

FCC Radio Test Report

FCC ID: R9C-CPH2015

This report concerns: Original Grant

Project No. : 1911C066
Equipment : Mobile Phone
Brand Name : OPPO
Test Model : CPH2015
Series Model : N/A
Applicant : GuangDong Oppo Mobile Telecommunications Corp., Ltd.
Address : NO. 18 HaiBin Road, WuSha village, Chang An Town, DongGuan City,Guangdong,China.
Manufacturer : GuangDong Oppo Mobile Telecommunications Corp., Ltd.
Address : NO. 18 HaiBin Road, WuSha village, Chang An Town, DongGuan City,Guangdong,China.
Factory : GuangDong Oppo Mobile Telecommunications Corp., Ltd.
Address : NO. 18 HaiBin Road, WuSha village, Chang An Town, DongGuan City,Guangdong,China.
Date of Receipt : Nov. 12, 2019
Date of Test : Nov. 12, 2019 ~ Dec. 18, 2019
Issued Date : Dec. 24, 2019
Report Version : R00
Test Sample : Engineering Sample No.: DG2019112569 for conducted, DG2019112570 for radiated.
Standard(s) : FCC Part15, Subpart C (15.247)
ANSI C63.10-2013
KDB 558074 D01 15.247 Meas Guidance v05r02

The above equipment has been tested and found compliance with the requirement of the relative standards by BTL Inc.

Trey Chen
Prepared by : Trey Chen

Steven Lu
Approved by : Steven Lu



Certificate #5123.02

Add: No.3, Jinshagang 1st Road, Shixia, Dalang Town, Dongguan, Guangdong, China.

Tel: +86-769-8318-3000

Web: www.newbtl.com

Declaration

BTL represents to the client that testing is done in accordance with standard procedures as applicable and that test instruments used has been calibrated with standards traceable to international standard(s) and/or national standard(s).

BTL's reports apply only to the specific samples tested under conditions. It is manufacture's responsibility to ensure that additional production units of this model are manufactured with the identical electrical and mechanical components. **BTL** shall have no liability for any declarations, inferences or generalizations drawn by the client or others from **BTL** issued reports.

The report must not be used by the client to claim product certification, approval, or endorsement by NVLAP, NIST, A2LA, or any agency of the U.S. Government.

This report is the confidential property of the client. As a mutual protection to the clients, the public and ourselves, the test report shall not be reproduced, except in full, without our written approval.

BTL's laboratory quality assurance procedures are in compliance with the **ISO/IEC 17025** requirements, and accredited by the conformity assessment authorities listed in this test report.

BTL is not responsible for the sampling stage, so the results only apply to the sample as received.

The information, data and test plan are provided by manufacturer which may affect the validity of results, so it is manufacturer's responsibility to ensure that the apparatus meets the essential requirements of applied standards and in all the possible configurations as representative of its intended use.

Limitation

For the use of the authority's logo is limited unless the Test Standard(s)/Scope(s)/Item(s) mentioned in this test report is (are) included in the conformity assessment authorities acceptance respective.

Please note that the measurement uncertainty is provided for informational purpose only and are not use in determining the Pass/Fail results.

| Table of Contents | Page |
|--|-------------|
| REPORT ISSUED HISTORY | 5 |
| 1 . SUMMARY OF TEST RESULTS | 6 |
| 1.1 TEST FACILITY | 7 |
| 1.2 MEASUREMENT UNCERTAINTY | 7 |
| 1.3 TEST ENVIRONMENT CONDITIONS | 7 |
| 2 . GENERAL INFORMATION | 8 |
| 2.1 GENERAL DESCRIPTION OF EUT | 8 |
| 2.2 DESCRIPTION OF TEST MODES | 10 |
| 2.3 PARAMETERS OF TEST SOFTWARE | 10 |
| 2.4 BLOCK DIAGRAM SHOWING THE CONFIGURATION OF SYSTEM TESTED | 11 |
| 2.5 SUPPORT UNITS | 11 |
| 3 . AC POWER LINE CONDUCTED EMISSIONS TEST | 12 |
| 3.1 LIMIT | 12 |
| 3.2 TEST PROCEDURE | 12 |
| 3.3 DEVIATION FROM TEST STANDARD | 12 |
| 3.4 TEST SETUP | 13 |
| 3.5 EUT OPERATING CONDITIONS | 13 |
| 3.6 TEST RESULTS | 13 |
| 4 . RADIATED EMISSION TEST | 14 |
| 4.1 LIMIT | 14 |
| 4.2 TEST PROCEDURE | 15 |
| 4.3 DEVIATION FROM TEST STANDARD | 15 |
| 4.4 TEST SETUP | 16 |
| 4.5 EUT OPERATING CONDITIONS | 17 |
| 4.6 TEST RESULT - 9 KHZ TO 30 MHZ | 17 |
| 4.7 TEST RESULT - 30 MHZ TO 1000 MHZ | 17 |
| 4.8 TEST RESULT - ABOVE 1000 MHZ | 17 |
| 5 . BANDWIDTH TEST | 18 |
| 5.1 LIMIT | 18 |
| 5.2 TEST PROCEDURE | 18 |
| 5.3 DEVIATION FROM STANDARD | 18 |
| 5.4 TEST SETUP | 18 |
| 5.5 EUT OPERATION CONDITIONS | 18 |

| Table of Contents | Page |
|--|-------------|
| 5.6 TEST RESULTS | 18 |
| 6 . MAXIMUM OUTPUT POWER | 19 |
| 6.1 LIMIT | 19 |
| 6.2 TEST PROCEDURE | 19 |
| 6.3 DEVIATION FROM STANDARD | 19 |
| 6.4 TEST SETUP | 19 |
| 6.5 EUT OPERATION CONDITIONS | 19 |
| 6.6 TEST RESULTS | 19 |
| 7 . CONDUCTED SPURIOUS EMISSION | 20 |
| 7.1 LIMIT | 20 |
| 7.2 TEST PROCEDURE | 20 |
| 7.3 DEVIATION FROM STANDARD | 20 |
| 7.4 TEST SETUP | 20 |
| 7.5 EUT OPERATION CONDITIONS | 20 |
| 7.6 TEST RESULTS | 20 |
| 8 . POWER SPECTRAL DENSITY TEST | 21 |
| 8.1 LIMIT | 21 |
| 8.2 TEST PROCEDURE | 21 |
| 8.3 DEVIATION FROM STANDARD | 21 |
| 8.4 TEST SETUP | 21 |
| 8.5 EUT OPERATION CONDITIONS | 21 |
| 8.6 TEST RESULTS | 21 |
| 9 . MEASUREMENT INSTRUMENTS LIST | 22 |
| APPENDIX A - AC POWER LINE CONDUCTED EMISSIONS | 24 |
| APPENDIX B - RADIATED EMISSION - 9 KHZ TO 30 MHZ | 27 |
| APPENDIX C - RADIATED EMISSION - 30 MHZ TO 1000 MHZ | 32 |
| APPENDIX D - RADIATED EMISSION - ABOVE 1000 MHZ | 35 |
| APPENDIX E - BANDWIDTH | 60 |
| APPENDIX F - MAXIMUM OUTPUT POWER | 62 |
| APPENDIX G - CONDUCTED SPURIOUS EMISSION | 64 |
| APPENDIX H - POWER SPECTRAL DENSITY | 67 |

REPORT ISSUED HISTORY

| Report Version | Description | Issued Date |
|----------------|-----------------|---------------|
| R00 | Original Issue. | Dec. 24, 2019 |

1. SUMMARY OF TEST RESULTS

Test procedures according to the technical standard(s):

| FCC Part15, Subpart C (15.247) | | | | |
|-------------------------------------|-----------------------------------|--|----------|---------|
| Standard(s) Section | Test Item | Test Result | Judgment | Remark |
| 15.207 | AC Power Line Conducted Emissions | APPENDIX A | PASS | ----- |
| 15.247(d) 15.205(a) 15.209(a) | Radiated Emissions | APPENDIX B APPENDIX C APPENDIX D | PASS | ----- |
| 15.247(a)(2) | Bandwidth | APPENDIX E | PASS | ----- |
| 15.247(b)(3) | Maximum Output Power | APPENDIX F | PASS | ----- |
| 15.247(d) | Conducted Spurious Emission | APPENDIX G | PASS | ----- |
| 15.247(e) | Power Spectral Density | APPENDIX H | PASS | ----- |
| 15.203 | Antenna Requirement | ----- | PASS | Note(2) |

Note:

- (1) "N/A" denotes test is not applicable to this device.
- (2) The device what use a permanently attached antenna were considered sufficient to comply with the provisions of 15.203.

1.1 TEST FACILITY

The test facilities used to collect the test data in this report is at the location of No.3, Jinshagang 1st Road, Shixia, Dalang Town, Dongguan, Guangdong, China.

BTL's Test Firm Registration Number for FCC: 357015

BTL's Designation Number for FCC: CN1240

1.2 MEASUREMENT UNCERTAINTY

ISO/IEC 17025 requires that an estimate of the measurement uncertainties associated with the emissions test results be included in the report. The measurement uncertainties given below are based on a 95% confidence level (based on a coverage factor (k=2))

The BTL measurement uncertainty as below table:

A. AC power line conducted emissions Measurement:

| Test Site | Method | Measurement Frequency Range | U, (dB) |
|-----------|--------|-----------------------------|---------|
| DG-C02 | CISPR | 150kHz ~ 30MHz | 2.60 |

B. Radiated emissions Measurement:

| Test Site | Method | Measurement Frequency Range | Ant. H / V | U, (dB) |
|-----------|--------|-----------------------------|------------|---------|
| DG-CB03 | CISPR | 9kHz ~ 30MHz | V | 3.79 |
| | | 9kHz ~ 30MHz | H | 3.57 |
| | | 30MHz ~ 200MHz | V | 4.88 |
| | | 30MHz ~ 200MHz | H | 4.14 |
| | | 200MHz ~ 1,000MHz | V | 4.62 |
| | | 200MHz ~ 1,000MHz | H | 4.80 |
| | | 1GHz ~ 6GHz | - | 4.58 |
| | | 6GHz ~ 18GHz | - | 5.18 |
| | | 18GHz ~ 26.5GHz | - | 3.62 |
| | | 26.5GHz ~ 40GHz | - | 4.00 |

Note: Unless specifically mentioned, the uncertainty of measurement has not been taken into account to declare the compliance or non-compliance to the specification.

1.3 TEST ENVIRONMENT CONDITIONS

| Test Item | Temperature | Humidity | Test Voltage | Tested By |
|-----------------------------------|-------------|----------|--------------|----------------|
| AC Power Line Conducted Emissions | 25°C | 53% | AC 120V/60Hz | Laughing Zhang |
| Radiated Emissions-9K-30MHz | 25°C | 60% | AC 120V/60Hz | Laughing Zhang |
| Radiated Emissions-30 MHz to 1GHz | 24°C | 68% | AC 120V/60Hz | Laughing Zhang |
| Radiated Emissions-Above 1000 MHz | 24°C | 68% | AC 120V/60Hz | Laughing Zhang |
| Bandwidth | 22.1°C | 52.3% | DC 3.85V | Jonas Chen |
| Maximum Output Power | 22.1°C | 52.3% | DC 3.85V | Laughing Zhang |
| Conducted Spurious Emission | 22.1°C | 52.3% | DC 3.85V | Jonas Chen |
| Power Spectral Density | 22.1°C | 52.3% | DC 3.85V | Jonas Chen |

2. GENERAL INFORMATION

2.1 GENERAL DESCRIPTION OF EUT

| | |
|-------------------------|---|
| Equipment | Mobile Phone |
| Brand Name | OPPO |
| Test Model | CPH2015 |
| Series Model | N/A |
| Model Difference(s) | N/A |
| Hardware Version | 11 |
| Software Version | ColorOS V6.1.2 |
| Power Source | 1. DC Voltage supplied from AC/DC adapter. 1# Model: OP52KAUH 2# Model: OP52JAUH 3# Model: OP52JBUH 4# Model: OP52YAUH 2. Supplied from Li-ion Polymer battery. 1# Factory / Model: Scud / BLP673 2# Factory / Model: Desay / BLP673 3. Supplied from USB port. |
| Power Rating | 1. I/P:100-240V~ 50/60Hz 0.4A O/P:5V---2A 2. 3.85Vdc, 4100mAh/15.78Wh 3. DC 5V |
| Operation Frequency | 2402 MHz ~ 2480 MHz |
| Modulation Technology | GFSK |
| Bit Rate of Transmitter | 1Mbps, 2Mbps |
| Max. Output Power | 1Mbps: 7.06 dBm (0.0051 W) 2Mbps: 7.05 dBm (0.0051 W) |

Note:

1. For a more detailed features description, please refer to the manufacturer's specifications or the user's manual.

2. Channel List:

| Channel | Frequency (MHz) | Channel | Frequency (MHz) |
|---------|-----------------|---------|-----------------|
| 00 | 2402 | 20 | 2442 |
| 01 | 2404 | 21 | 2444 |
| 02 | 2406 | 22 | 2446 |
| 03 | 2408 | 23 | 2448 |
| 04 | 2410 | 24 | 2450 |
| 05 | 2412 | 25 | 2452 |
| 06 | 2414 | 26 | 2454 |
| 07 | 2416 | 27 | 2456 |
| 08 | 2418 | 28 | 2458 |
| 09 | 2420 | 29 | 2460 |
| 10 | 2422 | 30 | 2462 |
| 11 | 2424 | 31 | 2464 |
| 12 | 2426 | 32 | 2466 |
| 13 | 2428 | 33 | 2468 |
| 14 | 2430 | 34 | 2470 |
| 15 | 2432 | 35 | 2472 |
| 16 | 2434 | 36 | 2474 |
| 17 | 2436 | 37 | 2476 |
| 18 | 2438 | 38 | 2478 |
| 19 | 2440 | 39 | 2480 |

3. Table for Filed Antenna:

| Ant. | Brand | Model Name | Antenna Type | Connector | Gain (dBi) |
|------|-------|------------|--------------|-----------|------------|
| 1 | N/A | N/A | Internal | N/A | 0.77 |

2.2 DESCRIPTION OF TEST MODES

The test system was pre-tested based on the consideration of all possible combinations of EUT operation mode.

| Pretest Mode | Description |
|--------------|---------------------------|
| Mode 1 | TX Mode NOTE (1) |
| Mode 2 | TX Mode Channel 19 _1Mbps |

Following mode(s) was (were) found to be the worst case(s) and selected for the final test.

| AC power line conducted emissions test | |
|--|---------------------------|
| Final Test Mode | Description |
| Mode 2 | TX Mode Channel 19 _1Mbps |

| Radiated emissions test - Below 1GHz | |
|--------------------------------------|---------------------------|
| Final Test Mode | Description |
| Mode 2 | TX Mode Channel 19 _1Mbps |

| Radiated emissions test - Above 1GHz | |
|--------------------------------------|------------------|
| Final Test Mode | Description |
| Mode 1 | TX Mode NOTE (1) |

| Conducted test | |
|-----------------|------------------|
| Final Test Mode | Description |
| Mode 1 | TX Mode NOTE (1) |

Note:

- (1) The measurements are performed at the high, middle, low available channels.
- (2) For radiated emission above 1 GHz test, 1GHz~26.5GHz have been pre-tested and in this report only recorded the worst case.
- (3) For radiated spurious emissions below 1 GHz test, all adapters had been pre-tested and in this report only recorded the worst case.

2.3 PARAMETERS OF TEST SOFTWARE

During testing channel & power controlling software provided by the customer was used to control the operating channel as well as the output power level. The RF output power selection is for the setting of RF output power expected by the customer and is going to be fixed on the firmware of the final end product power parameters of BT LE

| Test Software | *#36446337# | | |
|-------------------|-------------|------|------|
| Frequency (MHz) | 2402 | 2440 | 2480 |
| Parameters(1Mbps) | N/A | N/A | N/A |
| Parameters(2Mbps) | N/A | N/A | N/A |

2.4 BLOCK DIAGRAM SHOWING THE CONFIGURATION OF SYSTEM TESTED

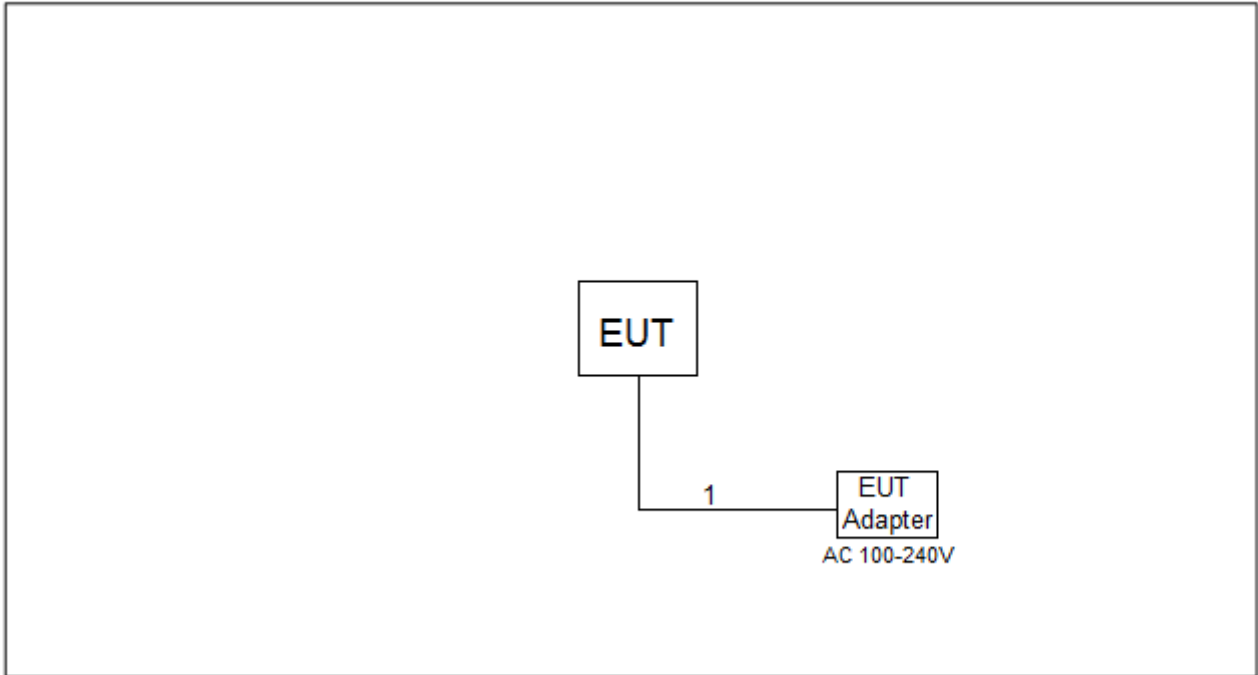

2.5 SUPPORT UNITS

| Item | Equipment | Brand | Model No. | Series No. |
|------|-----------|-------|-----------|------------|
| - | - | - | - | - |

| Item | Cable Type | Shielded Type | Ferrite Core | Length |
|------|------------|---------------|--------------|--------|
| 1 | USB Cable | YES | NO | 1m |

3. AC POWER LINE CONDUCTED EMISSIONS TEST

3.1 LIMIT

| Frequency of Emission (MHz) | Limit (dB μ V) | |
|-----------------------------|--------------------|-----------|
| | Quasi-peak | Average |
| 0.15 - 0.5 | 66 to 56* | 56 to 46* |
| 0.5 - 5.0 | 56 | 46 |
| 5.0 - 30.0 | 60 | 50 |

Note:

- (1) The tighter limit applies at the band edges.
- (2) The limit of " * " marked band means the limitation decreases linearly with the logarithm of the frequency in the range.

The following table is the setting of the receiver

| Receiver Parameters | Setting |
|---------------------|----------|
| Attenuation | 10 dB |
| Start Frequency | 0.15 MHz |
| Stop Frequency | 30 MHz |
| IF Bandwidth | 9 kHz |

3.2 TEST PROCEDURE

- a. The EUT was placed 0.8 meters from the horizontal ground plane with EUT being connected to the power mains through a line impedance stabilization network (LISN). All other support equipment powered from additional LISN(s). The LISN provide 50 Ohm/ 50uH of coupling impedance for the measuring instrument.
- b. Interconnecting cables that hang closer than 40 cm to the ground plane shall be folded back and forth in the center forming a bundle 30 to 40 cm long.
- c. I/O cables that are not connected to a peripheral shall be bundled in the center. The end of the cable may be terminated, if required, using the correct terminating impedance. The overall length shall not exceed 1 m.
- d. LISN at least 80 cm from nearest part of EUT chassis.
- e. For the actual test configuration, please refer to the related Item –EUT Test Photos.

3.3 DEVIATION FROM TEST STANDARD

No deviation

3.4 TEST SETUP

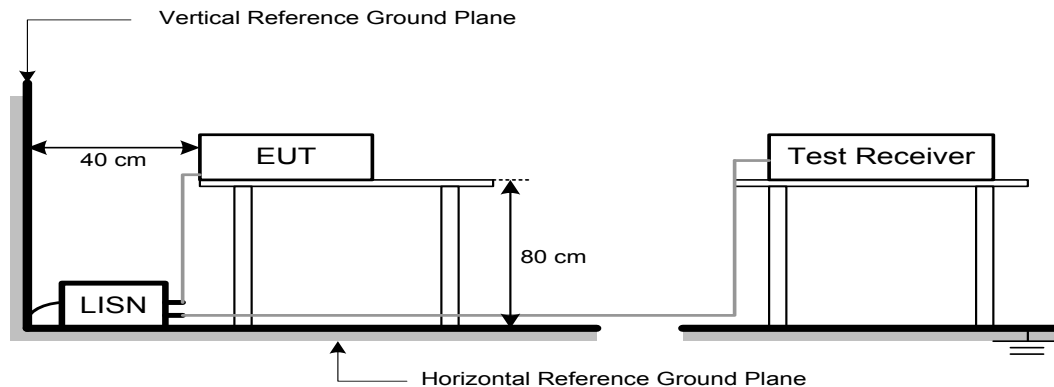

3.5 EUT OPERATING CONDITIONS

The EUT was configured for testing in a typical fashion (as a customer would normally use it). The EUT has been programmed to continuously transmit during test. This operating condition was tested and used to collect the included data.

3.6 TEST RESULTS

Please refer to the APPENDIX A.

Remark:

- (1) All readings are QP Mode value unless otherwise stated AVG in column of 『Note』 . If the QP Mode Measured value compliance with the QP Limits and lower than AVG Limits, the EUT shall be deemed to meet both QP & AVG Limits and then only QP Mode was measured, but AVG Mode didn't perform. In this case, a “*” marked in AVG Mode column of Interference Voltage Measured.
- (2) Measuring frequency range from 150 kHz to 30 MHz.

4. RADIATED EMISSION TEST

4.1 LIMIT

In case the emission fall within the restricted band specified on 15.205(a), then the 15.209(a) limit in the table below has to be followed.

LIMITS OF RADIATED EMISSION MEASUREMENT (9 kHz-1000 MHz)

| Frequency (MHz) | Field Strength (microvolts/meter) | Measurement Distance (meters) |
|-----------------|-----------------------------------|-------------------------------|
| 0.009-0.490 | 2400/F(kHz) | 300 |
| 0.490-1.705 | 24000/F(kHz) | 30 |
| 1.705-30.0 | 30 | 30 |
| 30-88 | 100 | 3 |
| 88-216 | 150 | 3 |
| 216-960 | 200 | 3 |
| Above 960 | 500 | 3 |

LIMITS OF RADIATED EMISSION MEASUREMENT (Above 1000 MHz)

| Frequency (MHz) | (dBuV/m at 3 m) | |
|-----------------|-----------------|---------|
| | Peak | Average |
| Above 1000 | 74 | 54 |

Note:

- (1) The limit for radiated test was performed according to FCC PART 15C.
- (2) The tighter limit applies at the band edges.
- (3) Emission level (dBuV/m)=20log Emission level (uV/m).

| Spectrum Parameter | Setting |
|--|---|
| Attenuation | Auto |
| Start Frequency | 1000 MHz |
| Stop Frequency | 10th carrier harmonic |
| RBW / VBW (Emission in restricted band) | RBW 1 MHz VBW 3 MHz peak detector for Pk value RMS detector for AV value |

| Receiver Parameter | Setting |
|------------------------|-------------------------------------|
| Attenuation | Auto |
| Start ~ Stop Frequency | 9 kHz~90 kHz for PK/AVG detector |
| Start ~ Stop Frequency | 90 kHz~110 kHz for QP detector |
| Start ~ Stop Frequency | 110 kHz~490 kHz for PK/AVG detector |
| Start ~ Stop Frequency | 490 kHz~30 MHz for QP detector |
| Start ~ Stop Frequency | 30 MHz~1000 MHz for QP detector |

4.2 TEST PROCEDURE

- a. The measuring distance of 3 m shall be used for measurements. The EUT was placed on the top of a rotating table 0.8 meter above the ground at a 3 meter semi-anechoic chamber. The table was rotated 360 degrees to determine the position of the highest radiation.(below 1 GHz)
- b. The measuring distance of 3 m shall be used for measurements. The EUT was placed on the top of a rotating table 1.5 meter above the ground at a 3 meter semi-anechoic chamber. The table was rotated 360 degrees to determine the position of the highest radiation.(above 1 GHz)
- c. The height of the equipment or of the substitution antenna shall be 0.8m or 1.5m; the height of the test antenna shall vary between 1 m to 4 m. Both horizontal and vertical polarizations of the antenna are set to make the measurement.
- d. For each suspected emission, the EUT was arranged to its worst case and then the antenna was tuned to heights find the maximum reading (used Bore sight function).
- e. The receiver system was set to peak and average detect function and specified bandwidth with maximum hold mode when the test frequency is above 1 GHz.
- f. The initial step in collecting radiated emission data is a receiver peak detector mode pre-scanning the measurement frequency range. Significant peaks are then marked and then Quasi Peak detector mode re-measured.
- g. All readings are Peak unless otherwise stated QP in column of Note. Peak denotes that the Peak reading compliance with the QP Limits and then QP Mode measurement didn't perform.
(below 1 GHz)
- h. All readings are Peak Mode value unless otherwise stated AVG in column of Note. If the Peak Mode Measured value compliance with the Peak Limits and lower than AVG Limits, the EUT shall be deemed to meet both Peak & AVG Limits and then only Peak Mode was measured, but AVG Mode didn't perform. (above 1 GHz)
- i. For the actual test configuration, please refer to the related Item –EUT Test Photos.

4.3 DEVIATION FROM TEST STANDARD

No deviation

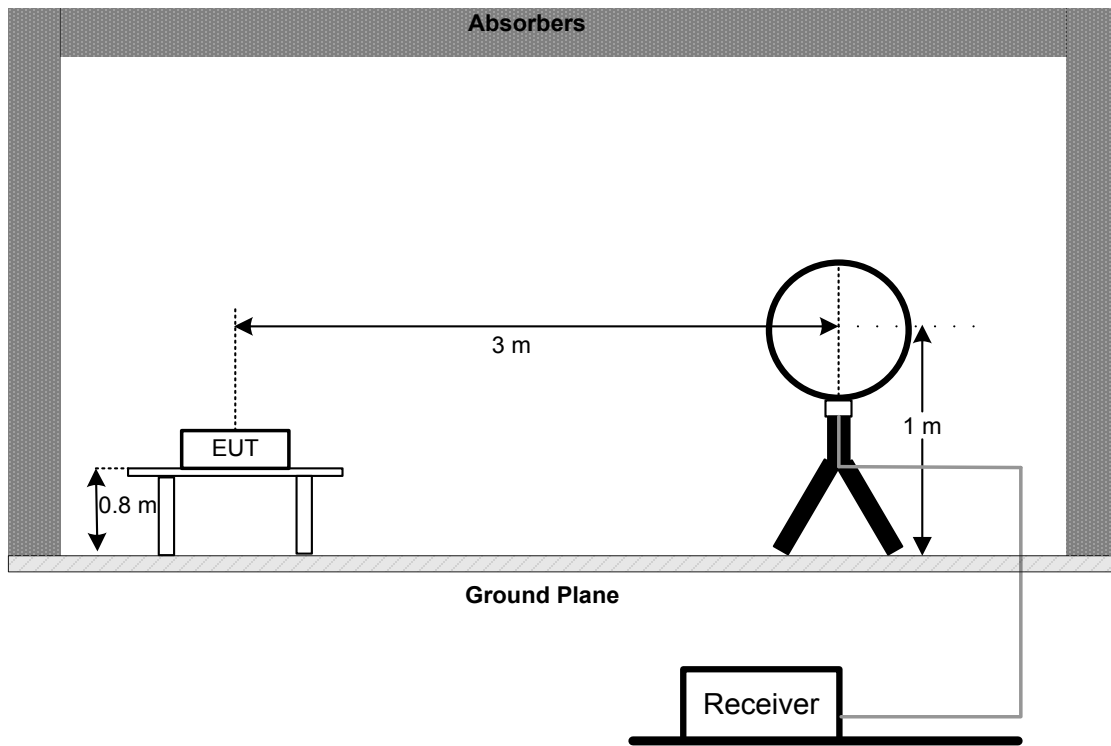
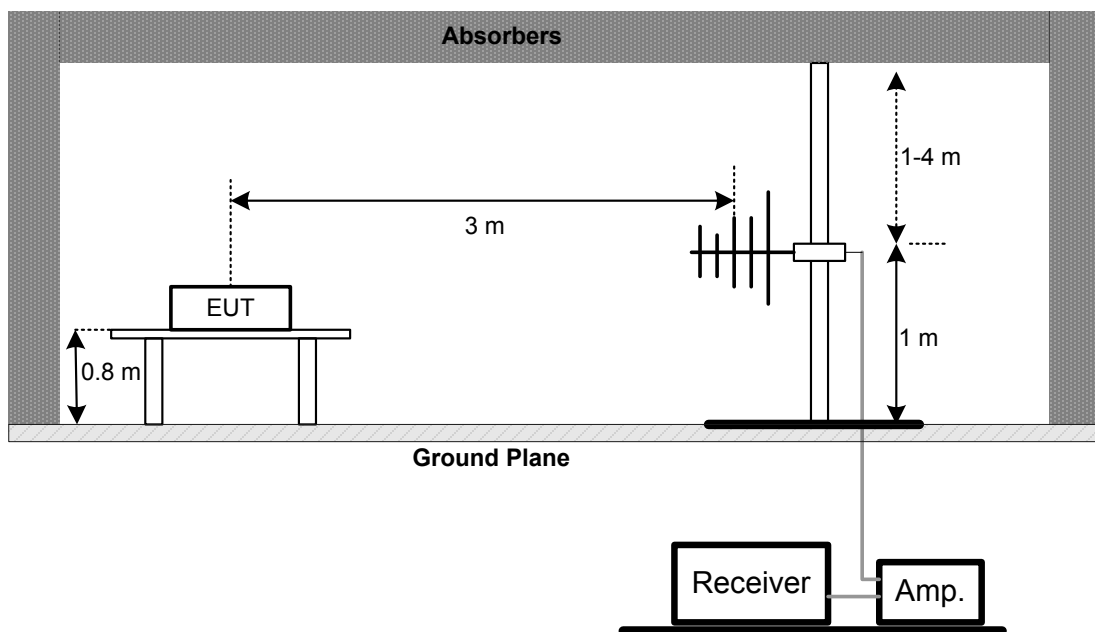
4.4 TEST SETUP**9 kHz-30 MHz****30 MHz to 1 GHz**

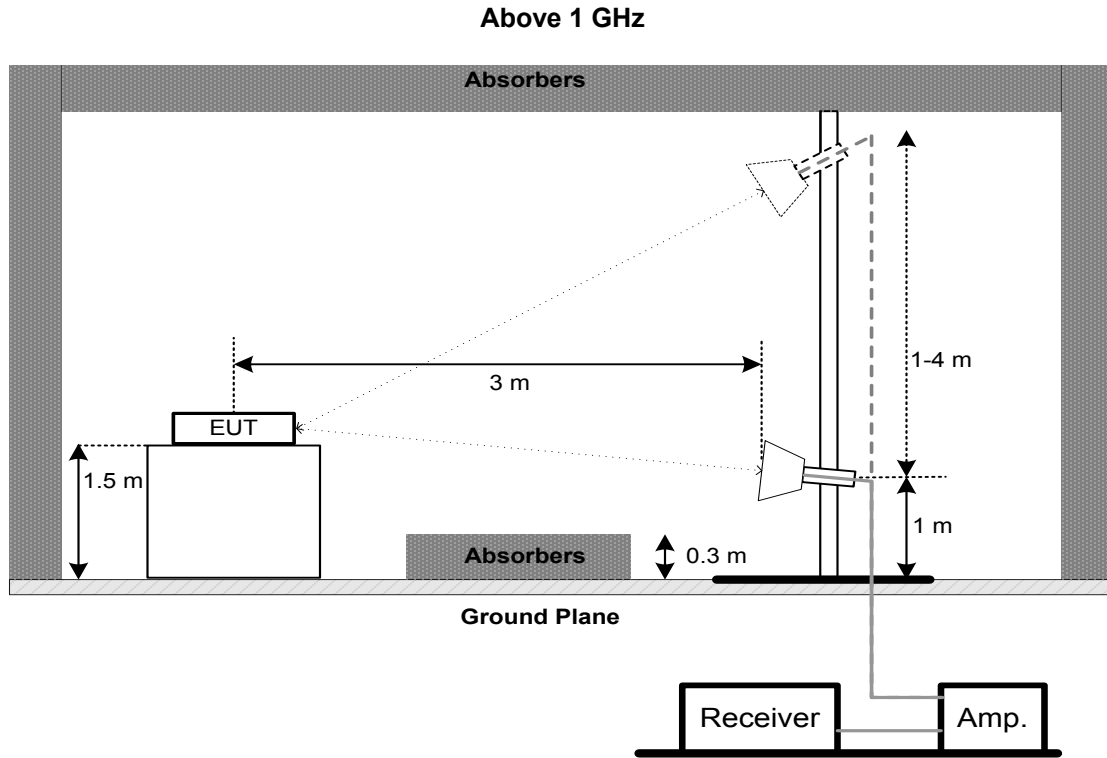

4.5 EUT OPERATING CONDITIONS

The EUT was programmed to be in continuously transmitting mode.

4.6 TEST RESULT - 9 kHz TO 30 MHz

Please refer to the APPENDIX B

Remark:

- (1) Distance extrapolation factor = $40 \log(\text{specific distance} / \text{test distance})$ (dB).
- (2) Limit line = specific limits (dBuV) + distance extrapolation factor.

4.7 TEST RESULT - 30 MHz TO 1000 MHz

Please refer to the APPENDIX C.

4.8 TEST RESULT - ABOVE 1000 MHz

Please refer to the APPENDIX D.

Remark:

- (1) No limit: This is fundamental signal, the judgment is not applicable.
For fundamental signal judgment was referred to Peak output test.

5. BANDWIDTH TEST

5.1 LIMIT

| FCC Part15, Subpart C (15.247) | | |
|--------------------------------|-----------|------------------------------------|
| Section | Test Item | Limit |
| 15.247(a)(2) | Bandwidth | ≥ 500 kHz (6 dB bandwidth) |

5.2 TEST PROCEDURE

- The EUT was directly connected to the spectrum analyzer and antenna output port as show in the block diagram below.
- Spectrum Setting : RBW= 100 kHz, VBW=300 kHz, Sweep time = 2.5 ms.

5.3 DEVIATION FROM STANDARD

No deviation.

5.4 TEST SETUP



5.5 EUT OPERATION CONDITIONS

The EUT tested system was configured as the statements of 3.5 unless otherwise a special operating condition is specified in the follows during the testing.

5.6 TEST RESULTS

Please refer to the APPENDIX E.

6. MAXIMUM OUTPUT POWER

6.1 LIMIT

| FCC Part15, Subpart C (15.247) | | |
|--------------------------------|----------------------|------------------|
| Section | Test Item | Limit |
| 15.247(b)(3) | Maximum Output Power | 1 watt or 30 dBm |

6.2 TEST PROCEDURE

- The EUT was directly connected to the spectrum analyzer and antenna output port as show in the block diagram below.
- The maximum conducted output power was performed in accordance with method 11.9.1.1 of ANSI C63.10-2013.

6.3 DEVIATION FROM STANDARD

No deviation.

6.4 TEST SETUP

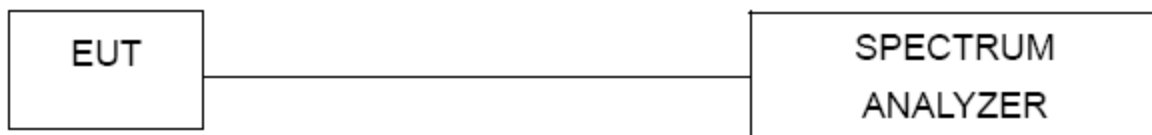

6.5 EUT OPERATION CONDITIONS

The EUT tested system was configured as the statements of 3.5 unless otherwise a special operating condition is specified in the follows during the testing.

6.6 TEST RESULTS

Please refer to the APPENDIX F.

7. CONDUCTED SPURIOUS EMISSION

7.1 LIMIT

In any 100 kHz bandwidth outside the frequency band in which the spread spectrum or digitally modulated intentional radiator is operating, the radio frequency power that is produced by the intentional radiator shall be at least 20 dB below that in the 100 kHz bandwidth within the band that contains the highest level of the desired power, based on either an RF conducted or a radiated measurement, provided the transmitter demonstrates compliance with the peak Output Power limits. If the transmitter complies with the Output Power limits based on the use of RMS averaging over a time interval, as permitted under paragraph (b)(3) of this section, the attenuation required under this paragraph shall be 30 dB instead of 20 dB. Attenuation below the general limits specified in Section 15.209(a) is not required.

7.2 TEST PROCEDURE

- a. The EUT was directly connected to the spectrum analyzer and antenna output port as show in the block diagram below.
- b. Spectrum Setting : RBW= 100 kHz, VBW=300 kHz, Sweep time = 10 ms.

7.3 DEVIATION FROM STANDARD

No deviation.

7.4 TEST SETUP

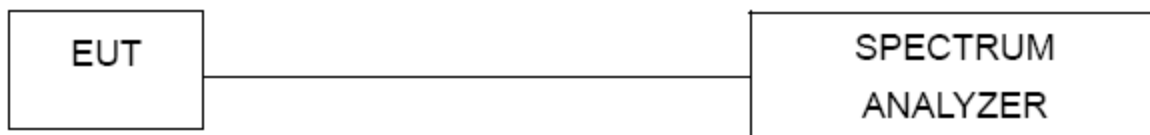

7.5 EUT OPERATION CONDITIONS

The EUT tested system was configured as the statements of 3.5 unless otherwise a special operating condition is specified in the follows during the testing.

7.6 TEST RESULTS

Please refer to the APPENDIX G.

8. POWER SPECTRAL DENSITY TEST

8.1 LIMIT

| FCC Part15, Subpart C (15.247) | | |
|--------------------------------|------------------------|-------------------------|
| Section | Test Item | Limit |
| 15.247(e) | Power Spectral Density | 8 dBm (in any 3 kHz) |

8.2 TEST PROCEDURE

- The EUT was directly connected to the spectrum analyzer and antenna output port as show in the block diagram below.
- Spectrum Setting: RBW=3 kHz, VBW=10 kHz, Sweep time = auto.

8.3 DEVIATION FROM STANDARD

No deviation.

8.4 TEST SETUP

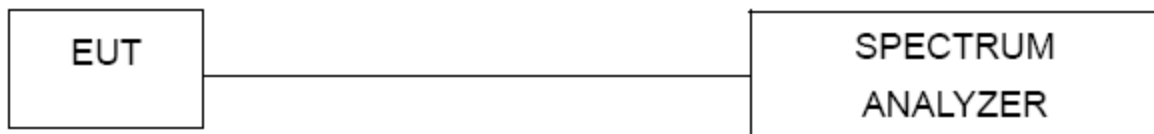

8.5 EUT OPERATION CONDITIONS

The EUT tested system was configured as the statements of 3.5 unless otherwise a special operating condition is specified in the follows during the testing.

8.6 TEST RESULTS

Please refer to the APPENDIX H.

9. MEASUREMENT INSTRUMENTS LIST

| AC Power Line Conducted Emissions | | | | | |
|-----------------------------------|-------------------------|--------------|--------------------------|------------|------------------|
| Item | Kind of Equipment | Manufacturer | Type No. | Serial No. | Calibrated until |
| 1 | EMI Test Receiver | R&S | ESCI | 100382 | Mar. 10, 2020 |
| 2 | LISN | EMCO | 3816/2 | 52765 | Mar. 10, 2020 |
| 3 | TWO-LINE V-NETWORK | R&S | ENV216 | 101447 | May 19, 2020 |
| 4 | 50Ω Terminator | SHX | TF5-3 | 15041305 | Mar. 10, 2020 |
| 5 | Measurement Software | Farad | EZ-EMC Ver.NB-03A1-01 | N/A | N/A |
| 6 | Cable | N/A | RG223 | 12m | Mar. 12, 2020 |

| Radiated Emissions - 9 kHz to 30 MHz | | | | | |
|--------------------------------------|-------------------------|--------------|--------------------------|------------|------------------|
| Item | Kind of Equipment | Manufacturer | Type No. | Serial No. | Calibrated until |
| 1 | Loop Antenna | EM | EM-6876-1 | 230 | Jan. 15, 2020 |
| 2 | Cable | N/A | RG 213/U | C-102 | May 31, 2020 |
| 3 | EMI Test Receiver | R&S | ESCI | 100895 | Mar. 10, 2020 |
| 4 | Measurement Software | Farad | EZ-EMC Ver.NB-03A1-01 | N/A | N/A |

| Radiated Emissions - 30 MHz to 1 GHz | | | | | |
|--------------------------------------|-------------------------|--------------|--------------------------------|-------------|------------------|
| Item | Kind of Equipment | Manufacturer | Type No. | Serial No. | Calibrated until |
| 1 | Antenna | Schwarzbeck | VULB9160 | 9160-3232 | Mar. 09, 2020 |
| 2* | Amplifier | HP | 8447D | 2944A09673 | Aug. 11, 2021 |
| 3 | Receiver | Agilent | N9038A | MY52130039 | Aug. 03, 2020 |
| 4 | Cable | emci | LMR-400(30MHz-1 GHz)(8m+5m) | N/A | May 24, 2020 |
| 5 | Controller | CT | SC100 | N/A | N/A |
| 6 | Controller | MF | MF-7802 | MF780208416 | N/A |
| 7 | Measurement Software | Farad | EZ-EMC Ver.NB-03A1-01 | N/A | N/A |

| Radiated Emissions - Above 1 GHz | | | | | |
|----------------------------------|---|-------------------|--------------------------|---------------|------------------|
| Item | Kind of Equipment | Manufacturer | Type No. | Serial No. | Calibrated until |
| 1 | Double Ridged Guide Antenna | ETS | 3115 | 75789 | Mar. 09, 2020 |
| 2 | Broad-Band Horn Antenna | Schwarzbeck | BBHA 9170 | 9170319 | Jun. 23, 2020 |
| 3 | Amplifier | Agilent | 8449B | 3008A02333 | Mar. 10, 2020 |
| 4 | Microwave Preamplifier With Adaptor | EMC INSTRUMENT | EMC2654045 | 980039 & HA01 | Mar. 10, 2020 |
| 5 | Receiver | Agilent | N9038A | MY52130039 | Aug. 03, 2020 |
| 6 | Controller | CT | SC100 | N/A | N/A |
| 7 | Controller | MF | MF-7802 | MF780208416 | N/A |
| 8 | Cable | mitron | B10-01-01-12M | 18072744 | Jun. 29, 2020 |
| 9 | Measurement Software | Farad | EZ-EMC Ver.NB-03A1-01 | N/A | N/A |

**Bandwidth &
Maximum Output Power &
Power Spectral Density &
Conducted Spurious Emission**

| Item | Kind of Equipment | Manufacturer | Type No. | Serial No. | Calibrated until |
|------|-------------------|--------------|----------|------------|------------------|
| 1 | Spectrum Analyzer | R&S | FSP40 | 100185 | Aug. 03, 2020 |

Remark: "N/A" denotes no model name, serial no. or calibration specified.

"**" calibration period of equipment list is three year.

Except * item, all calibration period of equipment list is one year.

APPENDIX A - AC POWER LINE CONDUCTED EMISSIONS

Test Mode: TX Mode Channel 19_1Mbps

Line

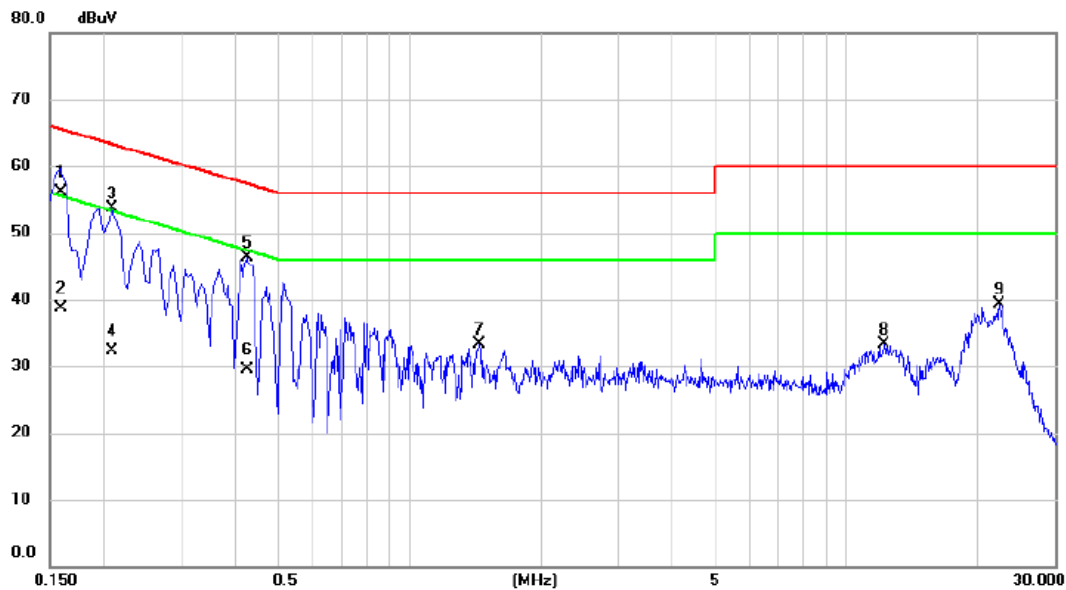

| No. | Mk. | Freq. MHz | Reading Level dBuV | Correct Factor dB | Measure- ment dBuV | Limit dBuV | Margin dB | Detector | Comment |
|-----|-----|--------------|--------------------------|-------------------------|--------------------------|---------------|--------------|----------|---------|
| 1 | * | 0.1590 | 46.24 | 9.82 | 56.06 | 65.52 | -9.46 | QP | |
| 2 | | 0.1590 | 28.88 | 9.82 | 38.70 | 55.52 | -16.82 | AVG | |
| 3 | | 0.2085 | 43.84 | 9.81 | 53.65 | 63.26 | -9.61 | peak | |
| 4 | | 0.2085 | 22.46 | 9.81 | 32.27 | 53.26 | -20.99 | AVG | |
| 5 | | 0.4245 | 36.36 | 9.87 | 46.23 | 57.36 | -11.13 | peak | |
| 6 | | 0.4245 | 19.68 | 9.87 | 29.55 | 47.36 | -17.81 | AVG | |
| 7 | | 1.4414 | 23.45 | 9.95 | 33.40 | 56.00 | -22.60 | peak | |
| 8 | | 12.1560 | 22.66 | 10.60 | 33.26 | 60.00 | -26.74 | peak | |
| 9 | | 22.3395 | 28.10 | 11.16 | 39.26 | 60.00 | -20.74 | peak | |

REMARKS:

(1) Measurement Value = Reading Level + Correct Factor.

(2) Margin Level = Measurement Value - Limit Value.

Test Mode: TX Mode Channel 19 _1Mbps

Neutral

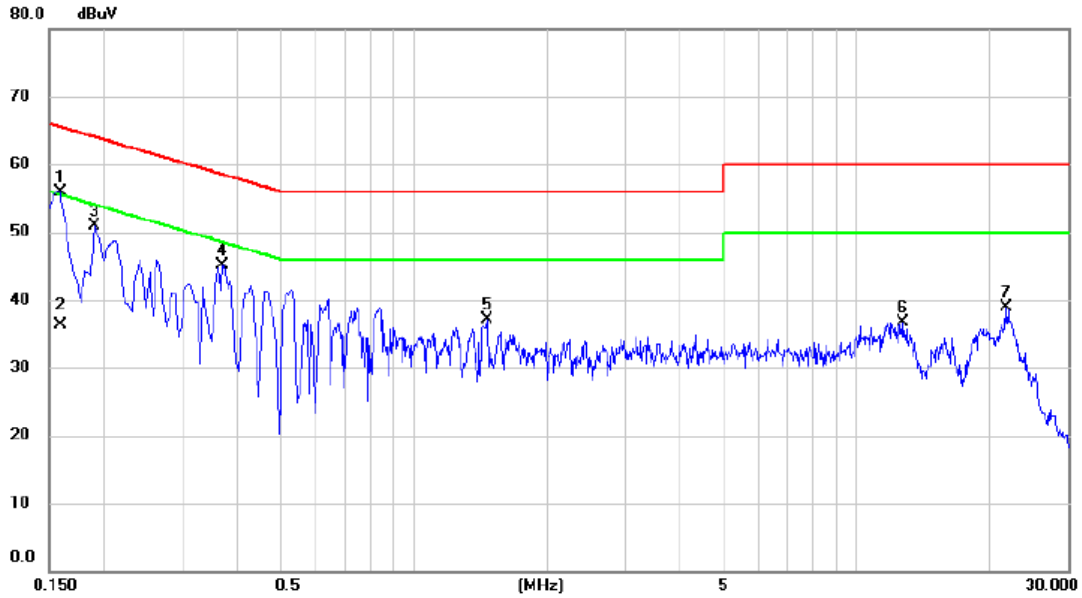

| No. | Mk. | Freq. MHz | Reading Level dBuV | Correct Factor dB | Measure- ment dBuV | Limit dBuV | Margin dB | Detector | Comment |
|-----|-----|--------------|--------------------------|-------------------------|--------------------------|---------------|--------------|----------|---------|
| 1 | * | 0.1590 | 45.97 | 9.91 | 55.88 | 65.52 | -9.64 | peak | |
| 2 | | 0.1590 | 26.41 | 9.91 | 36.32 | 55.52 | -19.20 | AVG | |
| 3 | | 0.1905 | 40.94 | 9.90 | 50.84 | 64.01 | -13.17 | peak | |
| 4 | | 0.3704 | 35.16 | 9.99 | 45.15 | 58.49 | -13.34 | peak | |
| 5 | | 1.4595 | 26.97 | 10.15 | 37.12 | 56.00 | -18.88 | peak | |
| 6 | | 12.7275 | 25.81 | 10.93 | 36.74 | 60.00 | -23.26 | peak | |
| 7 | | 21.6915 | 27.34 | 11.48 | 38.82 | 60.00 | -21.18 | peak | |

REMARKS:

- (1) Measurement Value = Reading Level + Correct Factor.
- (2) Margin Level = Measurement Value - Limit Value.

APPENDIX B - RADIATED EMISSION - 9 KHZ TO 30 MHZ

Test Mode: TX Mode Channel 19 _1Mbps

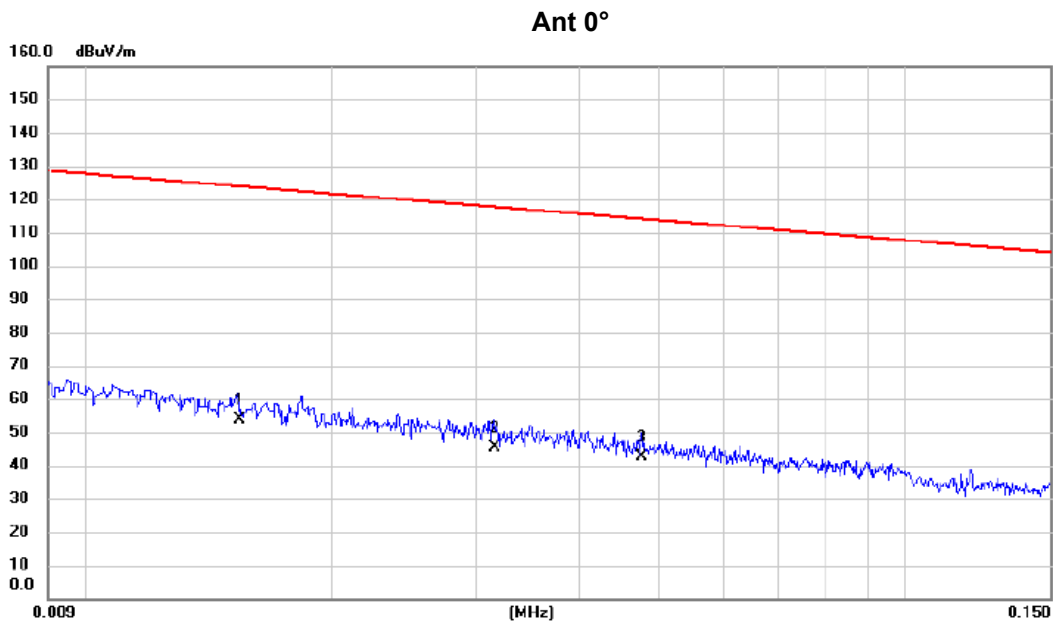

| No. | Mk. | Freq. | Reading Level | Correct Factor | Measurement | Limit | Margin | Detector | Comment |
|-----|-----|--------|---------------|----------------|-------------|--------|--------|----------|---------|
| | | MHz | dBuV | dB | dBuV/m | dBuV/m | dB | | |
| 1 | * | 0.0154 | 38.45 | 15.20 | 53.65 | 123.85 | -70.20 | AVG | |
| 2 | | 0.0316 | 31.58 | 13.86 | 45.44 | 117.61 | -72.17 | AVG | |
| 3 | | 0.0477 | 28.73 | 13.92 | 42.65 | 114.03 | -71.38 | AVG | |

REMARKS:

- (1) Measurement Value = Reading Level + Correct Factor.
- (2) Margin Level = Measurement Value - Limit Value.

Test Mode: TX Mode Channel 19 _1Mbps

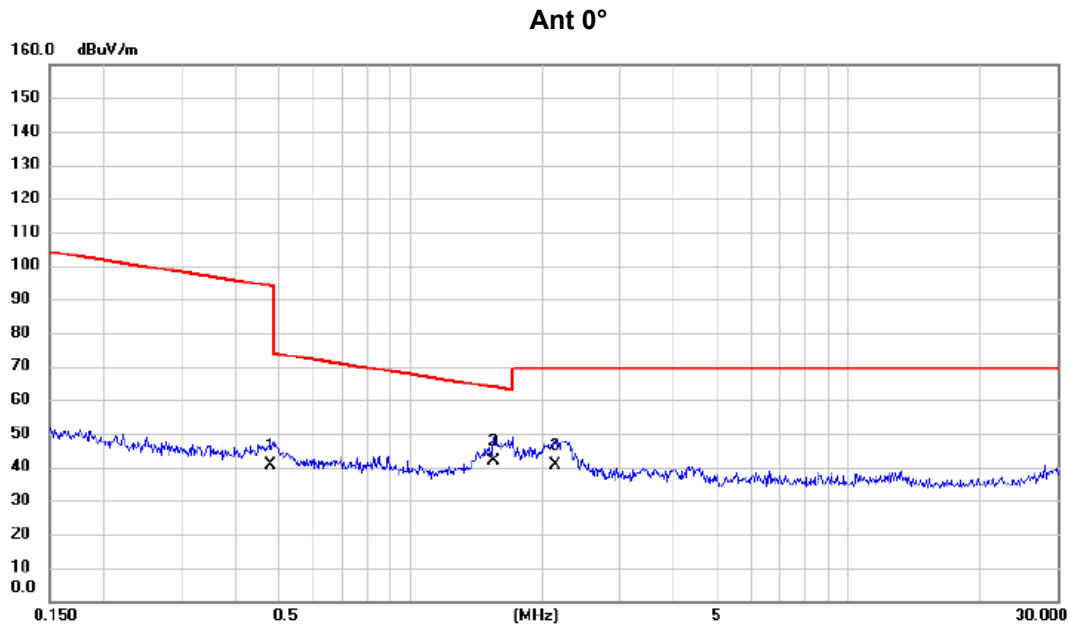

| No. | Mk. | Freq. MHz | Reading Level dBuV | Correct Factor dB | Measure- ment dBuV/m | Limit dBuV/m | Margin dB | Detector | Comment |
|-----|-----|--------------|--------------------------|-------------------------|----------------------------|-----------------|--------------|----------|---------|
| 1 | | 0.4786 | 27.65 | 13.11 | 40.76 | 94.00 | -53.24 | AVG | |
| 2 | * | 1.5518 | 29.87 | 12.12 | 41.99 | 63.79 | -21.80 | QP | |
| 3 | | 2.1440 | 28.74 | 11.73 | 40.47 | 69.54 | -29.07 | QP | |

REMARKS:

- (1) Measurement Value = Reading Level + Correct Factor.
- (2) Margin Level = Measurement Value - Limit Value.

Test Mode: TX Mode Channel 19 _1Mbps

Ant 90°

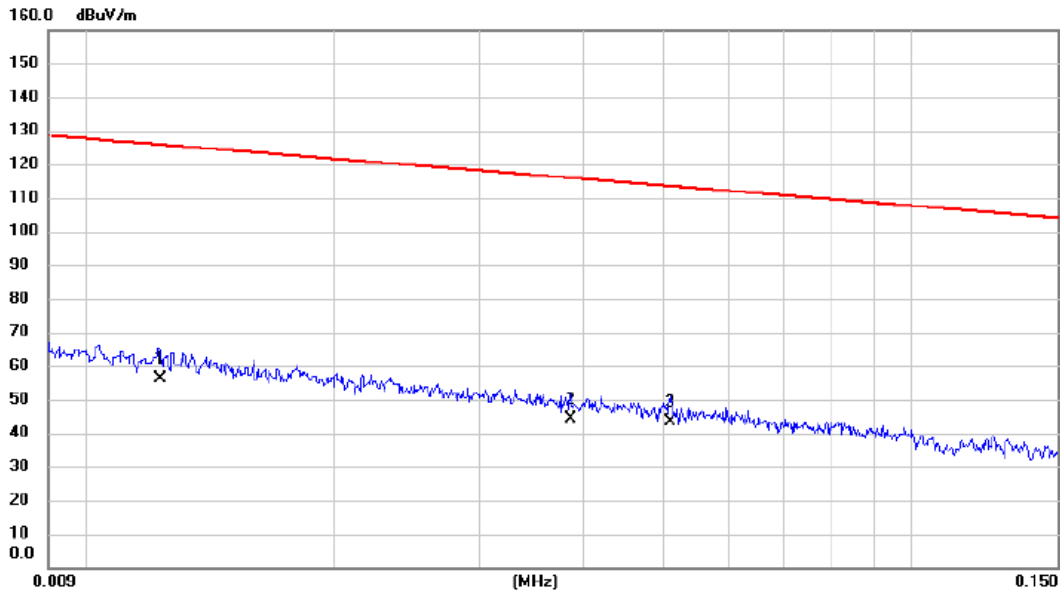

| No. | Mk. | Freq. MHz | Reading Level dBuV | Correct Factor dB | Measure- ment dBuV/m | Limit dBuV/m | Margin dB | Detector | Comment |
|-----|-----|--------------|--------------------------|-------------------------|----------------------------|-----------------|--------------|----------|---------|
| 1 | * | 0.0123 | 40.25 | 16.13 | 56.38 | 125.81 | -69.43 | AVG | |
| 2 | | 0.0387 | 30.14 | 13.89 | 44.03 | 115.85 | -71.82 | AVG | |
| 3 | | 0.0510 | 29.66 | 13.91 | 43.57 | 113.45 | -69.88 | AVG | |

REMARKS:

- (1) Measurement Value = Reading Level + Correct Factor.
- (2) Margin Level = Measurement Value - Limit Value.

Test Mode: TX Mode Channel 19 _1Mbps

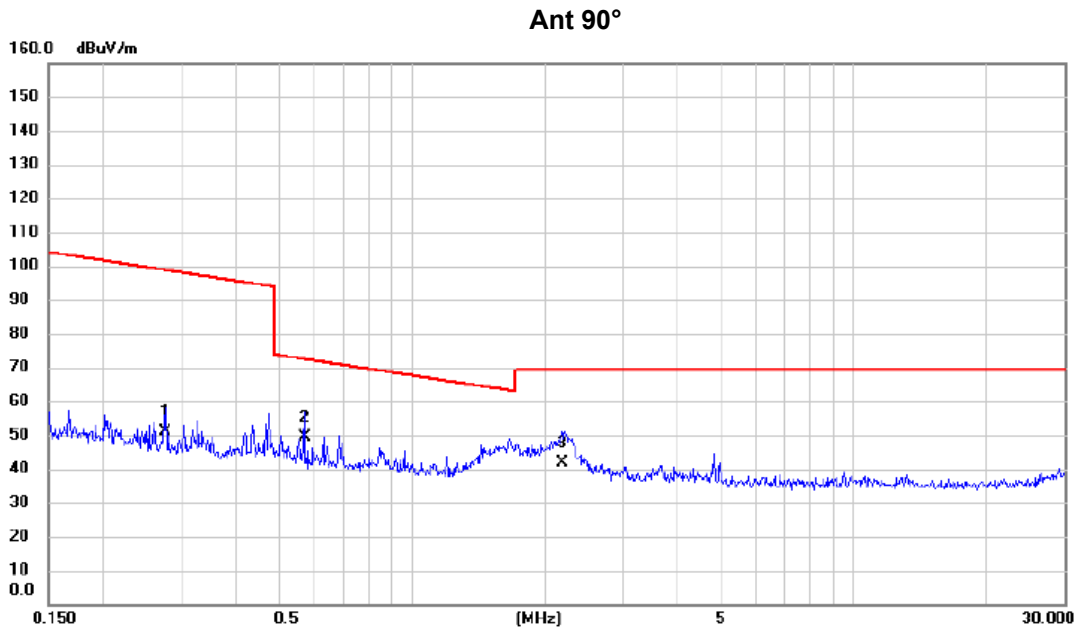

| No. | Mk. | Freq. MHz | Reading Level dBuV | Correct Factor dB | Measure- ment dBuV/m | Limit dBuV/m | Margin dB | Detector | Comment |
|-----|-----|--------------|--------------------------|-------------------------|----------------------------|-----------------|--------------|----------|---------|
| 1 | | 0.2760 | 37.45 | 13.60 | 51.05 | 98.79 | -47.74 | AVG | |
| 2 | * | 0.5701 | 36.48 | 12.93 | 49.41 | 72.48 | -23.07 | QP | |
| 3 | | 2.1898 | 30.15 | 11.71 | 41.86 | 69.54 | -27.68 | QP | |

REMARKS:

- (1) Measurement Value = Reading Level + Correct Factor.
- (2) Margin Level = Measurement Value - Limit Value.

APPENDIX C - RADIATED EMISSION - 30 MHZ TO 1000 MHZ

Test Mode: TX Mode Channel 19_1Mbps

Vertical

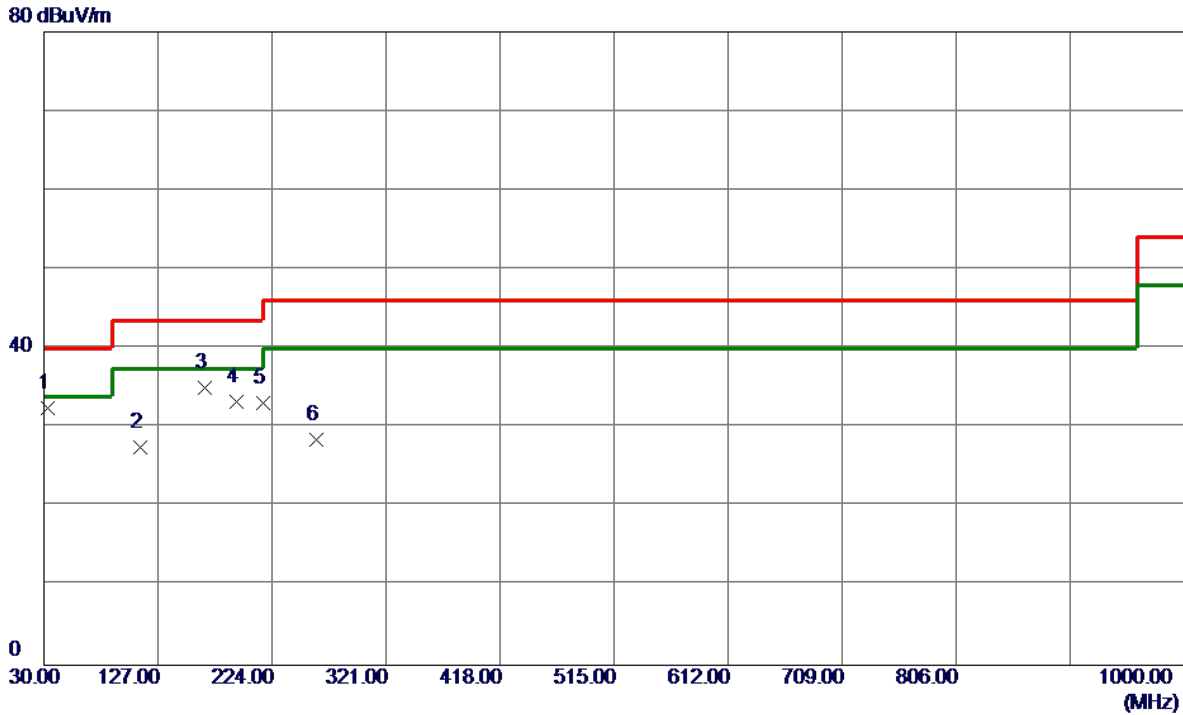

| No. | Freq. MHz | Reading Level dBuV/m | Correct Factor dB | Measure ment dBuV/m | Limit dBuV/m | Margin dB | Detector | Comment |
|-----|--------------|----------------------------|-------------------------|---------------------------|-----------------|--------------|----------|---------|
| 1 * | 32.9100 | 47.50 | -14.96 | 32.54 | 40.00 | -7.46 | Peak | |
| 2 | 111.4800 | 41.91 | -14.36 | 27.55 | 43.50 | -15.95 | Peak | |
| 3 | 166.7700 | 47.03 | -12.03 | 35.00 | 43.50 | -8.50 | Peak | |
| 4 | 193.9299 | 48.03 | -14.80 | 33.23 | 43.50 | -10.27 | Peak | |
| 5 | 216.2400 | 48.20 | -15.07 | 33.13 | 46.00 | -12.87 | Peak | |
| 6 | 261.8299 | 41.25 | -12.81 | 28.44 | 46.00 | -17.56 | Peak | |

REMARKS:

- (1) Measurement Value = Reading Level + Correct Factor.
- (2) Margin Level = Measurement Value - Limit Value.

Test Mode: TX Mode Channel 19_1Mbps

Horizontal

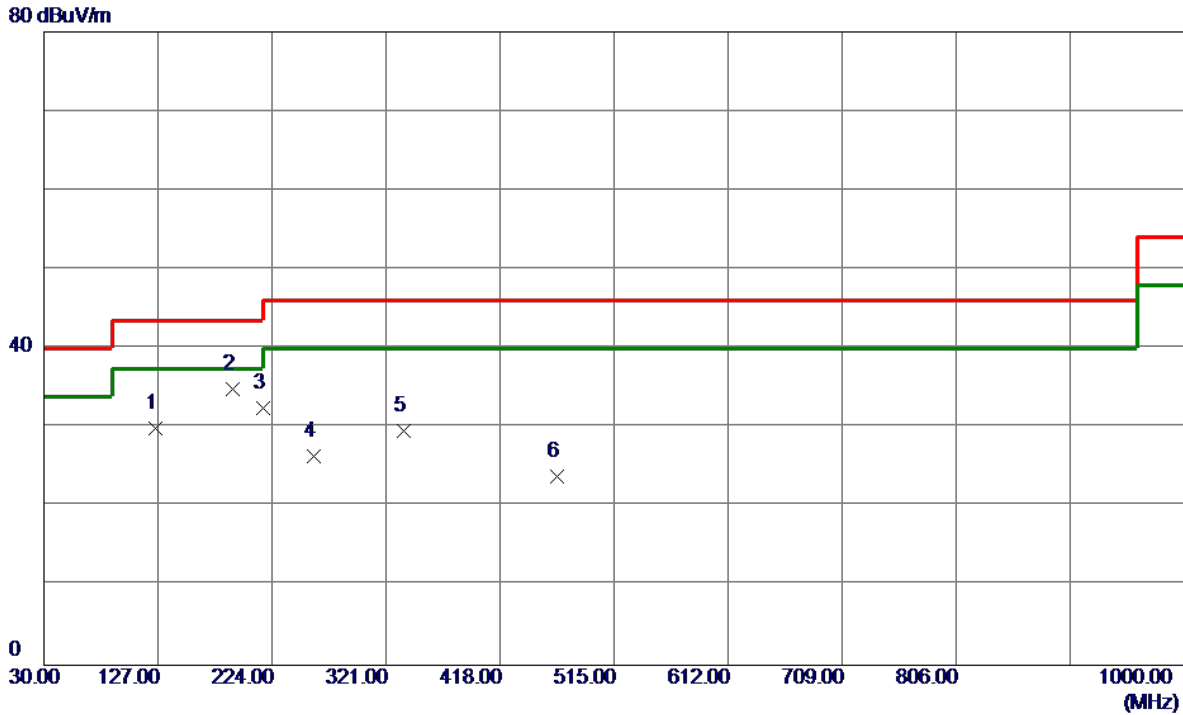

| No. | Freq. MHz | Reading Level dBuV/m | Correct Factor dB | Measure ment dBuV/m | Limit dBuV/m | Margin dB | Detector | Comment |
|-----|--------------|----------------------------|-------------------------|---------------------------|-----------------|--------------|----------|---------|
| 1 | 125.0600 | 43.03 | -13.11 | 29.92 | 43.50 | -13.58 | Peak | |
| 2 * | 190.0500 | 49.45 | -14.53 | 34.92 | 43.50 | -8.58 | Peak | |
| 3 | 216.2400 | 47.60 | -15.07 | 32.53 | 46.00 | -13.47 | Peak | |
| 4 | 259.8900 | 39.19 | -12.74 | 26.45 | 46.00 | -19.55 | Peak | |
| 5 | 336.5200 | 40.59 | -10.96 | 29.63 | 46.00 | -16.37 | Peak | |
| 6 | 466.5000 | 31.86 | -8.02 | 23.84 | 46.00 | -22.16 | Peak | |

REMARKS:

(1) Measurement Value = Reading Level + Correct Factor.

(2) Margin Level = Measurement Value - Limit Value.

APPENDIX D - RADIATED EMISSION - ABOVE 1000 MHZ

Test Mode : TX 2402 MHz _CH00_1Mbps

Vertical

130 dBuV/m

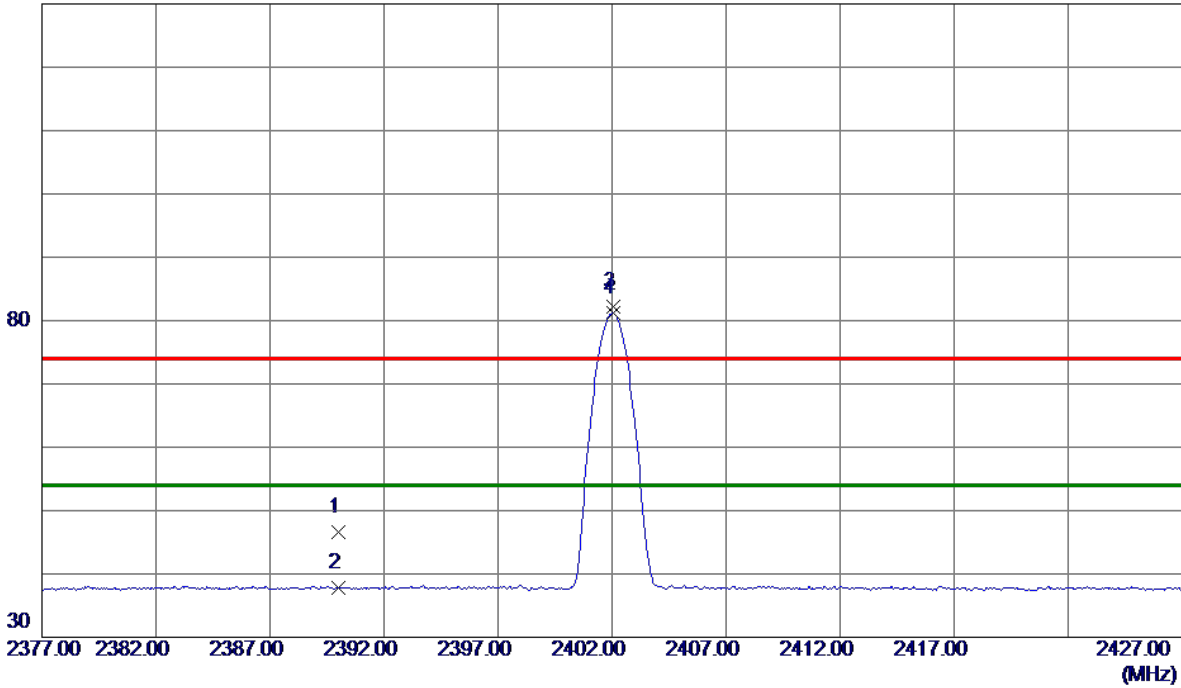

| No. | Freq. MHz | Reading Level dBuV/m | Correct Factor dB | Measure ment dBuV/m | Limit dBuV/m | Margin dB | Detector | Comment |
|-----|--------------|----------------------------|-------------------------|---------------------------|-----------------|--------------|----------|----------|
| 1 | 2390.0000 | 37.62 | 9.07 | 46.69 | 74.00 | -27.31 | Peak | |
| 2 | 2390.0000 | 28.72 | 9.07 | 37.79 | 54.00 | -16.21 | AVG | |
| 3 | 2402.0500 | 73.10 | 9.06 | 82.16 | 74.00 | 8.16 | Peak | No Limit |
| 4 * | 2402.0500 | 72.07 | 9.06 | 81.13 | 54.00 | 27.13 | AVG | No Limit |

REMARKS:

- (1) Measurement Value = Reading Level + Correct Factor.
- (2) Margin Level = Measurement Value - Limit Value.

Test Mode : TX 2402 MHz _CH00_1Mbps

Vertical

80 dBuV/m

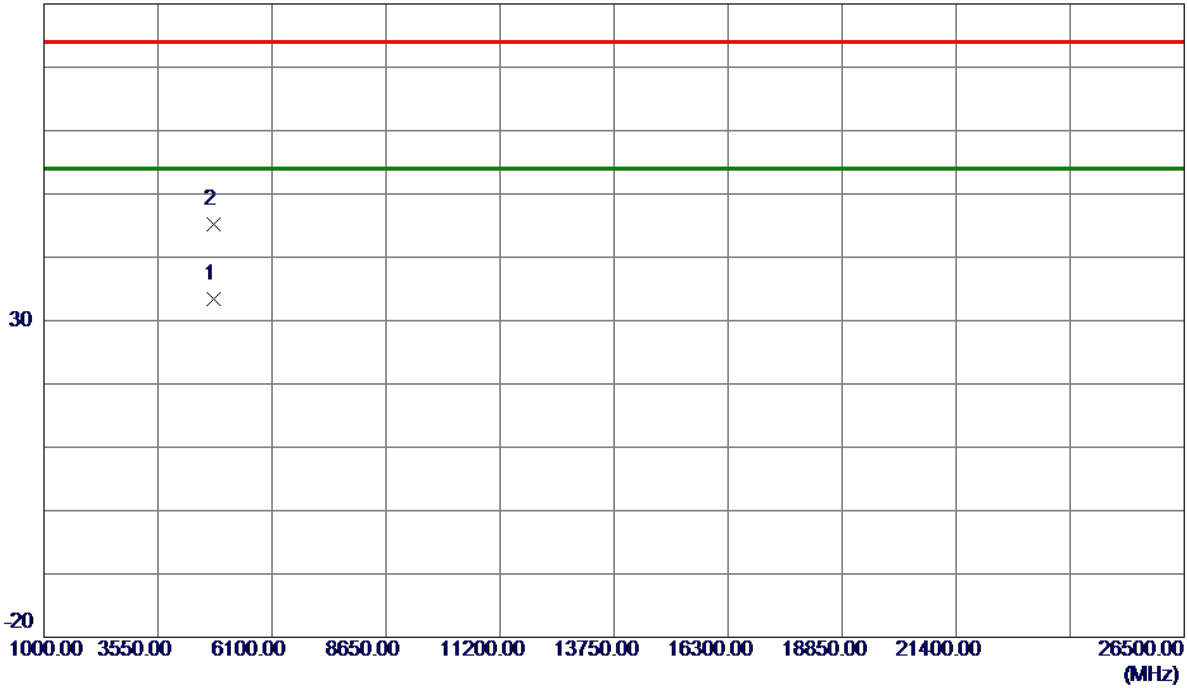

| No. | Freq. MHz | Reading Level dBuV/m | Correct Factor dB | Measure ment dBuV/m | Limit dBuV/m | Margin dB | Detector | Comment |
|-----|--------------|----------------------------|-------------------------|---------------------------|-----------------|--------------|----------|---------|
| 1 * | 4805.7950 | 25.43 | 7.98 | 33.41 | 54.00 | -20.59 | AVG | |
| 2 | 4806.7700 | 37.30 | 7.98 | 45.28 | 74.00 | -28.72 | Peak | |

REMARKS:

- (1) Measurement Value = Reading Level + Correct Factor.
- (2) Margin Level = Measurement Value - Limit Value.

Test Mode : TX 2402 MHz _CH00_1Mbps

Horizontal

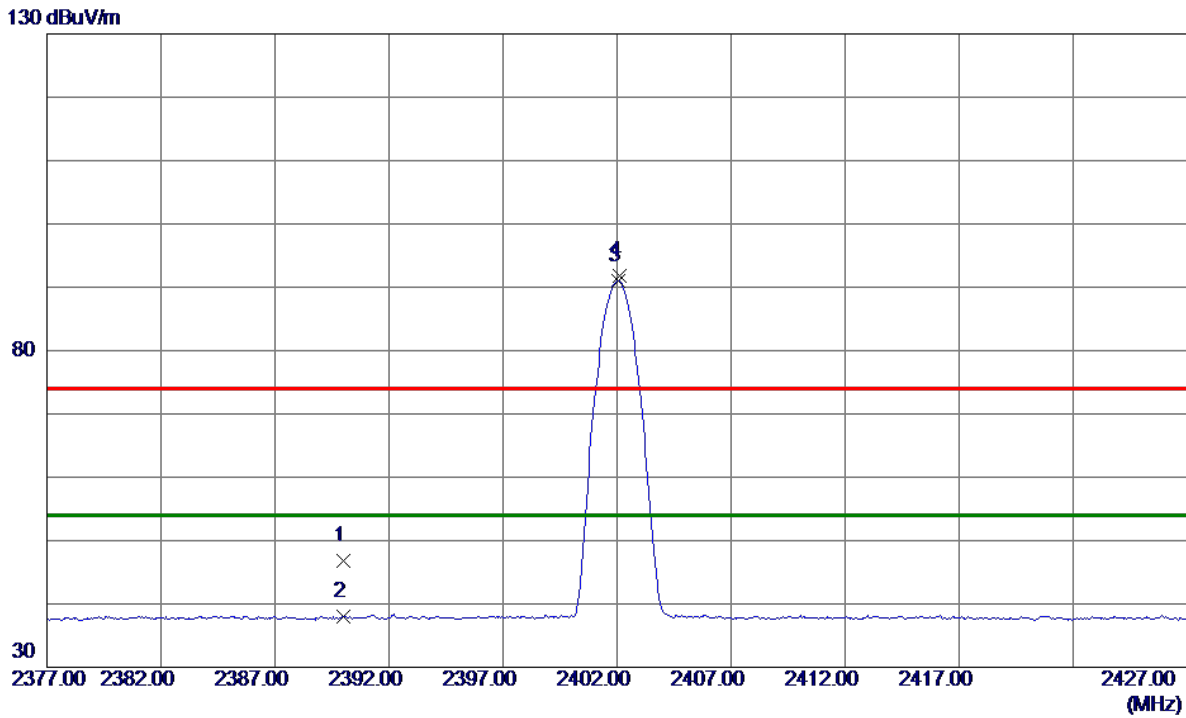

| No. | Freq. MHz | Reading Level dBuV/m | Correct Factor dB | Measure ment dBuV/m | Limit dBuV/m | Margin dB | Detector | Comment |
|-----|--------------|----------------------------|-------------------------|---------------------------|-----------------|--------------|----------|----------|
| 1 | 2390.0000 | 37.80 | 9.07 | 46.87 | 74.00 | -27.13 | Peak | |
| 2 | 2390.0000 | 28.98 | 9.07 | 38.05 | 54.00 | -15.95 | AVG | |
| 3 * | 2402.0500 | 81.87 | 9.06 | 90.93 | 54.00 | 36.93 | AVG | No Limit |
| 4 | 2402.1000 | 82.81 | 9.06 | 91.87 | 74.00 | 17.87 | Peak | No Limit |

REMARKS:

- (1) Measurement Value = Reading Level + Correct Factor.
- (2) Margin Level = Measurement Value - Limit Value.

Test Mode : TX 2402 MHz _CH00_1Mbps

Horizontal

80 dBuV/m

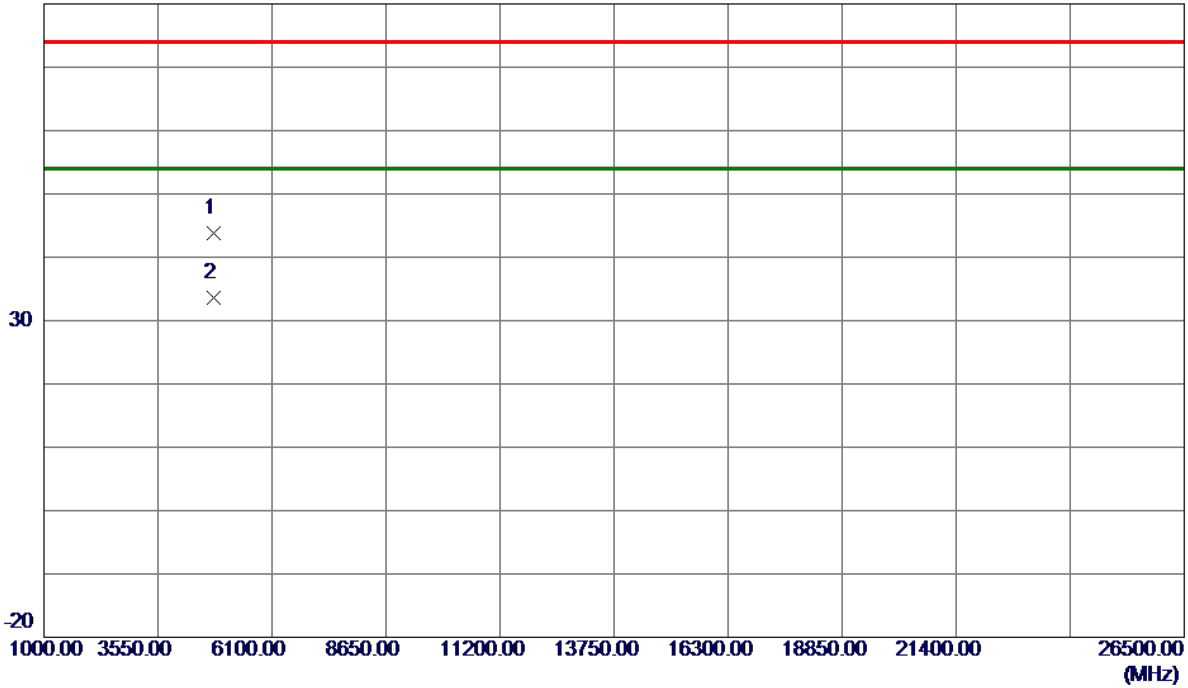

| No. | Freq. MHz | Reading Level dBuV/m | Correct Factor dB | Measure ment dBuV/m | Limit dBuV/m | Margin dB | Detector | Comment |
|-----|--------------|----------------------------|-------------------------|---------------------------|-----------------|--------------|----------|---------|
| 1 | 4805.5850 | 35.88 | 7.98 | 43.86 | 74.00 | -30.14 | Peak | |
| 2 * | 4805.8950 | 25.54 | 7.98 | 33.52 | 54.00 | -20.48 | AVG | |

REMARKS:

- (1) Measurement Value = Reading Level + Correct Factor.
- (2) Margin Level = Measurement Value - Limit Value.

Test Mode : TX 2440 MHz _CH19_1Mbps

Vertical

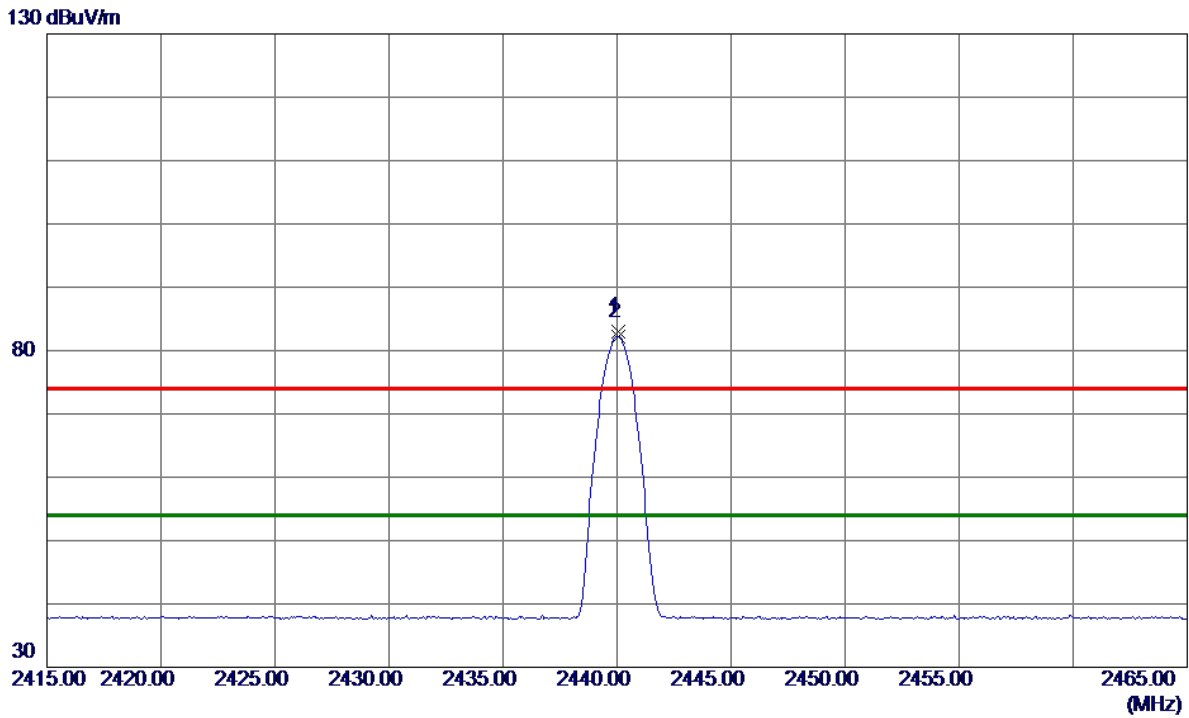

| No. | Freq. MHz | Reading Level dBuV/m | Correct Factor dB | Measure ment dBuV/m | Limit dBuV/m | Margin dB | Detector | Comment |
|-----|--------------|----------------------------|-------------------------|---------------------------|-----------------|--------------|----------|----------|
| 1 | 2440.0500 | 73.95 | 9.04 | 82.99 | 74.00 | 8.99 | Peak | No Limit |
| 2 * | 2440.0500 | 73.13 | 9.04 | 82.17 | 54.00 | 28.17 | AVG | No Limit |

REMARKS:

- (1) Measurement Value = Reading Level + Correct Factor.
- (2) Margin Level = Measurement Value - Limit Value.

Test Mode : TX 2440 MHz _CH19_1Mbps

Vertical

80 dBuV/m

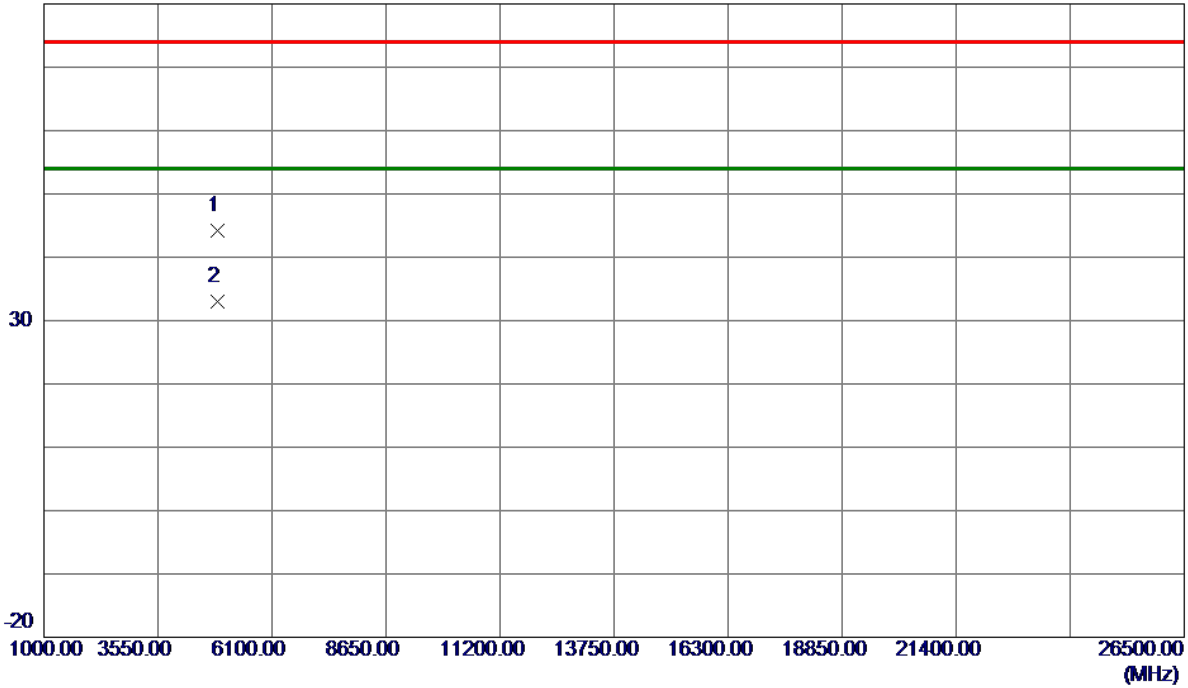

| No. | Freq. MHz | Reading Level dBuV/m | Correct Factor dB | Measure ment dBuV/m | Limit dBuV/m | Margin dB | Detector | Comment |
|-----|--------------|----------------------------|-------------------------|---------------------------|-----------------|--------------|----------|---------|
| 1 | 4880.2650 | 35.89 | 8.23 | 44.12 | 74.00 | -29.88 | Peak | |
| 2 * | 4880.4400 | 24.69 | 8.23 | 32.92 | 54.00 | -21.08 | AVG | |

REMARKS:

- (1) Measurement Value = Reading Level + Correct Factor.
- (2) Margin Level = Measurement Value - Limit Value.

Test Mode : TX 2440 MHz _CH19_1Mbps

Horizontal

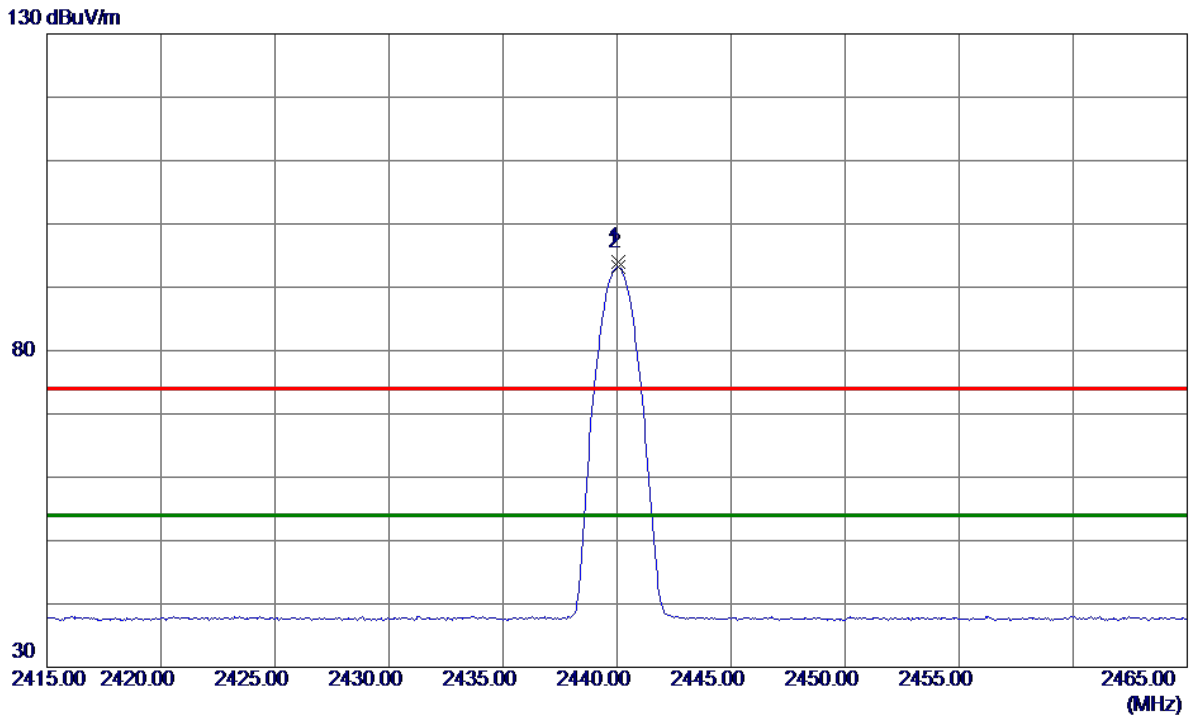

| No. | Freq. MHz | Reading Level dBuV/m | Correct Factor dB | Measure ment dBuV/m | Limit dBuV/m | Margin dB | Detector | Comment |
|-----|--------------|----------------------------|-------------------------|---------------------------|-----------------|--------------|----------|----------|
| 1 | 2440.0500 | 85.02 | 9.04 | 94.06 | 74.00 | 20.06 | Peak | No Limit |
| 2 * | 2440.0500 | 84.08 | 9.04 | 93.12 | 54.00 | 39.12 | AVG | No Limit |

REMARKS:

- (1) Measurement Value = Reading Level + Correct Factor.
- (2) Margin Level = Measurement Value - Limit Value.

Test Mode : TX 2440 MHz _CH19_1Mbps

Horizontal

80 dBuV/m

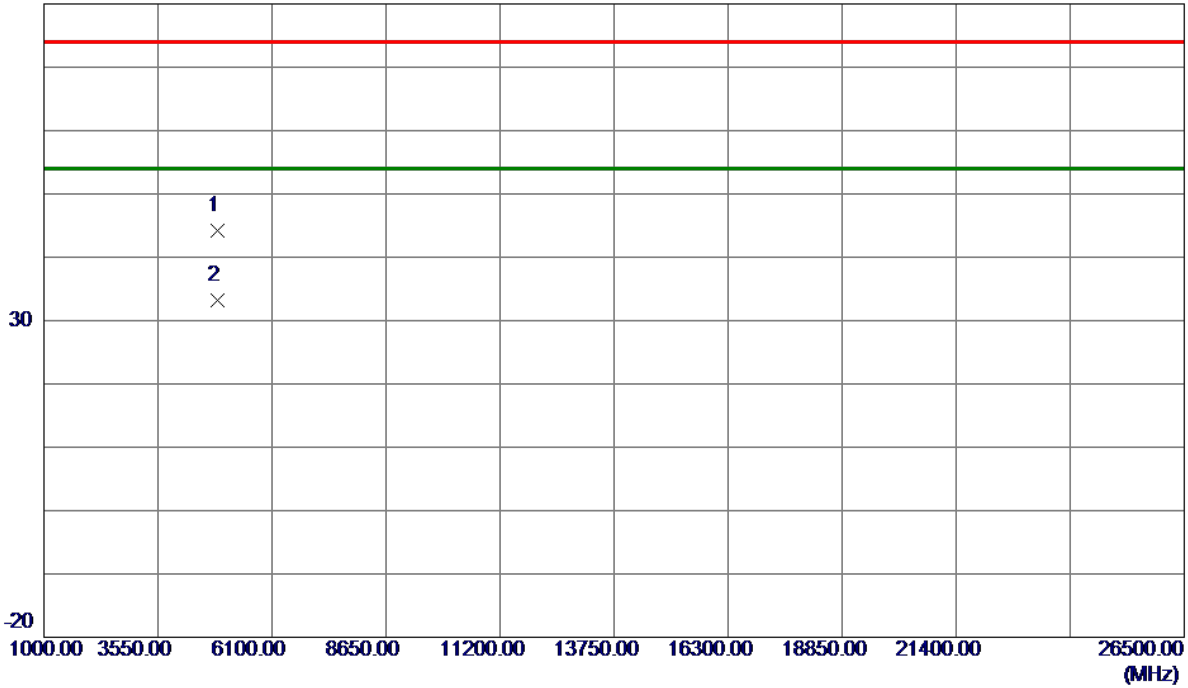

| No. | Freq. MHz | Reading Level dBuV/m | Correct Factor dB | Measure ment dBuV/m | Limit dBuV/m | Margin dB | Detector | Comment |
|-----|--------------|----------------------------|-------------------------|---------------------------|-----------------|--------------|----------|---------|
| 1 | 4880.0250 | 35.97 | 8.23 | 44.20 | 74.00 | -29.80 | Peak | |
| 2 * | 4880.3800 | 24.94 | 8.23 | 33.17 | 54.00 | -20.83 | AVG | |

REMARKS:

- (1) Measurement Value = Reading Level + Correct Factor.
- (2) Margin Level = Measurement Value - Limit Value.

Test Mode : TX 2480 MHz _CH39_1Mbps

Vertical

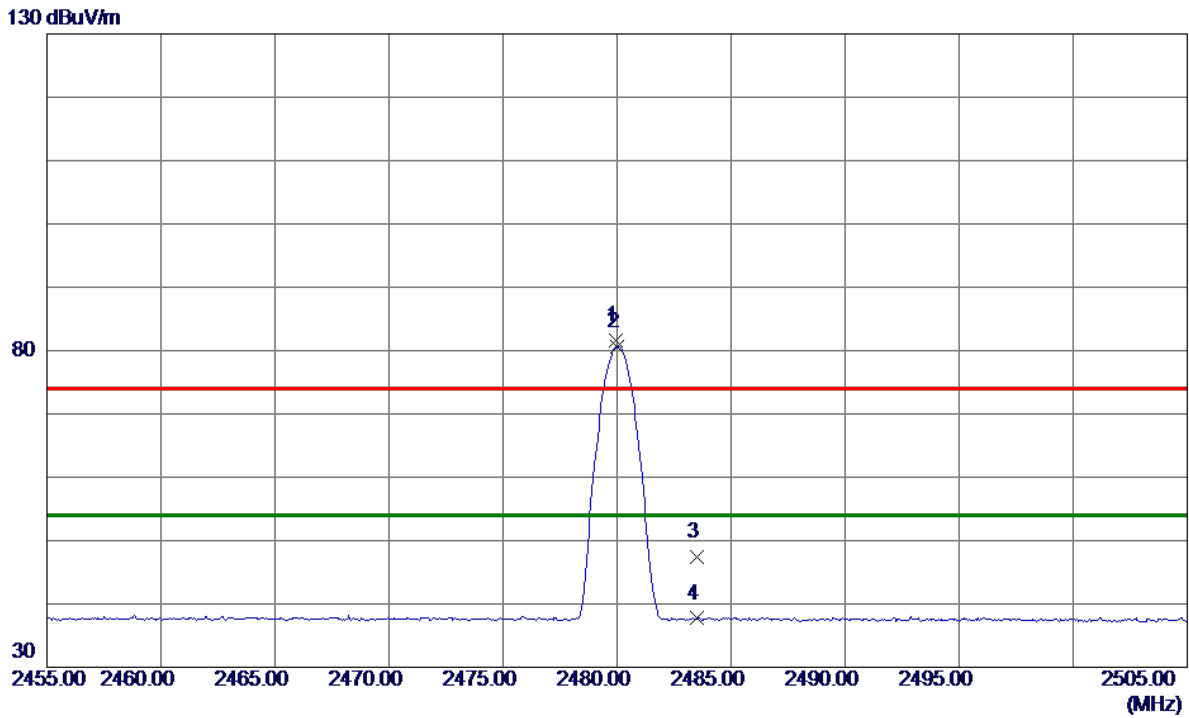

| No. | Freq. MHz | Reading Level dBuV/m | Correct Factor dB | Measure ment dBuV/m | Limit dBuV/m | Margin dB | Detector | Comment |
|-----|--------------|----------------------------|-------------------------|---------------------------|-----------------|--------------|----------|----------|
| 1 | 2479.9500 | 72.52 | 9.02 | 81.54 | 74.00 | 7.54 | Peak | No Limit |
| 2 * | 2480.0000 | 71.66 | 9.02 | 80.68 | 54.00 | 26.68 | AVG | No Limit |
| 3 | 2483.5000 | 38.46 | 9.01 | 47.47 | 74.00 | -26.53 | Peak | |
| 4 | 2483.5000 | 28.69 | 9.01 | 37.70 | 54.00 | -16.30 | AVG | |

REMARKS:
 (1) Measurement Value = Reading Level + Correct Factor.
 (2) Margin Level = Measurement Value - Limit Value.

Test Mode : TX 2480 MHz _CH39_1Mbps

Vertical

80 dBuV/m

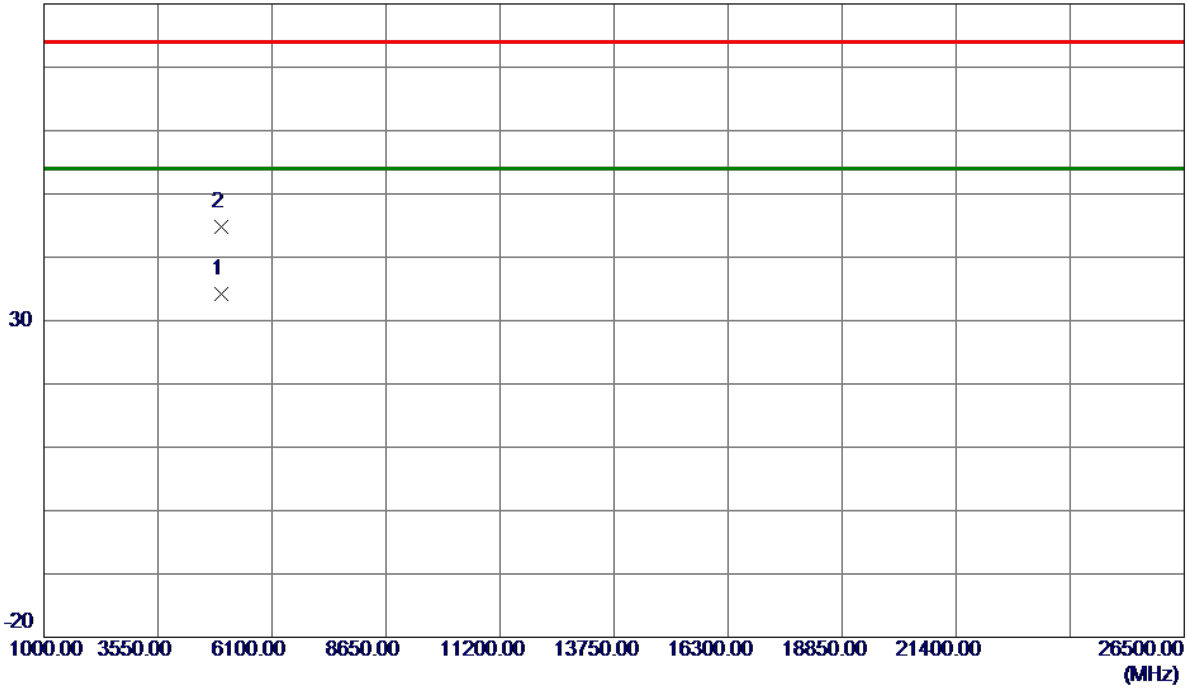

| No. | Freq. MHz | Reading Level dBuV/m | Correct Factor dB | Measure ment dBuV/m | Limit dBuV/m | Margin dB | Detector | Comment |
|-----|--------------|----------------------------|-------------------------|---------------------------|-----------------|--------------|----------|---------|
| 1 * | 4959.5150 | 25.65 | 8.49 | 34.14 | 54.00 | -19.86 | AVG | |
| 2 | 4960.7799 | 36.35 | 8.50 | 44.85 | 74.00 | -29.15 | Peak | |

REMARKS:

- (1) Measurement Value = Reading Level + Correct Factor.
- (2) Margin Level = Measurement Value - Limit Value.

Test Mode : TX 2480 MHz _CH39_1Mbps

Horizontal

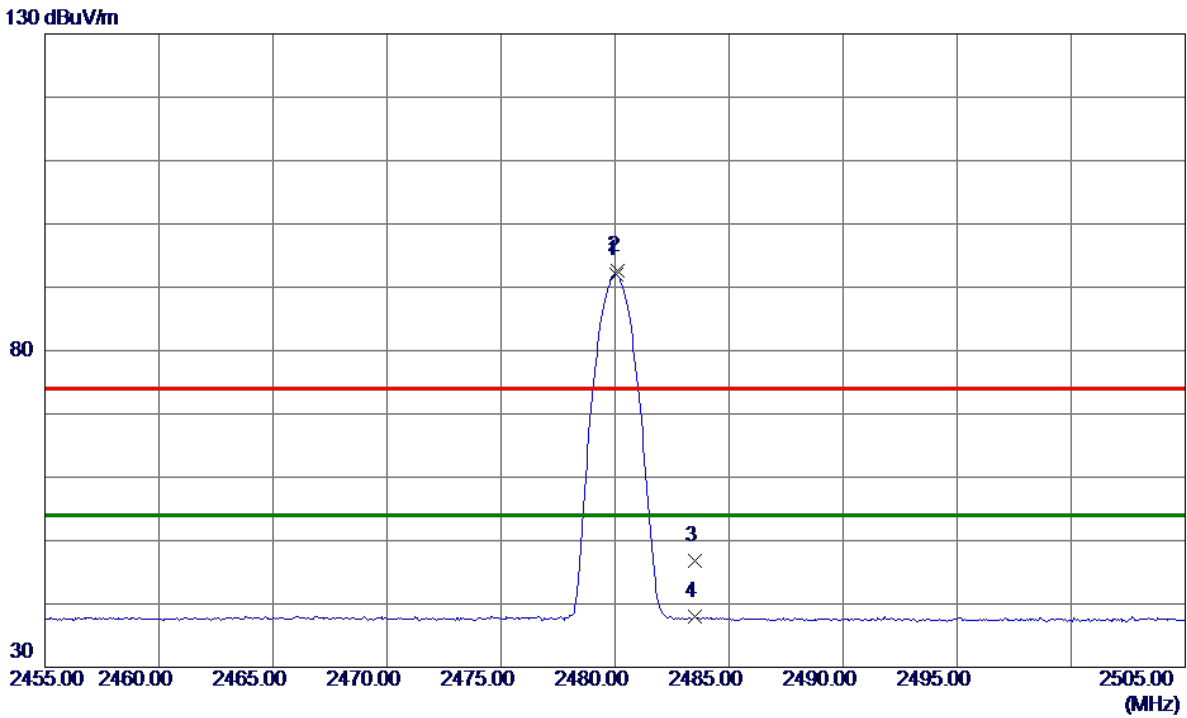

| No. | Freq. MHz | Reading Level dBuV/m | Correct Factor dB | Measure ment dBuV/m | Limit dBuV/m | Margin dB | Detector | Comment |
|-----|--------------|----------------------------|-------------------------|---------------------------|-----------------|--------------|----------|----------|
| 1 * | 2480.0500 | 82.88 | 9.02 | 91.90 | 54.00 | 37.90 | AVG | No Limit |
| 2 | 2480.1000 | 83.58 | 9.02 | 92.60 | 74.00 | 18.60 | Peak | No Limit |
| 3 | 2483.5000 | 37.79 | 9.01 | 46.80 | 74.00 | -27.20 | Peak | |
| 4 | 2483.5000 | 28.94 | 9.01 | 37.95 | 54.00 | -16.05 | AVG | |

REMARKS:

- (1) Measurement Value = Reading Level + Correct Factor.
- (2) Margin Level = Measurement Value - Limit Value.

Test Mode : TX 2480 MHz _CH39_1Mbps

Horizontal

80 dBuV/m

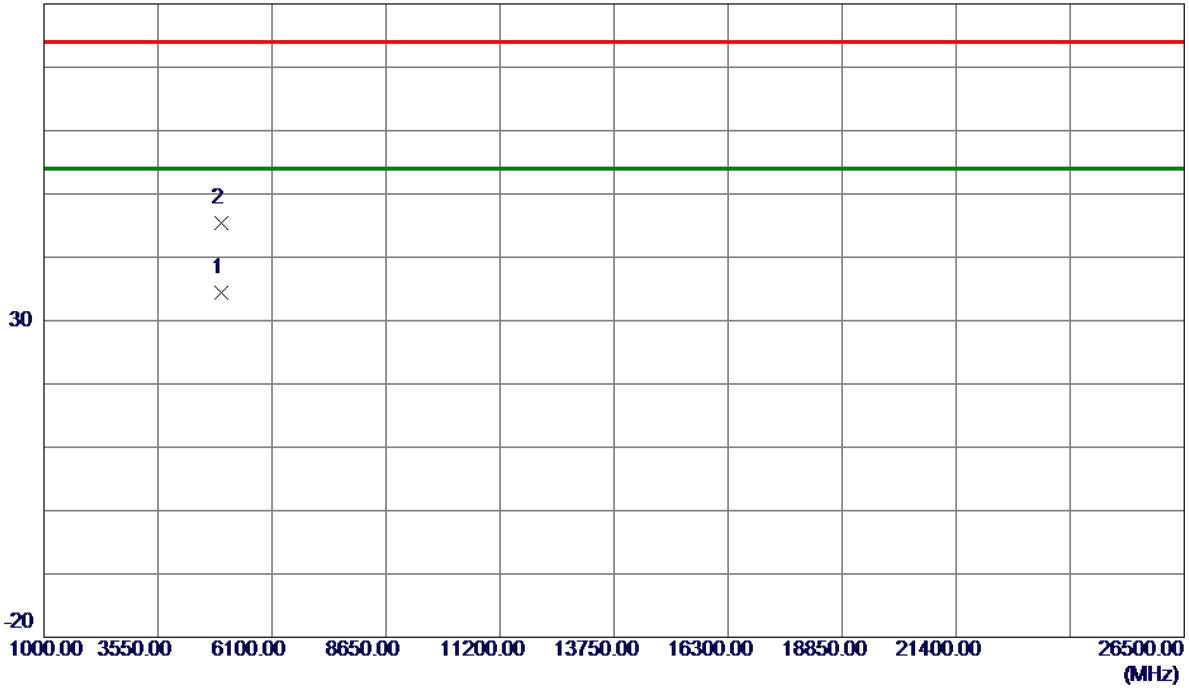

| No. | Freq. MHz | Reading Level dBuV/m | Correct Factor dB | Measure ment dBuV/m | Limit dBuV/m | Margin dB | Detector | Comment |
|-----|--------------|----------------------------|-------------------------|---------------------------|-----------------|--------------|----------|---------|
| 1 * | 4959.9300 | 25.86 | 8.50 | 34.36 | 54.00 | -19.64 | AVG | |
| 2 | 4960.5299 | 36.85 | 8.50 | 45.35 | 74.00 | -28.65 | Peak | |

REMARKS:

- (1) Measurement Value = Reading Level + Correct Factor.
- (2) Margin Level = Measurement Value - Limit Value.

Test Mode : TX 2402 MHz _CH00_2Mbps

Vertical

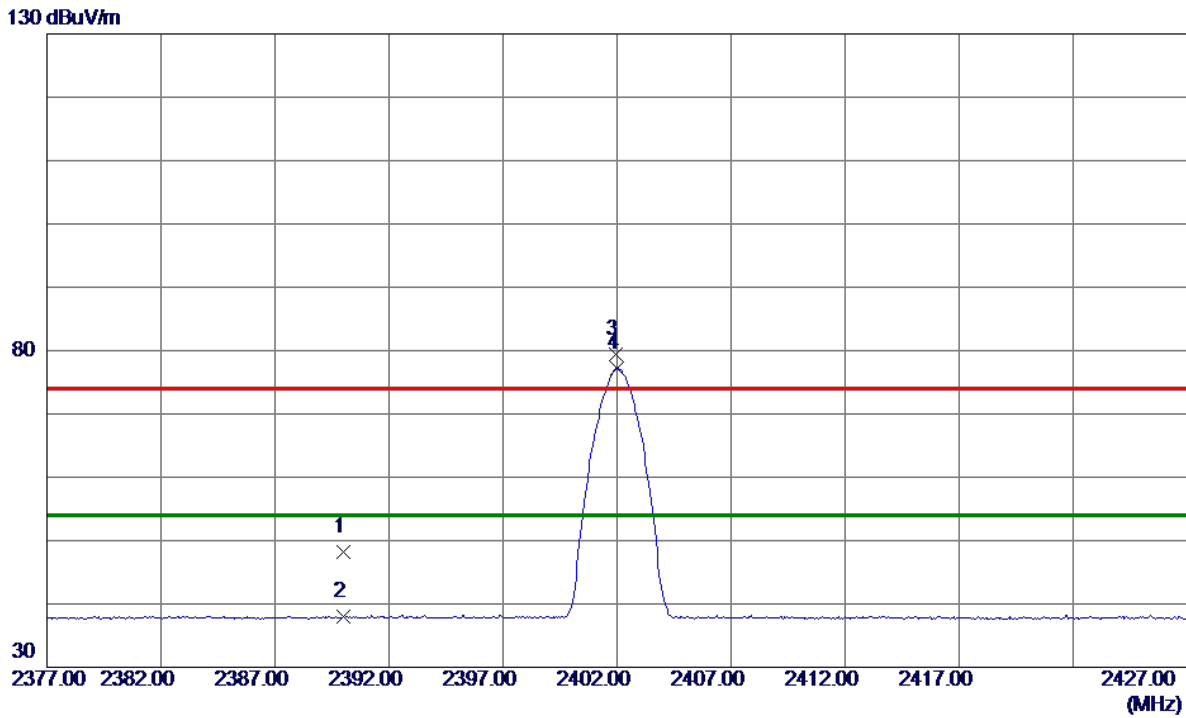

| No. | Freq. MHz | Reading Level dBuV/m | Correct Factor dB | Measure ment dBuV/m | Limit dBuV/m | Margin dB | Detector | Comment |
|-----|--------------|----------------------------|-------------------------|---------------------------|-----------------|--------------|----------|----------|
| 1 | 2390.0000 | 39.05 | 9.07 | 48.12 | 74.00 | -25.88 | Peak | |
| 2 | 2390.0000 | 28.86 | 9.07 | 37.93 | 54.00 | -16.07 | AVG | |
| 3 | 2401.9500 | 70.31 | 9.06 | 79.37 | 74.00 | 5.37 | Peak | No Limit |
| 4 * | 2402.0000 | 68.14 | 9.06 | 77.20 | 54.00 | 23.20 | AVG | No Limit |

REMARKS:

- (1) Measurement Value = Reading Level + Correct Factor.
- (2) Margin Level = Measurement Value - Limit Value.

Test Mode : TX 2402 MHz _CH00_2Mbps

Vertical

80 dBuV/m

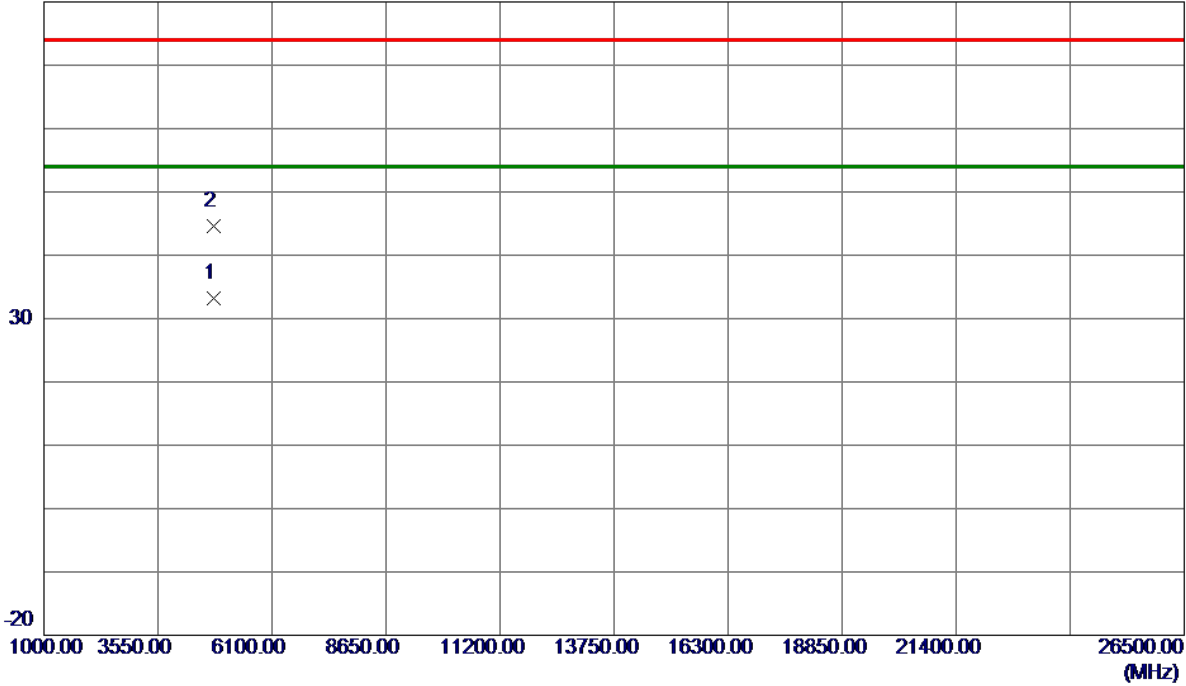

| No. | Freq. MHz | Reading Level dBuV/m | Correct Factor dB | Measure ment dBuV/m | Limit dBuV/m | Margin dB | Detector | Comment |
|-----|--------------|----------------------------|-------------------------|---------------------------|-----------------|--------------|----------|---------|
| 1 * | 4806.2850 | 25.16 | 7.98 | 33.14 | 54.00 | -20.86 | AVG | |
| 2 | 4806.3800 | 36.70 | 7.98 | 44.68 | 74.00 | -29.32 | Peak | |

REMARKS:

- (1) Measurement Value = Reading Level + Correct Factor.
- (2) Margin Level = Measurement Value - Limit Value.

Test Mode : TX 2402 MHz _CH00_2Mbps

Horizontal

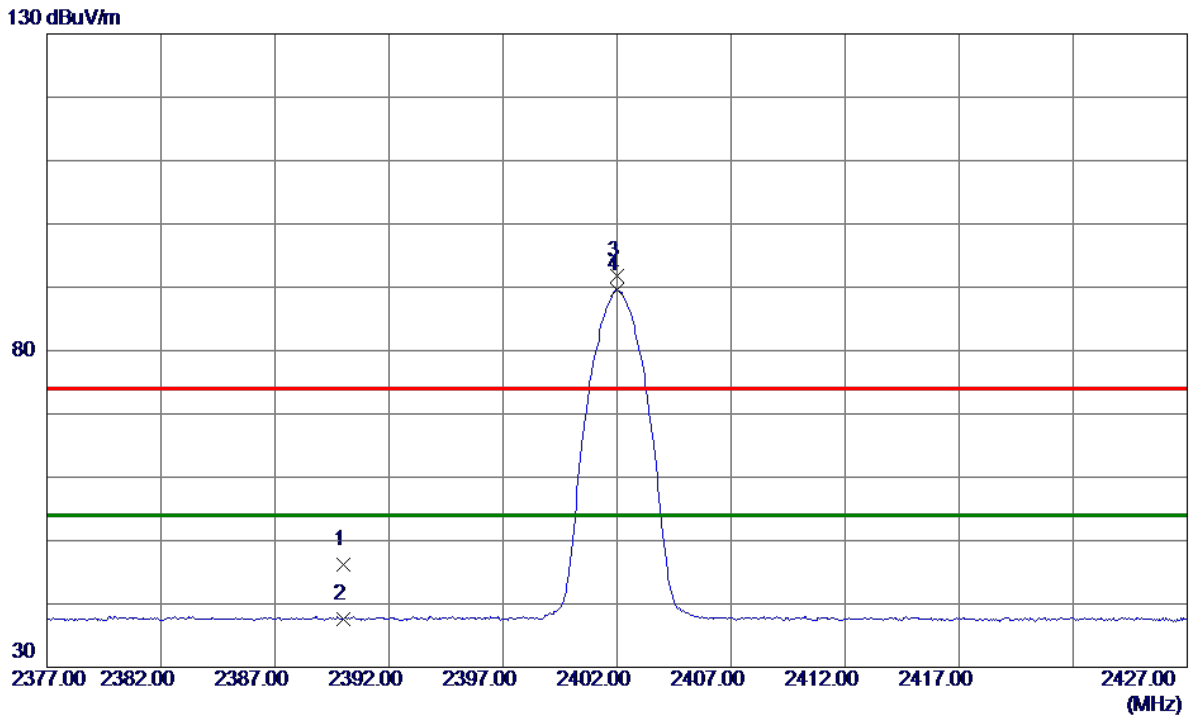

| No. | Freq. MHz | Reading Level dBuV/m | Correct Factor dB | Measure ment dBuV/m | Limit dBuV/m | Margin dB | Detector | Comment |
|-----|--------------|----------------------------|-------------------------|---------------------------|-----------------|--------------|----------|----------|
| 1 | 2390.0000 | 37.18 | 9.07 | 46.25 | 74.00 | -27.75 | Peak | |
| 2 | 2390.0000 | 28.54 | 9.07 | 37.61 | 54.00 | -16.39 | AVG | |
| 3 | 2402.0000 | 82.65 | 9.06 | 91.71 | 74.00 | 17.71 | Peak | No Limit |
| 4 * | 2402.0000 | 80.49 | 9.06 | 89.55 | 54.00 | 35.55 | AVG | No Limit |

REMARKS:

- (1) Measurement Value = Reading Level + Correct Factor.
- (2) Margin Level = Measurement Value - Limit Value.

Test Mode : TX 2402 MHz _CH00_2Mbps

Horizontal

80 dBuV/m

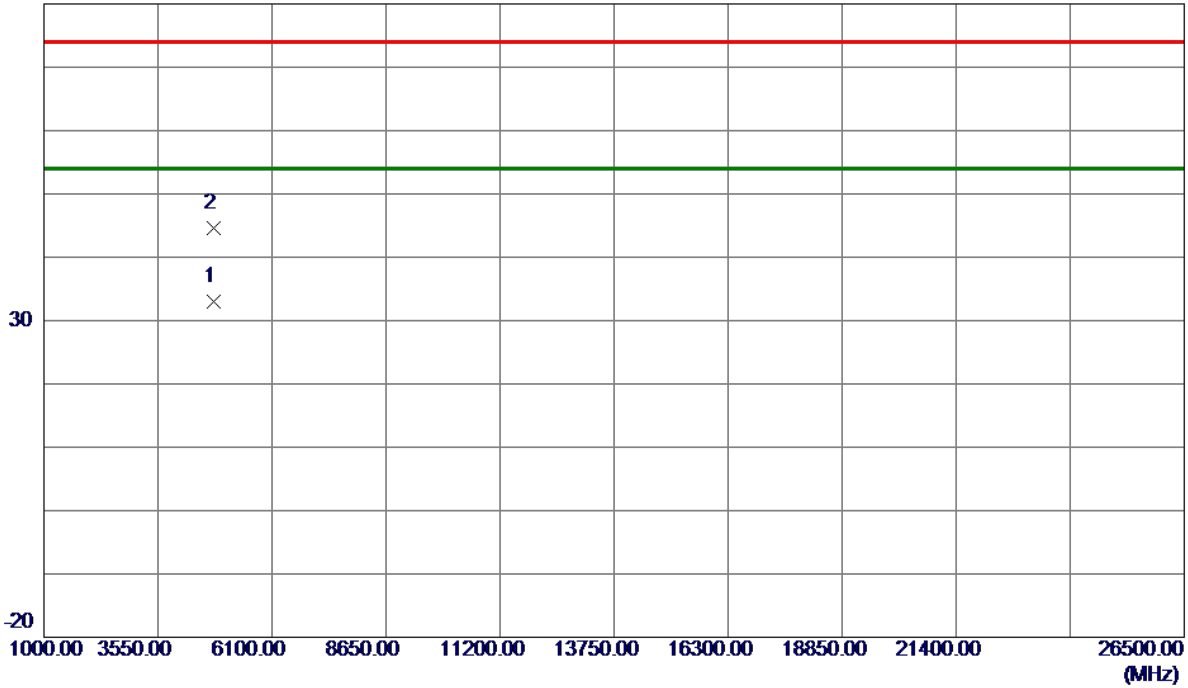

| No. | Freq. MHz | Reading Level dBuV/m | Correct Factor dB | Measurement dBuV/m | Limit dBuV/m | Margin dB | Detector | Comment |
|-----|-----------|----------------------|-------------------|--------------------|--------------|-----------|----------|---------|
| 1 * | 4804.8100 | 25.11 | 7.98 | 33.09 | 54.00 | -20.91 | AVG | |
| 2 | 4805.6250 | 36.57 | 7.98 | 44.55 | 74.00 | -29.45 | Peak | |

REMARKS:

- (1) Measurement Value = Reading Level + Correct Factor.
- (2) Margin Level = Measurement Value - Limit Value.

Test Mode : TX 2440 MHz _CH19_2Mbps

Vertical

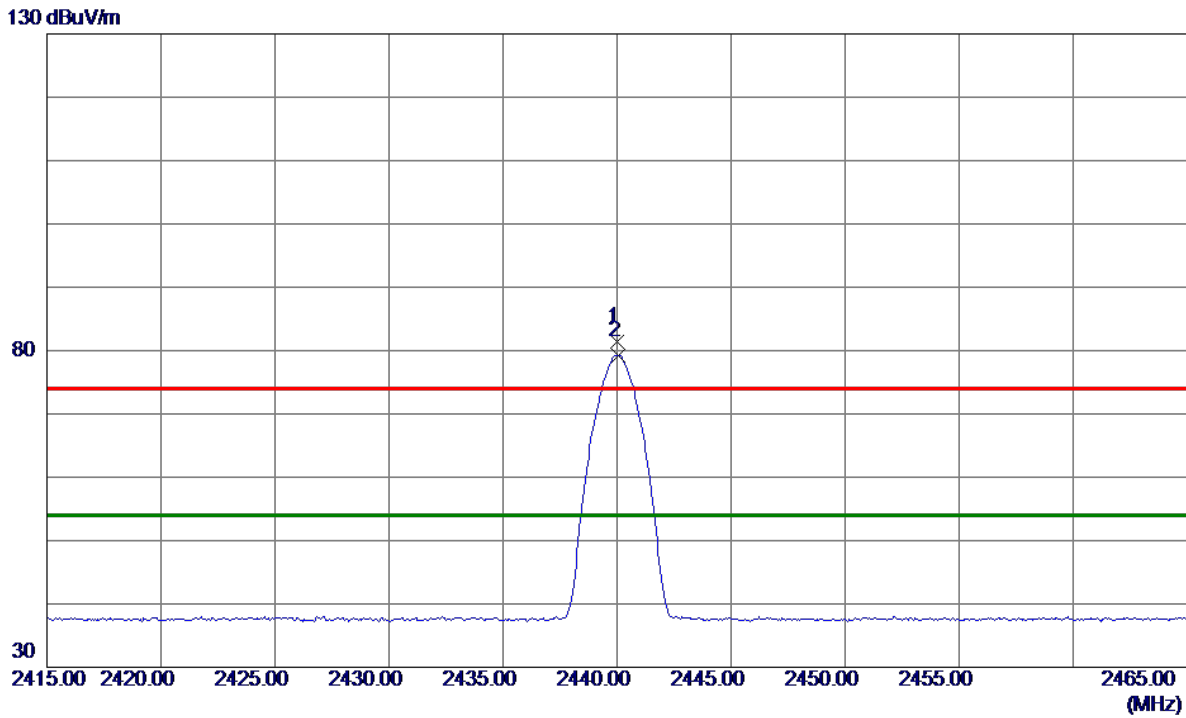

| No. | Freq. MHz | Reading Level dBuV/m | Correct Factor dB | Measure ment dBuV/m | Limit dBuV/m | Margin dB | Detector | Comment |
|-----|--------------|----------------------------|-------------------------|---------------------------|-----------------|--------------|----------|----------|
| 1 | 2440.0000 | 72.45 | 9.04 | 81.49 | 74.00 | 7.49 | Peak | No Limit |
| 2 * | 2440.0500 | 70.24 | 9.04 | 79.28 | 54.00 | 25.28 | AVG | No Limit |

REMARKS:

- (1) Measurement Value = Reading Level + Correct Factor.
- (2) Margin Level = Measurement Value - Limit Value.

Test Mode : TX 2440 MHz _CH19_2Mbps

Vertical

80 dBuV/m

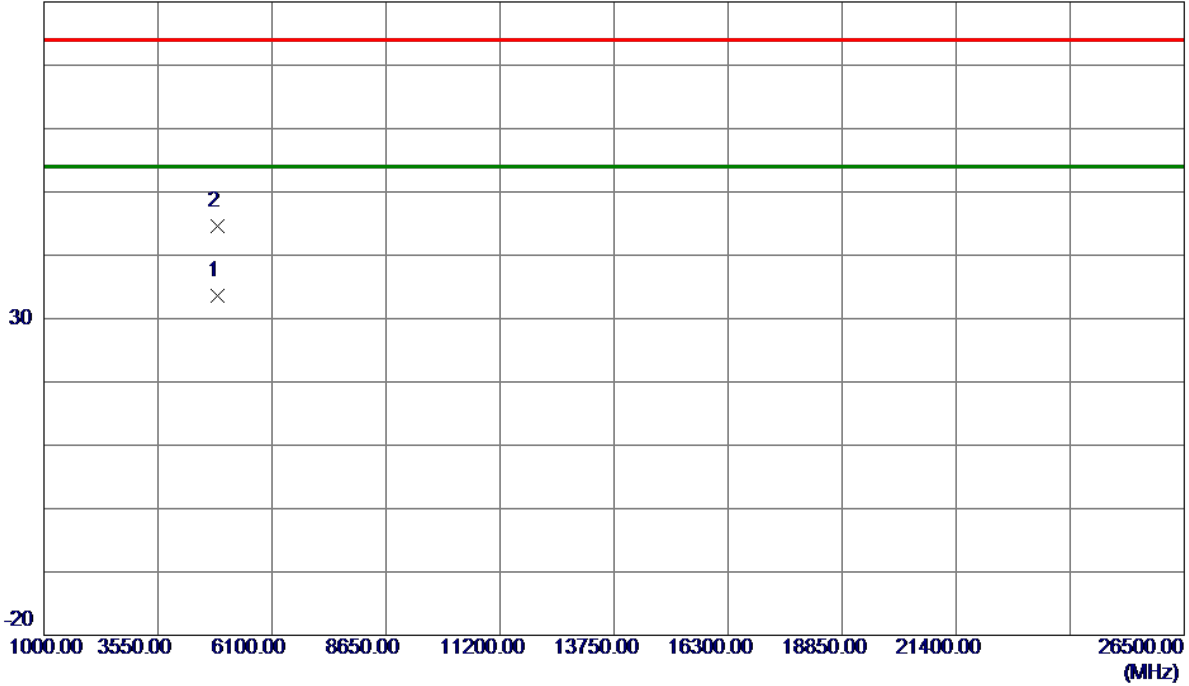

| No. | Freq. MHz | Reading Level dBuV/m | Correct Factor dB | Measure ment dBuV/m | Limit dBuV/m | Margin dB | Detector | Comment |
|-----|--------------|----------------------------|-------------------------|---------------------------|-----------------|--------------|----------|---------|
| 1 * | 4879.9400 | 25.39 | 8.23 | 33.62 | 54.00 | -20.38 | AVG | |
| 2 | 4881.8450 | 36.46 | 8.23 | 44.69 | 74.00 | -29.31 | Peak | |

REMARKS:

- (1) Measurement Value = Reading Level + Correct Factor.
- (2) Margin Level = Measurement Value - Limit Value.

Test Mode : TX 2440 MHz _CH19_2Mbps

Horizontal

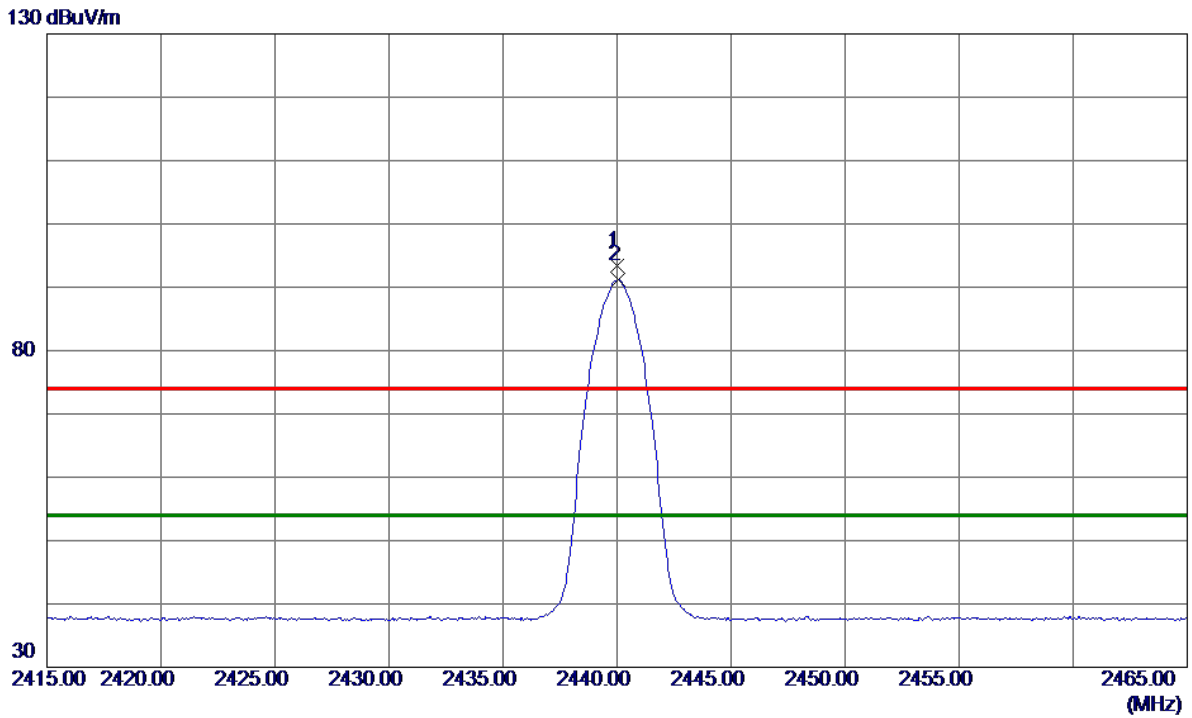

| No. | Freq. MHz | Reading Level dBuV/m | Correct Factor dB | Measure ment dBuV/m | Limit dBuV/m | Margin dB | Detector | Comment |
|-----|--------------|----------------------------|-------------------------|---------------------------|-----------------|--------------|----------|----------|
| 1 | 2440.0000 | 84.28 | 9.04 | 93.32 | 74.00 | 19.32 | Peak | No Limit |
| 2 * | 2440.0500 | 82.15 | 9.04 | 91.19 | 54.00 | 37.19 | AVG | No Limit |

REMARKS:

- (1) Measurement Value = Reading Level + Correct Factor.
- (2) Margin Level = Measurement Value - Limit Value.

Test Mode : TX 2440 MHz _CH19_2Mbps

Horizontal

80 dBuV/m

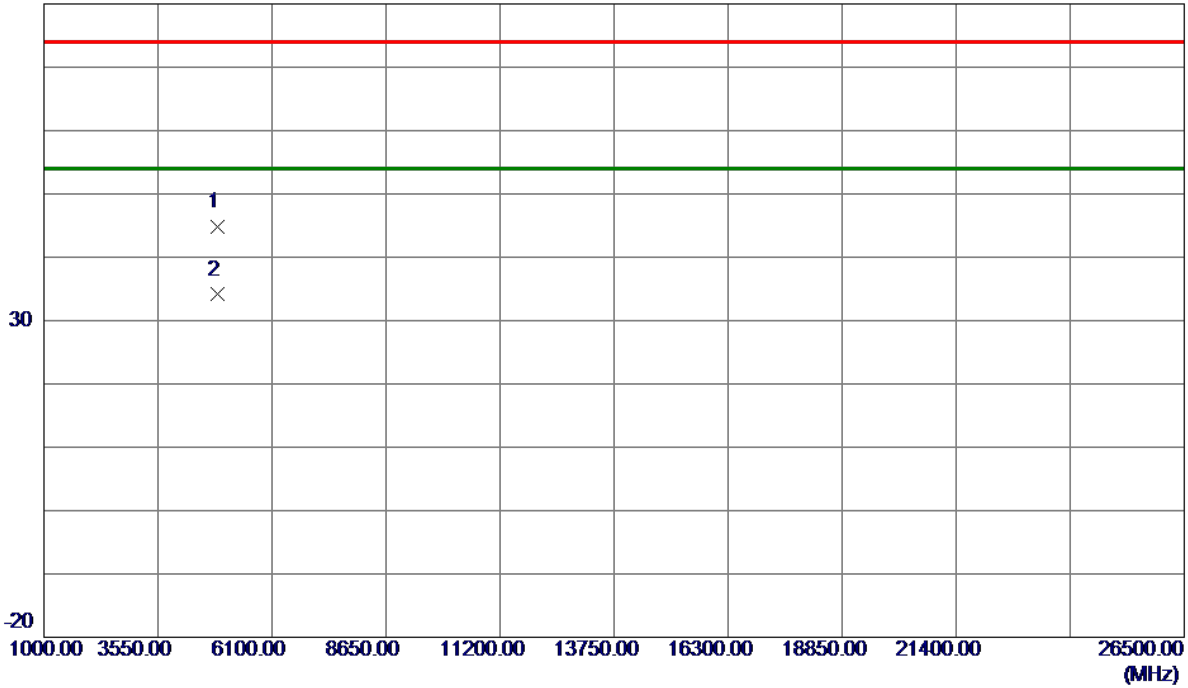

| No. | Freq. MHz | Reading Level dBuV/m | Correct Factor dB | Measure ment dBuV/m | Limit dBuV/m | Margin dB | Detector | Comment |
|-----|--------------|----------------------------|-------------------------|---------------------------|-----------------|--------------|----------|---------|
| 1 | 4879.4800 | 36.52 | 8.23 | 44.75 | 74.00 | -29.25 | Peak | |
| 2 * | 4880.1300 | 25.87 | 8.23 | 34.10 | 54.00 | -19.90 | AVG | |

REMARKS:

- (1) Measurement Value = Reading Level + Correct Factor.
- (2) Margin Level = Measurement Value - Limit Value.

Test Mode : TX 2480 MHz _CH39_2Mbps

Vertical

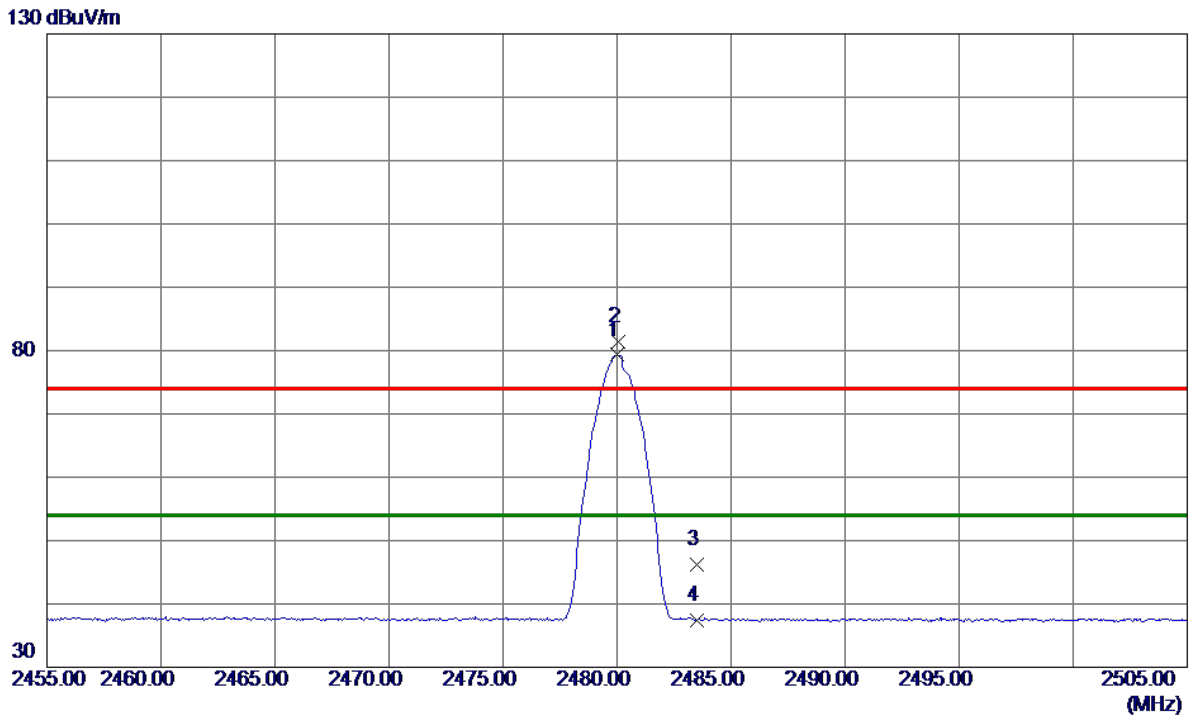

| No. | Freq. MHz | Reading Level dBuV/m | Correct Factor dB | Measure ment dBuV/m | Limit dBuV/m | Margin dB | Detector | Comment |
|-----|--------------|----------------------------|-------------------------|---------------------------|-----------------|--------------|----------|----------|
| 1 * | 2480.0000 | 70.28 | 9.02 | 79.30 | 54.00 | 25.30 | AVG | No Limit |
| 2 | 2480.0500 | 72.44 | 9.02 | 81.46 | 74.00 | 7.46 | Peak | No Limit |
| 3 | 2483.5000 | 37.16 | 9.01 | 46.17 | 74.00 | -27.83 | Peak | |
| 4 | 2483.5000 | 28.47 | 9.01 | 37.48 | 54.00 | -16.52 | AVG | |

REMARKS:

- (1) Measurement Value = Reading Level + Correct Factor.
- (2) Margin Level = Measurement Value - Limit Value.

Test Mode : TX 2480 MHz _CH39_2Mbps

Vertical

80 dBuV/m

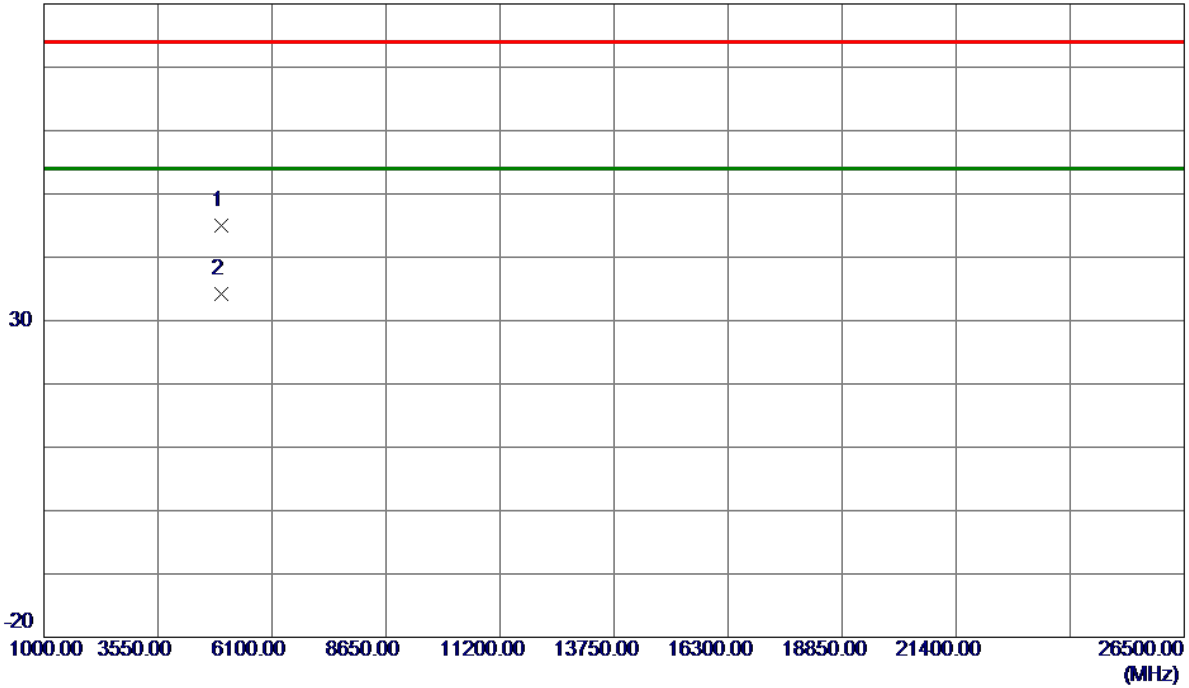

| No. | Freq. MHz | Reading Level dBuV/m | Correct Factor dB | Measure ment dBuV/m | Limit dBuV/m | Margin dB | Detector | Comment |
|-----|--------------|----------------------------|-------------------------|---------------------------|-----------------|--------------|----------|---------|
| 1 | 4958.0299 | 36.48 | 8.49 | 44.97 | 74.00 | -29.03 | Peak | |
| 2 * | 4960.2750 | 25.69 | 8.50 | 34.19 | 54.00 | -19.81 | AVG | |

REMARKS:

- (1) Measurement Value = Reading Level + Correct Factor.
- (2) Margin Level = Measurement Value - Limit Value.

Test Mode : TX 2480 MHz _CH39_2Mbps

Horizontal

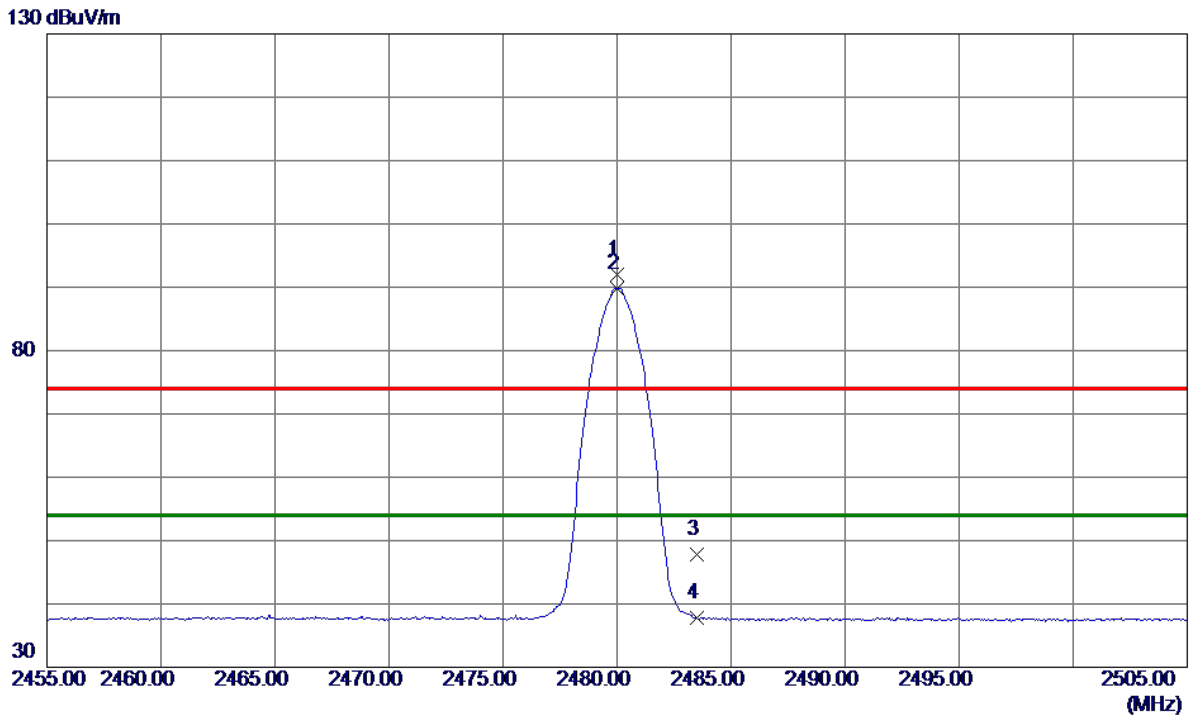

| No. | Freq. MHz | Reading Level dBuV/m | Correct Factor dB | Measure ment dBuV/m | Limit dBuV/m | Margin dB | Detector | Comment |
|-----|--------------|----------------------------|-------------------------|---------------------------|-----------------|--------------|----------|----------|
| 1 | 2480.0000 | 82.95 | 9.02 | 91.97 | 74.00 | 17.97 | Peak | No Limit |
| 2 * | 2480.0000 | 80.85 | 9.02 | 89.87 | 54.00 | 35.87 | AVG | No Limit |
| 3 | 2483.5000 | 38.77 | 9.01 | 47.78 | 74.00 | -26.22 | Peak | |
| 4 | 2483.5000 | 28.72 | 9.01 | 37.73 | 54.00 | -16.27 | AVG | |

REMARKS:

- (1) Measurement Value = Reading Level + Correct Factor.
- (2) Margin Level = Measurement Value - Limit Value.

Test Mode : TX 2480 MHz _CH39_2Mbps

Horizontal

80 dBuV/m

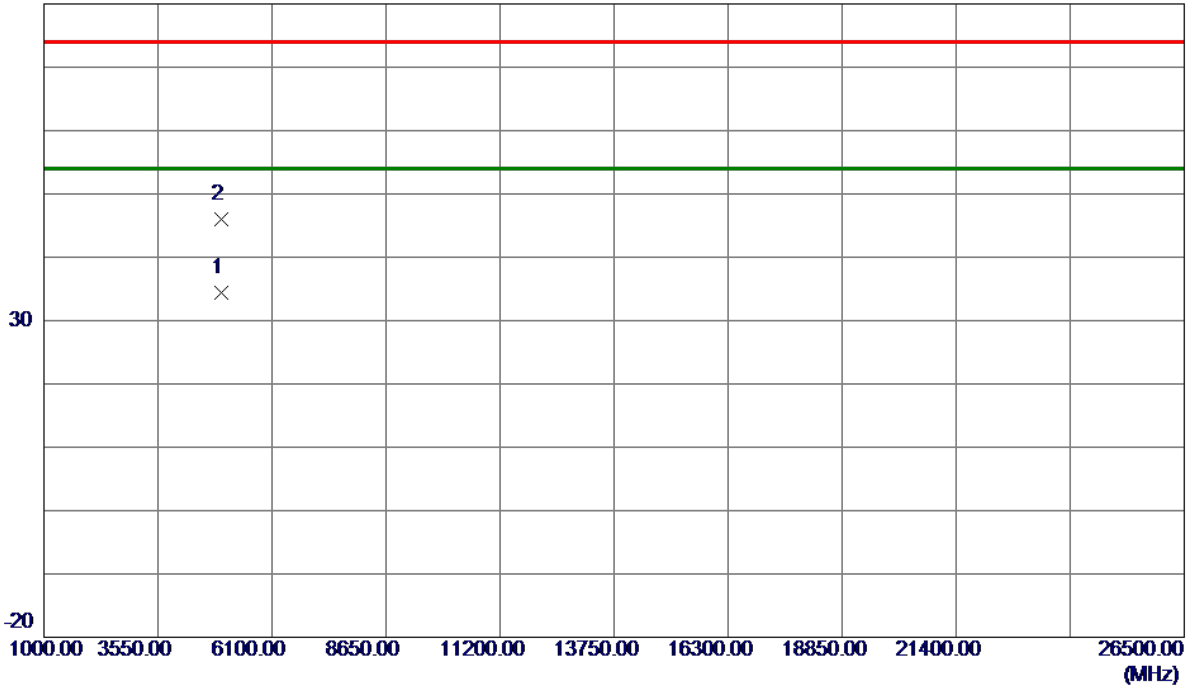

| No. | Freq. MHz | Reading Level dBuV/m | Correct Factor dB | Measure ment dBuV/m | Limit dBuV/m | Margin dB | Detector | Comment |
|-----|--------------|----------------------------|-------------------------|---------------------------|-----------------|--------------|----------|---------|
| 1 * | 4959.0650 | 25.93 | 8.49 | 34.42 | 54.00 | -19.58 | AVG | |
| 2 | 4962.3700 | 37.50 | 8.50 | 46.00 | 74.00 | -28.00 | Peak | |

REMARKS:

- (1) Measurement Value = Reading Level + Correct Factor.
- (2) Margin Level = Measurement Value - Limit Value.

APPENDIX E - BANDWIDTH

Test Mode: CH00, CH19, CH39 - 1Mbps

| Channel | Frequency (MHz) | 6 dB Bandwidth (MHz) | 99 % Emission Bandwidth (MHz) | 6 dB Bandwidth Min. Limit (kHz) | Test Result |
|---------|-----------------|----------------------|-------------------------------|---------------------------------|-------------|
| 00 | 2402 | 0.660 | 0.936 | 500 | Pass |
| 19 | 2440 | 0.648 | 0.932 | 500 | Pass |
| 39 | 2480 | 0.657 | 0.932 | 500 | Pass |

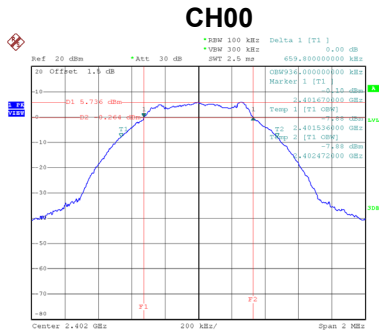

Date: 2.DEC.2019 14:16:34

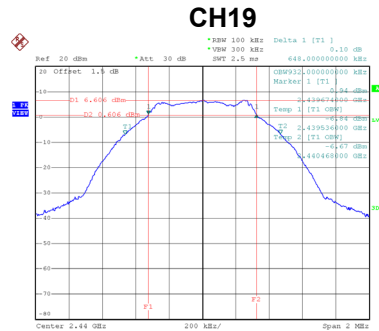

Date: 2.DEC.2019 14:18:44

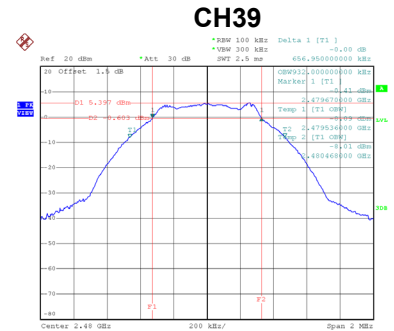

Date: 2.DEC.2019 14:20:45

Test Mode: CH00, CH19, CH39 - 2Mbps

| Channel | Frequency (MHz) | 6 dB Bandwidth (MHz) | 99 % Emission Bandwidth (MHz) | 6 dB Bandwidth Min. Limit (kHz) | Test Result |
|---------|-----------------|----------------------|-------------------------------|---------------------------------|-------------|
| 00 | 2402 | 1.142 | 1.864 | 500 | Pass |
| 19 | 2440 | 1.158 | 1.880 | 500 | Pass |
| 39 | 2480 | 1.150 | 1.864 | 500 | Pass |

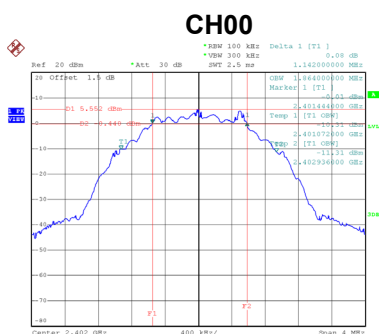

Date: 2.DEC.2019 14:23:44

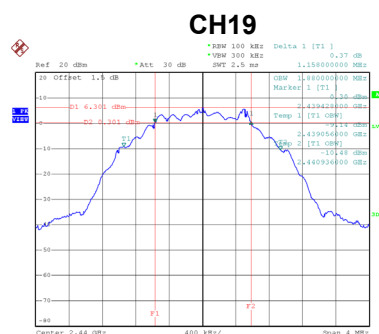

Date: 2.DEC.2019 14:26:45

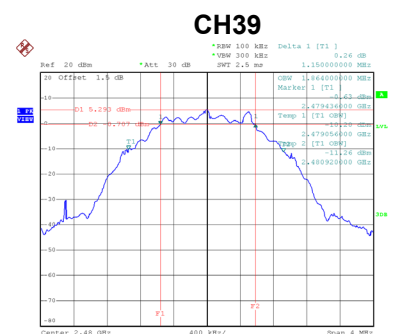

Date: 2.DEC.2019 14:28:47

APPENDIX F - MAXIMUM OUTPUT POWER

| | |
|-------------|---------------------------|
| Test Mode : | CH00, CH19 , CH39 - 1Mbps |
|-------------|---------------------------|

| Frequency (MHz) | Output Power (dBm) | Output Power (W) | Max. Limit (dBm) | Max. Limit (W) | Test Result |
|-----------------|--------------------|------------------|------------------|----------------|-------------|
| 2402 | 6.17 | 0.0041 | 30.00 | 1.00 | Pass |
| 2440 | 7.06 | 0.0051 | 30.00 | 1.00 | Pass |
| 2480 | 5.86 | 0.0039 | 30.00 | 1.00 | Pass |

| | |
|-------------|---------------------------|
| Test Mode : | CH00, CH19 , CH39 - 2Mbps |
|-------------|---------------------------|

| Frequency (MHz) | Output Power (dBm) | Output Power (W) | Max. Limit (dBm) | Max. Limit (W) | Test Result |
|-----------------|--------------------|------------------|------------------|----------------|-------------|
| 2402 | 6.15 | 0.0041 | 30.00 | 1.00 | Pass |
| 2440 | 7.05 | 0.0051 | 30.00 | 1.00 | Pass |
| 2480 | 5.83 | 0.0038 | 30.00 | 1.00 | Pass |

APPENDIX G - CONDUCTED SPURIOUS EMISSION

Test Mode : CH00, CH19 , CH39 - 1Mbps

Bandedge- CH00 (Lower)

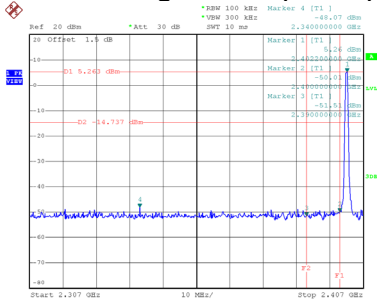

Date: 2.DEC.2019 14:16:43

Bandedge CH39 (Upper)

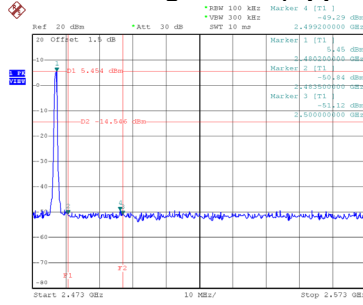

Date: 2.DEC.2019 14:20:54

CH00 – 10th Harmonic of the fundamental frequency

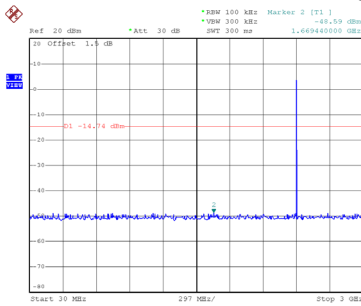

Date: 2.DEC.2019 14:16:57

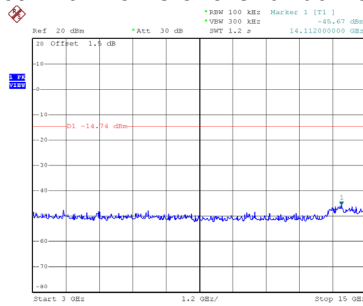

Date: 2.DEC.2019 14:17:05

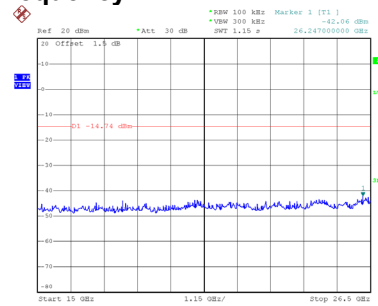

Date: 2.DEC.2019 14:17:14

CH19 – 10th Harmonic of the fundamental frequency

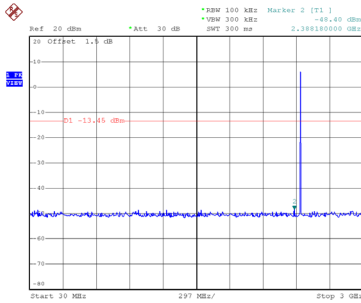

Date: 2.DEC.2019 14:19:06

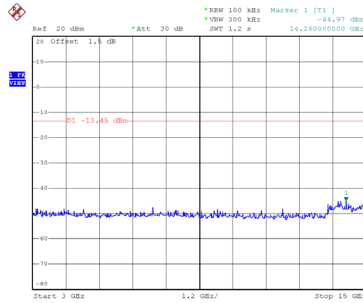

Date: 2.DEC.2019 14:19:14

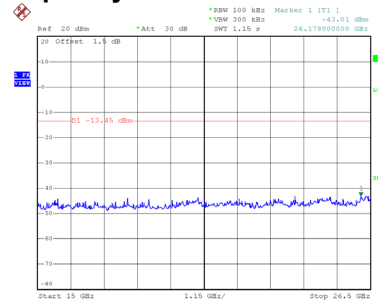

Date: 2.DEC.2019 14:19:23

CH39 – 10th Harmonic of the fundamental frequency

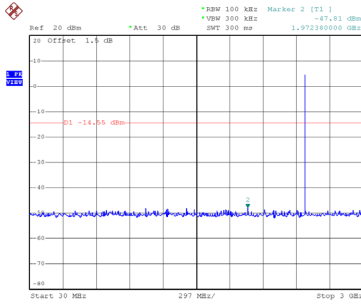

Date: 2.DEC.2019 14:21:08

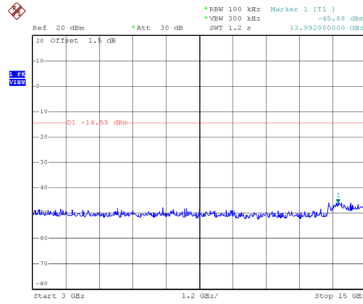

Date: 2.DEC.2019 14:21:17

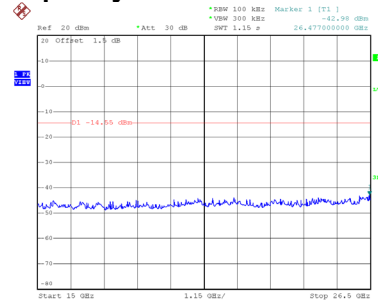

Date: 2.DEC.2019 14:21:25

Test Mode : CH00, CH19 , CH39 - 2Mbps

Bandedge- CH00 (Lower)

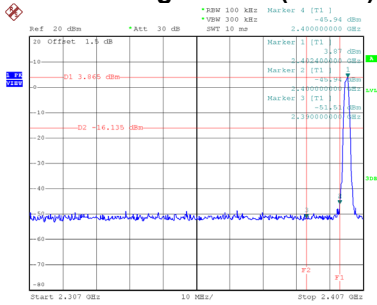

Date: 2.DEC.2019 14:24:10

Bandedge CH39 (Upper)

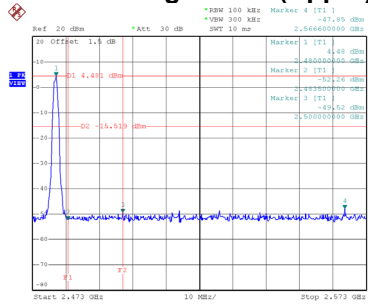

Date: 2.DEC.2019 14:29:13

CH00 – 10th Harmonic of the fundamental frequency

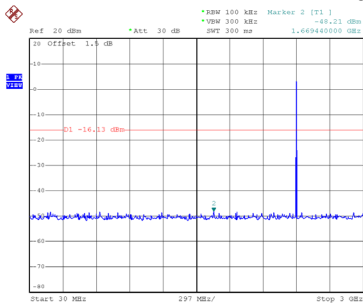

Date: 2.DEC.2019 14:24:24

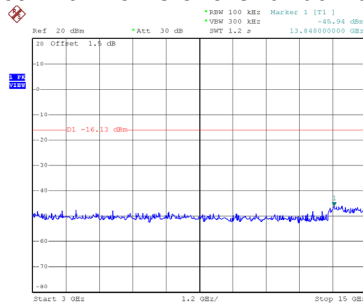

Date: 2.DEC.2019 14:24:33

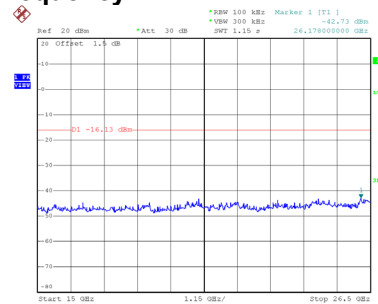

Date: 2.DEC.2019 14:24:41

CH19 – 10th Harmonic of the fundamental frequency

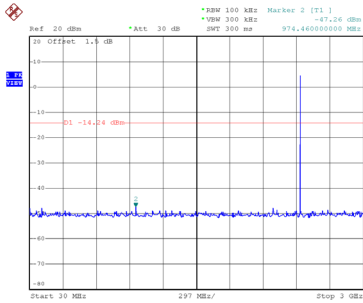

Date: 2.DEC.2019 14:27:25

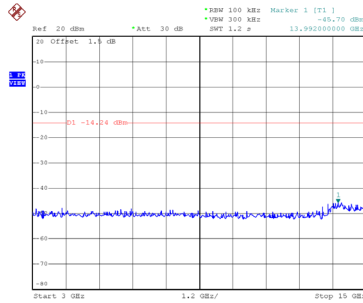

Date: 2.DEC.2019 14:27:33

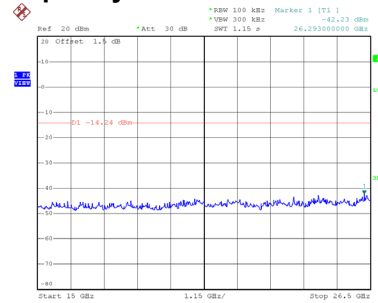

Date: 2.DEC.2019 14:27:42

CH39 – 10th Harmonic of the fundamental frequency

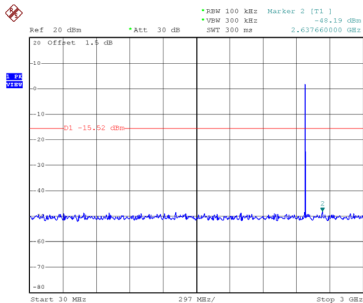

Date: 2.DEC.2019 14:29:26

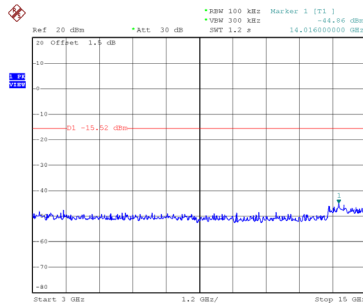

Date: 2.DEC.2019 14:29:35

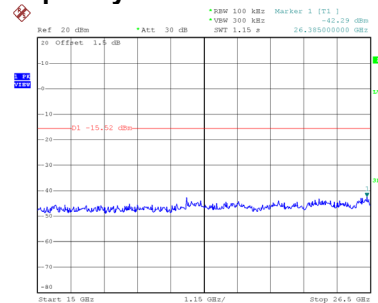

Date: 2.DEC.2019 14:29:43

APPENDIX H - POWER SPECTRAL DENSITY

Test Mode: CH00, CH19 , CH39 - 1Mbps

| Channel | Frequency (MHz) | Power Spectral Density (dBm/3 kHz) | Max. Limit (dBm/3 kHz) | Test Result |
|---------|-----------------|------------------------------------|------------------------|-------------|
| 00 | 2402 | -9.94 | 8.00 | Pass |
| 19 | 2440 | -9.02 | 8.00 | Pass |
| 39 | 2480 | -10.90 | 8.00 | Pass |

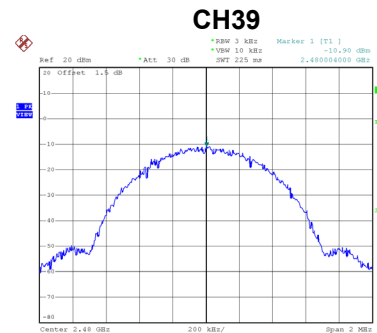
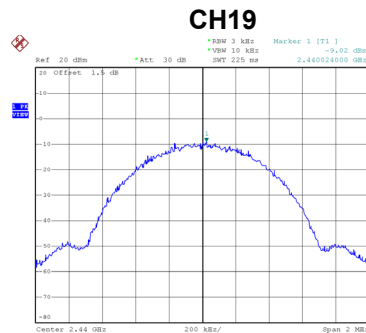
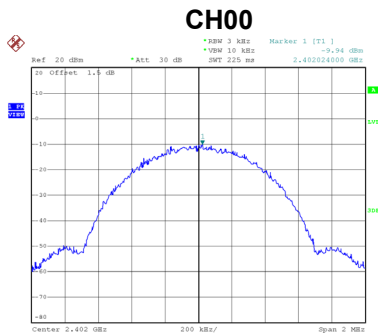

Test Mode: CH00, CH19 , CH39 - 2Mbps

| Channel | Frequency (MHz) | Power Spectral Density (dBm/3 kHz) | Max. Limit (dBm/3 kHz) | Test Result |
|---------|-----------------|------------------------------------|------------------------|-------------|
| 00 | 2402 | -12.20 | 8.00 | Pass |
| 19 | 2440 | -11.36 | 8.00 | Pass |
| 39 | 2480 | -12.78 | 8.00 | Pass |

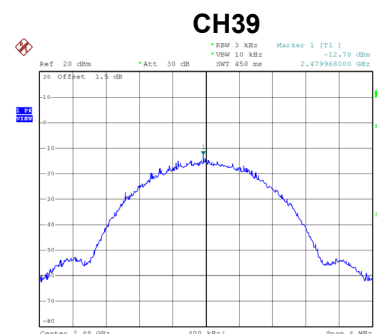
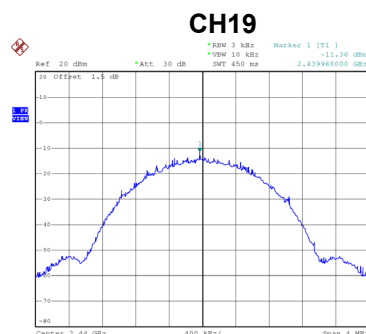
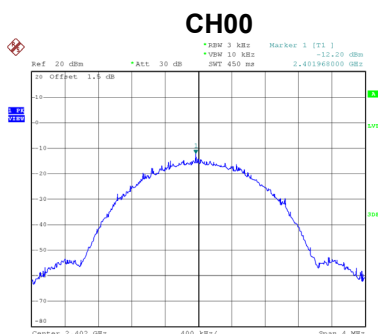

End of Test Report