



FCC TEST REPORT

Application No: ZR/2019/C0026
Applicant: GUANGDONG OPPO MOBILE TELECOMMUNICATIONS CORP.,LTD.
Address of Applicant: NO. 18 HaiBin Road, WuSha village, Chang An Town, DongGuan City, Guangdong,China
Manufacturer: GUANGDONG OPPO MOBILE TELECOMMUNICATIONS CORP.,LTD.
Address of Manufacturer: NO. 18 HaiBin Road, WuSha village, Chang An Town, DongGuan City, Guangdong,China
EUT Description: MOBILE PHONE
Model No.: CPH2009
Trade Mark: OPPO
FCC ID: R9C-CPH2009
Standards: 47 CFR Part 2
 47 CFR Part 22 subpart H
 47 CFR Part 24 subpart E
 47 CFR Part 27 subpart C
 47 CFR Part 90 subpart S
Test Method: FCC KDB 971168 D01 Power Meas License Digital Systems V03r01 C63.26 (2015)
Date of Receipt: 2019/12/23
Date of Test: 2019/12/23 to 2020/2/29
Date of Issue: 2020/2/29

Test Result:	PASS *
---------------------	---------------

* In the configuration tested, the EUT detailed in this report complied with the standards specified above.

Authorized Signature:

Derek Yang

Wireless Laboratory Manager



Unless otherwise agreed in writing, this document is issued by the Company subject to its General Conditions of Service printed overleaf, available on request or accessible at <http://www.sgs.com/en/Terms-and-Conditions.aspx> and, for electronic format documents, subject to Terms and Conditions for Electronic Documents at <http://www.sgs.com/en/terms-and-conditions/Terms-e-Documents.aspx>. Attention is drawn to the limitation of liability, indemnification and jurisdiction issues defined therein. Any holder of this document is advised that information contained hereon reflects the Company's findings at the time of its intervention only and within the limits of Client's instructions, if any. The Company's sole responsibility is to its Client and this document does not exonerate parties to a transaction from exercising all their rights and obligations under the transaction documents. This document cannot be reproduced except in full, without prior written approval of the Company. Any unauthorized alteration, forgery or falsification of the content or appearance of this document is unlawful and offenders may be prosecuted to the fullest extent of the law. Unless otherwise stated the results shown in this test report refer only to the sample(s) tested and such sample(s) are retained for 30 days only.
 Attention: To check the authenticity of testing /inspection report & certificate, please contact us at telephone: (86-755) 8307 1443, or email: CN.Doccheck@sgs.com



1 Version

Revision Record				
Version	Chapter	Date	Modifier	Remark
00		2020/2/29		Original

Authorized for issue by:			
Tested By		 <hr/> (Mike Hu) /Project Engineer	2020/2/29
			Date
Checked By		 <hr/> (David Chen) /Reviewer	2020/2/29
			Date



Unless otherwise agreed in writing, this document is issued by the Company subject to its General Conditions of Service printed overleaf, available on request or accessible at <http://www.sgs.com/en/Terms-and-Conditions.aspx> and, for electronic format documents, subject to Terms and Conditions for Electronic Documents at <http://www.sgs.com/en/terms-and-conditions/terms-e-document.aspx>. Attention is drawn to the limitation of liability, indemnification and jurisdiction issues defined therein. Any holder of this document is advised that information contained hereon reflects the Company's findings at the time of its intervention only and within the limits of Client's instructions, if any. The Company's sole responsibility is to its Client and this document does not exonerate parties to a transaction from exercising all their rights and obligations under the transaction documents. This document cannot be reproduced except in full, without prior written approval of the Company. Any unauthorized alteration, forgery or falsification of the content or appearance of this document is unlawful and offenders may be prosecuted to the fullest extent of the law. Unless otherwise stated the results shown in this test report refer only to the sample(s) tested and such sample(s) are retained for 30 days only.
Attention: To check the authenticity of testing /inspection report & certificate, please contact us at telephone: (86-755) 8307 1443, or email: CN.Doccheck@sgs.com



Content

1	VERSION	2
2	TEST SUMMARY	5
2.1	GSM850/UMTS BAND 5 & LTE BAND 5 / 26.....	5
2.2	GSM 1900/UMTS BAND 2 /LTE BAND 2.....	5
2.3	UMTS BAND 4 /LTE BAND 4/66.....	6
2.4	LTE BAND 7/38/41/ CA_7C/ CA_38C/ CA_41C.....	6
2.5	LTE BAND 12/17.....	7
2.6	LTE BAND 26.....	8
3	GENERAL INFORMATION	9
3.1	CLIENT INFORMATION.....	9
3.2	TEST LOCATION.....	9
3.3	TEST FACILITY.....	9
3.4	GENERAL DESCRIPTION OF EUT.....	10
3.5	TEST MODE.....	10
3.6	TEST ENVIRONMENT.....	11
3.7	TECHNICAL SPECIFICATION.....	11
3.8	TEST FREQUENCIES.....	14
4	DESCRIPTION OF TESTS	21
4.1	CONDUCTED OUTPUT POWER.....	21
4.2	EFFECTIVE (ISOTROPIC) RADIATED POWER OF TRANSMITTER.....	21
4.3	OCCUPIED BANDWIDTH.....	21
4.4	BAND EDGE AT ANTENNA TERMINALS.....	22
4.5	SPURIOUS AND HARMONIC EMISSIONS AT ANTENNA TERMINAL.....	23
4.6	PEAK-AVERAGE RATIO.....	23
4.7	FIELD STRENGTH OF SPURIOUS RADIATION.....	24
4.8	FREQUENCY STABILITY / TEMPERATURE VARIATION.....	25
4.9	TEST SETUPS.....	26
4.9.1	Test Setup 1.....	26
4.9.2	Test Setup 2.....	26
4.9.3	Test Setup 3.....	27



Unless otherwise agreed in writing, this document is issued by the Company subject to its General Conditions of Service printed overleaf, available on request or accessible at <http://www.sgs.com/en/Terms-and-Conditions.aspx> and, for electronic format documents, subject to Terms and Conditions for Electronic Documents at <http://www.sgs.com/en/terms-and-conditions/Terms-e-Document.aspx>. Attention is drawn to the limitation of liability, indemnification and jurisdiction issues defined therein. Any holder of this document is advised that information contained hereon reflects the Company's findings at the time of its intervention only and within the limits of Client's instructions, if any. The Company's sole responsibility is to its Client and this document does not exonerate parties to a transaction from exercising all their rights and obligations under the transaction documents. This document cannot be reproduced except in full, without prior written approval of the Company. Any unauthorized alteration, forgery or falsification of the content or appearance of this document is unlawful and offenders may be prosecuted to the fullest extent of the law. Unless otherwise stated the results shown in this test report refer only to the sample(s) tested and such sample(s) are retained for 30 days only.

Attention: To check the authenticity of testing /inspection report & certificate, please contact us at telephone: (86-755) 8307 1443, or email: CN.Doccheck@sgs.com



4.9.4 Test Setup 4.....27

4.10 TEST CONDITIONS28

5 MAIN TEST INSTRUMENTS30

6 MEASUREMENT UNCERTAINTY32

7 APPENDIXES.....32



Unless otherwise agreed in writing, this document is issued by the Company subject to its General Conditions of Service printed overleaf, available on request or accessible at <http://www.sgs.com/en/Terms-and-Conditions.aspx> and, for electronic format documents, subject to Terms and Conditions for Electronic Documents at <http://www.sgs.com/en/terms-and-conditions/terms-e-document.aspx>. Attention is drawn to the limitation of liability, indemnification and jurisdiction issues defined therein. Any holder of this document is advised that information contained hereon reflects the Company's findings at the time of its intervention only and within the limits of Client's instructions, if any. The Company's sole responsibility is to its Client and this document does not exonerate parties to a transaction from exercising all their rights and obligations under the transaction documents. This document cannot be reproduced except in full, without prior written approval of the Company. Any unauthorized alteration, forgery or falsification of the content or appearance of this document is unlawful and offenders may be prosecuted to the fullest extent of the law. Unless otherwise stated the results shown in this test report refer only to the sample(s) tested and such sample(s) are retained for 30 days only.

Attention: To check the authenticity of testing /inspection report & certificate, please contact us at telephone: (86-755) 8307 1443, or email: CN.Doccheck@sgs.com



2 Test Summary

2.1 GSM850/UMTS Band 5 & LTE Band 5 / 26

Test Item	FCC Rule No.	Requirements	Test Result	Verdict
Effective (Isotropic) Radiated Power Output Data	§2.1046, §22.913	FCC: ERP ≤ 7 W	Section 1 of Appendix B	Pass
Peak-Average Ratio	---	Limit ≤ 13 dB	Section 2 of Appendix B	Pass
Modulation Characteristics	§2.1047	Digital modulation	Section 3 of Appendix B	Pass
Bandwidth	§2.1049	OBW: No limit. EBW: No limit.	Section 4 of Appendix B	Pass
Band Edges Compliance	§2.1051, §22.917	≤ -13 dBm/1%*EBW, in 1 MHz bands immediately outside and adjacent to the frequency block.	Section 5 of Appendix B	Pass
Spurious Emission at Antenna Terminals	§2.1051, §22.917	FCC: ≤ -13 dBm/100 kHz, from 9 kHz to 10th harmonics but outside authorized operating frequency ranges.	Section 6 of Appendix B	Pass
Field Strength of Spurious Radiation	§2.1053, §22.917	FCC: ≤ -13 dBm/100 kHz.	Section 7 of Appendix B	Pass
Frequency Stability	§2.1055, §22.355	≤ ±2.5ppm.	Section 8 of Appendix B	Pass

Remark: For the verdict, the "N/A" denotes "not applicable", the "N/T" denotes "not tested".

2.2 GSM 1900/UMTS Band 2 /LTE Band 2

Test Item	FCC Rule No.	Requirements	Test Result	Verdict
Effective (Isotropic) Radiated Power Output Data	§2.1046, §24.232	EIRP ≤ 2 W	Section 1 of Appendix B	Pass
Peak-Average Ratio	§2.1046, §24.232	Limit ≤ 13 dB	Section 2 of Appendix B	Pass
Modulation Characteristics	§2.1047	Digital modulation	Section 3 of Appendix B	Pass
Bandwidth	§2.1049	OBW: No limit. EBW: No limit.	Section 4 of Appendix B	Pass
Band Edges Compliance	§2.1051, §24.238	≤ -13 dBm/1%*EBW, in 1 MHz bands immediately outside and adjacent to the frequency block.	Section 5 of Appendix B	Pass
Spurious Emission at Antenna Terminals	§2.1051, §24.238	≤ -13 dBm/1 MHz, from 9 kHz to 10 th harmonics but outside authorized operating frequency ranges.	Section 6 of Appendix B	Pass
Field Strength of Spurious Radiation	§2.1053, §24.238	≤ -13 dBm/1 MHz.	Section 7 of Appendix B	Pass
Frequency Stability	§2.1055, §24.235	≤ ±2.5 ppm.	Section 8 of Appendix B	Pass



Unless otherwise agreed in writing, this document is issued by the Company subject to its General Conditions of Service printed overleaf, available on request or accessible at <http://www.sgs.com/en/Terms-and-Conditions.aspx> and, for electronic format documents, subject to Terms and Conditions for Electronic Documents at <http://www.sgs.com/en/Terms-and-Conditions/Terms-e-Documents.aspx>. Attention is drawn to the limitation of liability, indemnification and jurisdiction issues defined therein. Any holder of this document is advised that information contained hereon reflects the Company's findings at the time of its intervention only and within the limits of Client's instructions, if any. The Company's sole responsibility is to its Client and this document does not exonerate parties to a transaction from exercising all their rights and obligations under the transaction documents. This document cannot be reproduced except in full, without prior written approval of the Company. Any unauthorized alteration, forgery or falsification of the content or appearance of this document is unlawful and offenders may be prosecuted to the fullest extent of the law. Unless otherwise stated the results shown in this test report refer only to the sample(s) tested and such sample(s) are retained for 30 days only.
Attention: To check the authenticity of testing/inspection report & certificate, please contact us at telephone: (86-755) 8307 1443, or email: CN.Doccheck@sgs.com



Test Item	FCC Rule No.	Requirements	Test Result	Verdict
Remark: For the verdict, the "N/A" denotes "not applicable", the "N/T" denotes "not tested".				

2.3 UMTS Band 4 /LTE Band 4/66

Test Item	FCC Rule No.	Requirements	Test Result	Verdict
Effective (Isotropic) Radiated Power Output Data	§2.1046, §27.50(d)	EIRP ≤ 1 W	Section 1 of Appendix B	Pass
Peak-Average Ratio	§2.1046, §27.50(d)	Limit≤13 dB	Section 2 of Appendix B	Pass
Modulation Characteristics	§2.1047	Digital modulation	Section 3 of Appendix B	Pass
Bandwidth	§2.1049	OBW: No limit. EBW: No limit.	Section 4 of Appendix B	Pass
Band Edges Compliance	§2.1051, §27.53(h)	≤ -13 dBm/1%*EBW, in 1 MHz bands immediately outside and adjacent to the frequency block.	Section 5 of Appendix B	Pass
Spurious Emission at Antenna Terminals	§2.1051, §27.53(h)	≤ -13 dBm/1 MHz, from 9 kHz to 10 th harmonics but outside authorized operating frequency ranges.	Section 6 of Appendix B	Pass
Field Strength of Spurious Radiation	§2.1053, §27.53(h)	≤ -13 dBm/1 MHz.	Section 7 of Appendix B	Pass
Frequency Stability	§2.1055, §27.54	≤ ±2.5 ppm.	Section 8 of Appendix B	Pass

Remark: For the verdict, the "N/A" denotes "not applicable", the "N/T" denotes "not tested".

2.4 LTE Band 7/38/41/ CA_7C/ CA_38C/ CA_41C

Test Item	FCC Rule No.	Requirements	Test Result	Verdict
Effective (Isotropic) Radiated Power Output Data	§2.1046, §27.50(h)	EIRP ≤ 2W	Section 1 of Appendix B	Pass
Peak-Average Ratio	§27.50(a)	≤13 dB	Section 2 of Appendix B	Pass
Modulation Characteristics	§2.1047	Digital modulation	Section 3 of Appendix B	Pass
Bandwidth	§2.1049	OBW: No limit. EBW: No limit.	Section 4 of Appendix B	Pass
Band Edges Compliance	§2.1051, §27.53(m4)	For mobile digital stations, the attenuation factor shall be not less than 40 + 10 log (P) dB on all frequencies between the channel edge and 5 megahertz from the channel edge, 43 + 10 log (P) dB on all frequencies between 5 megahertz and X megahertz from the channel edge, and 55 + 10 log (P) dB on all frequencies more than X megahertz from the channel edge, where X is the greater of 6 megahertz	Section 5 of Appendix B	Pass



Unless otherwise agreed in writing, this document is issued by the Company subject to its General Conditions of Service printed overleaf, available on request or accessible at <http://www.sgs.com/en/Terms-and-Conditions.aspx> and, for electronic format documents, subject to Terms and Conditions for Electronic Documents at <http://www.sgs.com/en/Terms-and-Conditions/Terms-e-Documents.aspx>. Attention is drawn to the limitation of liability, indemnification and jurisdiction issues defined therein. Any holder of this document is advised that information contained hereon reflects the Company's findings at the time of its intervention only and within the limits of Client's instructions, if any. The Company's sole responsibility is to its Client and this document does not exonerate parties to a transaction from exercising all their rights and obligations under the transaction documents. This document cannot be reproduced except in full, without prior written approval of the Company. Any unauthorized alteration, forgery or falsification of the content or appearance of this document is unlawful and offenders may be prosecuted to the fullest extent of the law. Unless otherwise stated the results shown in this test report refer only to the sample(s) tested and such sample(s) are retained for 30 days only.
Attention: To check the authenticity of testing /inspection report & certificate, please contact us at telephone: (86-755) 8307 1443, or email: CN.Doccheck@sgs.com

SGS-CSTC Standards Technical Services Co., Ltd.
Shenzhen Branch

No.1 Workshop, M-10, Middle Section, Science & Technology Park, Shenzhen, China 518057 t (86-755) 26012053 f (86-755) 26710594 www.sgs.com.cn
中国·深圳·科技园中区M-10栋一号厂房 邮编: 518057 t (86-755) 26012053 f (86-755) 26710594 sgs.china@sgs.com



Test Item	FCC Rule No.	Requirements	Test Result	Verdict
		or the actual emission bandwidth as defined in paragraph (m)(6) of this section.		
Spurious Emission at Antenna Terminals	§2.1051, §27.53(m)	<p>Channel Edge -25 dBm/ 1 MHz -25 dBm/ 1 MHz 9 kHz 9.5 MHz X MHz 10th harmonics X=Max {6MHz, EBW}</p>	Section 6 of Appendix B	Pass
Field Strength of Spurious Radiation	§2.1053, §27.53(m)	<p>Channel Edge -25 dBm/ 1 MHz -25 dBm/ 1 MHz 9 kHz 9.5 MHz X MHz 10th harmonics X=Max {6MHz, EBW}</p>	Section 7 of Appendix B	Pass
Frequency Stability	§2.1055, §27.54	Within authorized bands of operation/frequency block.	Section 8 of Appendix B	Pass
Remark: For the verdict, the "N/A" denotes "not applicable", the "N/T" denotes "not tested".				

2.5 LTE Band 12/17

Test Item	FCC Rule No	Requirements	Test Result	Verdict
Effective (Isotropic) Radiated Power Output Data	§27.50(c)	FCC: ERP ≤ 3 W.	Section 1 of Appendix B	Pass
Peak-Average Ratio	§2.1046, §27.50(c)	Limit ≤ 13 dB	Section 2 of Appendix B	Pass
Modulation Characteristics	§2.1047	Digital modulation	Section 3 of Appendix B	Pass
Bandwidth	§2.1049	OBW: No limit. EBW: No limit.	Section 4 of Appendix B	Pass
Band Edges Compliance	§2.1051, §27.53(g)	≤ -13 dBm/1%*EBW, in 1 MHz bands immediately outside and adjacent to the frequency block.	Section 5 of Appendix B	Pass
Spurious Emission at Antenna Terminals	§2.1051, §27.53(g)	FCC: ≤ -13 dBm/100 kHz, from 9 kHz to 10 th harmonics but outside authorized operating frequency ranges.	Section 6 of Appendix B	Pass
Field Strength of Spurious Radiation	§2.1053, §27.53(g)	FCC: ≤ -13 dBm/100 kHz.	Section 7 of Appendix B	Pass
Frequency Stability	§2.1055, §27.54	≤ ±2.5ppm.	Section 8 of Appendix B	Pass
Remark: For the verdict, the "N/A" denotes "not applicable", the "N/T" denotes "not tested".				



Unless otherwise agreed in writing, this document is issued by the Company subject to its General Conditions of Service printed overleaf, available on request or accessible at <http://www.sgs.com/en/Terms-and-Conditions.aspx> and, for electronic format documents, subject to Terms and Conditions for Electronic Documents at <http://www.sgs.com/en/Terms-and-Conditions/Terms-e-Documents.aspx>. Attention is drawn to the limitation of liability, indemnification and jurisdiction issues defined therein. Any holder of this document is advised that information contained hereon reflects the Company's findings at the time of its intervention only and within the limits of Client's instructions, if any. The Company's sole responsibility is to its Client and this document does not exonerate parties to a transaction from exercising all their rights and obligations under the transaction documents. This document cannot be reproduced except in full, without prior written approval of the Company. Any unauthorized alteration, forgery or falsification of the content or appearance of this document is unlawful and offenders may be prosecuted to the fullest extent of the law. Unless otherwise stated the results shown in this test report refer only to the sample(s) tested and such sample(s) are retained for 30 days only.

Attention: To check the authenticity of testing/inspection report & certificate, please contact us at telephone: (86-755) 8307 1443, or email: CN.Doccheck@sgs.com

No.1 Workshop, M-10, Middle Section, Science & Technology Park, Shenzhen, China 518057 t (86-755) 26012053 f (86-755) 26710594 www.sgs.com.cn
中国·深圳·科技园中区M-10栋一号厂房 邮编: 518057 t (86-755) 26012053 f (86-755) 26710594 sgs.china@sgs.com



2.6 LTE Band 26

Test Item	FCC Rule No.	Requirements	Test Result	Verdict
Transmitter Conducted Power Output	§2.1046, §90.635	< 100 W.	Section 1 of Appendix B	PASS
Peak-Average Ratio	---	FCC: Limit≤13 dB	Section 2 of Appendix B	N/T
Modulation Characteristics	§2.1047	Digital modulation	Section 3 of Appendix B	PASS
Bandwidth	§2.1049	OBW: No limit. EBW: No limit.	Section 4 of Appendix B	PASS
Emission Mask	§2.1051 § 90.691	For any frequency removed from the EA licensee's frequency block by up to and including 37.5 kHz, the power of any emission shall be attenuated below the transmitter power (P) in watts by at least 116 Log ₁₀ (f/6.1) decibels or 50+10Log ₁₀ (P) decibels or 80 decibels, whichever is the lesser attenuation, where f is the frequency removed from the center of the outer channel in the block in kilohertz and where f is greater than 12.5 kHz.	Section 5 of Appendix B	PASS
Spurious Emission at Antenna Terminals	§2.1051, §90.691	< 43 + 10Log ₁₀ (P[Watts]) for all out-of-band emissions	Section 6 of Appendix B	PASS
Field Strength of Spurious Radiation	§2.1053, §90.691	< 43 + 10Log ₁₀ (P[Watts]) for all out-of-band emissions	Section 7 of Appendix B	PASS
Frequency Stability	§2.1055, §90.213	< ±2.5ppm.	Section 8 of Appendix B	PASS

Remark: For the verdict, the "N/A" denotes "not applicable", the "N/T" denotes "not tested".



Unless otherwise agreed in writing, this document is issued by the Company subject to its General Conditions of Service printed overleaf, available on request or accessible at <http://www.sgs.com/en/Terms-and-Conditions.aspx> and, for electronic format documents, subject to Terms and Conditions for Electronic Documents at <http://www.sgs.com/en/terms-and-conditions/terms-e-document.aspx>. Attention is drawn to the limitation of liability, indemnification and jurisdiction issues defined therein. Any holder of this document is advised that information contained hereon reflects the Company's findings at the time of its intervention only and within the limits of Client's instructions, if any. The Company's sole responsibility is to its Client and this document does not exonerate parties to a transaction from exercising all their rights and obligations under the transaction documents. This document cannot be reproduced except in full, without prior written approval of the Company. Any unauthorized alteration, forgery or falsification of the content or appearance of this document is unlawful and offenders may be prosecuted to the fullest extent of the law. Unless otherwise stated the results shown in this test report refer only to the sample(s) tested and such sample(s) are retained for 30 days only.
Attention: To check the authenticity of testing /inspection report & certificate, please contact us at telephone: (86-755) 8307 1443, or email: CN.Doccheck@sgs.com



3 General Information

3.1 Client Information

Applicant:	GUANGDONG OPPO MOBILE TELECOMMUNICATIONS CORP.,LTD.
Address of Applicant:	NO. 18 HaiBin Road, WuSha village, Chang An Town, DongGuan City, Guangdong,China
Manufacturer:	GUANGDONG OPPO MOBILE TELECOMMUNICATIONS CORP.,LTD.
Address of Manufacturer:	NO. 18 HaiBin Road, WuSha village, Chang An Town, DongGuan City, Guangdong,China

3.2 Test Location

Company:	SGS-CSTC Standards Technical Services Co., Ltd. Shenzhen Branch
Address:	No. 1 Workshop, M-10, Middle section, Science & Technology Park, Shenzhen, Guangdong, China
Post code:	518057
Telephone:	+86 (0) 755 2601 2053
Fax:	+86 (0) 755 2671 0594
E-mail:	ee.shenzhen@sgs.com

3.3 Test Facility

The test facility is recognized, certified, or accredited by the following organizations:

• **CNAS (No. CNAS L2929)**

CNAS has accredited SGS-CSTC Standards Technical Services Co., Ltd. Shenzhen Branch EMC Lab to ISO/IEC 17025:2005 General Requirements for the Competence of Testing and Calibration Laboratories (CNAS-CL01 Accreditation Criteria for the Competence of Testing and Calibration Laboratories) for the competence in the field of testing.

• **A2LA (Certificate No. 3816.01)**

SGS-CSTC Standards Technical Services Co., Ltd., Shenzhen EMC Laboratory is accredited by the American Association for Laboratory Accreditation(A2LA). Certificate No. 3816.01.

• **VCCI**

The 3m Fully-anechoic chamber for above 1GHz, 10m Semi-anechoic chamber for below 1GHz, Shielded Room for Mains Port Conducted Interference Measurement and Telecommunication Port Conducted Interference Measurement of SGS-CSTC Standards Technical Services Co., Ltd. have been registered in accordance with the Regulations for Voluntary Control Measures with Registration No.: G-20026, R-14188, C-12383 and T-11153 respectively.

• **FCC –Designation Number: CN1178**

SGS-CSTC Standards Technical Services Co., Ltd., Shenzhen EMC Laboratory has been recognized as an accredited testing laboratory.

Designation Number: CN1178. Test Firm Registration Number: 406779.

• **Industry Canada (IC)**

Two 3m Semi-anechoic chambers and the 10m Semi-anechoic chamber of SGS-CSTC Standards Technical Services Co., Ltd. Shenzhen Branch EMC Lab have been registered by Certification and Engineering Bureau of Industry Canada for radio equipment testing with Registration No.: 4620C-1, 4620C-2, 4620C-3.



Unless otherwise agreed in writing, this document is issued by the Company subject to its General Conditions of Service printed overleaf, available on request or accessible at <http://www.sgs.com/en/Terms-and-Conditions.aspx> and, for electronic format documents, subject to Terms and Conditions for Electronic Documents at <http://www.sgs.com/en/Terms-and-Conditions/Terms-e-Documents.aspx>. Attention is drawn to the limitation of liability, indemnification and jurisdiction issues defined therein. Any holder of this document is advised that information contained hereon reflects the Company's findings at the time of its intervention only and within the limits of Client's instructions, if any. The Company's sole responsibility is to its Client and this document does not exonerate parties to a transaction from exercising all their rights and obligations under the transaction documents. This document cannot be reproduced except in full, without prior written approval of the Company. Any unauthorized alteration, forgery or falsification of the content or appearance of this document is unlawful and offenders may be prosecuted to the fullest extent of the law. Unless otherwise stated the results shown in this test report refer only to the sample(s) tested and such sample(s) are retained for 30 days only.
Attention: To check the authenticity of testing /inspection report & certificate, please contact us at telephone: (86-755) 8307 1443, or email: CN.Doccheck@sgs.com



3.4 General Description of EUT

EUT Description:	MOBILE PHONE
Model No.:	CPH2009
Trade Mark:	OPPO
Hardware Version:	11
Software Version:	ColorOS V7
Sample Type:	<input checked="" type="checkbox"/> Portable Device, <input type="checkbox"/> Module
Antenna Type:	<input type="checkbox"/> External, <input checked="" type="checkbox"/> Integrated
Antenna Gain:	GSM850: -7.0dBi (Ant0); -3.4dBi (Ant1); GSM1900: -1.6dBi (Ant2); -2.0dBi (Ant3); WCDMA Band II: -1.6dBi (Ant2); -2.0dBi (Ant3); WCDMA Band IV: -2.4dBi (Ant2); -2.5dBi (Ant3); WCDMA Band V: -7.0dBi (Ant0); -3.4dBi (Ant1); LTE Band 2: -1.6dBi (Ant2); -2.0dBi (Ant3); LTE Band 4: -2.4dBi (Ant2); -2.5dBi (Ant3); LTE Band 5: -7.0dBi (Ant0); -3.4dBi (Ant1); LTE Band 7: -3.8dBi (Ant0); -0.3dBi (Ant2); -0.1dBi (Ant3); LTE Band 12: -5.6dBi (Ant0); -2.4dBi (Ant1); LTE Band 17: -5.6dBi (Ant0); -2.4dBi (Ant1); LTE Band 26: -7.0dBi (Ant0); -3.4dBi (Ant1); LTE Band 38: -3.8dBi (Ant0); -0.3dBi (Ant2); -0.1dBi (Ant3); LTE Band 41: -3.8dBi (Ant0); -0.3dBi (Ant2); -0.1dBi (Ant3); LTE Band 66: -2.4dBi (Ant2); -2.5dBi (Ant3); LTE CA_7C: -3.8dBi (Ant0); -0.3dBi (Ant2); -0.1dBi (Ant3); LTE CA_38C: -3.8dBi (Ant0); -0.3dBi (Ant2); -0.1dBi (Ant3); LTE CA_41C: -3.8dBi (Ant0); -0.3dBi (Ant2); -0.1dBi (Ant3);

3.5 Test Mode

Test Mode	Test Modes Description
GSM/TM1	GSM system, GSM/GPRS, GMSK modulation
GSM/TM2	GSM system, EGPRS, 8PSK modulation
UMTS/TM1	UMTS system, WCDMA, QPSK modulation
UMTS/TM2	UMTS system, WCDMA, 16QAM modulation
LTE/TM1	LTE system, QPSK modulation
LTE/TM2	LTE system, 16QAM modulation
LTE/TM3	LTE system, 64QAM modulation

Remark: The test mode(s) are selected according to relevant radio technology specifications.



Unless otherwise agreed in writing, this document is issued by the Company subject to its General Conditions of Service printed overleaf, available on request or accessible at <http://www.sgs.com/en/Terms-and-Conditions.aspx> and, for electronic format documents, subject to Terms and Conditions for Electronic Documents at <http://www.sgs.com/en/terms-and-conditions/terms-e-document.aspx>. Attention is drawn to the limitation of liability, indemnification and jurisdiction issues defined therein. Any holder of this document is advised that information contained hereon reflects the Company's findings at the time of its intervention only and within the limits of Client's instructions, if any. The Company's sole responsibility is to its Client and this document does not exonerate parties to a transaction from exercising all their rights and obligations under the transaction documents. This document cannot be reproduced except in full, without prior written approval of the Company. Any unauthorized alteration, forgery or falsification of the content or appearance of this document is unlawful and offenders may be prosecuted to the fullest extent of the law. Unless otherwise stated the results shown in this test report refer only to the sample(s) tested and such sample(s) are retained for 30 days only.
Attention: To check the authenticity of testing/inspection report & certificate, please contact us at telephone: (86-755) 8307 1443, or email: CN.Doccheck@sgs.com

3.6 Test Environment

Environment Parameter	Selected Values During Tests	
Relative Humidity	52%	
Atmospheric Pressure:	101.32 KPa	
Temperature	NT	25 °C
Voltage:	LV	3.6V
	NV	3.87V
	HV	4.45V

Remark: LV= lower extreme test voltage; NV= nominal voltage
HV= upper extreme test voltage; NT= normal temperature

3.7 Technical Specification

Characteristics	Description		
Radio System Type	<input checked="" type="checkbox"/>	GSM	
	<input checked="" type="checkbox"/>	UMTS	
	<input checked="" type="checkbox"/>	LTE	
Supported Frequency Range	Band	TX	RX
	GSM850	824 to 849 MHz	869 to 894 MHz
	GSM1900	1850 to 1910 MHz	1930 to 1990 MHz
	UMTS Band II	1850 to 1910 MHz	1930 to 1990 MHz
	UMTS Band IV	1710 to 1755 MHz	2110 to 2155 MHz
	UMTS Band V	824 to 849 MHz	869 to 894 MHz
	LTE Band 2	1850 to 1910 MHz	1930 to 1990 MHz
	LTE Band 4	1710 to 1755 MHz	2110 to 2155 MHz
	LTE Band 5	824 to 849 MHz	869 to 894 MHz
	LTE Band 7	2500 to 2570 MHz	2620 to 2690 MHz
	LTE Band 12	699 to 716 MHz	729 to 746 MHz
	LTE Band 17	704 to 716 MHz	734 to 746 MHz
	LTE Band 26 (814 to 824 MHz)	814 to 824MHz	859 to 869 MHz
	LTE Band 26 (824 to 849 MHz)	824 to 849 MHz	869 to 894 MHz
	LTE Band 38	2570 to 2620 MHz	2570 to 2620 MHz
	LTE Band 41	2496 to 2690MHz	2496 to 2690MHz
	LTE Band 66	1710 to 1780 MHz	2110 to 2200 MHz
	LTE CA_7C	2500 to 2570 MHz	2620 to 2690 MHz
	LTE CA_38C	2570 to 2620 MHz	2570 to 2620 MHz
LTE CA_41C	2496 to 2690MHz	2496 to 2690MHz	
Target TX Output Power	GSM850:33.2 dBm (Ant0); 34.0dBm (Ant1) GSM1900: 30.5dBm (Ant2); 30.0dBm (Ant3) UMTS Band II: 24.0dBm (Ant2); 23.5dBm (Ant3) UMTS Band IV: 24.2dBm (Ant2); 23.7dBm (Ant3) UMTS Band V: 25.0dBm (Ant0); 25.0dBm (Ant1) LTE Band 2: 23.8dBm (Ant2); 23.0dBm (Ant3) LTE Band 4: 24.0dBm (Ant2); 23.2dBm (Ant3) LTE Band 5: 24.8dBm (Ant0); 25.0dBm (Ant1) LTE Band 7: 23.0dBm (Ant0); 24.0dBm (Ant2); 23.7dBm (Ant3) LTE Band 12: 24.4dBm (Ant0); 24.8dBm (Ant1) LTE Band 17: 24.4dBm (Ant0); 24.8dBm (Ant1)		



Unless otherwise agreed in writing, this document is issued by the Company subject to its General Conditions of Service printed overleaf, available on request or accessible at <http://www.sgs.com/en/Terms-and-Conditions.aspx> and, for electronic format documents, subject to Terms and Conditions for Electronic Documents at <http://www.sgs.com/en/Terms-and-Conditions/Terms-e-Documents.aspx>. Attention is drawn to the limitation of liability, indemnification and jurisdiction issues defined therein. Any holder of this document is advised that information contained hereon reflects the Company's findings at the time of its intervention only and within the limits of Client's instructions, if any. The Company's sole responsibility is to its Client and this document does not exonerate parties to a transaction from exercising all their rights and obligations under the transaction documents. This document cannot be reproduced except in full, without prior written approval of the Company. Any unauthorized alteration, forgery or falsification of the content or appearance of this document is unlawful and offenders may be prosecuted to the fullest extent of the law. Unless otherwise stated the results shown in this test report refer only to the sample(s) tested and such sample(s) are retained for 30 days only.

Attention: To check the authenticity of testing/inspection report & certificate, please contact us at telephone: (86-755) 8307 1443, or email: CN.Doccheck@sgs.com



	LTE Band 26: 24.6dBm (Ant0); 24.8dBm (Ant1) LTE Band 38: 23.0dBm (Ant0); 24.5dBm (Ant2); 23.6dBm (Ant3) LTE Band 41: 24.8dBm (Ant0); 26.0dBm (Ant2); 25.5dBm (Ant3) LTE Band 66: 24.0dBm (Ant2); 23.2dBm (Ant3) LTE CA_7C: 23.0dBm (Ant0); 24.0dBm (Ant2); 23.7dBm (Ant3) LTE CA_38C: 23.0dBm (Ant0); 24.5dBm (Ant2); 23.6dBm (Ant3) LTE CA_41C: 24.8dBm (Ant0); 26.0dBm (Ant2); 25.5dBm (Ant3)	
Supported Channel Bandwidth	GSM system:	<input checked="" type="checkbox"/> 0.2 MHz
	UMTS system:	<input checked="" type="checkbox"/> 5 MHz
	LTE Band 2	<input checked="" type="checkbox"/> 1.4 MHz; <input checked="" type="checkbox"/> 3 MHz; <input checked="" type="checkbox"/> 5 MHz; <input checked="" type="checkbox"/> 10 MHz; <input checked="" type="checkbox"/> 15 MHz; <input checked="" type="checkbox"/> 20 MHz
	LTE Band 4	<input checked="" type="checkbox"/> 1.4 MHz; <input checked="" type="checkbox"/> 3 MHz; <input checked="" type="checkbox"/> 5 MHz; <input checked="" type="checkbox"/> 10 MHz; <input checked="" type="checkbox"/> 15 MHz; <input checked="" type="checkbox"/> 20 MHz
	LTE Band 5	<input checked="" type="checkbox"/> 1.4 MHz; <input checked="" type="checkbox"/> 3 MHz; <input checked="" type="checkbox"/> 5 MHz; <input checked="" type="checkbox"/> 10 MHz
	LTE Band 7	<input checked="" type="checkbox"/> 5 MHz; <input checked="" type="checkbox"/> 10 MHz; <input checked="" type="checkbox"/> 15 MHz; <input checked="" type="checkbox"/> 20 MHz
	LTE Band 12	<input checked="" type="checkbox"/> 1.4 MHz; <input checked="" type="checkbox"/> 3 MHz; <input checked="" type="checkbox"/> 5 MHz; <input checked="" type="checkbox"/> 10 MHz
	LTE Band 17	<input checked="" type="checkbox"/> 5 MHz; <input checked="" type="checkbox"/> 10 MHz
	LTE Band 26(814-824)	<input checked="" type="checkbox"/> 1.4 MHz; <input checked="" type="checkbox"/> 3 MHz; <input checked="" type="checkbox"/> 5 MHz; <input checked="" type="checkbox"/> 10 MHz;
	LTE Band 26(824-849)	<input checked="" type="checkbox"/> 1.4 MHz; <input checked="" type="checkbox"/> 3 MHz; <input checked="" type="checkbox"/> 5 MHz; <input checked="" type="checkbox"/> 10 MHz; <input checked="" type="checkbox"/> 15 MHz
	LTE Band 38	<input checked="" type="checkbox"/> 5 MHz; <input checked="" type="checkbox"/> 10 MHz; <input checked="" type="checkbox"/> 15 MHz; <input checked="" type="checkbox"/> 20 MHz
	LTE Band 41	<input checked="" type="checkbox"/> 5 MHz; <input checked="" type="checkbox"/> 10 MHz; <input checked="" type="checkbox"/> 15 MHz; <input checked="" type="checkbox"/> 20 MHz
	LTE Band 66	<input checked="" type="checkbox"/> 1.4 MHz; <input checked="" type="checkbox"/> 3 MHz; <input checked="" type="checkbox"/> 5 MHz; <input checked="" type="checkbox"/> 10 MHz; <input checked="" type="checkbox"/> 15 MHz; <input checked="" type="checkbox"/> 20 MHz
	LTE CA_7C	<input checked="" type="checkbox"/> 50+100; <input checked="" type="checkbox"/> 75+150; <input checked="" type="checkbox"/> 75+75; <input checked="" type="checkbox"/> 75+100 <input checked="" type="checkbox"/> 100+100
	LTE CA_38C	<input checked="" type="checkbox"/> 75+75; <input checked="" type="checkbox"/> 100+100
LTE CA_41C	<input checked="" type="checkbox"/> 25+100; <input checked="" type="checkbox"/> 50+75; <input checked="" type="checkbox"/> 75+75; <input checked="" type="checkbox"/> 75+100, <input checked="" type="checkbox"/> 100+100	
Characteristics	Description	
Designation of Emissions (Remark: the necessary bandwidth of which is the worst value from the measured occupied bandwidths for each type of channel bandwidth configuration.)	GSM850	249KGXW; 246KG7W
	GSM1900	241KGXW; 243KG7W
	UMTS Band II	4M14F9W;
	UMTS Band IV	4M14F9W;
	UMTS Band V	4M15F9W;
	LTE Band 2 (QPSK/64QAM/16QAM)	1M10G7D; 1M09W7D; 1M09W7D 2M70G7D; 2M70W7D; 2M70W7D 4M49G7D; 4M48W7D; 4M49W7D 8M93G7D; 8M93W7D; 8M93W7D 13M5G7D; 13M5W7D; 13M5W7D 17M9G7D; 17M9W7D; 17M9W7D
	LTE Band 4 (QPSK/64QAM/16QAM)	1M09G7D; 1M09W7D; 1M09W7D 2M70G7D; 2M69W7D; 2M69W7D 4M47G7D; 4M49W7D; 4M48W7D 8M93G7D; 8M93W7D; 8M93W7D 13M5G7D; 13M5W7D; 13M5W7D 17M9G7D; 17M9W7D; 17M9W7D
	LTE Band 5 (QPSK/64QAM/16QAM)	1M09G7D; 1M09W7D; 1M09W7D 2M70G7D; 2M69W7D; 2M69W7D 4M49G7D; 4M48W7D; 4M49W7D 8M95G7D; 8M93W7D; 8M93W7D



Unless otherwise agreed in writing, this document is issued by the Company subject to its General Conditions of Service printed overleaf, available on request or accessible at <http://www.sgs.com/en/Terms-and-Conditions.aspx> and, for electronic format documents, subject to Terms and Conditions for Electronic Documents at <http://www.sgs.com/en/Terms-and-Conditions/Terms-e-Documents.aspx>. Attention is drawn to the limitation of liability, indemnification and jurisdiction issues defined therein. Any holder of this document is advised that information contained hereon reflects the Company's findings at the time of its intervention only and within the limits of Client's instructions, if any. The Company's sole responsibility is to its Client and this document does not exonerate parties to a transaction from exercising all their rights and obligations under the transaction documents. This document cannot be reproduced except in full, without prior written approval of the Company. Any unauthorized alteration, forgery or falsification of the content or appearance of this document is unlawful and offenders may be prosecuted to the fullest extent of the law. Unless otherwise stated the results shown in this test report refer only to the sample(s) tested and such sample(s) are retained for 30 days only.

Attention: To check the authenticity of testing / inspection report & certificate, please contact us at telephone: (86-755) 8307 1443, or email: CN.Doccheck@sgs.com

No.1 Workshop, M-10, Middle Section, Science & Technology Park, Shenzhen, China 518057 t (86-755) 26012053 f (86-755) 26710594 www.sgs.com.cn
 中国·深圳·科技园中区M-10栋一号厂房 邮编: 518057 t (86-755) 26012053 f (86-755) 26710594 sgs.china@sgs.com



LTE Band 7 (QPSK/64QAM/16QAM)	4M49G7D;4M49W7D; 4M49W7D 8M93G7D;8M93W7D; 8M93W7D 13M5G7D;13M5W7D; 13M5W7D 17M9G7D;17M9W7D; 17M9W7D
LTE Band 12 (QPSK/64QAM/16QAM)	1M10G7D;1M09W7D; 1M09W7D 2M70G7D;2M70W7D; 2M70W7D 4M49G7D;4M48W7D; 4M48W7D 8M95G7D;8M93W7D; 8M93W7D
LTE Band 17	4M48G7D;4M49W7D; 4M48W7D 8M93G7D;8M93W7D; 8M93W7D
LTE Band 26 (814-824) (QPSK/64QAM/16QAM)	1M10G7D;1M09W7D; 1M09W7D 5M94G7D;2M70W7D; 2M70W7D 4M49G7D;4M49W7D; 4M49W7D 8M95G7D;8M95W7D; 8M97W7D
LTE Band 26 (824-849) (QPSK/64QAM/16QAM)	1M09G7D;1M09W7D; 1M09W7D 2M70G7D;2M70W7D; 2M70W7D 4M49G7D;4M49W7D; 4M49W7D 8M95G7D;8M95W7D; 8M95W7D 13M5G7D;13M5W7D; 13M5W7D
LTE Band 38 (QPSK/64QAM/16QAM)	4M48G7D;4M48W7D; 4M48W7D 8M95G7D;8M95W7D; 8M93W7D 13M5G7D;13M5W7D; 13M5W7D 17M9G7D;17M9W7D; 17M9W7D
LTE Band 41 (QPSK/64QAM/16QAM)	4M49G7D;4M48W7D; 4M48W7D 8M93G7D;8M95W7D; 8M95W7D 13M5G7D;13M5W7D; 13M5W7D 17M9G7D;17M9W7D; 17M9W7D
LTE Band 66 (QPSK/64QAM/16QAM)	1M09G7D;1M09W7D; 1M09W7D 2M70G7D;2M69W7D; 2M69W7D 4M47G7D;4M47W7D; 4M49W7D 8M93G7D;8M91W7D; 8M91W7D 13M5G7D;13M4W7D; 13M5W7D 17M9G7D;17M9W7D; 17M9W7D
LTE CA_7C (QPSK/16QAM/64QAM)	28M4G7D;28M4W7D; 28M4W7D 37M4G7D;37M4W7D; 37M4W7D
LTE CA_38C (QPSK/16QAM/64QAM)	28M2G7D;28M2W7D; 28M2W7D 37M4G7D;37M4W7D; 37M5W7D
LTE CA_41C (QPSK/16QAM/64QAM)	22M9G7D;22M9W7D; 22M9W7D 37M5G7D;37M5W7D; 37M5W7D



Unless otherwise agreed in writing, this document is issued by the Company subject to its General Conditions of Service printed overleaf, available on request or accessible at <http://www.sgs.com/en/Terms-and-Conditions.aspx> and, for electronic format documents, subject to Terms and Conditions for Electronic Documents at <http://www.sgs.com/en/Terms-and-Conditions/Terms-e-Documents.aspx>. Attention is drawn to the limitation of liability, indemnification and jurisdiction issues defined therein. Any holder of this document is advised that information contained hereon reflects the Company's findings at the time of its intervention only and within the limits of Client's instructions, if any. The Company's sole responsibility is to its Client and this document does not exonerate parties to a transaction from exercising all their rights and obligations under the transaction documents. This document cannot be reproduced except in full, without prior written approval of the Company. Any unauthorized alteration, forgery or falsification of the content or appearance of this document is unlawful and offenders may be prosecuted to the fullest extent of the law. Unless otherwise stated the results shown in this test report refer only to the sample(s) tested and such sample(s) are retained for 30 days only.
Attention: To check the authenticity of testing /inspection report & certificate, please contact us at telephone: (86-755) 8307 1443, or email: CN.Doccheck@sgs.com



3.8 Test Frequencies

Test Mode	TX / RX	RF Channel		
		Low (L)	Middle (M)	High (H)
GSM850	TX	Channel 128	Channel 190	Channel 251
		824.2MHz	836.6 MHz	848.8 MHz
	RX	Channel 128	Channel 190	Channel 251
		869.2 MHz	881.6 MHz	893.8 MHz

Test Mode	TX / RX	RF Channel		
		Low (L)	Middle (M)	High (H)
GSM1900	TX	Channel 512	Channel 661	Channel 810
		1850.2MHz	1880.0 MHz	1909.8 MHz
	RX	Channel 512	Channel 661	Channel 810
		1930.2 MHz	1960.0 MHz	1989.8 MHz

Test Mode	TX / RX	RF Channel		
		Low (L)	Middle (M)	High (H)
WCDMA Band II	TX	Channel 9262	Channel 9400	Channel 9538
		1852.4 MHz	1880.0 MHz	1907.6 MHz
	RX	Channel 9662	Channel 9800	Channel 9938
		1932.4 MHz	1960.0 MHz	1987.6 MHz

Test Mode	TX / RX	RF Channel		
		Low (L)	Middle (M)	High (H)
WCDMA Band IV	TX	Channel 1312	Channel 1413	Channel 1513
		1712.4MHz	1732.6 MHz	1752.6 MHz
	RX	Channel 1537	Channel 1638	Channel 1738
		2112.4 MHz	2132.6 MHz	2152.6 MHz

Test Mode	TX / RX	RF Channel		
		Low (L)	Middle (M)	High (H)
WCDMA Band V	TX	Channel 4132	Channel 4182	Channel 4233
		826.4MHz	836.4 MHz	846.6 MHz
	RX	Channel 4357	Channel 4407	Channel 4458
		871.4 MHz	881.4 MHz	891.6 MHz



Unless otherwise agreed in writing, this document is issued by the Company subject to its General Conditions of Service printed overleaf, available on request or accessible at <http://www.sgs.com/en/Terms-and-Conditions.aspx> and, for electronic format documents, subject to Terms and Conditions for Electronic Documents at <http://www.sgs.com/en/terms-and-conditions/terms-e-document.aspx>. Attention is drawn to the limitation of liability, indemnification and jurisdiction issues defined therein. Any holder of this document is advised that information contained hereon reflects the Company's findings at the time of its intervention only and within the limits of Client's instructions, if any. The Company's sole responsibility is to its Client and this document does not exonerate parties to a transaction from exercising all their rights and obligations under the transaction documents. This document cannot be reproduced except in full, without prior written approval of the Company. Any unauthorized alteration, forgery or falsification of the content or appearance of this document is unlawful and offenders may be prosecuted to the fullest extent of the law. Unless otherwise stated the results shown in this test report refer only to the sample(s) tested and such sample(s) are retained for 30 days only.
Attention: To check the authenticity of testing /inspection report & certificate, please contact us at telephone: (86-755) 8307 1443, or email: CN.Doccheck@sgs.com



		1720 MHz	1732.5 MHz	1745 MHz
	RX	Channel 2050	Channel 2175	Channel 2300
		2120 MHz	2132.5MHz	2145 MHz

Test Mode	Bandwidth	TX / RX	RF Channel		
			Low (L)	Middle (M)	High (H)
LTE Band 5	1.4MHz	TX	Channel 20407	Channel 20525	Channel 20643
			824.7 MHz	836.5 MHz	848.3 MHz
		RX	Channel 2407	Channel 2525	Channel 2643
			869.7 MHz	881.5 MHz	893.3 MHz
	3MHz	TX	Channel 20415	Channel 20525	Channel 20635
			825.5 MHz	836.5 MHz	847.5 MHz
		RX	Channel 2415	Channel 2525	Channel 2635
			870.5 MHz	881.5 MHz	892.5 MHz
	5MHz	TX	Channel 20425	Channel 20525	Channel 20625
			826.5 MHz	836.5 MHz	846.5 MHz
		RX	Channel 2425	Channel 2525	Channel 2625
			871.5 MHz	881.5 MHz	891.5 MHz
10MHz	TX	Channel 20450	Channel 20525	Channel 20600	
		829 MHz	836.5 MHz	844 MHz	
	RX	Channel 2450	Channel 2525	Channel 2600	
		874 MHz	881.5 MHz	889 MHz	

Test Mode	Bandwidth	TX / RX	RF Channel		
			Low (L)	Middle (M)	High (H)
LTE Band 7	5MHz	TX	Channel 20775	Channel 21100	Channel 21425
			2502.5 MHz	2535 MHz	2567.5 MHz
		RX	Channel 2775	Channel 3100	Channel 5825
			2622.5 MHz	2655 MHz	2687.5 MHz
	10MHz	TX	Channel 20800	Channel 21100	Channel 21400
			2505 MHz	2535 MHz	2565 MHz
		RX	Channel 2800	Channel 3100	Channel 3400
			2625 MHz	2655 MHz	2685 MHz
	15MHz	TX	Channel 20825	Channel 21100	Channel 21375
			2507.5 MHz	2535 MHz	2562.5 MHz
		RX	Channel 2825	Channel 3100	Channel 3375
			2627.5 MHz	2655 MHz	2682.5 MHz
20MHz	TX	Channel 20850	Channel 21100	Channel 21350	
		2510 MHz	2535 MHz	2560 MHz	
	RX	Channel 2850	Channel 3100	Channel 3350	
		2630 MHz	2655 MHz	2680 MHz	

Test Mode	Bandwidth	TX / RX	RF Channel		
			Low (L)	Middle (M)	High (H)
LTE Band12	1.4MHz	TX	Channel 23017	Channel 23095	Channel 23173
			699.7 MHz	707.5 MHz	715.3 MHz
		RX	Channel 5017	Channel 5095	Channel 5173
			729.7 MHz	737.5 MHz	745.3 MHz
3MHz	TX	Channel 23025	Channel 23095	Channel 23165	



Unless otherwise agreed in writing, this document is issued by the Company subject to its General Conditions of Service printed overleaf, available on request or accessible at <http://www.sgs.com/en/Terms-and-Conditions.aspx> and, for electronic format documents, subject to Terms and Conditions for Electronic Documents at <http://www.sgs.com/en/Terms-and-Conditions/Terms-e-Documents.aspx>. Attention is drawn to the limitation of liability, indemnification and jurisdiction issues defined therein. Any holder of this document is advised that information contained hereon reflects the Company's findings at the time of its intervention only and within the limits of Client's instructions, if any. The Company's sole responsibility is to its Client and this document does not exonerate parties to a transaction from exercising all their rights and obligations under the transaction documents. This document cannot be reproduced except in full, without prior written approval of the Company. Any unauthorized alteration, forgery or falsification of the content or appearance of this document is unlawful and offenders may be prosecuted to the fullest extent of the law. Unless otherwise stated the results shown in this test report refer only to the sample(s) tested and such sample(s) are retained for 30 days only.

Attention: To check the authenticity of testing/inspection report & certificate, please contact us at telephone: (86-755) 8307 1443, or email: CN.Doccheck@sgs.com



	5MHz	RX	700.5 MHz	707.5 MHz	714.5 MHz
			Channel 5025	Channel 5095	Channel 5165
		TX	730.5 MHz	737.5 MHz	744.5 MHz
			Channel 23035	Channel 23095	Channel 23155
	10MHz	RX	701.5 MHz	707.5 MHz	713.5 MHz
			Channel 5035	Channel 5095	Channel 5155
		TX	731.5 MHz	737.5 MHz	743.5 MHz
			Channel 23060	Channel 23095	Channel 23130
RX	704 MHz	707.5 MHz	711 MHz		
	Channel 5060	Channel 5095	Channel 5130		
			734 MHz	737.5 MHz	741 MHz

Test Mode	Bandwidth	TX / RX	RF Channel		
			Low (L)	Middle (M)	High (H)
LTE Band 17	5MHz	TX	Channel 23755	Channel 23790	Channel 23825
			706.5 MHz	710 MHz	713.5 MHz
		RX	Channel 5755	Channel 5790	Channel 5825
			736.5 MHz	740 MHz	743.5 MHz
	10MHz	TX	Channel 23780	Channel 23790	Channel 23800
			709 MHz	710 MHz	711 MHz
		RX	Channel 5780	Channel 5790	Channel 5800
			739 MHz	740 MHz	741 MHz

Test Mode	Bandwidth	TX / RX	RF Channel		
			Low (L)	Middle (M)	High (H)
LTE Band 26 (814-824)	1.4MHz	TX	Channel 26697	Channel 26740	Channel 26783
			814.7 MHz	819 MHz	823.3 MHz
		RX	Channel 8697	Channel 8740	Channel 8783
			859.7 MHz	864MHz	868.3 MHz
	3MHz	TX	Channel 26705	Channel 26740	Channel 26775
			815.5 MHz	819 MHz	822.5 MHz
		RX	Channel 8705	Channel 8740	Channel 8775
			860.5 MHz	864MHz	867.5 MHz
	5MHz	TX	Channel 26715	Channel 26740	Channel 26765
			816.5 MHz	819 MHz	821.5 MHz
		RX	Channel 8715	Channel 8740	Channel 8755
			861.5 MHz	864MHz	866.5 MHz
	10MHz	TX	Channel 26740	Channel 26740	Channel 26740
			819 MHz	819 MHz	819 MHz
		RX	Channel 8740	Channel 8740	Channel 8740
			864MHz	864MHz	864MHz

Test Mode	Bandwidth	TX / RX	RF Channel		
			Low (L)	Middle (M)	High (H)
LTE Band 26 (824-849)	1.4MHz	TX	Channel 26797	Channel 26915	Channel 27033
			824.7 MHz	836.5 MHz	848.3 MHz
		RX	Channel 8697	Channel 8915	Channel 9033
			859.7 MHz	881.5 MHz	893.3 MHz
	3MHz	TX	Channel 26805	Channel 26915	Channel 27025



Unless otherwise agreed in writing, this document is issued by the Company subject to its General Conditions of Service printed overleaf, available on request or accessible at <http://www.sgs.com/en/Terms-and-Conditions.aspx> and, for electronic format documents, subject to Terms and Conditions for Electronic Documents at <http://www.sgs.com/en/Terms-and-Conditions/Terms-e-Documents.aspx>. Attention is drawn to the limitation of liability, indemnification and jurisdiction issues defined therein. Any holder of this document is advised that information contained hereon reflects the Company's findings at the time of its intervention only and within the limits of Client's instructions, if any. The Company's sole responsibility is to its Client and this document does not exonerate parties to a transaction from exercising all their rights and obligations under the transaction documents. This document cannot be reproduced except in full, without prior written approval of the Company. Any unauthorized alteration, forgery or falsification of the content or appearance of this document is unlawful and offenders may be prosecuted to the fullest extent of the law. Unless otherwise stated the results shown in this test report refer only to the sample(s) tested and such sample(s) are retained for 30 days only.

Attention: To check the authenticity of testing/inspection report & certificate, please contact us at telephone: (86-755) 8307 1443, or email: CN.Doccheck@sgs.com



	5MHz	RX	825.5 MHz	836.5 MHz	847.5 MHz
			Channel 8805	Channel 8915	Channel 9025
		TX	860.5 MHz	881.5 MHz	892.5 MHz
			Channel 26815	Channel 26915	Channel 27015
		RX	826.5 MHz	836.5 MHz	846.5 MHz
			Channel 8815	Channel 8915	Channel 9015
	10MHz	TX	871.5 MHz	881.5 MHz	891.5 MHz
			Channel 26840	Channel 26915	Channel 26990
		RX	829 MHz	836.5 MHz	844 MHz
			Channel 8840	Channel 8915	Channel 8990
	15MHz	TX	874 MHz	881.5 MHz	889 MHz
			Channel 26865	Channel 26915	Channel 26965
RX		831.5 MHz	836.5 MHz	841.5 MHz	
		Channel 8865	Channel 8915	Channel 8965	
			876.5 MHz	881.5 MHz	886.5 MHz

Test Mode	Bandwidth	TX / RX	RF Channel		
			Low (L)	Middle (M)	High (H)
LTE Band 38	5MHz	TX/RX	Channel 37775	Channel 38000	Channel 38225
			2572.5 MHz	2595 MHz	2617.5 MHz
	10MHz	TX/RX	Channel 37800	Channel 38000	Channel 38200
			2575 MHz	2595 MHz	2615 MHz
	15MHz	TX/RX	Channel 37825	Channel 38000	Channel 38175
			2577.5 MHz	2595 MHz	2612.5 MHz
	20MHz	TX/RX	Channel 37850	Channel 38000	Channel 38150
			2580 MHz	2595 MHz	2610 MHz

Test Mode	Bandwidth	TX / RX	RF Channel		
			Low (L)	Middle (M)	High (H)
LTE Band 41	5MHz	TX/RX	Channel 39675	Channel 40620	Channel 41565
			2498.5 MHz	2593 MHz	2687.5 MHz
	10MHz	TX/RX	Channel 39700	Channel 40620	Channel 41540
			2501 MHz	2593 MHz	2685 MHz
	15MHz	TX/RX	Channel 39725	Channel 40620	Channel 41515
			2503.5 MHz	2593 MHz	2682.5 MHz
	20MHz	TX/RX	Channel 39750	Channel 40620	Channel 41490
			2506 MHz	2593 MHz	2680 MHz

Test Mode	Bandwidth	TX / RX	RF Channel		
			Low (L)	Middle (M)	High (H)
LTE Band 66	1.4MHz	TX	Channel 131979	Channel 132322	Channel 132665
			1710.7 MHz	1745 MHz	1779.3 MHz
		RX	Channel 66443	Channel 66786	Channel 67329
			2110.7 MHz	2145MHz	2199.3 MHz
	3MHz	TX	Channel 131987	Channel 132322	Channel 132657
			1711.5 MHz	1745 MHz	1778.5MHz
		RX	Channel 66451	Channel 66786	Channel 67121
			2111.5 MHz	2145MHz	2198.5MHz
5MHz	TX	Channel 131997	Channel 132322	Channel 132647	



Unless otherwise agreed in writing, this document is issued by the Company subject to its General Conditions of Service printed overleaf, available on request or accessible at <http://www.sgs.com/en/Terms-and-Conditions.aspx> and, for electronic format documents, subject to Terms and Conditions for Electronic Documents at <http://www.sgs.com/en/Terms-and-Conditions/Terms-e-Documents.aspx>. Attention is drawn to the limitation of liability, indemnification and jurisdiction issues defined therein. Any holder of this document is advised that information contained hereon reflects the Company's findings at the time of its intervention only and within the limits of Client's instructions, if any. The Company's sole responsibility is to its Client and this document does not exonerate parties to a transaction from exercising all their rights and obligations under the transaction documents. This document cannot be reproduced except in full, without prior written approval of the Company. Any unauthorized alteration, forgery or falsification of the content or appearance of this document is unlawful and offenders may be prosecuted to the fullest extent of the law. Unless otherwise stated the results shown in this test report refer only to the sample(s) tested and such sample(s) are retained for 30 days only.

Attention: To check the authenticity of testing / inspection report & certificate, please contact us at telephone: (86-755) 8307 1443, or email: CN.Doccheck@sgs.com



	RX	1712.5 MHz	1745 MHz	1777.5 MHz	
		Channel 66461	Channel 66786	Channel 67311	
	TX	2112.5 MHz	2145MHz	2197.5 MHz	
		Channel 132022	Channel 132322	Channel 132622	
	10MHz	RX	1715 MHz	1745 MHz	1775 MHz
		RX	Channel 66486	Channel 66786	Channel 67286
	15MHz	RX	2115 MHz	2145MHz	2195 MHz
		TX	Channel 132047	Channel 132322	Channel 132597
	20MHz	TX	1717.5 MHz	1745 MHz	1772.5 MHz
		RX	Channel 66511	Channel 66786	Channel 67261
	TX	2117.5 MHz	2145MHz	2192.5 MHz	
		Channel 132072	Channel 132322	Channel 132572	
RX	1720 MHz	1745 MHz	1770 MHz		
	Channel 66536	Channel 66786	Channel 67236		
		2120 MHz	2145MHz	2190 MHz	

Table 4.3.1.1.7A-1: Test frequencies for CA_7C

Range	CC-Combo / N _{RB_agg} [RB]	CC1 Note1					CC2 Note1				
		BW [RB]	N _{UL}	f _{UL} [MHz]	N _{DL}	f _{DL} [MHz]	BW [RB]	N _{UL}	f _{UL} [MHz]	N _{DL}	f _{DL} [MHz]
Low	50+100	50	20805	2505.5	2805	2625.5	100	20949	2519.9	2949	2639.9
		100	20850	2510	2850	2630	50	20994	2524.4	2994	2644.4
	75+50	75	20825	2507.5	2825	2627.5	50	20945	2519.5	2945	2639.5
	75+75	75	20825	2507.5	2825	2627.5	75	20975	2522.5	2975	2642.5
	75+100	75	20828	2507.8	2828	2627.8	100	20999	2524.9	2999	2644.9
	100+100	100	20850	2510	2850	2630	75	21021	2527.1	3021	2647.1
Mid	50+100	50	21006	2525.6	3006	2645.6	100	21150	2540	3150	2660
		100	21051	2530.1	3051	2650.1	50	21195	2544.5	3195	2664.5
	75+50	75	21051	2530.1	3051	2650.1	50	21171	2542.1	3171	2662.1
	75+75	75	21025	2527.5	3025	2647.5	75	21175	2542.5	3175	2662.5
	75+100	75	21003	2525.3	3003	2645.3	100	21174	2542.4	3174	2662.4
	100+100	100	21026	2527.6	3026	2647.6	75	21197	2544.7	3197	2664.7
High	50+100	50	21206	2545.6	3206	2665.6	100	21350	2560	3350	2680
		100	21251	2550.1	3251	2670.1	50	21395	2564.5	3395	2684.5
	75+50	75	21277	2552.7	3277	2672.7	50	21397	2564.7	3397	2684.7
	75+75	75	21225	2547.5	3225	2667.5	75	21375	2562.5	3375	2682.5
	75+100	75	21179	2542.9	3179	2662.9	100	21350	2560	3350	2680
	100+100	100	21201	2545.1	3201	2665.1	75	21372	2562.2	3372	2682.2
	100	21152	2540.2	3152	2660.2	100	21350	2560	3350	2680	

Note 1: Carriers in increasing frequency order.



Unless otherwise agreed in writing, this document is issued by the Company subject to its General Conditions of Service printed overleaf, available on request or accessible at <http://www.sgs.com/en/Terms-and-Conditions.aspx> and, for electronic format documents, subject to Terms and Conditions for Electronic Documents at <http://www.sgs.com/en/Terms-and-Conditions/Terms-e-Documents.aspx>. Attention is drawn to the limitation of liability, indemnification and jurisdiction issues defined therein. Any holder of this document is advised that information contained hereon reflects the Company's findings at the time of its intervention only and within the limits of Client's instructions, if any. The Company's sole responsibility is to its Client and this document does not exonerate parties to a transaction from exercising all their rights and obligations under the transaction documents. This document cannot be reproduced except in full, without prior written approval of the Company. Any unauthorized alteration, forgery or falsification of the content or appearance of this document is unlawful and offenders may be prosecuted to the fullest extent of the law. Unless otherwise stated the results shown in this test report refer only to the sample(s) tested and such sample(s) are retained for 30 days only.

Attention: To check the authenticity of testing/inspection report & certificate, please contact us at telephone: (86-755) 8307 1443, or email: CN.Doccheck@sgs.com



Table 4.3.1.2.6A-1: Test frequencies for CA_38C

Range	CC-Combo / N _{RB_agg} [RB]	CC1 Note1			CC2 Note1		
		BW [RB]	N _{UL/DL}	f _{UL/DL} [MHz]	BW [RB]	N _{UL/DL}	f _{UL/DL} [MHz]
Low	75+75	75	37825	2577.5	75	37975	2592.5
	100+100	100	37850	2580	100	38048	2599.8
Mid	75+75	75	37925	2587.5	75	38075	2602.5
	100+100	100	37901	2585.1	100	38099	2604.9
High	75+75	75	38025	2597.5	75	38175	2612.5
	100+100	100	37952	2590.2	100	38150	2610

Note 1: Carriers in increasing frequency order.

Table 4.3.1.2.9A-1: Test frequencies for CA_41C

Range	CC-Combo / N _{RB_agg} [RB]	CC1 Note1			CC2 Note1		
		BW [RB]	N _{UL/DL}	f _{UL/DL} [MHz]	BW [RB]	N _{UL/DL}	f _{UL/DL} [MHz]
Low	25+100	25	39683	2499.3	100	39800	2511
		100	39750	2506	25	39867	2517.7
	50+75	50	39703	2501.3	75	39823	2513.3
		75	39725	2503.5	50	39845	2515.5
	50+100	50	39705	2501.5	100	39849	2515.9
		100	39750	2506	50	39894	2520.4
	75+75	75	39725	2503.5	75	39875	2518.5
		75+100	75	39728	2503.8	100	39899
	75+100	100	39750	2506	75	39921	2523.1
		100+100	100	39750	2506	100	39948
Mid	25+100	25	40528	2583.8	100	40645	2595.5
		100	40595	2590.5	25	40712	2602.2
	50+75	50	40549	2585.9	75	40669	2597.9
		75	40571	2588.1	50	40691	2600.1
	50+100	50	40526	2583.6	100	40670	2598.0
		100	40571	2588.1	50	40715	2602.5
	75+75	75	40545	2585.5	75	40695	2600.5
		75+100	75	40523	2583.3	100	40694
	75+100	100	40546	2585.6	75	40717	2602.7
		100+100	100	40521	2583.1	100	40719
High	25+100	25	41373	2668.3	100	41490	2680
		100	41440	2675	25	41557	2686.7
	50+75	50	41395	2670.5	75	41515	2682.5
		75	41417	2672.7	50	41537	2684.7
	50+100	50	41346	2665.6	100	41490	2680
		100	41391	2670.1	50	41535	2684.5
	75+75	75	41365	2667.5	75	41515	2682.5
		75+100	75	41319	2662.9	100	41490
	75+100	100	41341	2665.1	75	41512	2682.2
		100+100	100	41292	2660.2	100	41490

Note 1: Carriers in increasing frequency order.



Unless otherwise agreed in writing, this document is issued by the Company subject to its General Conditions of Service printed overleaf, available on request or accessible at <http://www.sgs.com/en/Terms-and-Conditions.aspx> and, for electronic format documents, subject to Terms and Conditions for Electronic Documents at <http://www.sgs.com/en/Terms-and-Conditions/Terms-e-Documents.aspx>. Attention is drawn to the limitation of liability, indemnification and jurisdiction issues defined therein. Any holder of this document is advised that information contained hereon reflects the Company's findings at the time of its intervention only and within the limits of Client's instructions, if any. The Company's sole responsibility is to its Client and this document does not exonerate parties to a transaction from exercising all their rights and obligations under the transaction documents. This document cannot be reproduced except in full, without prior written approval of the Company. Any unauthorized alteration, forgery or falsification of the content or appearance of this document is unlawful and offenders may be prosecuted to the fullest extent of the law. Unless otherwise stated the results shown in this test report refer only to the sample(s) tested and such sample(s) are retained for 30 days only.

Attention: To check the authenticity of testing/inspection report & certificate, please contact us at telephone: (86-755) 8307 1443, or email: CN.Doccheck@sgs.com



4 Description of Tests

4.1 Conducted Output Power

Measurement Procedure: FCC KDB 971168 D01 V03r01

The transmitter output was connected to a calibrated coaxial cable, attenuator and power meter, the other end of which was connected to a Base Station Simulator. The Base Station Simulator was set to force the EUT to its maximum power setting. The power output at the transmitter antenna port was determined by adding the value of the cable insertion loss to the power reading. The tests were performed at three frequencies (low channel, middle channel and high channel) and on the highest power levels, which can be setup on the transmitters.

Remark: Reference test setup 1

4.2 Effective (Isotropic) Radiated Power of Transmitter

Measurement Procedure: FCC KDB 971168 D01 V03r01 ; C63.26 (2015)

Calculate power in dBm by the following formula:

ERP (dBm) = Conducted Power (dBm) + antenna gain (dBd)

EIRP(dBm) = Conducted Power (dBm) + antenna gain (dBi)

EIRP=ERP+2.15dB

4.3 Occupied Bandwidth

Measurement Procedure: FCC KDB 971168 D01 V03r01 Section 4.2

The occupied bandwidth, that is the frequency bandwidth such that, below its lower and above its upper frequency limits, the mean powers radiated are each equal to 0.5 percent of the total mean power radiated by a given emission shall be measured. The transmitter output was connected to a calibrated coaxial cable, attenuator and Spectrum analyser, the other end of which was connected to a Base Station Simulator. The Base Station Simulator was set to force the EUT to its maximum power setting. The tests were performed at three frequencies (low channel, middle channel and high channel). The span of the analyzer shall be set to capture all products of the modulation process, including the emission skirts. The resolution bandwidth shall be set to as close to 1 percent of the selected span as is possible without being below 1 percent. The video bandwidth shall be set to 3 times the resolution bandwidth. Video averaging is not permitted. Where practical, a sampling detector shall be used since a peak or, peak hold, may produce a wider bandwidth than actual. The trace data points are recovered and are directly summed in linear terms. The recovered amplitude data points, beginning at the lowest frequency, are placed in a running sum until 0.5 percent of the total is reached and that frequency recorded. The process is repeated for the highest frequency data points. This frequency is recorded. The span between the two recorded frequencies is the occupied bandwidth.

Remark: Reference test setup 1



Unless otherwise agreed in writing, this document is issued by the Company subject to its General Conditions of Service printed overleaf, available on request or accessible at <http://www.sgs.com/en/Terms-and-Conditions.aspx> and, for electronic format documents, subject to Terms and Conditions for Electronic Documents at <http://www.sgs.com/en/Terms-and-Conditions/Terms-e-Documents.aspx>. Attention is drawn to the limitation of liability, indemnification and jurisdiction issues defined therein. Any holder of this document is advised that information contained hereon reflects the Company's findings at the time of its intervention only and within the limits of Client's instructions, if any. The Company's sole responsibility is to its Client and this document does not exonerate parties to a transaction from exercising all their rights and obligations under the transaction documents. This document cannot be reproduced except in full, without prior written approval of the Company. Any unauthorized alteration, forgery or falsification of the content or appearance of this document is unlawful and offenders may be prosecuted to the fullest extent of the law. Unless otherwise stated the results shown in this test report refer only to the sample(s) tested and such sample(s) are retained for 30 days only.
Attention: To check the authenticity of testing /inspection report & certificate, please contact us at telephone: (86-755) 8307 1443, or email: CN.Doccheck@sgs.com

Test Settings

1. The signal analyzer's automatic bandwidth measurement capability was used to perform the 99% occupied bandwidth and the 26dB bandwidth. The bandwidth measurement was not influenced by any intermediate power nulls in the fundamental emission.
2. RBW = 1 – 5% of the expected OBW
3. VBW \geq 3 x RBW
4. Detector = Peak
5. Trace mode = max hold
6. Sweep = auto couple
7. The trace was allowed to stabilize
8. If necessary, steps 2 – 7 were repeated after changing the RBW such that it would be within 1 – 5% of the 99% occupied bandwidth observed in Step 7

4.4 Band Edge at Antenna Terminals

Measurement Procedure: FCC KDB 971168 D01 V03r01 Section 6.0

The transmitter output was connected to a calibrated coaxial cable, attenuator and Spectrum analyser, the other end of which was connected to a Base Station Simulator. The Base Station Simulator was set to force the EUT to its maximum power setting. The tests were performed at two frequencies (low channel and high channel). in the 1MHz bands immediately outside and adjacent to the frequency block a resolution bandwidth of 100kHz or 1% of the emission bandwidth of the fundamental emission of the transmitter may be employed. The EUT emission bandwidth is measured as the width of the signal between two points, outside of which all emission are attenuated at least 26dB below the transmitter power. The video bandwidth of the spectrum analyzer was set at thrice the resolution bandwidth. Detector Mode was set to peak or peak hold power.

Remark: Reference test setup 1

Test Settings

1. Start and stop frequency were set such that the band edge would be placed in the center of the plot
2. Span was set large enough so as to capture all out of band emissions near the band edge
3. RBW \geq 1% of the emission bandwidth
4. VBW \geq 3 x RBW
5. Detector = RMS
6. Number of sweep points \geq 2 x Span/RBW
7. Trace mode = trace average for continuous emissions, max hold for pulse emissions
8. Sweep time = auto couple
9. The trace was allowed to stabilize



Unless otherwise agreed in writing, this document is issued by the Company subject to its General Conditions of Service printed overleaf, available on request or accessible at <http://www.sgs.com/en/Terms-and-Conditions.aspx> and, for electronic format documents, subject to Terms and Conditions for Electronic Documents at <http://www.sgs.com/en/Terms-and-Conditions/Terms-e-Document.aspx>. Attention is drawn to the limitation of liability, indemnification and jurisdiction issues defined therein. Any holder of this document is advised that information contained hereon reflects the Company's findings at the time of its intervention only and within the limits of Client's instructions, if any. The Company's sole responsibility is to its Client and this document does not exonerate parties to a transaction from exercising all their rights and obligations under the transaction documents. This document cannot be reproduced except in full, without prior written approval of the Company. Any unauthorized alteration, forgery or falsification of the content or appearance of this document is unlawful and offenders may be prosecuted to the fullest extent of the law. Unless otherwise stated the results shown in this test report refer only to the sample(s) tested and such sample(s) are retained for 30 days only.
Attention: To check the authenticity of testing / inspection report & certificate, please contact us at telephone: (86-755) 8307 1443, or email: CN.Doccheck@sgs.com

4.5 Spurious And Harmonic Emissions at Antenna Terminal

Measurement Procedure: FCC KDB 971168 D01 V03r01

The transmitter output was connected to a calibrated coaxial cable, attenuator and Spectrum analyzer, the other end of which was connected to a Base Station Simulator. The Base Station Simulator was set to force the EUT to its maximum power setting. The tests were performed at three frequencies (low channel and high channel). The level of the carrier and the various conducted spurious and harmonic frequencies is measured by means of a calibrated spectrum analyzer. The spectrum is scanned from the lowest frequency generated in the equipment up to a frequency including its 10th harmonic. On any frequency outside a licensee's frequency block, the power of any emission shall be attenuated below the transmitter power (P) by at least $43 + 10 \log(P)$ dB. Compliance with these provisions is based on the use of measurement instrumentation employing a resolution bandwidth of 1 MHz or greater. However, in the 1 MHz bands immediately outside and adjacent to the frequency block a resolution bandwidth of at least one percent of the emission bandwidth of the fundamental emission of the transmitter may be employed. The emission bandwidth is defined as the width of the signal between two points, one below the carrier center frequency and one above the carrier center frequency, outside of which all emission are attenuated at least 26 dB below the transmitter power.

Remark: Reference test setup 1

Test Settings

1. Start frequency was set to 30MHz and stop frequency was set to at least $10 \times$ the fundamental frequency (separated into at least two plots per channel)
2. Detector = RMS
3. Trace mode = trace average for continuous emissions, max hold for pulse emissions
4. Sweep time = auto couple
5. The trace was allowed to stabilize
6. Please see test notes below for RBW and VBW settings

4.6 Peak-Average Ratio

Measurement Procedure: FCC KDB 971168 D01 V03r01 Section 5.7.1

A peak to average ratio measurement is performed at the conducted port of the EUT. For WCDMA signals, the spectrum analyzers Complementary Cumulative Distribution Function (CCDF) measurement profile is used to determine the largest deviation between the average and the peak power of the EUT in a given bandwidth. The CCDF curve shows how much time the peak waveform spends at or above a given average power level. The percent of time the signal spends at or above the level defines the probability for that particular power level. For GSM signals, an average and a peak trace are used on a spectrum analyzer to determine the largest deviation between the average and the peak power of the EUT in a bandwidth greater than the emission bandwidth. The traces are generated with the spectrum analyzer set to zero span mode.

Remark: Reference test setup 1



Unless otherwise agreed in writing, this document is issued by the Company subject to its General Conditions of Service printed overleaf, available on request or accessible at <http://www.sgs.com/en/Terms-and-Conditions.aspx> and, for electronic format documents, subject to Terms and Conditions for Electronic Documents at <http://www.sgs.com/en/Terms-and-Conditions/Terms-e-Document.aspx>. Attention is drawn to the limitation of liability, indemnification and jurisdiction issues defined therein. Any holder of this document is advised that information contained hereon reflects the Company's findings at the time of its intervention only and within the limits of Client's instructions, if any. The Company's sole responsibility is to its Client and this document does not exonerate parties to a transaction from exercising all their rights and obligations under the transaction documents. This document cannot be reproduced except in full, without prior written approval of the Company. Any unauthorized alteration, forgery or falsification of the content or appearance of this document is unlawful and offenders may be prosecuted to the fullest extent of the law. Unless otherwise stated the results shown in this test report refer only to the sample(s) tested and such sample(s) are retained for 30 days only.
Attention: To check the authenticity of testing / inspection report & certificate, please contact us at telephone: (86-755) 8307 1443, or email: CN.Doccheck@sgs.com

Test Settings

1. The signal analyzer's CCDF measurement profile is enabled
2. Frequency = carrier center frequency
3. Measurement BW > Emission bandwidth of signal
4. The signal analyzer was set to collect one million samples to generate the CCDF curve
5. The measurement interval was set depending on the type of signal analyzed. For continuous signals (>98% duty cycle), the measurement interval was set to 1ms. For burst transmissions, the spectrum analyzer is set to use an internal "RF Burst" trigger that is synced with an incoming pulse and the measurement interval is set to less than the duration of the "on time" of one burst to ensure that energy is only captured during a time in which the transmitter is operating at maximum power

4.7 Field Strength of Spurious Radiation

Measurement Procedure: FCC KDB 971168 D01 V03r01

Below 1GHz test procedure as below:

- 1). The EUT was powered ON and placed on a 80cm high table in the chamber. The antenna of the transmitter was extended to its maximum length.
- 2). The disturbance of the transmitter was maximized on the test receiver display by raising and lowering from 1m to 4m (for the test frequency of below 30MHz, the antenna was tuned to heights 1 meter) the receive antenna and by rotating through 360° the turntable. After the fundamental emission was maximized, a field strength measurement was made.
- 3). Steps 1) and 2) were performed with the EUT and the receive antenna in both vertical and horizontal polarization.
- 4). The transmitter was then removed and replaced with another antenna. The center of the antenna was approximately at the same location as the center of the transmitter.
- 5). A signal at the disturbance was fed to the substitution antenna by means of a non-radiating cable. With both the substitution and the receive antennas horizontally polarized, the receive antenna was raised and lowered to obtain a maximum reading at the test receiver. The level of the signal generator was adjusted until the measured field strength level in step 2) is obtained for this set of conditions.
- 6). The output power into the substitution antenna was then measured.
- 7). Steps 5) and 6) were repeated with both antennas polarized.
- 8) Calculate power in dBm by the following formula:

$$\text{ERP(dBm)} = \text{Pg(dBm)} - \text{cable loss (dB)} + \text{antenna gain (dBd)}$$

Where:

Pd is the dipole equivalent power, Pg is the generator output into the substitution antenna, and the antenna gain is the gain of the substitute antenna used relative to either a half-wave dipole (dBd) or an isotropic source (dBi). The substitute level is equal to Pg [dBm] – cable loss [dB]. The calculated Pd levels are then compared to the absolute spurious emission limit of -13dBm which is equivalent to the required minimum attenuation of 43 + 10log10(Power [Watts]).

Above 1GHz test procedure as below:

- 1) Different between above is the test site, change from Semi- Anechoic Chamber to fully Anechoic Chamber



2) Calculate power in dBm by the following formula:

$$\text{EIRP(dBm)} = \text{Pg(dBm)} - \text{cable loss (dB)} + \text{antenna gain (dBi)}$$

$$\text{EIRP} = \text{ERP} + 2.15\text{dB}$$

Where:

Pg is the generator output power into the substitution antenna.

3. Test the EUT in the lowest channel, the middle channel the Highest channel
4. The radiation measurements are performed in X, Y, Z axis positioning. And found the X axis positioning which it is worse case, Only the test worst case mode is recorded in the report.
5. Repeat above procedures until all frequencies measured was complete

Remark: Reference test setup 3

4.8 Frequency Stability / Temperature Variation

Measurement Procedure:

Frequency stability testing is performed in accordance with the guidelines of FCC KDB 971168 D01 V03r01; ANSI/C63.26 (2015)

. The frequency stability of the transmitter is measured by:

- a.) **Temperature:** The temperature is varied from -30°C to +50°C in 10°C increments using an environmental chamber.
- b.) **Primary Supply Voltage:** The primary supply voltage is varied from 85% to 115% of the nominal value for non hand-carried battery and AC powered equipment. For hand-carried, battery-powered equipment, primary supply voltage is reduced to the battery operating end point which shall be specified by the manufacturer.

Specification – The frequency stability shall be sufficient to ensure that the fundamental emission stays within the authorized frequency block. The frequency stability of the transmitter shall be maintained within $\pm 0.00025\%$ (± 2.5 ppm) of the center frequency.

Time Period and Procedure:

1. The carrier frequency of the transmitter is measured at room temperature (20°C to provide a reference).
2. The equipment is turned on in a “standby” condition for fifteen minutes before applying power to the transmitter. Measurement of the carrier frequency of the transmitter is made within one minute after applying power to the transmitter.
3. Frequency measurements are made at 10°C intervals ranging from -30°C to +50°C. A period of at least one half-hour is provided to allow stabilization of the equipment at each temperature level.

Remark: Reference test setup 4



Unless otherwise agreed in writing, this document is issued by the Company subject to its General Conditions of Service printed overleaf, available on request or accessible at <http://www.sgs.com/en/Terms-and-Conditions.aspx> and, for electronic format documents, subject to Terms and Conditions for Electronic Documents at <http://www.sgs.com/en/terms-and-conditions/terms-e-document.aspx>. Attention is drawn to the limitation of liability, indemnification and jurisdiction issues defined therein. Any holder of this document is advised that information contained hereon reflects the Company's findings at the time of its intervention only and within the limits of Client's instructions, if any. The Company's sole responsibility is to its Client and this document does not exonerate parties to a transaction from exercising all their rights and obligations under the transaction documents. This document cannot be reproduced except in full, without prior written approval of the Company. Any unauthorized alteration, forgery or falsification of the content or appearance of this document is unlawful and offenders may be prosecuted to the fullest extent of the law. Unless otherwise stated the results shown in this test report refer only to the sample(s) tested and such sample(s) are retained for 30 days only.
Attention: To check the authenticity of testing /inspection report & certificate, please contact us at telephone: (86-755) 8307 1443, or email: CN.Doccheck@sgs.com

4.9 Test Setups

4.9.1 Test Setup 1

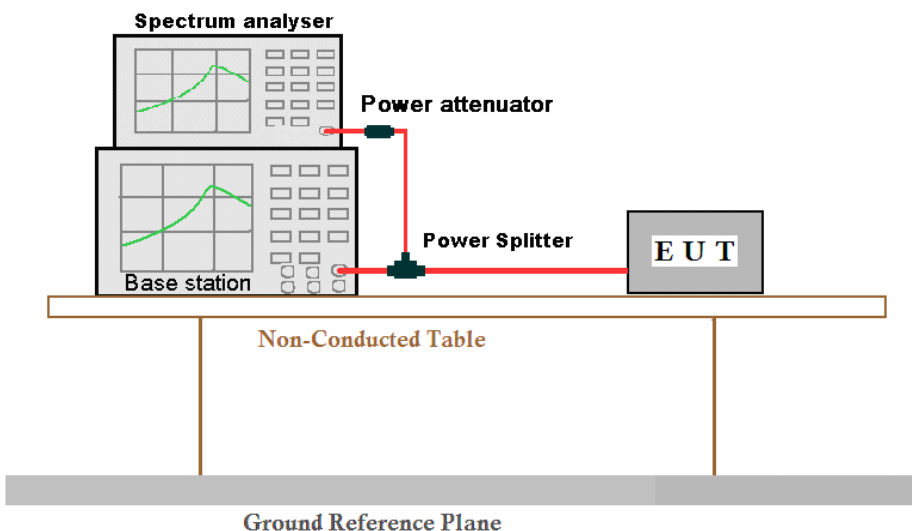

4.9.2 Test Setup 2

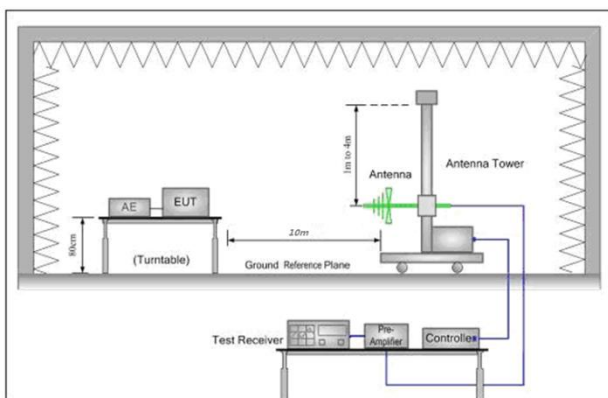

Figure 1. 30MHz to 1GHz

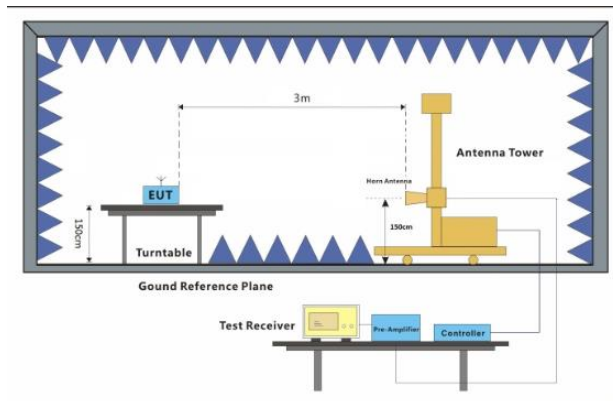

Figure 2. above 1GHz



4.9.3 Test Setup 3

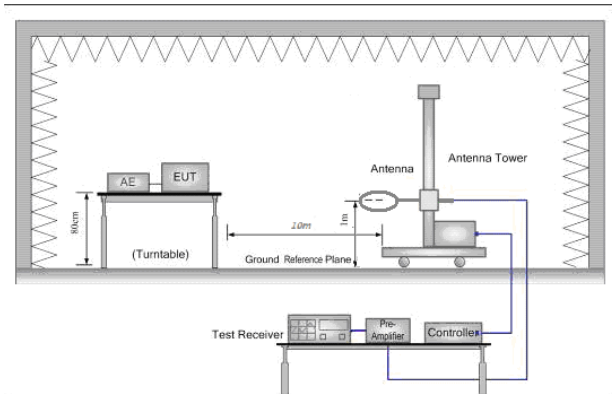

Figure 1. Below 30MHz

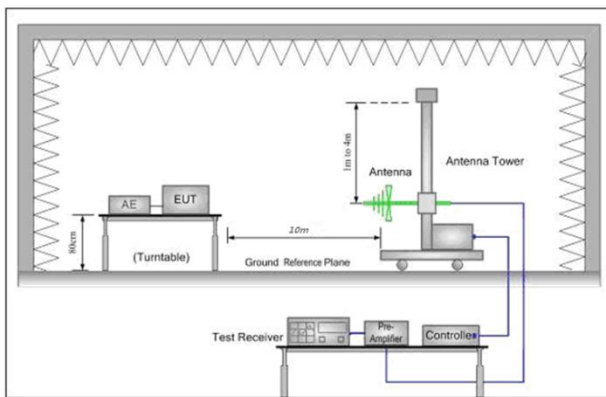

Figure 2. 30MHz to 1GHz

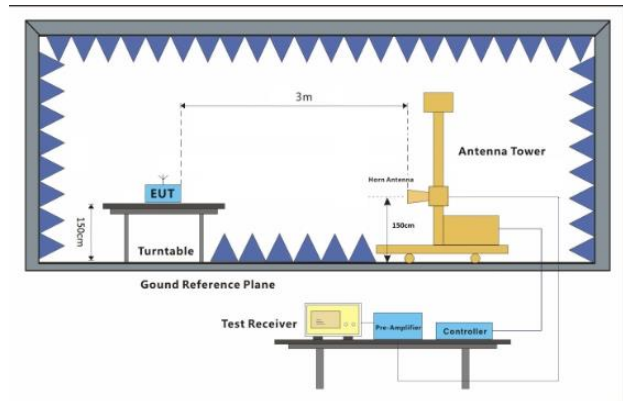
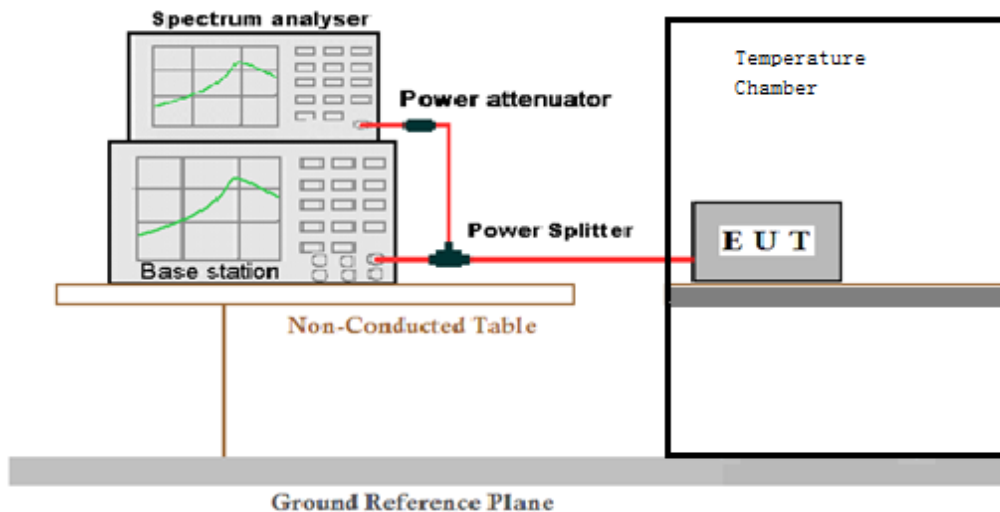

Figure 3. above 1GHz

4.9.4 Test Setup 4



Unless otherwise agreed in writing, this document is issued by the Company subject to its General Conditions of Service printed overleaf, available on request or accessible at <http://www.sgs.com/en/Terms-and-Conditions.aspx> and, for electronic format documents, subject to Terms and Conditions for Electronic Documents at <http://www.sgs.com/en/terms-and-conditions/terms-e-document.aspx>. Attention is drawn to the limitation of liability, indemnification and jurisdiction issues defined therein. Any holder of this document is advised that information contained hereon reflects the Company's findings at the time of its intervention only and within the limits of Client's instructions, if any. The Company's sole responsibility is to its Client and this document does not exonerate parties to a transaction from exercising all their rights and obligations under the transaction documents. This document cannot be reproduced except in full, without prior written approval of the Company. Any unauthorized alteration, forgery or falsification of the content or appearance of this document is unlawful and offenders may be prosecuted to the fullest extent of the law. Unless otherwise stated the results shown in this test report refer only to the sample(s) tested and such sample(s) are retained for 30 days only.
Attention: To check the authenticity of testing /inspection report & certificate, please contact us at telephone: (86-755) 8307 1443, or email: CN.Doccheck@sgs.com
No.1 Workshop, M-10, Middle Section, Science & Technology Park, Shenzhen, China 518057 t (86-755) 26012053 f (86-755) 26710594 www.sgs.com.cn
中国·深圳·科技园中区M-10栋一号厂房 邮编: 518057 t (86-755) 26012053 f (86-755) 26710594 sgs.china@sgs.com



4.10 Test Conditions

Test Case		Test Conditions	
Transmit Output Power Data	Average Power, Total	Test Environment	Ambient Climate & Rated Voltage
		Test Setup	Test Setup 1
		RF Channels (TX)	L, M, H (L= low channel, M= middle channel, H= high channel)
		Test Mode	GSM/TM1;GSM/TM2;UMTS/TM1; UMTS/TM2; LTE/TM1;LTE/TM2;LTE/TM3
	Average Power, Spectral Density (if required)	Test Environment	Ambient Climate & Rated Voltage
		Test Setup	Test Setup 1
		RF Channels (TX)	L, M, H (L= low channel, M= middle channel, H= high channel)
		Test Mode	GSM/TM1;GSM/TM2;UMTS/TM1; UMTS/TM2; LTE/TM1;LTE/TM2;LTE/TM3
Peak-to-Average Ratio (if required)	Test Environment	Ambient Climate & Rated Voltage	
	Test Setup	Test Setup 1	
	RF Channels (TX)	L, M, H (L= low channel, M= middle channel, H= high channel)	
	Test Mode	GSM/TM1;GSM/TM2;UMTS/TM1; UMTS/TM2; LTE/TM1;LTE/TM2;LTE/TM3	
Modulation Characteristics	Test Environment	Ambient Climate & Rated Voltage	
	Test Setup	Test Setup 1	
	RF Channels (TX)	M (M= middle channel)	
	Test Mode	GSM/TM1;GSM/TM2;UMTS/TM1; UMTS/TM2; LTE/TM1;LTE/TM2;LTE/TM3	
Bandwidth	Occupied Bandwidth	Test Environment	Ambient Climate & Rated Voltage
		Test Setup	Test Setup 1
		RF Channels (TX)	L, M, H (L= low channel, M= middle channel, H= high channel)
		Test Mode	GSM/TM1;GSM/TM2;UMTS/TM1; UMTS/TM2; LTE/TM1;LTE/TM2;LTE/TM3
	Emission Bandwidth (if required)	Test Environment	Ambient Climate & Rated Voltage
		Test Setup	Test Setup 1
		RF Channels (TX)	L, M, H (L= low channel, M= middle channel, H= high channel)
		Test Mode	GSM/TM1;GSM/TM2;UMTS/TM1; UMTS/TM2; LTE/TM1;LTE/TM2;LTE/TM3



Unless otherwise agreed in writing, this document is issued by the Company subject to its General Conditions of Service printed overleaf, available on request or accessible at <http://www.sgs.com/en/Terms-and-Conditions.aspx> and, for electronic format documents, subject to Terms and Conditions for Electronic Documents at <http://www.sgs.com/en/terms-and-conditions/terms-e-document.aspx>. Attention is drawn to the limitation of liability, indemnification and jurisdiction issues defined therein. Any holder of this document is advised that information contained hereon reflects the Company's findings at the time of its intervention only and within the limits of Client's instructions, if any. The Company's sole responsibility is to its Client and this document does not exonerate parties to a transaction from exercising all their rights and obligations under the transaction documents. This document cannot be reproduced except in full, without prior written approval of the Company. Any unauthorized alteration, forgery or falsification of the content or appearance of this document is unlawful and offenders may be prosecuted to the fullest extent of the law. Unless otherwise stated the results shown in this test report refer only to the sample(s) tested and such sample(s) are retained for 30 days only.
Attention: To check the authenticity of testing /inspection report & certificate, please contact us at telephone: (86-755) 8307 1443, or email: CN.Doccheck@sgs.com



Band Edges Compliance	Test Environment	Ambient Climate & Rated Voltage
	Test Setup	Test Setup 1
	RF Channels (TX)	L, H (L= low channel, H= high channel)
	Test Mode	GSM/TM1;GSM/TM2;UMTS/TM1; UMTS/TM2; LTE/TM1;LTE/TM2;LTE/TM3
Spurious Emission at Antenna Terminals	Test Environment	Ambient Climate & Rated Voltage
	Test Setup	Test Setup 1
	RF Channels (TX)	L,M, H (L= low channel, M= middle channel, H= high channel)
	Test Mode	GSM/TM1;GSM/TM2;UMTS/TM1; UMTS/TM2; LTE/TM1;LTE/TM2;LTE/TM3
Field Strength of Spurious Radiation	Test Environment	Ambient Climate & Rated Voltage
	Test Setup	Test Setup 2
	Test Mode	GSM/TM1;GSM/TM2;UMTS/TM1;UMTS/TM2; LTE/TM1;LTE/TM2;LTE/TM3; Remark: If applicable, the EUT conf. that has maximum power density (based on the equivalent power level) is selected.
	RF Channels (TX)	L, M, H (L= low channel, M= middle channel, H= high channel)
Frequency Stability	Test Environment	(1) -30 °C to +50 °C with step 10 °C at Rated Voltage; (2) VL, VN and VH of Rated Voltage at Ambient Climate.
	Test Setup	Test Setup 4
	RF Channels (TX)	L, M, H (L= low channel, M= middle channel, H= high channel)
	Test Mode	GSM/TM1;GSM/TM2;UMTS/TM1; UMTS/TM2; LTE/TM1;LTE/TM2;LTE/TM3



Unless otherwise agreed in writing, this document is issued by the Company subject to its General Conditions of Service printed overleaf, available on request or accessible at <http://www.sgs.com/en/Terms-and-Conditions.aspx> and, for electronic format documents, subject to Terms and Conditions for Electronic Documents at <http://www.sgs.com/en/Terms-and-Conditions/Terms-e-Document.aspx>. Attention is drawn to the limitation of liability, indemnification and jurisdiction issues defined therein. Any holder of this document is advised that information contained hereon reflects the Company's findings at the time of its intervention only and within the limits of Client's instructions, if any. The Company's sole responsibility is to its Client and this document does not exonerate parties to a transaction from exercising all their rights and obligations under the transaction documents. This document cannot be reproduced except in full, without prior written approval of the Company. Any unauthorized alteration, forgery or falsification of the content or appearance of this document is unlawful and offenders may be prosecuted to the fullest extent of the law. Unless otherwise stated the results shown in this test report refer only to the sample(s) tested and such sample(s) are retained for 30 days only.
Attention: To check the authenticity of testing /inspection report & certificate, please contact us at telephone: (86-755) 8307 1443, or email: CN.Doccheck@sgs.com



5 Main Test Instruments

RE in Chamber					
Test Equipment	Manufacturer	Model No.	Inventory No.	Cal. date	Cal. Due date
				(yyyy-mm-dd)	(yyyy-mm-dd)
3m Semi-Anechoic Chamber	AUDIX	N/A	SEM001-02	2018/3/13	2021/3/12
Spectrum Analyzer (20Hz-43GHz)	Rohde & Schwarz	FSU43	SEM004-08	2019/12/22	2020/12/21
BiConiLog Antenna (26-3000MHz)	ETS-Lindgren	3142C	SEM003-01	2017/6/27	2020/6/26
Horn Antenna (800MHz-18GHz)	Rohde & Schwarz	HF907	SEM003-07	2018/4/13	2021/4/12
Horn Antenna (15-40GHz)	Schwarzbeck	BBHA 9170	SEM003-15	2017/10/17	2020/10/16
Amplifier (0.1-1300MHz)	HP	8447D	SEM005-02	2019/7/14	2020/7/14
Low Noise Amplifier (100MHz-18GHz)	Black Diamond Series	BDLNA-0118-352810	SEM005-05	2019/7/14	2020/7/14
Pre-Amplifier (0.1-26.5GHz)	Compliance Directions Systems Inc.	PAP-0126	EMC2063	2019/9/20	2020/9/19
Pre-amplifier (26-40GHz)	Compliance Directions Systems Inc.	PAP-2640-50	SEM005-08	2019/12/22	2020/12/21
Band filter	N/A	N/A	N/A	N/A	N/A
Measurement Software	AUDIX	e3 V8.2014-6-27	N/A	N/A	N/A
Coaxial Cable	SGS	N/A	SEM026-01	2019/6/12	2020/6/11
Wideband Radio Communication Tester	Anristu	MT8821C	6201462742	2019/4/3	2020/4/3
Wideband Radio Communication Tester	Rohde & Schwarz	CMW500	W005-02	2020/1/13	2021/1/2
RF conducted test					
Test Equipment	Manufacturer	Model No.	Inventory No.	Cal. date	Cal. Due date
				(yyyy-mm-dd)	(yyyy-mm-dd)
Dual Output Mobile Communication DC Source	Agilent Technologies Inc	66311B	W009-09	2019/10/22	2020/10/21
Signal Analyzer	Rohde & Schwarz	FSV	W005-02	2019/12/22	2020/12/21
Coaxial Cable	SGS	N/A	SEM031-01	2019/6/12	2020/6/11
Attenuator	Weinschel Associates	WA41	SEM021-09	N/A	N/A
Signal Generator	KEYSIGHT	N5173B	SEM006-05	2019/10/22	2020/10/21
Humidity/ Temperature Indicator	Shanghai Meteorological Industry Factory	HTC-1	W006-17	2019/10/22	2020/10/21
Temperature Chamber	GIANT FORCE	ICT-150-40-CP-AR	W027-03	2019/10/22	2020/10/21
Wideband Radio Communication Tester	Anristu	MT8821C	6201462742	2019/12/22	2020/12/21
Wideband Radio Communication Tester	Rohde & Schwarz	CMW500	W005-02	2019/10/22	2020/10/21



Unless otherwise agreed in writing, this document is issued by the Company subject to its General Conditions of Service printed overleaf, available on request or accessible at <http://www.sgs.com/en/Terms-and-Conditions.aspx> and, for electronic format documents, subject to Terms and Conditions for Electronic Documents at <http://www.sgs.com/en/Terms-and-Conditions/Terms-e-Documents.aspx>. Attention is drawn to the limitation of liability, indemnification and jurisdiction issues defined therein. Any holder of this document is advised that information contained hereon reflects the Company's findings at the time of its intervention only and within the limits of Client's instructions, if any. The Company's sole responsibility is to its Client and this document does not exonerate parties to a transaction from exercising all their rights and obligations under the transaction documents. This document cannot be reproduced except in full, without prior written approval of the Company. Any unauthorized alteration, forgery or falsification of the content or appearance of this document is unlawful and offenders may be prosecuted to the fullest extent of the law. Unless otherwise stated the results shown in this test report refer only to the sample(s) tested and such sample(s) are retained for 30 days only.
Attention: To check the authenticity of testing / inspection report & certificate, please contact us at telephone: (86-755) 8307 1443, or email: CN.Doccheck@sgs.com



Test Equipment	Manufacturer	Model No.	Inventory No.	Cal. Date (yyyy-mm-dd)	Cal. Due date (yyyy-mm-dd)
3m Semi-Anechoic Chamber	AUDIX	N/A	SEM001-00	2018/3/13	2021/3/12
Wideband Radio Communication Tester	Anristu	MT8821C	6.201E+09	2019/4/3	2020/4/3
Wideband Radio Communication Tester	Rohde & Schwarz	CMW500	W005-02	2020/1/3	2021/1/2
EXA Signal Analyzer (10Hz-26.5GHz)	Agilent Technologies Inc	N9010A	SEM004-09	2019/3/13	2020/3/12
Spectrum Analyzer (20Hz-43GHz)	Rohde & Schwarz	FSU43	SEM004-08	2019/12/22	2020/12/21
BiConiLog Antenna (26-3000MHz)	ETS-Lindgren	3142C	SEM003-04	2017/6/27	2020/6/26
Horn Antenna (800MHz-18GHz)	Rohde & Schwarz	HF907	SEM003-07	2018/4/13	2021/4/12
Horn Antenna (15-40GHz)	Schwarzbeck	BBHA 9170	SEM003-15	2017/10/17	2020/10/16
Amplifier (0.1-1300MHz)	HP	8447D	SEM005-02	2019/7/25	2020/7/24
Pre-Amplifier (0.1-26.5GHz)	Compliance Directions Systems Inc.	PAP-0126	SEM004-11	2019/7/25	2020/7/24
Pre-amplifier (26-40GHz)	Compliance Directions Systems Inc.	PAP-2640-50	SEM005-08	2019/12/22	2020/12/21
Band filter	N/A	N/A	N/A	N/A	N/A
Coaxial Cable	SGS	N/A	SEM026-01	2019/6/12	2020/6/11
Tunable Notch Filter WRCD1700/2000-0.2/40-10EEK	WAINRIGHT Instruments GMBH	N/A	N/A	N/A	N/A
Tunable Notch Filter WRCD800/960-0.2/40-10EEK	WAINRIGHT Instruments GMBH	N/A	N/A	N/A	N/A
HighPass Filter WHK1.2/15G-10SS	WAINRIGHT Instruments GMBH	N/A	N/A	N/A	N/A
HighPass Filter WHKX10-2700-3000-18000-40SS	WAINRIGHT Instruments GMBH	N/A	N/A	N/A	N/A
HighPass Filter WHKX7.0/26.5G-6SS	WAINRIGHT Instruments GMBH	N/A	N/A	N/A	N/A
Band Reject Filter WRCG 824/849-814/859-40/8SS	WAINRIGHT Instruments GMBH	N/A	N/A	N/A	N/A
Band Reject Filter WRCG 1850/1910-1835/1925-40/8SS	WAINRIGHT Instruments GMBH	N/A	N/A	N/A	N/A



Unless otherwise agreed in writing, this document is issued by the Company subject to its General Conditions of Service printed overleaf, available on request or accessible at <http://www.sgs.com/en/Terms-and-Conditions.aspx> and, for electronic format documents, subject to Terms and Conditions for Electronic Documents at <http://www.sgs.com/en/Terms-and-Conditions/Terms-e-Document.aspx>. Attention is drawn to the limitation of liability, indemnification and jurisdiction issues defined therein. Any holder of this document is advised that information contained hereon reflects the Company's findings at the time of its intervention only and within the limits of Client's instructions, if any. The Company's sole responsibility is to its Client and this document does not exonerate parties to a transaction from exercising all their rights and obligations under the transaction documents. This document cannot be reproduced except in full, without prior written approval of the Company. Any unauthorized alteration, forgery or falsification of the content or appearance of this document is unlawful and offenders may be prosecuted to the fullest extent of the law. Unless otherwise stated the results shown in this test report refer only to the sample(s) tested and such sample(s) are retained for 30 days only.

Attention: To check the authenticity of testing /inspection report & certificate, please contact us at telephone: (86-755) 8307 1443, or email: CN.Doccheck@sgs.com



6 Measurement Uncertainty

For a 95% confidence level ($k = 2$), the measurement expanded uncertainties for defined systems, in accordance with the recommendations of ISO 17025 as following:

Test Item	Extended Uncertainty	Data
Transmit Output Power Data	Power [dBm]	$U = \pm 0.37$ dB
Bandwidth	Magnitude [%]	$U = \pm 0.2\%$
Band Edge Compliance	Disturbance Power [dBm]	$U = \pm 2.0$ dB
Spurious Emissions, Conducted	Disturbance Power [dBm]	$U = \pm 2.0$ dB
Field Strength of Spurious Radiation	ERP[dBm]/EIRP [dBm]	For 3 m Chamber: $U = \pm 4.5$ dB (30 MHz to 1GHz) $U = \pm 3.3$ dB (above 1 GHz) For 10 m Chamber: $U = \pm 4.5$ dB (30 MHz to 1GHz) $U = \pm 3.2$ dB (above 1 GHz)
Frequency Stability	Frequency Accuracy [ppm]	$U = \pm 0.24$ ppm

7 Appendixes

Appendix A	Photographs of Set-Up for ZR/2019/C0026
Appendix B.1	GSM850 & GSM1900
Appendix B.2	WCDMA Band II & IV & V
Appendix B.3	LTE Band 2
Appendix B.4	LTE Band 4
Appendix B.5	LTE Band 5
Appendix B.6	LTE Band 7
Appendix B.7	LTE Band 12
Appendix B.8	LTE Band 17
Appendix B.9	LTE Band 26 (814-824)
Appendix B.10	LTE Band 26 (824-849)
Appendix B.11	LTE Band 38
Appendix B.12	LTE Band 41
Appendix B.13	LTE Band 66
Appendix B.14	LTE CA_7C
Appendix B.15	LTE CA_38C
Appendix B.16	LTE CA_41C

The End



Unless otherwise agreed in writing, this document is issued by the Company subject to its General Conditions of Service printed overleaf, available on request or accessible at <http://www.sgs.com/en/Terms-and-Conditions.aspx> and, for electronic format documents, subject to Terms and Conditions for Electronic Documents at <http://www.sgs.com/en/Terms-and-Conditions/Terms-e-Document.aspx>. Attention is drawn to the limitation of liability, indemnification and jurisdiction issues defined therein. Any holder of this document is advised that information contained hereon reflects the Company's findings at the time of its intervention only and within the limits of Client's instructions, if any. The Company's sole responsibility is to its Client and this document does not exonerate parties to a transaction from exercising all their rights and obligations under the transaction documents. This document cannot be reproduced except in full, without prior written approval of the Company. Any unauthorized alteration, forgery or falsification of the content or appearance of this document is unlawful and offenders may be prosecuted to the fullest extent of the law. Unless otherwise stated the results shown in this test report refer only to the sample(s) tested and such sample(s) are retained for 30 days only.
Attention: To check the authenticity of testing / inspection report & certificate, please contact us at telephone: (86-755) 8307 1443, or email: CN.Doccheck@sgs.com