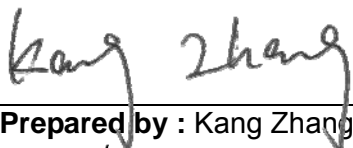
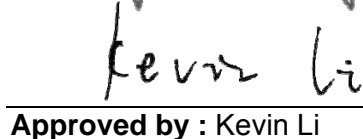

# FCC EMC Test Report

**Project No.** : 1909C106  
**Equipment** : Mobile Phone  
**Brand Name** : OPPO  
**Test Model** : CPH1941  
**Series Model** : N/A  
**Applicant** : GuangDong Oppo Mobile Telecommunications Corp., Ltd.  
**Address** : NO. 18 HaiBin Road, WuSha village, Chang An Town, DongGuan City,Guangdong,China.  
**Manufacturer** : GuangDong Oppo Mobile Telecommunications Corp., Ltd.  
**Address** : NO. 18 HaiBin Road, WuSha village, Chang An Town, DongGuan City,Guangdong,China.  
**Factory** : GuangDong Oppo Mobile Telecommunications Corp., Ltd.  
**Address** : NO. 18 HaiBin Road, WuSha village, Chang An Town, DongGuan City,Guangdong,China.  
**Date of Receipt** : Sep. 19, 2019  
**Date of Test** : Sep. 21, 2019 ~ Sep. 30, 2019  
**Issued Date** : Oct. 24, 2019  
**Report Version** : R00  
**Test Sample** : Engineering Sample No.: DG2019091946  
**Standard(s)** : FCC Part 15, Subpart B

The above equipment has been tested and found compliance with the requirement of the relative standards by BTL Inc.

  
Prepared by : Kang Zhang

  
Approved by : Kevin Li



Certificate #5123.02

Add: No.3, Jinshagang 1st Road, Shixia, Dalang Town,Dongguan, Guangdong, China.

Tel: +86-769-8318-3000

Web: [www.newbtl.com](http://www.newbtl.com)

**Declaration**

**BTL** represents to the client that testing is done in accordance with standard procedures as applicable and that test instruments used has been calibrated with standards traceable to international standard(s) and/or national standard(s).

**BTL's** reports apply only to the specific samples tested under conditions. It is manufacture's responsibility to ensure that additional production units of this model are manufactured with the identical electrical and mechanical components. **BTL** shall have no liability for any declarations, inferences or generalizations drawn by the client or others from **BTL** issued reports.

The report must not be used by the client to claim product certification, approval, or endorsement by NIST, A2LA, or any agency of the U.S. Government.

This report is the confidential property of the client. As a mutual protection to the clients, the public and ourselves, the test report shall not be reproduced, except in full, without our written approval.

**BTL's** laboratory quality assurance procedures are in compliance with the **ISO/IEC 17025** requirements, and accredited by the conformity assessment authorities listed in this test report.

**BTL** is not responsible for the sampling stage, so the results only apply to the sample as received.

The information, data and test plan are provided by manufacturer which may affect the validity of results, so it is manufacturer's responsibility to ensure that the apparatus meets the essential requirements of applied standards and in all the possible configurations as representative of its intended use.

**Limitation**

For the use of the authority's logo is limited unless the Test Standard(s)/Scope(s)/Item(s) mentioned in this test report is (are) included in the conformity assessment authorities acceptance respective.

Please note that the measurement uncertainty is provided for informational purpose only and are not use in determining the Pass/Fail results.

<b>Table of Contents</b>	<b>Page</b>
<b>REPORT ISSUED HISTORY</b>	<b>4</b>
<b>1 . SUMMARY OF TEST RESULTS</b>	<b>5</b>
1.1 TEST FACILITY	6
1.2 MEASUREMENT UNCERTAINTY	6
1.3 TEST ENVIRONMENT CONDITIONS	6
<b>2 . GENERAL INFORMATION</b>	<b>7</b>
2.1 GENERAL DESCRIPTION OF EUT	7
2.2 DESCRIPTION OF TEST MODES	8
2.3 EUT OPERATING CONDITIONS	10
2.4 BLOCK DIAGRAM SHOWING THE CONFIGURATION OF SYSTEM TESTED	10
2.5 DESCRIPTION OF SUPPORT UNITS	12
<b>3 . EMC EMISSION TEST</b>	<b>13</b>
3.1 AC POWER LINE CONDUCTED EMISSIONS TEST	13
3.1.2 MEASUREMENT INSTRUMENTS LIST	13
3.1.3 TEST PROCEDURE	14
3.1.4 DEVIATION FROM TEST STANDARD	14
3.1.5 TEST SETUP	14
3.1.6 TEST RESULTS	14
3.2 RADIATED EMISSIONS 30 MHZ TO 1 GHZ	17
3.2.1 LIMIT	17
3.2.2 MEASUREMENT INSTRUMENTS LIST	17
3.2.3 TEST PROCEDURE	18
3.2.4 DEVIATION FROM TEST STANDARD	18
3.2.5 TEST SETUP	18
3.2.6 TEST RESULTS	18
3.3 RADIATED EMISSIONS ABOVE 1 GHZ	21
3.3.1 LIMIT	21
3.3.2 MEASUREMENT INSTRUMENTS LIST	22
3.3.3 TEST PROCEDURE	23
3.3.4 DEVIATION FROM TEST STANDARD	23
3.3.5 TEST SETUP	24
3.3.6 TEST RESULTS	25
<b>4 . EUT TEST PHOTO</b>	<b>34</b>

**REPORT ISSUED HISTORY**

Report Version	Description	Issued Date
R00	Original Issue.	Oct. 24, 2019

**1. SUMMARY OF TEST RESULTS**

Emission		
Ref Standard(s)	Test Item	Result
ANSI C63.4-2014	AC Power Line Conducted Emissions	PASS
	Radiated Emissions 30 MHz to 1 GHz	PASS
	Radiated Emissions Above 1 GHz	PASS

### 1.1 TEST FACILITY

The test facilities used to collect the test data in this report at the location of No.3, Jinshagang 1st Road, Shixia, Dalang Town, Dongguan, Guangdong, China.

BTL's Test Firm Registration Number for FCC: 357015

BTL's Designation Number for FCC: CN1240

### 1.2 MEASUREMENT UNCERTAINTY

ISO/IEC 17025 requires that an estimate of the measurement uncertainties associated with the emissions test results be included in the report. The measurement uncertainties given below are based on a 95% confidence level (based on a coverage factor (k=2))

The BTL measurement uncertainty as below table:

#### A. AC power line conducted emissions test:

Test Site	Method	Measurement Frequency Range	U,(dB)
DG-C02	CISPR	150 kHz ~ 30MHz	2.32

#### B. Radiated emissions test:

Test Site	Method	Measurement Frequency Range	Ant. H / V	U,(dB)
DG-CB08 (3m)	CISPR	30MHz ~ 200MHz	V	3.76
		30MHz ~ 200MHz	H	3.56
		200MHz ~ 1,000MHz	V	4.00
		200MHz ~ 1,000MHz	H	3.90

Test Site	Method	Measurement Frequency Range	U,(dB)
DG-CB08 (3m)	CISPR	1GHz ~ 6GHz	4.02
		6GHz ~ 18GHz	5.10

Test Site	Method	Measurement Frequency Range	U,(dB)
DG-CB08 (1m)	CISPR	18 ~ 26.5 GHz	3.82
		26.5 ~ 40 GHz	3.90

Note: Unless specifically mentioned, the uncertainty of measurement has not been taken into account to declare the compliance or non-compliance to the specification.

### 1.3 TEST ENVIRONMENT CONDITIONS

Test Item	Temperature	Humidity	Tested By
AC Power Line Conducted Emissions	25°C	53%	Lorry Lao
Radiated emissions 30 MHz to 1 GHz	25°C	60%	Kwok Guo
Radiated emissions above 1 GHz	25°C	60%	Kwok Guo

## 2. GENERAL INFORMATION

### 2.1 GENERAL DESCRIPTION OF EUT

Equipment	Mobile Phone
Brand Name	OPPO
Test Model	CPH1941
Series Model	N/A
Model Difference(s)	N/A
Hardware Version	ColorOS V6.0.1
Software Version	TBD
Power Source	<ol style="list-style-type: none"> <li>DC Voltage supplied from AC/DC adapter.            1# Model: OP52KAUH            2# Model: OP52JAUH            3# Model: OP52YAUH</li> <li>Supplied from Li-ion Polymer battery.            1# Factory / Model: NVT / BLP727 (NA-P727-92)            2# Factory / Model: Desay / BLP727 (DA-P727-923)            3# Factory / Model: Sunwoda / BLP727 (XA-P727-922)            4# Factory / Model: Desay / BLP727 (DD-P727-918)            5# Factory / Model: Desay / BLP727 (DA-P727-931)</li> <li>Supplied from USB port.</li> </ol>
Power Rating	<ol style="list-style-type: none"> <li>I/P:100-240V~ 50/60Hz 0.4A    O/P:5V<math>\overline{\text{---}}</math>2A</li> <li>3.87Vdc, 5000mAh/19.35Wh</li> <li>DC 5V</li> </ol>
Connecting I/O Port(s)	<ol style="list-style-type: none"> <li>1* Earphone port</li> <li>1* Type-C port</li> </ol>
Classification of EUT	Class B
Highest Internal Frequency(Fx)	5825 MHz

Note:

- For a more detailed features description, please refer to the manufacturer's specifications or the user's manual.

## 2.2 DESCRIPTION OF TEST MODES

To investigate the maximum EMI emission characteristics generated from EUT, the test system was pre-scanning tested based on the consideration of following EUT operation mode or test configuration mode which possibly have effect on EMI emission level. Each of these EUT operation mode(s) or test configuration mode(s) mentioned above was evaluated respectively.

Pretest Mode	Description
Mode 1	Adapter+ Idle+Playing+Speaker
Mode 2	Adapter+ Idle+Playing+earphone
Mode 3	Adapter+Idle+2.4G WIFI+BT+GPS+NFC+Camera on(Front)
Mode 4	Adapter+Idle+2.4G WIFI+BT+GPS+NFC+Camera on(Rear)
Mode 5	Adapter+Idle+5G WIFI+BT+GPS+NFC+Camera on(Front)
Mode 6	Adapter+Traffic(GSM)(GSM850.900.1800.1900)
Mode 7	Adapter+Traffic(WCDMA)(BAND1.2.4.5.6.8.19)
Mode 8	Adapter+Traffic(LTE)(BAND1.2.3.4.5.7.8.18.19.20.26.28.38.39.40.41)
Mode 9	FM 88MHz
Mode 10	FM 98MHz
Mode 11	FM 108MHz
Mode 12	USB Copy + Idle

### AC Power Line Conducted Emissions test

Final Test Mode	Description
Mode 5	Adapter+Idle+5G WIFI+BT+GPS+NFC+Camera on(Front)

### Radiated Emissions 30 MHz to 1 GHz test

Final Test Mode	Description
Mode 5	Adapter+Idle+5G WIFI+BT+GPS+NFC+Camera on(Front)

### Radiated emissions above 1 GHz test

Final Test Mode	Description
Mode 5	Adapter+Idle+5G WIFI+BT+GPS+NFC+Camera on(Front)



Item	Model	Factory/SN	config1	config2	config3	config4	config5
Adapter	OP52KAUH	/	V				
	OP52YAUH	/		V			
	OP52JAUH	/			V	V	V
USB Cable	/	/	V	V	V	V	V
Battery	BLP727	Desay /DA-P2727-923	V				
	BLP727	Sunwoda /XA-P727-922		V			
	BLP727	NVT/NA-P2727-92			V		
	BLP727	Desay /DD-P727-918				V	
	BLP727	Desay /DA-P727-931					V
Earphone	/	/	V	V	V	V	V

Evaluation description:

1. Mode 1: Tested config1-5. Config 1 is the worst case and tested Mode 2-11.
2. Mode 12 tested config 1-5.
3. Config1 with Mode 5 is the worst case and recorded in this report.

Note:

1. The product support BT function, the frequency of exemption is 2402- 2480MHz.
2. The frequency of 2.4G WIFI exemption is 2412-2472MHz.
3. The frequency of 5G WIFI exemption is 5180-5825MHz.

### 2.3 EUT OPERATING CONDITIONS

The EUT exercise program used during radiated and/or conducted emission measurement was designed to exercise the various system components in a manner similar to a typical use. The standard test signals and output signal as following:

Mode 1-11:

1. EUT connected to earphone via earphone cable.
2. EUT connected to adapter via USB cable.
3. EUT connected to router via WIFI function.
4. EUT connected to BT earphone via BT function.
5. EUT connected to wireless communication test SET via radio signal.
6. EUT connected to signal generator via radio signal.
7. EUT connected to wideband radio communication tester via radio signal.
8. EUT connected to FM STEREO FM-AM signal generator via FM function.

Mode 12:

1. EUT connected to PC via USB cable.
2. PC connected to keyboard and mouse via USB cable.
3. PC connected to monitor via HDMI cable.
4. PC connected to printer via parallel cable.
5. PC connected to modem via RS232 cable.

### 2.4 BLOCK DIAGRAM SHOWING THE CONFIGURATION OF SYSTEM TESTED

Mode 1-11

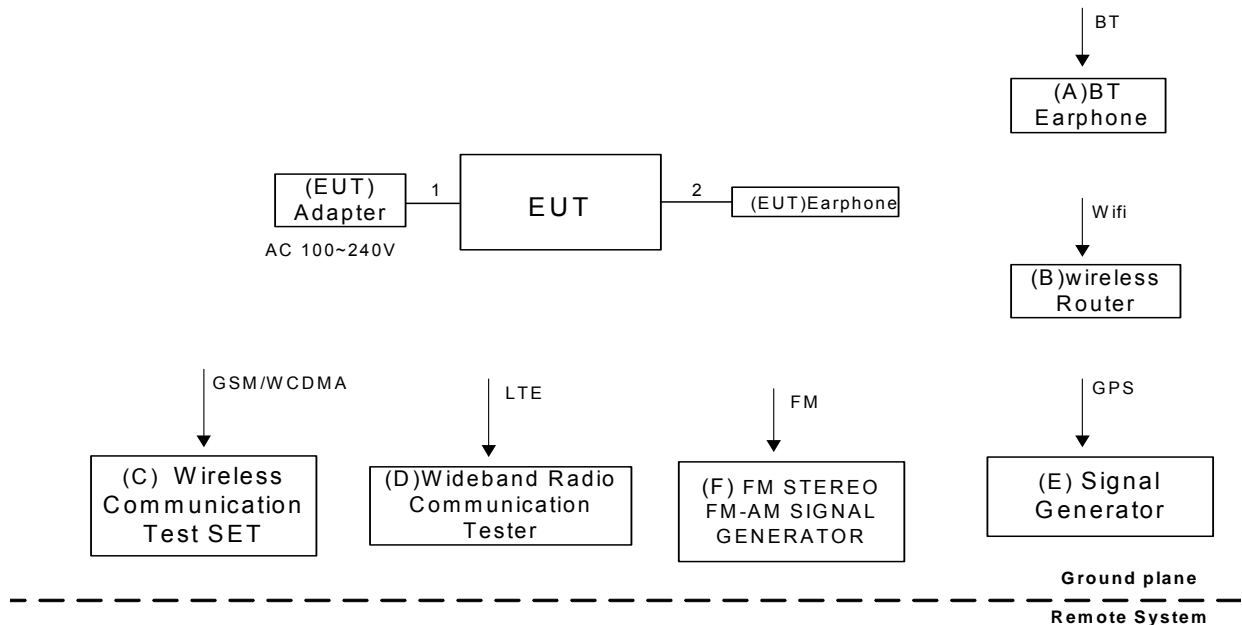

## Mode 12

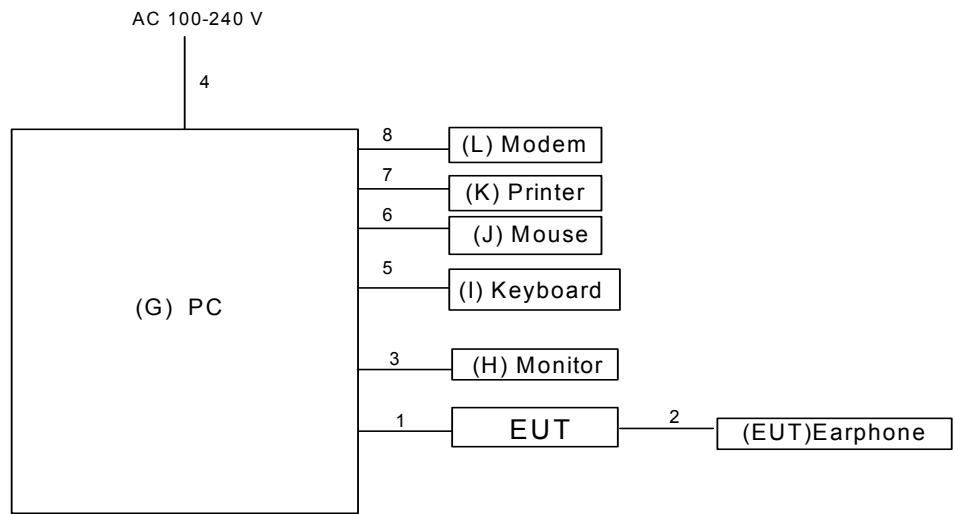

----- Ground plane -----  
Remote System

## 2.5 DESCRIPTION OF SUPPORT UNITS

The EUT has been tested as an independent unit together with other necessary accessories or support units. The following support units or accessories were used to form a representative test configuration during the tests.

Item	Equipment	Mfr/Brand	Model/Type No.	Series No.
A	BT earphone	MICROKIA	M9	N/A
B	wireless router	ASUS	RT-AC66U	E8ICGG000138
C	Wireless Communication Test SET	Agilent	(8960 Series) E5515C	MY48364183
D	Wideband Radio Communication Tester	RS	CMW500	122125
E	Signal Generator	Agilent	E4438C	MY49071316
F	FM STEREO FM-AM SIGNAL GENERATOR	KENWOOD	SG-5110	HR1010099
G	PC	Dell 745	DCSM	G7K832X
H	Monitor	PHILIPS	241P6V	UHBA1633026326
I	Keyboard	Dell	L100	CNORH6596589071T08NE
J	Mouse	Dell	MO56UOA	FQJ000BS
K	Printer	SII	DPU-414	3018507 B
L	Modem	ACEEX	DM-1414V	0603002131

Item	Cable Type	Shielded Type	Ferrite Core	Length
1	USB Cable	YES	NO	1m
2	Earphone Cable	NO	NO	1m
3	HDMI Cable	YES	NO	1.8m
4	AC Cable	NO	NO	1.8m
5	USB Cable	YES	NO	1.8m
6	USB Cable	YES	NO	1.8m
7	Parallel cable	YES	NO	1.8m
8	RS232 cable	YES	NO	1.8m

### 3. EMC EMISSION TEST

#### 3.1 AC POWER LINE CONDUCTED EMISSIONS TEST

##### 3.1.1 LIMIT

Frequency of Emission (MHz)	Class B (dBuV)	
	Quasi-peak	Average
0.15 - 0.5	66 - 56 *	56 - 46 *
0.5 - 5.0	56.00	46.00
5.0 - 30.0	60.00	50.00

Note:

- (1) The tighter limit applies at the band edges.
- (2) The limit of " \* " marked band means the limitation decreases linearly with the logarithm of the frequency in the range.
- (3) The test result calculated as following:  
 Measurement Value = Reading Level + Correct Factor  
 Correct Factor = Insertion Loss + Cable Loss + Attenuator Factor(if use)  
 Margin Level = Measurement Value - Limit Value

##### 3.1.2 MEASUREMENT INSTRUMENTS LIST

Item	Kind of Equipment	Manufacturer	Type No.	Serial No.	Calibrated until
1	EMI Test Receiver	R&S	ESCI	100382	Mar. 10, 2020
2	LISN	EMCO	3816/2	52765	Mar. 10, 2020
3	TWO-LINE V-NETWORK	R&S	ENV216	101447	May. 19, 2020
4	50Ω Terminator	SHX	TF5-3	15041305	Mar. 10, 2020
5	Measurement Software	Farad	EZ-EMC Ver.NB-03A1 -01	N/A	N/A
6	Cable	N/A	RG223	12m	Mar. 12, 2020

Remark: "N/A" denotes no model name, serial no. or calibration specified.  
 All calibration period of equipment list is one year.

### 3.1.3 TEST PROCEDURE

- a. The EUT was placed 0.8 meters from the horizontal ground plane with EUT being connected to the power mains through a line impedance stabilization network (LISN). All other support equipment powered from additional LISN(s). The LISN provide 50 Ohm/ 50uH of coupling impedance for the measuring instrument.
- b. Interconnecting cables that hang closer than 40 cm to the ground plane shall be folded back and forth in the center forming a bundle 30 to 40 cm long.
- c. I/O cables that are not connected to a peripheral shall be bundled in the center. The end of the cable may be terminated, if required, using the correct terminating impedance. The overall length shall not exceed 1 m.
- d. LISN at least 80 cm from nearest part of EUT chassis.
- e. For the actual test configuration, please refer to the related Item –EUT Test Photos.
- f. Measuring frequency range from 150KHz to 30MHz.

### 3.1.4 DEVIATION FROM TEST STANDARD

No deviation

### 3.1.5 TEST SETUP

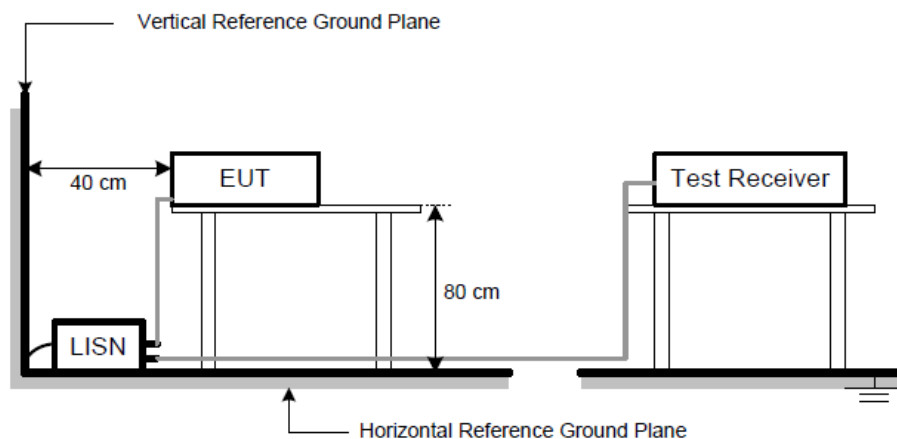

### 3.1.6 TEST RESULTS

Remark:

- (1) Reading in which marked as QP means measurements by using are Quasi-Peak Mode with Detector BW=9 kHz; SPA setting in RBW=10 kHz, VBW =10 kHz, Swp. Time = 0.3 sec./MHz. Reading in which marked as AV means measurements by using are Average Mode with instrument setting in RBW=10 kHz, VBW=10 kHz, Swp. Time =0.3 sec./MHz.
- (2) All readings are QP Mode value unless otherwise stated AVG in column of 『Note』. If the QP Mode Measured value compliance with the QP Limits and lower than AVG Limits, the EUT shall be deemed to meet both QP & AVG Limits and then only QP Mode was measured, but AVG Mode didn't perform. In this case, a “\*” marked in AVG Mode column of Interference Voltage Measured.

Test Voltage	AC 120V/60Hz	Phase	Line
Test Mode	Mode 5(Config1)		

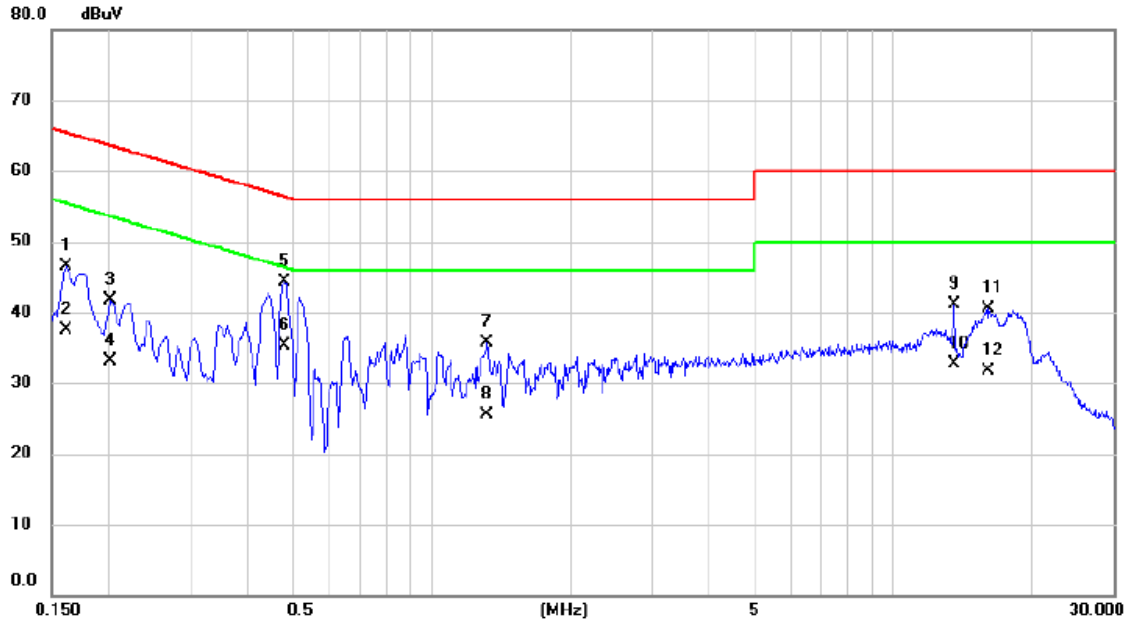

No. Mk.	Freq. MHz	Reading Level dBuV	Correct Factor dB	Measurement dBuV	Limit dBuV	Margin dB	Detector	Comment
1	0.1612	36.91	9.57	46.48	65.40	-18.92	QP	
2	0.1612	27.90	9.57	37.47	55.40	-17.93	AVG	
3	0.2017	32.22	9.56	41.78	63.54	-21.76	QP	
4	0.2017	23.60	9.56	33.16	53.54	-20.38	AVG	
5	0.4807	34.68	9.57	44.25	56.33	-12.08	QP	
6 *	0.4807	25.80	9.57	35.37	46.33	-10.96	AVG	
7	1.3200	25.97	9.64	35.61	56.00	-20.39	QP	
8	1.3200	15.80	9.64	25.44	46.00	-20.56	AVG	
9	13.5600	30.83	10.32	41.15	60.00	-18.85	QP	
10	13.5600	22.40	10.32	32.72	50.00	-17.28	AVG	
11	16.0890	29.99	10.47	40.46	60.00	-19.54	QP	
12	16.0890	21.30	10.47	31.77	50.00	-18.23	AVG	

Test Voltage	AC 120V/60Hz	Phase	Neutral
Test Mode	Mode 5(Config1)		

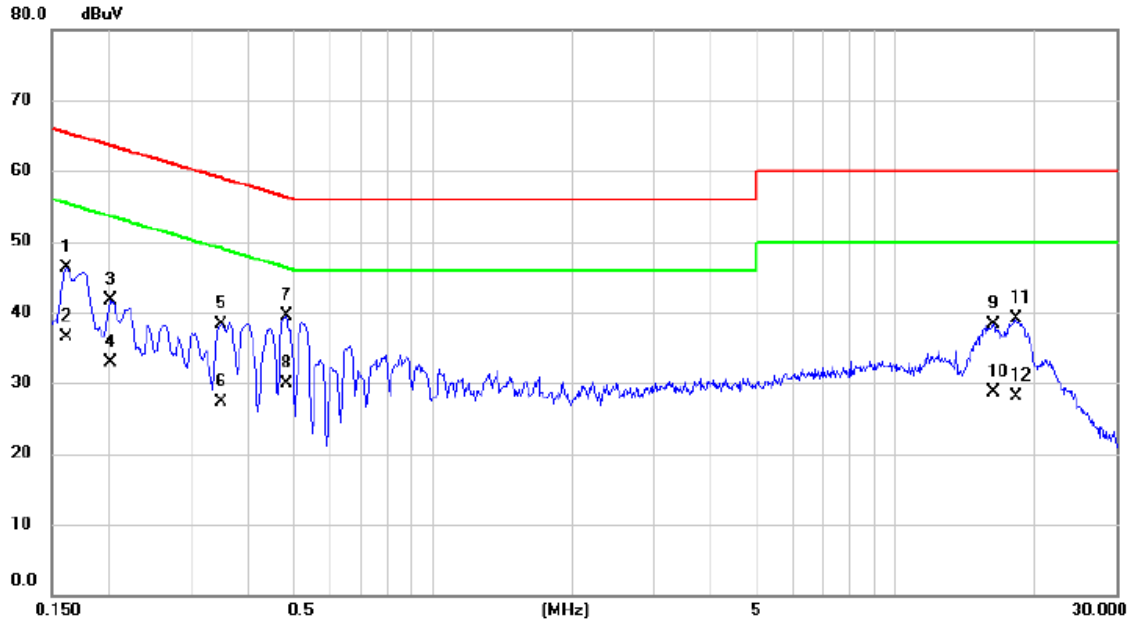

No.	Mk.	Freq. MHz	Reading Level dBuV	Correct Factor dB	Measure- ment dBuV	Limit dBuV	Margin dB	Detector	Comment
1		0.1613	36.84	9.54	46.38	65.40	-19.02	QP	
2		0.1613	26.90	9.54	36.44	55.40	-18.96	AVG	
3		0.2017	32.15	9.54	41.69	63.54	-21.85	QP	
4		0.2017	23.40	9.54	32.94	53.54	-20.60	AVG	
5		0.3480	28.84	9.54	38.38	59.01	-20.63	QP	
6		0.3480	17.80	9.54	27.34	49.01	-21.67	AVG	
7		0.4830	29.99	9.56	39.55	56.29	-16.74	QP	
8	*	0.4830	20.30	9.56	29.86	46.29	-16.43	AVG	
9		16.3005	27.84	10.52	38.36	60.00	-21.64	QP	
10		16.3005	18.20	10.52	28.72	50.00	-21.28	AVG	
11		18.2265	28.50	10.67	39.17	60.00	-20.83	QP	
12		18.2265	17.50	10.67	28.17	50.00	-21.83	AVG	



### 3.2 RADIATED EMISSIONS 30 MHZ TO 1 GHZ

#### 3.2.1 LIMIT

Frequency (MHz)	Class B (at 3m)	
	( $\mu\text{V/m}$ ) Field strength	(dB $\mu\text{V/m}$ ) Field strength
30 - 88	100	40
88 - 216	150	43.5
216 - 960	200	46
Above 960	500	54

**NOTE:**

- (1) The tighter limit applies at the band edges.
- (2) Emission level (dB $\mu\text{V/m}$ ) = 20log Emission level ( $\mu\text{V/m}$ ).  
3m Emission level = 10m Emission level + 20log(10m/3m).
- (3) The test result calculated as following:  
Measurement Value = Reading Level + Correct Factor  
Correct Factor = Antenna Factor + Cable Loss - Amplifier Gain(if use)  
Margin Level = Measurement Value - Limit Value

#### 3.2.2 MEASUREMENT INSTRUMENTS LIST

Item	Kind of Equipment	Manufacturer	Type No.	Serial No.	Calibrated until
1	Receiver	Keysight	N9038A	MY54450004	Aug. 03, 2020
2	MXE EMI Receiver	Agilent	N9038A	MY53220133	Mar. 10, 2020
3	Pre-Amplifier	EMC INSTRUMENT	EMC 9135	980284	Mar. 10, 2020
4	Pre-Amplifier	EMC INSTRUMENT	EMC 9135	980283	Mar. 10, 2020
5	Trilog-Broadband Antenna	Schwarzbeck	VULB9168	946	Nov. 24, 2019
6	Trilog-Broadband Antenna	Schwarzbeck	VULB9168	947	Nov. 24, 2019
7	Cable	emci	LMR-400(5m+11m+15m)	N/A	Aug. 06, 2020
8	Cable	emci	LMR-400(5m+8m+8m)	N/A	Aug. 06, 2020
9	Measurement Software	Farad	EZ-EMC Ver.BTL-2ANT-1	N/A	N/A
10	Multi-Device Controller	ETS-Lindgren	2090	N/A	N/A
11	Attenuator	EMCI	EMCI-N-6-06	N0670	Nov. 24, 2019
12	Attenuator	EMCI	EMCI-N-6-06	N0671	Nov. 24, 2019

Remark: "N/A" denotes no model name, no serial no. or no calibration specified.

All calibration period of equipment list is one year.

### 3.2.3 TEST PROCEDURE

- The measuring distance of 3 m shall be used for measurements. The EUT was placed on the top of a rotating table 0.8 meter above the ground at a 10 meter semi-anechoic chamber. The table was rotated 360 degrees to determine the position of the highest radiation.
- The height of the equipment or of the substitution antenna shall be 0.8 m, the height of the test antenna shall vary between 1 m to 4 m. Both horizontal and vertical polarizations of the antenna are set to make the measurement.
- For each suspected emission, the EUT was arranged to its worst case and then the antenna was tuned to heights find the maximum reading (used Bore sight function).
- The initial step in collecting radiated emission data is a receiver peak detector mode pre-scanning the measurement frequency range. Significant peaks are then marked and then Quasi Peak detector mode re-measured.
- All readings are Peak unless otherwise stated QP in column of Note. Peak denotes that the Peak reading compliance with the QP Limits and then QP Mode measurement didn't perform.
- For the actual test configuration, please refer to the related Item - Block Diagram of system tested.

### 3.2.4 DEVIATION FROM TEST STANDARD

No deviation

### 3.2.5 TEST SETUP

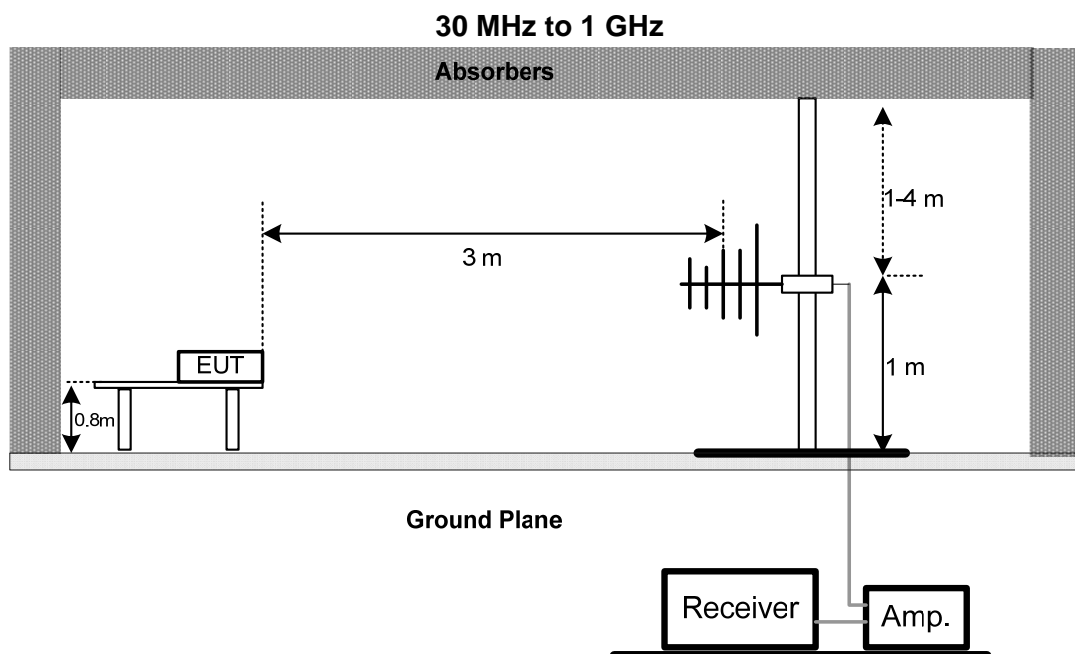

### 3.2.6 TEST RESULTS

Remark:

- Measuring frequency range from 30 MHz to 1000 MHz
- If the peak scan value lower limit more than 20 dB, then this signal data does not show in table.

Test Voltage	AC 120V/60Hz	Polarization	Vertical
Test Mode	Mode 5(Config1)		

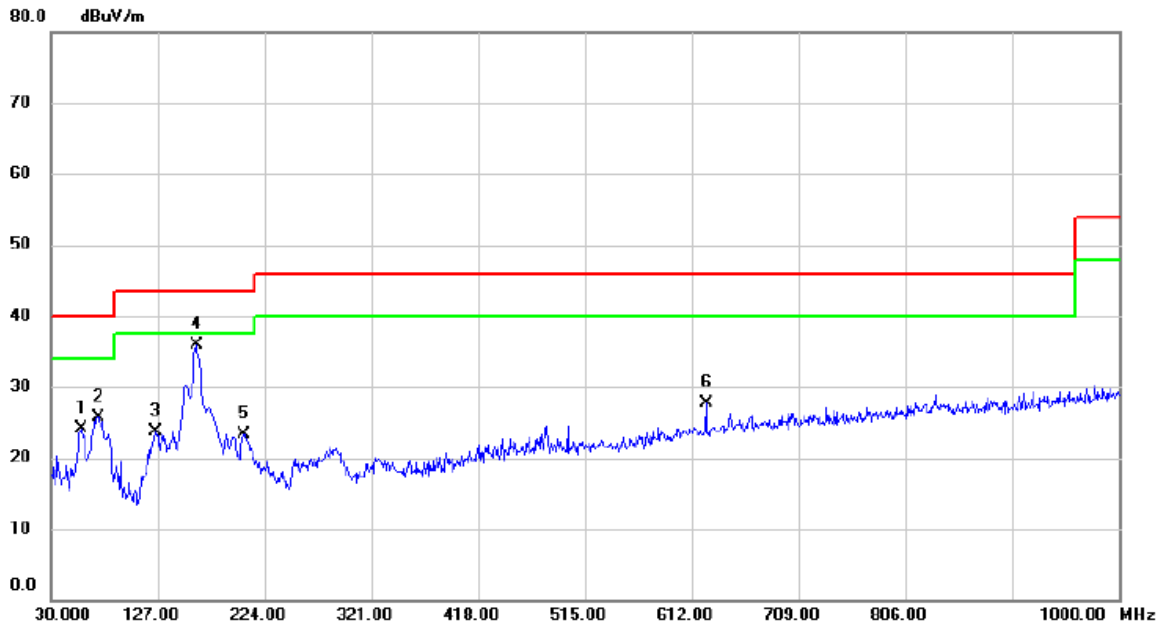

No.	Mk.	Freq. MHz	Reading Level dBuV	Correct Factor dB	Measure- ment dBuV/m	Limit dBuV/m	Margin dB	Detector	Comment
1		57.6450	38.62	-14.55	24.07	40.00	-15.93	QP	
2		73.1650	42.53	-16.81	25.72	40.00	-14.28	QP	
3		125.5450	36.75	-13.04	23.71	43.50	-19.79	QP	
4	*	162.4050	47.24	-11.34	35.90	43.50	-7.60	QP	
5		204.6000	38.72	-15.37	23.35	43.50	-20.15	QP	
6		625.0950	32.94	-5.20	27.74	46.00	-18.26	QP	

Test Voltage	AC 120V/60Hz	Polarization	Horizontal
Test Mode	Mode 5(Config1)		

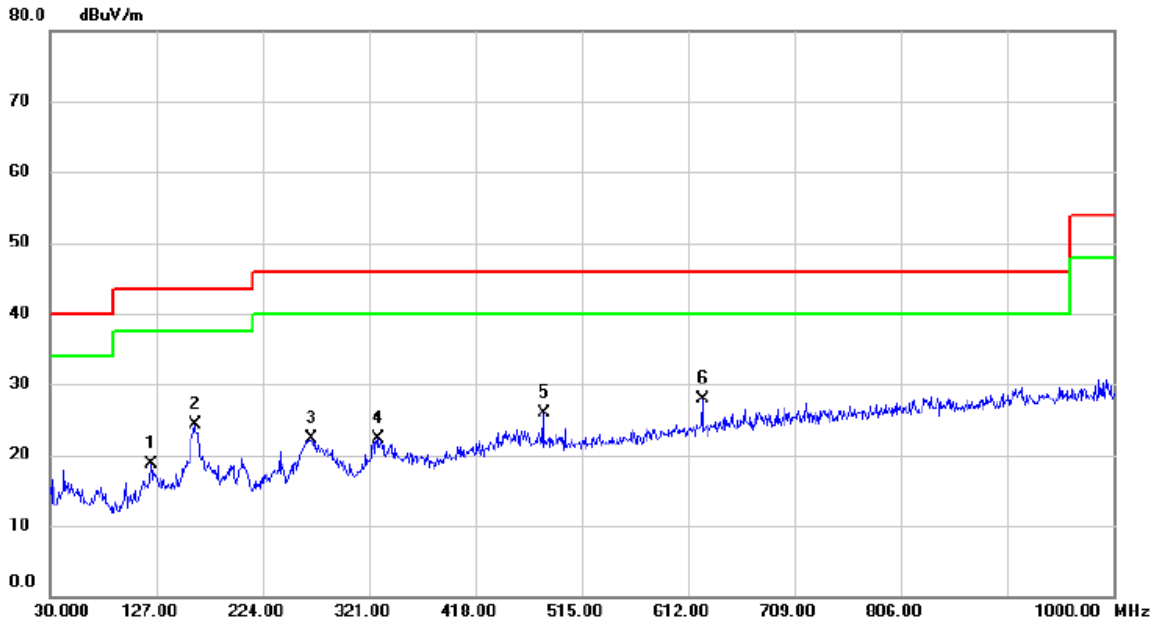

No.	Mk.	Freq. MHz	Reading Level dBuV	Correct Factor dB	Measure- ment dBuV/m	Limit dBuV/m	Margin dB	Detector	Comment
1		122.1500	31.81	-13.04	18.77	43.50	-24.73	QP	
2		162.4050	35.72	-11.34	24.38	43.50	-19.12	QP	
3		268.6200	35.37	-13.02	22.35	46.00	-23.65	QP	
4		329.7300	33.28	-11.00	22.28	46.00	-23.72	QP	
5		480.0800	33.68	-7.84	25.84	46.00	-20.16	QP	
6	*	625.0950	33.11	-5.20	27.91	46.00	-18.09	QP	

### 3.3 RADIATED EMISSIONS ABOVE 1 GHZ

#### 3.3.1 LIMIT

Frequency (MHz)	Class B	
	(dBuV/m) (at 3m)	
	Peak	Average
Above 1000	74	54

#### FREQUENCY RANGE OF RADIATED MEASUREMENT (FOR UNINTENTIONAL RADIATORS)

Highest frequency generated or Upper frequency of measurement used in the device or on which the device operates or tunes (MHz)	Range (MHz)
Below 1.705	30
1.705 - 108	1000
108 - 500	2000
500 - 1000	5000
Above 1000	5 <sup>th</sup> harmonic of the highest frequency or 40 GHz, whichever is lower

**NOTE:**

- (1) The tighter limit applies at the band edges.
- (2) Emission level (dBuV/m) = 20log Emission level (uV/m).  
3m Emission level = 10m Emission level + 20log(10m/3m).
- (3) The test result calculated as following:  
Measurement Value = Reading Level + Correct Factor  
Correct Factor = Antenna Factor + Cable Loss - Amplifier Gain(if use)  
Margin Level = Measurement Value - Limit Value

### 3.3.2 MEASUREMENT INSTRUMENTS LIST

Item	Kind of Equipment	Manufacturer	Type No.	Serial No.	Calibrated until
1	Horn Antenna	EMCO	3115	9605-4803	Mar. 23, 2020
2	Broad-Band Horn Antenna	Schwarzbeck	BBHA 9170	9170319	Jun. 23, 2020
3	Amplifier	Agilent	8449B	3008A02584	Aug. 03, 2020
4	Microwave Preamplifier With Adaptor	EMC INSTRUMENT	EMC2654045	980039 & HA01	Mar. 10, 2020
5	MXE EMI Receiver	Agilent	N9038A	MY53220133	Mar. 10, 2020
6	Measurement Software	Farad	EZ-EMC Ver.BTL-2ANT-1	N/A	N/A
7	Multi-Device Controller	ETS-Lindgren	2090	N/A	N/A
8	Controller	MF	MF-7802	MF780208159	N/A
9	Cable	emci	SUCOFLEX 102_8m(0.01GHz – 40GHz)	N/A	Mar. 26, 2020
10	Cable	Mlcable Inc.	B10-01-01-5M	18047123	Mar. 01, 2020
11	Cable	Mlcable Inc.	B10-01-01-10M	18072746	Mar. 01, 2020
12	Cable	N/A	A50-3.5M3.5M-1.5M-AT	18041824	Mar. 01, 2020

Remark: "N/A" denotes no model name, no serial no. or no calibration specified.  
 All calibration period of equipment list is one year.

### 3.3.3 TEST PROCEDURE

- a. The measuring distance of 3 m shall be used for measurements. The EUT was placed on the top of a rotating table 0.8 meter above the ground at a 10 meter semi-anechoic chamber. The table was rotated 360 degrees to determine the position of the highest radiation.

Note:

For measurement of frequency 1GHz -18GHz, the EUT was set 3 meters away from the receiver antenna. For 18G – 40GHz, the EUT was set 1 meter.

Emission level (dBuV/m)=20log Emission level (uV/m).

The limits above 18GHz shall be extrapolated to the specified distance using an extrapolation factor of 20dB/decade from 3m to 1m

Distance extrapolation factor =  $20 \log (3\text{m}/1\text{m})$  dB ;

Limit line = specific limits (dBuV) + 9.5 dB.

- b. The height of the equipment or of the substitution antenna shall be 0.8 m, the height of the test antenna shall vary between 1 m to 4 m. Both horizontal and vertical polarizations of the antenna are set to make the measurement.
- c. For each suspected emission, the EUT was arranged to its worst case and then the antenna was tuned to heights find the maximum reading (used Bore sight function).
- d. The initial step in collecting radiated emission data is a receiver peak detector mode pre-scanning the measurement frequency range. Significant peaks are then marked and then Quasi Peak detector mode re-measured.
- e. The receiver system was set to peak and average detect function and specified bandwidth with maximum hold mode when the test frequency is above 1 GHz.
- f. All readings are Peak Mode value unless otherwise stated AVG in column of Note. If the Peak Mode Measured value compliance with the Peak Limits and lower than AVG Limits, the EUT shall be deemed to meet both Peak & AVG Limits and then only Peak Mode was measured, but AVG Mode didn't perform.
- g. For the actual test configuration, please refer to the related Item - Block Diagram of system tested.

### 3.3.4 DEVIATION FROM TEST STANDARD

No deviation

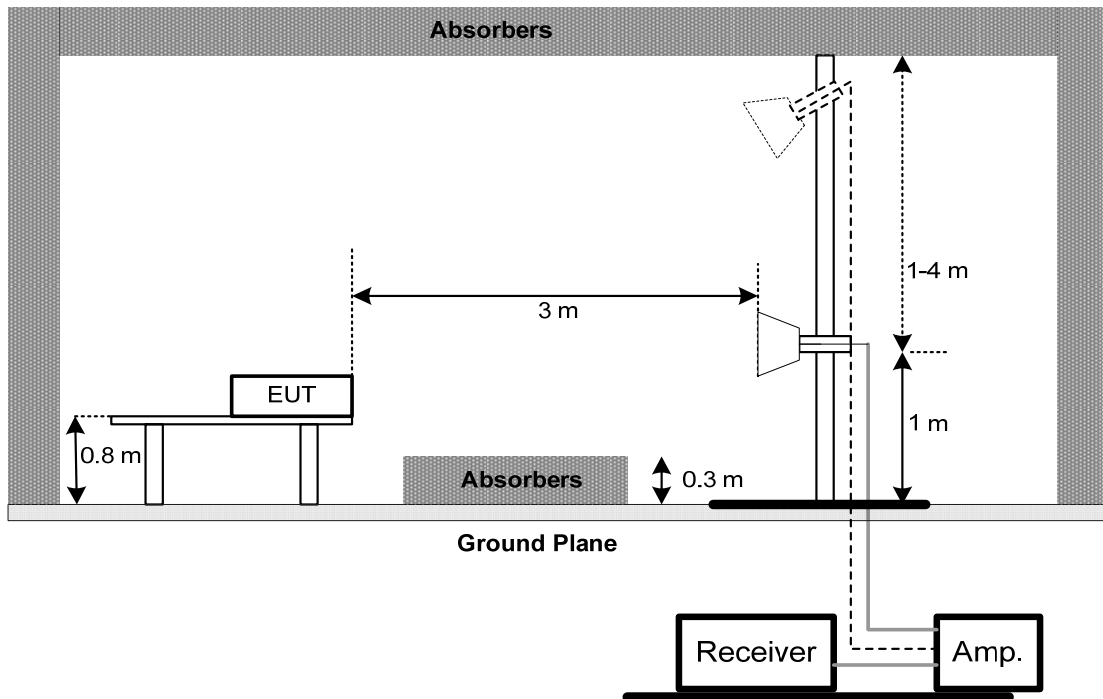
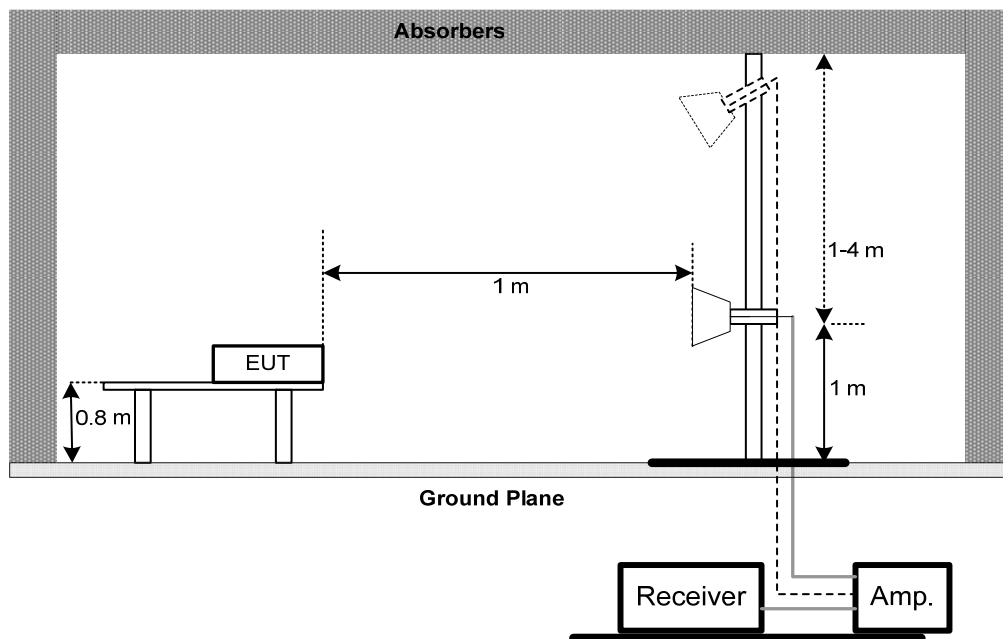
**3.3.5 TEST SETUP****1 GHz-18 GHz****18 GHz-40 GHz**



### 3.3.6 TEST RESULTS

Remark:

- (1) Radiated emissions measured in frequency range above 1000 MHz were made with an instrument using Peak detector mode and AV detector mode of the emission.
- (2) Data of measurement within this frequency range shown “ \* ” in the table above means the reading of emissions are attenuated more than 20 dB below the permissible limits or the field strength is too small to be measured.
- (3) A preamp and high pass filter were used for this test in order to provide sufficient measurement sensitivity.

Test Voltage	AC 120V/60Hz	Polarization	Vertical
Test Mode	Mode 5(Config1)		

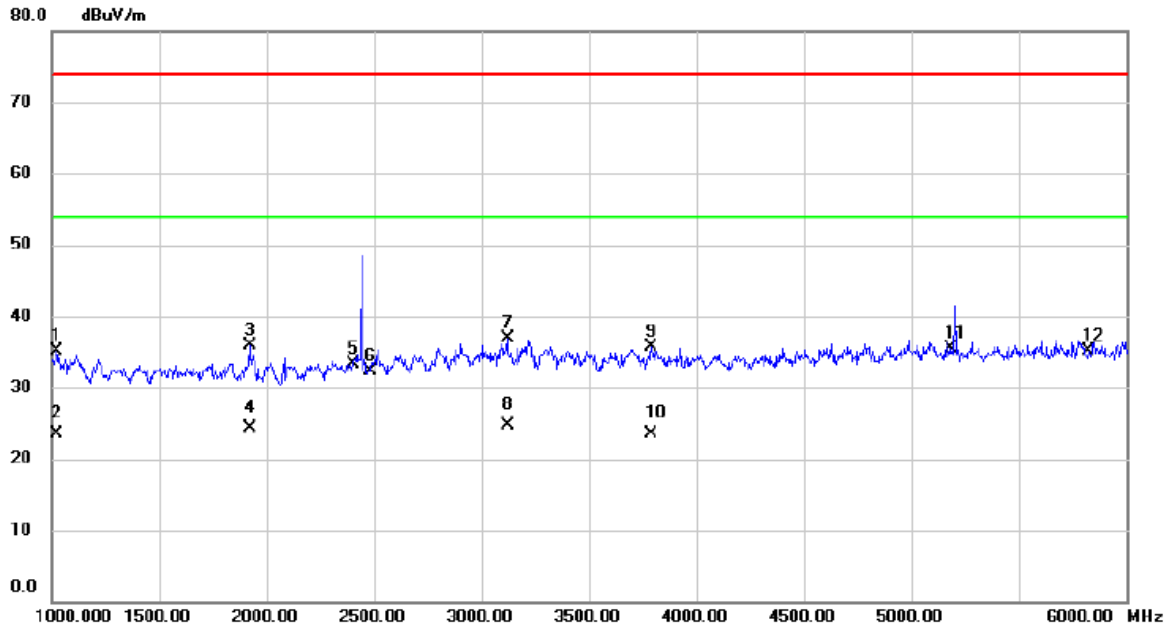

No.	Mk.	Freq. MHz	Reading Level dBuV	Correct Factor dB	Measure- ment dBuV/m	Limit dBuV/m	Margin dB	Detector	Comment
1		1020.000	41.61	-6.55	35.06	74.00	-38.94	peak	
2		1020.000	30.03	-6.55	23.48	54.00	-30.52	AVG	
3		1920.000	39.97	-4.00	35.97	74.00	-38.03	peak	
4		1920.000	28.25	-4.00	24.25	54.00	-29.75	AVG	
5		2402.000	35.74	-2.40	33.34	74.00	-40.66	peak	
6		2480.000	34.50	-2.13	32.37	74.00	-41.63	peak	
7		3120.000	36.62	0.20	36.82	74.00	-37.18	peak	
8	*	3120.000	24.52	0.20	24.72	54.00	-29.28	AVG	
9		3792.500	34.71	0.94	35.65	74.00	-38.35	peak	
10		3792.500	22.63	0.94	23.57	54.00	-30.43	AVG	
11		5180.000	30.42	5.04	35.46	74.00	-38.54	peak	
12		5825.000	29.20	5.85	35.05	74.00	-38.95	peak	

Test Voltage	AC 120V/60Hz	Polarization	Horizontal
Test Mode	Mode 5(Config1)		

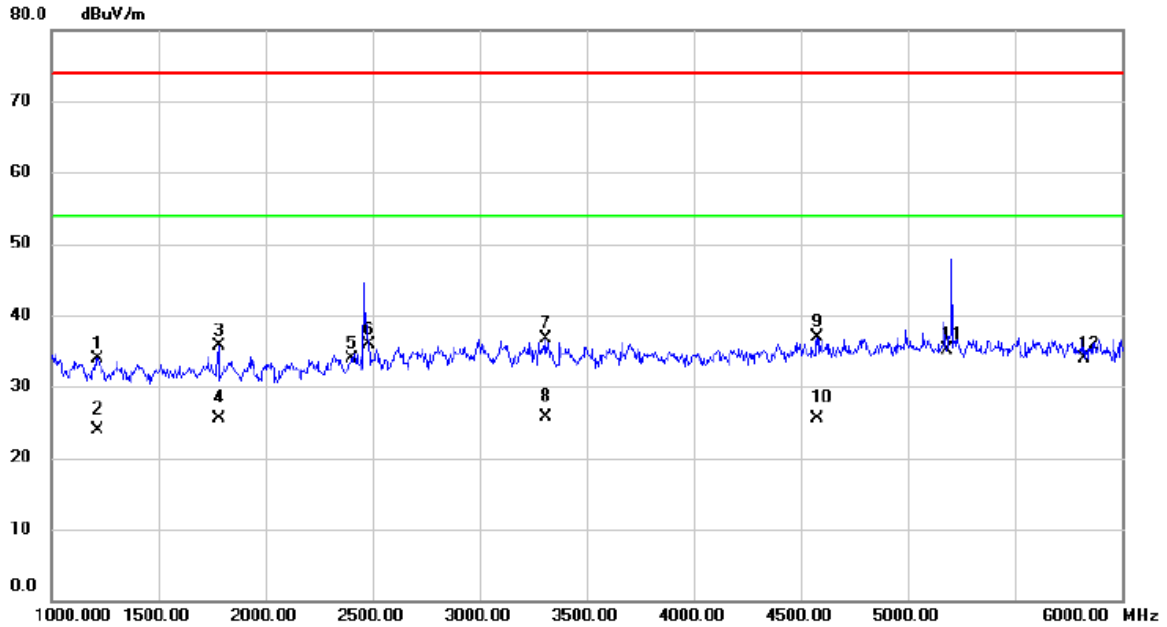

No.	Mk.	Freq. MHz	Reading Level dBuV	Correct Factor dB	Measure- ment dBuV/m	Limit dBuV/m	Margin dB	Detector	Comment
1		1215.000	40.04	-6.11	33.93	74.00	-40.07	peak	
2		1215.000	30.01	-6.11	23.90	54.00	-30.10	AVG	
3		1780.000	40.27	-4.49	35.78	74.00	-38.22	peak	
4		1780.000	30.05	-4.49	25.56	54.00	-28.44	AVG	
5		2402.000	36.22	-2.40	33.82	74.00	-40.18	peak	
6		2480.000	38.01	-2.13	35.88	74.00	-38.12	peak	
7		3307.500	36.30	0.44	36.74	74.00	-37.26	peak	
8	*	3307.500	25.25	0.44	25.69	54.00	-28.31	AVG	
9		4575.000	33.51	3.33	36.84	74.00	-37.16	peak	
10		4575.000	22.23	3.33	25.56	54.00	-28.44	AVG	
11		5180.000	30.08	5.04	35.12	74.00	-38.88	peak	
12		5825.000	27.98	5.85	33.83	74.00	-40.17	peak	

Test Voltage	AC 120V/60Hz	Polarization	Vertical
Test Mode	Mode 5(Config1)		

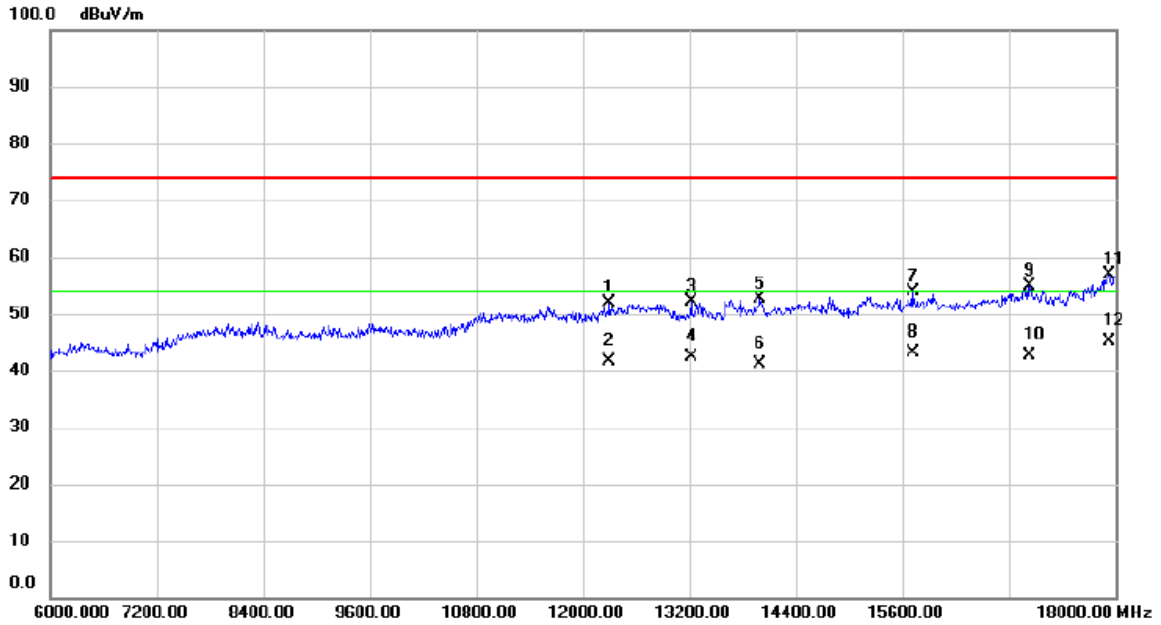

No.	Mk.	Freq. MHz	Reading Level dBuV	Correct Factor dB	Measure- ment dBuV/m	Limit dBuV/m	Margin dB	Detector	Comment
1		12300.00	30.47	21.40	51.87	74.00	-22.13	peak	
2		12300.00	20.20	21.40	41.60	54.00	-12.40	AVG	
3		13218.00	28.02	24.03	52.05	74.00	-21.95	peak	
4		13218.00	18.33	24.03	42.36	54.00	-11.64	AVG	
5		13992.00	23.81	28.70	52.51	74.00	-21.49	peak	
6		13992.00	12.33	28.70	41.03	54.00	-12.97	AVG	
7		15714.00	30.96	22.80	53.76	74.00	-20.24	peak	
8		15714.00	20.26	22.80	43.06	54.00	-10.94	AVG	
9		17034.00	27.61	27.28	54.89	74.00	-19.11	peak	
10		17034.00	15.33	27.28	42.61	54.00	-11.39	AVG	
11		17928.00	24.12	32.82	56.94	74.00	-17.06	peak	
12	*	17928.00	12.32	32.82	45.14	54.00	-8.86	AVG	

Test Voltage	AC 120V/60Hz	Polarization	Horizontal
Test Mode	Mode 5(Config1)		

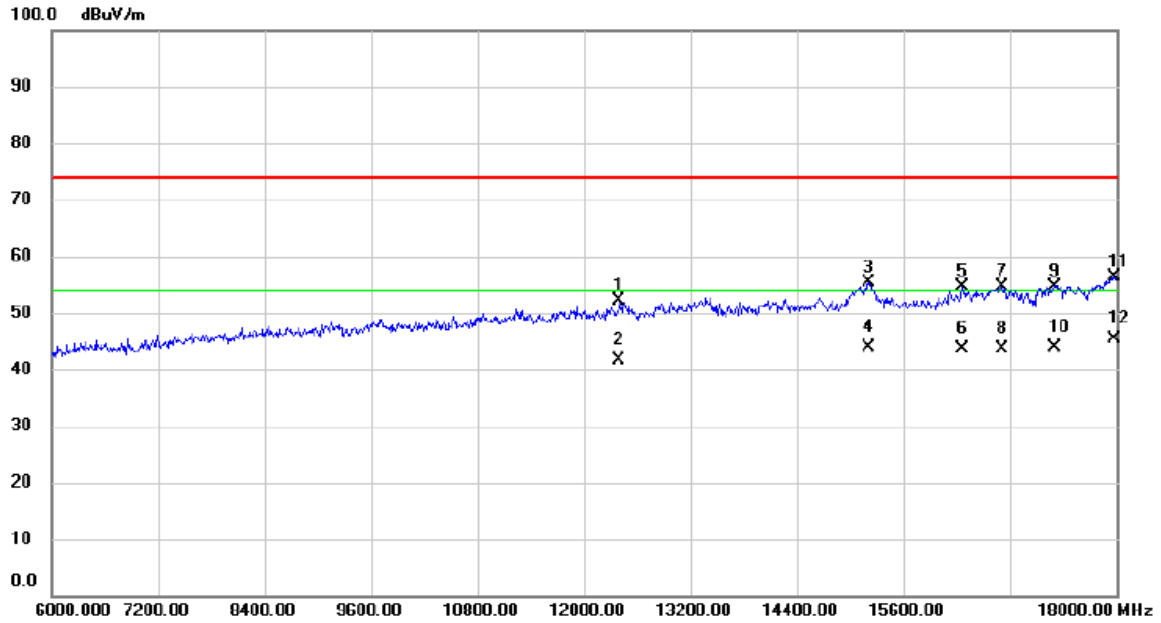

No.	Mk.	Freq. MHz	Reading Level dBuV	Correct Factor dB	Measure- ment dBuV/m	Limit dBuV/m	Margin dB	Detector	Comment
1		12396.00	30.58	21.50	52.08	74.00	-21.92	peak	
2		12396.00	20.24	21.50	41.74	54.00	-12.26	AVG	
3		15210.00	30.71	24.70	55.41	74.00	-18.59	peak	
4		15210.00	19.22	24.70	43.92	54.00	-10.08	AVG	
5		16266.00	31.38	23.34	54.72	74.00	-19.28	peak	
6		16266.00	20.26	23.34	43.60	54.00	-10.40	AVG	
7		16710.00	29.26	25.27	54.53	74.00	-19.47	peak	
8		16710.00	18.33	25.27	43.60	54.00	-10.40	AVG	
9		17298.00	26.23	28.48	54.71	74.00	-19.29	peak	
10		17298.00	15.33	28.48	43.81	54.00	-10.19	AVG	
11		17970.00	23.32	33.15	56.47	74.00	-17.53	peak	
12	*	17970.00	12.32	33.15	45.47	54.00	-8.53	AVG	

Test Voltage	AC 120V/60Hz	Polarization	Vertical
Test Mode	Mode 5(Config1)		

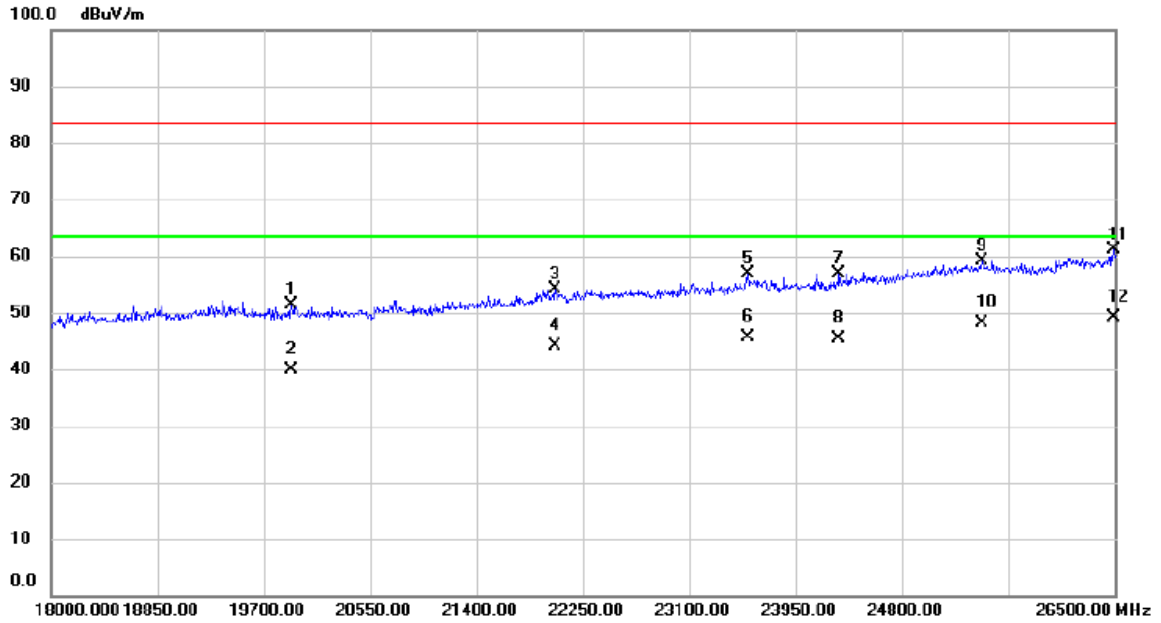

No.	Mk.	Freq. MHz	Reading Level dBuV	Correct Factor dB	Measure- ment dBuV/m	Limit dBuV/m	Margin dB	Detector	Comment
1		19921.00	31.61	19.66	51.27	83.50	-32.23	peak	
2		19921.00	20.26	19.66	39.92	63.50	-23.58	AVG	
3		22029.00	32.48	21.68	54.16	83.50	-29.34	peak	
4		22029.00	22.33	21.68	44.01	63.50	-19.49	AVG	
5		23567.50	32.50	24.26	56.76	83.50	-26.74	peak	
6		23567.50	21.33	24.26	45.59	63.50	-17.91	AVG	
7		24298.50	31.88	25.06	56.94	83.50	-26.56	peak	
8		24298.50	20.26	25.06	45.32	63.50	-18.18	AVG	
9		25437.50	32.36	26.74	59.10	83.50	-24.40	peak	
10		25437.50	21.33	26.74	48.07	63.50	-15.43	AVG	
11		26491.50	33.20	27.84	61.04	83.50	-22.46	peak	
12	*	26491.50	21.30	27.84	49.14	63.50	-14.36	AVG	

Test Voltage	AC 120V/60Hz	Polarization	Horizontal
Test Mode	Mode 5(Config1)		

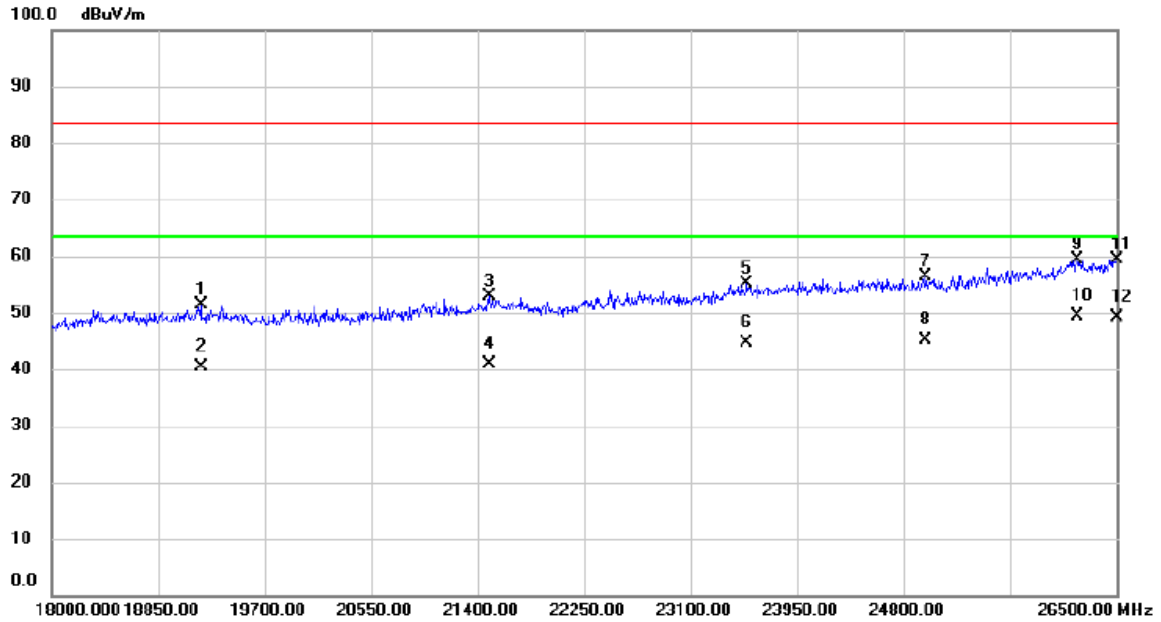

No.	Mk.	Freq. MHz	Reading Level dBuV	Correct Factor dB	Measure- ment dBuV/m	Limit dBuV/m	Margin dB	Detector	Comment
1		19190.00	31.38	20.07	51.45	83.50	-32.05	peak	
2		19190.00	20.26	20.07	40.33	63.50	-23.17	AVG	
3		21493.50	31.57	21.40	52.97	83.50	-30.53	peak	
4		21493.50	19.36	21.40	40.76	63.50	-22.74	AVG	
5		23550.50	30.77	24.25	55.02	83.50	-28.48	peak	
6		23550.50	20.26	24.25	44.51	63.50	-18.99	AVG	
7		24978.50	30.43	25.92	56.35	83.50	-27.15	peak	
8		24978.50	19.32	25.92	45.24	63.50	-18.26	AVG	
9		26185.50	32.17	27.11	59.28	83.50	-24.22	peak	
10	*	26185.50	22.33	27.11	49.44	63.50	-14.06	AVG	
11		26500.00	31.58	27.85	59.43	83.50	-24.07	peak	
12		26500.00	21.32	27.85	49.17	63.50	-14.33	AVG	

Test Voltage	AC 120V/60Hz	Polarization	Vertical
Test Mode	Mode 5(Config1)		

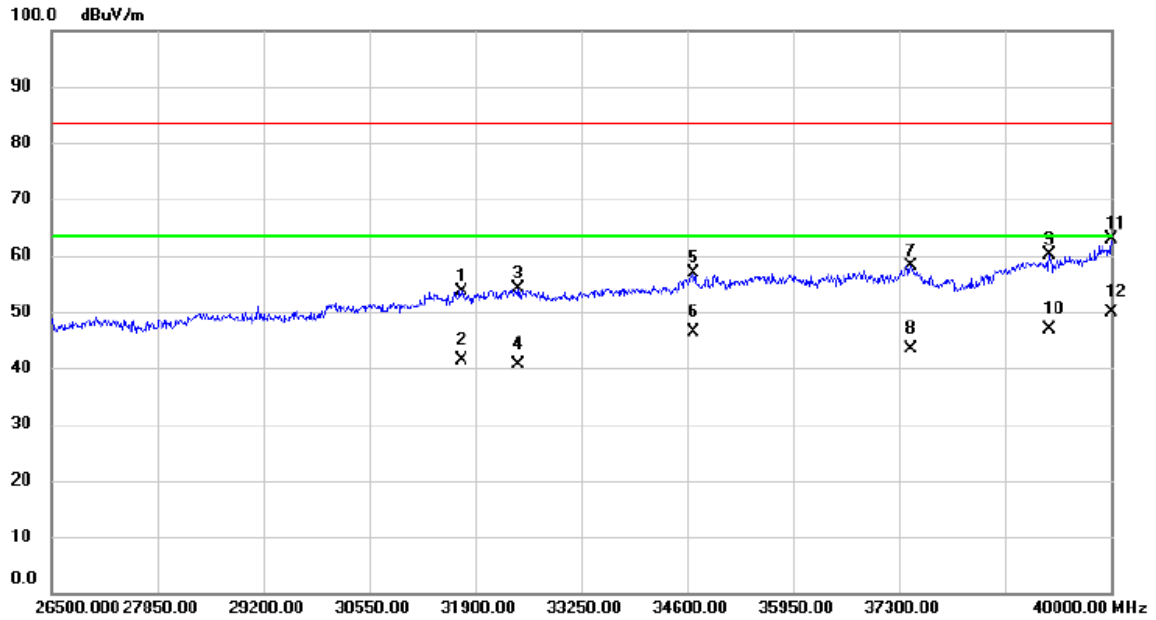

No. Mk.	Freq. MHz	Reading Level dBuV	Correct Factor dB	Measurement dBuV/m	Limit dBuV/m	Margin dB	Detector	Comment
1	31724.50	44.63	9.04	53.67	83.50	-29.83	peak	
2	31724.50	32.33	9.04	41.37	63.50	-22.13	AVG	
3	32453.50	44.81	9.20	54.01	83.50	-29.49	peak	
4	32453.50	31.33	9.20	40.53	63.50	-22.97	AVG	
5	34681.00	45.76	11.11	56.87	83.50	-26.63	peak	
6	34681.00	35.33	11.11	46.44	63.50	-17.06	AVG	
7	37448.50	47.23	10.95	58.18	83.50	-25.32	peak	
8	37448.50	32.33	10.95	43.28	63.50	-20.22	AVG	
9	39217.00	44.58	15.51	60.09	83.50	-23.41	peak	
10	39217.00	31.36	15.51	46.87	63.50	-16.63	AVG	
11	40000.00	45.28	17.60	62.88	83.50	-20.62	peak	
12 *	40000.00	32.36	17.60	49.96	63.50	-13.54	AVG	



Test Voltage	AC 120V/60Hz	Polarization	Horizontal
Test Mode	Mode 5(Config1)		

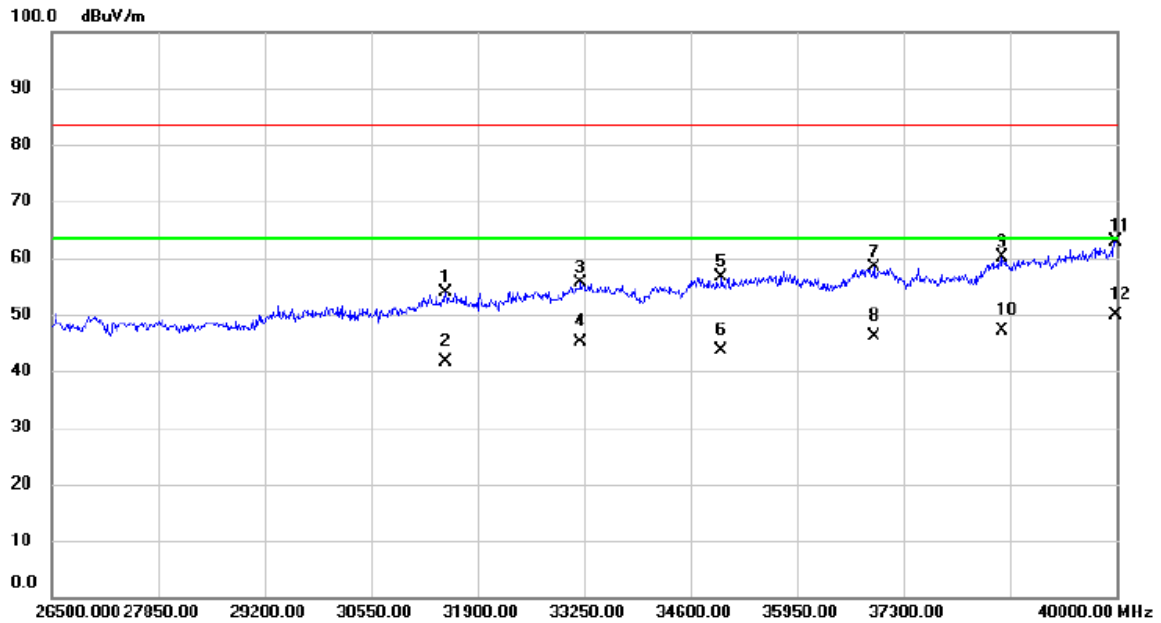

No.	Mk.	Freq. MHz	Reading Level dBuV	Correct Factor dB	Measure- ment dBuV/m	Limit dBuV/m	Margin dB	Detector	Comment
1		31495.00	44.66	9.28	53.94	83.50	-29.56	peak	
2		31495.00	32.33	9.28	41.61	63.50	-21.89	AVG	
3		33209.50	45.86	9.71	55.57	83.50	-27.93	peak	
4		33209.50	35.33	9.71	45.04	63.50	-18.46	AVG	
5		34991.50	45.41	11.32	56.73	83.50	-26.77	peak	
6		34991.50	32.33	11.32	43.65	63.50	-19.85	AVG	
7		36922.00	47.54	10.86	58.40	83.50	-25.10	peak	
8		36922.00	35.33	10.86	46.19	63.50	-17.31	AVG	
9		38555.50	46.30	13.76	60.06	83.50	-23.44	peak	
10		38555.50	33.26	13.76	47.02	63.50	-16.48	AVG	
11		39986.50	45.41	17.56	62.97	83.50	-20.53	peak	
12	*	39986.50	32.31	17.56	49.87	63.50	-13.63	AVG	