

LAVA LAMP BLUETOOTH SPEAKER

Item No. 316709



**Please read these instructions thoroughly
before use and retain for future reference**

Instructions for use

Please read all instructions carefully

Getting started

Remove the speaker from the box

Remove any packaging from the product

Place the packaging inside the box and store for safekeeping

In the box

Lava Lamp Base Speaker

Lava Bottle

Lid

Instruction Manual

Features

Enjoy music wirelessly.

Enjoy the lava lamp effect

Safety Instructions

When using any electrical product, basic safety precautions should always be followed including the following:

- Always ensure that the voltage on the rating label corresponds to the mains voltage in your home.
- Incorrect operation and improper use can damage the product and cause injury to the user.
- When lava lamp is in operation. Be sure not to move or shake it in order to avoid liquid becoming murky and permanently damaged.
- Lava lamp should never be heated up by any other means. Nor should it be cooled down artificially. Not be used when the vase is cracked or damaged.
- Never immerse the unit in water or any other liquid for cleaning purposes.
- Do not operate the unit if it has been exposed to water, moisture or any other liquids to prevent against electric shock, explosion and/or injury to yourself and damage to the unit.
- Repairs to electrical equipment should only be performed by a qualified electrician. Improper repairs may place the user at serious risk.
- Do not use the unit with wet hands.
- Do not put objects into any of the openings.
- Keep the unit free from dust, lint etc.
- Do not use this unit for anything other than its intended use.
- Keep the unit out of reach of small children.
- This product is not a toy.
- Do not use abrasive cleaning solvents to clean.
- Always disconnect from the mains after use.
- Indoor use only.

Product Diagram

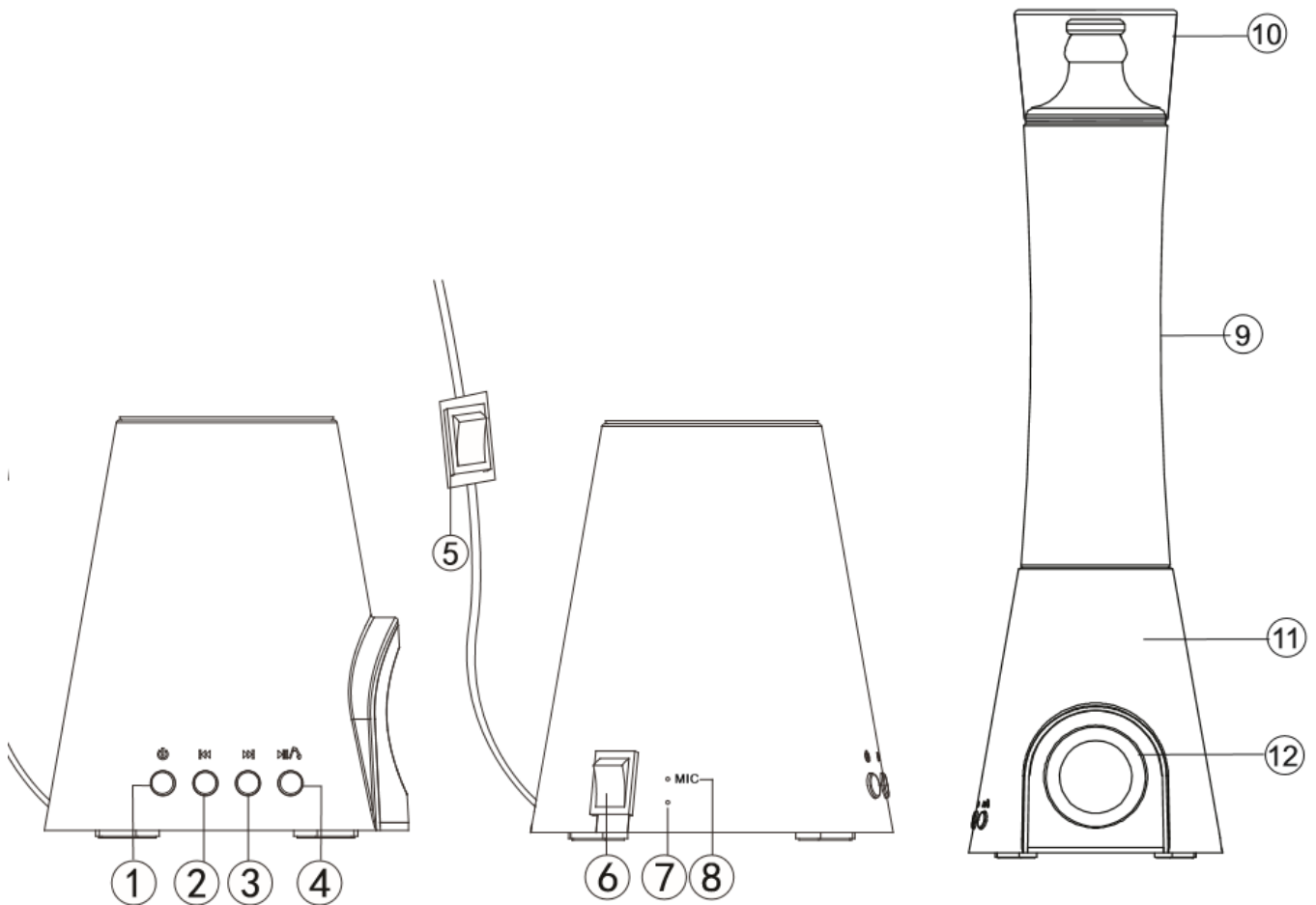

1. Bluetooth ON/OFF Button
2. Previous Track / VOL-
3. Next Track / VOL+
4. Play / Pause /Answer a call /end a call
5. Power Switch
6. Lava Lamp ON/OFF Switch
7. Bluetooth Indicator Light
8. MIC.
9. Lava Bottle
10. Lid
11. Lava Lamp Base
12. Speaker

INSTRUCTION FOR USE

Safe Operation of These Lights:

- 1) When the lamp is in operation, be sure not to move or shake it in order to avoid liquid becoming murky and permanently damaged.
- 2) Use only 30 Watt R39 E14 light bulb for the replacement of the bulb. Variance in bulb size or wattage will produce unsatisfactory operation, fire or breakage of the glass tube.
- 3) The lamp bulb and reflector may be off centre during shipping. Please re-centre them before plugging the lamp in.
- 4) DO NOT INGEST.
- 5) This is not a toy. This is an electrical lamp. Keep out of the reach of small children. The Motion Lamp is designed to operate in an average room temperature of 20 – 25°C (68-77 F). It takes approx. 3-5 hours to warm up. Do not leave the lamp unattended during use.
- 6) Keep the Motion Lamp from sources of cold or warm wind such as heating and air conditioning vents.
- 7) The colour of the wax will mellow after 2-3 runs of operation. If the tube without floating. Wait until room temperature is achieved before restarting.
- 8) The appliance is not intended for use by persons (including children) with reduced physical, sensory or mental capabilities, or lack of experience and knowledge, unless they have been given supervision or instruction concerning the use of the appliance by a person responsible for their safety.

Assembly:

Un-pack all contents carefully. Ensure the item is unplugged. Place the speaker base on to a flat surface. Position the the Lava bottle upwards and place in to the speaker base securing it firmly. Place the Lid on top of the Lave bottle.

Connection to the power supply:

Plug the end of the mains lead into a wall socket and switch on the wall socket, and turn ON of the Power Switch.

Pairing the speaker with Bluetooth devices (Phone or Music Device)

Turn ON the unit, press the Bluetooth ON/OFF button for a short while, the Blue LED will flash and you will hear "Bluetooth mode"

Turn on the Bluetooth function on your Bluetooth Device (Mobile Phone or Tablet). Please refer to manufacturer's instructions on enabling Bluetooth on your device.









Once you have turned on Bluetooth on your device, select the device "**LAVA01**" from the list of available Bluetooth devices.

If required, enter the password '**0000**' to confirm to pairing.

Once paired successfully, you will hear a tone indicating pairing successful.

The speaker will remember this device and will pair automatically when the device's Bluetooth is activated and in range. You do not need to pair any previously connected devices again. Please refer to your device's user manual for further information.

Control Functions:

Function	Operation	Button
Increase Volume	Playing music	A long press on the  button once will increase the volume
Decrease Volume	Playing music	A long press on the  button once will decrease the volume
Next Track	Playing music	A short press on the  button once will go to next track
Previous Track	Playing music	A short press on the  button once will return to previous track
Pause	Playing music	A short press on the  button will pause the music
Play	Pausing	A short press on the  button will restart the music
Answer a call	Incoming call	A short press on the  button will answer the call
End a call	Incoming call	A short press on the  button will end the call
Call return	Call return	A short press twice on the  button will Call return

Please Note

- Not all mobile phones support all the functions listed above. Please refer to your cell phone's user's manual for further information.
- Certain functions and indication tones may vary depending on your mobile phone.
- An indication tone will alert you when the volume is adjusted to the maximum level.

Listening to Music:

Once the speaker is paired with your device you can stream music wirelessly through the speaker. Should you encounter any problems while streaming please refer your device's user manual for further information.

Using the Lava Lamp:

Turn on of the Lava lamp switch, after 1 to 2 hours, the "wax" will begin to melt and the lava lamp effect will be achieved. The lava lamp can be used independently of the speaker and be used as a regular lava lamp.

Noted: Don't touch Glass shade & Base – it may still be hot for up to 2 hours after it has been switched off.

Cleaning & Maintenance

Make sure the LAVA lamp was cooled down completely before cleaning.

Unplug the product from the supply if it is left unattended and before cleaning.

NEVER immerse the product into water and use a dry cloth for cleaning.

Caution

- 1) When the lamp is in operation, be sure not to move or shake it in order to avoid liquid becoming murky and permanently damaged.
- 2) The lamp should never be heated up by any other means, nor should it be cooled down artificially, or be used when the tube is cracked or damaged.
- 3) Before carrying it, please check to see that the wax layer is completely flat and solidified.
- 4) The space at the top of the tube is provided for expansion. Do not break the seal of the cap to fill it with liquid or solid. Breaking the seal can be dangerous and will ruin the product.
- 5) Use only specified bulb for replacement. Variance in bulb size or wattage will produce unsatisfactory operation, fire or breaking of the glass tube.
- 6) During long periods of storage, the lamp should be handled carefully without freezing or overheating which may permanently damage the product. Always use the original box to store the lamp.
- 7) Do not touch glass shade & base during operation.

Do's and Don'ts

Read the following recommendations before using the speaker. Following these you will be able to enjoy the product for many years.

- Do not expose the speaker to liquid, moisture or humidity to avoid the product's internal circuit being affected.
- Don't use abrasive cleaning solvents to clean the speaker.
- Do not expose the speaker to extremely high or low temperature as this will shorten the life of electronic devices, distort certain plastic parts.
- Don't dispose of the speaker in a fire as it will result in an explosion.
- Don't expose the speaker to contact with sharp objects as this will cause scratches and damage.
- Don't let the speaker drop on to the floor. The internal circuitry might get damaged.
- Don't attempt to disassemble the speaker as it may get damaged if you are not professional.
- Do not expose the speakers to heat or fire. Avoid storage in direct sunlight.
- Do not subject the speakers to mechanical shock.
- Do not add any fluids or solids to your lamp.
- Do not use the product if it has been damaged in any way.

Specifications

Bluetooth specification	Bluetooth 2.1+EDR
Operating distance	10 meters (max.)
Frequency response	80Hz-20Kz
External power supply	AC 220V - 240V~, 50Hz, 30W
Speaker power	1 x 3W
Product size	120x120x400mm



is a trademark on a registered trademark of Bluetooth SIG Inc.

Guidelines for protection of the environment



This appliance should not be put into the domestic garbage at the end of its useful life, but must be disposed of at a central point for recycling of electric and electronic domestic appliances. This symbol on appliance, instruction manual and packaging puts your attention to this important issue. The materials used in this appliance can be recycled. By recycling used domestic appliances you contribute an important push to the protection of our environment. Ask your local authorities for information regarding the point of recollection.

B&M L24 8RJ
Made in China



FCC Statement:

This equipment has been tested and found to comply with the limits for a Class B digital device, pursuant to part 15 of the FCC Rules. These limits are designed to provide reasonable protection against harmful interference in a residential installation. This equipment generates, uses and can radiate radio frequency energy and, if not installed and used in accordance with the instructions, may cause harmful interference to radio communications.

However, there is no guarantee that interference will not occur in a particular installation. If this equipment does cause harmful interference to radio or television reception, which can be determined by turning the equipment off and on, the user is encouraged to try to correct the interference by one or more of the following measures:

- Reorient or relocate the receiving antenna.
- Increase the separation between the equipment and receiver.
- Connect the equipment to an outlet on a circuit different from that to which the receiver is connected.

This device complies with part 15 of the FCC rules. Operation is subject to the following two conditions: (1) This device may not cause harmful interference, and (2) this device must accept any interference received, including interference that may cause undesired operation.

Note: Modifications to this product will void the user's authority to operate this equipment.

Guarantee

This product is guaranteed for twelve months from the date of original purchase.

If any defect should occur due to faulty materials or workmanship, the unit will either be replaced or refunded at our discretion.

You will need to have your receipt or proof of purchase.

The following conditions apply:

- The product must be returned to the retailer with original proof of purchase.
- It is only valid in the UK.
- It does not cover wear and tear, damage, misuse or consumable parts.
- The product must be correctly installed and operated in accordance with the instructions contained in the instruction manual.
- The product must be used solely for domestic purposes.
- The guarantee will be rendered invalid if the product is re-sold or has been damaged by inexpert repair.
- The guarantee is in addition to, and does not diminish your statutory or legal rights.