



TEST REPORT

FCC ID: R8HYM-Z18

For

Shenzhen XinHuaMei Electronics Limited Company

Bluetooth speaker

Model No. : YM-Z18, BTS-Z18, AS-Z18

Trade Name : N/A

Prepared for : Shenzhen XinHuaMei Electronics Limited Company
Address : Bldg 5, Taifeng Industrial Park, No.10, Jianan Road, Shajing Sub-district,
: Baoan District, Shenzhen, China

Prepared by : Shenzhen Alpha Product Testing Co., Ltd.
Address : Building B, East Area of Nanchang Second, Industrial Zone, Gushu 2nd Road,
: Bao'an, Shenzhen, China

Report No. : T1870784 01

Date of Receipt : May 08, 2017

Date of Test : May 08-26, 2017

Date of Report : May 26, 2017

Version Number : REV0

TABLE OF CONTENT

Description	Page
1. General Information	5
1.1. Description of Device (EUT)	5
1.2. Description of Test Facility	6
1.3. Test Procedure	6
2. Summary of Measurement	7
2.1. Summary of test result	7
2.2. Assistant equipment used for test	7
2.3. Block Diagram	8
2.4. Test mode	8
2.5. Test Conditions	9
2.6. Measurement Uncertainty (95% confidence levels, k=2)	9
2.7. Test Equipment List	10
3. Maximum Peak Output power	11
3.1. Limit	11
3.2. Test Procedure	11
3.3. Test Setup	11
3.4. Test Results	11
4. Bandwidth	12
4.1. Limit	12
4.2. Test Procedure	12
4.3. Test Results	12
5. Carrier Frequency Separation	18
5.1. Limit	18
5.2. Test Procedure	18
5.3. Test Results	18
6. Number Of Hopping Channel	21
6.1. Limit	21
6.2. Test Procedure	21
6.3. Test Results	21
7. Dwell Time	24
7.1. Test limit	24
7.2. Test Procedure	24
7.3. Test Results	24
8. Radiated emissions	31
8.1. Radiation Emission Limits(15.209)	31
8.2. Block Diagram of Test setup	32
8.3. Test Procedure	33
8.4. Test Results	33
9. Band Edge Compliance	45
9.1. Block Diagram of Test Setup	45
9.2. Limit	45

9.3. Test Procedure	45
9.4. Test Results	45
10. Power Line Conducted Emissions	64
10.1. Conducted Emission Limits(15.207)	64
10.2. Block Diagram of Test Setup	64
10.3. Test Procedure	64
10.4. Test Results	64
11. Antenna Requirements	67
11.1. Standard Requirement	67
11.2. Antenna Connected Construction	67
11.3. Results	67
12. Test setup photo	68
12.1. Photos of Radiated emission	68
12.2. Photos of Conducted Emission test.....	69
13. Photos of EUT.....	70

DECLARATION

Applicant : Shenzhen XinHuaMei Electronics Limited Company
 Manufacturer : Shenzhen XinHuaMei Electronics Limited Company
 Product : Bluetooth speaker

(A) Model No. : YM-Z18, BTS-Z18, AS-Z18

(B) Trade Name : N/A

(C) Power supply : DC 3.7V from internal battery or DC 5V From USB port

Measurement Standard Used:

FCC Rules and Regulations Part 15 Subpart C Section 15.247: 2016,
ANSI C63.4:2014 ANSI C63.10:2013

The device described above is tested by Shenzhen Alpha Product Testing Co., Ltd. to determine the maximum emission levels emanating from the device. The maximum emission levels are compared to the FCC Part 15 Subpart C limits both conducted and radiated emissions. The test results are contained in this test report and Shenzhen Alpha Product Testing Co., Ltd. is assumed of full responsibility for the accuracy and completeness of these tests.

After the test, our opinion is that EUT compliance with the requirement of the above standards.

This report applies to above tested sample only. This report shall not be reproduced in parts without written approval of Shenzhen Alpha Product Testing Co., Ltd.

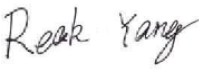
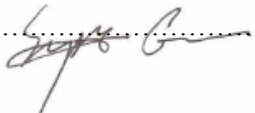
Tested by (name + signature).....:	Reak Yang Project Engineer	
Approved by (name + signature).....:	Simple Guan Project Manager	
Date of issue.....	May 26, 2017	

1. General Information

1.1. Description of Device (EUT)

EUT	:	Bluetooth speaker
Model No.	:	YM-Z18, BTS-Z18, AS-Z18
DIFF.	:	N/A
Trade mark	:	N/A
Power supply	:	DC 3.7V from internal battery or DC 5V From USB port
Radio Technology	:	Bluetooth 3.0
Operation frequency	:	2402-2480MHz
Modulation	:	GFSK, $\pi/4$ DQPSK, 8- DPSK
Antenna Type	:	Integral Antenna, max gain 0dBi.
Software version	:	N/A
Hardware version	:	N/A
Applicant	:	Shenzhen XinHuaMei Electronics Limited Company
Address	:	Bldg 5, Taifeng Industrial Park, No.10, Jianan Road, Shajing Sub-district, Baoan District, Shenzhen, China
Manufacturer	:	Shenzhen XinHuaMei Electronics Limited Company
Address	:	Bldg 5, Taifeng Industrial Park, No.10, Jianan Road, Shajing Sub-district, Baoan District, Shenzhen, China
Adapter	:	N/A

1.2. Description of Test Facility

Shenzhen Alpha Product Testing Co., Ltd

Building B, East Area of Nanchang Second, Industrial Zone, Gushu 2nd Road,

Bao'an, Shenzhen, China

March 25, 2015 File on Federal Communication Commission

Registration Number: 203110

July 18, 2014 Certificated by IC

Registration Number: 12135A

1.3. Test Procedure

POWER LINE CONDUCTED INTERFERENCE:

The test procedure used was ANSI Standard ANSI C63.4:2014 using a 50 u H LISN. Both Lines were observed. The bandwidth of the receiver was 10kHz with an appropriate sweep speed. The ambient temperature of the EUT was 25°C with a humidity of 58%.

RADIATION INTERFERENCE:

The test procedure used was ANSI Standard ANSI C63.4:2014 using a ANRITSU spectrum analyzer with a pre-selector. The analyzer was calibrated in dB above a micro volt at the output of the antenna. The resolution bandwidth was 100kHz and the video bandwidth was 300 kHz up to 1 GHz and 1 MHz with a video BW of 3MHz above 1 GHz. The ambient temperature of the EUT was 25°C with a humidity of 58%.

FORMULA OF CONVERSION FACTORS:

The Field Strength at 3m was established by adding the meter reading of the spectrum analyzer (which is set to read in units of dBuV) to the antenna correction factor supplied by the antenna manufacturer and cable loss. The antenna correction factors and cable loss are stated in terms of dB. The gain of the Pre-selector was accounted for in the Spectrum Analyzer Meter Reading.

Example:

Freq (MHz) METER READING + ACF + CABLE = FS

33.20 dBuV + 10.36 dB + 0.9 dB= 44.46 dBuV/m @ 3m

ANSI STANDARD ANSI C63.4:2014 10.1.7 MEASUREMENT PROCEDURES:

The EUT was placed on a table 80 cm high and with dimensions of 1m by 1.5m. The EUT was placed in the center of the table (1.5m side). The table used for radiated measurements is capable of continuous rotation. When an emission was found, the table was rotated to produce the maximum signal strength. At this point, the antenna was raised and lowered from 1m to 4m. The antenna was placed in both the horizontal and vertical planes. The situation was similar for the conducted measurement except that the table did not rotate. The EUT was setup as described in ANSI Standard ANSI C63.4:2014 10.1.7 with the EUT 40 cm from the vertical ground wall.

2. Summary of Measurement

2.1. Summary of test result

Test procedures according to the technical standards:

KDB DA 00-705

Description of Test Item	Standard	Results
Maximum Peak Output Power	FCC Part 15: 15.247(b)(1) ANSI C63.4 :2014	PASS
Bandwidth	FCC Part 15: 15.215 ANSI C63.4 :2014	PASS
Carrier Frequency Separation	FCC Part 15: 15.247(a)(1) ANSI C63.4 :2014	PASS
Number Of Hopping Channel	FCC Part 15: 15.247(a)(1)(iii) ANSI C63.4 :2014	PASS
Dwell Time	FCC Part 15: 15.247(a)(1)(iii) ANSI C63.4 :2014	PASS
Radiated Emission	FCC Part 15: 15.209 FCC Part 15: 15.247(d) ANSI C63.4 :2014	PASS
Band Edge Compliance	FCC Part 15: 15.247(d) ANSI C63.4 :2014	PASS
Power Line Conducted Emissions	FCC Part 15: 15.207 ANSI C63.4 :2014	PASS
Antenna requirement	FCC Part 15: 15.203	PASS

Note:

1: "N/A" denotes test is not applicable in this Test Report

2: Test with the test procedure Blue tool.

3: All tests are according to ANSI C63.10-2013:

2.2. Assistant equipment used for test

Description	:	N/A
Manufacturer	:	N/A
Model No.	:	N/A

2.3. Block Diagram

1, For radiated emissions test: EUT was placed on a turn table, which is 0.8 meter high above ground for below 1GHz, 1.5 meter high above ground for above 1GHz. EUT was be set into BT test mode by software before test.



2, For Power Line Conducted Emissions Test.

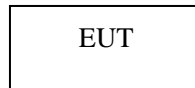

2.4. Test mode

The test software was used to control EUT work in Continuous TX mode, and select test channel, wireless mode.

Tested mode, channel, and data rate information		
Mode	Channel	Frequency (MHz)
GFSK	Low :CH1	2402
	Middle: CH40	2441
	High: CH79	2480

Tested mode, channel, and data rate information		
Mode	Channel	Frequency (MHz)
π /4 DQPSK	Low :CH1	2402
	Middle: CH40	2441
	High: CH79	2480

Tested mode, channel, and data rate information		
Mode	Channel	Frequency (MHz)
8- DPSK	Low :CH1	2402
	Middle: CH40	2441
	High: CH79	2480

2.5. Test Conditions

Temperature range	21-25°C
Humidity range	40-75%
Pressure range	86-106kPa

2.6. Measurement Uncertainty (95% confidence levels, k=2)

Item	MU	Remark
Uncertainty for Power point Conducted Emissions Test	2.71dB	
Uncertainty for Radiation Emission test in 3m chamber (below 30MHz)	2.13 dB	Polarize: V
	2.57dB	Polarize: H
Uncertainty for Radiation Emission test in 3m chamber (30MHz to 1GHz)	3.90dB	Polarize: V
	3.92dB	Polarize: H
Uncertainty for Radiation Emission test in 3m chamber (1GHz to 25GHz)	4.28dB	Polarize: H
	4.26dB	Polarize: V
Uncertainty for radio frequency	1×10^{-9}	
Uncertainty for conducted RF Power	0.16dB	
Uncertainty for temperature	0.2°C	
Uncertainty for humidity	1%	
Uncertainty for DC and low frequency voltages	0.06%	

2.7. Test Equipment List

Equipment	Manufacture	Model No.	Serial No.	Cal. Due	Cal. Interval
3m Semi-Anechoic	CHENYU	N/A	N/A	2017.07.21	2Year
Spectrum analyzer	Agilent	E4407B	MY46185649	2017.09.29	1Year
Receiver	R&S	ESPI	101873	2017.09.29	1Year
Receiver	R&S	ESCI	101165	2017.09.29	1Year
Bilog Antenna	SCHWARZBECK	VULB 9168	VULB9168-438	2017.09.30	2Year
Horn Antenna	SCHWARZBECK	BBHA 9120 D	BBHA 9120 D(1201)	2017.09.30	2Year
L.I.S.N.#1	Schwarzbeck	NSLK8126	8126466	2017.09.29	1 Year
L.I.S.N.#2	ROHDE&SCHWARZ	ENV216	101043	2017.09.29	1 Year
Cable	Resenberger	N/A	No.1	2017.09.29	1Year
Cable	SCHWARZBECK	N/A	No.2	2017.09.29	1Year
Cable	SCHWARZBECK	N/A	No.3	2017.09.29	1Year
Pre-amplifier	HP	HP8347A	2834A00455	2017.09.29	1Year
Pre-amplifier	Agilent	8449B	3008A02664	2017.09.29	1Year
vector Signal Generator	Agilent	N5182A	MY49060042	2017.09.29	1 Year
vector Signal Generator	Agilent	E4438C	US44271917	2017.09.29	1 Year
X-series USB Peak and Average Power Sensor	Agilent	U2021XA	MY54080020	2017.09.29	1 Year
X-series USB Peak and Average Power Sensor	Agilent	U2021XA	MY54110001	2017.09.29	1 Year
Signal Analyzer	Agilent	N9020A	MY48030494	2017.09.29	1 Year

3. Maximum Peak Output power

3.1. Limit

Please refer section 15.247.

For frequency hopping systems operating in the 2400-2483.5 MHz band employing at least 75 non-overlapping hopping channels, and all frequency hopping systems in the 5725-5850 MHz band: 1 watt. For all other frequency hopping systems in the 2400-2483.5 MHz band: 0.125 watts, the e.i.r.p shall not exceed 4W

3.2. Test Procedure

The transmitter output is connected to the RF Power Meter. The RF Power Meter is set to the peak power detection.

3.3. Test Setup

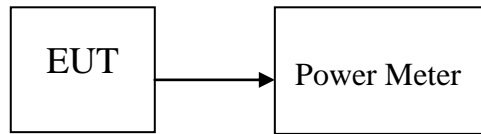

3.4. Test Results

EUT: Bluetooth speaker		M/N: YM-Z18			
Test date: 2017-05-22		Test site: RF site		Tested by: Reak	
Mode	Freq (MHz)	PK Output Power (dBm)	PK Output Power (mW)	Limit (dBm)	Margin (dB)
GFSK	2402	1.76	1.50	21	19.24
	2441	1.35	1.36	21	19.65
	2480	1.42	1.39	21	19.58
π /4 DQPSK,	2402	1.29	1.35	21	19.71
	2441	1.31	1.35	21	19.69
	2480	1.54	1.43	21	19.46
8- DPSK	2402	1.29	1.35	21	19.71
	2441	1.48	1.41	21	19.52
	2480	1.52	1.42	21	19.48

Conclusion: PASS

4. Bandwidth

4.1. Limit

Intentional radiators operating under the alternative provisions to the general emission limits, as contained in §§ 15.217 through 15.257 and in Subpart E of this part, must be designed to ensure that the 20 dB bandwidth of the emission, or whatever bandwidth may otherwise be specified in the specific rule section under which the equipment operates, is contained within the frequency band designated in the rule section under which the equipment is operated.

4.2. Test Procedure

The transmitter output was coupled to a spectrum analyzer via a antenna. The bandwidth of the fundamental frequency was measured by spectrum analyzer with 30kHz RBW and 100kHz VBW. The 20dB bandwidth is defined as the total spectrum the power of which is higher than peak power minus 20dB.

4.3. Test Results

EUT: Bluetooth speaker		M/N: YM-Z18		
Test date: 2017-05-22		Test site: RF site		Tested by: Reak
Mode	Freq (MHz)	20dB Bandwidth (KHz)	Limit (kHz)	Conclusion
GFSK	2402	1097	/	PASS
	2441	1099	/	PASS
	2480	1104	/	PASS
π /4 DQPSK	2402	1357	/	PASS
	2441	1367	/	PASS
	2480	1390	/	PASS
8- DPSK	2402	1345	/	PASS
	2441	1359	/	PASS
	2480	1381	/	PASS

Original Test data For 20dB bandwidth
GFSK:

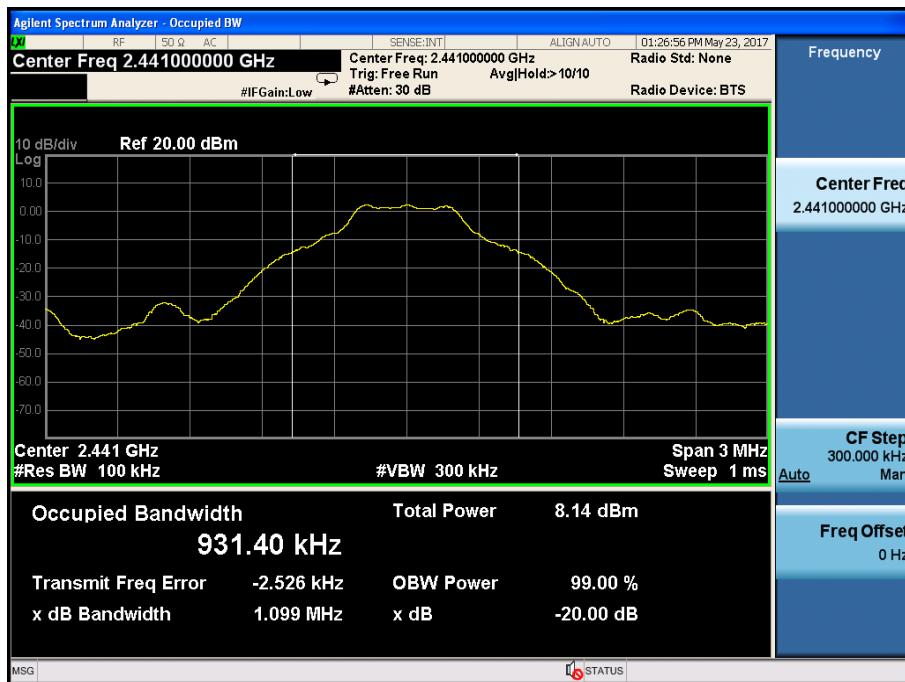
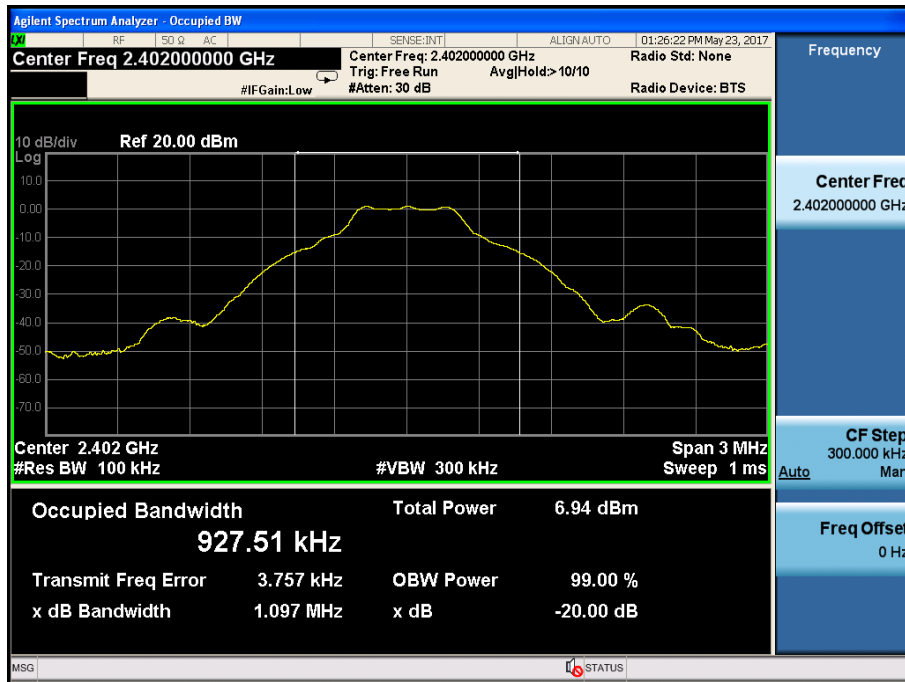

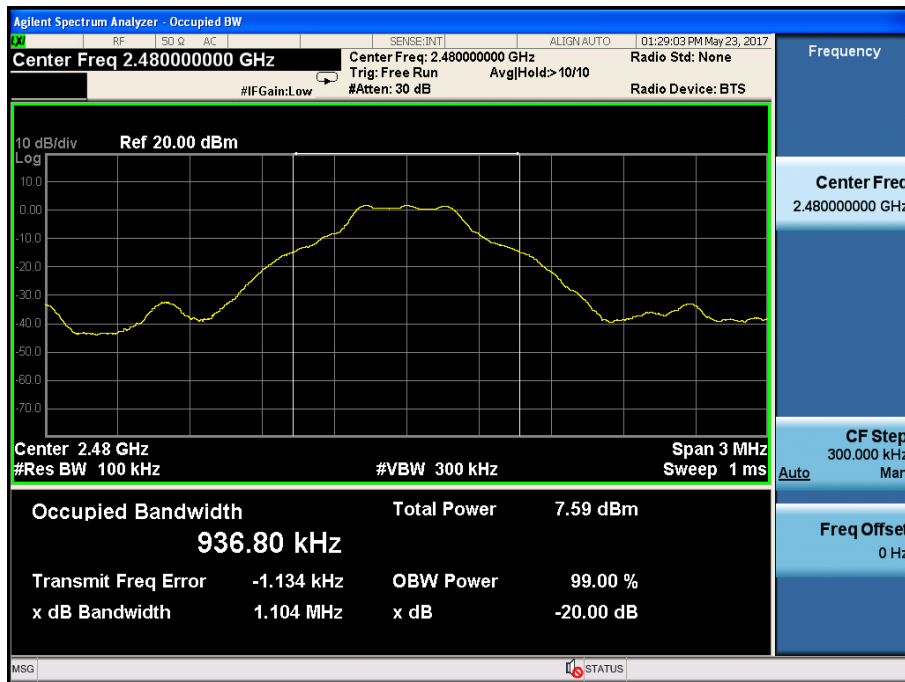

$\pi/4$ DQPSK:

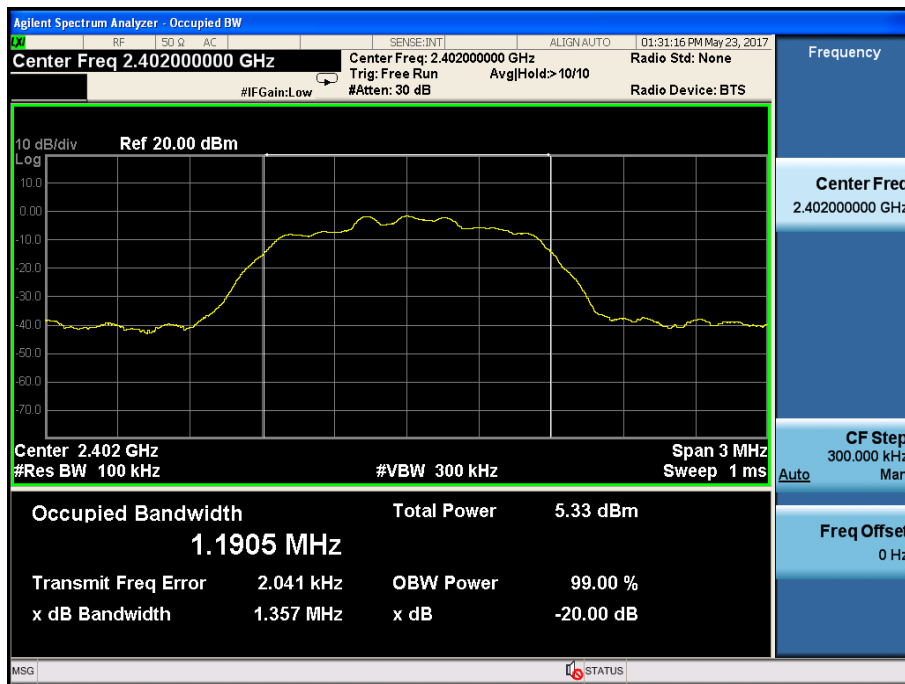

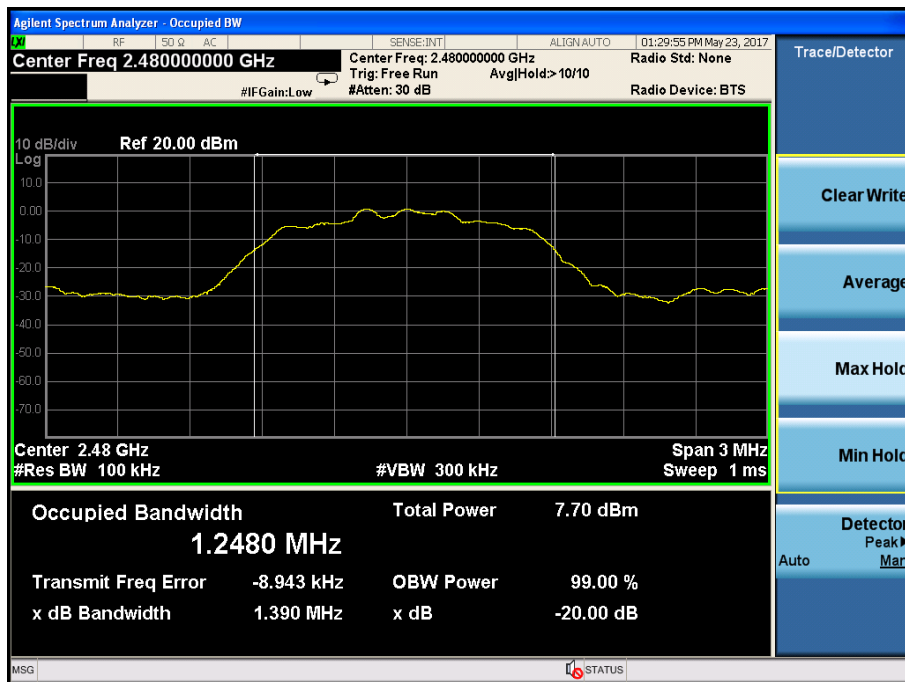
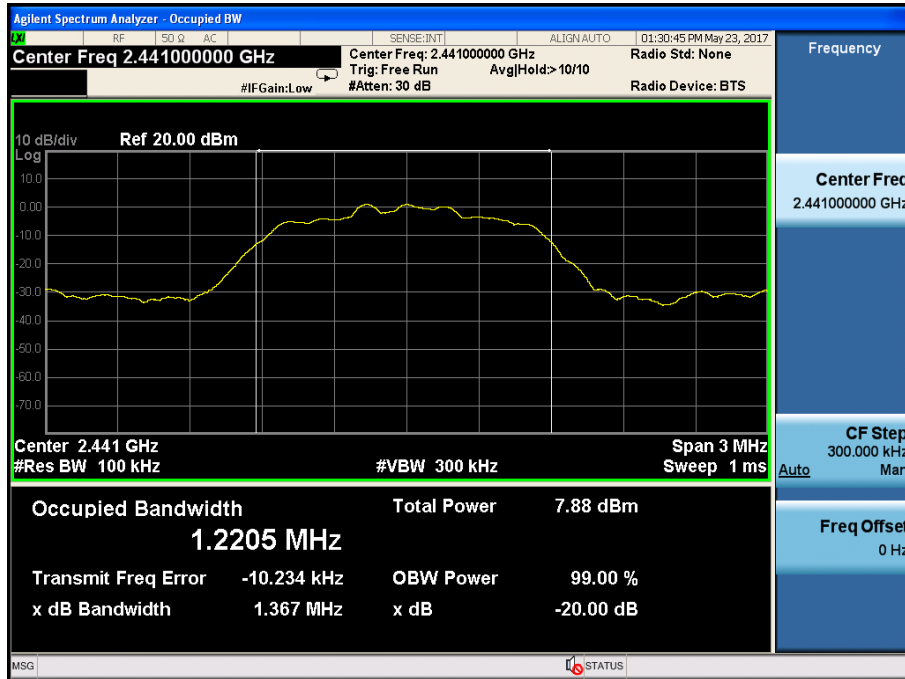

8- DPSK:

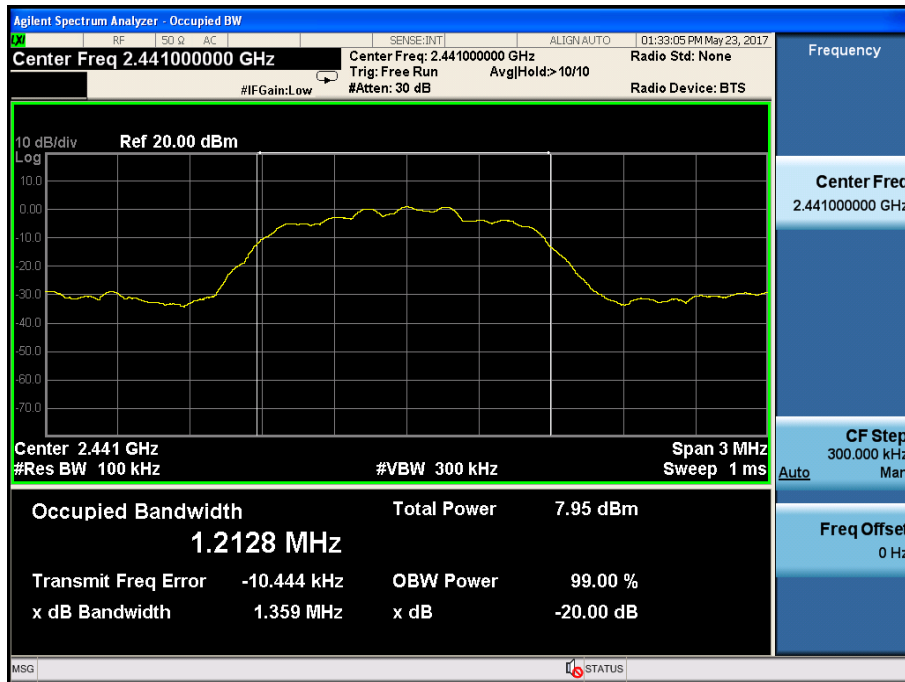
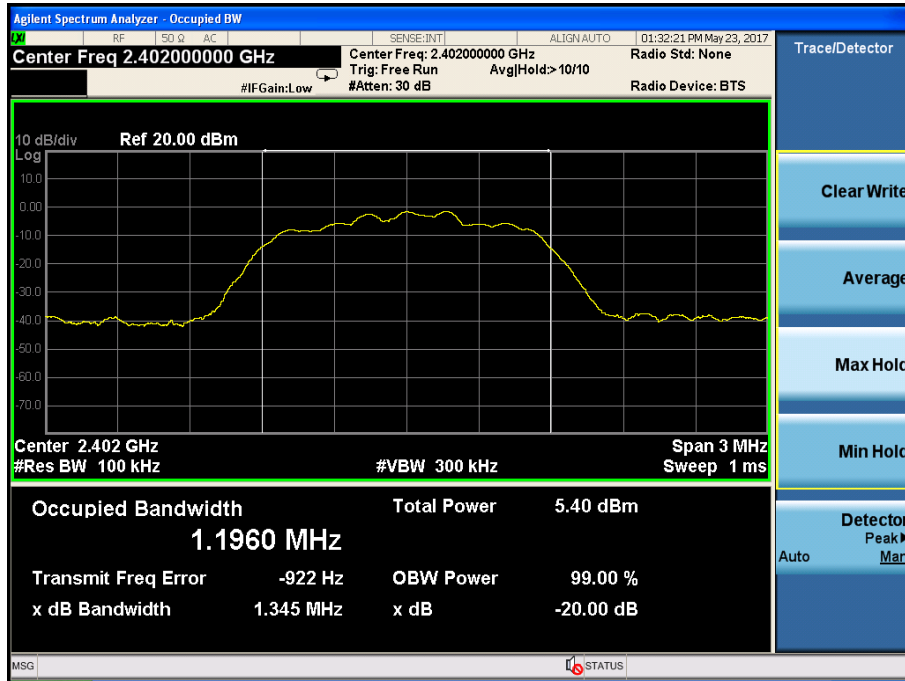

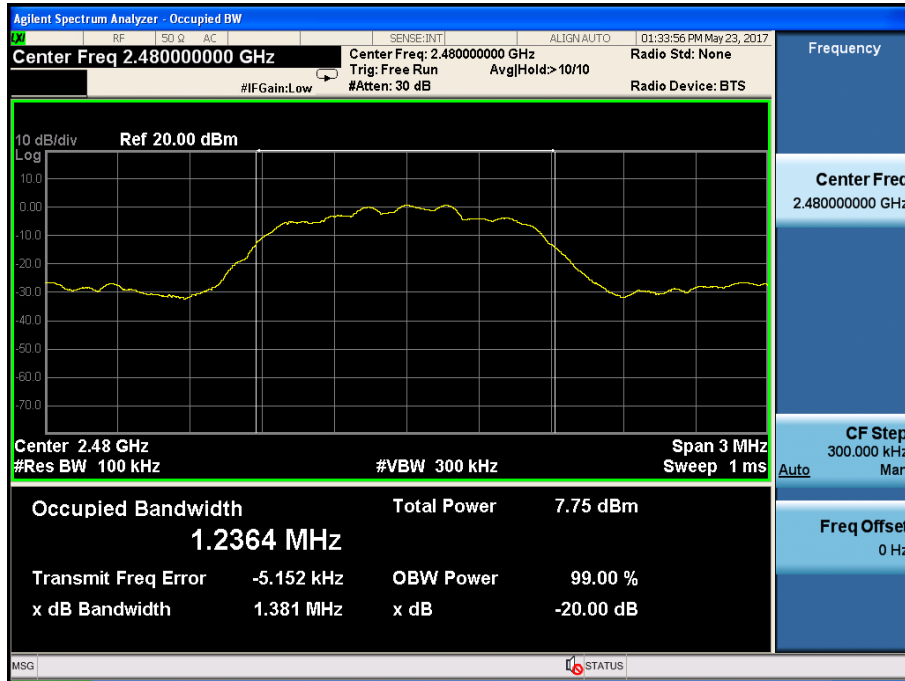

5. Carrier Frequency Separation

5.1. Limit

Frequency hopping systems shall have hopping channel carrier frequencies separated by a minimum of 25 kHz or the 20 dB bandwidth of the hopping channel, whichever is greater. Alternatively, frequency hopping systems operating in the 2400-2483.5 MHz band may have hopping channel carrier frequencies that are separated by 25 kHz or two-thirds of the 20 dB bandwidth of the hopping channel, whichever is greater, provided the systems operate with an output power no greater than 125 mW

5.2. Test Procedure

The transmitter output was coupled to a spectrum analyzer via a antenna. The carrier frequency was measured by spectrum analyzer with 30kHz RBW and 100kHz VBW.

5.3. Test Results

EUT: Bluetooth speaker M/N: YM-Z18				
Test date: 2017-05-22		Test site: RF site		Tested by: Reak
Mode/Channel	Channel separation (MHz)	20dB Bandwidth (KHz)	Limit (KHz) 2/3 20dB bandwidth	Conclusion
GFSK	1.005	1099	732.667	PASS
π /4 DQPSK	1.005	1390	926.667	PASS
8- DPSK	1.002	1387	924.667	PASS

Original test data for channel separation
GFSK

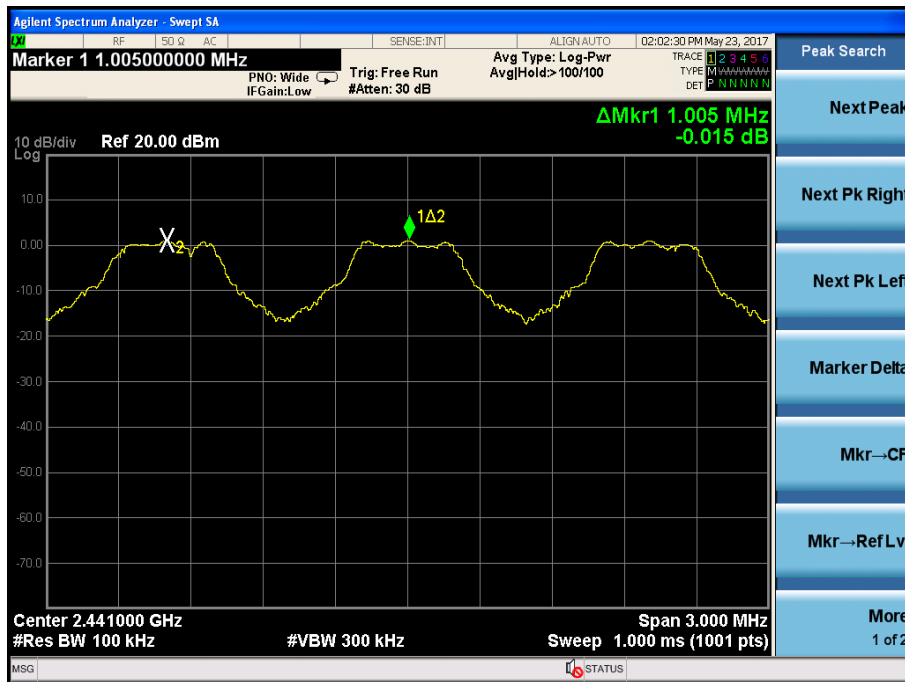

$\pi/4$ DQPSK



8- DPSK:

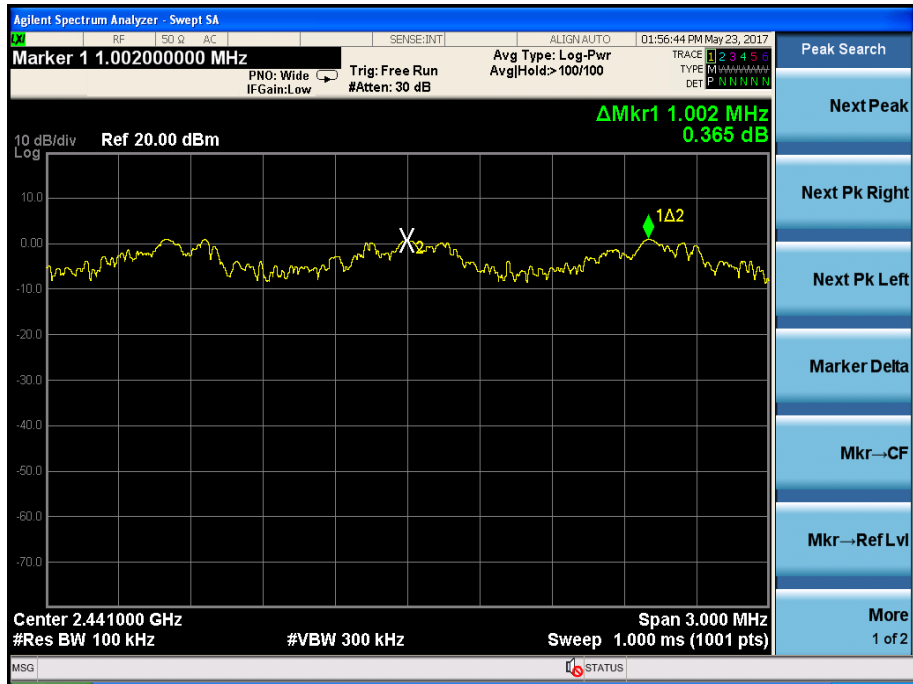

6. Number Of Hopping Channel

6.1. Limit

Frequency hopping systems in the 2400-2483.5 MHz band shall use at least 15 channels.

6.2. Test Procedure

The transmitter output was coupled to a spectrum analyzer via a antenna. The number of hopping channel was measured by spectrum analyzer with 300kHz RBW and 1MHz VBW.

6.3. Test Results

EUT: Bluetooth speaker M/N: YM-Z18			
Test date: 2017-05-22		Test site: RF site	Tested by: Reak
Mode	Number of hopping channel	Limit	Conclusion
GFSK	79	>15	PASS
π /4 DQPSK	79	>15	PASS
8- DPSK	79	>15	PASS

Original test data for hopping channel number
GFSK

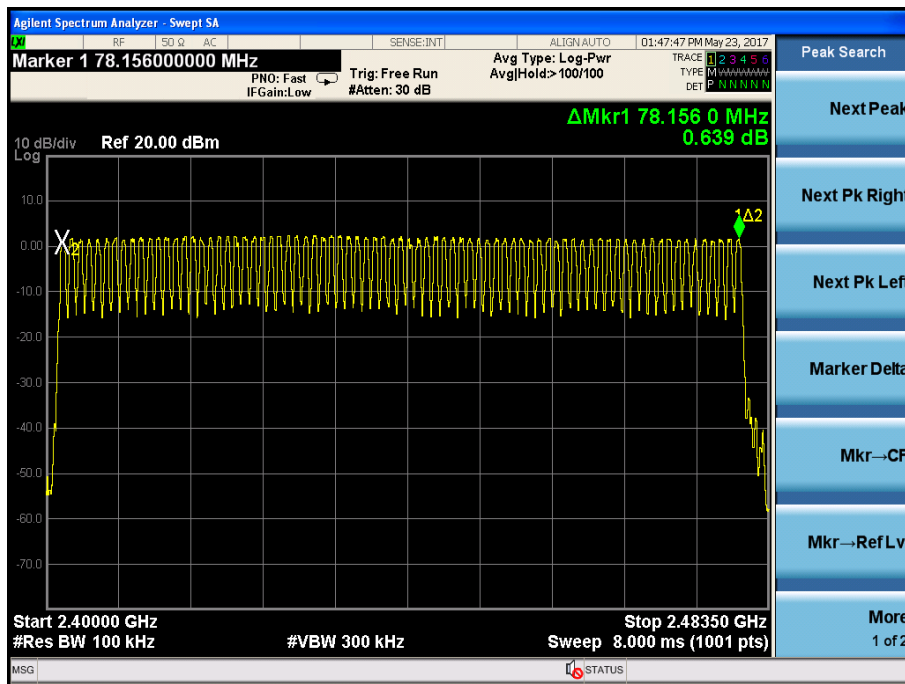

$\pi/4$ DQPSK

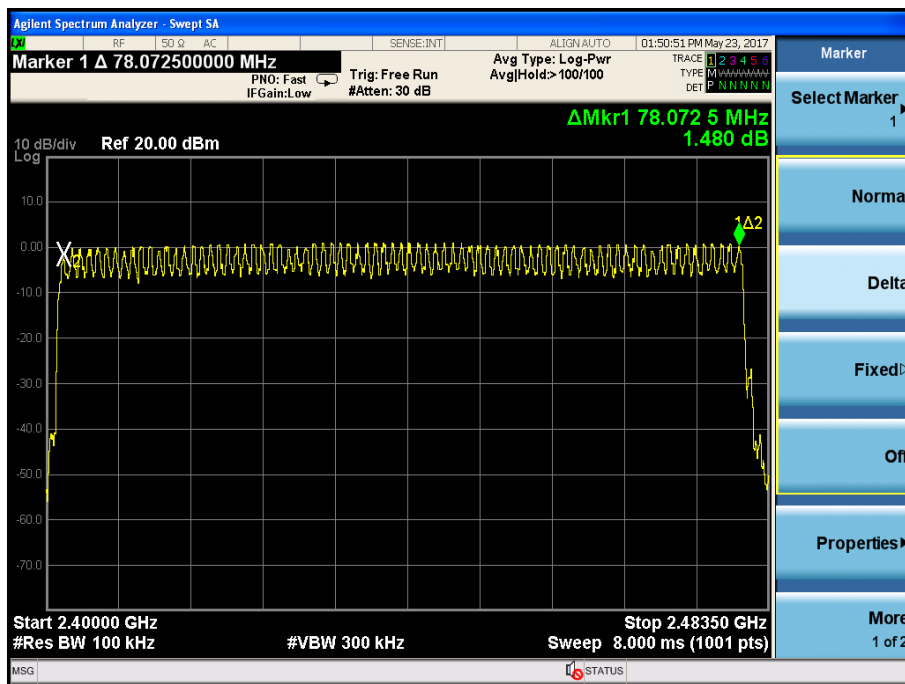

8- DPSK:

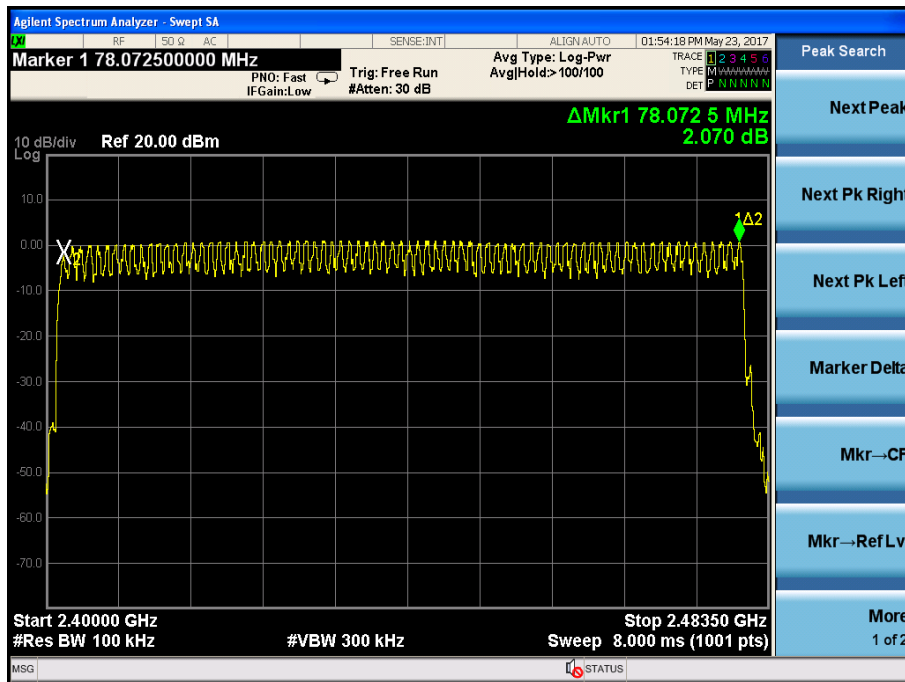

7. Dwell Time

7.1. Test limit

Please refer section 15.247

According to §15.247(a)(1)(iii), Frequency hopping systems operating in the 2400MHz-2483.5 MHz. The average time of occupancy on any frequency shall not be greater than 0.4 s within period of 0.4 seconds multiplied by the number of hopping channels employed.

7.2. Test Procedure

7.2.1. Place the EUT on the table and set it in transmitting mode.

7.2.2. Remove the antenna from the EUT and then connect a low loss RF cable from the antenna port to the spectrum analyzer.

7.2.3. Set center frequency of spectrum analyzer = operating frequency.

7.2.4. Set the spectrum analyzer as RBW, VBW=1MHz, Span = 0Hz, Sweep = auto.

7.2.5. Repeat above procedures until all frequency measured were complete.

7.3. Test Results

PASS.

Detailed information please see the following page.

EUT: Bluetooth speaker M/N: YM-Z18						
Test date: 2017-05-22		Test site: RF site		Tested by: Reak		
Mode	Data Packet	Frequency (MHz)	Pulse Duration (ms)	Dwell Time (s)	Limit (s)	Conclusion
GFSK	DH1	2441	0.384	0.123	<0.4	PASS
	DH3	2441	2.012	0.322	<0.4	PASS
	DH5	2441	2.872	0.306	<0.4	PASS
π /4 DQPSK	DH1	2441	0.400	0.128	<0.4	PASS
	DH3	2441	1.608	0.257	<0.4	PASS
	DH5	2441	2.880	0.307	<0.4	PASS
8- DPSK	DH1	2441	0.396	0.127	<0.4	PASS
	DH3	2441	1.608	0.257	<0.4	PASS
	DH5	2441	2.888	0.308	<0.4	PASS

Note: 1 A period time = 0.4 (s) * 79 = 31.6(s)
2 DH1 time slot = Pulse Duration * (1600/(2*79)) * A period time/1000
DH3 time slot = Pulse Duration * (1600/(4*79)) * A period time/1000
DH5 time slot = Pulse Duration * (1600/(6*79)) * A period time/1000

GFSK

DH1:

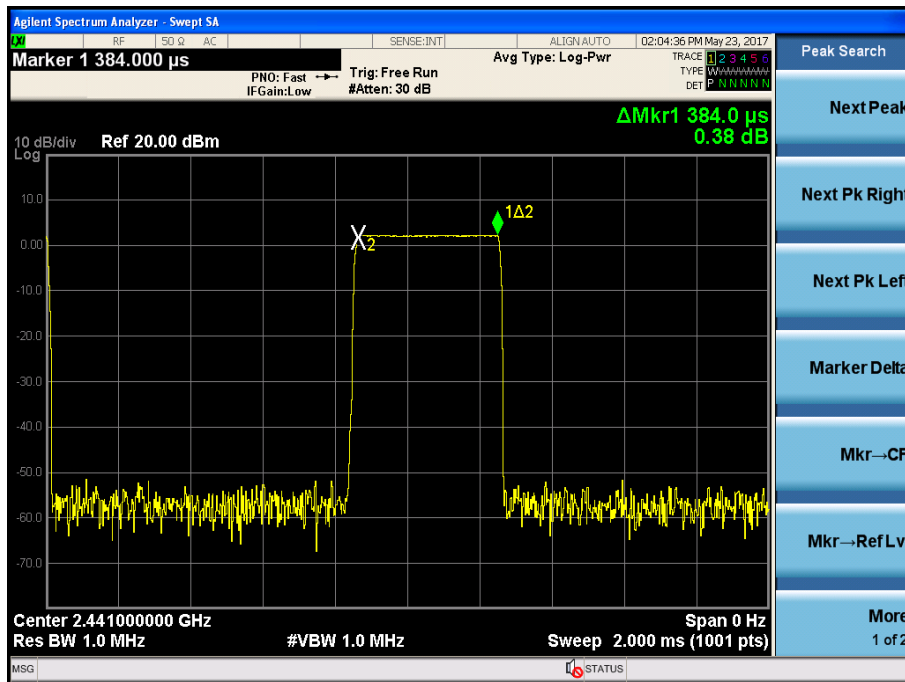

DH3:

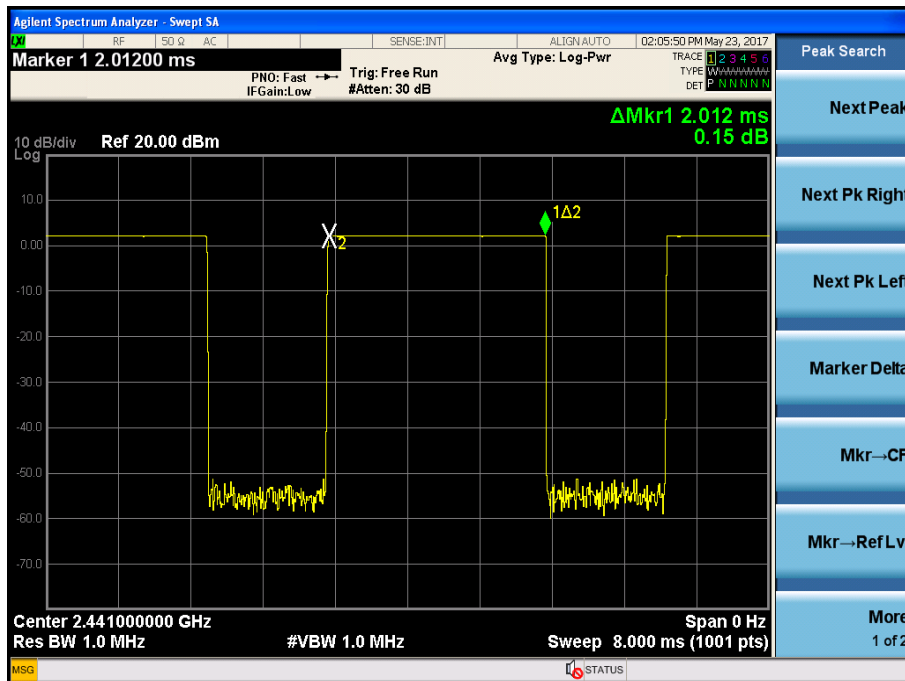

DH5

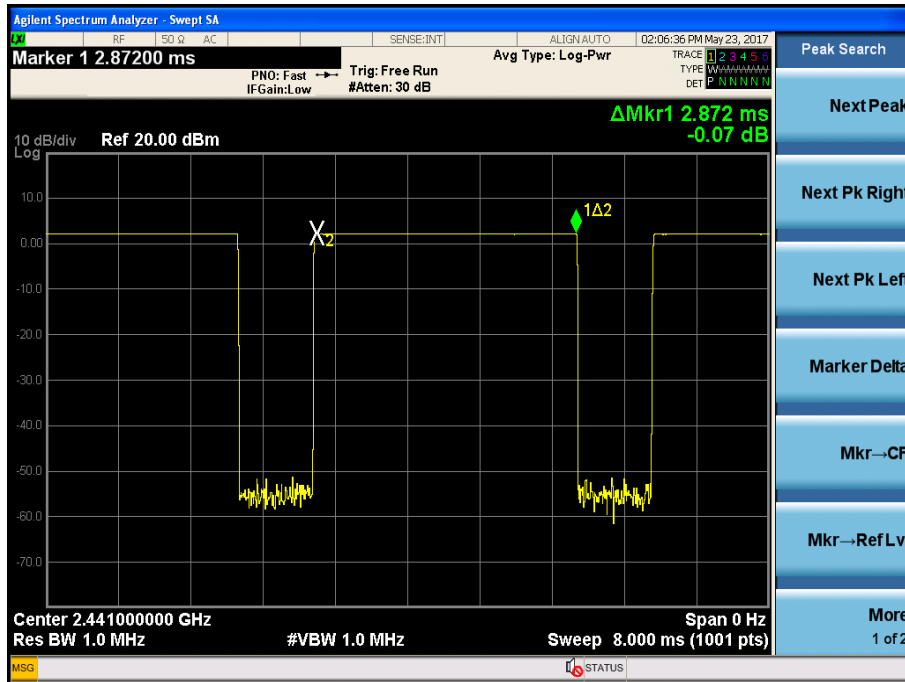

$\pi/4$ DQPSK

DH1:

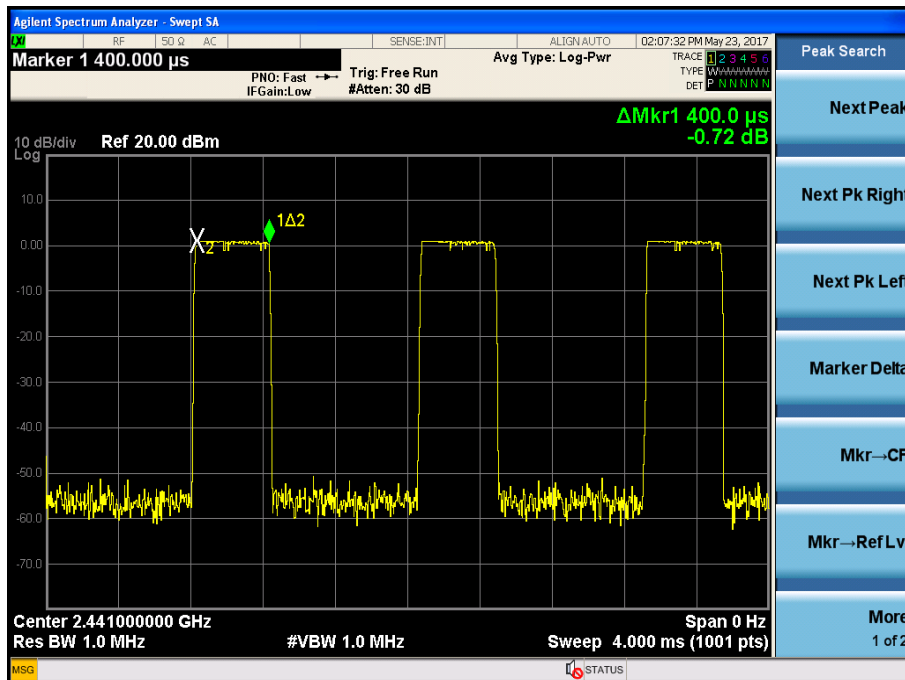

DH3:

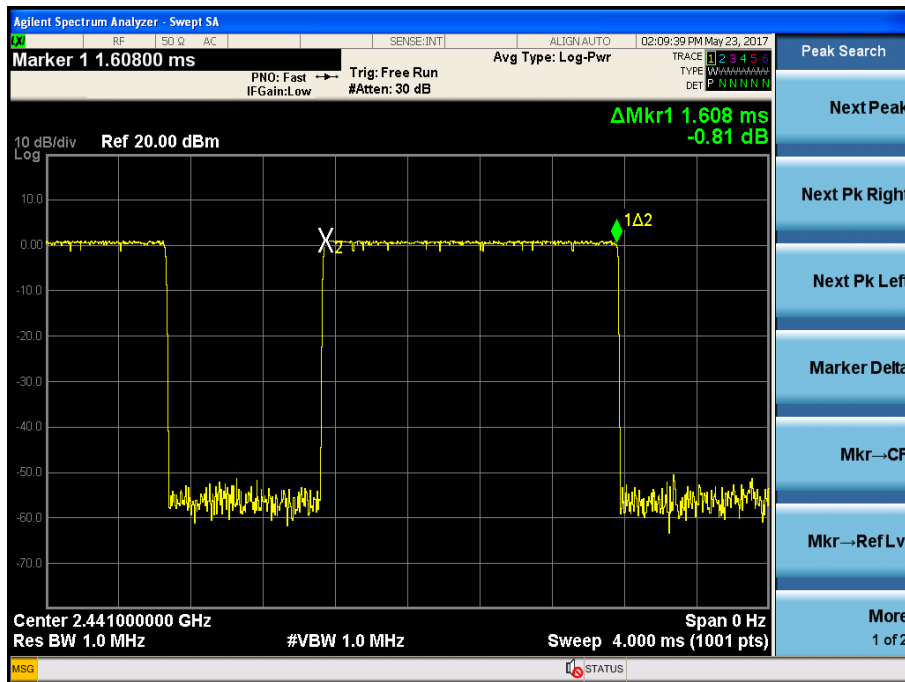

DH5:

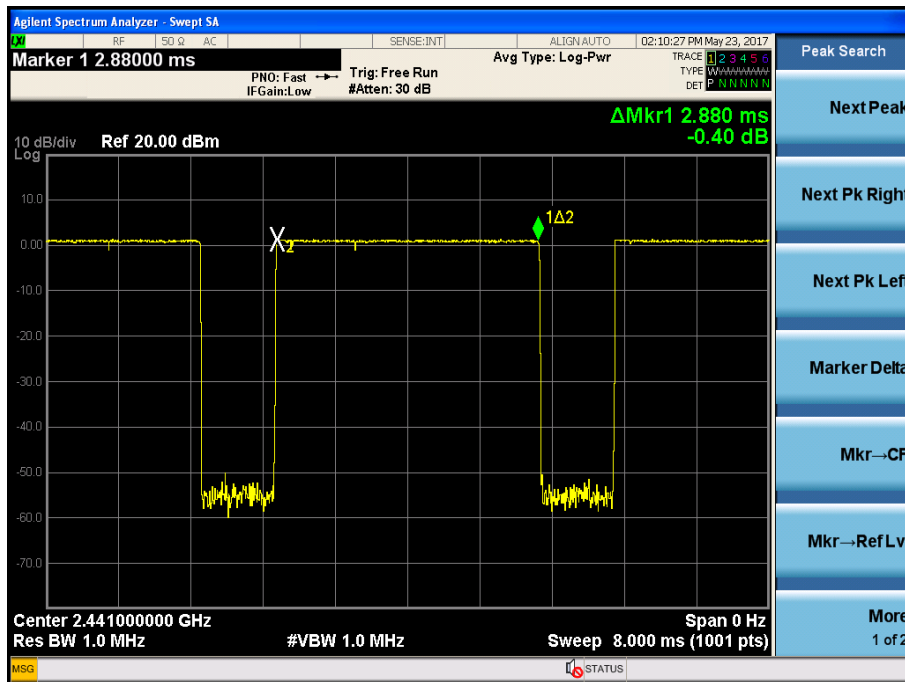

8- DPSK:

DH1

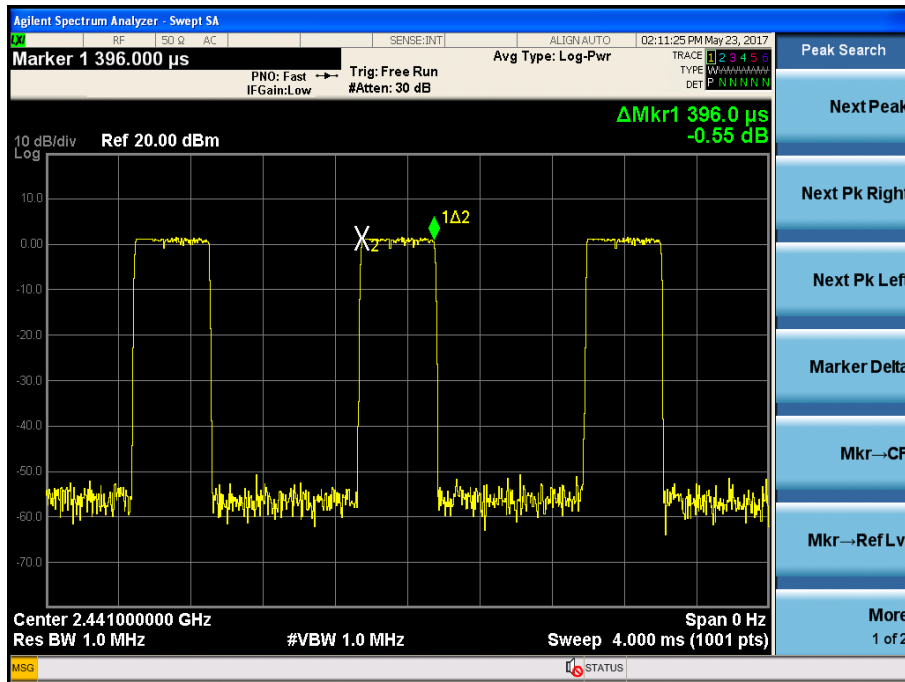

DH3

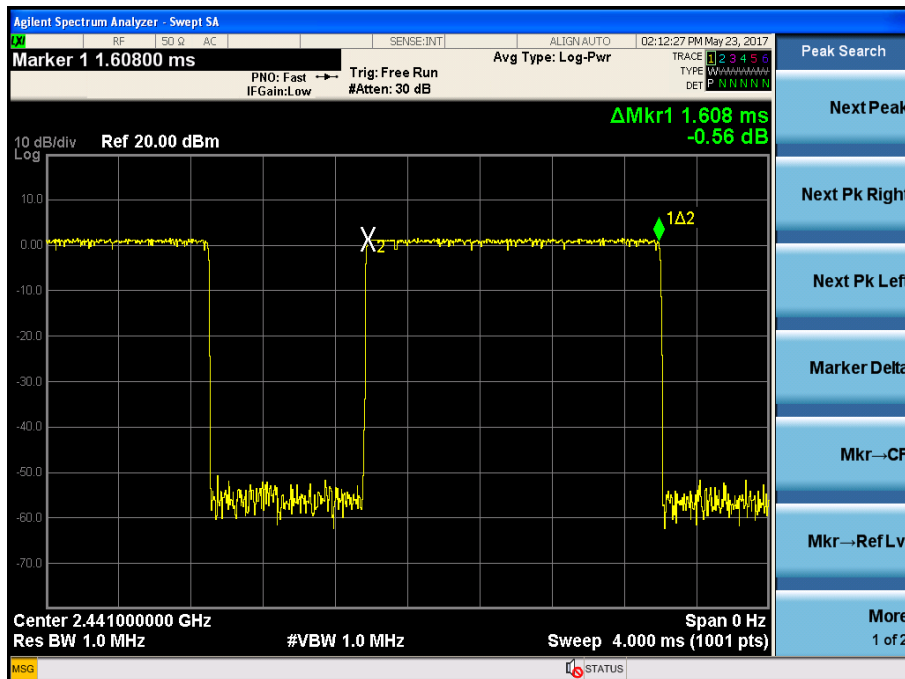

DH5

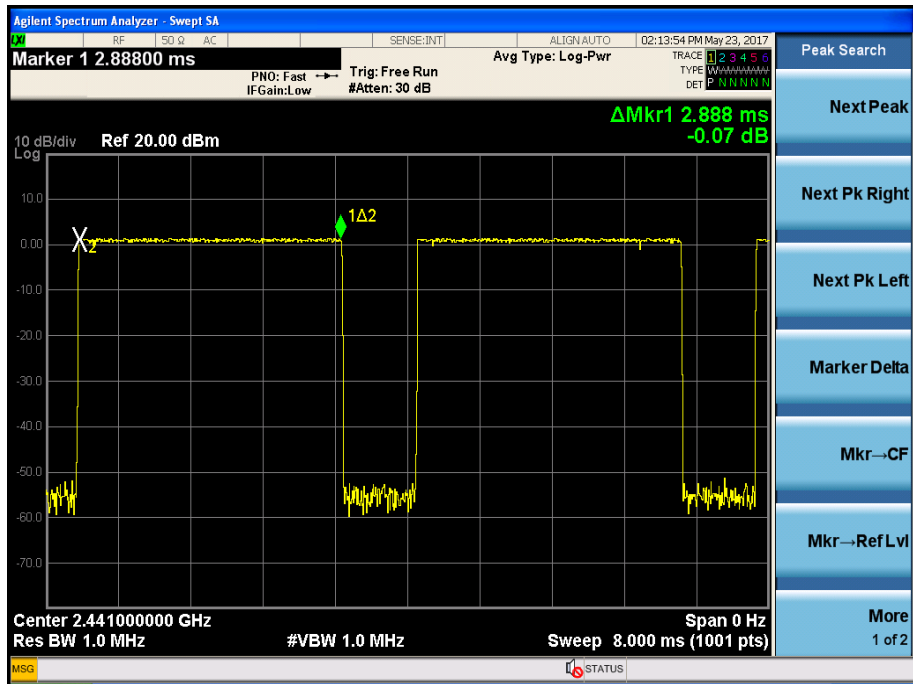

8. Radiated emissions

8.1. Radiation Emission Limits(15.209)

All the emissions appearing within 15.205 restricted frequency bands shall not exceed the limits shown in 15.209, all the other emissions shall be at least 20dB below the fundamental emissions, or comply with 15.209 limits.

15.205 Restricted frequency band

MHz	MHz	MHz	GHz
0.090 - 0.110	16.42 - 16.423	399.9 - 410	4.5 - 5.15
¹ 0.495 - 0.505	16.69475 - 16.69525	608 - 614	5.35 - 5.46
2.1735 - 2.1905	16.80425 - 16.80475	960 - 1240	7.25 - 7.75
4.125 - 4.128	25.5 - 25.67	1300 - 1427	8.025 - 8.5
4.17725 - 4.17775	37.5 - 38.25	1435 - 1626.5	9.0 - 9.2
4.20725 - 4.20775	73 - 74.6	1645.5 - 1646.5	9.3 - 9.5
6.215 - 6.218	74.8 - 75.2	1660 - 1710	10.6 - 12.7
6.26775 - 6.26825	108 - 121.94	1718.8 - 1722.2	13.25 - 13.4
6.31175 - 6.31225	123 - 138	2200 - 2300	14.47 - 14.5
8.291 - 8.294	149.9 - 150.05	2310 - 2390	15.35 - 16.2
8.362 - 8.366	156.52475 - 156.52525	2483.5 - 2500	17.7 - 21.4
8.37625 - 8.38675	156.7 - 156.9	2690 - 2900	22.01 - 23.12
8.41425 - 8.41475	162.0125 - 167.17	3260 - 3267	23.6 - 24.0
12.29 - 12.293	167.72 - 173.2	3332 - 3339	31.2 - 31.8
12.51975 - 12.52025	240 - 285	3345.8 - 3358	36.43 - 36.5
12.57675 - 12.57725	322 - 335.4	3600 - 4400	(²)

15.209 Limit

FREQUENCY MHz	DISTANCE Meters	FIELD STRENGTHS LIMIT	
		$\mu\text{V}/\text{m}$	$\text{dB}(\mu\text{V})/\text{m}$
0.009-0.490	300	2400/F(KHz)	/
0.490-1.705	30	24000/F(KHz)	/
1.705-30	30	30	29.5
30 ~ 88	3	100	40.0
88 ~ 216	3	150	43.5
216 ~ 960	3	200	46.0
960 ~ 1000	3	500	54.0
Above 1000	3	74.0 $\text{dB}(\mu\text{V})/\text{m}$ (Peak) 54.0 $\text{dB}(\mu\text{V})/\text{m}$ (Average)	

8.2. Block Diagram of Test setup

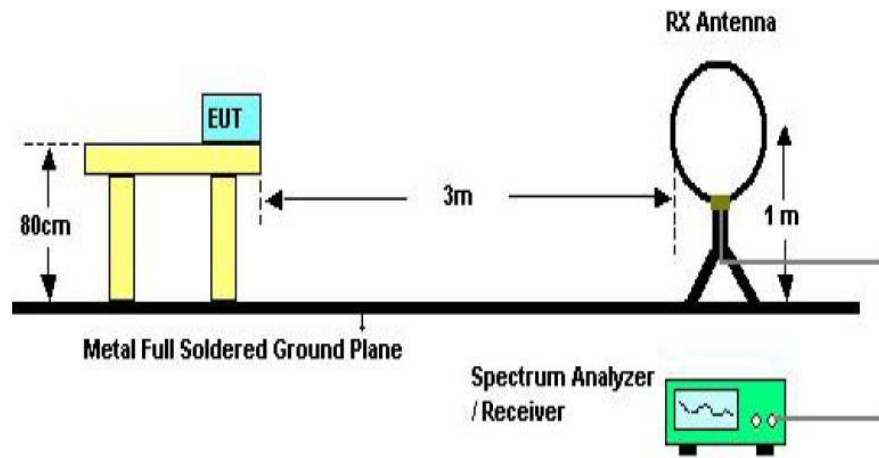

Below 30MHz Test Setup

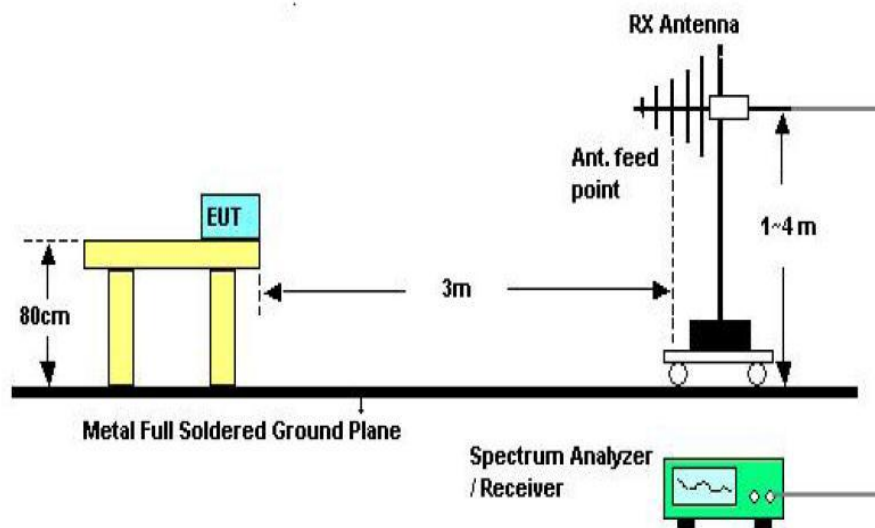

Above 30MHz Test Setup

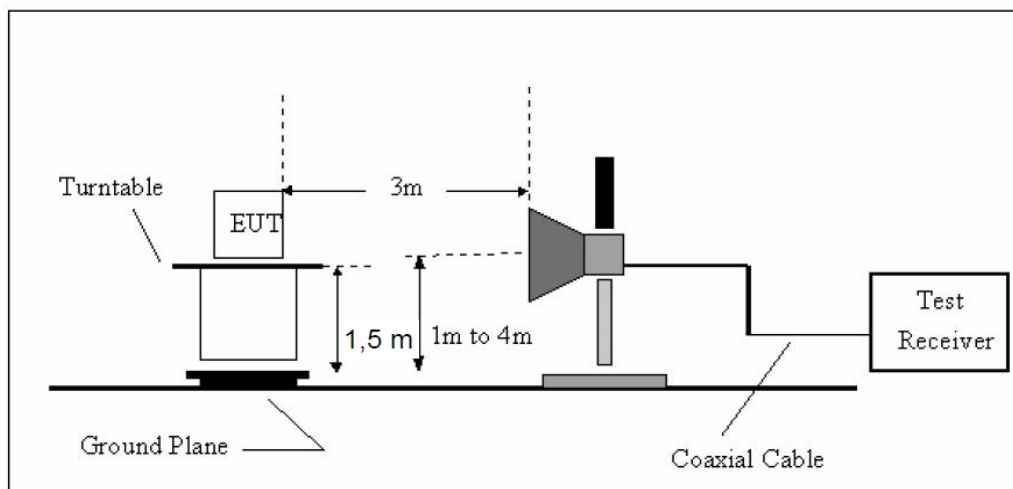

Above 1GHz Test Setup

8.3. Test Procedure

- (1) EUT was placed on a non-metallic table, 80 cm above the ground plane inside a semi-anechoic chamber.
- (2) Setup EUT and simulator as shown in section 1.4 and 6.1
- (3) Test antenna was located 3m from the EUT on an adjustable mast. Below pre-scan procedure was first performed in order to find prominent radiated emissions.
 - (a) Change work frequency or channel of device if practicable.
 - (b) Change modulation type of device if practicable.
 - (c) Rotated EUT though three orthogonal axes to determine the attitude of EUT arrangement produces highest emissions
- (4) Spectrum frequency from 9KHz to 25GHz (tenth harmonic of fundamental frequency) was investigated
- (5) For final emissions measurements at each frequency of interest, the EUT were rotated and the antenna height was varied between 1m and 4m in order to maximize the emission. Measurements in both horizontal and vertical polarities were made and the data was recorded. In order to find the maximum emission, the relative positions of equipments and all of the interface cables were changed according to ANSI C63.4 :2014on Radiated Emission test.
- (6) For emissions above 1GHz, both Peak and Average level were measured with Spectrum Analyzer, and the RBW is set at 1MHz, VBW is set at 3MHz for Peak measure; RBW is set at 1MHz, VBW is set at 10Hz for Average measure.

8.4. Test Results

We have scanned the 10th harmonic from 9KHz to the EUT's highest frequency.. Detailed information please see the following page.

From 9KHz to 30MHz: Conclusion: PASS

Note: The amplitude of spurious emissions which are attenuated by more than 20dB below the permissible value has no need to be reported.

From 30MHz to 1000MHz: Conclusion: PASS

Site: LAB	Polarization: Horizontal	Temperature: 23.5
Limit: FCC Part15 Class B Radiation	Power:	Humidity: 51 %
EUT: Bluetooth Speaker	Distance: 3m	
M/N: YM-Z18		
Mode:		
Note:		

Radiated Emission Measurement

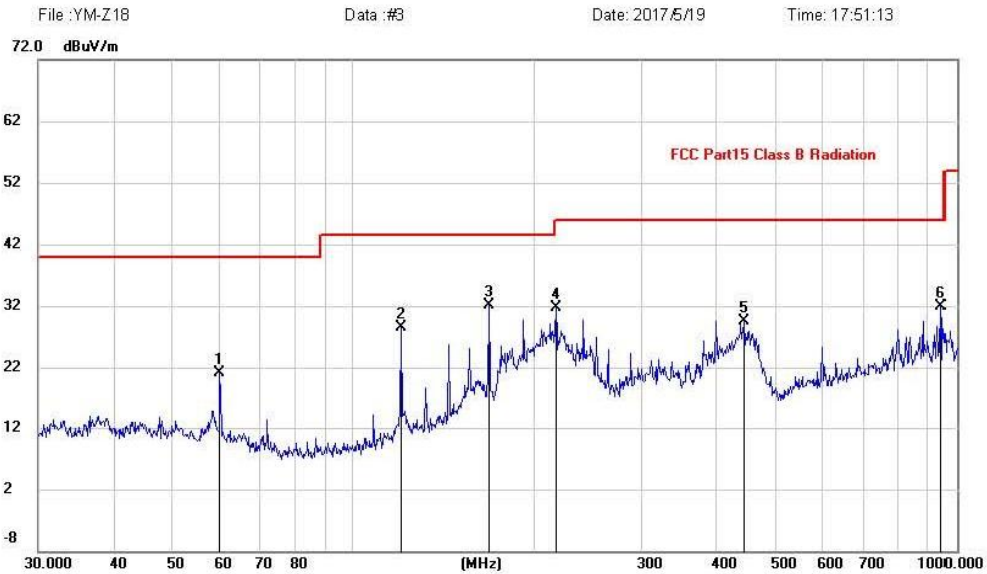

No.	Mk.	Freq.	Reading Level	Correct Factor	Measurement	Limit	Margin	Antenna Height	Table Degree	
		MHz	dBuV	dB	dBuV/m	dBuV/m	dB	cm	degree	Comment
1		59.8588	8.08	13.00	21.08	40.00	-18.92			peak
2		119.8556	15.88	12.58	28.46	43.50	-15.04			peak
3	*	168.4138	18.20	13.90	32.10	43.50	-11.40			peak
4		216.0240	20.57	11.06	31.63	46.00	-14.37			peak
5		444.8514	12.79	16.79	29.58	46.00	-16.42			peak
6		942.1305	8.81	23.18	31.99	46.00	-14.01			peak

Site: LAB	Polarization: Vertical	Temperature: 23.5
Limit: FCC Part15 Class B Radiation	Power:	Humidity: 51 %
EUT: Bluetooth Speaker	Distance: 3m	
M/N: YM-Z18		
Mode:		
Note:		

Radiated Emission Measurement



No.	Mk.	Freq. MHz	Reading Level dBuV	Correct Factor dB	Measure- ment dBuV/m	Limit dBuV/m	Margin dB	Detector	Antenna Height cm	Table Degree	Comment
1		57.3923	10.84	13.09	23.93	40.00	-16.07	peak			
2	*	119.8556	25.32	12.58	37.90	43.50	-5.60	QP			
3		143.8295	18.15	14.11	32.26	43.50	-11.24	peak			
4		168.4138	15.12	13.90	29.02	43.50	-14.48	peak			
5		475.4991	12.00	17.04	29.04	46.00	-16.96	peak			
6		903.3094	9.47	23.05	32.52	46.00	-13.48	peak			

Remark: All modes have been tested, and only worst data of GFSK mode, Channel 2402MHz was listed in this report.

1GHz—25GHz Radiated emission Test result									
EUT: Bluetooth speaker					M/N: YM-Z18				
Power: DC 3.7V from internal battery									
Test date: 2017-05-21 Test site: 3m Chamber Tested by: Reak									
Test mode: GFSK Tx CH1 2402MHz									
Antenna polarity: Vertical									
No	Freq (MHz)	Read Level (dBuV/m)	Antenna Factor (dB/m)	Cable loss(dB)	Amp Factor (dB)	Result (dBuV/m)	Limit (dBuV/m)	Margin (dB)	Remark
1	4804	46.79	33.95	10.18	34.26	56.66	74	17.34	PK
2	4804	36.05	33.95	10.18	34.26	45.92	54	8.08	AV
3	7206	/							
4	9608	/							
5	12010	/							
Antenna Polarity: Horizontal									
1	4804	47.52	33.95	10.18	34.26	57.39	74	16.61	PK
2	4804	34.29	33.95	10.18	34.26	44.16	54	9.84	AV
3	7206	/							
4	9608	/							
5	12010	/							
Note:									
1, Measuring frequency from 1GHz to 25GHz									
2, Spectrum Set for PK measure: RBW=1MHz, VBW=1MHz, Sweep time=Auto, Detector: PK									
2, Spectrum Set for AV measure: RBW=1MHz, VBW=10Hz, Sweep time=Auto, Detector: PK									
3, Result = Read level + Antenna factor + cable loss-Amp factor									
4, All the other emissions not reported were too low to read and deemed to comply with FCC limit.									

1GHz—25GHz Radiated emission Test result									
EUT: Bluetooth speaker					M/N: YM-Z18				
Power: DC 3.7V from internal battery									
Test date: 2017-05-21 Test site: 3m Chamber Tested by: Reak									
Test mode: GFSK Tx CH40 2441MHz									
Antenna polarity: Vertical									
No	Freq (MHz)	Read Level (dBuV/m)	Antenna Factor (dB/m)	Cable loss(dB)	Amp Factor (dB)	Result (dBuV/m)	Limit (dBuV/m)	Margin (dB)	Remark
1	4882	46.17	33.93	10.2	34.29	56.01	74	17.99	PK
2	4882	34.35	33.93	10.2	34.29	44.19	54	9.81	AV
3	7323	/							
4	9764	/							
5	12205	/							
Antenna Polarity: Horizontal									
1	4882	47.94	33.93	10.2	34.29	57.78	74	16.22	PK
2	4882	35.86	33.93	10.2	34.29	45.7	54	8.3	AV
3	7323	/							
4	9764	/							
5	12205	/							
Note:									
1, Measuring frequency from 1GHz to 25GHz									
2, Spectrum Set for PK measure: RBW=1MHz, VBW=1MHz, Sweep time=Auto, Detector: PK									
2, Spectrum Set for AV measure: RBW=1MHz, VBW=10Hz, Sweep time=Auto, Detector: PK									
3, Result = Read level + Antenna factor + cable loss-Amp factor									
4, All the other emissions not reported were too low to read and deemed to comply with FCC limit.									

1GHz—25GHz Radiated emission Test result									
EUT: Bluetooth speaker					M/N: YM-Z18				
Power: DC 3.7V from internal battery									
Test date: 2017-05-21 Test site: 3m Chamber Tested by: Reak									
Test mode: GFSK Tx CH79 2480MHz									
Antenna polarity: Vertical									
No	Freq (MHz)	Read Level (dBuV/m)	Antenna Factor (dB/m)	Cable loss(dB)	Amp Factor (dB)	Result (dBuV/m)	Limit (dBuV/m)	Margin (dB)	Remark
1	4960	46.03	33.98	10.22	34.25	55.98	74	18.02	PK
2	4960	34.18	33.98	10.22	34.25	44.13	54	9.87	AV
3	7440	/							
4	9920	/							
5	12400	/							
Antenna Polarity: Horizontal									
1	4960	45.56	33.98	10.22	34.25	55.51	74	18.49	PK
2	4960	36.25	33.98	10.22	34.25	46.2	54	7.8	AV
3	7440	/							
4	9920	/							
5	12400	/							
Note:									
1, Measuring frequency from 1GHz to 25GHz									
2, Spectrum Set for PK measure: RBW=1MHz, VBW=1MHz, Sweep time=Auto, Detector: PK									
2, Spectrum Set for AV measure: RBW=1MHz, VBW=10Hz, Sweep time=Auto, Detector: PK									
3, Result = Read level + Antenna factor + cable loss-Amp factor									
4, All the other emissions not reported were too low to read and deemed to comply with FCC limit.									

1GHz—25GHz Radiated emission Test result									
EUT: Bluetooth speaker					M/N: YM-Z18				
Power: DC 3.7V from internal battery									
Test date: 2017-05-21 Test site: 3m Chamber Tested by: Reak									
Test mode: π /4 DQPSK Tx CH1 2402MHz									
Antenna polarity: Vertical									
No	Freq (MHz)	Read Level (dBuV/m)	Antenna Factor (dB/m)	Cable loss(dB)	Amp Factor (dB)	Result (dBuV/m)	Limit (dBuV/m)	Margin (dB)	Remark
1	4804	47.27	33.95	10.18	34.26	57.14	74	16.86	PK
2	4804	35.43	33.95	10.18	34.26	45.3	54	8.7	AV
3	7206	/							
4	9608	/							
5	12010	/							
Antenna Polarity: Horizontal									
1	4804	47.05	33.95	10.18	34.26	56.92	74	17.08	PK
2	4804	35.21	33.95	10.18	34.26	45.08	54	8.92	AV
3	7206	/							
4	9608	/							
5	12010	/							
Note:									
1, Measuring frequency from 1GHz to 25GHz									
2, Spectrum Set for PK measure: RBW=1MHz, VBW=1MHz, Sweep time=Auto, Detector: PK									
2, Spectrum Set for AV measure: RBW=1MHz, VBW=10Hz, Sweep time=Auto, Detector: PK									
3, Result = Read level + Antenna factor + cable loss-Amp factor									
4, All the other emissions not reported were too low to read and deemed to comply with FCC limit.									

1GHz—25GHz Radiated emission Test result									
EUT: Bluetooth speaker					M/N: YM-Z18				
Power: DC 3.7V from internal battery									
Test date: 2017-05-21 Test site: 3m Chamber Tested by: Reak									
Test mode: $\pi/4$ DQPSK Tx CH40 2441MHz									
Antenna polarity: Vertical									
No	Freq (MHz)	Read Level (dBuV/m)	Antenna Factor (dB/m)	Cable loss(dB)	Amp Factor (dB)	Result (dBuV/m)	Limit (dBuV/m)	Margin (dB)	Remark
1	4882	46.34	33.93	10.2	34.29	56.18	74	17.82	PK
2	4882	34.9	33.93	10.2	34.29	44.74	54	9.26	AV
3	7323	/							
4	9764	/							
5	12205	/							
Antenna Polarity: Horizontal									
1	4882	47.67	33.93	10.2	34.29	57.51	74	16.49	PK
2	4882	33.26	33.93	10.2	34.29	43.1	54	10.9	AV
3	7323	/							
4	9764	/							
5	12205	/							
Note:									
1, Measuring frequency from 1GHz to 25GHz									
2, Spectrum Set for PK measure: RBW=1MHz, VBW=1MHz, Sweep time=Auto, Detector: PK									
2, Spectrum Set for AV measure: RBW=1MHz, VBW=10Hz, Sweep time=Auto, Detector: PK									
3, Result = Read level + Antenna factor + cable loss-Amp factor									
4, All the other emissions not reported were too low to read and deemed to comply with FCC limit.									

1GHz—25GHz Radiated emission Test result									
EUT: Bluetooth speaker					M/N: YM-Z18				
Power: DC 3.7V from internal battery									
Test date: 2017-05-21 Test site: 3m Chamber Tested by: Reak									
Test mode: $\pi/4$ DQPSK Tx CH79 2480MHz									
Antenna polarity: Vertical									
No	Freq (MHz)	Read Level (dBuV/m)	Antenna Factor (dB/m)	Cable loss(dB)	Amp Factor (dB)	Result (dBuV/m)	Limit (dBuV/m)	Margin (dB)	Remark
1	4960	45.79	33.98	10.22	34.25	55.74	74	18.26	PK
2	4960	34.01	33.98	10.22	34.25	43.96	54	10.04	AV
3	7440	/							
4	9920	/							
5	12400	/							
Antenna Polarity: Horizontal									
1	4960	46.82	33.98	10.22	34.25	56.77	74	17.23	PK
2	4960	35.45	33.98	10.22	34.25	45.4	54	8.6	AV
3	7440	/							
4	9920	/							
5	12400	/							
Note:									
1, Measuring frequency from 1GHz to 25GHz									
2, Spectrum Set for PK measure: RBW=1MHz, VBW=1MHz, Sweep time=Auto, Detector: PK									
2, Spectrum Set for AV measure: RBW=1MHz, VBW=10Hz, Sweep time=Auto, Detector: PK									
3, Result = Read level + Antenna factor + cable loss-Amp factor									
4, All the other emissions not reported were too low to read and deemed to comply with FCC limit.									

1GHz—25GHz Radiated emission Test result									
EUT: Bluetooth speaker					M/N: YM-Z18				
Power: DC 3.7V from internal battery									
Test date: 2017-05-21 Test site: 3m Chamber Tested by: Reak									
Test mode: 8- DQPSK Tx CH1 2402MHz									
Antenna polarity: Vertical									
No	Freq (MHz)	Read Level (dBuV/m)	Antenna Factor (dB/m)	Cable loss(dB)	Amp Factor (dB)	Result (dBuV/m)	Limit (dBuV/m)	Margin (dB)	Remark
1	4804	46.59	33.95	10.18	34.26	56.46	74	17.54	PK
2	4804	35.16	33.95	10.18	34.26	45.03	54	8.97	AV
3	7206	/							
4	9608	/							
5	12010	/							
Antenna Polarity: Horizontal									
1	4804	47.64	33.95	10.18	34.26	57.51	74	16.49	PK
2	4804	35.59	33.95	10.18	34.26	45.46	54	8.54	AV
3	7206	/							
4	9608	/							
5	12010	/							
Note:									
1, Measuring frequency from 1GHz to 25GHz									
2, Spectrum Set for PK measure: RBW=1MHz, VBW=1MHz, Sweep time=Auto, Detector: PK									
2, Spectrum Set for AV measure: RBW=1MHz, VBW=10Hz, Sweep time=Auto, Detector: PK									
3, Result = Read level + Antenna factor + cable loss-Amp factor									
4, All the other emissions not reported were too low to read and deemed to comply with FCC limit.									

1GHz—25GHz Radiated emission Test result									
EUT: Bluetooth speaker					M/N: YM-Z18				
Power: DC 3.7V from internal battery									
Test date: 2017-05-21 Test site: 3m Chamber Tested by: Reak									
Test mode: 8- DQPSK Tx CH40 2441MHz									
Antenna polarity: Vertical									
No	Freq (MHz)	Read Level (dBuV/m)	Antenna Factor (dB/m)	Cable loss(dB)	Amp Factor (dB)	Result (dBuV/m)	Limit (dBuV/m)	Margin (dB)	Remark
1	4882	46.73	33.93	10.2	34.29	56.57	74	17.43	PK
2	4882	34.28	33.93	10.2	34.29	44.12	54	9.88	AV
3	7323	/							
4	9764	/							
5	12205	/							
Antenna Polarity: Horizontal									
1	4882	47.81	33.93	10.2	34.29	57.65	74	16.35	PK
2	4882	34.08	33.93	10.2	34.29	43.92	54	10.08	AV
3	7323	/							
4	9764	/							
5	12205	/							
Note:									
1, Measuring frequency from 1GHz to 25GHz									
2, Spectrum Set for PK measure: RBW=1MHz, VBW=1MHz, Sweep time=Auto, Detector: PK									
2, Spectrum Set for AV measure: RBW=1MHz, VBW=10Hz, Sweep time=Auto, Detector: PK									
3, Result = Read level + Antenna factor + cable loss-Amp factor									
4, All the other emissions not reported were too low to read and deemed to comply with FCC limit.									

1GHz—25GHz Radiated emission Test result									
EUT: Bluetooth speaker					M/N: YM-Z18				
Power: DC 3.7V from internal battery									
Test date: 2017-05-21 Test site: 3m Chamber Tested by: Reak									
Test mode: 8- DQPSK Tx CH79 2480MHz									
Antenna polarity: Vertical									
No	Freq (MHz)	Read Level (dBuV/m)	Antenna Factor (dB/m)	Cable loss(dB)	Amp Factor (dB)	Result (dBuV/m)	Limit (dBuV/m)	Margin (dB)	Remark
1	4960	45.27	33.98	10.22	34.25	55.22	74	18.78	PK
2	4960	34.73	33.98	10.22	34.25	44.68	54	9.32	AV
3	7440	/							
4	9920	/							
5	12400	/							
Antenna Polarity: Horizontal									
1	4960	46.43	33.98	10.22	34.25	56.38	74	17.62	PK
2	4960	34.76	33.98	10.22	34.25	44.71	54	9.29	AV
3	7440	/							
4	9920	/							
5	12400	/							
Note:									
1, Measuring frequency from 1GHz to 25GHz									
2, Spectrum Set for PK measure: RBW=1MHz, VBW=1MHz, Sweep time=Auto, Detector: PK									
2, Spectrum Set for AV measure: RBW=1MHz, VBW=10Hz, Sweep time=Auto, Detector: PK									
3, Result = Read level + Antenna factor + cable loss-Amp factor									
4, All the other emissions not reported were too low to read and deemed to comply with FCC limit.									

9. Band Edge Compliance

9.1. Block Diagram of Test Setup

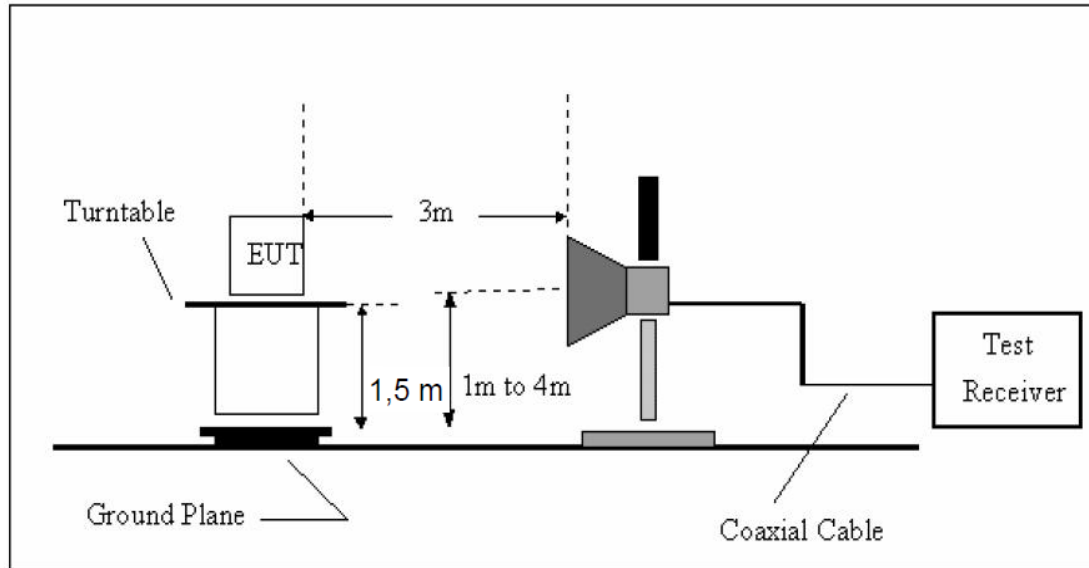

9.2. Limit

All the lower and upper band-edges emissions appearing within restricted frequency bands shall not exceed the limits shown in 15.209, all the other emissions outside operation shall be at least 20dB below the fundamental emissions, or comply with 15.209 limits.

9.3. Test Procedure

All restriction band and non- restriction band have been tested , only worse case is reported.

9.4. Test Results

PASS. (See below detailed test data)

Radiated Method

GFSK (CH Low)

Band Edge Test result								
EUT: Bluetooth speaker				M/N: YM-Z18				
Power: DC 3.7V from internal battery								
Test date: 2017-05-21 Test site: 3m Chamber Tested by: Reak								
Test mode: Tx CH Low 2402MHz								
Antenna polarity: Vertical								
Freq (MHz)	Read Level (dBuV/m)	Antenna Factor (dB/m)	Cable loss(dB)	Amp Factor (dB)	Result (dBuV/m)	Limit (dBuV/m)	Margin (dB)	Remark
2390	45.23	27.62	3.92	34.97	41.8	74	32.2	PK
Antenna Polarity: Horizontal								
2390	42.91	27.62	3.92	34.97	39.48	74	34.52	PK
Note:								
1, Spectrum Set for PK measure: RBW=1MHz, VBW=1MHz, Sweep time=Auto, Detector: PK								
2, Spectrum Set for AV measure: RBW=1MHz, VBW=10Hz, Sweep time=Auto, Detector: PK								
3, Result = Read level + Antenna factor + cable loss-Amp factor								
4, All the other emissions not reported were too low to read and deemed to comply with FCC limit.								

GFSK (CH High)

Band Edge Test result								
EUT: Bluetooth speaker				M/N: YM-Z18				
Power: DC 3.7V from internal battery								
Test date: 2017-05-21 Test site: 3m Chamber Tested by: Reak								
Test mode: Tx CH High 2480MHz								
Antenna polarity: Vertical								
Freq (MHz)	Read Level (dBuV/m)	Antenna Factor (dB/m)	Cable loss(dB)	Amp Factor (dB)	Result (dBuV/m)	Limit (dBuV/m)	Margin (dB)	Remark
2483.5	43.59	27.89	4	34.97	40.51	74	33.49	PK
Antenna Polarity: Horizontal								
2483.5	42.97	27.89	4	34.97	39.89	74	34.11	PK
Note:								
1, Spectrum Set for PK measure: RBW=1MHz, VBW=1MHz, Sweep time=Auto, Detector: PK								
2, Spectrum Set for AV measure: RBW=1MHz, VBW=10Hz, Sweep time=Auto, Detector: PK								
3, Result = Read level + Antenna factor + cable loss-Amp factor								
4, All the other emissions not reported were too low to read and deemed to comply with FCC limit.								

GFSK (Hopping Low)

Band Edge Test result								
EUT: Bluetooth speaker				M/N: YM-Z18				
Power: DC 3.7V from internal battery								
Test date: 2017-05-21 Test site: 3m Chamber Tested by: Reak								
Test mode: Tx CH Low 2402MHz								
Antenna polarity: Vertical								
Freq (MHz)	Read Level (dBuV/m)	Antenna Factor (dB/m)	Cable loss(dB)	Amp Factor (dB)	Result (dBuV/m)	Limit (dBuV/m)	Margin (dB)	Remark
2390	43.96	27.62	3.92	34.97	40.53	74	33.47	PK
Antenna Polarity: Horizontal								
2390	43.11	27.62	3.92	34.97	39.68	74	34.32	PK
Note:								
1, Spectrum Set for PK measure: RBW=1MHz, VBW=1MHz, Sweep time=Auto, Detector: PK								
2, Spectrum Set for AV measure: RBW=1MHz, VBW=10Hz, Sweep time=Auto, Detector: PK								
3, Result = Read level + Antenna factor + cable loss-Amp factor								
4, All the other emissions not reported were too low to read and deemed to comply with FCC limit.								

GFSK (Hopping High)

Band Edge Test result								
EUT: Bluetooth speaker				M/N: YM-Z18				
Power: DC 3.7V from internal battery								
Test date: 2017-05-21 Test site: 3m Chamber Tested by: Reak								
Test mode: Tx CH High 2480MHz								
Antenna polarity: Vertical								
Freq (MHz)	Read Level (dBuV/m)	Antenna Factor (dB/m)	Cable loss(dB)	Amp Factor (dB)	Result (dBuV/m)	Limit (dBuV/m)	Margin (dB)	Remark
2483.5	44.26	27.89	4	34.97	41.18	74	32.82	PK
Antenna Polarity: Horizontal								
2483.5	41.17	27.89	4	34.97	38.09	74	35.91	PK
Note:								
1, Spectrum Set for PK measure: RBW=1MHz, VBW=1MHz, Sweep time=Auto, Detector: PK								
2, Spectrum Set for AV measure: RBW=1MHz, VBW=10Hz, Sweep time=Auto, Detector: PK								
3, Result = Read level + Antenna factor + cable loss-Amp factor								
4, All the other emissions not reported were too low to read and deemed to comply with FCC limit.								

π /4 DQPSK (CH Low)

Band Edge Test result								
EUT: Bluetooth speaker			M/N: YM-Z18					
Power: DC 3.7V from internal battery								
Test date: 2017-05-21 Test site: 3m Chamber Tested by: Reak								
Test mode: Tx CH Low 2402MHz								
Antenna polarity: Vertical								
Freq (MHz)	Read Level (dBuV/m)	Antenna Factor (dB/m)	Cable loss(dB)	Amp Factor (dB)	Result (dBuV/m)	Limit (dBuV/m)	Margin (dB)	Remark
2390	41.75	27.62	3.92	34.97	38.32	74	35.68	PK
Antenna Polarity: Horizontal								
2390	42.71	27.62	3.92	34.97	39.28	74	34.72	PK
<p>Note:</p> <p>1, Spectrum Set for PK measure: RBW=1MHz, VBW=1MHz, Sweep time=Auto, Detector: PK</p> <p>2, Spectrum Set for AV measure: RBW=1MHz, VBW=10Hz, Sweep time=Auto, Detector: PK</p> <p>3, Result = Read level + Antenna factor + cable loss-Amp factor</p> <p>4, All the other emissions not reported were too low to read and deemed to comply with FCC limit.</p>								

π /4 DQPSK (CH High)

Band Edge Test result								
EUT: Bluetooth speaker				M/N: YM-Z18				
Power: DC 3.7V from internal battery								
Test date: 2017-05-21 Test site: 3m Chamber Tested by: Reak								
Test mode: Tx CH High 2480MHz								
Antenna polarity: Vertical								
Freq (MHz)	Read Level (dBuV/m)	Antenna Factor (dB/m)	Cable loss(dB)	Amp Factor (dB)	Result (dBuV/m)	Limit (dBuV/m)	Margin (dB)	Remark
2483.5	41.91	27.89	4	34.97	38.83	74	35.17	PK
Antenna Polarity: Horizontal								
2483.5	42.29	27.89	4	34.97	39.21	74	34.79	PK
Note:								
1, Spectrum Set for PK measure: RBW=1MHz, VBW=1MHz, Sweep time=Auto, Detector: PK								
2, Spectrum Set for AV measure: RBW=1MHz, VBW=10Hz, Sweep time=Auto, Detector: PK								
3, Result = Read level + Antenna factor + cable loss-Amp factor								
4, All the other emissions not reported were too low to read and deemed to comply with FCC limit.								

$\pi/4$ DQPSK (Hopping Low)

Band Edge Test result								
EUT: Bluetooth speaker				M/N: YM-Z18				
Power: DC 3.7V from internal battery								
Test date: 2017-05-21 Test site: 3m Chamber Tested by: Reak								
Test mode: Tx CH Low 2402MHz								
Antenna polarity: Vertical								
Freq (MHz)	Read Level (dBUV/m)	Antenna Factor (dB/m)	Cable loss(dB)	Amp Factor (dB)	Result (dBUV/m)	Limit (dBUV/m)	Margin (dB)	Remark
2390	42.82	27.62	3.92	34.97	39.39	74	34.61	PK
Antenna Polarity: Horizontal								
2390	42.35	27.62	3.92	34.97	38.92	74	35.08	PK
<p>Note:</p> <p>1, Spectrum Set for PK measure: RBW=1MHz, VBW=1MHz, Sweep time=Auto, Detector: PK</p> <p>2, Spectrum Set for AV measure: RBW=1MHz, VBW=10Hz, Sweep time=Auto, Detector: PK</p> <p>3, Result = Read level + Antenna factor + cable loss-Amp factor</p> <p>4, All the other emissions not reported were too low to read and deemed to comply with FCC limit.</p>								

π /4 DQPSK (Hopping High)

Band Edge Test result								
EUT: Bluetooth speaker				M/N: YM-Z18				
Power: DC 3.7V from internal battery								
Test date: 2017-05-21			Test site: 3m Chamber			Tested by: Reak		
Test mode: Tx CH High 2480MHz								
Antenna polarity: Vertical								
Freq (MHz)	Read Level (dBuV/m)	Antenna Factor (dB/m)	Cable loss(dB)	Amp Factor (dB)	Result (dBuV/m)	Limit (dBuV/m)	Margin (dB)	Remark
2483.5	43.44	27.89	4	34.97	40.36	74	33.64	PK
Antenna Polarity: Horizontal								
2483.5	41.18	27.89	4	34.97	38.1	74	35.9	PK
Note:								
1, Spectrum Set for PK measure: RBW=1MHz, VBW=1MHz, Sweep time=Auto, Detector: PK								
2, Spectrum Set for AV measure: RBW=1MHz, VBW=10Hz, Sweep time=Auto, Detector: PK								
3, Result = Read level + Antenna factor + cable loss-Amp factor								
4, All the other emissions not reported were too low to read and deemed to comply with FCC limit.								

8- DPSK (CH Low)

Band Edge Test result								
EUT: Bluetooth speaker				M/N: YM-Z18				
Power: DC 3.7V from internal battery								
Test date: 2017-05-21 Test site: 3m Chamber Tested by: Reak								
Test mode: Tx CH Low 2402MHz								
Antenna polarity: Vertical								
Freq (MHz)	Read Level (dBuV/m)	Antenna Factor (dB/m)	Cable loss(dB)	Amp Factor (dB)	Result (dBuV/m)	Limit (dBuV/m)	Margin (dB)	Remark
2390	43.46	27.62	3.92	34.97	40.03	74	33.97	PK
Antenna Polarity: Horizontal								
2390	41.89	27.62	3.92	34.97	38.46	74	35.54	PK
Note:								
1, Spectrum Set for PK measure: RBW=1MHz, VBW=1MHz, Sweep time=Auto, Detector: PK								
2, Spectrum Set for AV measure: RBW=1MHz, VBW=10Hz, Sweep time=Auto, Detector: PK								
3, Result = Read level + Antenna factor + cable loss-Amp factor								
4, All the other emissions not reported were too low to read and deemed to comply with FCC limit.								

8- DPSK (CH High)

Band Edge Test result								
EUT: Bluetooth speaker				M/N: YM-Z18				
Power: DC 3.7V from internal battery								
Test date: 2017-05-21			Test site: 3m Chamber			Tested by: Reak		
Test mode: Tx CH High 2480MHz								
Antenna polarity: Vertical								
Freq (MHz)	Read Level (dBuV/m)	Antenna Factor (dB/m)	Cable loss(dB)	Amp Factor (dB)	Result (dBuV/m)	Limit (dBuV/m)	Margin (dB)	Remark
2483.5	45.87	27.89	4	34.97	42.79	74	31.21	PK
Antenna Polarity: Horizontal								
2483.5	43.64	27.89	4	34.97	40.56	74	33.44	PK
Note:								
1, Spectrum Set for PK measure: RBW=1MHz, VBW=1MHz, Sweep time=Auto, Detector: PK								
2, Spectrum Set for AV measure: RBW=1MHz, VBW=10Hz, Sweep time=Auto, Detector: PK								
3, Result = Read level + Antenna factor + cable loss-Amp factor								
4, All the other emissions not reported were too low to read and deemed to comply with FCC limit.								

8- DPSK (Hopping Low)

Band Edge Test result								
EUT: Bluetooth speaker				M/N: YM-Z18				
Power: DC 3.7V from internal battery								
Test date: 2017-05-21			Test site: 3m Chamber			Tested by: Reak		
Test mode: Tx CH Low 2402MHz								
Antenna polarity: Vertical								
Freq (MHz)	Read Level (dBuV/m)	Antenna Factor (dB/m)	Cable loss(dB)	Amp Factor (dB)	Result (dBuV/m)	Limit (dBuV/m)	Margin (dB)	Remark
2390	42.5	27.62	3.92	34.97	39.07	74	34.93	PK
Antenna Polarity: Horizontal								
2390	44.03	27.62	3.92	34.97	40.6	74	33.4	PK
Note:								
1, Spectrum Set for PK measure: RBW=1MHz, VBW=1MHz, Sweep time=Auto, Detector: PK								
2, Spectrum Set for AV measure: RBW=1MHz, VBW=10Hz, Sweep time=Auto, Detector: PK								
3, Result = Read level + Antenna factor + cable loss-Amp factor								
4, All the other emissions not reported were too low to read and deemed to comply with FCC limit.								

8- DPSK (Hopping High)

Band Edge Test result								
EUT: Bluetooth speaker				M/N: YM-Z18				
Power: DC 3.7V from internal battery								
Test date: 2017-05-21 Test site: 3m Chamber Tested by: Reak								
Test mode: Tx CH High 2480MHz								
Antenna polarity: Vertical								
Freq (MHz)	Read Level (dBuV/m)	Antenna Factor (dB/m)	Cable loss(dB)	Amp Factor (dB)	Result (dBuV/m)	Limit (dBuV/m)	Margin (dB)	Remark
2483.5	41.99	27.89	4	34.97	38.91	74	35.09	PK
Antenna Polarity: Horizontal								
2483.5	40.61	27.89	4	34.97	37.53	74	36.47	PK
Note:								
1, Spectrum Set for PK measure: RBW=1MHz, VBW=1MHz, Sweep time=Auto, Detector: PK								
2, Spectrum Set for AV measure: RBW=1MHz, VBW=10Hz, Sweep time=Auto, Detector: PK								
3, Result = Read level + Antenna factor + cable loss-Amp factor								
4, All the other emissions not reported were too low to read and deemed to comply with FCC limit.								

Conducted Method

GFSK

CH LOW :

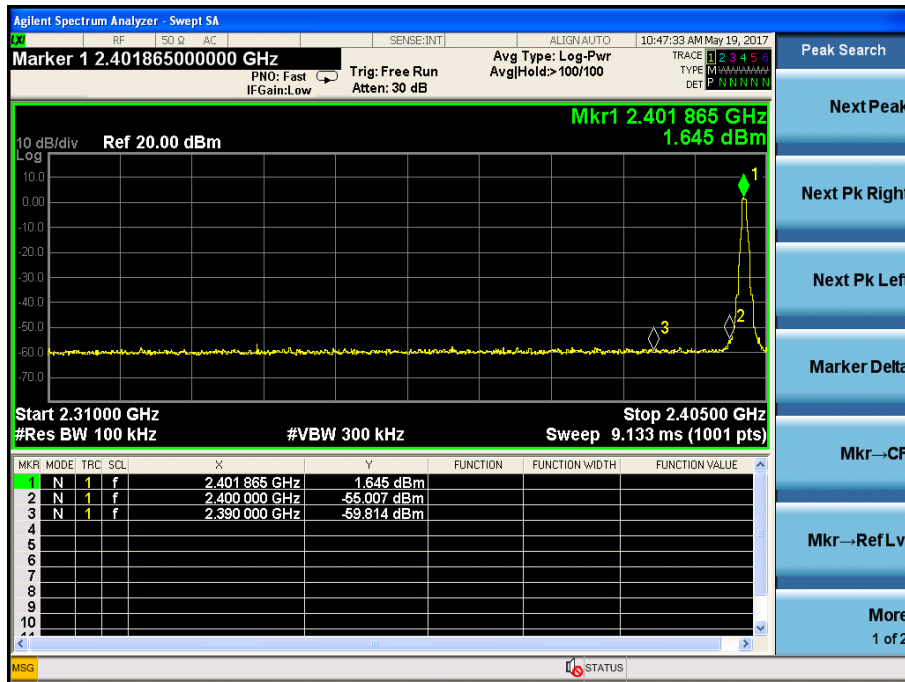

CH High :

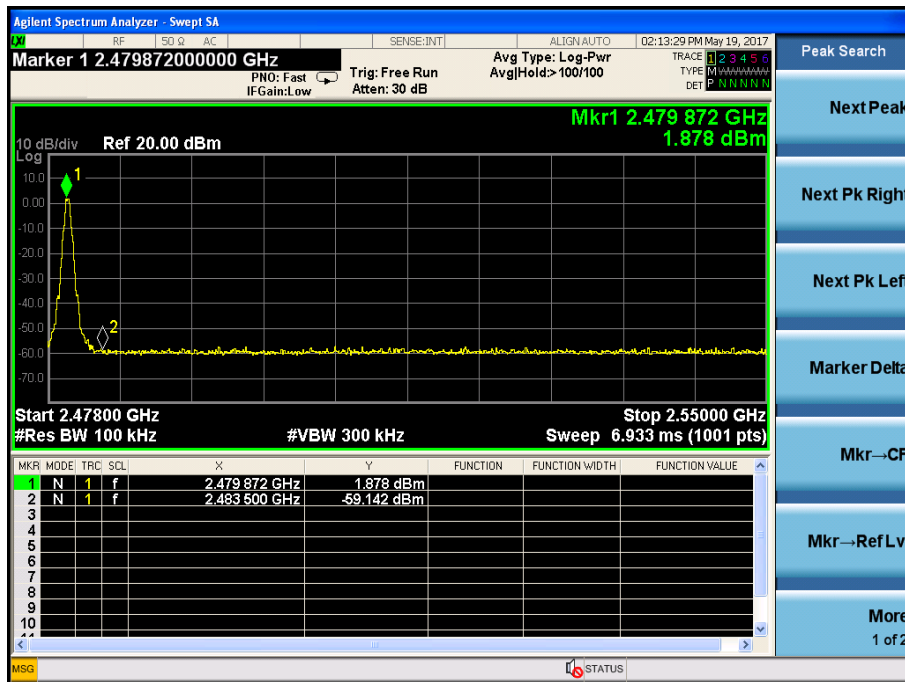

Hopping
Low

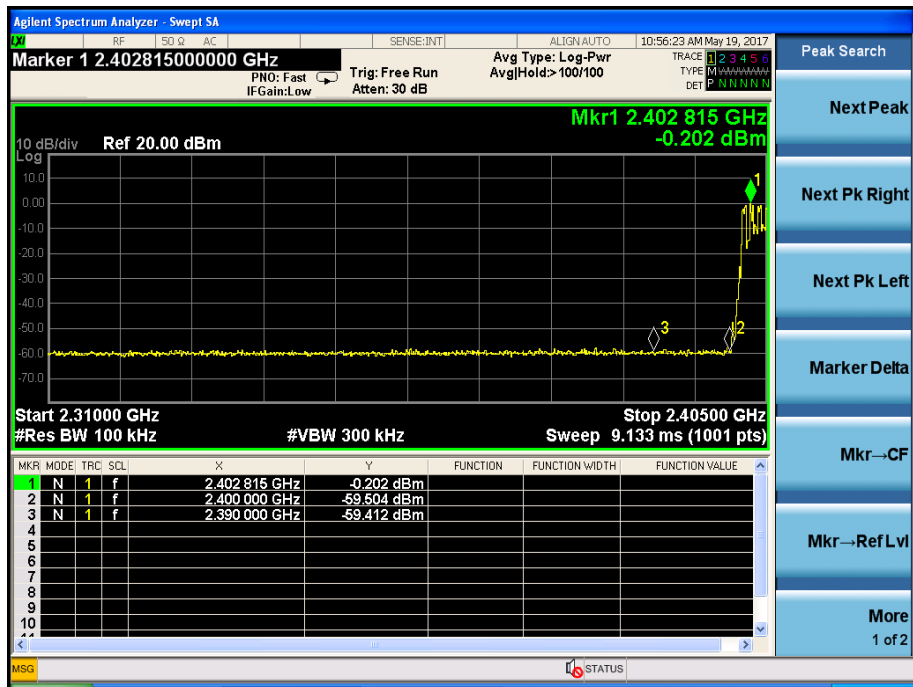

High

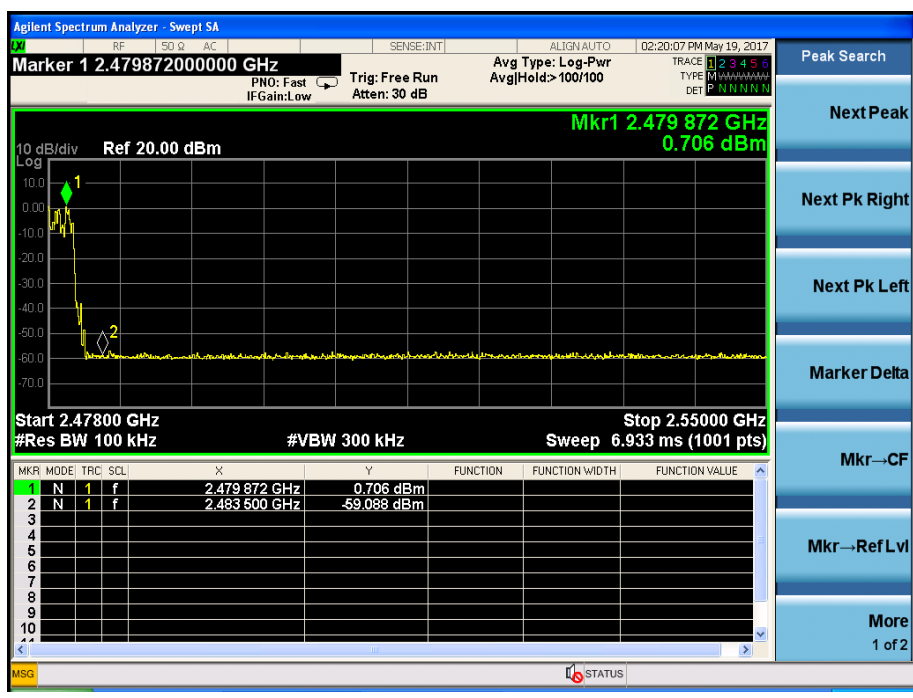

Hopping
Low

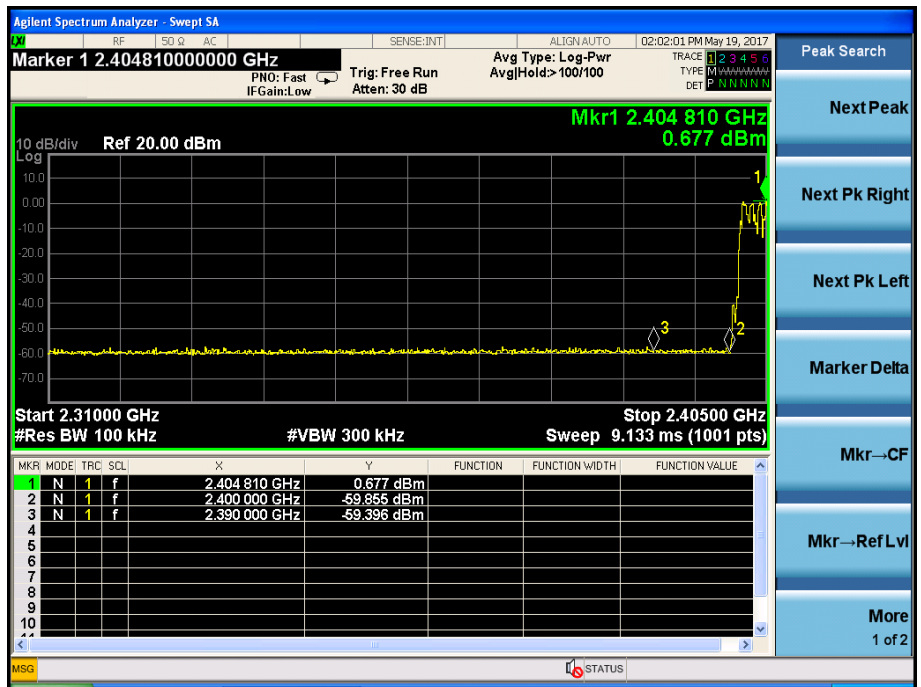

High

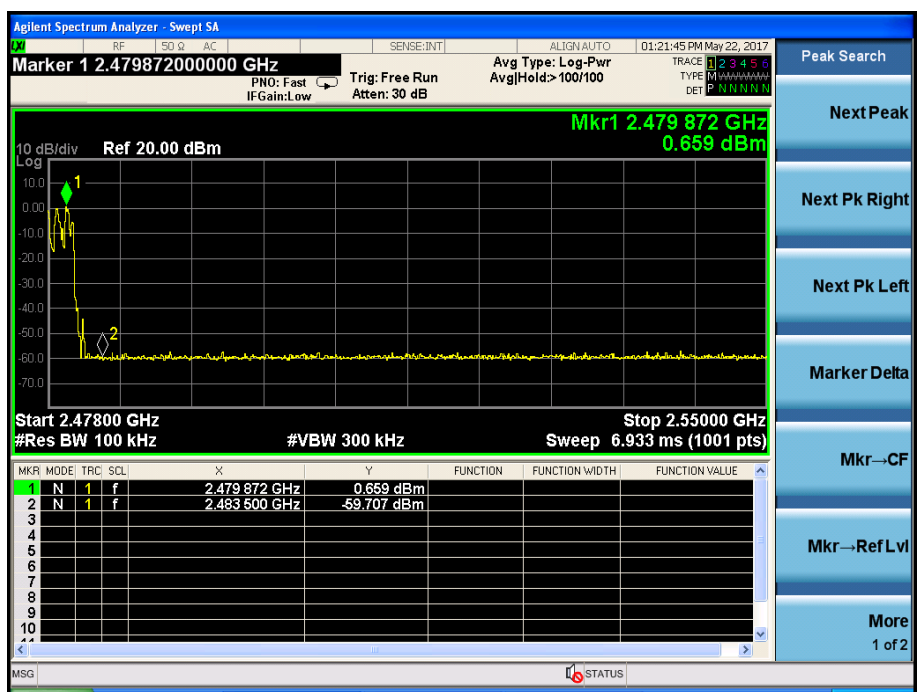

10. Power Line Conducted Emissions

10.1. Conducted Emission Limits(15.207)

Frequency MHz	Limits dB(μ V)	
	Quasi-peak Level	Average Level
0.15 -0.50	66 -56*	56 - 46*
0.50 -5.00	56	46
5.00 -30.00	60	50

- Notes: 1. *Decreasing linearly with logarithm of frequency.
2. The lower limit shall apply at the transition frequencies.
3. The limit decreases in line with the logarithm of the frequency in rang of 0.15 to 0.50 MHz.

10.2. Block Diagram of Test Setup

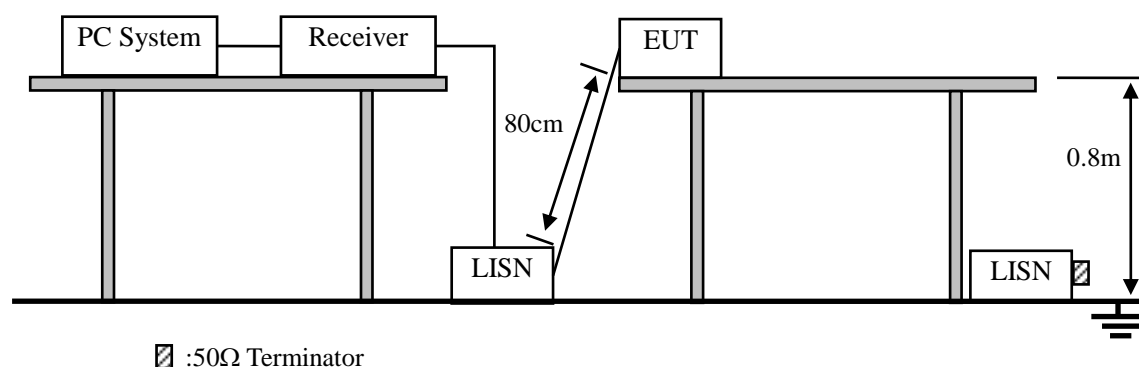

10.3. Test Procedure

- (1) The EUT was placed on a non-metallic table, 80cm above the ground plane.
- (2) Setup the EUT and simulator as shown in 10.1
- (3) The EUT Power connected to the power mains through a power adapter and a line impedance stabilization network (L.I.S.N1). The other peripheral devices power cord connected to the power mains through a line impedance stabilization network (L.I.S.N2), this provided a 50-ohm coupling impedance for the EUT (Please refer to the block diagram of the test setup and photographs). Both sides of power line were checked for maximum conducted interference. In order to find the maximum emission, the relative positions of equipments and all of the interface cables were changed according to ANSI C63.4 :2014on conducted Emission test.
- (4) The bandwidth of test receiver is set at 10KHz.
- (5) The frequency range from 150 KHz to 30MHz is checked.

10.4. Test Results

PASS (See below detailed test data)

Site: LAB
 Limit: FCC Part 15 CLASS B QP
 EUT: Bluetooth Speaker
 M/N: YM-Z18
 Mode:
 Note:

Phase: **N**
 Power:
 Temperature: 24.2
 Humidity: 53 %

Conducted Emission Measurement

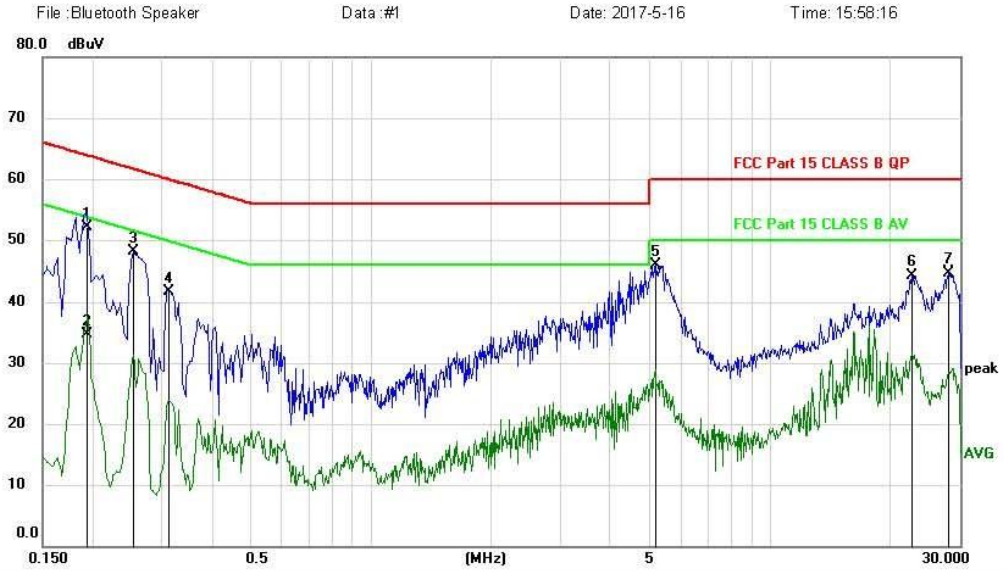

No.	Mk.	Freq. MHz	Reading Level dBuV	Correct Factor dB	Measure- ment dBuV	Limit dBuV	Margin dB	Detector	Comment
1	*	0.1949	42.45	9.67	52.12	63.83	-11.71	QP	
2		0.1949	25.02	9.67	34.69	53.83	-19.14	AVG	
3		0.2535	38.32	9.69	48.01	61.64	-13.63	peak	
4		0.3120	32.10	9.70	41.80	59.92	-18.12	peak	
5		5.2125	35.64	10.17	45.81	60.00	-14.19	peak	
6		22.7220	33.61	10.63	44.24	60.00	-15.76	peak	
7		28.0455	33.84	10.90	44.74	60.00	-15.26	peak	

Site: LAB
 Limit: FCC Part 15 CLASS B QP
 EUT: Bluetooth Speaker
 M/N: YM-Z18
 Mode:
 Note:

Phase: L1
 Power:

Temperature: 24.2
 Humidity: 53 %

Conducted Emission Measurement

File: Bluetooth Speaker

Data: #2

Date: 2017-5-16

Time: 16:00:31

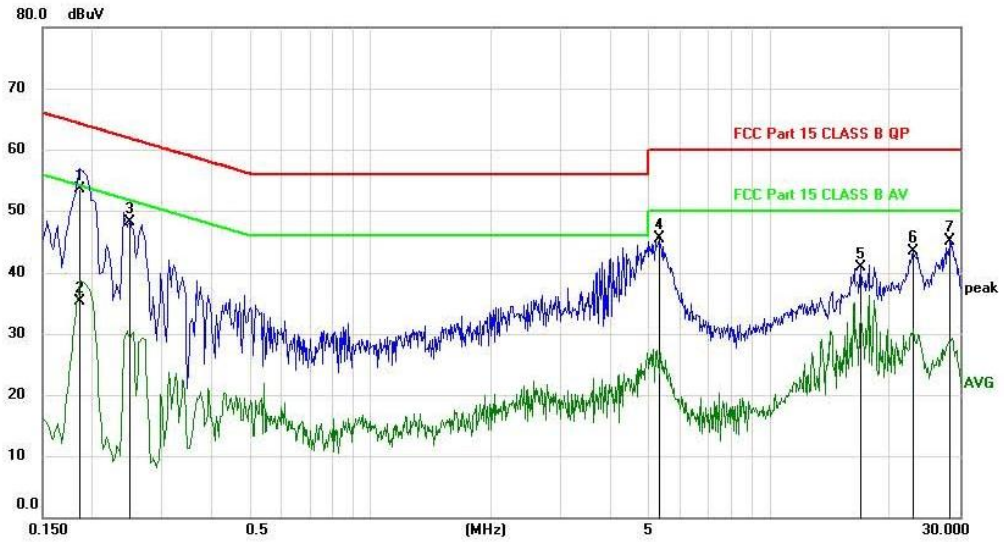

No.	Mk.	Freq. MHz	Reading Level dBuV	Correct Factor dB	Measure- ment dBuV	Limit dBuV	Margin dB	Detector	Comment
1	*	0.1860	43.79	9.67	53.46	64.21	-10.75	QP	
2		0.1860	25.68	9.67	35.35	54.21	-18.86	AVG	
3		0.2490	38.48	9.69	48.17	61.79	-13.62	peak	
4		5.2845	35.27	10.17	45.44	60.00	-14.56	peak	
5		16.9035	30.46	10.44	40.90	60.00	-19.10	peak	
6		22.8255	32.81	10.63	43.44	60.00	-16.56	peak	
7		28.1985	34.22	10.91	45.13	60.00	-14.87	peak	

11. Antenna Requirements

11.1. Standard Requirement

For intentional device, according to FCC 47 CFR Section 15.203, an intentional radiator shall be designed to ensure that no antenna other than that furnished by the responsible party shall be used with the device. And according to FCC 47 CFR Section 15.247 (b), if transmitting antennas of directional gain greater than 6dBi are used, the power shall be reduced by the amount in dB that the directional gain of the antenna exceeds 6dBi.

11.2. Antenna Connected Construction

The antenna is PCB antenna and no consideration of replacement. Please see EUT photo for details.

11.3. Results

The EUT antenna is PCB Antenna. It comply with the standard requirement.

12. Test setup photo

12.1. Photos of Radiated emission

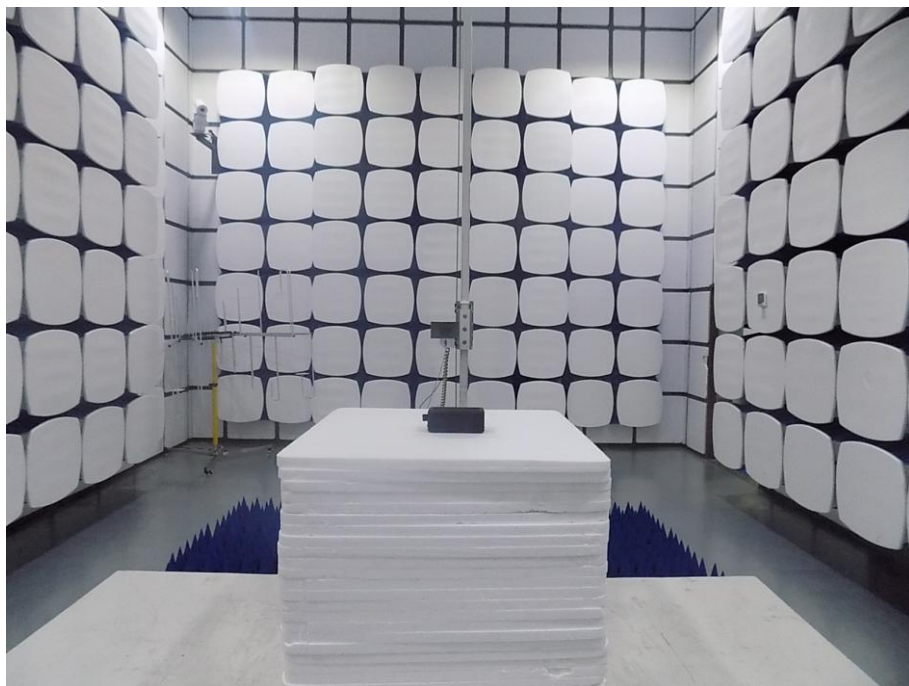
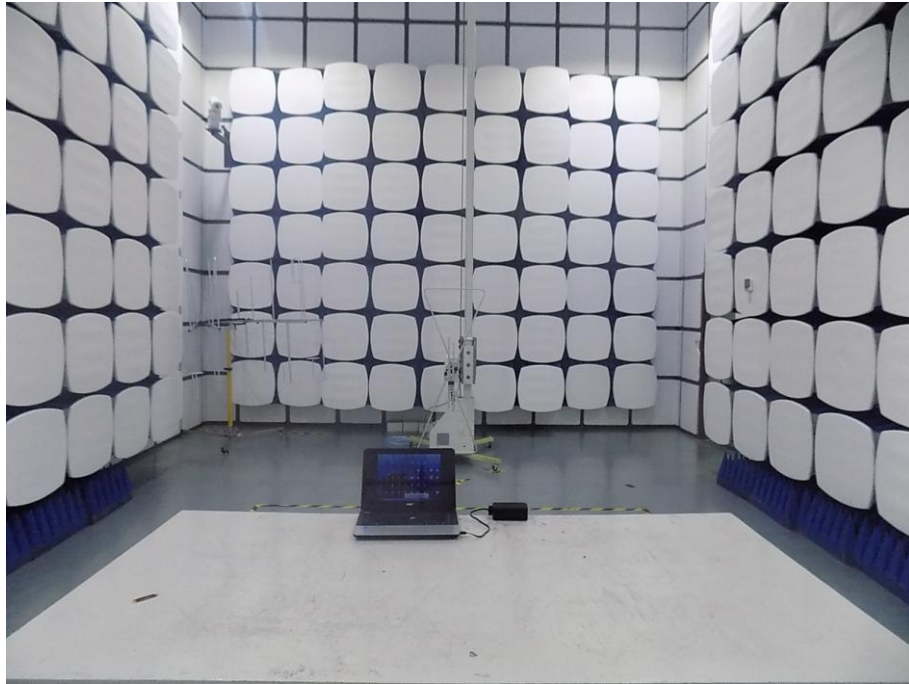

12.2.Photos of Conducted Emission test

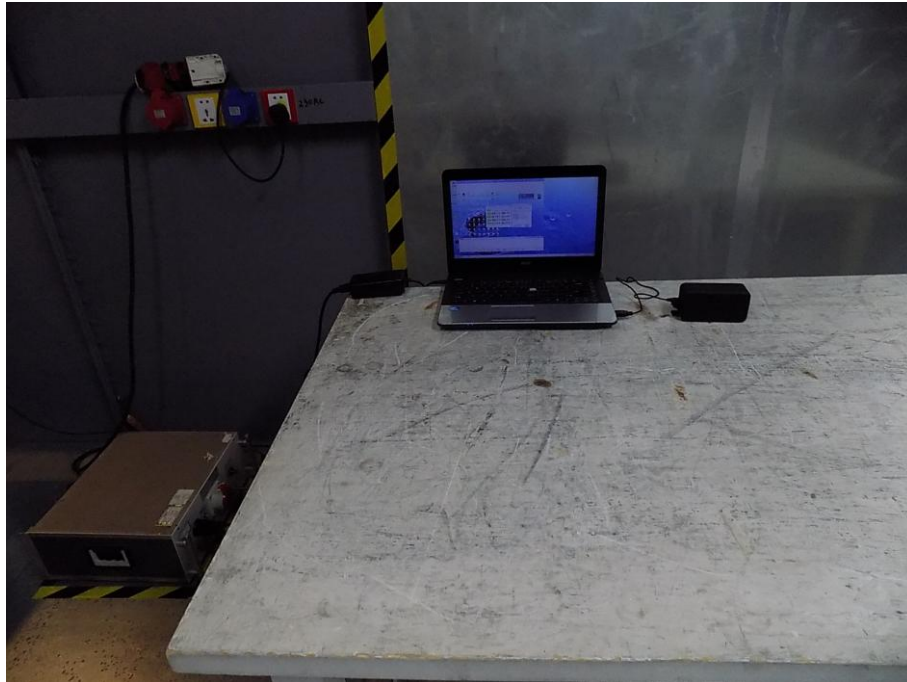

13.Photos of EUT



-----END OF REPORT-----