



FCC Part 15C Test Report

FCC ID:R8HYM-C06

Product Name:	spabluetooth speaker
Trademark:	N/A
Model Name :	YM-C06
Serial Model:	SP190, DP-1826
Prepared For :	Shenzhen XinHuaMei Electronics Limited Company
Address :	Bldg 5, Taifeng Industrial Park, No.10, Jianan Road, Shajing Sub-district, Baoan District, Shenzhen, China
Prepared By :	Shenzhen BCTC Technology Co., Ltd.
Address :	No.101, Yousong Road, Longhua New District, Shenzhen,China
Test Date:	May 24 – Jul. 05, 2017
Date of Report :	Jul. 05, 2017
Report No.:	BCTC-FY170805511E



VERIFICATION OF COMPLIANCE

Applicant's name.....: **Shenzhen XinHuaMei Electronics Limited Company**
Address: Bldg 5, Taifeng Industrial Park, No.10, Jianan Road, Shajing
 Sub-district, Baoan District, Shenzhen, China

Manufacture's Name: **Shenzhen XinHuaMei Electronics Limited Company**
Address: Bldg 5, Taifeng Industrial Park, No.10, Jianan Road, Shajing
 Sub-district, Baoan District, Shenzhen, China

Product description

Product name : spabluetooth speaker
Trademark: N/A
Model Name: YM-C06
Serial Model: SP190, DP-1826
Standards: FCC Part15.249
 ANSI C63.10-2013

This device described above has been tested by BCTC, and the test results show that the equipment under test (EUT) is in compliance with the FCC requirements. And it is applicable only to the tested sample identified in the report.

This report shall not be reproduced except in full, without the written approval of BCTC, this document may be altered or revised by BCTC, personal only, and shall be noted in the revision of the document.

Test Result : **Pass**

Prepared by (Engineer)	Eric Yang	<i>Eric Yang</i>
Reviewer(Supervisor)	Jade Yang	<i>Jade Yang</i>
Approved(Manager)	Carson Zhang	<i>Carson Zhang</i>



Table of Contents	Page
1 . SUMMARY OF TEST RESULTS	5
1.1 TEST FACILITY	5
1.2 MEASUREMENT UNCERTAINTY	5
2 . GENERAL INFORMATION	6
2.1 GENERAL DESCRIPTION OF EUT	6
2.2 DESCRIPTION OF TEST MODES	8
2.3 TABLE OF PARAMETERS OF TEXT SOFTWARE SETTING	8
2.4 BLOCK DIGRAM SHOWING THE CONFIGURATION OF SYSTEM TESTED	9
2.5 DESCRIPTION OF SUPPORT UNITS(CONDUCTED MODE)	10
2.6 EQUIPMENTS LIST FOR ALL TEST ITEMS	11
3 . EMC EMISSION TEST	12
3.1 CONDUCTED EMISSION MEASUREMENT	12
3.1.1 POWER LINE CONDUCTED EMISSION LIMITS	12
3.1.2 TEST PROCEDURE	13
3.1.3 DEVIATION FROM TEST STANDARD	13
3.1.4 TEST SETUP	13
3.1.5 EUT OPERATING CONDITIONS	13
3.1.6 TEST RESULTS	14
3.2 RADIATED EMISSION MEASUREMENT	16
3.2.1 RADIATED EMISSION LIMITS	16
3.2.2 TEST PROCEDURE	17
3.2.3 DEVIATION FROM TEST STANDARD	17
3.2.4 TEST SETUP	18
3.2.5 EUT OPERATING CONDITIONS	19
3.2.6 TEST RESULTS	20
4 . BANDWIDTH TEST	41
4.1 APPLIED PROCEDURES / LIMIT	41
4.1.1 TEST PROCEDURE	41
4.1.2 DEVIATION FROM STANDARD	41
4.1.3 TEST SETUP	41
4.1.4 EUT OPERATION CONDITIONS	41
4.1.5 TEST RESULTS	42
5 . 100 KHZ BANDWIDTH OF FREQUENCY BAND EDGE	49
5.1 DEVIATION FROM STANDARD	50
5.2 EUT OPERATION CONDITIONS	50
5.3 TEST RESULTS	51



Table of Contents

Page

6 . ANTENNA REQUIREMENT	58
6.1 STANDARD REQUIREMENT	58
6.2 EUT ANTENNA	58
7 . EUT TEST PHOTO	59
8 . EUT PHOTO	61



1. SUMMARY OF TEST RESULTS

Test procedures according to the technical standards:

FCC Part15 (15.249) , Subpart C			
Standard Section	Test Item	Judgment	Remark
15.207(a)	Conducted Emission	PASS	
15.209(a)&&15.249(a) &15.249(c)&15.205(a)	Fundamental &Radiated Spurious Emission Measurement	PASS	
15.215(c)	Bandwidth	PASS	
15.249(d)	Band Edge Emission	PASS	
15.203	Antenna Requirement	PASS	

1.1 TEST FACILITY

Shenzhen BCTC Technology Co., Ltd.
Add.:No.101,Yousong Road,Longhua New District, Shenzhen,China
FCC Registration No.:187086

1.2 MEASUREMENT UNCERTAINTY

The reported uncertainty of measurement $y \pm U$, where expended uncertainty U is based on a standard uncertainty multiplied by a coverage factor of $k=2$, providing a level of confidence of approximately **95 %** .

No.	Item	Uncertainty
1	Conducted Emission Test	$\pm 1.38\text{dB}$
2	RF power,conducted	$\pm 0.16\text{dB}$
3	Spurious emissions,conducted	$\pm 0.21\text{dB}$
4	All emissions,radiated(<1G)	$\pm 4.68\text{dB}$
5	All emissions,radiated(>1G)	$\pm 4.89\text{dB}$
6	Temperature	$\pm 0.5^{\circ}\text{C}$
7	Humidity	$\pm 2\%$



2. GENERAL INFORMATION

2.1 GENERAL DESCRIPTION OF EUT

Equipment	spabluetooth speaker	
Trade Name	N/A	
Model Name	YM-C06	
Serial Model	SP190, DP-1826	
Model Difference	All the model are the same circuit and RF module,except model names.	
Product Description	Operation Frequency:	2402~2480 MHz
	Modulation Type:	GFSK, $\pi/4$ DPSK,8DPSK
	Bit Rate of Transmitter	1Mbps/2Mbps/3Mbps
	Number Of Channel	79 CH
	Antenna Designation:	Please see Note 3.
	Based on the application, features, or specification exhibited in User's Manual, the EUT is considered as an ITE/Computing Device. More details of EUT technical specification, please refer to the User's Manual.	
Channel List	Please refer to the Note 2.	
Battery	DC3.7V	
Adapter	N/A	
Connecting I/O Port(s)	Please refer to the User's Manual	
hardware version	-	
Software version	-	

Note:

1. For a more detailed features description, please refer to the manufacturer's specifications or the User's Manual.



2.

Channel List					
Channel	Frequency (MHz)	Channel	Frequency (MHz)	Channel	Frequency (MHz)
00	2402	27	2429	54	2456
01	2403	28	2430	55	2457
02	2404	29	2431	56	2458
03	2405	30	2432	57	2459
04	2406	31	2433	58	2460
05	2407	32	2434	59	2461
06	2408	33	2435	60	2462
07	2409	34	2436	61	2463
08	2410	35	2437	62	2464
09	2411	36	2438	63	2465
10	2412	37	2439	64	2466
11	2413	38	2440	65	2467
12	2414	39	2441	66	2468
13	2415	40	2442	67	2469
14	2416	41	2443	68	2470
15	2417	42	2444	69	2471
16	2418	43	2445	70	2472
17	2419	44	2446	71	2473
18	2420	45	2447	72	2474
19	2421	46	2448	73	2475
20	2422	47	2449	74	2476
21	2423	48	2450	75	2477
22	2424	49	2451	76	2478
23	2425	50	2452	77	2479
24	2426	51	2453	78	2480
25	2427	52	2454		
26	2428	53	2455		

3.

Table for Filed Antenna

Ant	Brand	Model Name	Antenna Type	Connector	Gain (dBi)	NOTE
1	N/A	N/A	FPCB antenna	N/A	0	BT antenna



2.2 DESCRIPTION OF TEST MODES

To investigate the maximum EMI emission characteristics generated from EUT, the test system was pre-scanning tested based on the consideration of following EUT operation mode or test configuration mode which possibly have effect on EMI emission level. Each of these EUT operation mode(s) or test configuration mode(s) mentioned above was evaluated respectively.

For All Mode	Description	Modulation Type
Mode 1	CH00	GFSK, $\pi/4$ DPSK, 8DPSK
Mode 2	CH39	
Mode 3	CH78	
Mode 4	Link mode	

Note:

- (1) The measurements are performed at the highest, middle, lowest available channels.
- (2) Fully-charged battery is used during the test

2.3 TABLE OF PARAMETERS OF TEXT SOFTWARE SETTING

During testing channel & power controlling software provided by the customer was used to control the operating channel as well as the output power level. The RF output power selection is for the setting of RF output power expected by the customer and is going to be fixed on the firmware of the final end product power parameters

Frequency	2402 MHz	2441 MHz	2480 MHz
Channel	Low	Middle	High



2.4 BLOCK DIGRAM SHOWING THE CONFIGURATION OF SYSTEM TESTED

Conducted Emission/

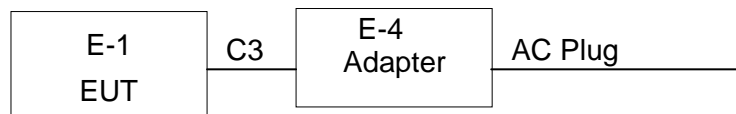

Radiated Spurious Emission Test

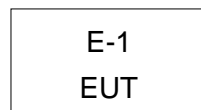

RF test setup:

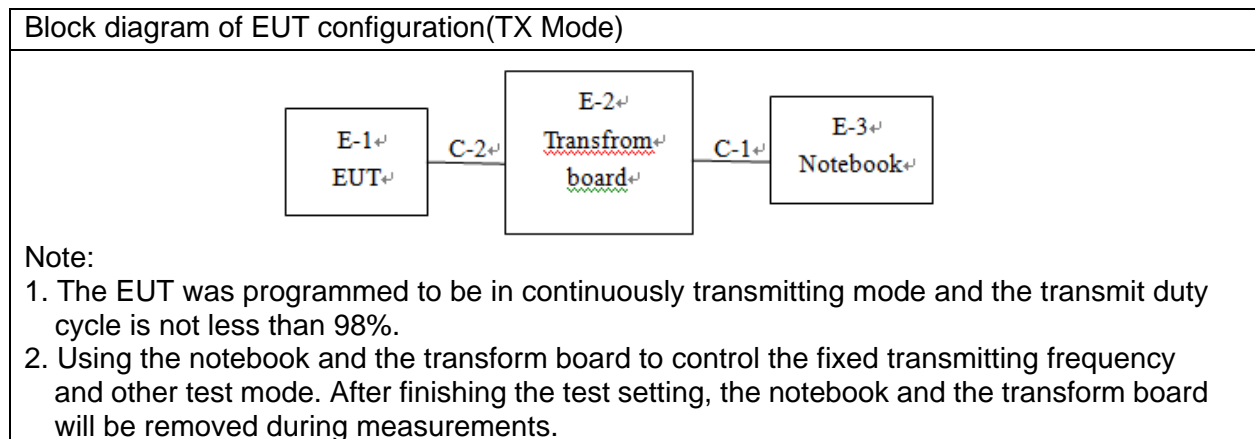



2.5 DESCRIPTION OF SUPPORT UNITS(CONDUCTED MODE)

The EUT has been tested as an independent unit together with other necessary accessories or support units. The following support units or accessories were used to form a representative test configuration during the tests.

Item	Equipment	Mfr/Brand	Model/Type No.	Series No.	Note
E-1	spabluetooth speaker	N/A	YM-C06	N/A	EUT
E-2	Transfrom board	N/A	N/A	N/A	N/A
E-3	Notebook	Lenovo	S2	N/A	Lab Provide
E-4	Adapter	N/A	KA25-0501000CN		Lab Provide

Item	Shielded Type	Ferrite Core	Length	Note
C1	NO	NO	0.8M	USB cable unshielded
C2	NO	NO	0.5M	Connection cable unshielded
C3	NO	NO	1.2M	USB cable unshielded

Note:

- (1) The support equipment was authorized by Declaration of Confirmation.
- (2) For detachable type I/O cable should be specified the length in cm in 『Length』 column.
- (3) “YES” is means “shielded” “with core”; “NO” is means “unshielded” “without core”.



2.6 EQUIPMENTS LIST FOR ALL TEST ITEMS

For Conducted Emission at the mains terminals Test

Item	Equipment	Manufacturer	Type No.	Serial No.	Last calibration	Calibrated until
1	Test Receiver	R&S	ESCI	1166.5950K03-1 01165-ha	2016.08.27	2017.08.26
2	LISN	SCHWARZBECK	NSLK8127	8127739	2016.08.27	2017.08.26
3	LISN	R&S	NSLK8126	8126487	2016.08.27	2017.08.26
4	RF cables	R&S	R204	R20X	2016.08.27	2017.08.26
5	Attenuator	R&S	ESH3-Z2	143206	2016.08.27	2017.08.26

Radiation test, Band-edge test and 20db bandwidth test quipment

Item	Equipment	Manufacturer	Type No.	Serial No.	Last calibration	Calibrated until
1	Spectrum Analyzer (9kHz-26.5GHz)	Agilent	E4407B	MY45108040	2016.08.27	2017.08.26
2	Test Receiver (9kHz-7GHz)	R&S	ESPI	101318	2016.08.27	2017.08.26
3	Bilog Antenna (30MHz-1GHz)	R&S	VULB 9168	VULB91 68-438	2016.08.27	2017.08.26
4	Horn Antenna (1GHz-18GHz)	SCHWARZBECK	BBHA9120D	1201	2016.09.03	2017.09.03
5	Horn Antenna (14GHz-40GHz)	SCHWARZBECK	BBHA 9170	9170-181	2016.09.03	2017.09.03
6	Amplifier (9KHz-6GHz)	SCHWARZBECK	BBV9744	9744-0037	2016.08.27	2017.08.26
7	Amplifier (1GHz-18GHz)	SCHWARZBECK	BBV9718	9718-309	2016.08.27	2017.08.26
8	Amplifier (18GHz-40GHz)	SCHWARZBECK	BBV 9721	9721-205	2016.08.27	2017.08.26
9	Loop Antenna (9KHz-30MHz)	SCHWARZBECK	FMZB1519B	00014	2016.09.03	2017.09.03
10	RF cables1 (9kHz-1GHz)	R&S	R203	R20X	2016.08.27	2017.08.26
11	RF cables2 (1GHz-40GHz)	R&S	R204	R21X	2016.08.27	2017.08.26
12	Antenna connector	Florida RF Labs	N/A	RF 01#	2016.08.27	2017.08.26
13	Power Metter	ANRITSU	ML2487A	6K00001568	2016.08.27	2017.08.26
14	Power Sensor (AV)	ANRITSU	ML2491A	030989	2016.08.27	2017.08.26
15	Signal Analyzer 9kHz-26.5GHz	Agilent	N9010A	MY48030494	2016.08.27	2017.08.26
16	Test Receiver 20kHz-40GHz	R&S	ESU 40	100376	2016.08.27	2017.08.26
17	D.C. Power Supply	LongWei	PS-305D	010964729	2016.08.27	2017.08.26



3. EMC EMISSION TEST

3.1 CONDUCTED EMISSION MEASUREMENT

3.1.1 POWER LINE CONDUCTED EMISSION Limits (Frequency Range 150KHz-30MHz)

FREQUENCY (MHz)	Limit (dBuV)		Standard
	Quas -peak	Average	
0.15 -0.5	66 - 56 *	56 - 46 *	CISPR
0.50 -5.0	56.00	46.00	CISPR
5.0 -30.0	60.00	50.00	CISPR

0.15 -0.5	66 - 56 *	56 - 46 *	FCC
0.50 -5.0	56.00	46.00	FCC
5.0 -30.0	60.00	50.00	FCC

Note:

- (1) The tighter limit applies at the band edges.
- (2) The limit of " * " marked band means the limitation decreases linearly with the logarithm of the frequency in the range.

The following table is the setting of the receiver

Receiver Parameters	Setting
Attenuation	10 dB
Start Frequency	0.15 MHz
Stop Frequency	30 MHz
IF Bandwidth	9 kHz

3.1.2 TEST PROCEDURE

- The EUT was placed 0.8 meters from the horizontal ground plane with EUT being connected to the power mains through a line impedance stabilization network (LISN). All other support equipments powered from additional LISN(s). The LISN provide 50 Ohm/ 50uH of coupling impedance for the measuring instrument.
- Interconnecting cables that hang closer than 40 cm to the ground plane shall be folded back and forth in the center forming a bundle 30 to 40 cm long.
- I/O cables that are not connected to a peripheral shall be bundled in the center. The end of the cable may be terminated, if required, using the correct terminating impedance. The overall length shall not exceed 1 m.
- LISN at least 80 cm from nearest part of EUT chassis.
- For the actual test configuration, please refer to the related Item –EUT Test Photos.

3.1.3 DEVIATION FROM TEST STANDARD

No deviation

3.1.4 TEST SETUP

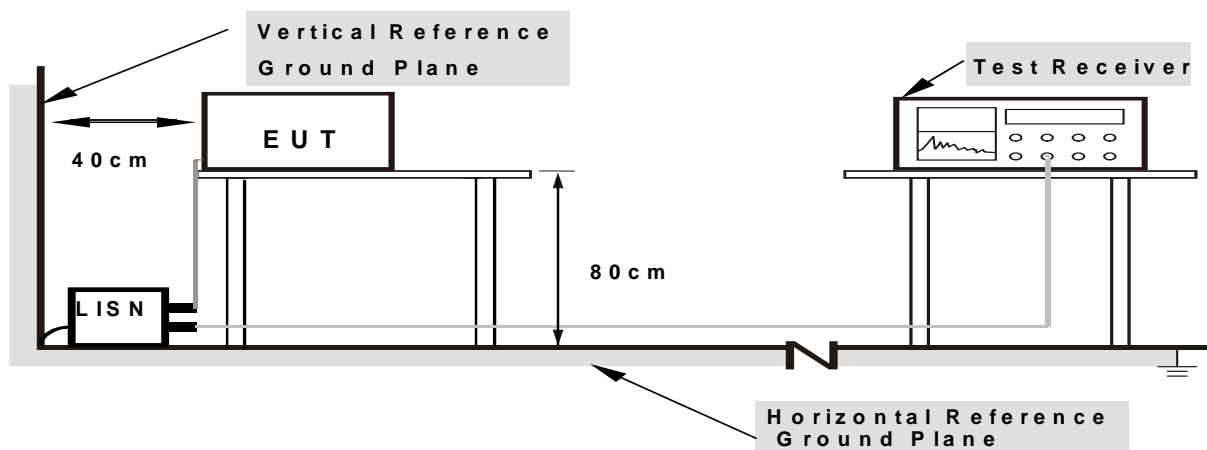

- Note: 1.Support units were connected to second LISN.
2.Both of LISNs (AMN) are 80 cm from EUT and at least 80 from other units and other metal planes

3.1.5 EUT OPERATING CONDITIONS

The EUT was configured for testing in a typical fashion (as a customer would normally use it). The EUT has been programmed to continuously transmit during test. This operating condition was tested and used to collect the included data.

We pretest AC 120V and AC 240V, the worst voltage was AC 120V and the data recording in the report.



3.1.6 TEST RESULTS

Temperature :	25 °C	Relative Humidity :	54%
Pressure :	1010hPa	Phase :	L
Test Voltage :	AC120V/60Hz	Test Mode :	Mode4

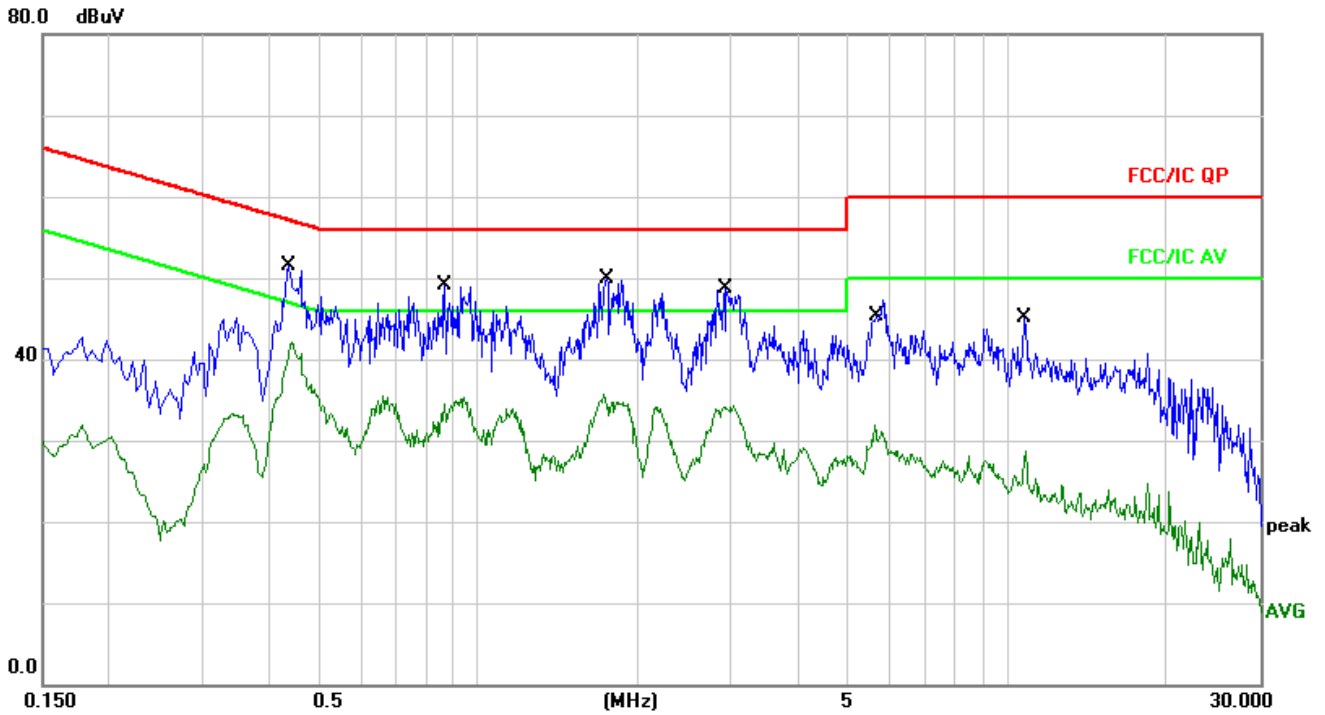

No. Mk.	Freq. MHz	Reading Level dBuV	Correct Factor dB	Measurement dBuV	Limit dBuV	Over dB	Detector	Comment
1	0.4380	41.83	9.67	51.50	57.10	-5.60	QP	
2 *	0.4380	32.51	9.67	42.18	47.10	-4.92	AVG	
3	0.8620	39.40	9.69	49.09	56.00	-6.91	QP	
4	0.8620	25.68	9.69	35.37	46.00	-10.63	AVG	
5	1.7300	40.30	9.70	50.00	56.00	-6.00	QP	
6	1.7300	26.02	9.70	35.72	46.00	-10.28	AVG	
7	2.9380	38.99	9.72	48.71	56.00	-7.29	QP	
8	2.9380	24.53	9.72	34.25	46.00	-11.75	AVG	
9	5.5980	37.45	9.75	47.20	60.00	-12.80	QP	
10	5.5980	22.07	9.75	31.82	50.00	-18.18	AVG	
11	10.7900	35.38	9.82	45.20	60.00	-14.80	QP	
12	10.7900	18.90	9.82	28.72	50.00	-21.28	AVG	



Temperature :	25 °C	Relative Humidity :	54%
Pressure :	1010hPa	Phase :	N
Test Voltage :	AC120V/60Hz	Test Mode :	Mode4

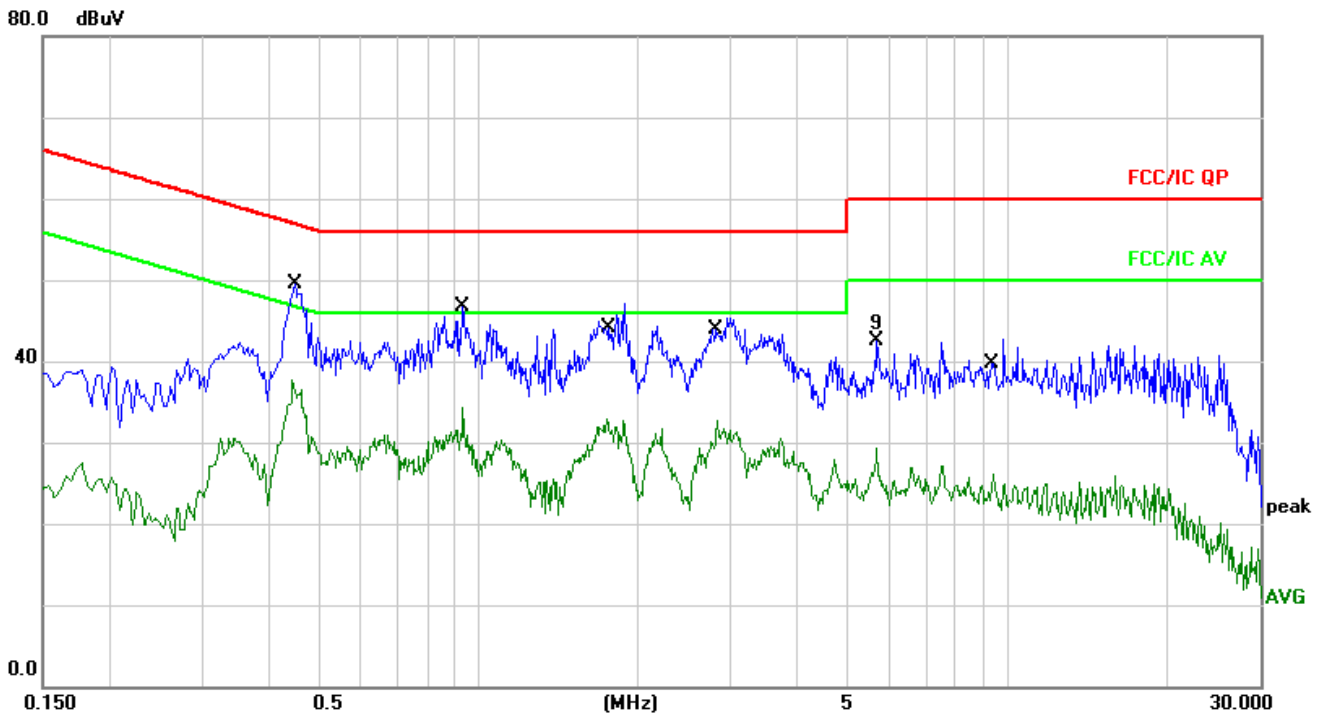

No.	Mk.	Freq. MHz	Reading Level dBuV	Correct Factor dB	Measure- ment dBuV	Limit dBuV	Over dB	Detector	Comment
1	*	0.4460	39.80	9.67	49.47	56.95	-7.48	QP	
2		0.4460	28.01	9.67	37.68	46.95	-9.27	AVG	
3		0.9380	37.00	9.69	46.69	56.00	-9.31	QP	
4		0.9380	24.55	9.69	34.24	46.00	-11.76	AVG	
5		1.7460	37.37	9.70	47.07	56.00	-8.93	QP	
6		1.7460	23.22	9.70	32.92	46.00	-13.08	AVG	
7		2.8300	35.59	9.72	45.31	56.00	-10.69	QP	
8		2.8300	22.96	9.72	32.68	46.00	-13.32	AVG	
9		5.6620	32.73	9.76	42.49	60.00	-17.51	peak	
10		5.6620	19.45	9.76	29.21	50.00	-20.79	AVG	
11		9.4420	32.87	9.82	42.69	60.00	-17.31	QP	
12		9.4420	16.31	9.82	26.13	50.00	-23.87	AVG	



3.2 RADIATED EMISSION MEASUREMENT

3.2.1 RADIATED EMISSION LIMITS (Frequency Range 9kHz-1000MHz)

20dBc in any 100 kHz bandwidth outside the operating frequency band. In case the emission fall within the restricted band specified on 15.205(a), then the 15.209(a) limit in the table below has to be followed.

Frequencies (MHz)	Field Strength (micorvolts/meter)	Measurement Distance (meters)
0.009~0.490	2400/F(KHz)	300
0.490~1.705	24000/F(KHz)	30
1.705~30.0	30	30
30~88	100	3
88~216	150	3
216~960	200	3
Above 960	500	3

LIMITS OF RADIATED EMISSION MEASUREMENT (Above 1000MHz)

FREQUENCY (MHz)	Limit (dBuV/m) (at 3M)	
	PEAK	AVERAGE
Above 1000	74	54

Notes:

- (1) The limit for radiated test was performed according to FCC PART 15C.
- (2) The tighter limit applies at the band edges.
- (3) Emission level (dBuV/m)=20log Emission level (uV/m).

FREQUENCY RANGE OF RADIATED MEASUREMENT (For unintentional radiators)

Highest frequency generated or Upper frequency of measurement used in the device or on which the device operates or tunes (MHz)	Range (MHz)
Below 1.705	30
1.705 – 108	1000
108 – 500	2000
500 – 1000	5000
Above 1000	5 th harmonic of the highest frequency or 40 GHz, whichever is lower



Spectrum Parameter	Setting
Attenuation	Auto
Start Frequency	1000 MHz
Stop Frequency	10th carrier harmonic
RB / VB (emission in restricted band)	1 MHz / 1 MHz for Peak, 1 MHz / 10Hz for Average

Receiver Parameter	Setting
Attenuation	Auto
Start ~ Stop Frequency	9kHz~150kHz / RB 200Hz for QP
Start ~ Stop Frequency	150kHz~30MHz / RB 9kHz for QP
Start ~ Stop Frequency	30MHz~1000MHz / RB 120kHz for QP

3.2.2 TEST PROCEDURE

- a. The measuring distance of at 3 m shall be used for measurements at frequency up to 25GHz. For frequencies above 1GHz, any suitable measuring distance may be used.
- b. The EUT was placed on the top of a rotating table 0.8 and 1.5 meters above the ground at a 3 meter semi-chamber test. The table was rotated 360 degrees to determine the position of the highest radiation.
- c. The height of the equipment or of the substitution antenna shall be 0.8 m; above 1GHz, the height was 1.5m, the height of the test antenna shall vary between 1 m to 4 m. Both horizontal and vertical polarizations of the antenna are set to make the measurement.
- d. The initial step in collecting conducted emission data is a spectrum analyzer peak detector mode pre-scanning the measurement frequency range. Significant peaks are then marked and then Quasi Peak detector mode re-measured.
- e. If the Peak Mode measured value compliance with and lower than Quasi Peak Mode Limit, the EUT shall be deemed to meet QP Limits and then no additional QP Mode measurement performed.
- f. For the actual test configuration, please refer to the related Item –EUT Test Photos.
- g. For the radiated emission test above 1GHz:
Place the measurement antenna away from each area of the EUT determined to be a source of emissions at the specified measurement distance, while keeping the measurement antenna aimed at the source of emissions at each frequency of significant emissions, with polarization oriented for maximum response.
The measurement antenna may have to be higher or lower than the EUT, depending on the radiation pattern of the emission and staying aimed at the emission source for receiving the maximum signal. The final measurement antenna elevation shall be that which maximizes the emissions. The measurement antenna elevation for maximum emissions shall be restricted to a range of heights of from 1 m to 4 m above the ground or reference ground plane.

Note:

Both horizontal and vertical antenna polarities were tested and performed pretest to three orthogonal axis. The worst case emissions were reported

3.2.3 DEVIATION FROM TEST STANDARD

No deviation

3.2.4 TEST SETUP

(A) Radiated Emission Test-Up Frequency Below 30MHz

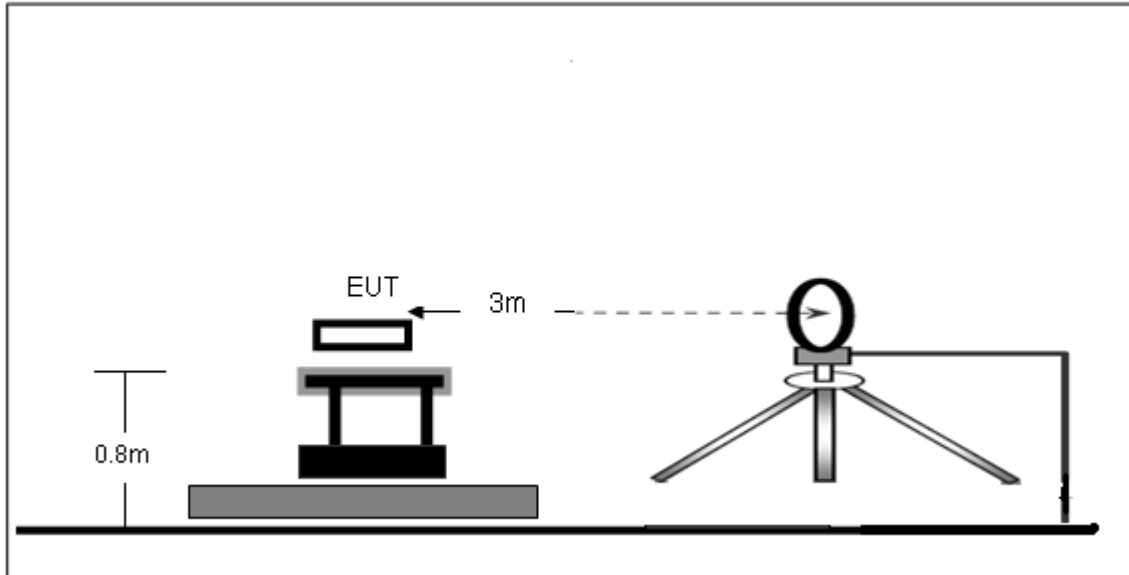

(B) Radiated Emission Test-Up Frequency 30MHz~1GHz

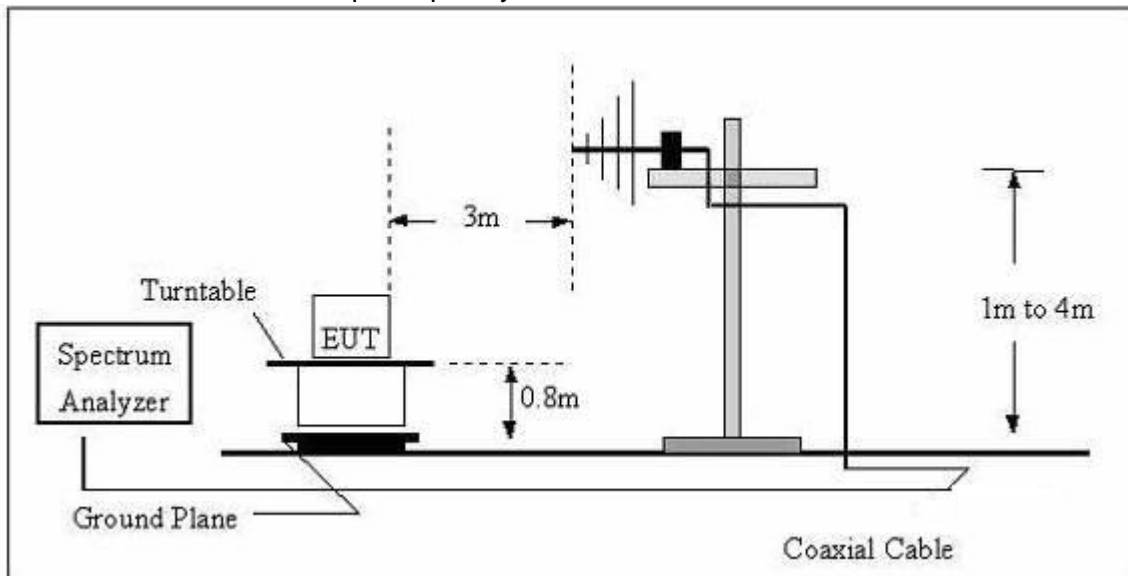

(C) Radiated Emission Test-Up Frequency Above 1GHz

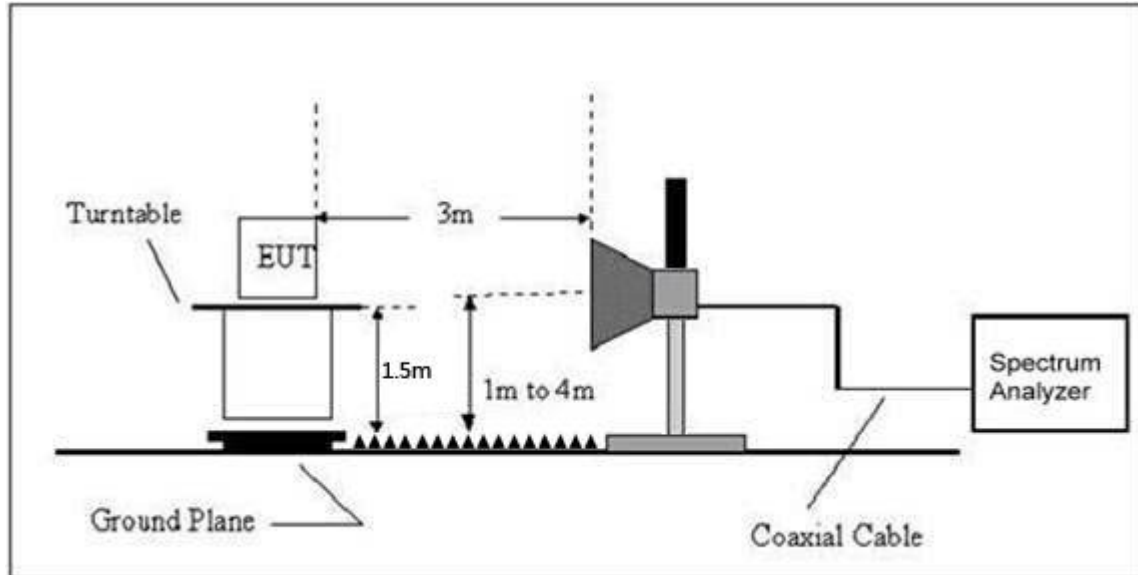

3.2.5 EUT OPERATING CONDITIONS

The EUT tested system was configured as the statements of 2.4 Unless otherwise a special operating condition is specified in the follows during the testing.



3.2.6 TEST RESULTS

Radiated Spurious Emission (Below 30MHz)

Temperature :	25 °C	Relative Humidity :	55%
Pressure :	1010 hPa	Polarization :	---
Test Voltage :	DC3.7V		
Test Mode :	Mode 4		

Freq.	Reading	Limit	Margin	State
(MHz)	(dBuV/m)	(dBuV/m)	(dB)	P/F
--	--	--	--	PASS
--	--	--	--	PASS

NOTE:

The amplitude of spurious emissions which are attenuated by more than 20dB below the permissible value has no need to be reported.

Distance extrapolation factor = $40 \log(\text{specific distance}/\text{test distance})$ (dB);

Limit line = specific limits(dBuv) + distance extrapolation factor.



Radiated Spurious Emission (Between 30MHz – 1GHz)

Temperature :	25 °C	Relative Humidity :	55%
Pressure :	1010 hPa	Polarization :	Horizontal
Test Voltage :	DC3.7V		
Test Mode : (Worst)	Mode 4		

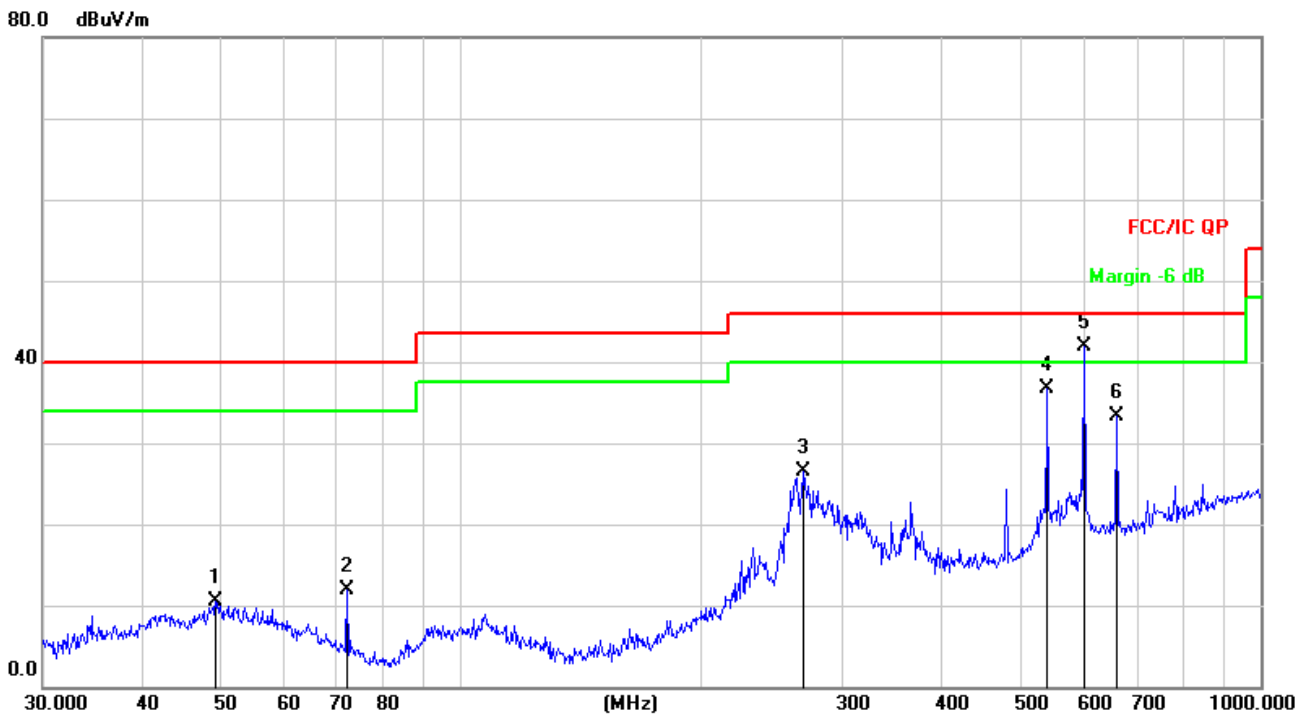

No.	Mk.	Freq. MHz	Reading Level dBuV	Correct Factor dB	Measure- ment dBuV/m	Limit dB/m	Over dB	Detector
1		49.3594	25.24	-14.70	10.54	40.00	-29.46	QP
2		72.0843	31.57	-19.71	11.86	40.00	-28.14	QP
3		268.4853	39.70	-13.14	26.56	46.00	-19.44	QP
4		541.3725	42.97	-6.24	36.73	46.00	-9.27	QP
5	*	601.4265	46.45	-4.47	41.98	46.00	-4.02	QP
6		661.1505	36.84	-3.61	33.23	46.00	-12.77	QP



Temperature :	25 °C	Relative Humidity :	55%
Pressure :	1010 hPa	Polarization :	Vertical
Test Voltage :	DC3.7V		
Test Mode : (Worst)	Mode 4		

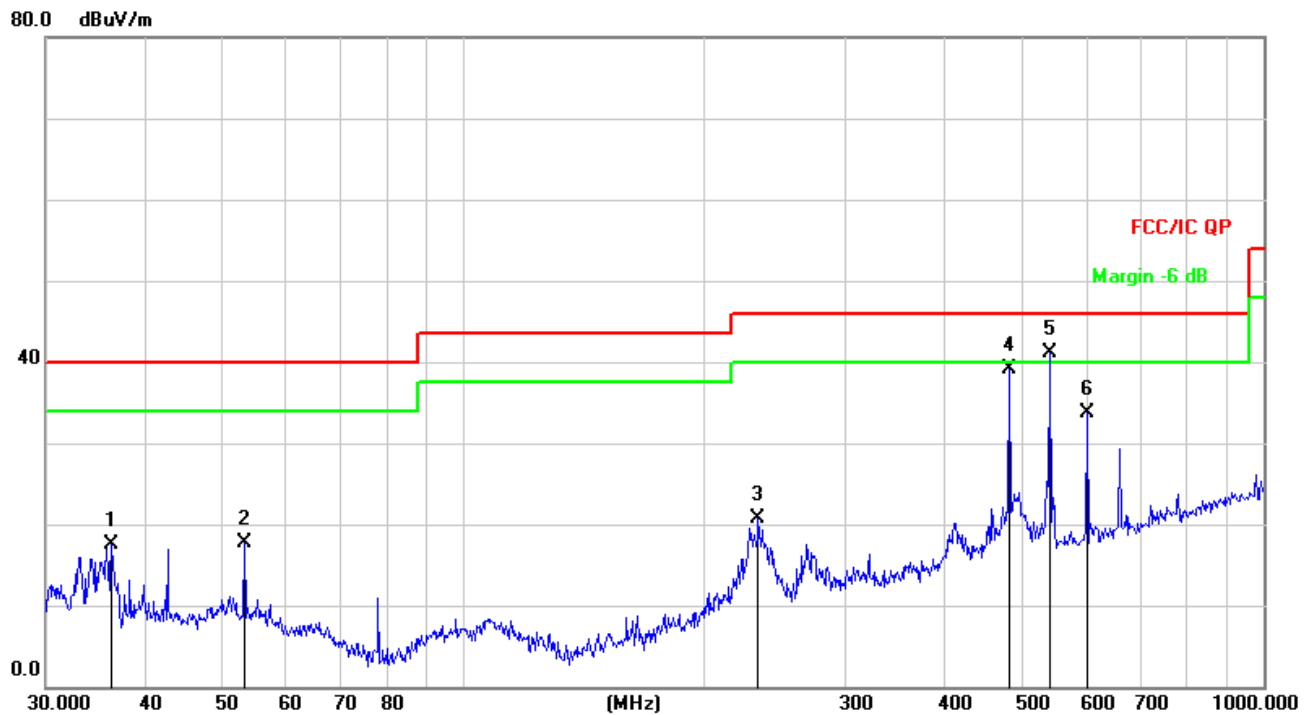

No.	Mk.	Freq. MHz	Reading Level dBuV	Correct Factor dB	Measure- ment dBuV/m	Limit dB/m	Over dB	Detector
1		36.2541	34.45	-16.97	17.48	40.00	-22.52	QP
2		53.1313	32.61	-14.82	17.79	40.00	-22.21	QP
3		233.3487	35.11	-14.41	20.70	46.00	-25.30	QP
4		480.5276	46.77	-7.68	39.09	46.00	-6.91	QP
5	*	541.3725	47.43	-6.24	41.19	46.00	-4.81	QP
6		601.4265	38.10	-4.47	33.63	46.00	-12.37	QP



Radiated Spurious Emission (1GHz to 10th harmonics)

GFSK

Polar (H/V)	Frequency	Meter Reading	Pre-amplifier	Cable Loss	Antenna Factor	Emission Level	Limits	Margin	Detector Type
	(MHz)	(dBuV)	(dB)	(dB)	(dB/m)	(dBuV/m)	(dBuV/m)	(dB)	
Low Channel 2402MHz									
V	2402.00	111.24	38.11	7.44	20.36	100.93	114	-13.07	PK
V	2402.00	96.81	38.11	7.44	20.36	86.5	94	-7.5	AV
V	4804.00	60.10	38.65	7.80	23.61	52.86	74	-21.14	PK
V	4804.00	47.76	38.65	7.80	23.61	40.52	54	-13.48	AV
V	16132.00	48.62	38.75	10.36	26.57	46.8	74	-27.2	PK
H	2402.00	114.05	38.11	7.44	20.36	103.74	114	-10.26	PK
H	2402.00	94.51	38.11	7.44	20.36	84.2	94	-9.8	AV
H	4804.00	61.16	38.65	7.80	23.61	53.92	74	-20.08	PK
H	4804.00	48.50	38.65	7.80	23.61	41.26	54	-12.74	AV
H	16132.00	50.68	38.75	10.36	26.57	48.86	74	-25.14	PK
Middle Channel 2441MHz									
V	2441.00	109.92	38.11	7.44	20.36	99.61	114	-14.39	PK
V	2441.00	93.90	38.11	7.44	20.36	83.59	94	-10.41	AV
V	4882.00	58.18	38.65	7.80	23.61	50.94	74	-23.06	PK
V	4882.00	47.24	38.65	7.80	23.61	40	54	-14	AV
V	16132.00	47.57	38.75	10.36	26.57	45.75	74	-28.25	PK
H	2441.00	112.16	38.11	7.44	20.36	101.85	114	-12.15	PK
H	2441.00	90.69	38.11	7.44	20.36	80.38	94	-13.62	AV
H	4882.00	59.49	38.65	7.80	23.61	52.25	74	-21.75	PK
H	4882.00	46.17	38.65	7.80	23.61	38.93	54	-15.07	AV
H	16132.00	49.30	38.75	10.36	26.57	47.48	74	-26.52	PK
High Channel 2480MHz									
V	2480.00	111.75	38.17	7.47	20.51	101.56	114	-12.44	PK
V	2480.00	94.19	38.17	7.47	20.51	84	94	-10	AV
V	4960.00	62.80	38.69	7.83	23.83	55.77	74	-18.23	PK
V	4960.00	50.17	38.69	7.83	23.83	43.14	54	-10.86	AV
V	16132.00	53.08	38.75	10.36	26.57	51.26	74	-22.74	PK
H	2480.00	114.22	38.17	7.47	20.51	104.03	114	-9.97	PK
H	2480.00	92.94	38.17	7.47	20.51	82.75	94	-11.25	AV
H	4960.00	62.64	38.69	7.83	23.83	55.61	74	-18.39	PK
H	4960.00	49.46	38.69	7.83	23.83	42.43	54	-11.57	AV
H	16132.00	52.87	38.75	10.36	26.57	51.05	74	-22.95	PK

Remark:

1. Emission Level = Meter Reading + Antenna Factor + Cable Loss – Pre-amplifier, Margin= Emission Level - Limit
2. If peak below the average limit, the average emission was no test.
3. The amplitude of spurious emissions which are attenuated by more than 20dB below the permissible value has no need to be reported.



PI/4 DPSK

Polar (H/V)	Frequency	Meter Reading	Pre-amplifier	Cable Loss	Antenna Factor	Emission Level	Limits	Margin	Detector Type
	(MHz)	(dBuV)	(dB)	(dB)	(dB/m)	(dBuV/m)	(dBuV/m)	(dB)	
Low Channel 2402MHz									
V	2402.00	112.17	38.06	7.42	20.15	101.68	114	-12.32	PK
V	2402.00	92.69	38.06	7.42	20.15	82.2	94	-11.8	AV
V	4804.00	56.45	38.53	7.78	23.25	48.95	74	-25.05	PK
V	4804.00	46.58	38.53	7.78	23.25	39.08	54	-14.92	AV
V	16132.00	52.64	38.75	10.36	26.57	50.82	74	-23.18	PK
H	2402.00	113.94	38.06	7.42	20.15	103.45	114	-10.55	PK
H	2402.00	90.87	38.06	7.42	20.15	80.38	94	-13.62	AV
H	4804.00	58.22	38.53	7.78	23.25	50.72	74	-23.28	PK
H	4804.00	47.27	38.53	7.78	23.25	39.77	54	-14.23	AV
H	16132.00	51.56	38.75	10.36	26.57	49.74	74	-24.26	PK
Middle Channel 2441MHz									
V	2441.00	110.67	38.11	7.44	20.36	100.36	114	-13.64	PK
V	2441.00	95.49	38.11	7.44	20.36	85.18	94	-8.82	AV
V	4882.00	57.79	38.65	7.80	23.61	50.55	74	-23.45	PK
V	4882.00	45.83	38.65	7.80	23.61	38.59	54	-15.41	AV
V	16132.00	48.64	38.75	10.36	26.57	46.82	74	-27.18	PK
H	2441.00	111.85	38.11	7.44	20.36	101.54	114	-12.46	PK
H	2441.00	90.70	38.11	7.44	20.36	80.39	94	-13.61	AV
H	4882.00	59.12	38.65	7.80	23.61	51.88	74	-22.12	PK
H	4882.00	47.84	38.65	7.80	23.61	40.6	54	-13.4	AV
H	16132.00	50.27	38.75	10.36	26.57	48.45	74	-25.55	PK
High Channel 2480MHz									
V	2480.00	110.89	38.17	7.47	20.51	100.7	114	-13.3	PK
V	2480.00	88.74	38.17	7.47	20.51	78.55	94	-15.45	AV
V	4960.00	56.21	38.69	7.83	23.83	49.18	74	-24.82	PK
V	4960.00	46.53	38.69	7.83	23.83	39.5	54	-14.5	AV
V	16132.00	51.76	38.75	10.36	26.57	49.94	74	-24.06	PK
H	2480.00	109.04	38.17	7.47	20.51	98.85	114	-15.15	PK
H	2480.00	90.68	38.17	7.47	20.51	80.49	94	-13.51	AV
H	4960.00	57.98	38.69	7.83	23.83	50.95	74	-23.05	PK
H	4960.00	43.47	38.69	7.83	23.83	36.44	54	-17.56	AV
H	16132.00	50.96	38.75	10.36	26.57	49.14	74	-24.86	PK

Remark:

1. Emission Level = Meter Reading + Antenna Factor + Cable Loss – Pre-amplifier,
Margin= Emission Level - Limit
2. If peak below the average limit, the average emission was no test.
3. The amplitude of spurious emissions which are attenuated by more than 20dB below the permissible value has no need to be reported.



8DPSK

Polar (H/V)	Frequency	Meter Reading	Pre-amplifier	Cable Loss	Antenna Factor	Emission Level	Limits	Margin	Detector Type
	(MHz)	(dBuV)	(dB)	(dB)	(dB/m)	(dBuV/m)	(dBuV/m)	(dB)	
Low Channel 2402MHz									
V	2402.00	108.35	38.06	7.42	20.15	97.86	114	-16.14	PK
V	2402.00	92.62	38.06	7.42	20.15	82.13	94	-11.87	AV
V	4804.00	58.47	38.53	7.78	23.25	50.97	74	-23.03	PK
V	4804.00	45.51	38.53	7.78	23.25	38.01	54	-15.99	AV
V	16132.00	48.68	38.75	10.36	26.57	46.86	74	-27.14	PK
H	2402.00	109.34	38.06	7.42	20.15	98.85	114	-15.15	PK
H	2402.00	93.68	38.06	7.42	20.15	83.19	94	-10.81	AV
H	4804.00	57.53	38.53	7.78	23.25	50.03	74	-23.97	PK
H	4804.00	43.71	38.53	7.78	23.25	36.21	54	-17.79	AV
H	16132.00	47.47	38.75	10.36	26.57	45.65	74	-28.35	PK
Middle Channel 2441MHz									
V	2441.00	108.38	38.11	7.44	20.36	98.07	114	-15.93	PK
V	2441.00	91.39	38.11	7.44	20.36	81.08	94	-12.92	AV
V	4882.00	56.48	38.65	7.80	23.61	49.24	74	-24.76	PK
V	4882.00	42.12	38.65	7.80	23.61	34.88	54	-19.12	AV
V	16132.00	46.79	38.75	10.36	26.57	44.97	74	-29.03	PK
H	2441.00	108.84	38.11	7.44	20.36	98.53	114	-15.47	PK
H	2441.00	90.68	38.11	7.44	20.36	80.37	94	-13.63	AV
H	4882.00	57.38	38.65	7.80	23.61	50.14	74	-23.86	PK
H	4882.00	44.37	38.65	7.80	23.61	37.13	54	-16.87	AV
H	16132.00	47.02	38.75	10.36	26.57	45.2	74	-28.8	PK
High Channel 2480MHz									
V	2480.00	108.58	38.17	7.47	20.51	98.39	114	-15.61	PK
V	2480.00	89.79	38.17	7.47	20.51	79.6	94	-14.4	AV
V	4960.00	59.44	38.69	7.83	23.83	52.41	74	-21.59	PK
V	4960.00	45.78	38.69	7.83	23.83	38.75	54	-15.25	AV
V	16132.00	48.20	38.75	10.36	26.57	46.38	74	-27.62	PK
H	2480.00	109.61	38.17	7.47	20.51	99.42	114	-14.58	PK
H	2480.00	87.56	38.17	7.47	20.51	77.37	94	-16.63	AV
H	4960.00	58.05	38.69	7.83	23.83	51.02	74	-22.98	PK
H	4960.00	45.53	38.69	7.83	23.83	38.5	54	-15.5	AV
H	16132.00	49.59	38.75	10.36	26.57	47.77	74	-26.23	PK

Remark:

1. Emission Level = Meter Reading + Antenna Factor + Cable Loss – Pre-amplifier, Margin= Emission Level - Limit
2. If peak below the average limit, the average emission was no test.
3. The amplitude of spurious emissions which are attenuated by more than 20dB below the permissible value has no need to be reported.



Operation Mode: GFSK mode(CH00, CH39, CH78)

CH 00 (GFSK mode) - Frequency Band 1 (30 MHz \leq f \leq 1000 MHz)

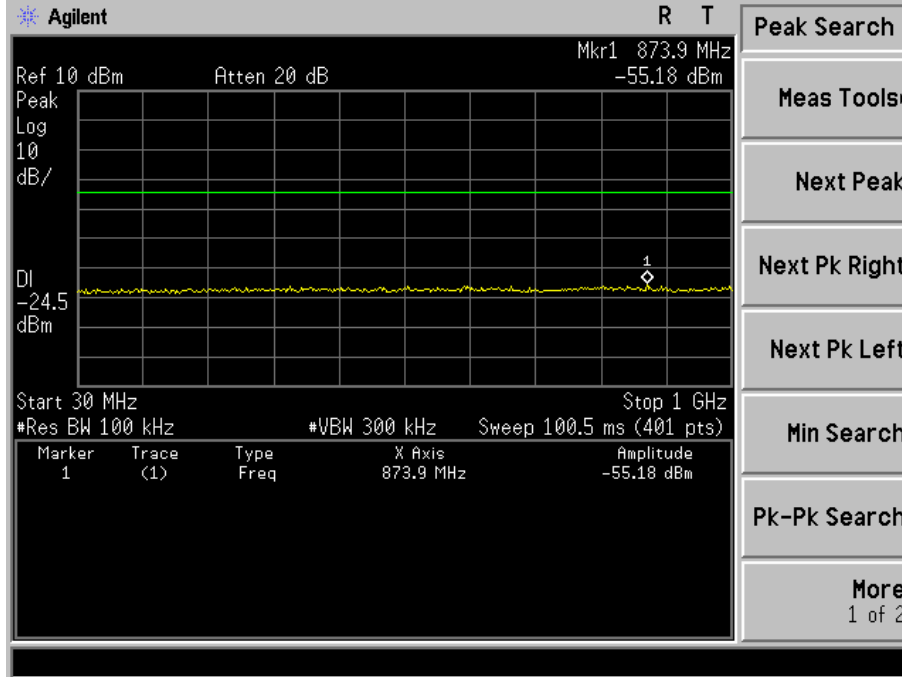

CH 00 (GFSK mode) - Frequency Band 2 (1000 MHz < f \leq 3000 MHz)

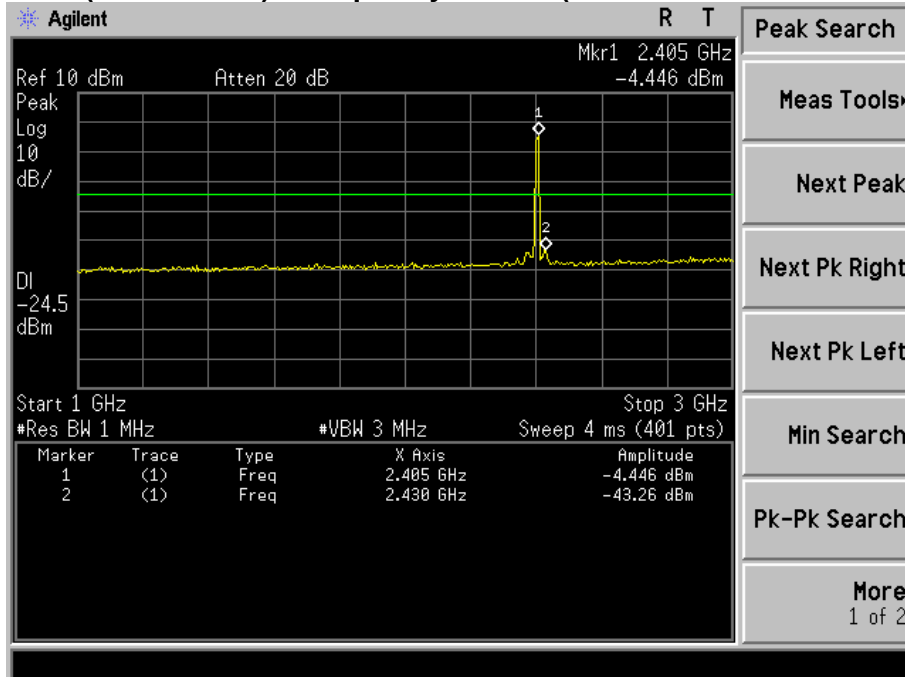



CH 00 (GFSK mode) - Frequency Band 3 (3000 MHz <math>f < \infty 25000 \text{ MHz}</math>)

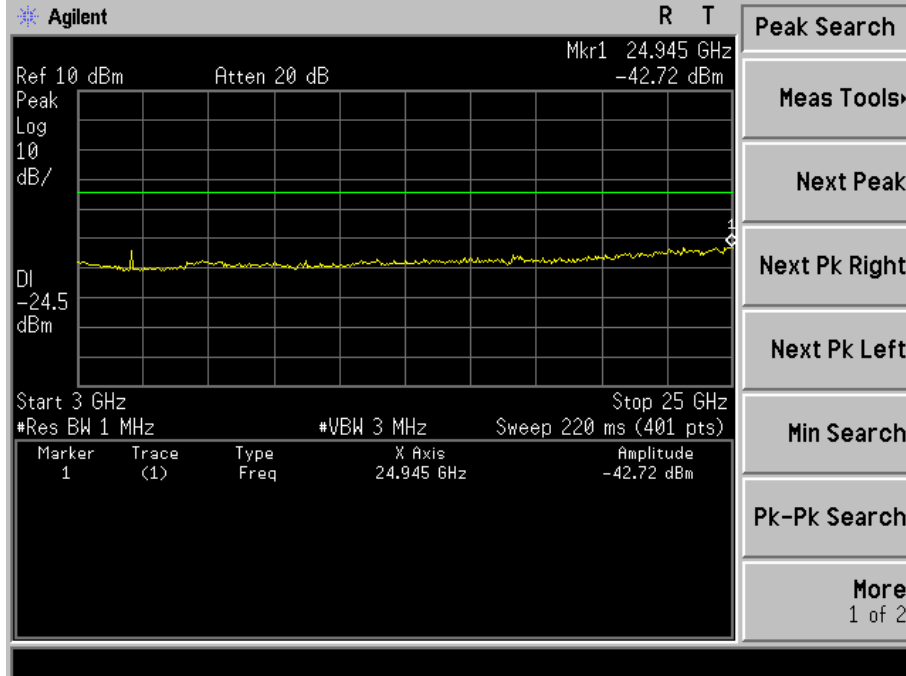

CH 39 (GFSK mode) - Frequency Band 1 (30 MHz $f \infty 1000 \text{ MHz}$)

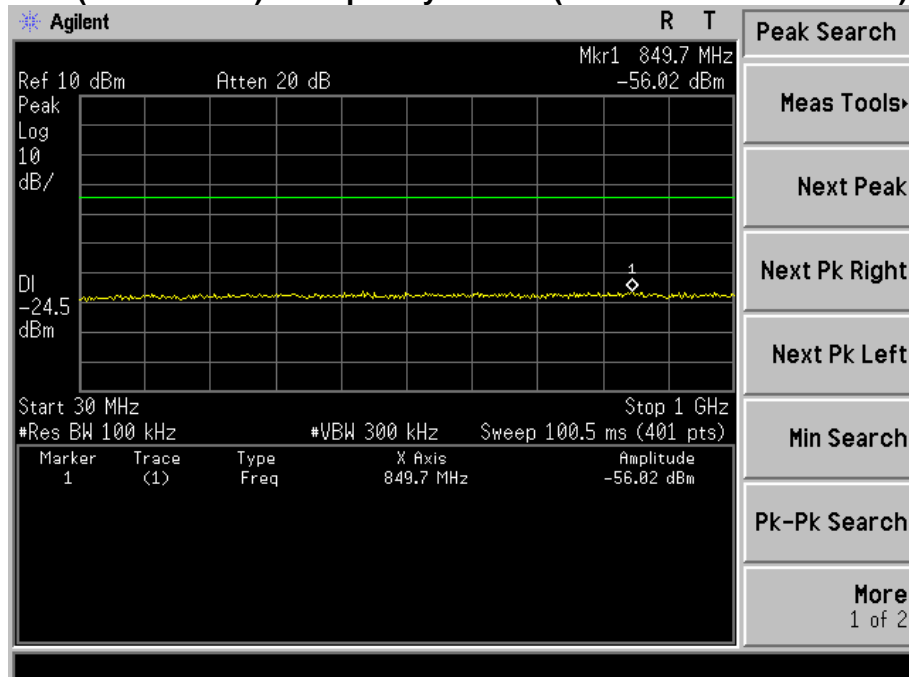



CH 39 (GFSK mode) - Frequency Band 2 (1000 MHz < f ≦ 3000 MHz)

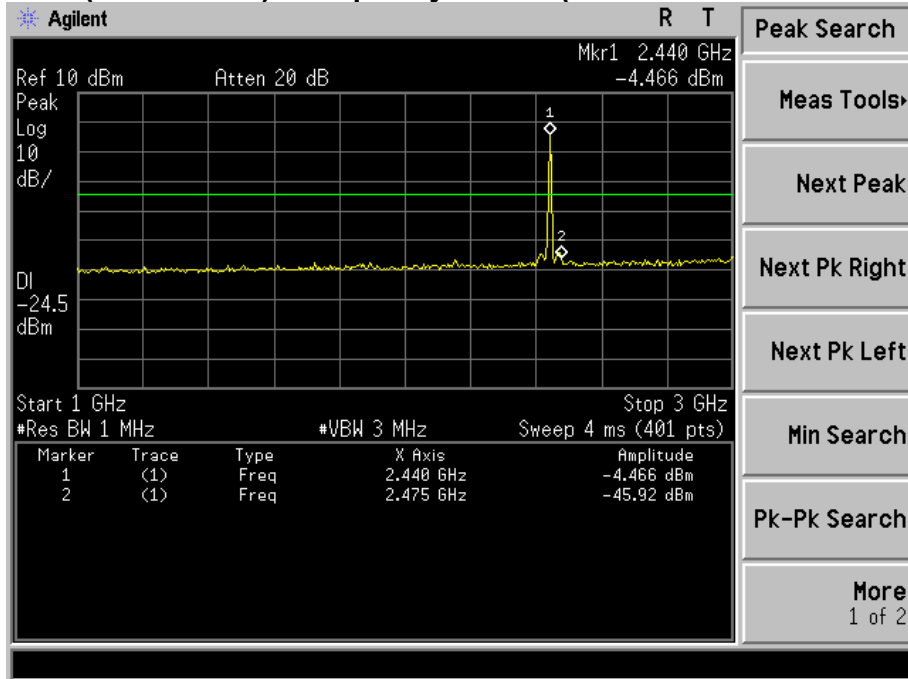

CH 39 (GFSK mode) - Frequency Band 3 (3000 MHz < f ≦ 25000 MHz)

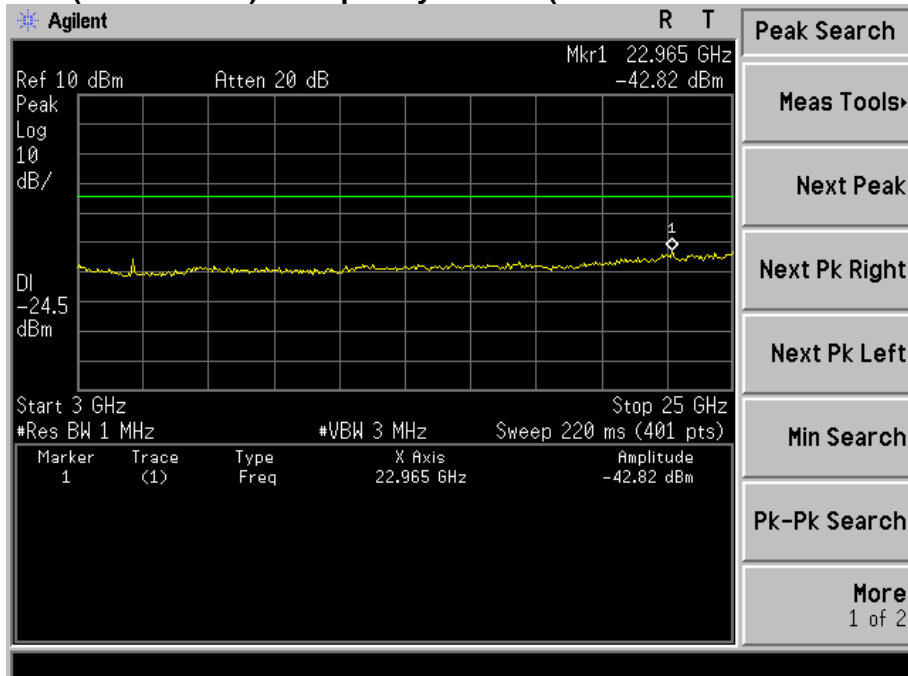



CH 78 (GFSK mode) - Frequency Band 1 (30 MHz \leq f \leq 1000 MHz)

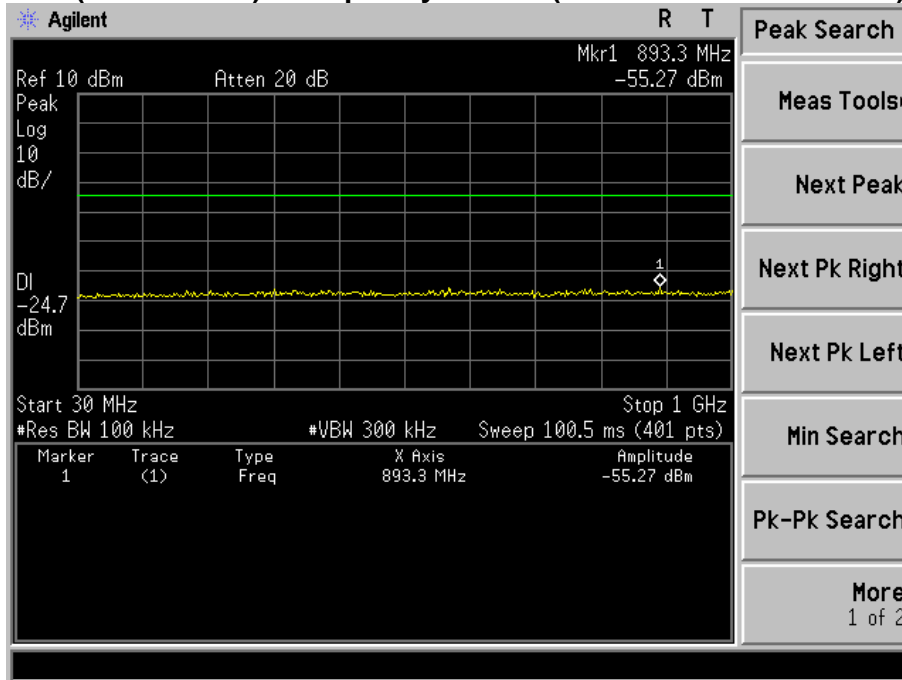

CH 78 (GFSK mode) - Frequency Band 2 (1000 MHz < f \leq 3000 MHz)

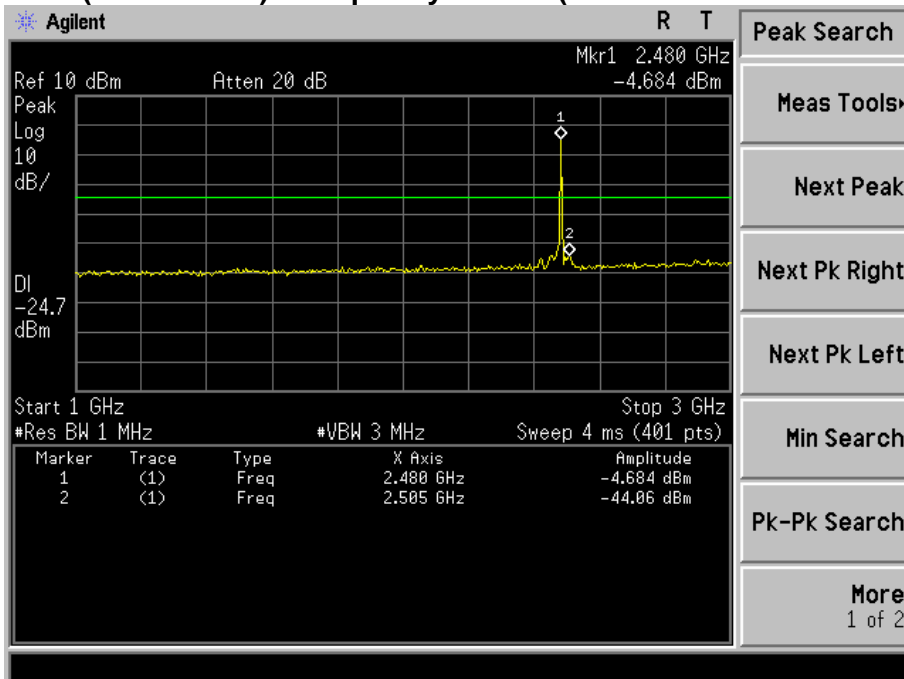



CH 78 (GFSK mode) - Frequency Band 3 (3000 MHz < f ≤ 25000 MHz)

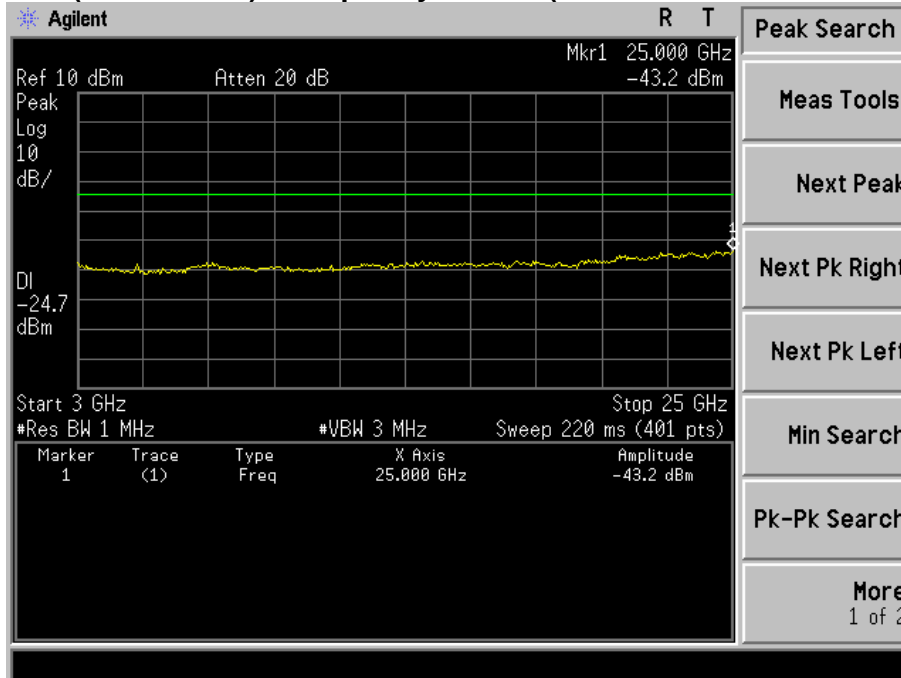



Operation Mode: $\pi/4$ DPSK mode(CH00, CH39, CH78)

CH 00 ($\pi/4$ DPSK mode) - Frequency Band 1 (30 MHz \leq f \leq 1000 MHz)

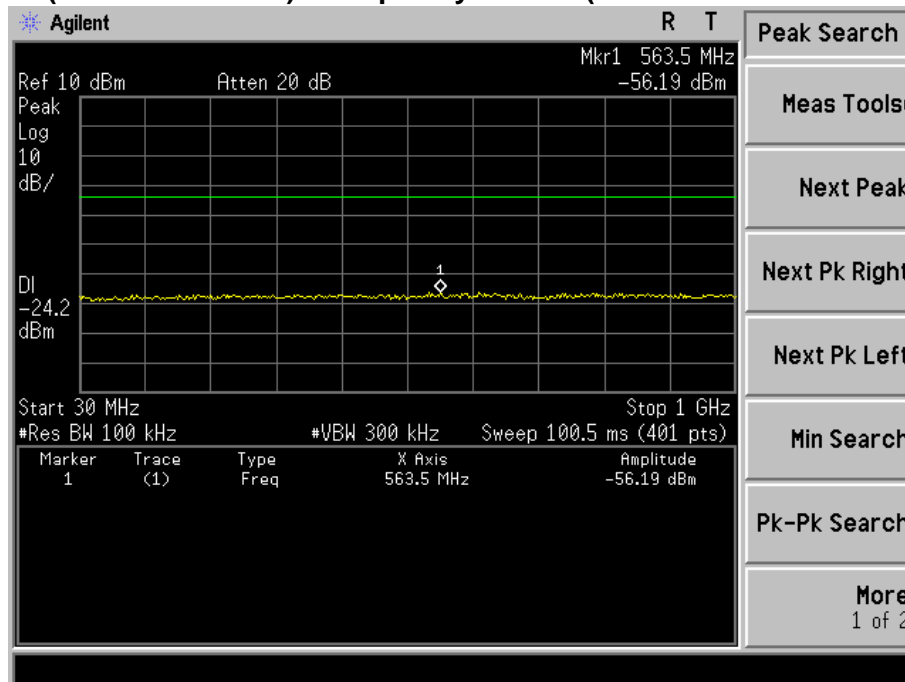

CH 00 ($\pi/4$ DPSK mode) - Frequency Band 2 (1000 MHz < f \leq 3000 MHz)

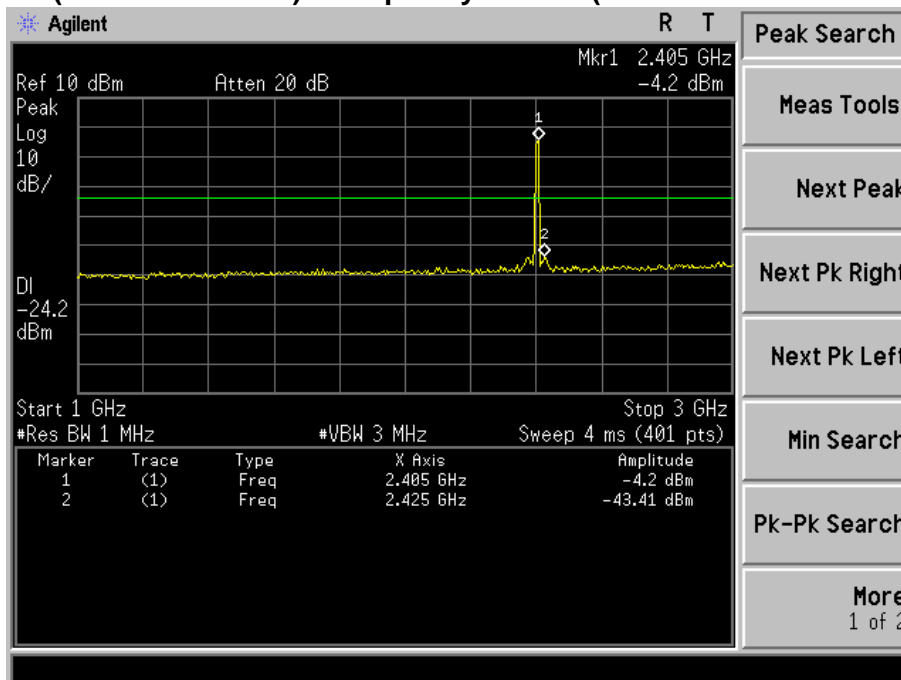



CH 00 ($\pi/4$ DPSK mode) - Frequency Band 3 (3000 MHz <math>f <math>\leq 25000 MHz)

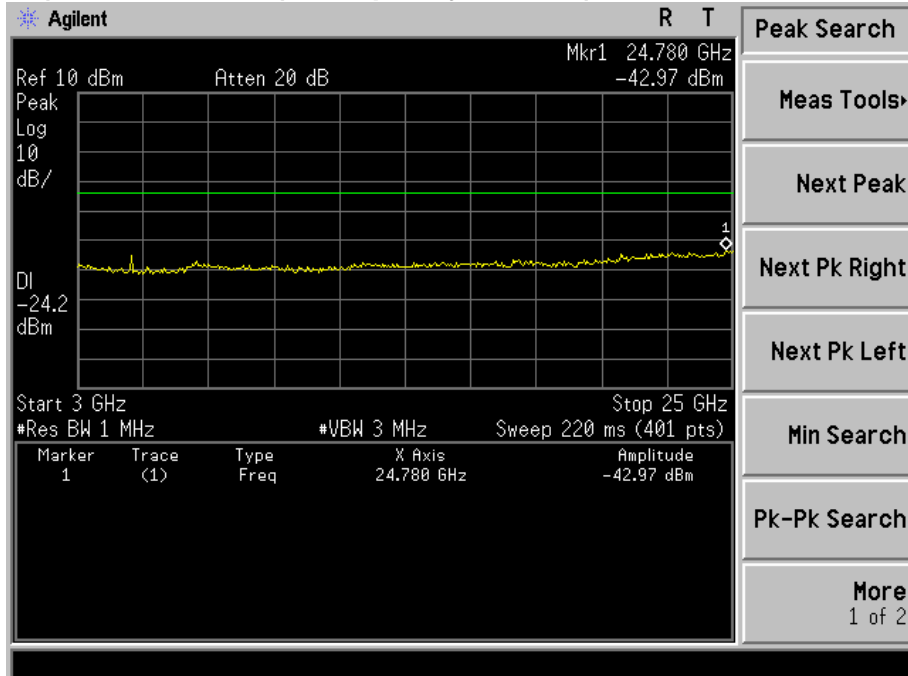

CH 39 ($\pi/4$ DPSK mode) - Frequency Band 1 (30 MHz $\leq f \leq 1000$ MHz)

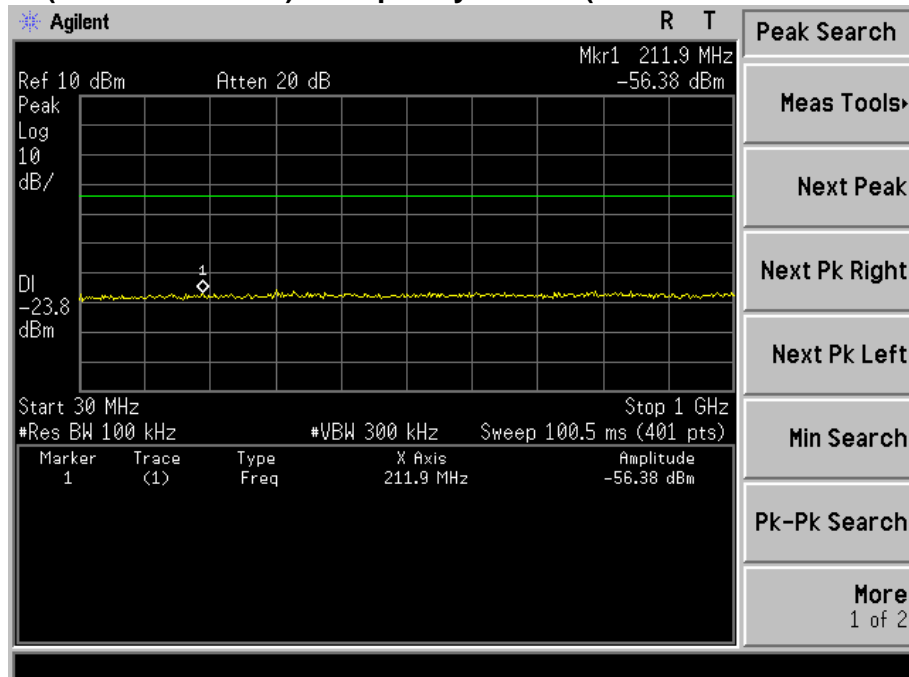



CH 39 ($\pi/4$ DPSK mode) - Frequency Band 2 ($1000 \text{ MHz} < f \leq 3000 \text{ MHz}$)

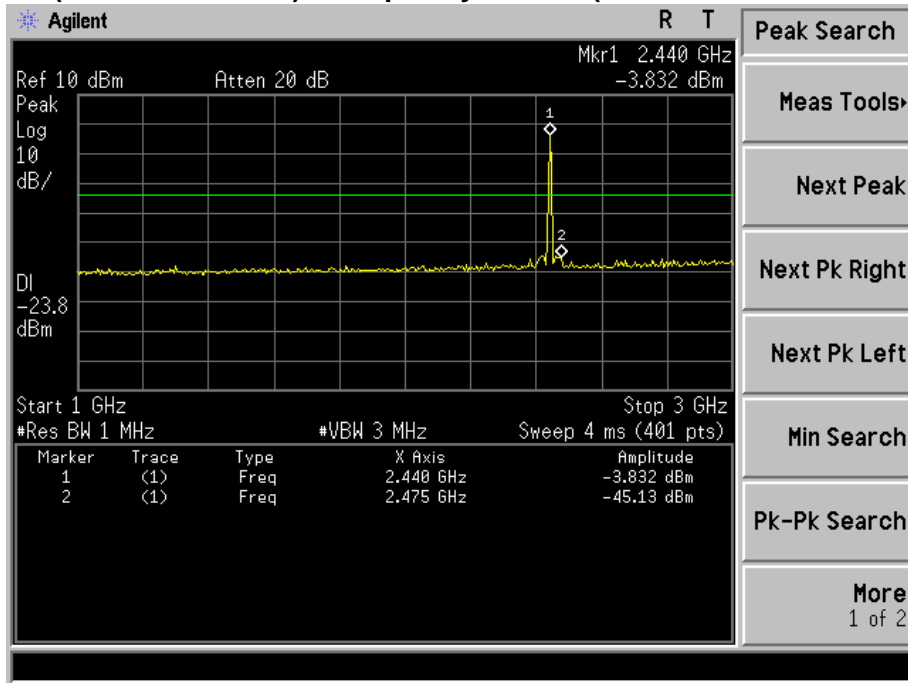

CH 39 ($\pi/4$ DPSK mode) - Frequency Band 3 ($3000 \text{ MHz} < f \leq 25000 \text{ MHz}$)

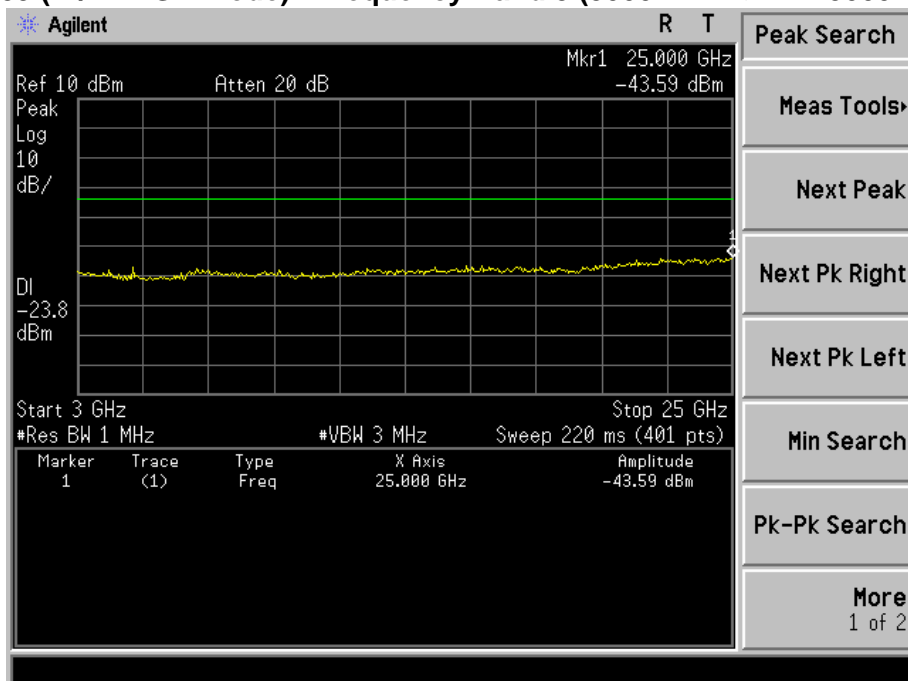



CH 78 ($\pi/4$ DPSK mode) - Frequency Band 1 ($30 \text{ MHz} \leq f \leq 1000 \text{ MHz}$)

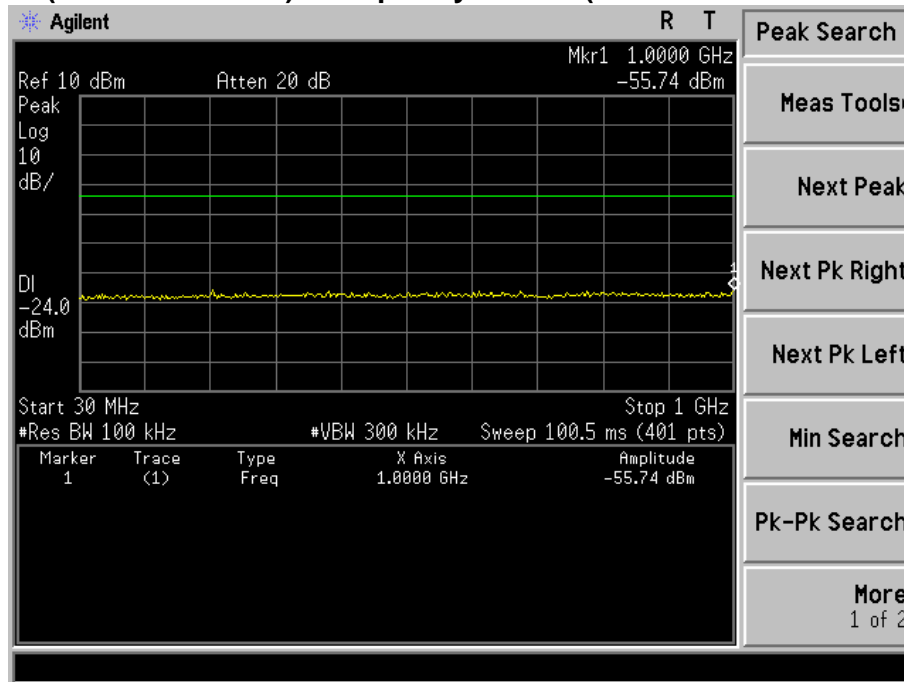

CH 78 ($\pi/4$ DPSK mode) - Frequency Band 2 ($1000 \text{ MHz} < f \leq 3000 \text{ MHz}$)

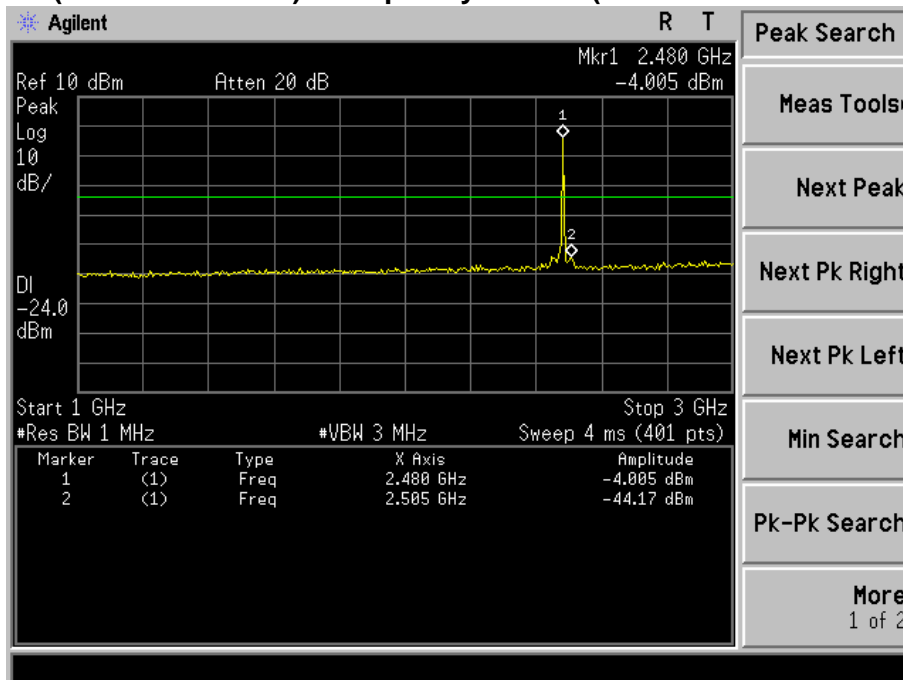



CH 78 ($\pi/4$ DPSK mode) - Frequency Band 3 (3000 MHz <math>f \leq 25000 MHz)

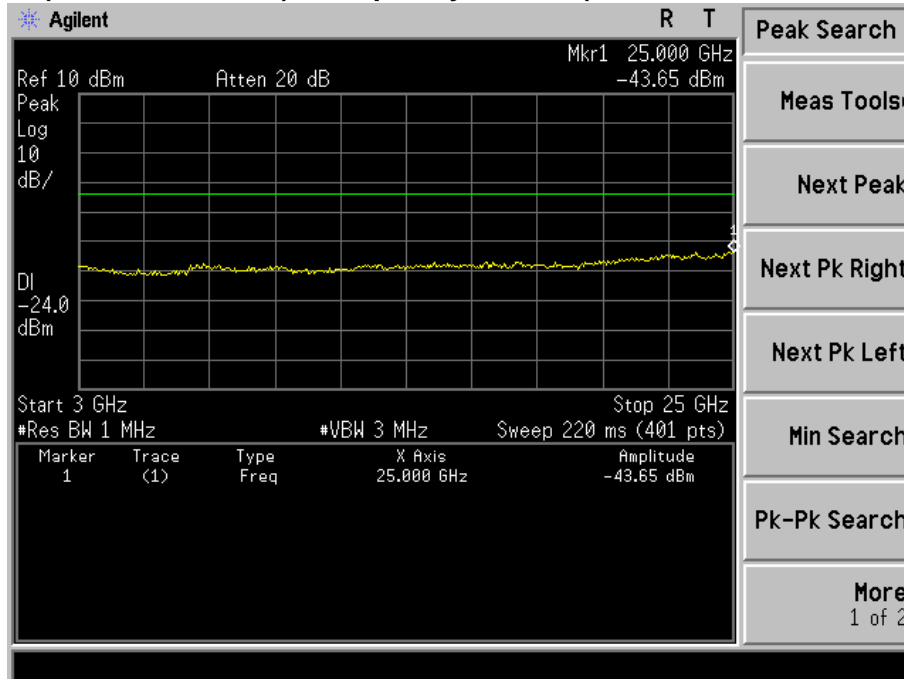



Operation Mode: 8DPSK mode(CH00, CH39, CH78)

CH 00 (8DPSK mode) - Frequency Band 1 (30 MHz \leq f \leq 1000 MHz)

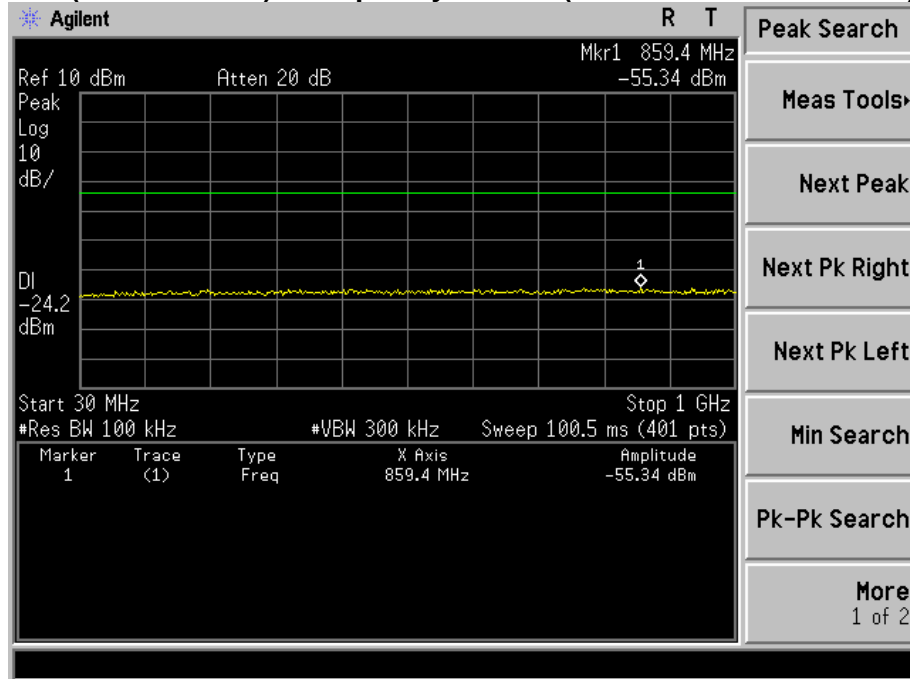

CH 00 (8DPSK mode) - Frequency Band 2 (1000 MHz < f \leq 3000 MHz)

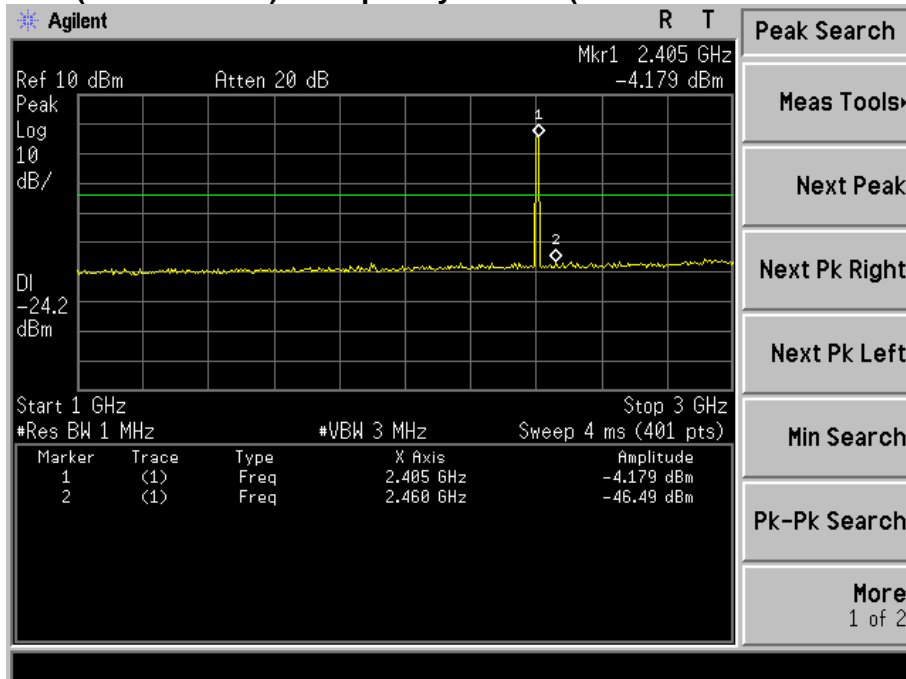



CH 00 (8DPSK mode) - Frequency Band 3 (3000 MHz $\leq f \leq 25000\text{ MHz}$)

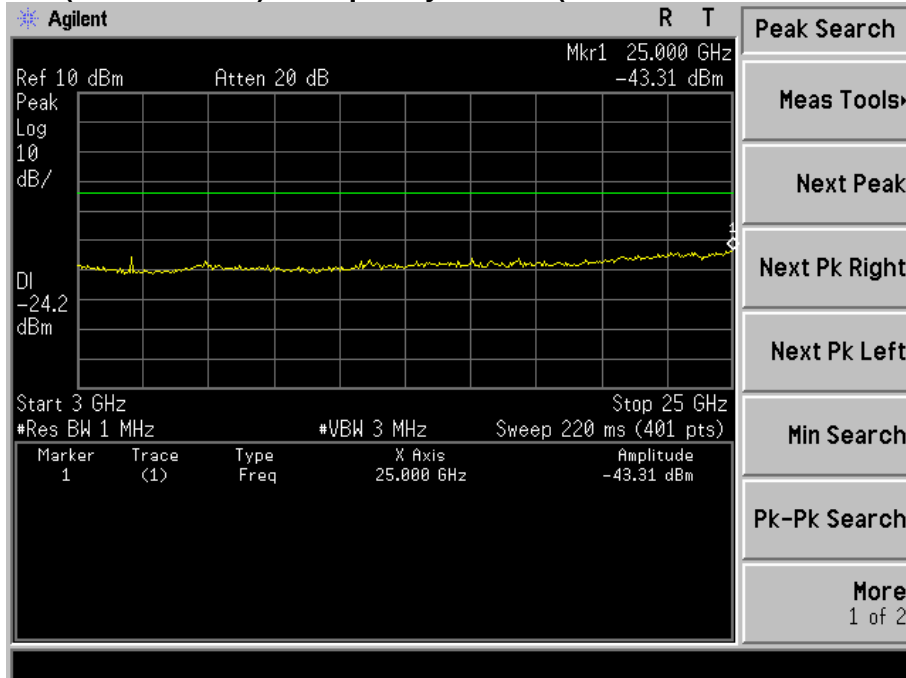

CH 39 (8DPSK mode) - Frequency Band 1 (30 MHz $\leq f \leq 1000\text{ MHz}$)

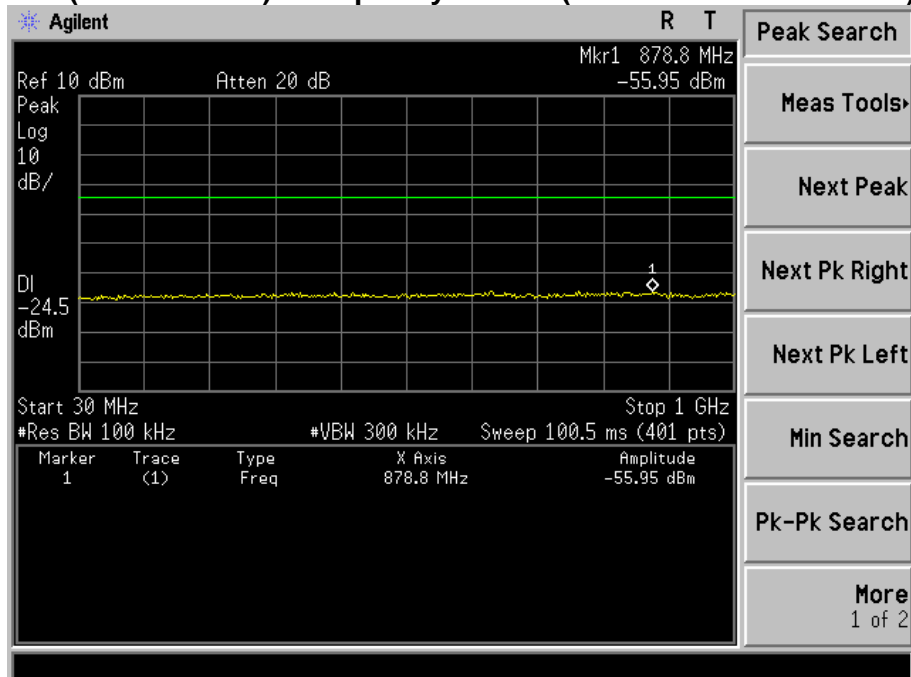



CH 39 (8DPSK mode) - Frequency Band 2 (1000 MHz < f ≦ 3000 MHz)

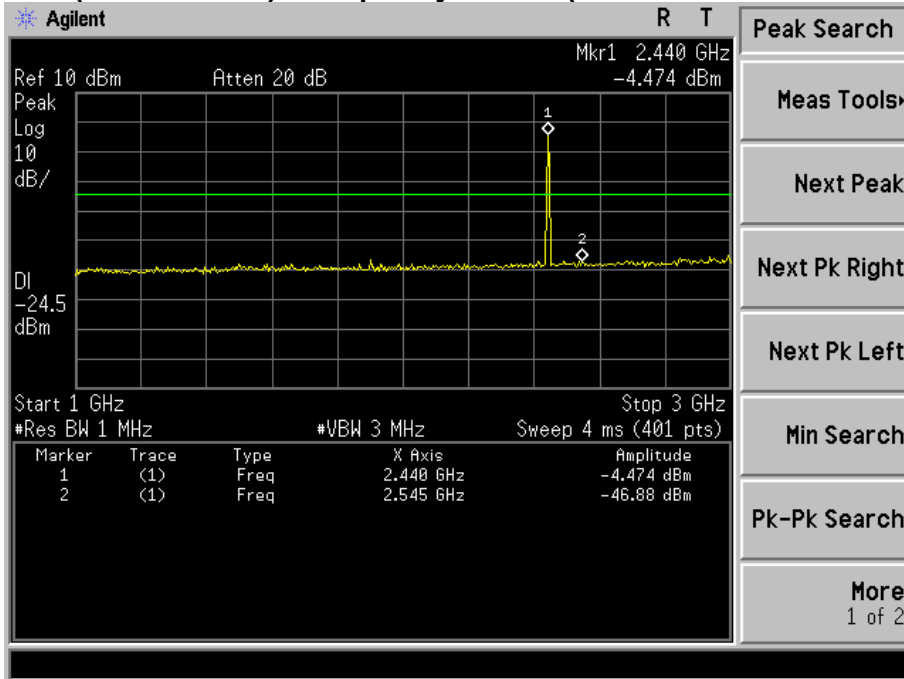

CH 39 (8DPSK mode) - Frequency Band 3 (3000 MHz < f ≦ 25000 MHz)

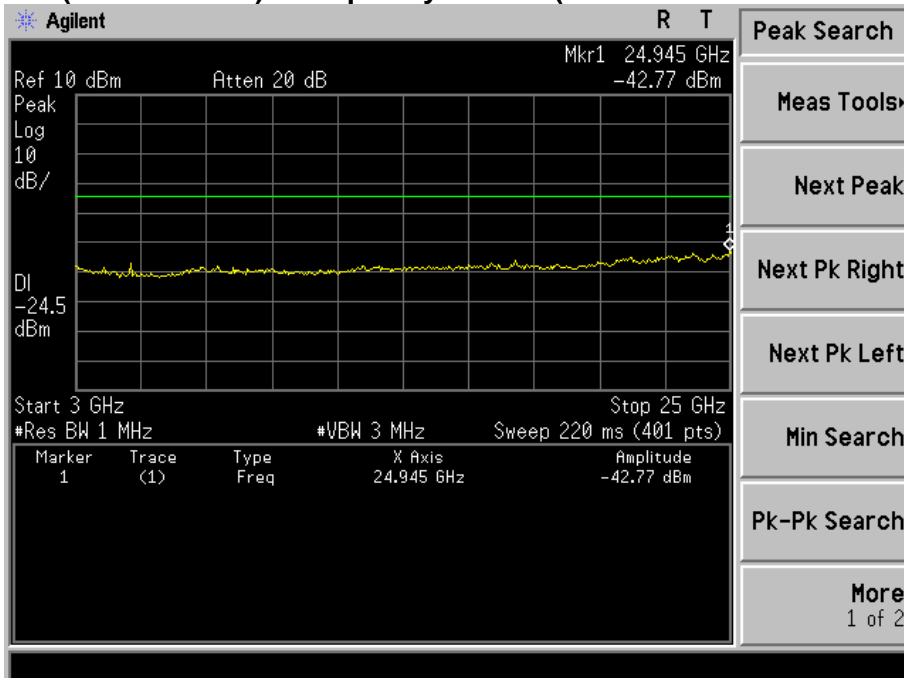



CH 78 (8DPSK mode) - Frequency Band 1 ($30 \text{ MHz} \leq f \leq 1000 \text{ MHz}$)

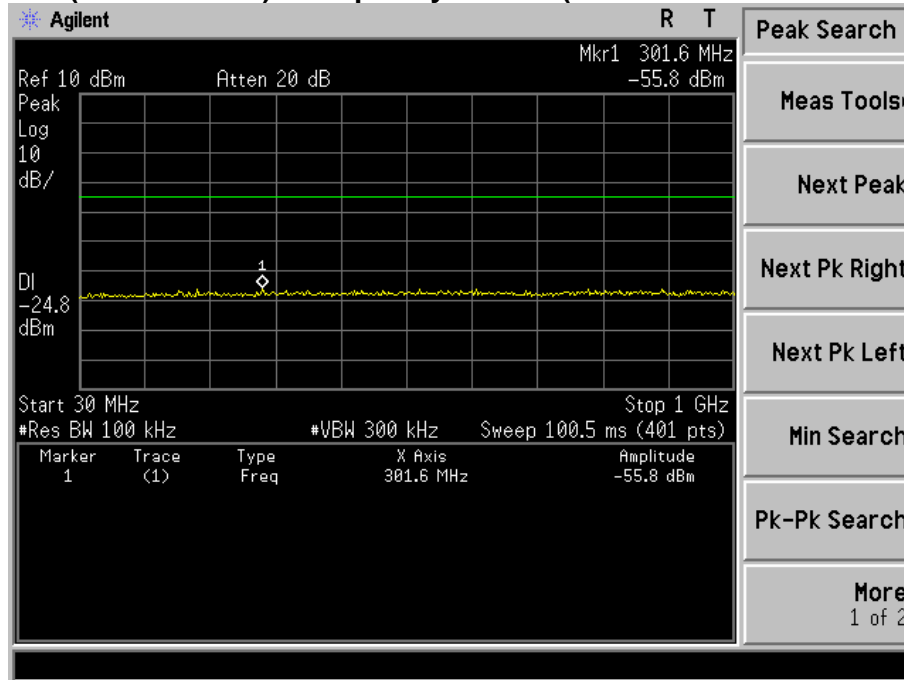

CH 78 (8DPSK mode) - Frequency Band 2 ($1000 \text{ MHz} < f \leq 3000 \text{ MHz}$)

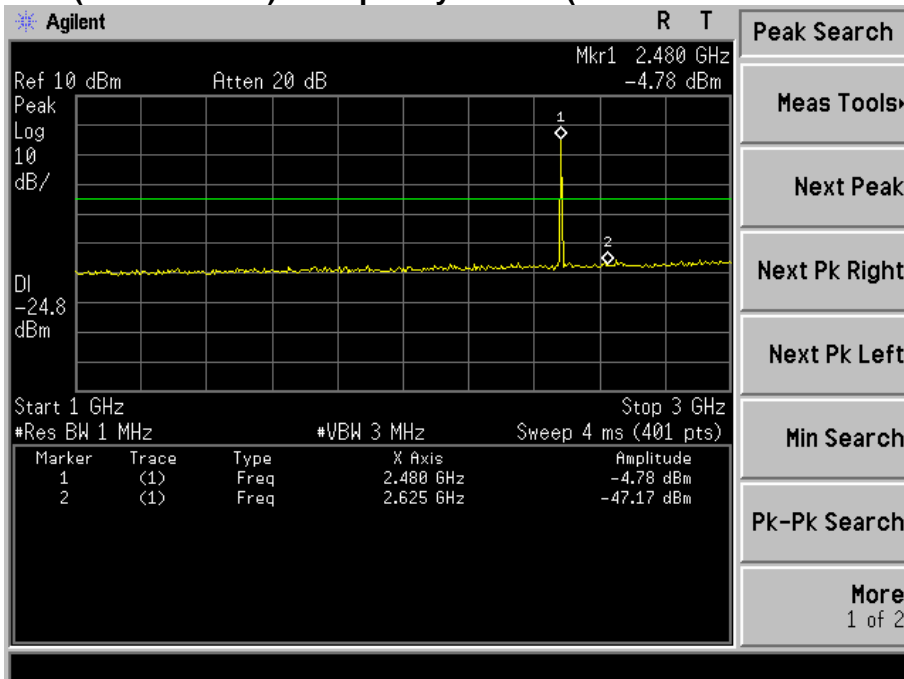



4. BANDWIDTH TEST

4.1 APPLIED PROCEDURES / LIMIT

FCC Part15 (15.249) , Subpart C				
Section	Test Item	Limit	Frequency Range (MHz)	Result
15.249	Bandwidth	(20dB bandwidth)	2400-2483.5	PASS

Spectrum Parameter	Setting
Attenuation	Auto
Span Frequency	> Measurement Bandwidth or Channel Separation
RB	100KHz
VB	≥RBW
Detector	Peak
Trace	Max Hold
Sweep Time	Auto

4.1.1 TEST PROCEDURE

- a. The EUT was directly connected to the spectrum analyzer and antenna output port as show in the block diagram below,
- b. Spectrum Setting : RBW= 100KHz, VBW≥ RBW, Sweep time = Auto.

4.1.2 DEVIATION FROM STANDARD

No deviation.

4.1.3 TEST SETUP



4.1.4 EUT OPERATION CONDITIONS

The EUT tested system was configured as the statements of 2.4 Unless otherwise a special operating condition is specified in the follows during the testing.



4.1.5 TEST RESULTS

EUT :	spabluetooth speaker	Model Name :	spabluetooth speaker
Temperature :	25 °C	Relative Humidity :	55%
Pressure :	1012 hPa	Test Voltage :	DC3.7V
Test Mode :	CH00 / CH39 /C78		

	Frequency	20dB Bandwidth (kHz)	Result
GFSK	2402 MHz	1079	PASS
	2441 MHz	1105	PASS
	2480 MHz	1095	PASS
PI/4 DPSK	2402 MHz	1376	PASS
	2441 MHz	1383	PASS
	2480 MHz	1381	PASS
8DPSK	2402 MHz	1388	PASS
	2441 MHz	1414	PASS
	2480 MHz	1408	PASS



GFSK

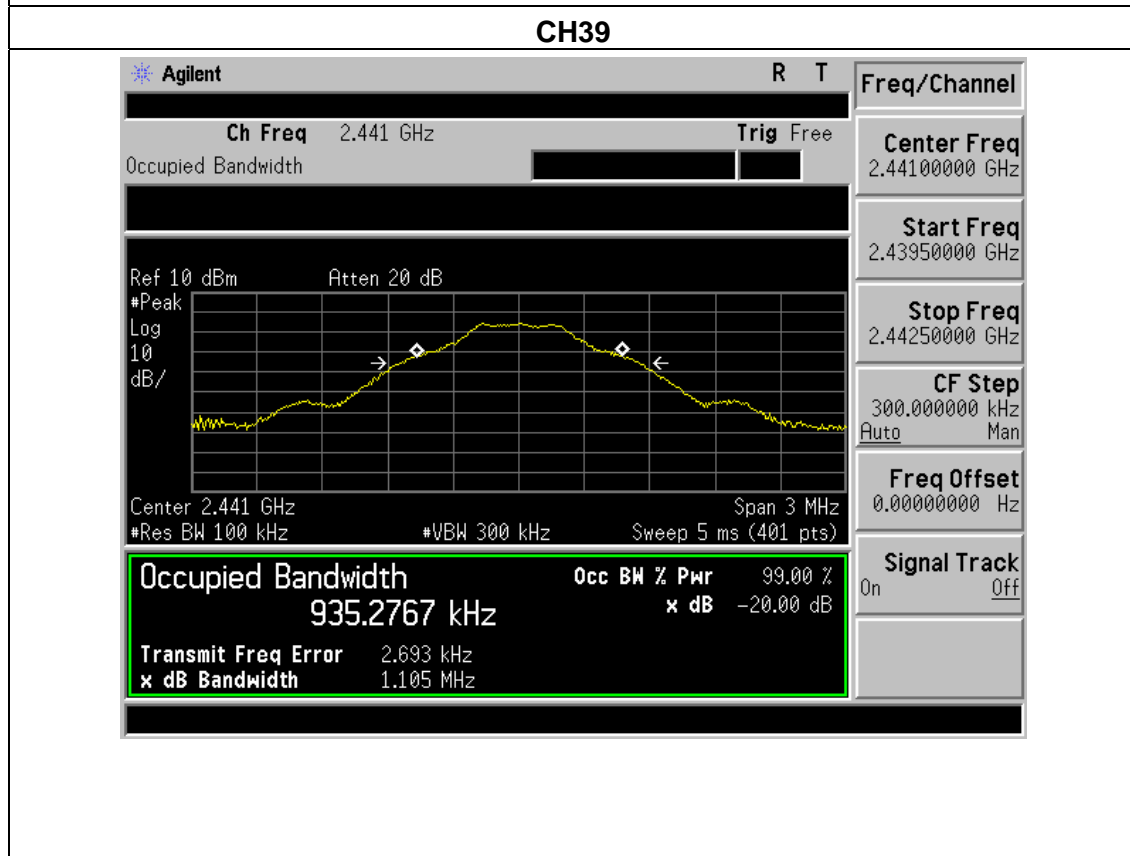
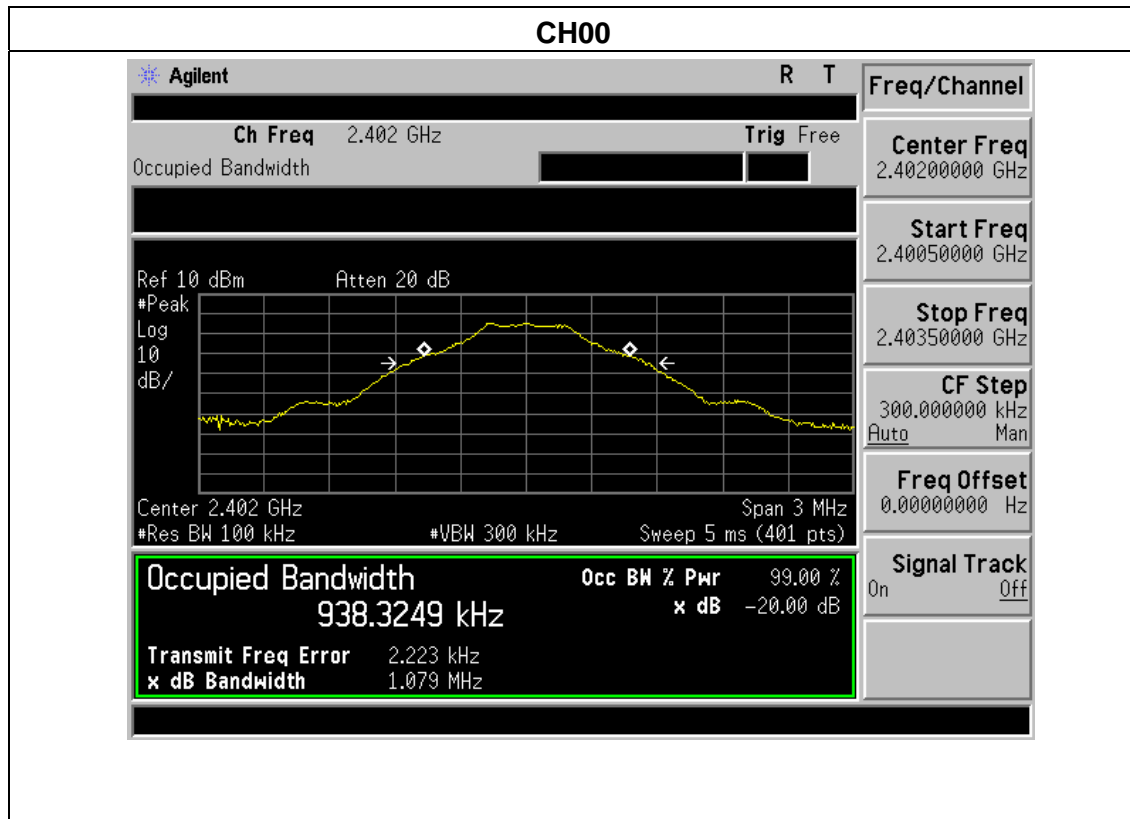

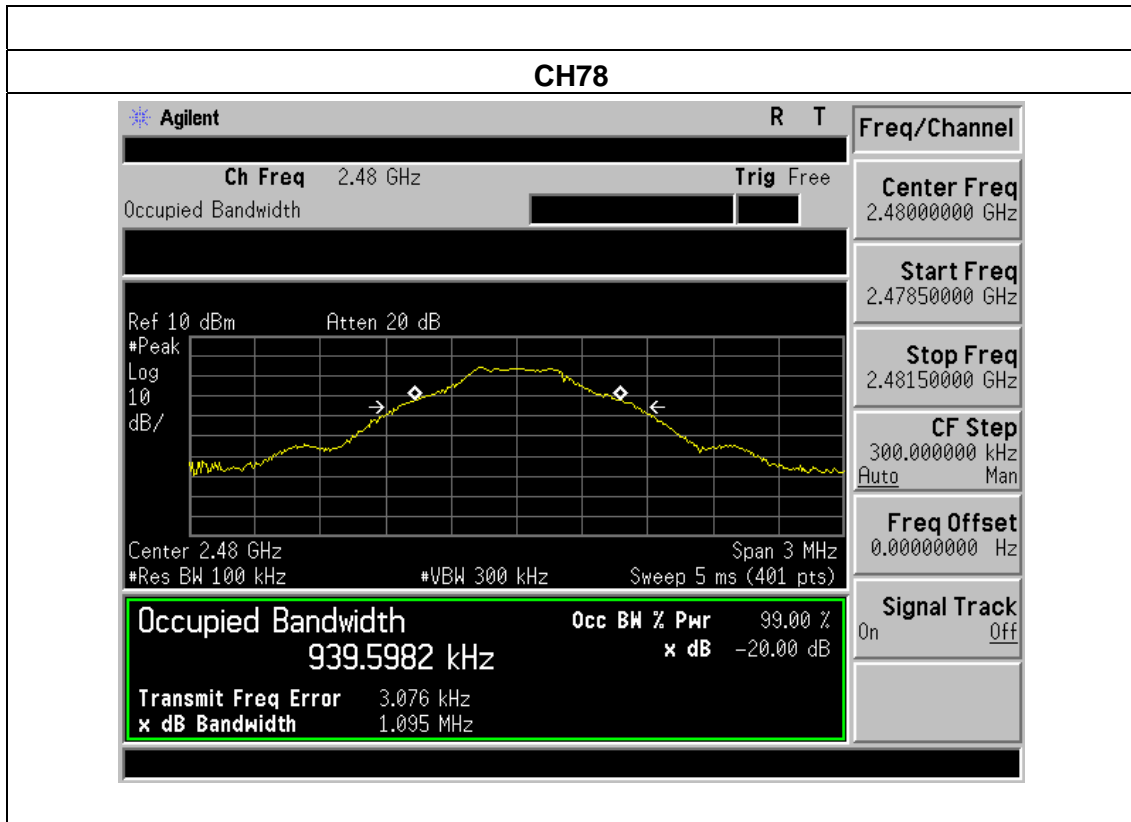



PI/4 DPSK

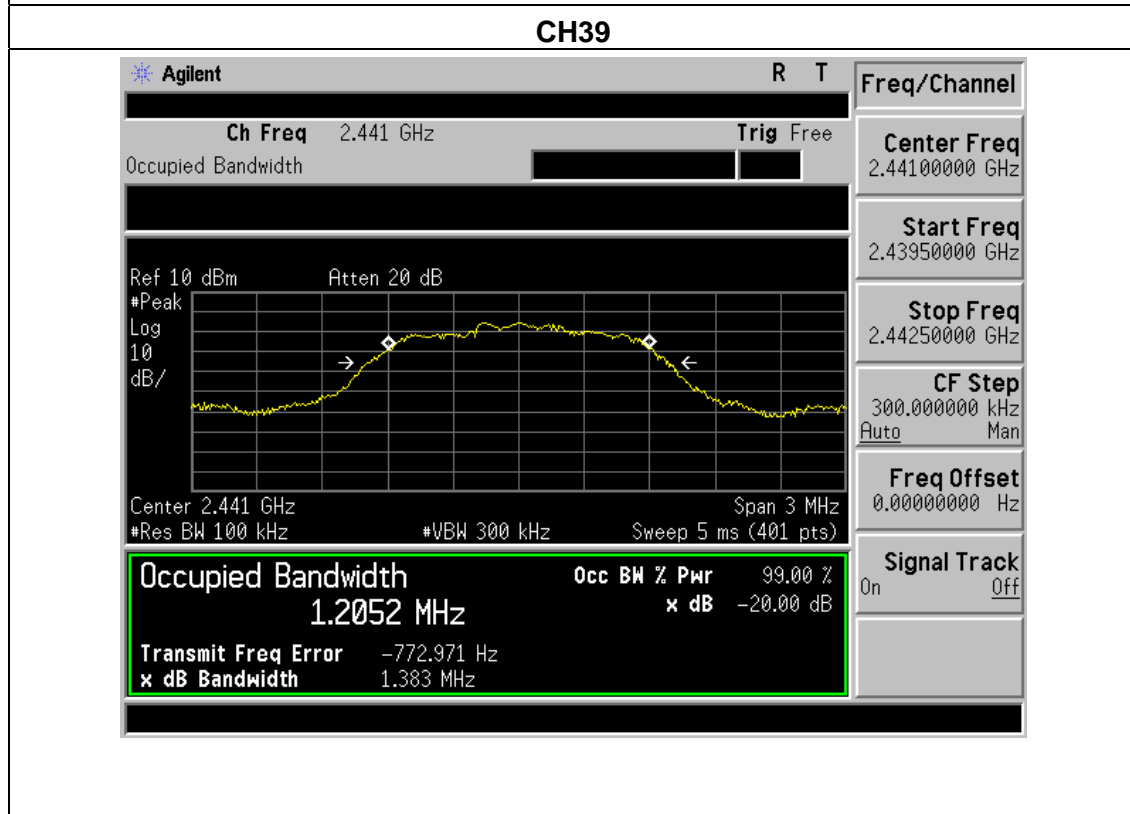
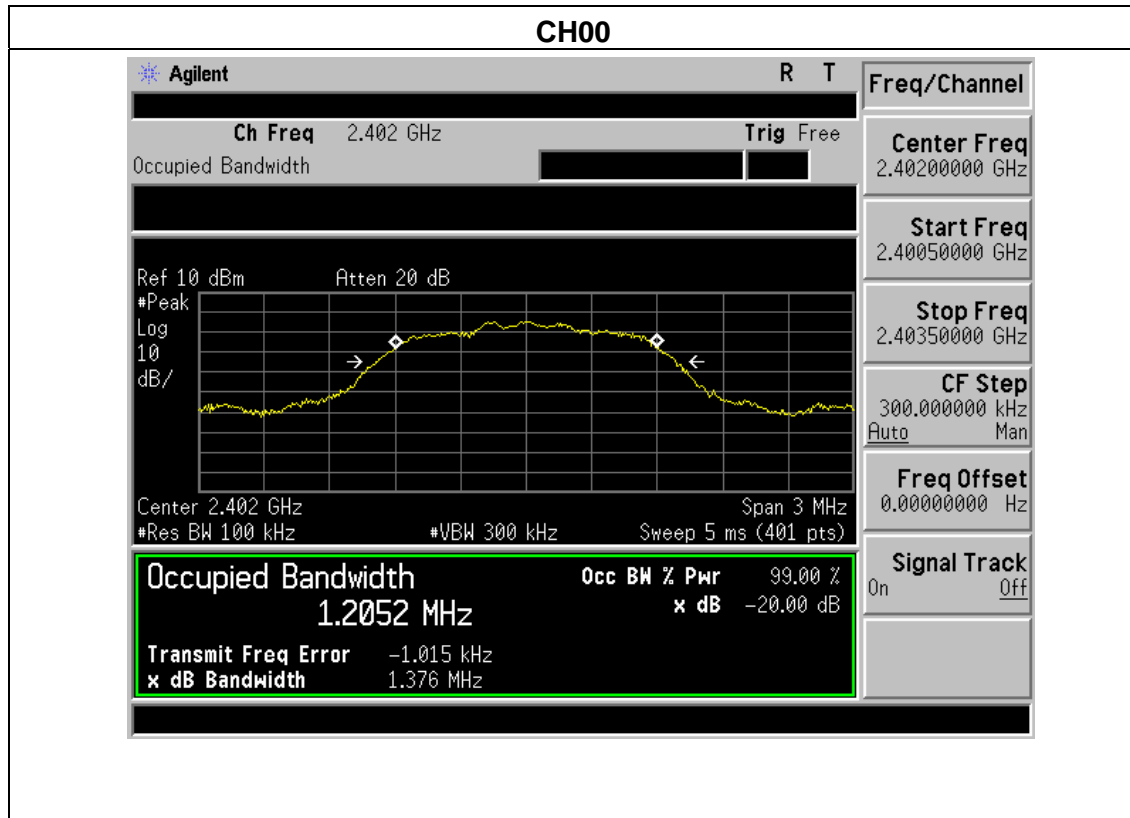

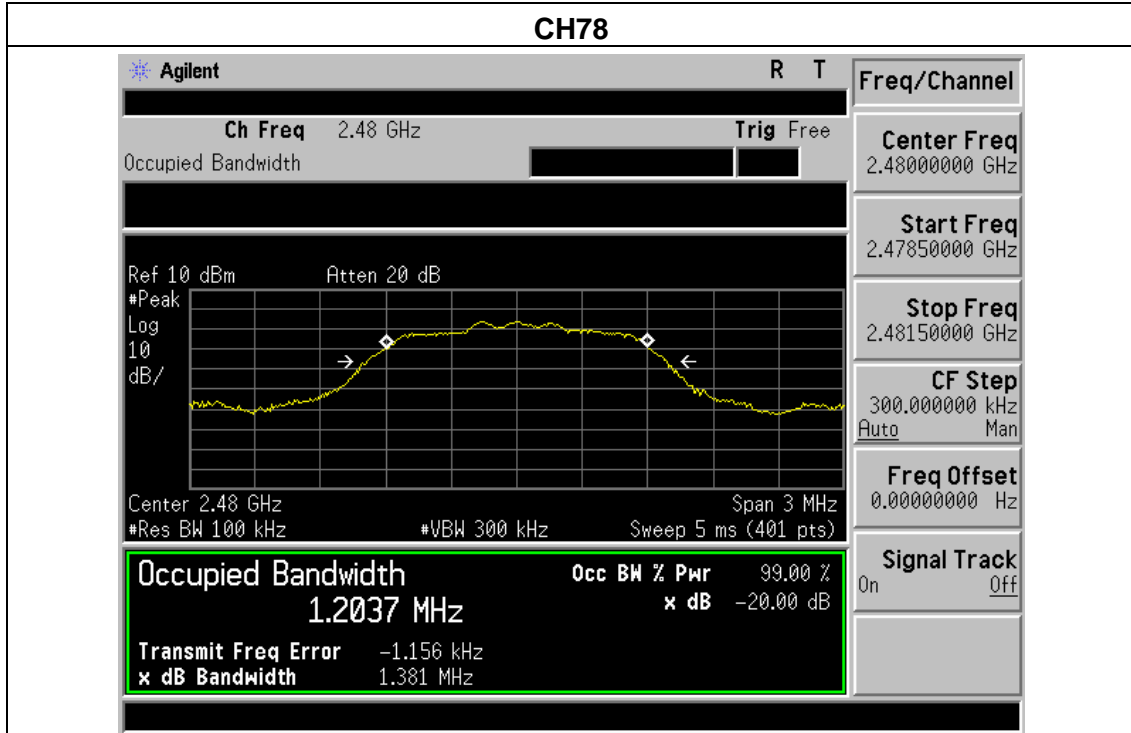



8DPSK

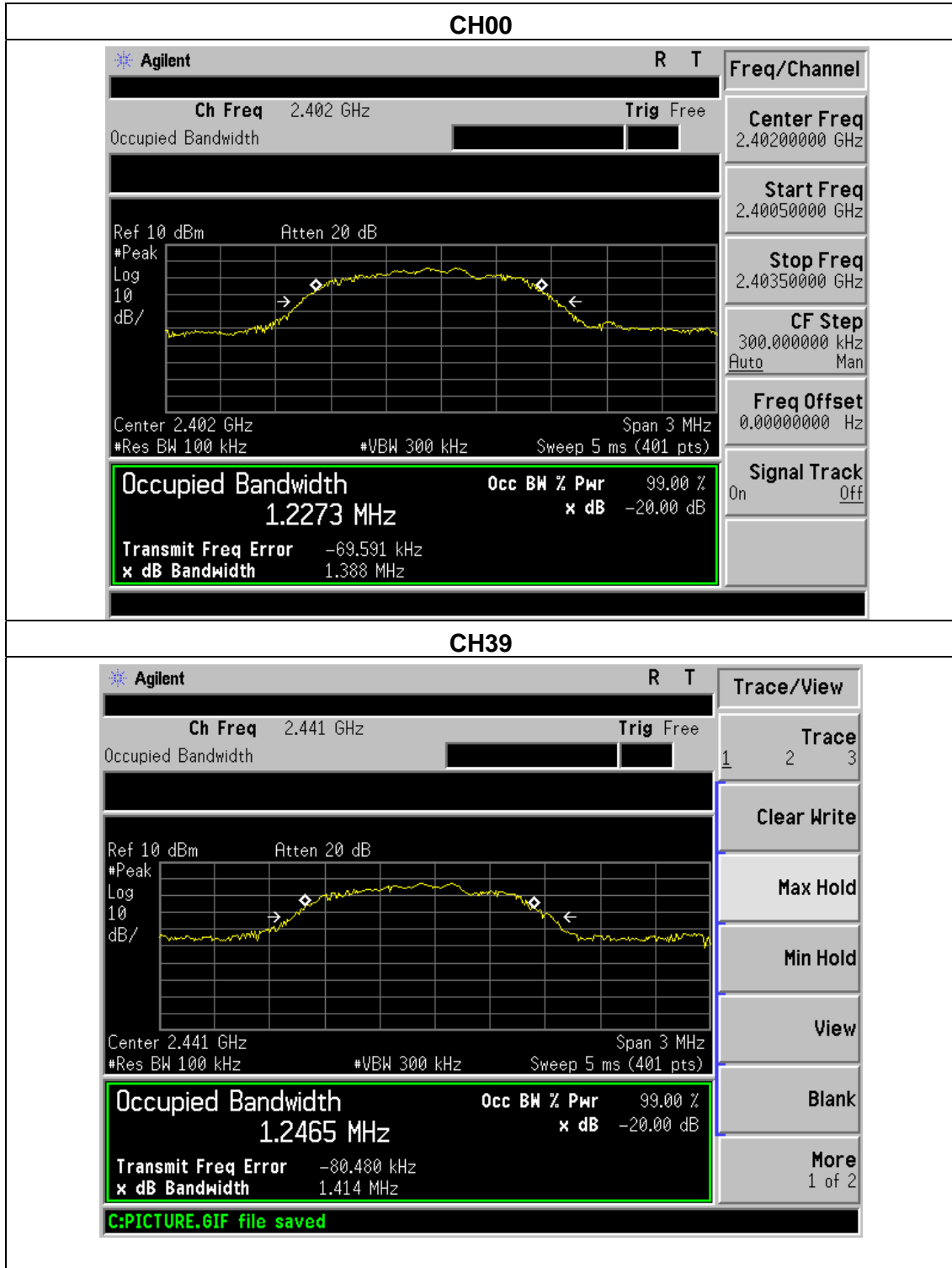

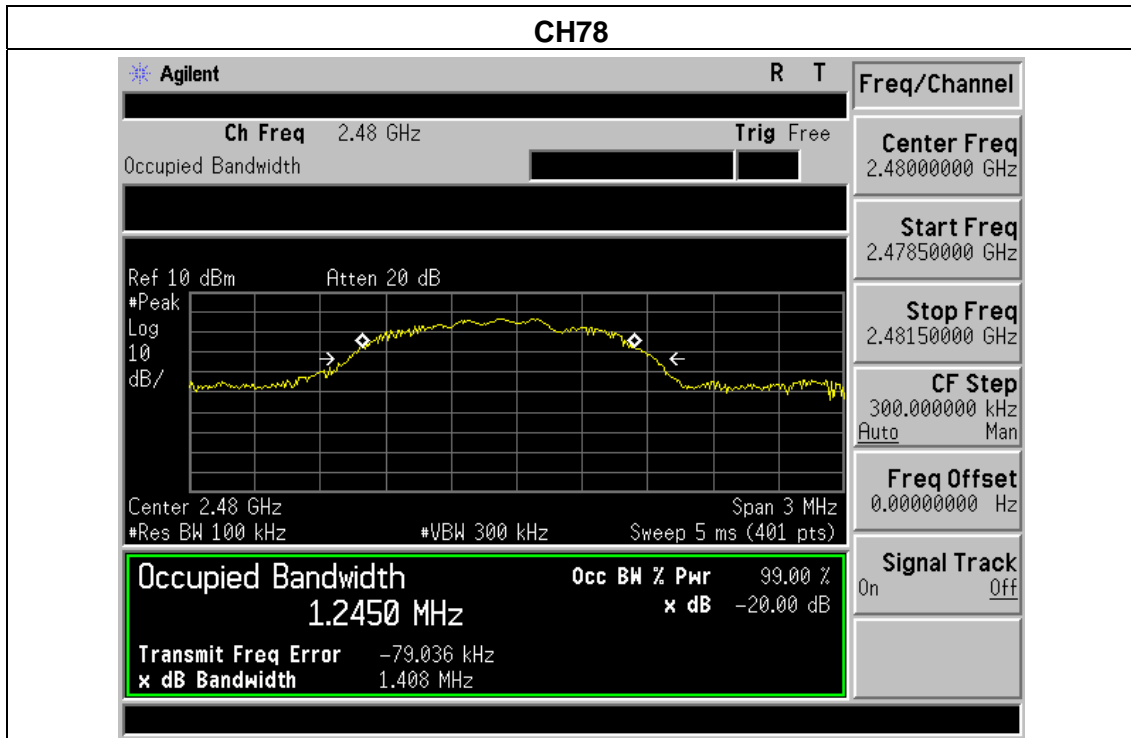



5. 100 KHZ BANDWIDTH OF FREQUENCY BAND EDGE

APPLICABLE STANDARD

In any 100 kHz bandwidth outside the frequency band in which the spread spectrum or digitally modulated intentional radiator is operating, the radio frequency power that is produced by the intentional radiator shall be at least 20 dB below that in the 100 kHz bandwidth within the band that contains the highest level of the desired power, based on either an RF conducted or a radiated measurement, provided the transmitter demonstrates compliance with the peak conducted power limits. If the transmitter complies with the conducted power limits based on the use of RMS averaging over a time interval, as permitted under paragraph (b)(3) of this section, the attenuation required under this paragraph shall be 30 dB instead of 20 dB. Attenuation below the general limits specified in §15.209(a) is not required. In addition, radiated emissions which fall in the restricted bands, as defined in §15.205(a), must also comply with the radiated emission limits specified in §15.209(a)(c)

TEST PROCEDURE

- a) Check the calibration of the measuring instrument using either an internal calibrator or a known signal from an external generator.
- b) Position the EUT without connection to measurement instrument. Turn on the EUT and connect its antenna terminal to measurement instrument via a low loss cable. Then set it to any one measured frequency within its operating range, and make sure the instrument is operated in its linear range.
- c) Set RBW to 100 kHz and VBW of spectrum analyzer to 300 kHz with a convenient frequency span including 100 kHz bandwidth from band edge.
- d) Measure the highest amplitude appearing on spectral display and set it as a reference level. Plot the graph with marking the highest point and edge frequency.
- e) Repeat above procedures until all measured frequencies were complete.

Note:

Both horizontal and vertical antenna polarities were tested and performed pretest to three orthogonal axis. The worst case emissions were reported



5.1 DEVIATION FROM STANDARD

No deviation.

5.2 EUT OPERATION CONDITIONS

The EUT tested system was configured as the statements of 2.4 Unless otherwise a special operating condition is specified in the follows during the testing.



5.3 TEST RESULTS

Temperature :	25 °C	Relative Humidity :	54%
Pressure :	1012 hPa	Test Voltage :	DC3.7V
Test Mode :	CH00/ CH78		

	Polar (H/V)	Frequency (MHz)	Meter Reading (dBuV)	Pre-amplifier (dB)	Cable Loss (dB)	Antenna Factor (dB/m)	Emission level (dBuV/m)	Limits (dBuV/m)		Result	
							PK	PK	AV		
GFSK	Low Channel 2402MHz										
	H	2390.00	57.93	38.06	7.42	20.15	47.44	74.00	54.00	PASS	
	H	2400.00	56.67	38.06	7.42	20.15	46.18	74.00	54.00	PASS	
	V	2390.00	57.52	38.06	7.42	20.15	47.03	74.00	54.00	PASS	
	V	2400.00	58.68	38.06	7.42	20.15	48.19	74.00	54.00	PASS	
	High Channel 2480MHz										
	H	2483.50	57.23	38.17	7.42	20.51	46.99	74.00	54.00	PASS	
	H	2483.50	57.87	38.17	7.42	20.51	47.63	74.00	54.00	PASS	
	V	2485.50	57.74	38.2	7.45	20.54	47.53	74.00	54.00	PASS	
	V	2485.50	58.65	38.2	7.45	20.54	48.44	74.00	54.00	PASS	
	PI/4 DPSK	Low Channel 2402MHz									
		H	2390.00	58.71	38.06	7.42	20.15	48.22	74.00	54.00	PASS
H		2400.00	58.56	38.06	7.42	20.15	48.07	74.00	54.00	PASS	
V		2390.00	59.24	38.06	7.42	20.15	48.75	74.00	54.00	PASS	
V		2400.00	58.66	38.06	7.42	20.15	48.17	74.00	54.00	PASS	
High Channel 2480MHz											
H		2483.50	58.36	38.17	7.42	20.51	48.12	74.00	54.00	PASS	
H		2483.50	59.61	38.17	7.42	20.51	49.37	74.00	54.00	PASS	
V		2485.50	59.78	38.2	7.45	20.54	49.57	74.00	54.00	PASS	
V		2485.50	59.29	38.2	7.45	20.54	49.08	74.00	54.00	PASS	
8DPSK		Low Channel 2402MHz									
		H	2390.00	59.63	38.06	7.42	20.15	49.14	74.00	54.00	PASS
	H	2400.00	59.55	38.06	7.42	20.15	49.06	74.00	54.00	PASS	
	V	2390.00	59.02	38.06	7.42	20.15	48.53	74.00	54.00	PASS	
	V	2400.00	58.10	38.06	7.42	20.15	47.61	74.00	54.00	PASS	
	High Channel 2480MHz										
	H	2483.50	59.64	38.17	7.42	20.51	49.40	74.00	54.00	PASS	
	H	2483.50	58.23	38.17	7.42	20.51	47.99	74.00	54.00	PASS	
	V	2485.50	60.81	38.2	7.45	20.54	50.6	74.00	54.00	PASS	
	V	2485.50	59.93	38.2	7.45	20.54	49.72	74.00	54.00	PASS	

Remark:

1. Emission Level = Meter Reading + Antenna Factor + Cable Loss – Pre-amplifier, Margin= Emission Level - Limit
2. If the PK measured levels comply with average limit, then the average level were deemed to comply with average limit.

If the PK measured levels comply with average limit, then the average level were deemed to comply with average limit.



GFSK

2402MHz Horizontal

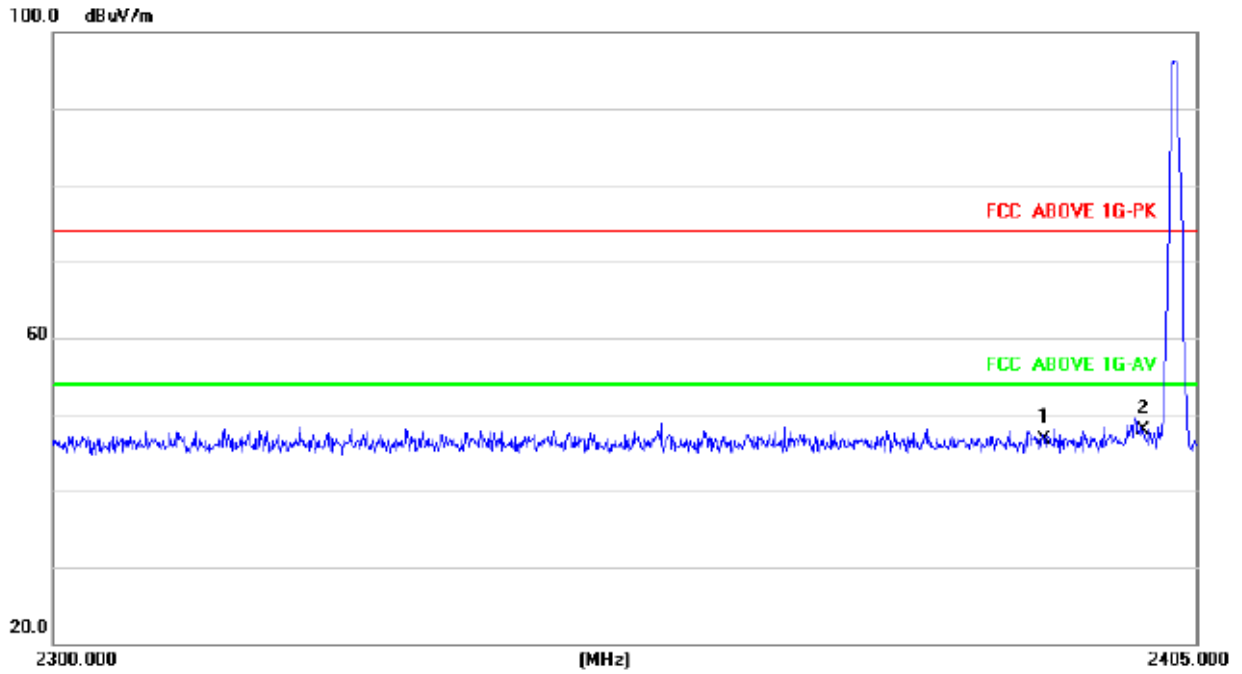

2402MHz Vertical

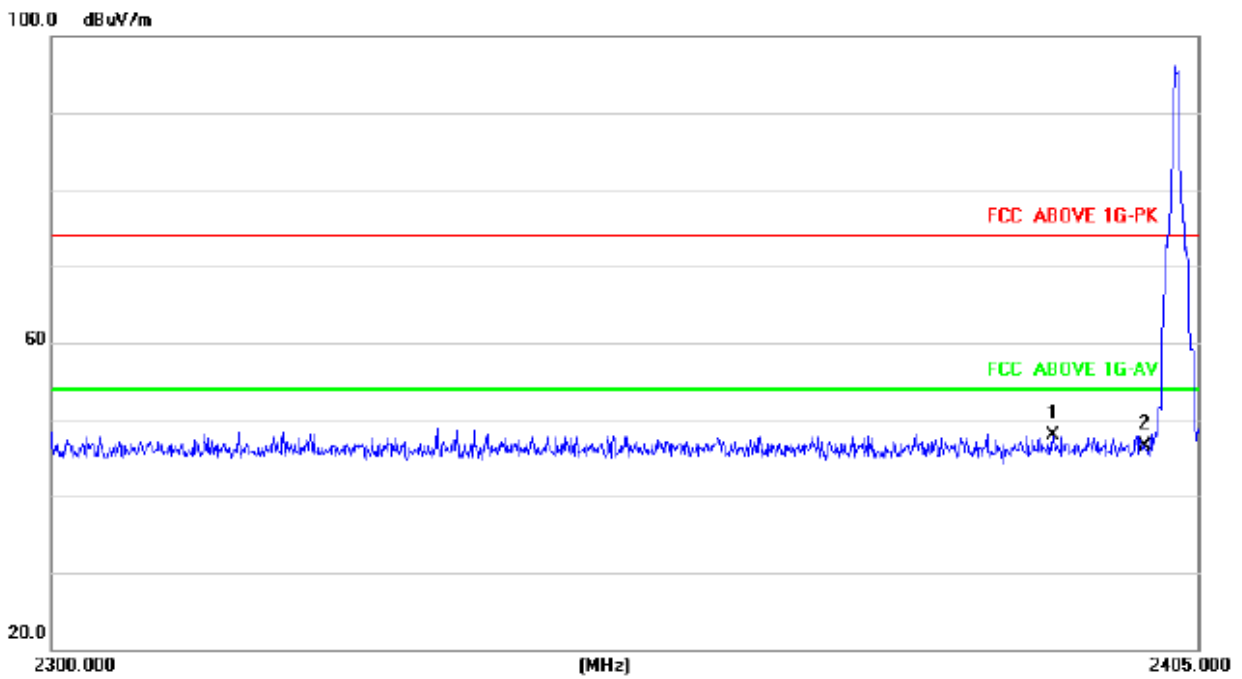



2480MHz Horizontal

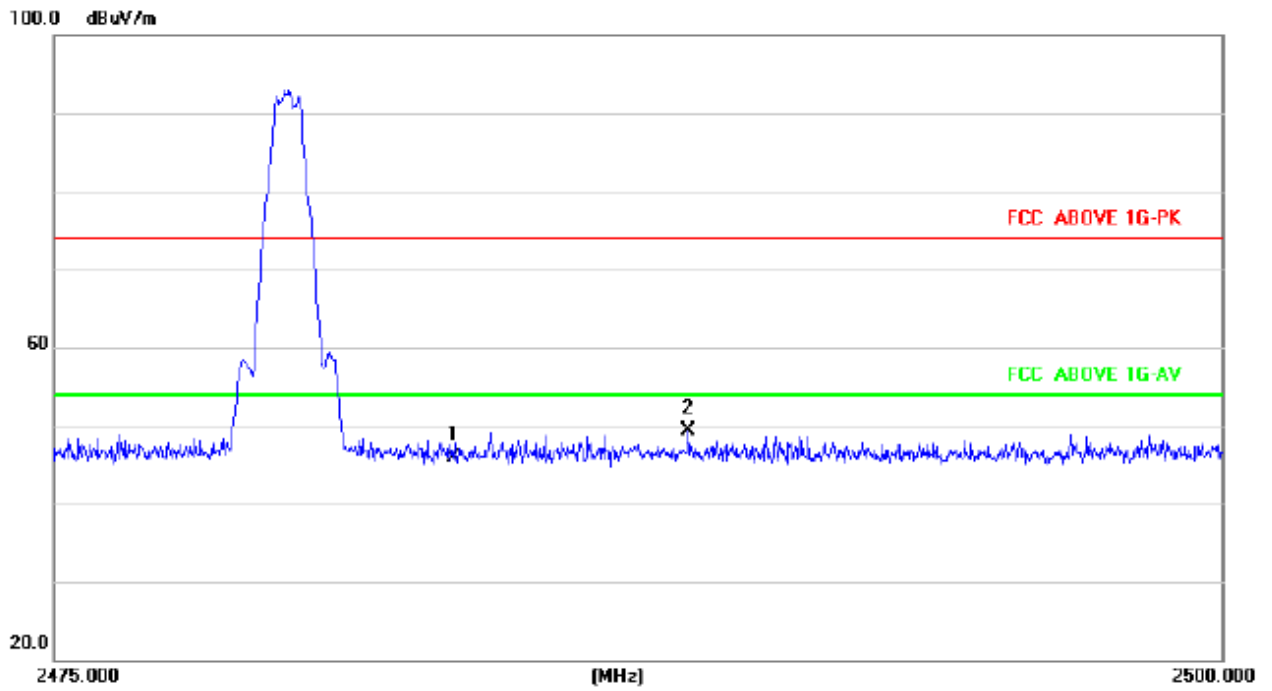

2480MHz Vertical

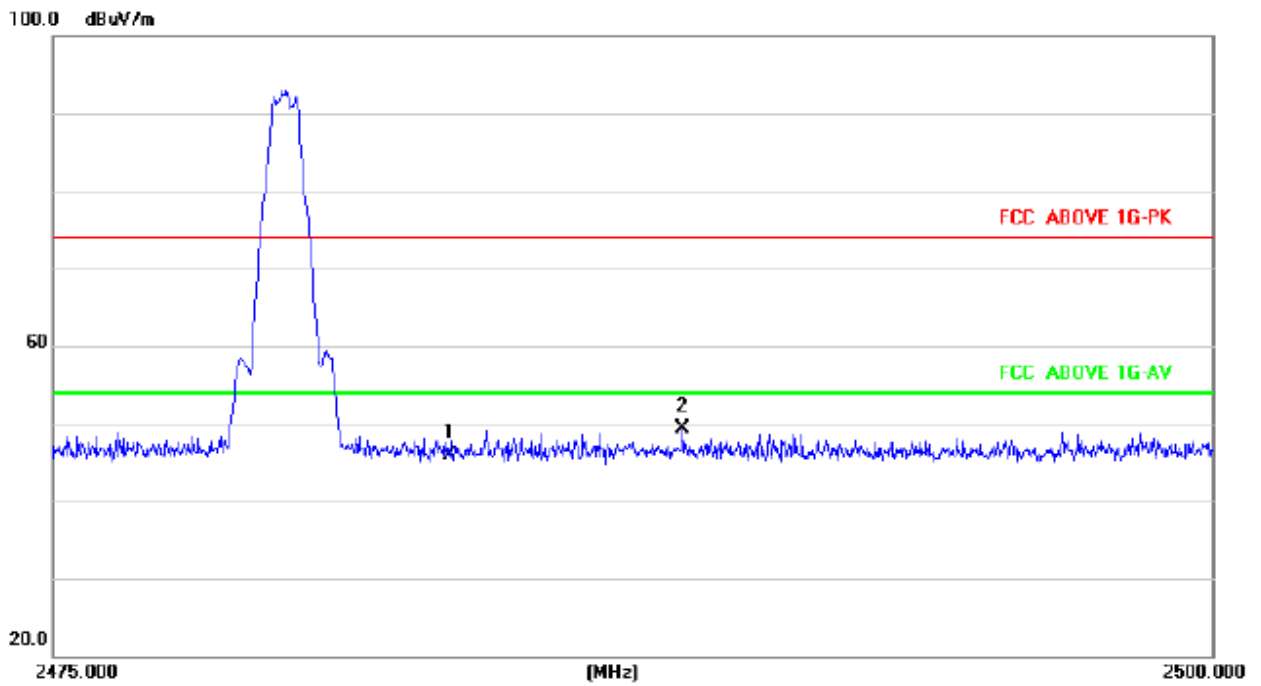



PI/4 DPSK

2402MHz Horizontal

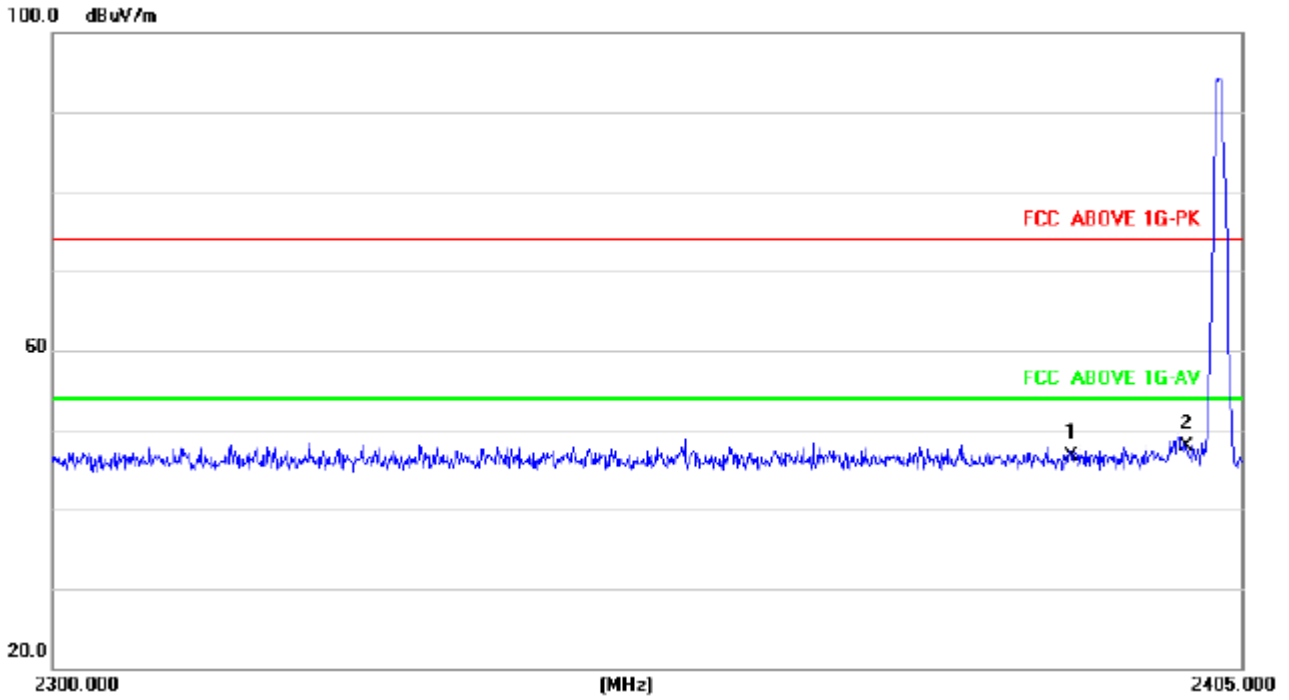

2402MHz Vertical

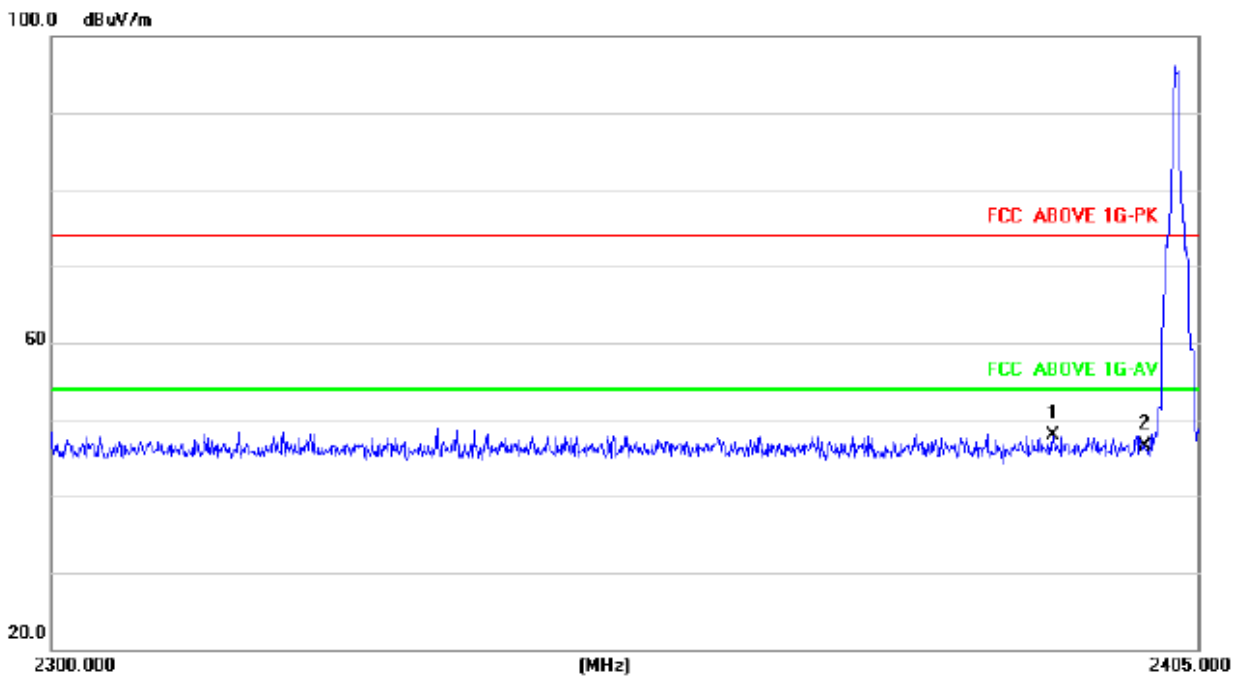



2480MHz Horizontal

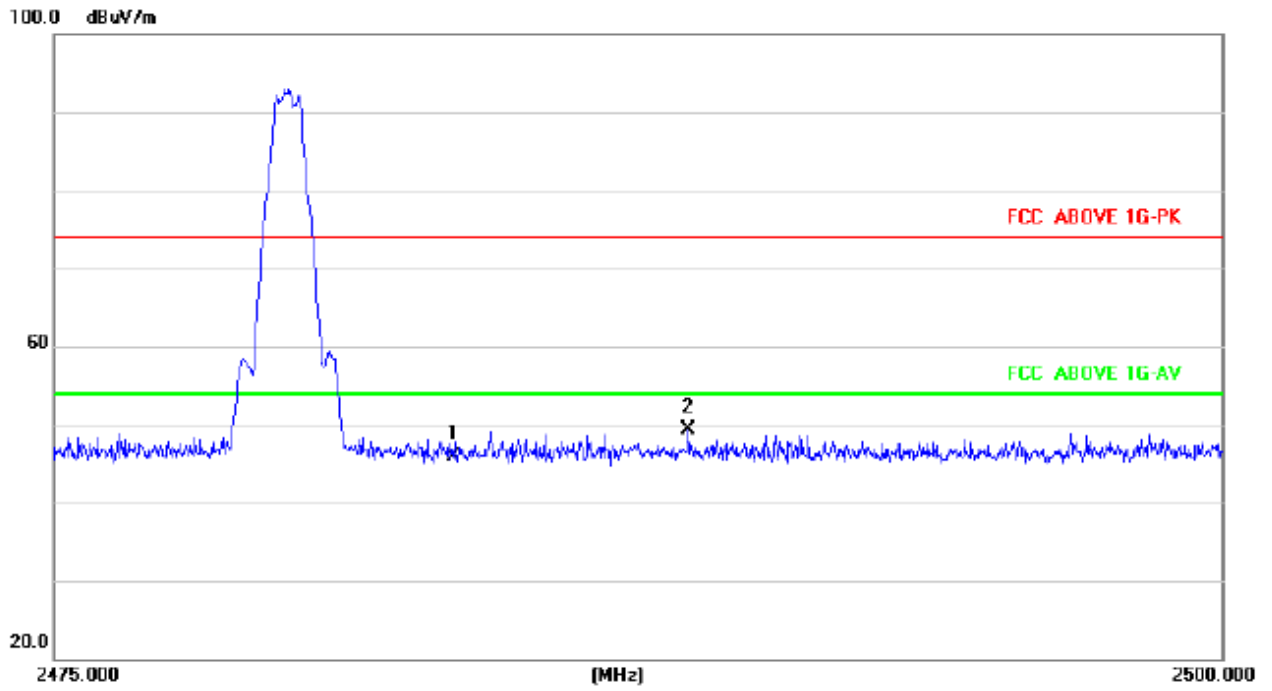

2480MHz Vertical

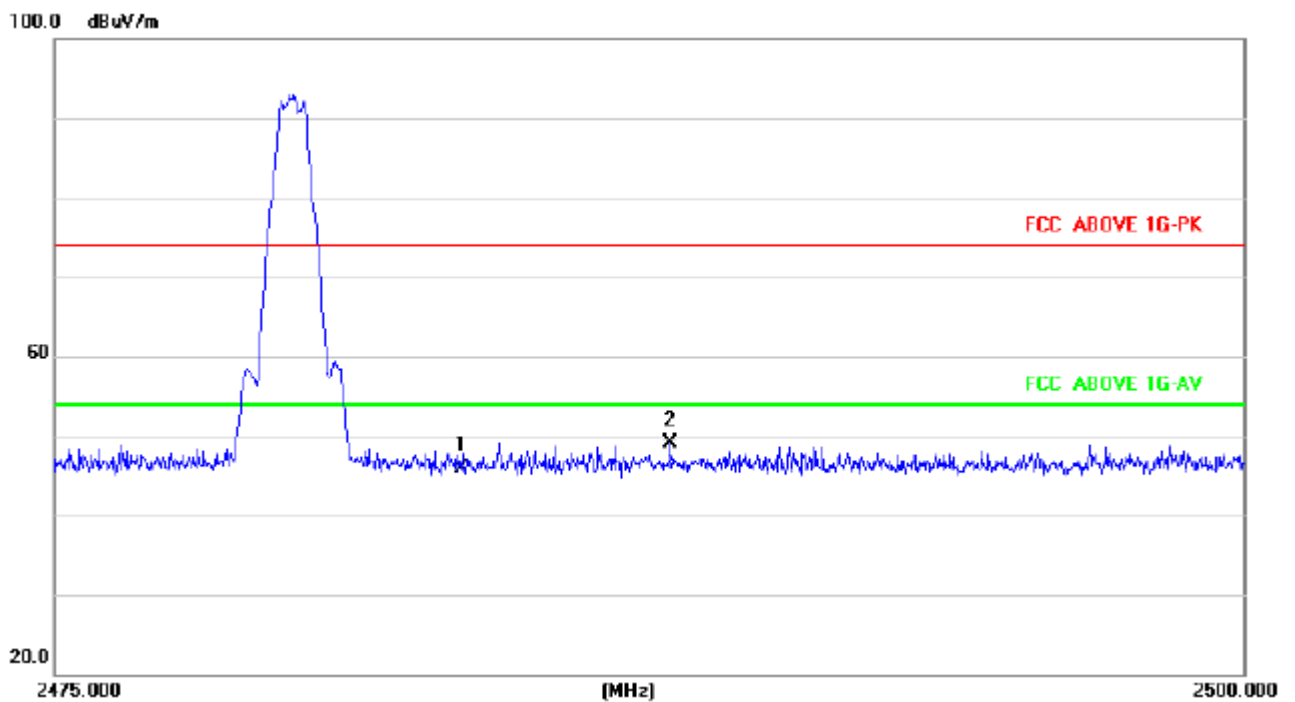



8DPSK

2402MHz Horizontal

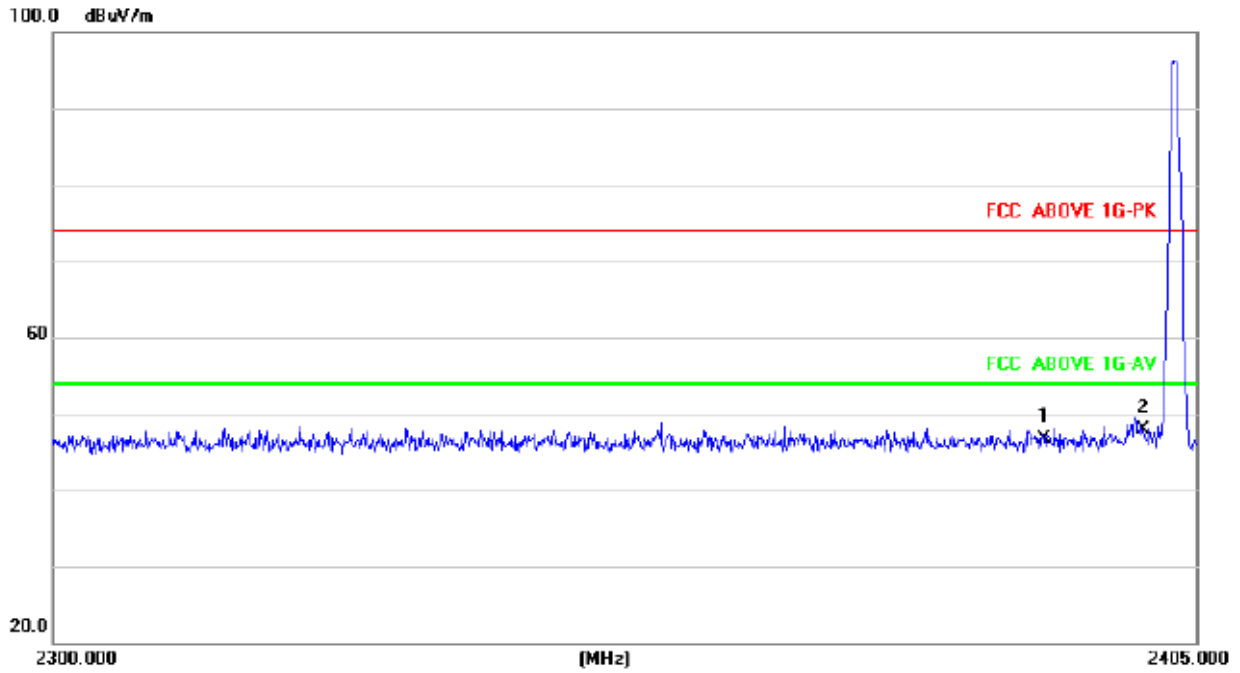

2402MHz Vertical

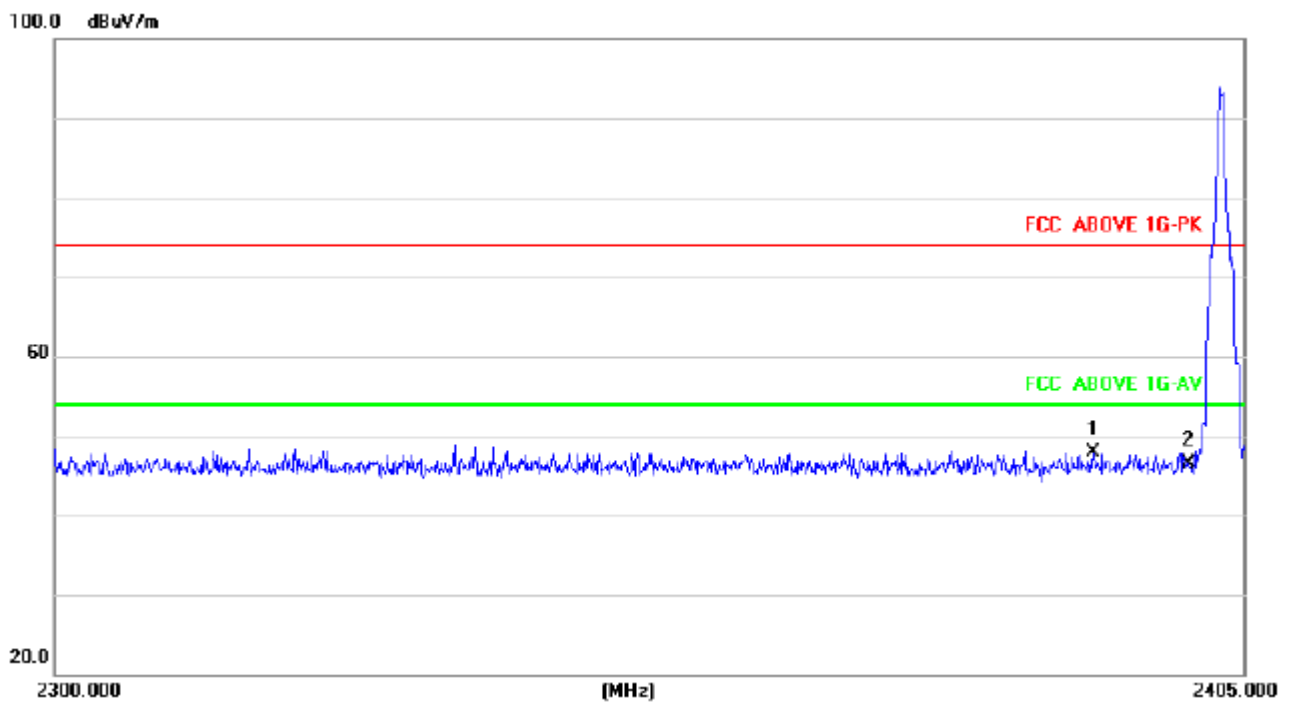



2480MHz Horizontal

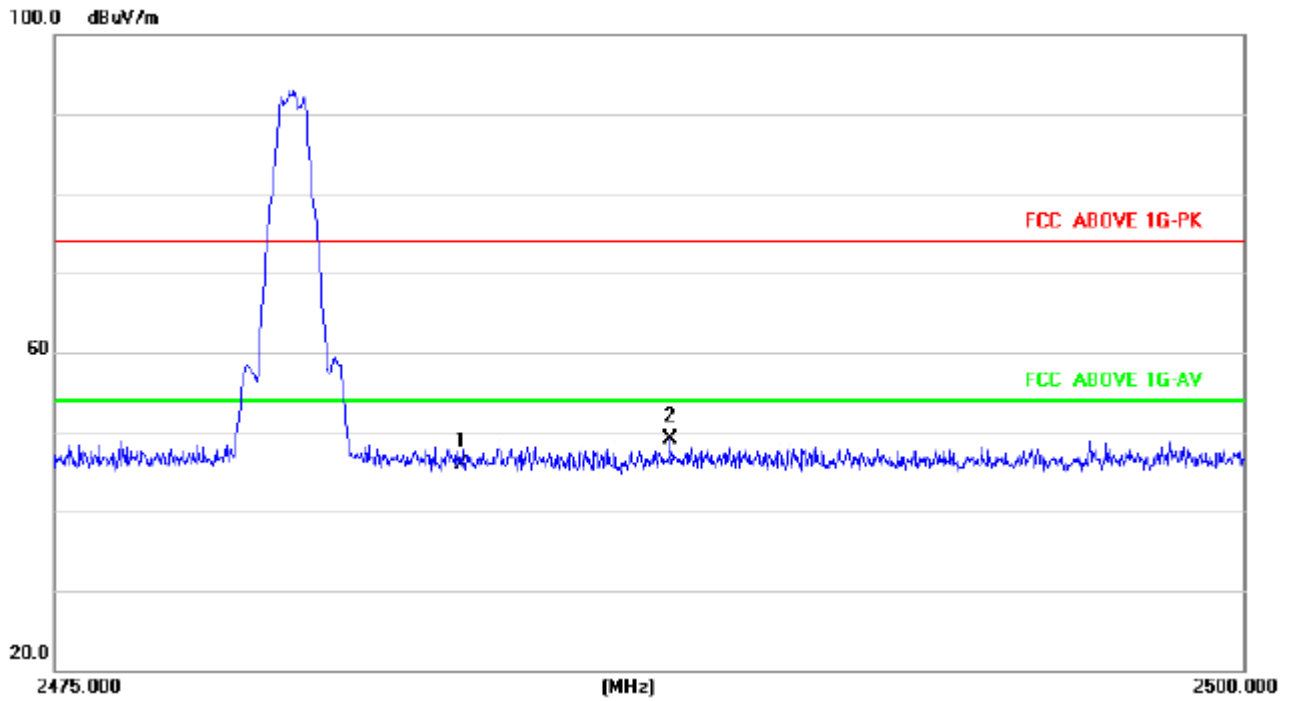

2480MHz Vertical

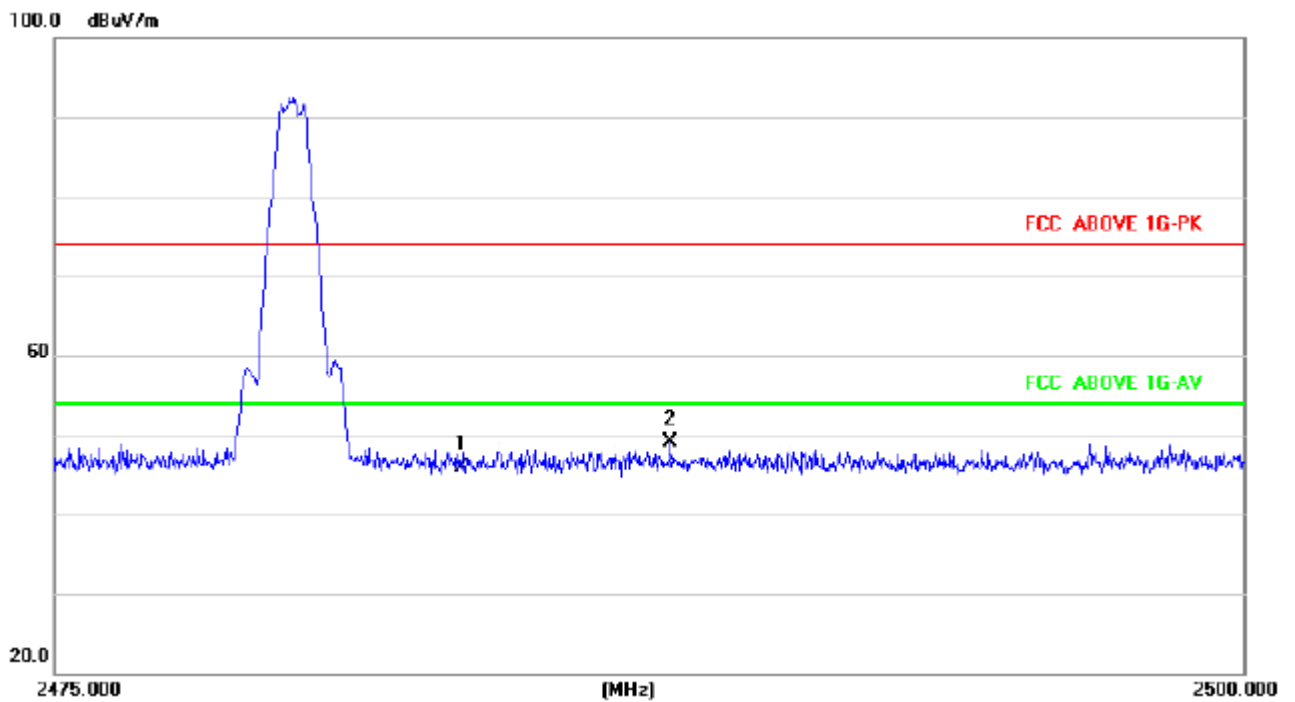



6. ANTENNA REQUIREMENT

6.1 STANDARD REQUIREMENT

15.203 requirement: For intentional device, according to 15.203: an intentional radiator shall be designed to ensure that no antenna other than that furnished by the responsible party shall be used with the device.

6.2 EUT ANTENNA

The EUT antenna is FPCB antenna. It complies with the standard requirement.



7. EUT TEST PHOTO

Radiated Measurement Photos





Conducted Measurement Photos





8. EUT PHOTO



***** END OF REPORT *****