

VOICE ASSISTANT BLUETOOTH SPEAKER

USER MANUAL

Model NO.: BTS-622B



Please kindly read this user manual before using the product carefully, and keep it for future reference.

In the box :

Bluetooth Speaker	x 1
Charging Cable	x 1
Aux cable	x 1
User Manual	x 1

Features:

Wireless Speaker supports Siri & Google Assistant Voice Commands

Just press the "Voice Assistant" button to start conversation with your Siri or Google Assistant

Connects to any Bluetooth enabled devices

Streams wireless music from your iPhone, iPad and other Android smartphones and tablets

Built-in microphone for hands-free calls

Description of Parts:

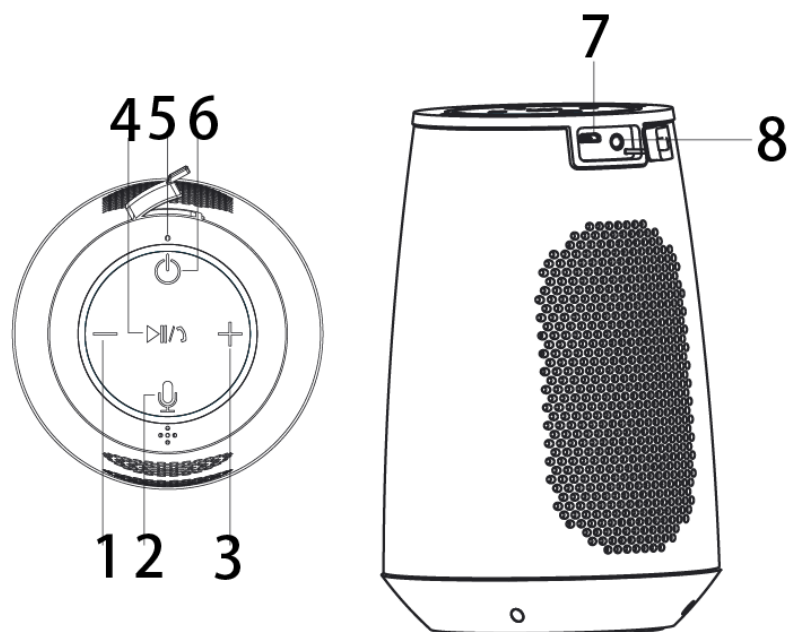

1	Previous Track / Volume Decrease
2	Voice assistant button
3	Next Track / Volume Increase
4	Phone/Play/Pause
5	Led indicator
6	Power ON/OFF
7	Charging Port
8	AUX in jack

Charging the speaker

To charge the Bluetooth speaker, connect the supplied micro USB cable to the USB charging port and the other end to your computer or USB charging device.

Make sure you charge your Bluetooth speaker fully for the first time.

Pairing speaker with bluetooth device





1. Turn on the Bluetooth speaker.
2. Turn on your Bluetooth enabled device and activate the Bluetooth function.
3. Search for the Bluetooth device, "BTS-622B" will show up.
4. If a PIN is required, enter the password '0000' to confirm to finalize pairing.
5. Connect it with your bluetooth enabled device.

Voice Assistant Operation

1. Make sure that Siri is activated; Make sure Google Assistant is downloaded and set to default Voice Assistant.
2. Make sure your mobile device is bluetooth paired.
3. Press the “  ” button once.
4. You should hear a beep tone, indicating Siri or Google Assistant is listening.
5. Say a command after beep, such as : “What the time now ”

Note: Google Assistant is available on eligible Android 5.0 devices or later. Works on Lollipop, Marshmallow and Nougat Android Phones with Google Play Services, >1.5GB of memory and 720P or higher screen resolution. Please ensure Google Assistant App is downloaded and made as default Voice Assistant on your mobile device.

Button functions

	Press and hold to turn ON the speaker; Press and hold to turn Off the speaker.
	Press button to pause a song while playing music, Press again to resume playing. When a call comes, press to answer a call; Press again to end a call; Press and hold to reject a call.
	Press and hold button to decrease the volume; Press shortly to previous track
	Press and hold button to increase the volume; Press shortly to next track
	Press the “Voice Assistant” button once. You should hear a beep tone, indicating Siri or Google Assistant is listening. Say a command after beep, such as : “What the time now

Specifications

Bluetooth® Version: 4.2
Working distance : Up to 10 meters in open space
Speaker output: 5W * 2
Power Input: DC 5V
Play time : about 3-4 hours
Charging Time: about 3 -4 hours
Built-In Rechargeable Battery : 3.7V / 1800mAh
Unit Size: 120*120*180 mm

(Note: Battery life & charging time may vary based on usage, types of devices connected & wireless distance.)

FCC Instructions

NOTE: This equipment has been tested and found to comply with the limits for a Class B digital device, pursuant to part 15 of the FCC Rules. These limits are designed to provide reasonable protection against harmful interference in a residential installation. This equipment generates uses and can radiate radio frequency energy and, if not installed and used in accordance with the instructions, may cause harmful interference to radio communications. However, there is no guarantee that interference will not occur in a particular installation. If this equipment does cause harmful interference to radio or television reception, which can be determined by turning the equipment off and on, the user is encouraged to try to correct the interference by one or more of the following measures:

- Reorient or relocate the receiving antenna.
- Increase the separation between the equipment and receiver.
- Connect the equipment into an outlet on a circuit different from that to which the receiver is connected.
- Consult the dealer or an experienced radio/TV technician for help

Changes or modifications not expressly approved by the party responsible for compliance

could void the user's authority to operate the equipment.

This device complies with Part 15 of the FCC Rules. Operation is subject to the following two conditions:

- (1) this device may not cause harmful interference, and
- (2) this device must accept any interference received, including interference that may cause undesired operation.