



# TEST REPORT

## FCC ID: R8HBTS-518B

For

Shenzhen Xihuamei Electronics Limited Company

Bluetooth Speaker

Model No. : BTS-518B

Trade Name : N/A

Prepared for : Shenzhen Xihuamei Electronics Limited Company  
Address : Bldg. 5, TaiFeng Industrial Park, NO.10. JianAn Road,shajing sub-district,  
: BaoAn District, Shenzhen, China

Prepared by : Shenzhen Alpha Product Testing Co., Ltd.  
Address : Building B, East Area of Nanchang Second, Industrial Zone,  
: Gushu 2nd Road, Bao'an, Shenzhen, China

Report No. : T1871081 01

Date of Receipt : June 25, 2017

Date of Test : June 25, 2017 – July 5, 2017

Date of Report : July 6 , 2017

Version Number : REV0

## Contents

<b>1. General Information</b> .....	<b>5</b>
1.1. Description of Device (EUT).....	5
1.2. Accessories of device (EUT).....	6
1.3. Test Lab information.....	6
<b>2. Summary of test</b> .....	<b>7</b>
2.1. Summary of test result.....	7
2.2. Assistant equipment used for test.....	7
2.3. Block Diagram.....	8
2.4. Test mode.....	8
2.5. Test Conditions.....	9
2.6. Measurement Uncertainty (95% confidence levels, k=2).....	9
2.7. Test Equipment.....	10
<b>3. Maximum Peak Output power</b> .....	<b>11</b>
3.1. Limit.....	11
3.2. Test Procedure.....	11
3.3. Test Setup.....	11
3.4. Test Result.....	11
<b>4. Bandwidth</b> .....	<b>12</b>
4.1. Limit.....	12
4.2. Test Procedure.....	12
4.3. Test Result.....	12
<b>5. Carrier Frequency Separation</b> .....	<b>18</b>
5.1. Limit.....	18
5.2. Test Procedure.....	18
5.3. Test Result.....	18
<b>6. Number Of Hopping Channel</b> .....	<b>21</b>
6.1. Limit.....	21
6.2. Test Procedure.....	21
6.3. Test Result.....	21
<b>7. Dwell Time</b> .....	<b>24</b>
7.1. Test limit.....	24
7.2. Test Procedure.....	24
7.3. Test Results.....	24
<b>8. Radiated emissions</b> .....	<b>31</b>
8.1. Limit.....	31
8.2. Block Diagram of Test setup.....	32
8.3. Test Procedure.....	33
8.4. Test Result.....	33
<b>9. Band Edge Compliance</b> .....	<b>45</b>
9.1. Block Diagram of Test Setup.....	45
9.2. Limit.....	45
9.3. Test Procedure.....	45
9.4. Test Result.....	45

<b>10. Power Line Conducted Emissions .....</b>	<b>64</b>
10.1. Block Diagram of Test Setup .....	64
10.2. Limit .....	64
10.3. Test Procedure .....	64
10.4. Test Result .....	65
<b>11. Antenna Requirements.....</b>	<b>67</b>
11.1. Limit .....	67
11.2. Result.....	67
<b>12. Test setup photo .....</b>	<b>68</b>
12.1. Photos of Radiated emission .....	68
12.2. Photos of Conducted Emission test.....	69
<b>13. Photos of EUT .....</b>	<b>70</b>

# DECLARATION

Applicant : Shenzhen Xihuamei Electronics Limited Company  
 Manufacturer : Shenzhen Xihuamei Electronics Limited Company  
 Product : Bluetooth Speaker

(A) Model No. : BTS-518B

(B) Trade Name : N/A

(C) Power supply : DC 3.7V from internal battery or DC 5V From DC port

Measurement Standard Used:

**FCC Rules and Regulations Part 15 Subpart C Section 15.247: 2016, ANSI C63.10:2013**

The device described above is tested by Shenzhen Alpha Product Testing Co., Ltd. to determine the maximum emission levels emanating from the device. The maximum emission levels are compared to the FCC Part 15 Subpart C limits both conducted and radiated emissions. The test results are contained in this test report and Shenzhen Alpha Product Testing Co., Ltd. is assumed of full responsibility for the accuracy and completeness of these tests.

After the test, our opinion is that EUT compliance with the requirement of the above standards.

This report applies to above tested sample only. This report shall not be reproduced in parts without written approval of Shenzhen Alpha Product Testing Co., Ltd.

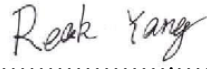
Tested by (name + signature).....: Reak Yang   
 Test Engineer .....

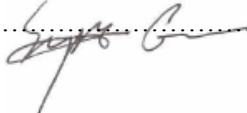
Approved by (name + signature).....: Simple Guan   
 Project Manager .....

Date of issue..... : July 6, 2017

## 1. General Information

### 1.1. Description of Device (EUT)

EUT	:	Bluetooth Speaker
Model No.	:	BTS-518B
Trade mark	:	N/A
Power supply	:	DC 3.7V from internal battery or DC 5V From DC port
Radio Technology	:	Bluetooth 3.0 +EDR
Operation frequency	:	2402-2480MHz
Modulation	:	GFSK, $\pi/4$ DQPSK, 8- DPSK
Antenna Type	:	PCB antenna max gain is 0dBi
Software version	:	N/A
Hardware version	:	N/A
Applicant	:	Shenzhen Xinquamei Electronics Limited Company
Address	:	Bldg. 5, TaiFeng Industrial Park, NO.10. JianAn Road,shajing sub-district, BaoAn District, Shenzhen, China
Manufacturer	:	Shenzhen Xinquamei Electronics Limited Company
Address	:	Bldg. 5, TaiFeng Industrial Park, NO.10. JianAn Road,shajing sub-district, BaoAn District, Shenzhen, China

## 1.2. Accessories of device (EUT)

Accessories : USB charging cable

Type : N/A

## 1.3. Test Lab information

Shenzhen Alpha Product Testing Co., Ltd.

Building B, East Area of Nanchang Second Industrial Zone,  
Gushu 2nd Road, Bao'an District, Shenzhen 518126, P.R. China

FCC Registered No.: 203110

## 2. Summary of test

### 2.1. Summary of test result

Description of Test Item	Standard	Results
Maximum Peak Output Power	FCC Part 15: 15.247(b)(1) ANSI C63.10 :2013	PASS
Bandwidth	FCC Part 15: 15.215 ANSI C63.10 :2013	PASS
Carrier Frequency Separation	FCC Part 15: 15.247(a)(1) ANSI C63.10 :2013	PASS
Number Of Hopping Channel	FCC Part 15: 15.247(a)(1)(iii) ANSI C63.10 :2013	PASS
Dwell Time	FCC Part 15: 15.247(a)(1)(iii) ANSI C63.10 :2013	PASS
Radiated Emission	FCC Part 15: 15.209 FCC Part 15: 15.247(d) ANSI C63.10 :2013	PASS
Band Edge Compliance	FCC Part 15: 15.247(d) ANSI C63.10 :2013	PASS
Power Line Conducted Emissions	FCC Part 15: 15.207 ANSI C63.10 :2013	PASS
Antenna requirement	FCC Part 15: 15.203	PASS
Note: Test with the test procedure Blue tool.		

### 2.2. Assistant equipment used for test

Description	:	Notebook PC
Manufacturer	:	ACER
Model No.	:	ZQT
NOTE: FCC DOC approved.		

### 2.3. Block Diagram

1, For radiated emissions test: EUT was placed on a turn table, which is 0.8 meter high above ground for below 1GHz, 1.5 meter high above ground for above 1GHz. EUT was be set into BT test mode by software before test.



2, For Power Line Conducted Emissions Test

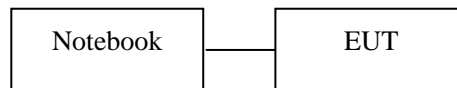

### 2.4. Test mode

The test software was used to control EUT work in Continuous TX mode, and select test channel, wireless mode.

Tested mode, channel, and data rate information		
Mode	Channel	Frequency (MHz)
GFSK	Low :CH1	2402
	Middle: CH40	2441
	High: CH79	2480

Tested mode, channel, and data rate information		
Mode	Channel	Frequency (MHz)
$\pi/4$ DQPSK	Low :CH1	2402
	Middle: CH40	2441
	High: CH79	2480

Tested mode, channel, and data rate information		
Mode	Channel	Frequency (MHz)
8- DPSK	Low :CH1	2402
	Middle: CH40	2441
	High: CH79	2480



## 2.5. Test Conditions

Temperature range	21-25°C
Humidity range	40-75%
Pressure range	86-106kPa

## 2.6. Measurement Uncertainty (95% confidence levels, k=2)

Item	MU	Remark
Uncertainty for Power point Conducted Emissions Test	2.71dB	
Uncertainty for Radiation Emission test in 3m chamber (below 30MHz)	2.13 dB	Polarize: V
	2.57dB	Polarize: H
Uncertainty for Radiation Emission test in 3m chamber (30MHz to 1GHz)	3.90dB	Polarize: V
	3.92dB	Polarize: H
Uncertainty for Radiation Emission test in 3m chamber (1GHz to 25GHz)	4.28dB	Polarize: H
	4.26dB	Polarize: V
Uncertainty for radio frequency	$1 \times 10^{-9}$	
Uncertainty for conducted RF Power	0.16dB	
Uncertainty for temperature	0.2°C	
Uncertainty for humidity	1%	
Uncertainty for DC and low frequency voltages	0.06%	

## 2.7. Test Equipment

Equipment	Manufacture	Model No.	Serial No.	Due cal.	Cal Interval
3m Semi-Anechoic	CHENYU	N/A	N/A	2020.07.20	4Year
Spectrum analyzer	Agilent	E4407B	MY46185649	2017.09.28	1Year
Receiver	R&S	ESPI	101873	2017.09.28	1Year
Receiver	R&S	ESCI	101165	2017.09.28	1Year
Bilog Antenna	SCHWARZBECK	VULB 9168	VULB9168-438	2018.09.29	2Year
Horn Antenna	SCHWARZBECK	BBHA 9120 D	BBHA 9120 D(1201)	2018.09.29	2Year
L.I.S.N.#1	Schwarzbeck	NSLK8126	8126466	2017.09.28	1 Year
L.I.S.N.#2	ROHDE&SCHWARZ	ENV216	101043	2017.09.28	1 Year
Cable	Resenberger	N/A	No.1	2017.09.28	1Year
Cable	SCHWARZBECK	N/A	No.2	2017.09.28	1Year
Cable	SCHWARZBECK	N/A	No.3	2017.09.28	1Year
Pre-amplifier	HP	HP8347A	2834A00455	2017.09.28	1Year
Pre-amplifier	Agilent	8449B	3008A02664	2017.09.28	1Year
vector Signal Generator	Agilent	N5182A	MY49060042	2017.09.28	1 Year
vector Signal Generator	Agilent	E4438C	US44271917	2017.09.28	1 Year
X-series USB Peak and Average Power Sensor	Agilent	U2021XA	MY54080020	2017.09.28	1 Year
X-series USB Peak and Average Power Sensor	Agilent	U2021XA	MY54110001	2017.09.28	1 Year
Signal Analyzer	Agilent	N9020A	MY48030494	2017.09.28	1 Year

### 3. Maximum Peak Output power

#### 3.1. Limit

Please refer section 15.247.

For frequency hopping systems operating in the 2400-2483.5 MHz band employing at least 75 non-overlapping hopping channels, and all frequency hopping systems in the 5725-5850 MHz band: 1 watt. For all other frequency hopping systems in the 2400-2483.5 MHz band: 0.125 watts, the e.i.r.p shall not exceed 4W

#### 3.2. Test Procedure

The transmitter output is connected to the RF Power Meter. The RF Power Meter is set to the peak power detection.

#### 3.3. Test Setup

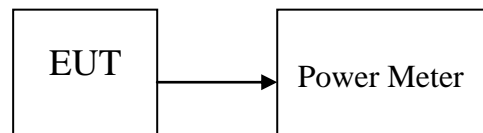

#### 3.4. Test Result

EUT: Bluetooth Speaker		M/N: BTS-518B			
Test date: 2017-7-5		Test site: RF site		Tested by: Reak	
Mode	Freq (MHz)	PK Output Power (dBm)	PK Output Power (mW)	Limit (dBm)	Margin (dB)
GFSK	2402	-3.76	0.421	21	24.760
	2441	-4.58	0.348	21	25.580
	2480	-6.02	0.250	21	27.020
$\pi/4$ DQPSK,	2402	-3.72	0.425	21	24.720
	2441	-4.57	0.349	21	25.570
	2480	-6.01	0.251	21	27.010
8- DPSK	2402	-3.70	0.427	21	24.700
	2441	-4.56	0.350	21	25.560
	2480	-6.00	0.251	21	27.000

Conclusion: PASS

## 4. Bandwidth

### 4.1. Limit

Intentional radiators operating under the alternative provisions to the general emission limits, as contained in §§ 15.217 through 15.257 and in Subpart E of this part, must be designed to ensure that the 20 dB bandwidth of the emission, or whatever bandwidth may otherwise be specified in the specific rule section under which the equipment operates, is contained within the frequency band designated in the rule section under which the equipment is operated.

### 4.2. Test Procedure

The transmitter output was coupled to a spectrum analyzer via a antenna. The bandwidth of the fundamental frequency was measured by spectrum analyzer with 30kHz RBW and 100kHz VBW. The 20dB bandwidth is defined as the total spectrum the power of which is higher than peak power minus 20dB.

### 4.3. Test Result

EUT: Bluetooth Speaker		M/N: BTS-518B		
Test date: 2017-7-5		Test site: RF site	Tested by: Reak	
Mode	Freq (MHz)	20dB Bandwidth (KHz)	Limit (kHz)	Conclusion
GFSK	2402	1046	/	PASS
	2441	1046	/	PASS
	2480	1045	/	PASS
$\pi$ /4 DQPSK	2402	1044	/	PASS
	2441	1040	/	PASS
	2480	1036	/	PASS
8- DPSK	2402	1046	/	PASS
	2441	1045	/	PASS
	2480	1044	/	PASS

Original Test data For 20dB bandwidth  
GFSK:

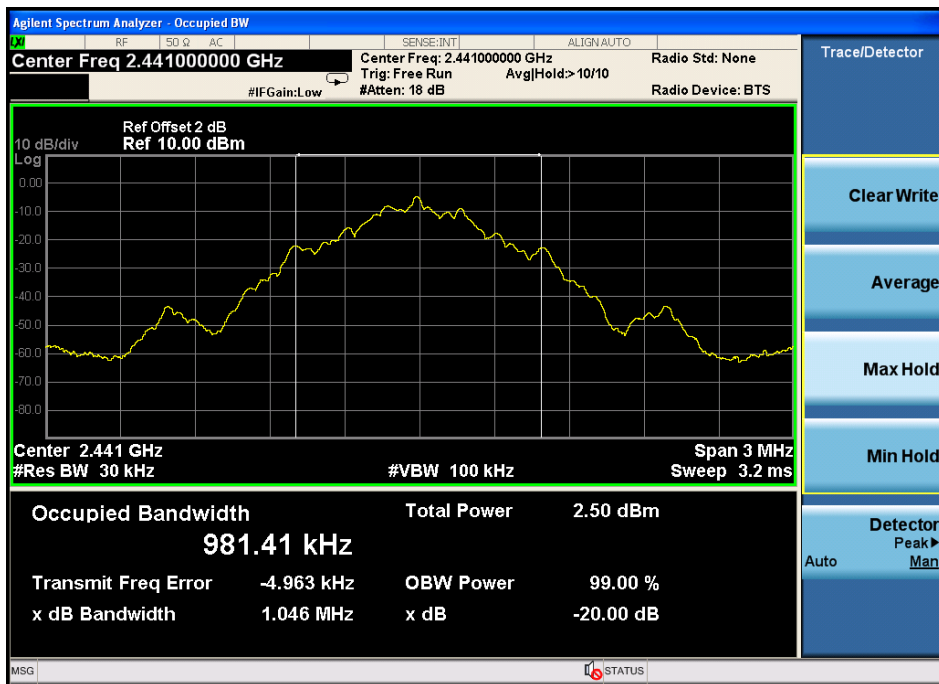
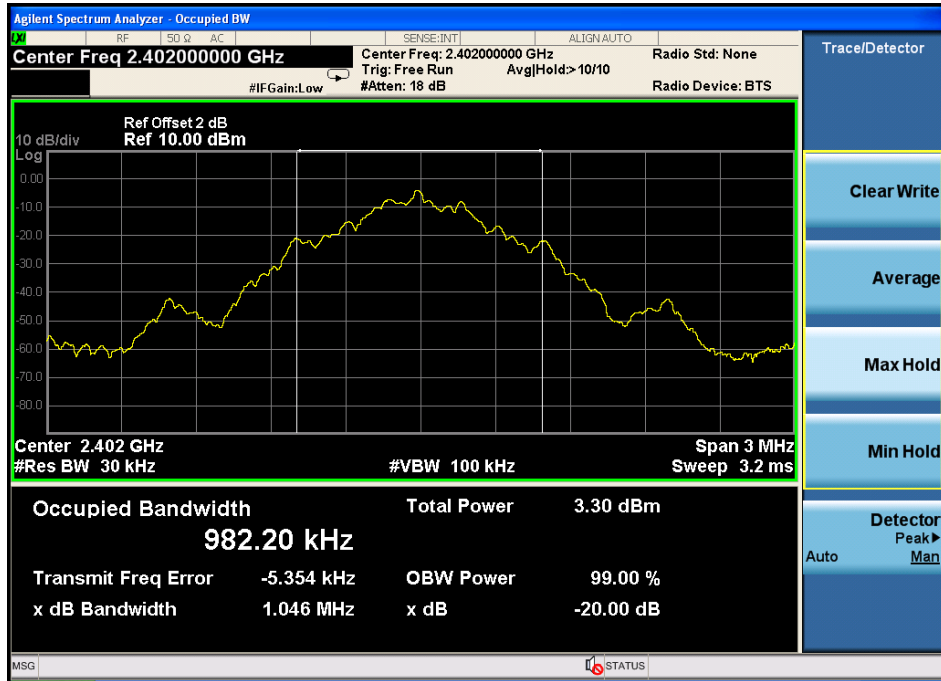



$\pi/4$  DQPSK:

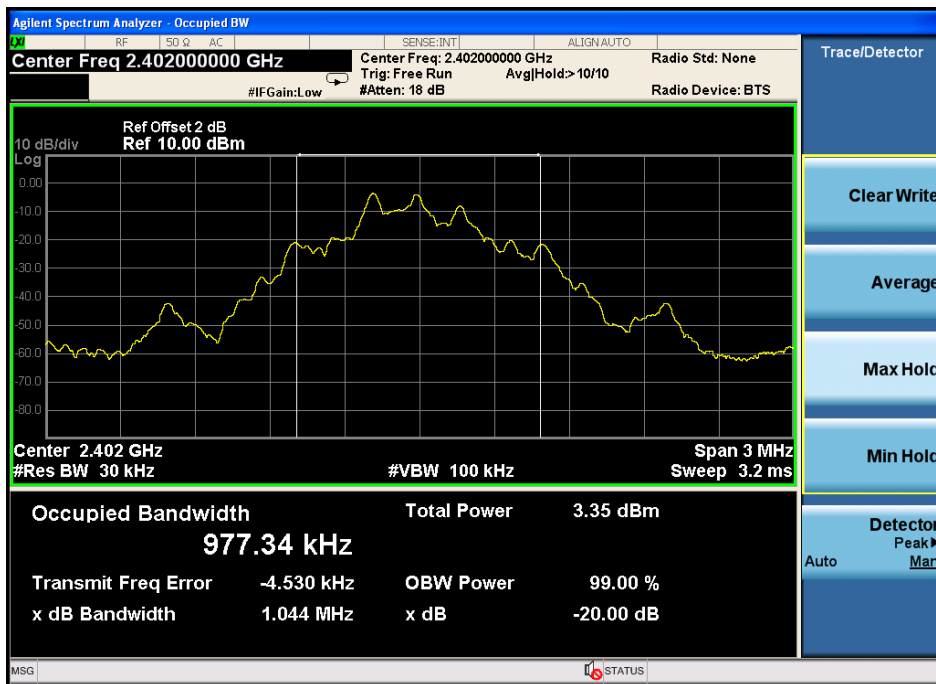



8- DPSK:

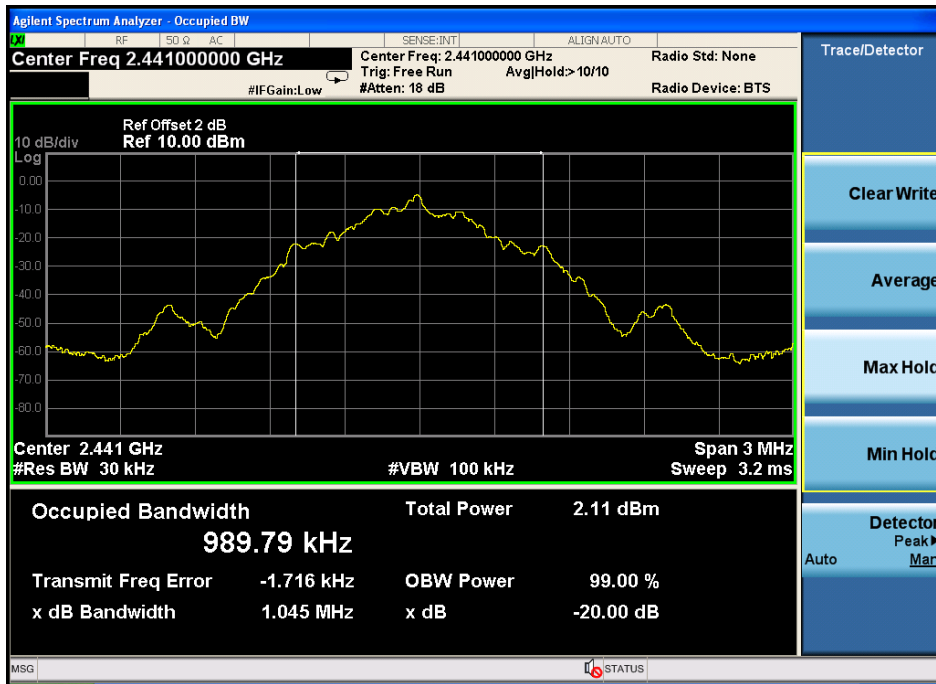
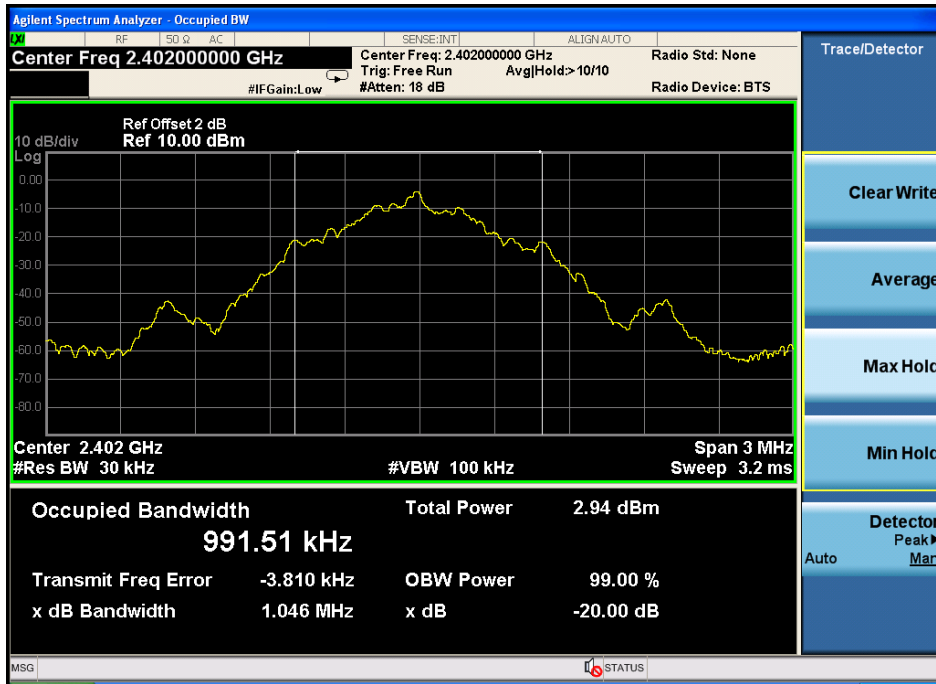



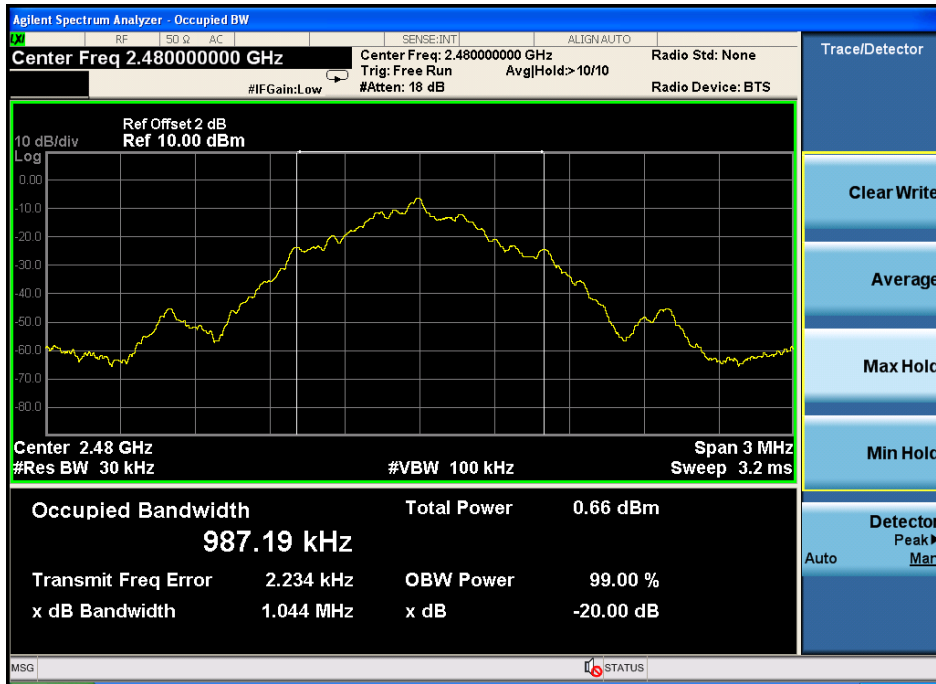

## 5. Carrier Frequency Separation

### 5.1. Limit

Frequency hopping systems shall have hopping channel carrier frequencies separated by a minimum of 25 kHz or the 20 dB bandwidth of the hopping channel, whichever is greater. Alternatively, frequency hopping systems operating in the 2400-2483.5 MHz band may have hopping channel carrier frequencies that are separated by 25 kHz or two-thirds of the 20 dB bandwidth of the hopping channel, whichever is greater, provided the systems operate with an output power no greater than 125 mW

### 5.2. Test Procedure

The transmitter output was coupled to a spectrum analyzer via a antenna. The carrier frequency was measured by spectrum analyzer with 100kHz RBW and 300kHz VBW.

### 5.3. Test Result

EUT: Bluetooth Speaker M/N: BTS-518B				
Test date: 2017-7-5		Test site: RF site		Tested by: Reak
Mode/Channel	Channel separation (KHz)	20dB Bandwidth (KHz)	Limit (KHz) 2/3 20dB bandwidth	Conclusion
GFSK	999	1046	697.333	PASS
$\pi$ /4 DQPSK	1017	1044	696.000	PASS
8- DPSK	999	1046	697.333	PASS

Original test data for channel separation  
GFSK

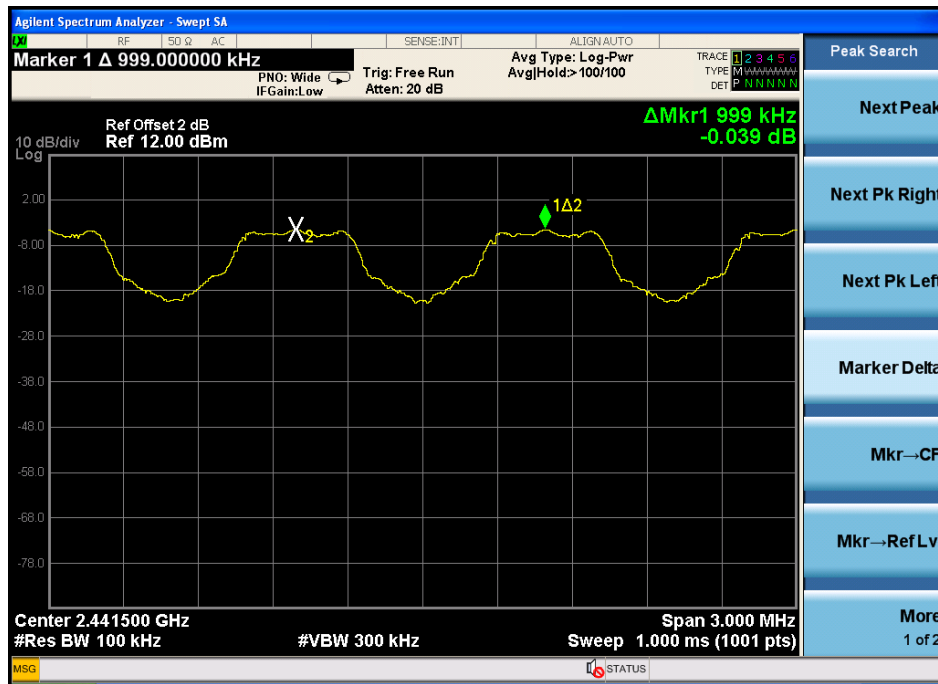

$\pi/4$  DQPSK

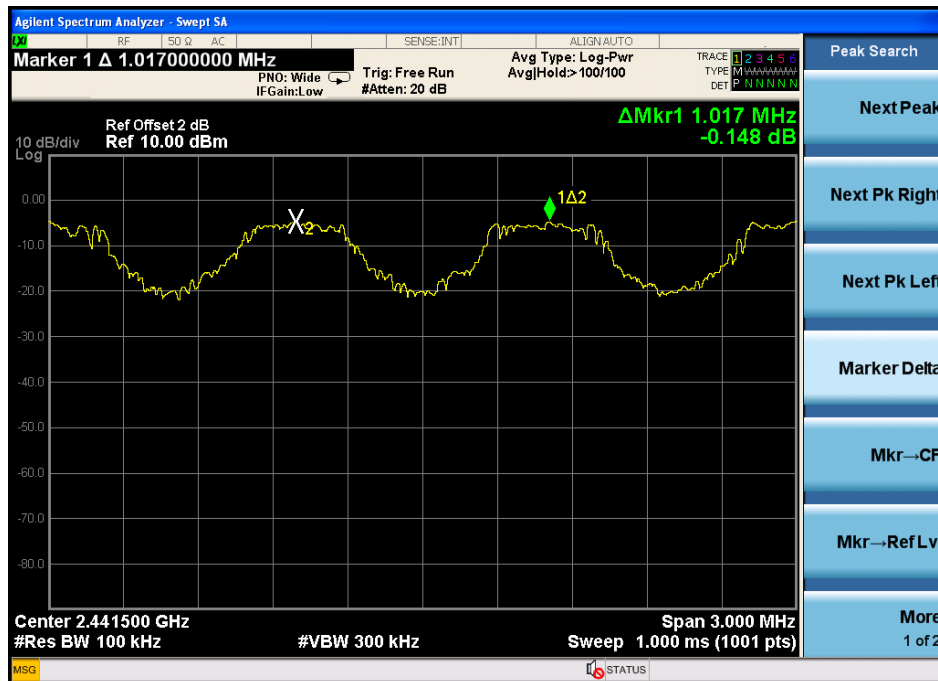

8- DPSK:

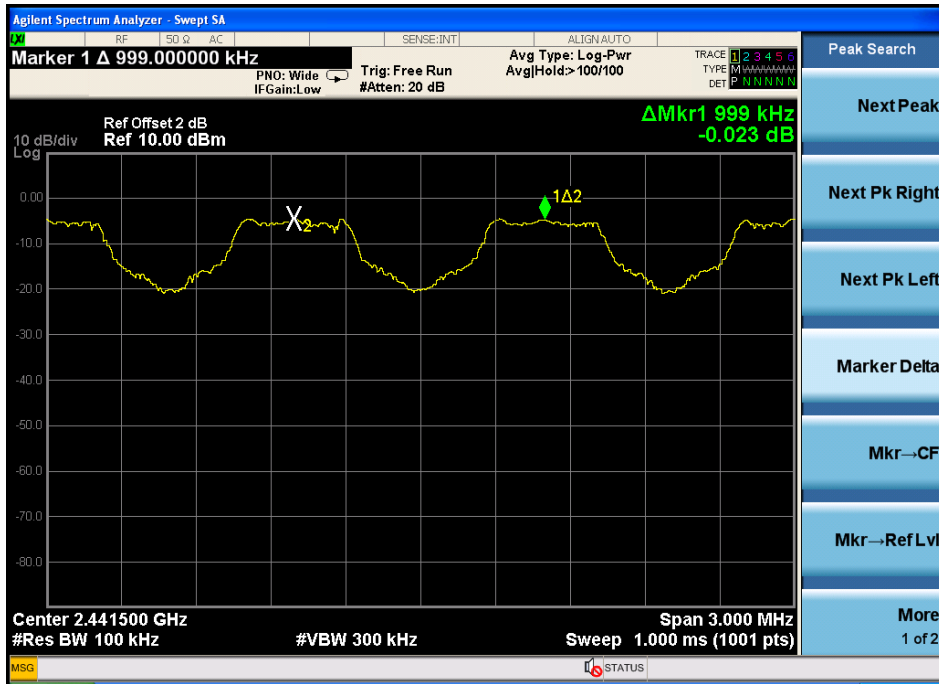

## 6. Number Of Hopping Channel

### 6.1. Limit

Frequency hopping systems in the 2400-2483.5 MHz band shall use at least 15 channels

### 6.2. Test Procedure

The transmitter output was coupled to a spectrum analyzer via a antenna. The number of hopping channel was measured by spectrum analyzer with 100kHz RBW and 300KHz VBW.

### 6.3. Test Result

EUT: Bluetooth Speaker M/N: BTS-518B			
Test date: 2017-7-4		Test site: RF site	Tested by: Reak
Mode	Number of hopping channel	Limit	Conclusion
GFSK	79	>15	PASS
$\pi$ /4 DQPSK	79	>15	PASS
8- DPSK	79	>15	PASS

Original test data for hopping channel number  
GFSK

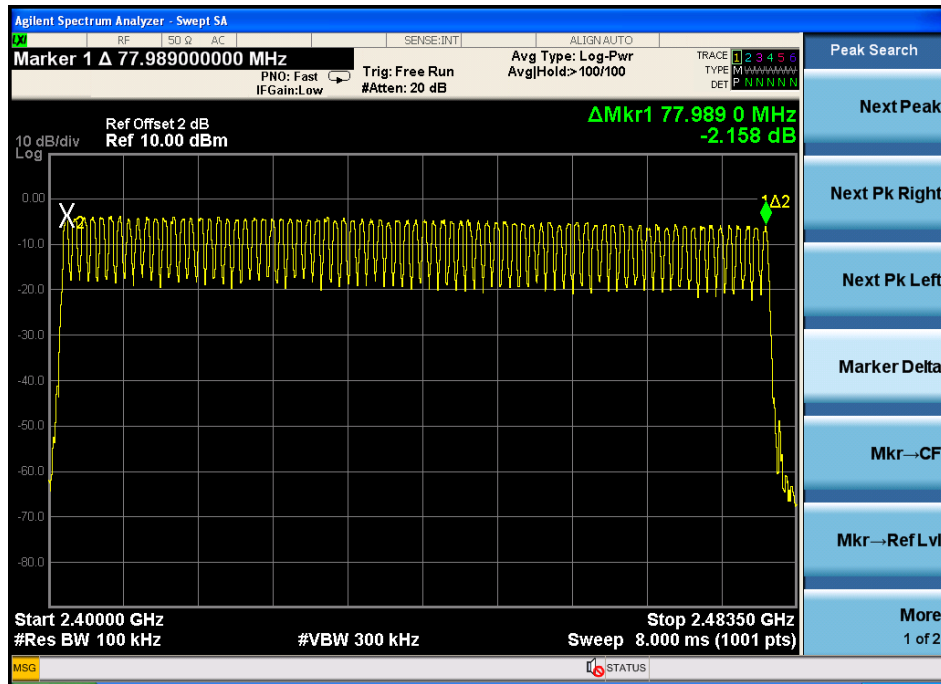

$\pi/4$  DQPSK

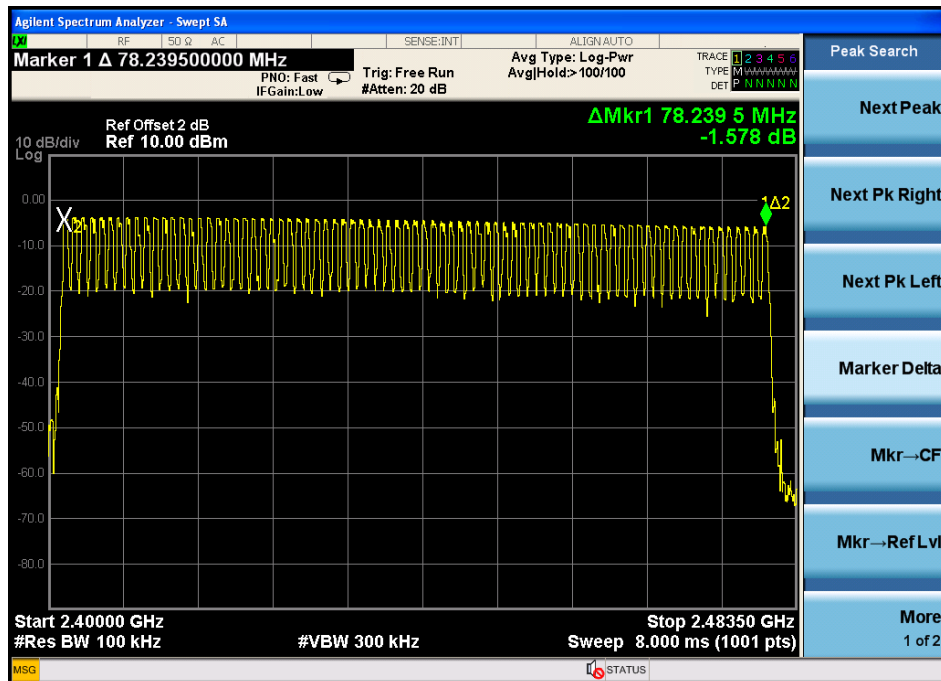

8- DPSK:

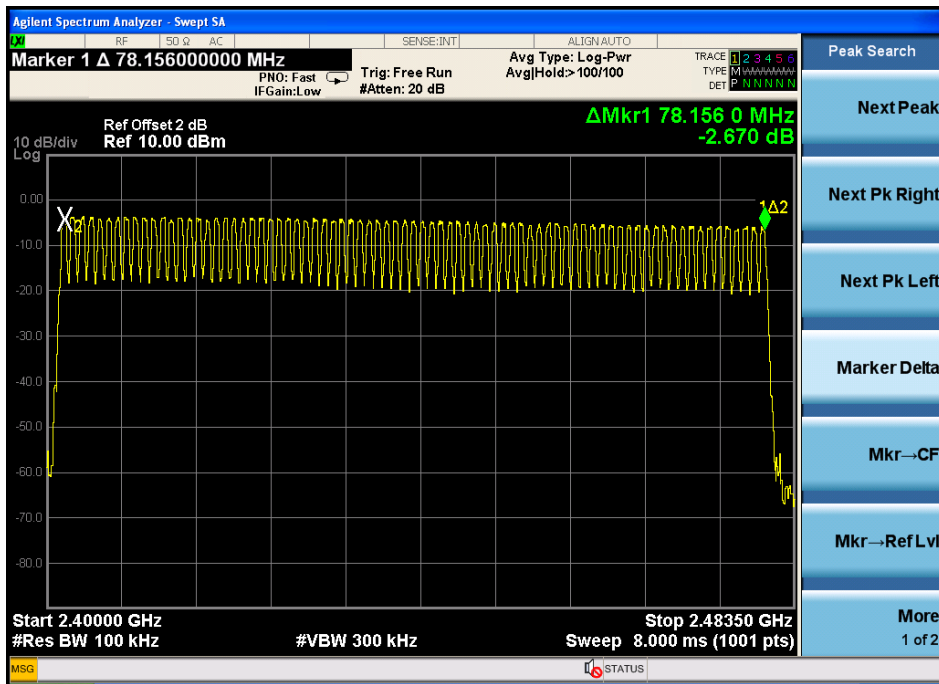

## 7. Dwell Time

### 7.1. Test limit

Please refer section 15.247

According to §15.247(a)(1)(iii), Frequency hopping systems operating in the 2400MHz-2483.5 MHz. The average time of occupancy on any frequency shall not greater than 0.4 s within period of 0.4 seconds multiplied by the number of hopping channel employed.

### 7.2. Test Procedure

7.2.1. Place the EUT on the table and set it in transmitting mode.

7.2.2. Remove the antenna from the EUT and then connect a low loss RF cable from the antenna port to the spectrum analyzer.

7.2.3. Set center frequency of spectrum analyzer = operating frequency.

7.2.4. Set the spectrum analyzer as RBW, VBW=1MHz, Span = 0Hz, Sweep = auto.

7.2.5. Repeat above procedures until all frequency measured were complete.

### 7.3. Test Results

PASS.

Detailed information please see the following page.



EUT: Bluetooth Speaker M/N: BTS-518B						
Test date: 2017-7-4		Test site: RF site		Tested by: Reak		
Mode	Data Packet	Frequency (MHz)	Pulse Duration (ms)	Dwell Time (s)	Limit (s)	Conclusion
GFSK	DH1	2441	0.390	0.250	<0.4	PASS
	DH3	2441	1.659	0.354	<0.4	PASS
	DH5	2441	2.913	0.373	<0.4	PASS
$\pi$ /4 DQPSK	DH1	2441	0.406	0.260	<0.4	PASS
	DH3	2441	1.643	0.351	<0.4	PASS
	DH5	2441	2.913	0.373	<0.4	PASS
8- DPSK	DH1	2441	0.406	0.260	<0.4	PASS
	DH3	2441	1.643	0.351	<0.4	PASS
	DH5	2441	2.913	0.373	<0.4	PASS

Note: 1 A period time = 0.4 (s) \* 79 = 31.6(s)  
 2 DH1 time slot = Pulse Duration \* (1600/(1\*79)) \* A period time/1000  
 DH3 time slot = Pulse Duration \* (1600/(3\*79)) \* A period time/1000  
 DH5 time slot = Pulse Duration \* (1600/(5\*79)) \* A period time/1000

GFSK

DH1:

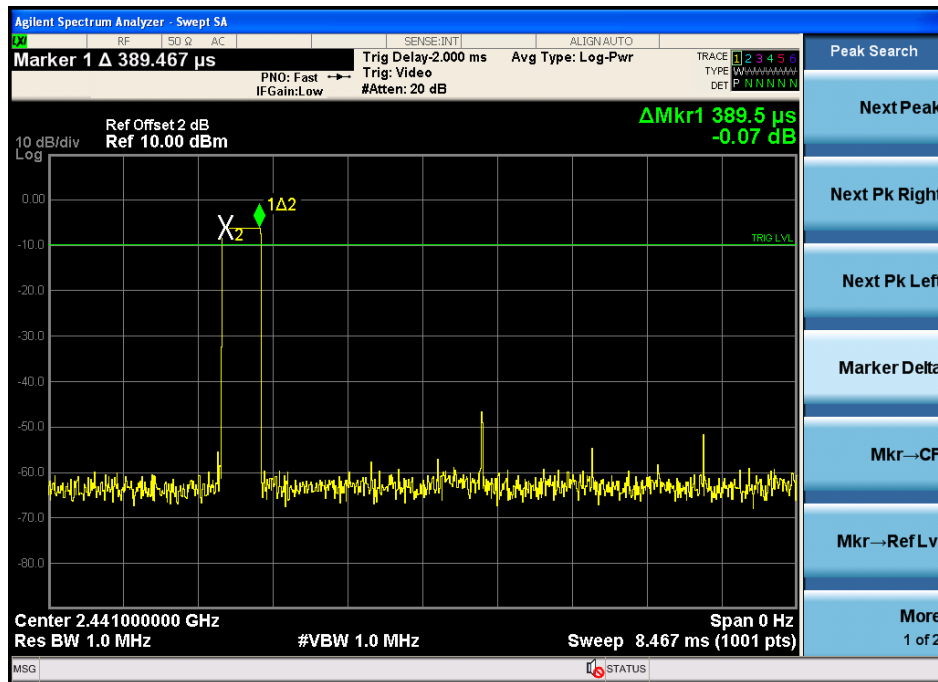

DH3:

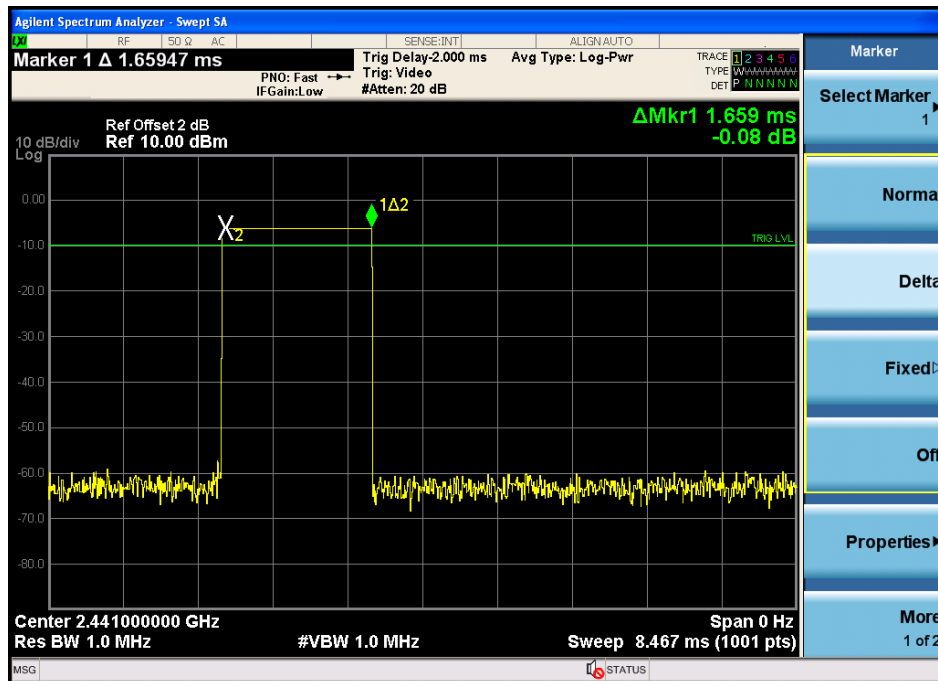

### DH5

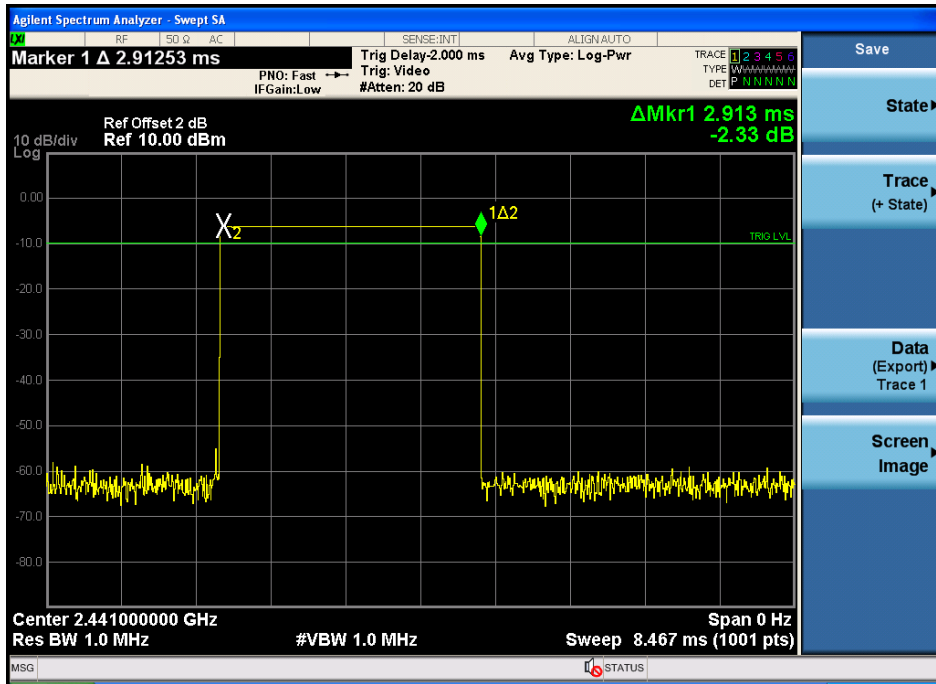

### $\pi/4$ DQPSK DH1

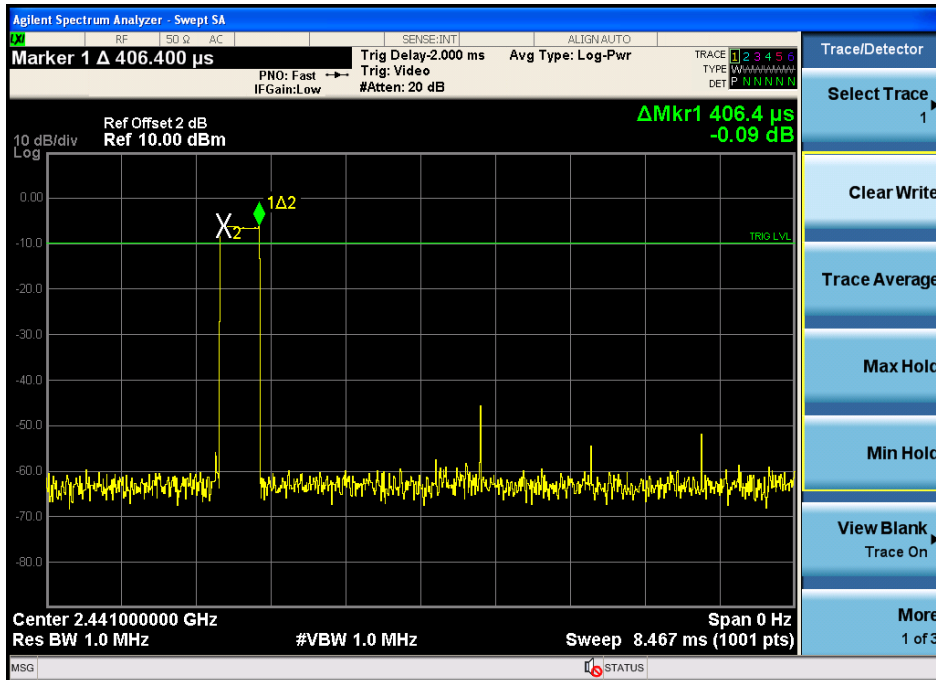

DH3

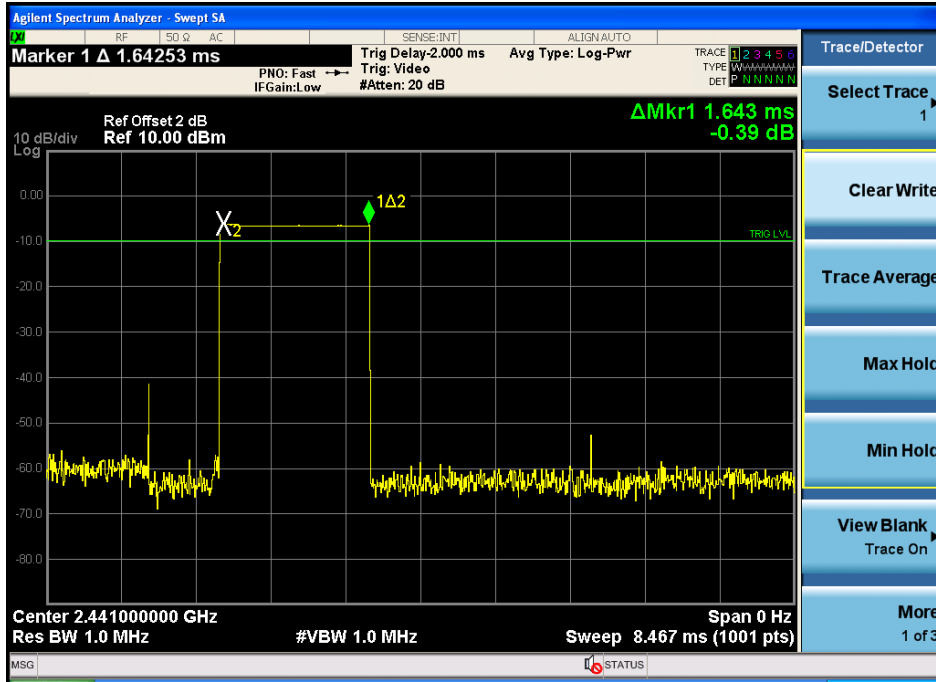

DH5

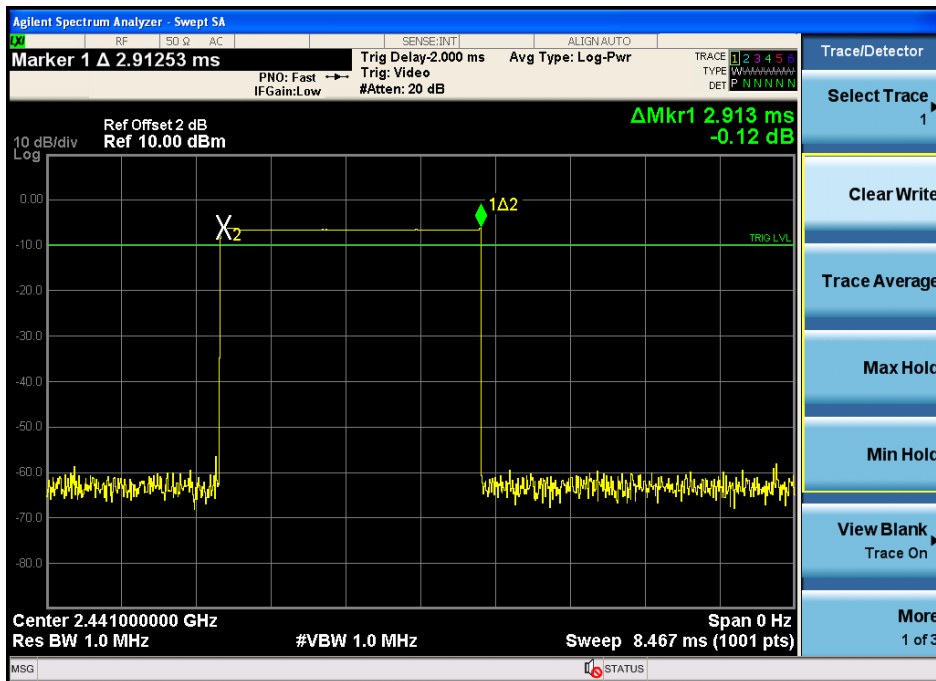

8- DPSK:  
DH1:

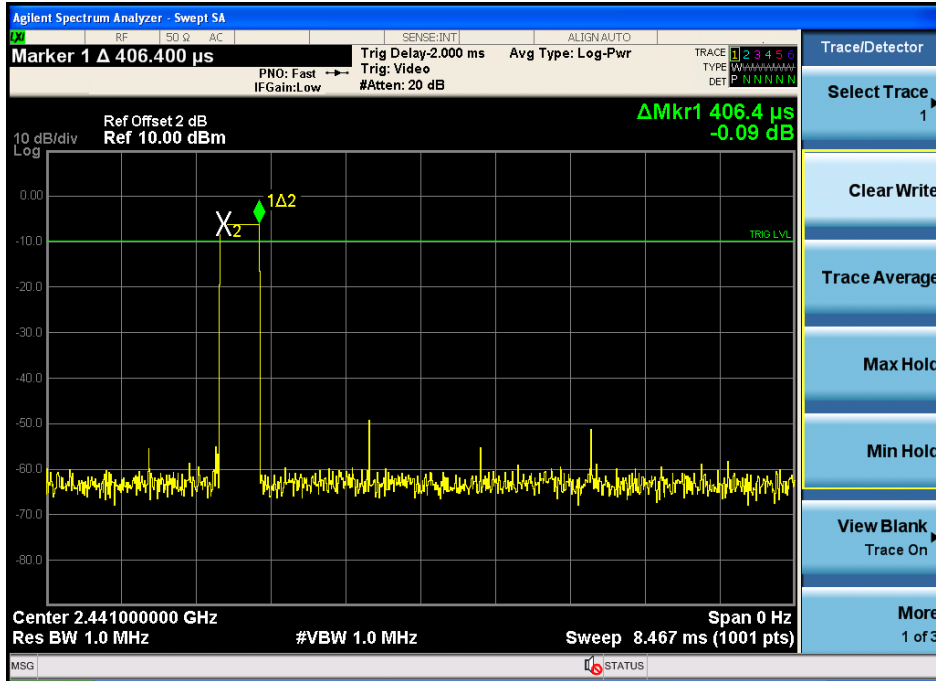

DH3:

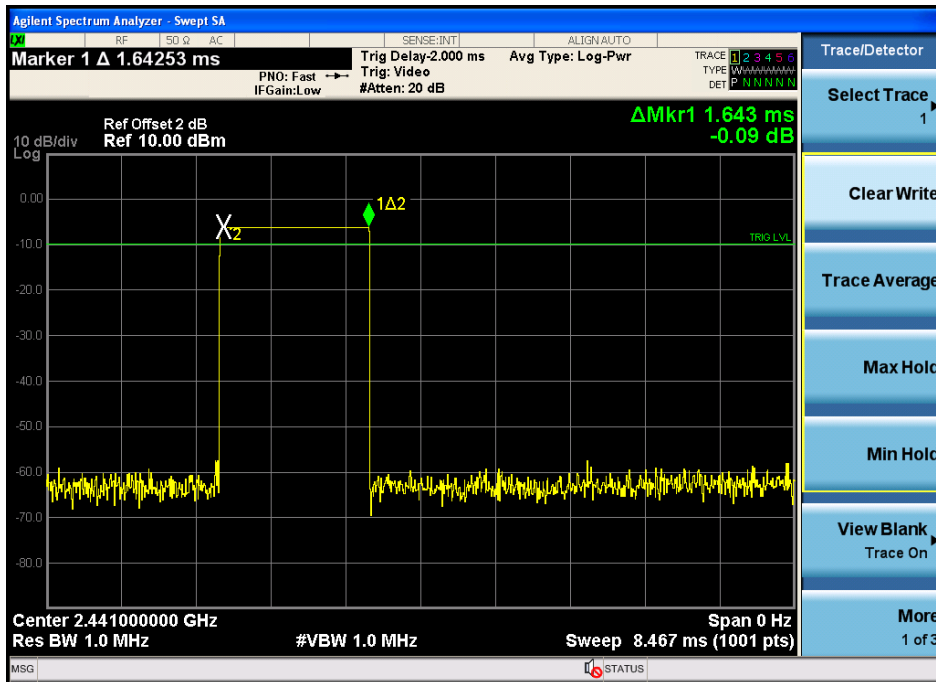

DH5:

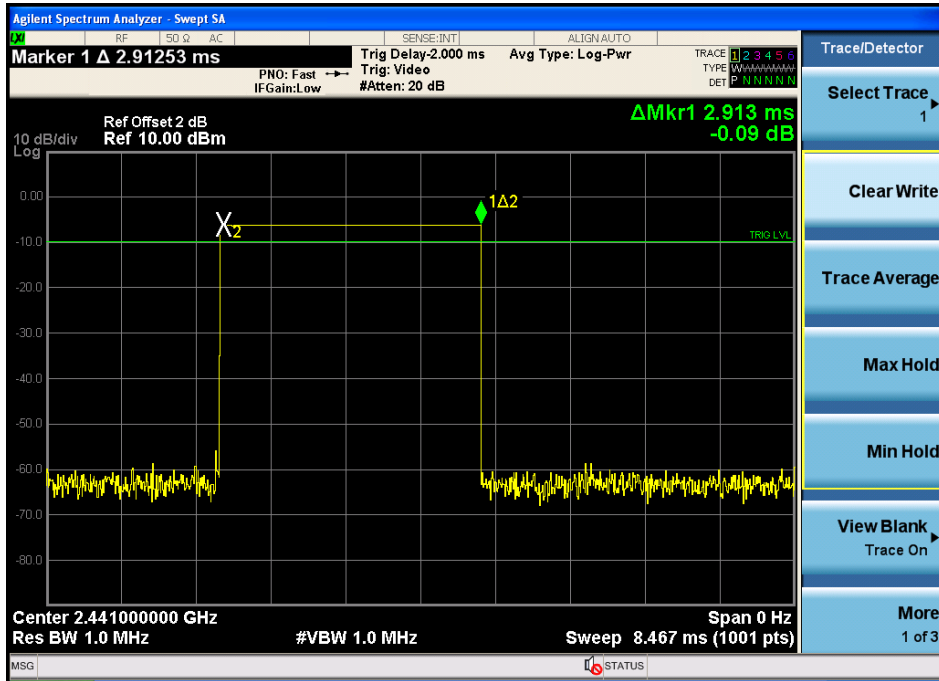

## 8. Radiated emissions

### 8.1. Limit

All the emissions appearing within 15.205 restricted frequency bands shall not exceed the limits shown in 15.209, all the other emissions shall be at least 20dB below the fundamental emissions, or comply with 15.209 limits.

#### 15.205 Restricted frequency band

MHz	MHz	MHz	GHz
0.090 - 0.110	16.42 - 16.423	399.9 - 410	4.5 - 5.15
<sup>1</sup> 0.495 - 0.505	16.69475 - 16.69525	608 - 614	5.35 - 5.46
2.1735 - 2.1905	16.80425 - 16.80475	960 - 1240	7.25 - 7.75
4.125 - 4.128	25.5 - 25.67	1300 - 1427	8.025 - 8.5
4.17725 - 4.17775	37.5 - 38.25	1435 - 1626.5	9.0 - 9.2
4.20725 - 4.20775	73 - 74.6	1645.5 - 1646.5	9.3 - 9.5
6.215 - 6.218	74.8 - 75.2	1660 - 1710	10.6 - 12.7
6.26775 - 6.26825	108 - 121.94	1718.8 - 1722.2	13.25 - 13.4
6.31175 - 6.31225	123 - 138	2200 - 2300	14.47 - 14.5
8.291 - 8.294	149.9 - 150.05	2310 - 2390	15.35 - 16.2
8.362 - 8.366	156.52475 - 156.52525	2483.5 - 2500	17.7 - 21.4
8.37625 - 8.38675	156.7 - 156.9	2690 - 2900	22.01 - 23.12
8.41425 - 8.41475	162.0125 - 167.17	3260 - 3267	23.6 - 24.0
12.29 - 12.293	167.72 - 173.2	3332 - 3339	31.2 - 31.8
12.51975 - 12.52025	240 - 285	3345.8 - 3358	36.43 - 36.5
12.57675 - 12.57725	322 - 335.4	3600 - 4400	( <sup>2</sup> )

#### 15.209 Limit

FREQUENCY MHz	DISTANCE Meters	FIELD STRENGTHS LIMIT	
		$\mu\text{V}/\text{m}$	$\text{dB}(\mu\text{V})/\text{m}$
0.009-0.490	300	2400/F(KHz)	/
0.490-1.705	30	24000/F(KHz)	/
1.705-30	30	30	29.5
30 ~ 88	3	100	40.0
88 ~ 216	3	150	43.5
216 ~ 960	3	200	46.0
960 ~ 1000	3	500	54.0
Above 1000	3	74.0 dB( $\mu\text{V}$ )/m (Peak) 54.0 dB( $\mu\text{V}$ )/m (Average)	

## 8.2. Block Diagram of Test setup

### 8.2.1 In 3m Anechoic Chamber Test Setup Diagram for below 1GHz

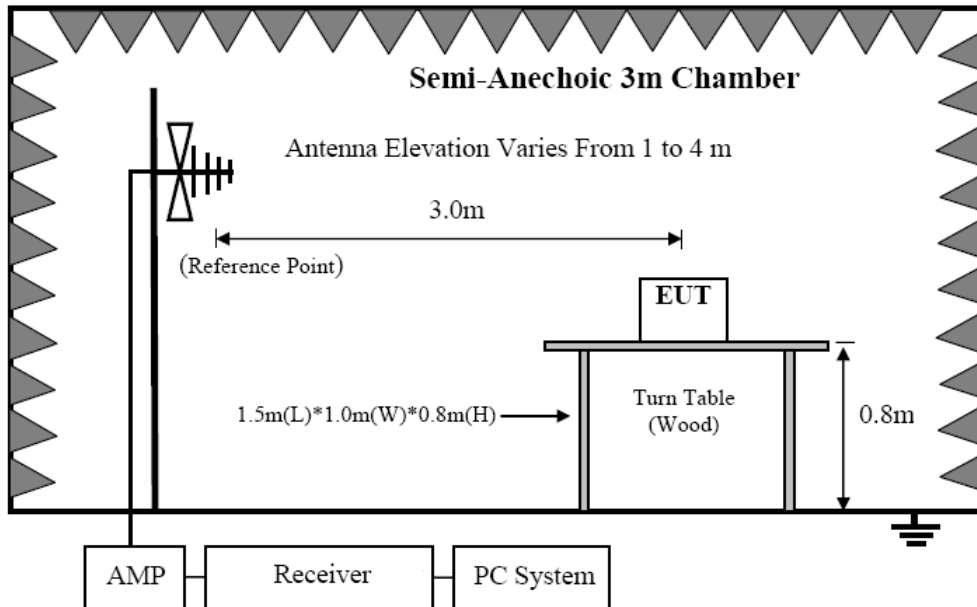

### 8.2.2 In 3m Anechoic Chamber Test Setup Diagram for frequency above 1GHz

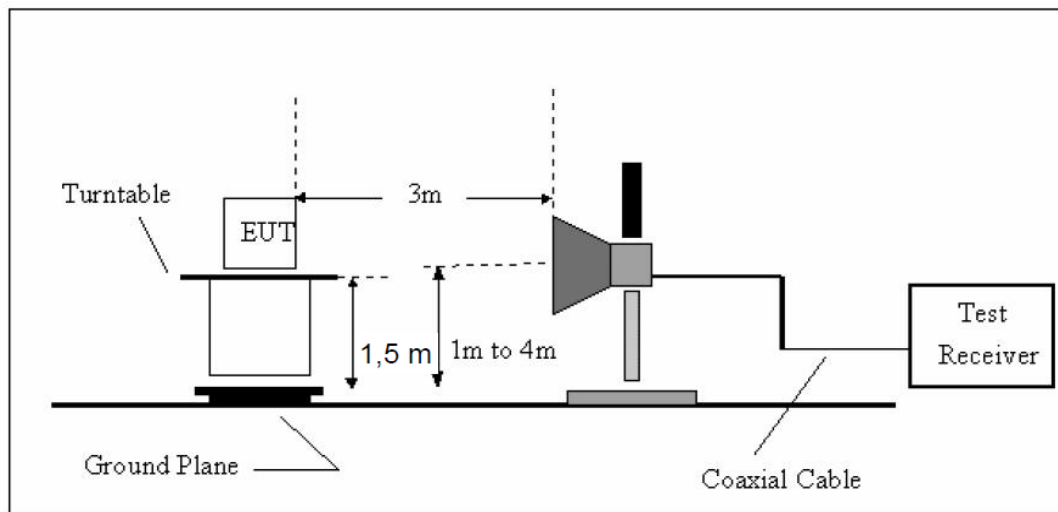

Note: For harmonic emissions test a appropriate high pass filter was inserted in the input port of AMP.



### 8.3. Test Procedure

- (1) EUT was placed on a non-metallic table, 80 cm above the ground plane inside a semi-anechoic chamber.
- (2) Setup EUT and simulator as shown in section 1.4 and 6.1
- (3) Test antenna was located 3m from the EUT on an adjustable mast. Below pre-scan procedure was first performed in order to find prominent radiated emissions.
  - (a) Change work frequency or channel of device if practicable.
  - (b) Change modulation type of device if practicable.
  - (c) Rotated EUT though three orthogonal axes to determine the attitude of EUT arrangement produces highest emissions
- (4) Spectrum frequency from 9KHz to 25GHz (tenth harmonic of fundamental frequency) was investigated
- (5) For final emissions measurements at each frequency of interest, the EUT were rotated and the antenna height was varied between 1m and 4m in order to maximize the emission. Measurements in both horizontal and vertical polarities were made and the data was recorded. In order to find the maximum emission, the relative positions of equipments and all of the interface cables were changed according to ANSI C63.10 :2013on Radiated Emission test.
- (6) For emissions above 1GHz, both Peak and Average level were measured with Spectrum Analyzer, and the RBW is set at 1MHz, VBW is set at 3MHz for Peak measure; RBW is set at 1MHz, VBW is set at 10Hz for Average measure.

### 8.4. Test Result

We have scanned the 10th harmonic from 9KHz to the EUT's highest frequency.. Detailed information please see the following page.

From 9KHz to 30MHz: Conclusion: PASS

Note: The amplitude of spurious emissions which are attenuated by more than 20dB below the permissible value has no need to be reported.



Site LAB 966-2 Chamber  
 Limit: FCC Part 15 Class B Radiation  
 EUT:  
 M/N:  
 Mode:  
 Note:

Polarization: **Horizontal**  
 Power: DC 5V  
 Distance:

Temperature: 23.8  
 Humidity: 56 %

Engineer Signature:

**Radiated Emission Measurement**

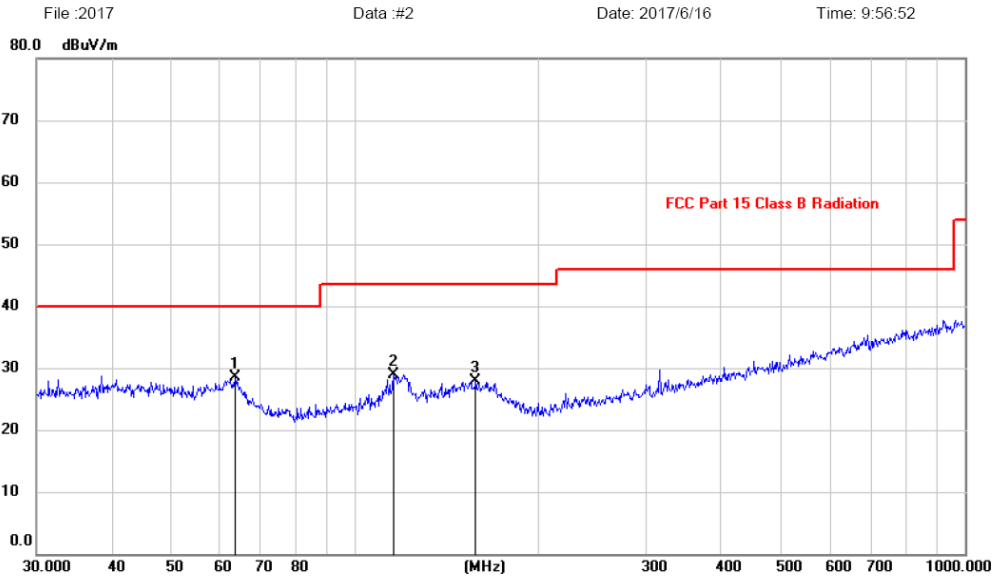

No.	Mk.	Freq.	Reading Level	Correct Factor	Measurement	Limit	Margin	Antenna Height	Table Degree	
		MHz	dBuV	dB	dBuV/m	dBuV/m	dB	cm	degree	Comment
1	*	63.5356	16.37	12.21	28.58	40.00	-11.42	peak		
2		115.3205	16.86	12.09	28.95	43.50	-14.55	peak		
3		157.5588	13.41	14.57	27.98	43.50	-15.52	peak		

Note:1. \*:Maximum data; x:Over limit; !:over margin.  
 2.Measurement=Reading Level+Correct Factor; Correct Factor=Antenna Factor+Cable Loss.

Remark: All modes have been tested, and only worst data of GFSK mode, Channel 2402MHz was listed in this report.

1GHz—25GHz Radiated emission Test result									
EUT: Bluetooth Speaker					M/N: BTS-518B				
Power: DC 3.7V from internal battery									
Test date: 2017-7-4 Test site: 3m Chamber Tested by: Reak									
Test mode: GFSK Tx CH1 2402MHz									
Antenna polarity: Vertical									
No	Freq (MHz)	Read Level (dBuV/m)	Antenna Factor (dB/m)	Cable loss(dB)	Amp Factor (dB)	Result (dBuV/m)	Limit (dBuV/m)	Margin (dB)	Remark
1	4804	43.51	33.95	10.18	34.26	53.38	74	20.62	PK
2	4804	34.65	33.95	10.18	34.26	44.52	54	9.48	AV
3	7206	/							
4	9608	/							
5	12010	/							
Antenna Polarity: Horizontal									
1	4804	43.36	33.95	10.18	34.26	53.23	74	20.77	PK
2	4804	34.36	33.95	10.18	34.26	44.23	54	9.77	AV
3	7206	/							
4	9608	/							
5	12010	/							
Note:									
1, Measuring frequency from 1GHz to 25GHz									
2, Spectrum Set for PK measure: RBW=1MHz, VBW=1MHz, Sweep time=Auto, Detector: PK									
2, Spectrum Set for AV measure: RBW=1MHz, VBW=10Hz, Sweep time=Auto, Detector: PK									
3, Result = Read level + Antenna factor + cable loss-Amp factor									
4, All the other emissions not reported were too low to read and deemed to comply with FCC limit.									

1GHz—25GHz Radiated emission Test result									
EUT: Bluetooth Speaker					M/N: BTS-518B				
Power: DC 3.7V from internal battery									
Test date: 2017-7-4 Test site: 3m Chamber Tested by: Reak									
Test mode: GFSK Tx CH40 2441MHz									
Antenna polarity: Vertical									
No	Freq (MHz)	Read Level (dBuV/m)	Antenna Factor (dB/m)	Cable loss(dB)	Amp Factor (dB)	Result (dBuV/m)	Limit (dBuV/m)	Margin (dB)	Remark
1	4882	41.76	33.93	10.2	34.29	51.60	74	22.40	PK
2	4882	32.37	33.93	10.2	34.29	42.21	54	11.79	AV
3	7323	/							
4	9764	/							
5	12205	/							
Antenna Polarity: Horizontal									
1	4882	41.88	33.93	10.2	34.29	51.72	74	22.28	PK
2	4882	32.86	33.93	10.2	34.29	42.70	54	11.30	AV
3	7323	/							
4	9764	/							
5	12205	/							
Note:									
1, Measuring frequency from 1GHz to 25GHz									
2, Spectrum Set for PK measure: RBW=1MHz, VBW=1MHz, Sweep time=Auto, Detector: PK									
2, Spectrum Set for AV measure: RBW=1MHz, VBW=10Hz, Sweep time=Auto, Detector: PK									
3, Result = Read level + Antenna factor + cable loss-Amp factor									
4, All the other emissions not reported were too low to read and deemed to comply with FCC limit.									

1GHz—25GHz Radiated emission Test result									
EUT: Bluetooth Speaker					M/N: BTS-518B				
Power: DC 3.7V from internal battery									
Test date: 2017-7-4 Test site: 3m Chamber Tested by: Reak									
Test mode: GFSK Tx CH79 2480MHz									
Antenna polarity: Vertical									
No	Freq (MHz)	Read Level (dBuV/m)	Antenna Factor (dB/m)	Cable loss(dB)	Amp Factor (dB)	Result (dBuV/m)	Limit (dBuV/m)	Margin (dB)	Remark
1	4960	41.75	33.98	10.22	34.25	51.70	74	22.30	PK
2	4960	32.59	33.98	10.22	34.25	42.54	54	11.46	AV
3	7440	/							
4	9920	/							
5	12400	/							
Antenna Polarity: Horizontal									
1	4960	42.59	33.98	10.22	34.25	52.54	74	21.46	PK
2	4960	31.85	33.98	10.22	34.25	41.80	54	12.20	AV
3	7440	/							
4	9920	/							
5	12400	/							
Note:									
1, Measuring frequency from 1GHz to 25GHz									
2, Spectrum Set for PK measure: RBW=1MHz, VBW=1MHz, Sweep time=Auto, Detector: PK									
2, Spectrum Set for AV measure: RBW=1MHz, VBW=10Hz, Sweep time=Auto, Detector: PK									
3, Result = Read level + Antenna factor + cable loss-Amp factor									
4, All the other emissions not reported were too low to read and deemed to comply with FCC limit.									

1GHz—25GHz Radiated emission Test result									
EUT: Bluetooth Speaker					M/N: BTS-518B				
Power: DC 3.7V from internal battery									
Test date: 2017-7-4 Test site: 3m Chamber Tested by: Reak									
Test mode: $\pi/4$ DQPSK Tx CH1 2402MHz									
Antenna polarity: Vertical									
No	Freq (MHz)	Read Level (dBuV/m)	Antenna Factor (dB/m)	Cable loss(dB)	Amp Factor (dB)	Result (dBuV/m)	Limit (dBuV/m)	Margin (dB)	Remark
1	4804	43.27	33.95	10.18	34.26	53.14	74	20.86	PK
2	4804	31.98	33.95	10.18	34.26	41.85	54	12.15	AV
3	7206	/							
4	9608	/							
5	12010	/							
Antenna Polarity: Horizontal									
1	4804	43.97	33.95	10.18	34.26	53.84	74	20.16	PK
2	4804	31.88	33.95	10.18	34.26	41.75	54	12.25	AV
3	7206	/							
4	9608	/							
5	12010	/							
Note:									
1, Measuring frequency from 1GHz to 25GHz									
2, Spectrum Set for PK measure: RBW=1MHz, VBW=1MHz, Sweep time=Auto, Detector: PK									
2, Spectrum Set for AV measure: RBW=1MHz, VBW=10Hz, Sweep time=Auto, Detector: PK									
3, Result = Read level + Antenna factor + cable loss-Amp factor									
4, All the other emissions not reported were too low to read and deemed to comply with FCC limit.									

1GHz—25GHz Radiated emission Test result									
EUT: Bluetooth Speaker					M/N: BTS-518B				
Power: DC 3.7V from internal battery									
Test date: 2017-7-4 Test site: 3m Chamber Tested by: Reak									
Test mode: $\pi/4$ DQPSK Tx CH40 2441MHz									
Antenna polarity: Vertical									
No	Freq (MHz)	Read Level (dBuV/m)	Antenna Factor (dB/m)	Cable loss(dB)	Amp Factor (dB)	Result (dBuV/m)	Limit (dBuV/m)	Margin (dB)	Remark
1	4882	43.83	33.98	10.2	34.25	53.76	74	20.24	PK
2	4882	30.45	33.98	10.2	34.25	40.38	54	13.62	AV
3	7323	/							
4	9764	/							
5	12205	/							
Antenna Polarity: Horizontal									
1	4882	44.10	33.93	10.2	34.29	53.94	74	20.06	PK
2	4882	33.65	33.93	10.2	34.29	43.49	54	10.51	AV
3	7323	/							
4	9764	/							
5	12205	/							
Note:									
1, Measuring frequency from 1GHz to 25GHz									
2, Spectrum Set for PK measure: RBW=1MHz, VBW=1MHz, Sweep time=Auto, Detector: PK									
2, Spectrum Set for AV measure: RBW=1MHz, VBW=10Hz, Sweep time=Auto, Detector: PK									
3, Result = Read level + Antenna factor + cable loss-Amp factor									
4, All the other emissions not reported were too low to read and deemed to comply with FCC limit.									



1GHz—25GHz Radiated emission Test result									
EUT: Bluetooth Speaker					M/N: BTS-518B				
Power: DC 3.7V from internal battery									
Test date: 2017-7-4 Test site: 3m Chamber Tested by: Reak									
Test mode: $\pi/4$ DQPSK Tx CH79 2480MHz									
Antenna polarity: Vertical									
No	Freq (MHz)	Read Level (dBuV/m)	Antenna Factor (dB/m)	Cable loss(dB)	Amp Factor (dB)	Result (dBuV/m)	Limit (dBuV/m)	Margin (dB)	Remark
1	4960	42.25	33.98	10.22	34.25	52.20	74	21.80	PK
2	4960	32.32	33.98	10.22	34.25	42.27	54	11.73	AV
3	7440	/							
4	9920	/							
5	12400	/							
Antenna Polarity: Horizontal									
1	4960	42.59	33.98	10.22	34.25	52.54	74	21.46	PK
2	4960	31.37	33.98	10.22	34.25	41.32	54	12.68	AV
3	7440	/							
4	9920	/							
5	12400	/							
Note:									
1, Measuring frequency from 1GHz to 25GHz									
2, Spectrum Set for PK measure: RBW=1MHz, VBW=1MHz, Sweep time=Auto, Detector: PK									
2, Spectrum Set for AV measure: RBW=1MHz, VBW=10Hz, Sweep time=Auto, Detector: PK									
3, Result = Read level + Antenna factor + cable loss-Amp factor									
4, All the other emissions not reported were too low to read and deemed to comply with FCC limit.									

1GHz—25GHz Radiated emission Test result									
EUT: Bluetooth Speaker					M/N: BTS-518B				
Power: DC 3.7V from internal battery									
Test date: 2017-7-4 Test site: 3m Chamber Tested by: Reak									
Test mode: 8- DQPSK Tx CH1 2402MHz									
Antenna polarity: Vertical									
No	Freq (MHz)	Read Level (dBuV/m)	Antenna Factor (dB/m)	Cable loss(dB)	Amp Factor (dB)	Result (dBuV/m)	Limit (dBuV/m)	Margin (dB)	Remark
1	4804	42.10	33.95	10.18	34.26	51.97	74	22.03	PK
2	4804	31.58	33.95	10.18	34.26	41.45	54	12.55	AV
3	7206	/							
4	9608	/							
5	12010	/							
Antenna Polarity: Horizontal									
1	4804	40.80	33.95	10.18	34.26	50.67	74	23.33	PK
2	4804	32.23	33.95	10.18	34.26	42.10	54	11.90	AV
3	7206	/							
4	9608	/							
5	12010	/							
Note:									
1, Measuring frequency from 1GHz to 25GHz									
2, Spectrum Set for PK measure: RBW=1MHz, VBW=1MHz, Sweep time=Auto, Detector: PK									
2, Spectrum Set for AV measure: RBW=1MHz, VBW=10Hz, Sweep time=Auto, Detector: PK									
3, Result = Read level + Antenna factor + cable loss-Amp factor									
4, All the other emissions not reported were too low to read and deemed to comply with FCC limit.									

1GHz—25GHz Radiated emission Test result									
EUT: Bluetooth Speaker					M/N: BTS-518B				
Power: DC 3.7V from internal battery									
Test date: 2017-7-4 Test site: 3m Chamber Tested by: Reak									
Test mode: 8- DQPSK Tx CH40 2441MHz									
Antenna polarity: Vertical									
No	Freq (MHz)	Read Level (dBuV/m)	Antenna Factor (dB/m)	Cable loss(dB)	Amp Factor (dB)	Result (dBuV/m)	Limit (dBuV/m)	Margin (dB)	Remark
1	4882	41.95	33.93	10.2	34.29	51.79	74	22.21	PK
2	4882	32.17	33.93	10.2	34.29	42.01	54	11.99	AV
3	7323	/							
4	9764	/							
5	12205	/							
Antenna Polarity: Horizontal									
1	4882	42.72	33.93	10.2	34.29	52.56	74	21.44	PK
2	4882	32.56	33.93	10.2	34.29	42.40	54	11.60	AV
3	7323	/							
4	9764	/							
5	12205	/							
Note:									
1, Measuring frequency from 1GHz to 25GHz									
2, Spectrum Set for PK measure: RBW=1MHz, VBW=1MHz, Sweep time=Auto, Detector: PK									
2, Spectrum Set for AV measure: RBW=1MHz, VBW=10Hz, Sweep time=Auto, Detector: PK									
3, Result = Read level + Antenna factor + cable loss-Amp factor									
4, All the other emissions not reported were too low to read and deemed to comply with FCC limit.									

1GHz—25GHz Radiated emission Test result									
EUT: Bluetooth Speaker		M/N: BTS-518B							
Power: DC 3.7V from internal battery									
Test date: 2017-7-4 Test site: 3m Chamber Tested by: Reak									
Test mode: 8- DQPSK Tx CH79 2480MHz									
Antenna polarity: Vertical									
No	Freq (MHz)	Read Level (dBuV/m)	Antenna Factor (dB/m)	Cable loss(dB)	Amp Factor (dB)	Result (dBuV/m)	Limit (dBuV/m)	Margin (dB)	Remark
1	4960	41.84	33.98	10.22	34.25	51.79	74	22.21	PK
2	4960	32.97	33.98	10.22	34.25	42.92	54	11.08	AV
3	7440	/							
4	9920	/							
5	12400	/							
Antenna Polarity: Horizontal									
1	4960	41.74	33.98	10.22	34.25	51.69	74	22.31	PK
2	4960	33.19	33.98	10.22	34.25	43.14	54	10.86	AV
3	7440	/							
4	9920	/							
5	12400	/							
Note:									
1, Measuring frequency from 1GHz to 25GHz									
2, Spectrum Set for PK measure: RBW=1MHz, VBW=1MHz, Sweep time=Auto, Detector: PK									
2, Spectrum Set for AV measure: RBW=1MHz, VBW=10Hz, Sweep time=Auto, Detector: PK									
3, Result = Read level + Antenna factor + cable loss-Amp factor									
4, All the other emissions not reported were too low to read and deemed to comply with FCC limit.									

## 9. Band Edge Compliance

### 9.1. Block Diagram of Test Setup

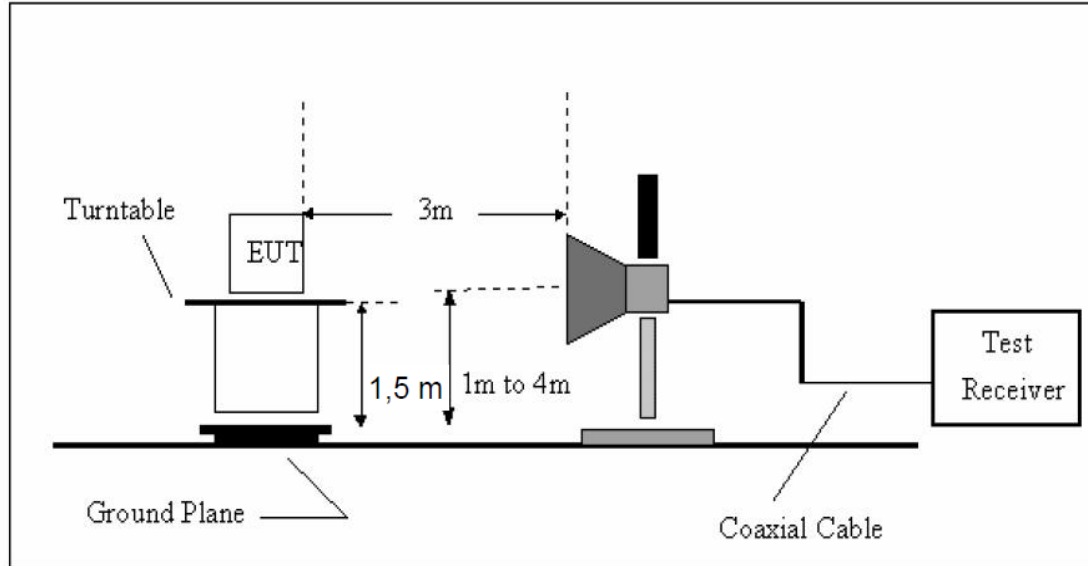

### 9.2. Limit

All the lower and upper band-edges emissions appearing within restricted frequency bands shall not exceed the limits shown in 15.209, all the other emissions outside operation shall be at least 20dB below the fundamental emissions, or comply with 15.209 limits.

### 9.3. Test Procedure

All restriction band and non- restriction band have been tested , only worse case is reported.

### 9.4. Test Result

**PASS. (See below detailed test data)**

## Radiated Method

GFSK (CH Low)

Band Edge Test result								
EUT: Bluetooth Speaker				M/N: BTS-518B				
Power: DC 3.7V from internal battery								
Test date: 2017-7-4 Test site: 3m Chamber Tested by: Reak								
Test mode: Tx CH Low 2402MHz								
Antenna polarity: Vertical								
Freq (MHz)	Read Level (dBuV/m)	Antenna Factor (dB/m)	Cable loss(dB)	Amp Factor (dB)	Result (dBuV/m)	Limit (dBuV/m)	Margin (dB)	Remark
2390	44.44	27.62	3.92	34.97	41.01	74	32.99	<b>PK</b>
Antenna Polarity: Horizontal								
2390	44.63	27.62	3.92	34.97	41.20	74	32.80	<b>PK</b>
Note:								
1, Spectrum Set for PK measure: RBW=1MHz, VBW=1MHz, Sweep time=Auto, Detector: PK								
2, Spectrum Set for AV measure: RBW=1MHz, VBW=10Hz, Sweep time=Auto, Detector: PK								
3, Result = Read level + Antenna factor + cable loss-Amp factor								
4, All the other emissions not reported were too low to read and deemed to comply with FCC limit.								

## GFSK (CH High)

Band Edge Test result								
EUT: Bluetooth Speaker				M/N: BTS-518B				
Power: DC 3.7V from internal battery								
Test date: 2017-7-4 Test site: 3m Chamber Tested by: Reak								
Test mode: Tx CH High 2480MHz								
Antenna polarity: Vertical								
Freq (MHz)	Read Level (dBuV/m)	Antenna Factor (dB/m)	Cable loss(dB)	Amp Factor (dB)	Result (dBuV/m)	Limit (dBuV/m)	Margin (dB)	Remark
2483.5	44.21	27.89	4	34.97	41.13	74	32.87	<b>PK</b>
Antenna Polarity: Horizontal								
2483.5	44.39	27.89	4	34.97	41.31	74	32.69	<b>PK</b>
Note:								
1, Spectrum Set for PK measure: RBW=1MHz, VBW=1MHz, Sweep time=Auto, Detector: PK								
2, Spectrum Set for AV measure: RBW=1MHz, VBW=10Hz, Sweep time=Auto, Detector: PK								
3, Result = Read level + Antenna factor + cable loss-Amp factor								
4, All the other emissions not reported were too low to read and deemed to comply with FCC limit.								

## GFSK ( Hopping Low)

Band Edge Test result								
EUT: Bluetooth Speaker			M/N: BTS-518B					
Power: DC 3.7V from internal battery								
Test date: 2017-7-4 Test site: 3m Chamber Tested by: Reak								
Test mode: Tx								
Antenna polarity: Vertical								
Freq (MHz)	Read Level (dBuV/m)	Antenna Factor (dB/m)	Cable loss(dB)	Amp Factor (dB)	Result (dBuV/m)	Limit (dBuV/m)	Margin (dB)	Remark
2390	44.34	27.62	3.92	34.97	40.91	74	33.09	<b>PK</b>
Antenna Polarity: Horizontal								
2390	44.08	27.62	3.92	34.97	40.65	74	33.35	<b>PK</b>
Note:								
1, Spectrum Set for PK measure: RBW=1MHz, VBW=1MHz, Sweep time=Auto, Detector: PK								
2, Spectrum Set for AV measure: RBW=1MHz, VBW=10Hz, Sweep time=Auto, Detector: PK								
3, Result = Read level + Antenna factor + cable loss-Amp factor								
4, All the other emissions not reported were too low to read and deemed to comply with FCC limit.								



## GFSK ( Hopping High)

Band Edge Test result								
EUT: Bluetooth Speaker				M/N: BTS-518B				
Power: DC 3.7V from internal battery								
Test date: 2017-7-4 Test site: 3m Chamber Tested by: Reak								
Test mode: Tx								
Antenna polarity: Vertical								
Freq (MHz)	Read Level (dBuV/m)	Antenna Factor (dB/m)	Cable loss(dB)	Amp Factor (dB)	Result (dBuV/m)	Limit (dBuV/m)	Margin (dB)	Remark
2483.5	43.87	27.89	4	34.97	40.79	74	33.21	<b>PK</b>
Antenna Polarity: Horizontal								
2483.5	43.77	27.89	4	34.97	40.69	74	33.31	<b>PK</b>
Note:								
1, Spectrum Set for PK measure: RBW=1MHz, VBW=1MHz, Sweep time=Auto, Detector: PK								
2, Spectrum Set for AV measure: RBW=1MHz, VBW=10Hz, Sweep time=Auto, Detector: PK								
3, Result = Read level + Antenna factor + cable loss-Amp factor								
4, All the other emissions not reported were too low to read and deemed to comply with FCC limit.								

$\pi$  /4 DQPSK ( CH Low )

Band Edge Test result								
EUT: Bluetooth Speaker			M/N: BTS-518B					
Power: DC 3.7V from internal battery								
Test date: 2017-7-4 Test site: 3m Chamber Tested by: Reak								
Test mode: Tx CH Low 2402MHz								
Antenna polarity: Vertical								
Freq (MHz)	Read Level (dBuV/m)	Antenna Factor (dB/m)	Cable loss(dB)	Amp Factor (dB)	Result (dBuV/m)	Limit (dBuV/m)	Margin (dB)	Remark
2390	44.34	27.62	3.92	34.97	40.91	74	33.09	<b>PK</b>
Antenna Polarity: Horizontal								
2390	44.08	27.62	3.92	34.97	40.65	74	33.35	<b>PK</b>
Note:								
1, Spectrum Set for PK measure: RBW=1MHz, VBW=1MHz, Sweep time=Auto, Detector: PK								
2, Spectrum Set for AV measure: RBW=1MHz, VBW=10Hz, Sweep time=Auto, Detector: PK								
3, Result = Read level + Antenna factor + cable loss-Amp factor								
4, All the other emissions not reported were too low to read and deemed to comply with FCC limit.								

$\pi/4$  DQPSK ( CH High )

Band Edge Test result								
EUT: Bluetooth Speaker				M/N: BTS-518B				
Power: DC 3.7V from internal battery								
Test date: 2017-7-4 Test site: 3m Chamber Tested by: Reak								
Test mode: Tx CH High 2480MHz								
Antenna polarity: Vertical								
Freq (MHz)	Read Level (dBuV/m)	Antenna Factor (dB/m)	Cable loss(dB)	Amp Factor (dB)	Result (dBuV/m)	Limit (dBuV/m)	Margin (dB)	Remark
2483.5	44.49	27.89	4	34.97	41.41	74	32.59	PK
Antenna Polarity: Horizontal								
2483.5	43.87	27.89	4	34.97	40.79	74	33.21	PK
Note:								
1, Spectrum Set for PK measure: RBW=1MHz, VBW=1MHz, Sweep time=Auto, Detector: PK								
2, Spectrum Set for AV measure: RBW=1MHz, VBW=10Hz, Sweep time=Auto, Detector: PK								
3, Result = Read level + Antenna factor + cable loss-Amp factor								
4, All the other emissions not reported were too low to read and deemed to comply with FCC limit.								

$\pi/4$  DQPSK (Hopping Low)

Band Edge Test result								
EUT: Bluetooth Speaker			M/N: BTS-518B					
Power: DC 3.7V from internal battery								
Test date: 2017-7-4 Test site: 3m Chamber Tested by: Reak								
Test mode: Tx								
Antenna polarity: Vertical								
Freq (MHz)	Read Level (dBuV/m)	Antenna Factor (dB/m)	Cable loss(dB)	Amp Factor (dB)	Result (dBuV/m)	Limit (dBuV/m)	Margin (dB)	Remark
2390	43.94	27.62	3.92	34.97	40.51	74	33.49	<b>PK</b>
Antenna Polarity: Horizontal								
2390	44.50	27.62	3.92	34.97	41.07	74	32.93	<b>PK</b>
Note:								
1, Spectrum Set for PK measure: RBW=1MHz, VBW=1MHz, Sweep time=Auto, Detector: PK								
2, Spectrum Set for AV measure: RBW=1MHz, VBW=10Hz, Sweep time=Auto, Detector: PK								
3, Result = Read level + Antenna factor + cable loss-Amp factor								
4, All the other emissions not reported were too low to read and deemed to comply with FCC limit.								

$\pi$  /4 DQPSK (Hopping High )

Band Edge Test result								
EUT: Bluetooth Speaker			M/N: BTS-518B					
Power: DC 3.7V from internal battery								
Test date: 2017-7-4 Test site: 3m Chamber Tested by: Reak								
Test mode: Tx								
Antenna polarity: Vertical								
Freq (MHz)	Read Level (dBuV/m)	Antenna Factor (dB/m)	Cable loss(dB)	Amp Factor (dB)	Result (dBuV/m)	Limit (dBuV/m)	Margin (dB)	Remark
2483.5	44.53	27.89	4	34.97	41.45	74	32.55	PK
Antenna Polarity: Horizontal								
2483.5	44.37	27.89	4	34.97	41.29	74	32.71	PK
Note:								
1, Spectrum Set for PK measure: RBW=1MHz, VBW=1MHz, Sweep time=Auto, Detector: PK								
2, Spectrum Set for AV measure: RBW=1MHz, VBW=10Hz, Sweep time=Auto, Detector: PK								
3, Result = Read level + Antenna factor + cable loss-Amp factor								
4, All the other emissions not reported were too low to read and deemed to comply with FCC limit.								

## 8- DPSK ( CH Low )

Band Edge Test result								
EUT: Bluetooth Speaker			M/N: BTS-518B					
Power: DC 3.7V from internal battery								
Test date: 2017-7-4 Test site: 3m Chamber Tested by: Reak								
Test mode: Tx CH Low 2402MHz								
Antenna polarity: Vertical								
Freq (MHz)	Read Level (dBuV/m)	Antenna Factor (dB/m)	Cable loss(dB)	Amp Factor (dB)	Result (dBuV/m)	Limit (dBuV/m)	Margin (dB)	Remark
2390	43.66	27.62	3.92	34.97	40.23	74	33.77	<b>PK</b>
Antenna Polarity: Horizontal								
2390	44.15	27.62	3.92	34.97	40.72	74	33.28	<b>PK</b>
Note:								
1, Spectrum Set for PK measure: RBW=1MHz, VBW=1MHz, Sweep time=Auto, Detector: PK								
2, Spectrum Set for AV measure: RBW=1MHz, VBW=10Hz, Sweep time=Auto, Detector: PK								
3, Result = Read level + Antenna factor + cable loss-Amp factor								
4, All the other emissions not reported were too low to read and deemed to comply with FCC limit.								

## 8- DPSK ( CH High )

Band Edge Test result								
EUT: Bluetooth Speaker			M/N: BTS-518B					
Power: DC 3.7V from internal battery								
Test date: 2017-7-4 Test site: 3m Chamber Tested by: Reak								
Test mode: Tx CH High 2480MHz								
Antenna polarity: Vertical								
Freq (MHz)	Read Level (dBuV/m)	Antenna Factor (dB/m)	Cable loss(dB)	Amp Factor (dB)	Result (dBuV/m)	Limit (dBuV/m)	Margin (dB)	Remark
2483.5	44.62	27.89	4	34.97	41.54	74	32.46	<b>PK</b>
Antenna Polarity: Horizontal								
2483.5	44.22	27.89	4	34.97	41.14	74	32.86	<b>PK</b>
Note:								
1, Spectrum Set for PK measure: RBW=1MHz, VBW=1MHz, Sweep time=Auto, Detector: PK								
2, Spectrum Set for AV measure: RBW=1MHz, VBW=10Hz, Sweep time=Auto, Detector: PK								
3, Result = Read level + Antenna factor + cable loss-Amp factor								
4, All the other emissions not reported were too low to read and deemed to comply with FCC limit.								

## 8- DPSK ( Hopping Low)

Band Edge Test result								
EUT: Bluetooth Speaker				M/N: BTS-518B				
Power: DC 3.7V from internal battery								
Test date: 2017-7-4 Test site: 3m Chamber Tested by: Reak								
Test mode: Tx								
Antenna polarity: Vertical								
Freq (MHz)	Read Level (dBuV/m)	Antenna Factor (dB/m)	Cable loss(dB)	Amp Factor (dB)	Result (dBuV/m)	Limit (dBuV/m)	Margin (dB)	Remark
2390	43.95	27.62	3.92	34.97	40.52	74	33.48	<b>PK</b>
Antenna Polarity: Horizontal								
2390	44.11	27.62	3.92	34.97	40.68	74	33.32	<b>PK</b>
Note:								
1, Spectrum Set for PK measure: RBW=1MHz, VBW=1MHz, Sweep time=Auto, Detector: PK								
2, Spectrum Set for AV measure: RBW=1MHz, VBW=10Hz, Sweep time=Auto, Detector: PK								
3, Result = Read level + Antenna factor + cable loss-Amp factor								
4, All the other emissions not reported were too low to read and deemed to comply with FCC limit.								



## 8- DPSK (Hopping High )

Band Edge Test result								
EUT: Bluetooth Speaker			M/N: BTS-518B					
Power: DC 3.7V from internal battery								
Test date: 2017-7-4 Test site: 3m Chamber Tested by: Reak								
Test mode: Tx								
Antenna polarity: Vertical								
Freq (MHz)	Read Level (dBuV/m)	Antenna Factor (dB/m)	Cable loss(dB)	Amp Factor (dB)	Result (dBuV/m)	Limit (dBuV/m)	Margin (dB)	Remark
2483.5	44.59	27.89	4	34.97	41.51	74	32.49	PK
Antenna Polarity: Horizontal								
2483.5	44.11	27.89	4	34.97	41.03	74	32.97	PK
Note:								
1, Spectrum Set for PK measure: RBW=1MHz, VBW=1MHz, Sweep time=Auto, Detector: PK								
2, Spectrum Set for AV measure: RBW=1MHz, VBW=10Hz, Sweep time=Auto, Detector: PK								
3, Result = Read level + Antenna factor + cable loss-Amp factor								
4, All the other emissions not reported were too low to read and deemed to comply with FCC limit.								

Conducted Method

GFSK

CH LOW :

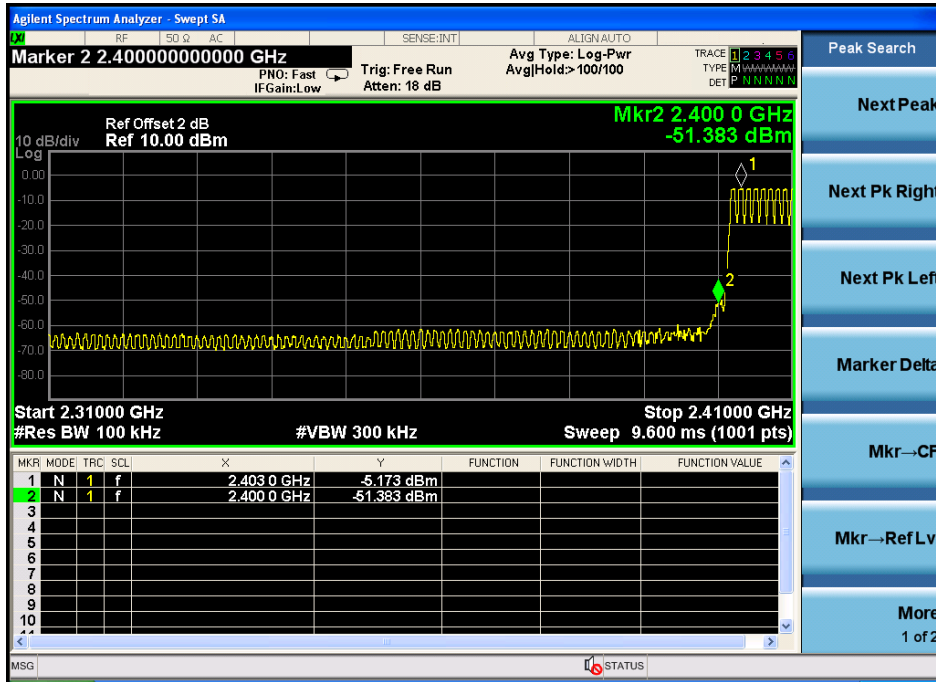

CH High :

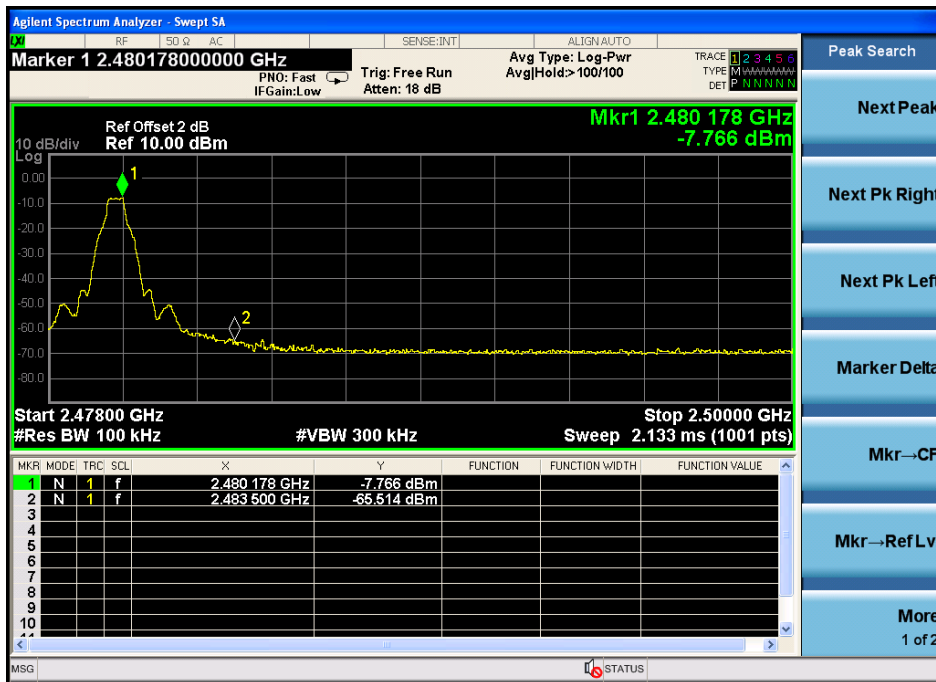

Hopping  
Low

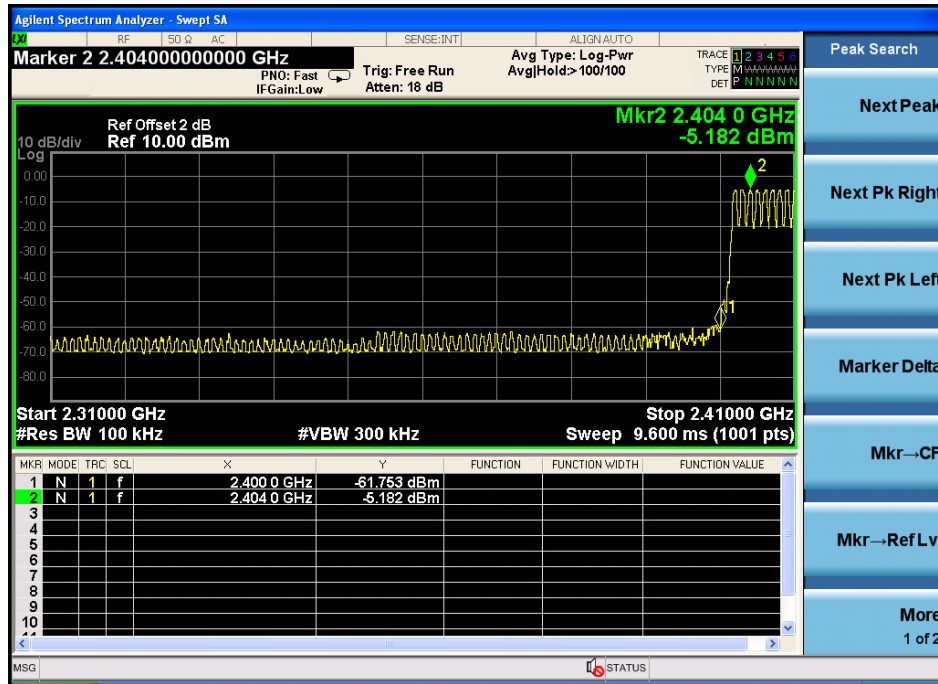

High

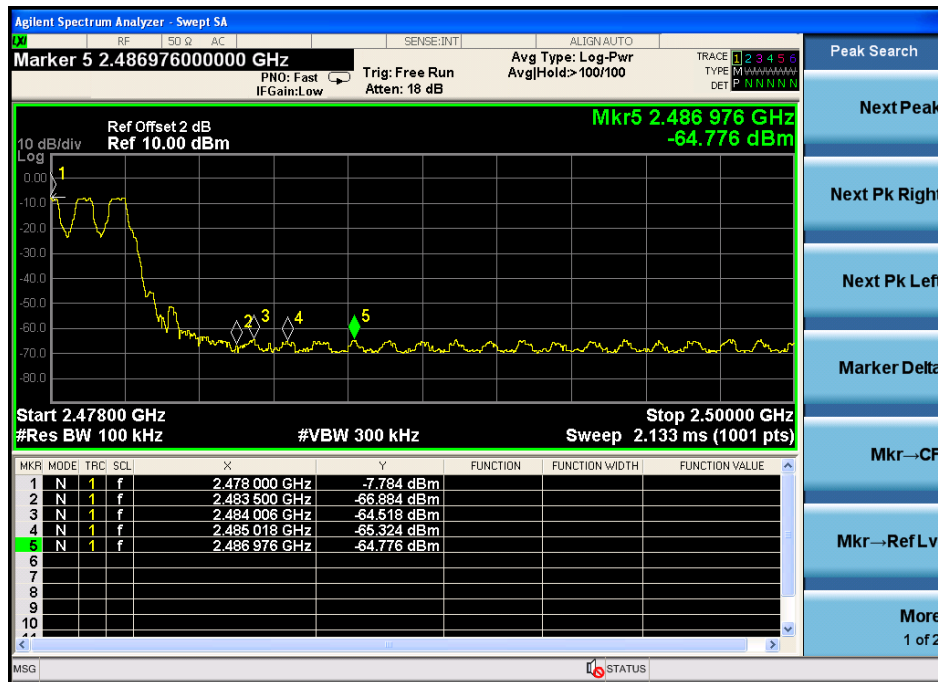



Hopping  
Low

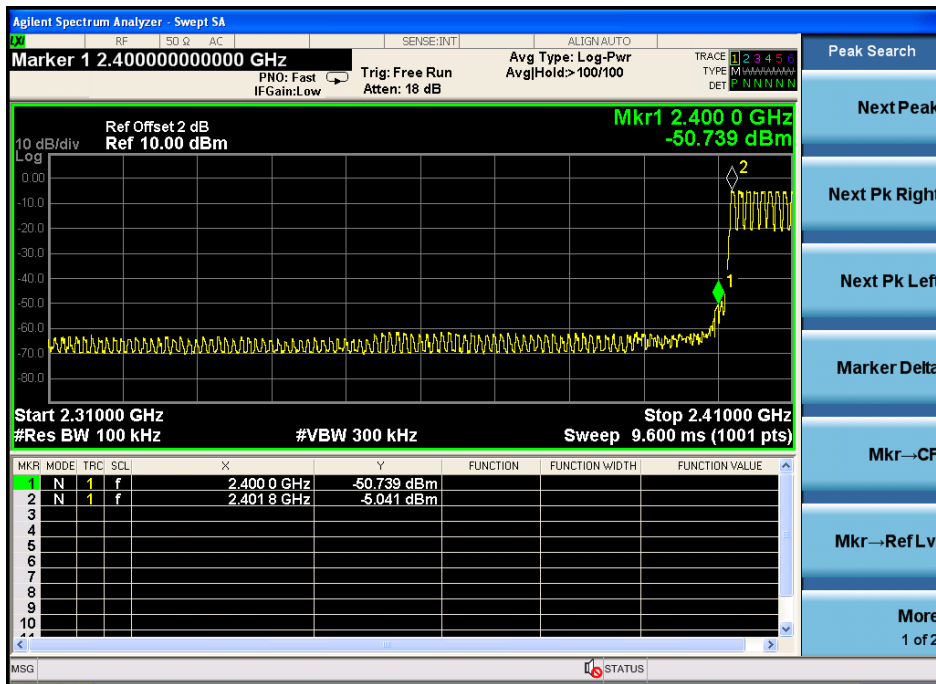

High

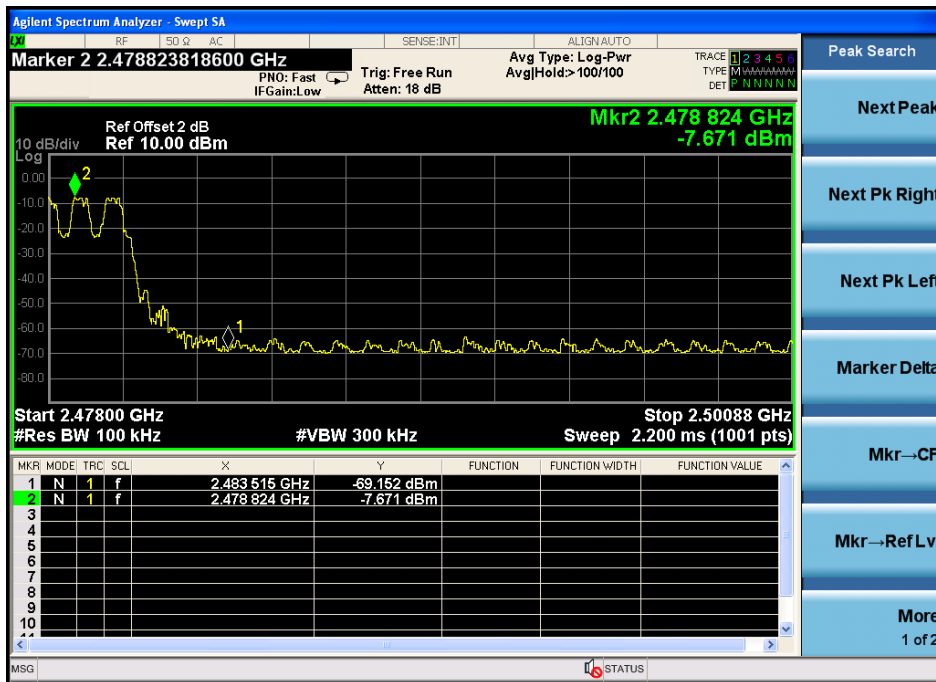





## 10. Power Line Conducted Emissions

### 10.1. Block Diagram of Test Setup

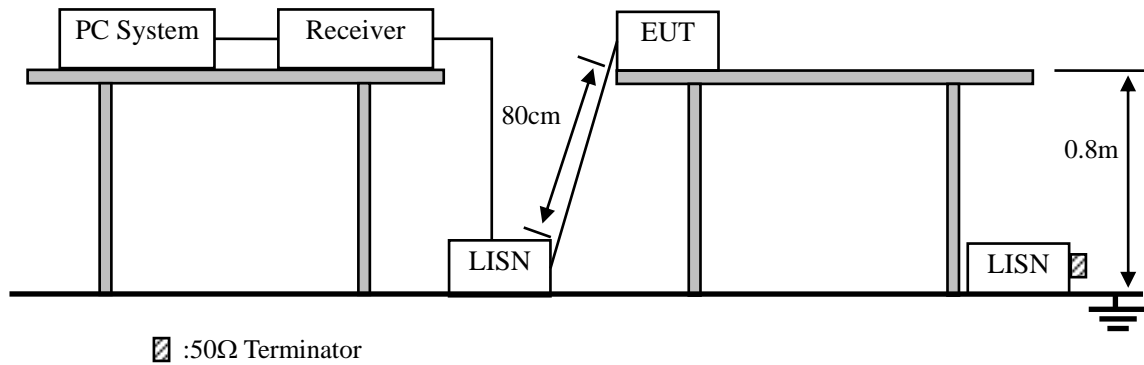

### 10.2. Limit

Frequency	Maximum RF Line Voltage	
	Quasi-Peak Level dB( $\mu$ V)	Average Level dB( $\mu$ V)
150kHz ~ 500kHz	66 ~ 56*	56 ~ 46*
500kHz ~ 5MHz	56	46
5MHz ~ 30MHz	60	50

- Notes: 1. \* Decreasing linearly with logarithm of frequency.  
2. The lower limit shall apply at the transition frequencies.

### 10.3. Test Procedure

- (1) The EUT was placed on a non-metallic table, 80cm above the ground plane.
- (2) Setup the EUT and simulator as shown in 10.1
- (3) The EUT Power connected to the power mains through a power adapter and a line impedance stabilization network (L.I.S.N1). The other peripheral devices power cord connected to the power mains through a line impedance stabilization network (L.I.S.N2), this provided a 50-ohm coupling impedance for the EUT (Please refer to the block diagram of the test setup and photographs). Both sides of power line were checked for maximum conducted interference. In order to find the maximum emission, the relative positions of equipments and all of the interface cables were changed according to ANSI C63.10 :2013on conducted Emission test.
- (4) The bandwidth of test receiver is set at 10KHz.
- (5) The frequency range from 150 KHz to 30MHz is checked.



### 10.4. Test Result

PASS. (See below detailed test data)

Note: If QP Result comply with AV limit, AV Result is deemed to comply with AV limit

Site LAB	Phase: <b>L1</b>	Temperature: 24.2
Limit: FCC Part 15 CLASS B QP	Power: DC 5V	Humidity: 53 %
EUT:		
M/N:		
Mode:		
Note:		

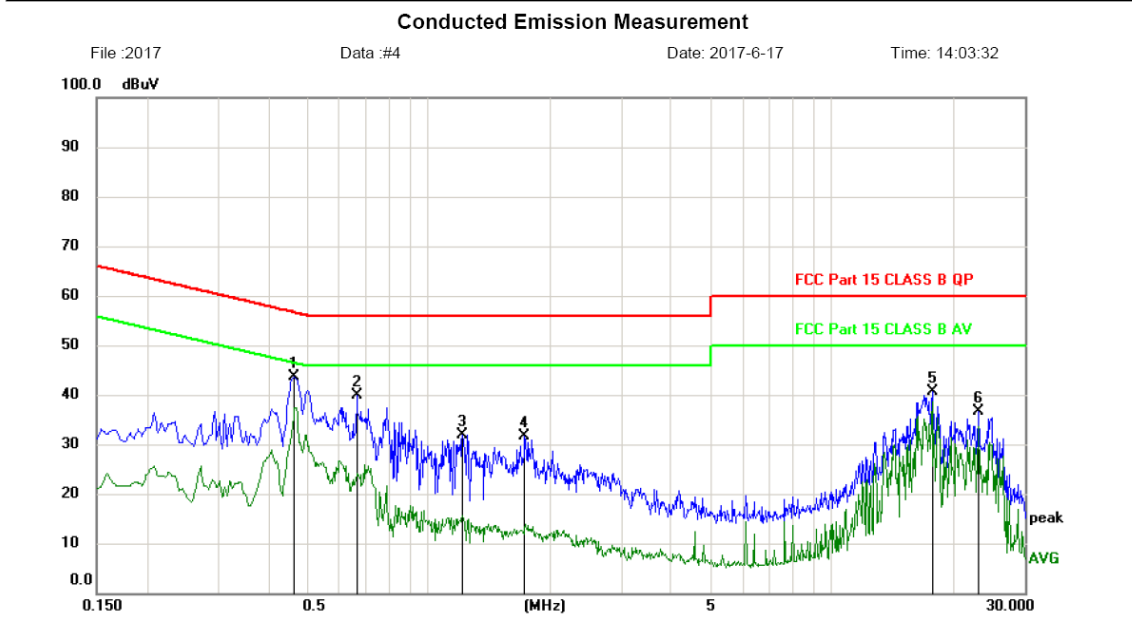

No.	Mk.	Freq.	Reading Level	Correct Factor	Measurement	Limit	Margin	Detector	Comment
		MHz	dBuV	dB	dBuV	dBuV	dB		
1	*	0.4650	33.92	9.71	43.63	56.60	-12.97	peak	
2		0.6630	30.21	9.74	39.95	56.00	-16.05	peak	
3		1.2120	22.08	9.79	31.87	56.00	-24.13	peak	
4		1.7295	21.81	9.85	31.66	56.00	-24.34	peak	
5		17.6955	30.09	10.43	40.52	60.00	-19.48	peak	
6		23.1315	25.91	10.66	36.57	60.00	-23.43	peak	

\*:Maximum data    x:Over limit    !:over margin (Reference Only)

Note: Measurement=Reading Level+Correc Factor.    Factor=(LISN or ISN or PLC or Current Probe)Factor+Cable

Site: LAB	Phase: <b>N</b>	Temperature: 24.2
Limit: FCC Part 15 CLASS B QP	Power: DC 5V	Humidity: 53 %
EUT:		
M/N:		
Mode:		
Note:		

**Conducted Emission Measurement**

File: 2017      Data: #3      Date: 2017-6-17      Time: 14:01:53

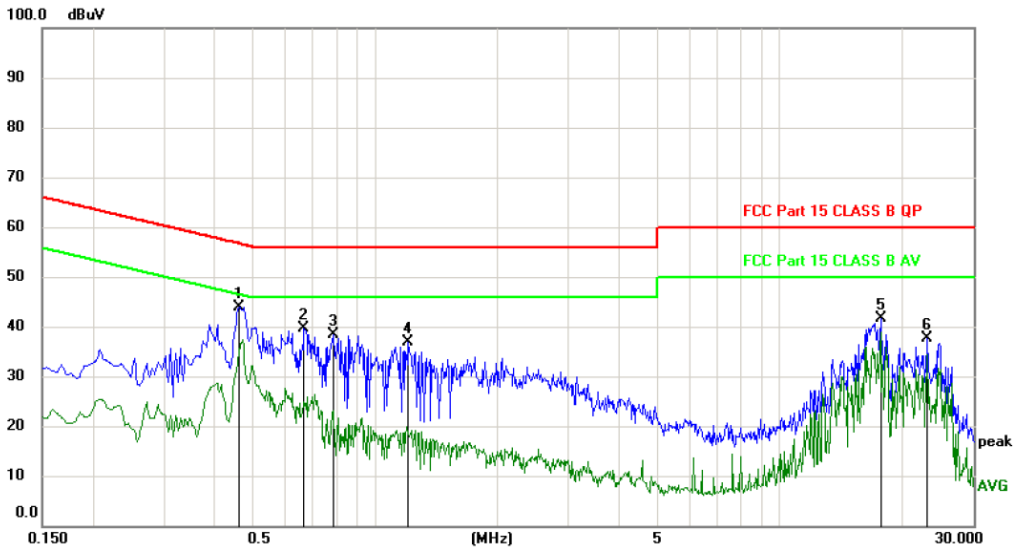

No. Mk.	Freq. MHz	Reading Level dBuV	Correct Factor dB	Measurement dBuV	Limit dBuV	Margin dB	Detector	Comment
1 *	0.4605	34.26	9.71	43.97	56.68	-12.71	peak	
2	0.6675	29.91	9.74	39.65	56.00	-16.35	peak	
3	0.7890	28.57	9.74	38.31	56.00	-17.69	peak	
4	1.2075	27.00	9.79	36.79	56.00	-19.21	peak	
5	17.6955	31.19	10.43	41.62	60.00	-18.38	peak	
6	23.1315	26.94	10.66	37.60	60.00	-22.40	peak	

\*:Maximum data    x:Over limit    !:over margin      <Reference Only

Note: Measurement=Reading Level+Correc Factor.    Factor=(LISN or ISN or PLC or Current Probe)Factor+Cable

## **11. Antenna Requirements**

### **11.1. Limit**

For intentional device, according to FCC 47 CFR Section 15.203, an intentional radiator shall be designed to ensure that no antenna other than that furnished by the responsible party shall be used with the device. And according to FCC 47 CFR Section 15.247 (b), if transmitting antennas of directional gain greater than 6dBi are used, the power shall be reduced by the amount in dB that the directional gain of the antenna exceeds 6dBi.

### **11.2. Result**

The antennas used for this product are PCB Antenna for Bluetooth, no antenna other than that furnished by the responsible party shall be used with the device, the maximum peak gain of the transmit antenna is only 0dBi for Bluetooth.

## 12. Test setup photo

### 12.1. Photos of Radiated emission

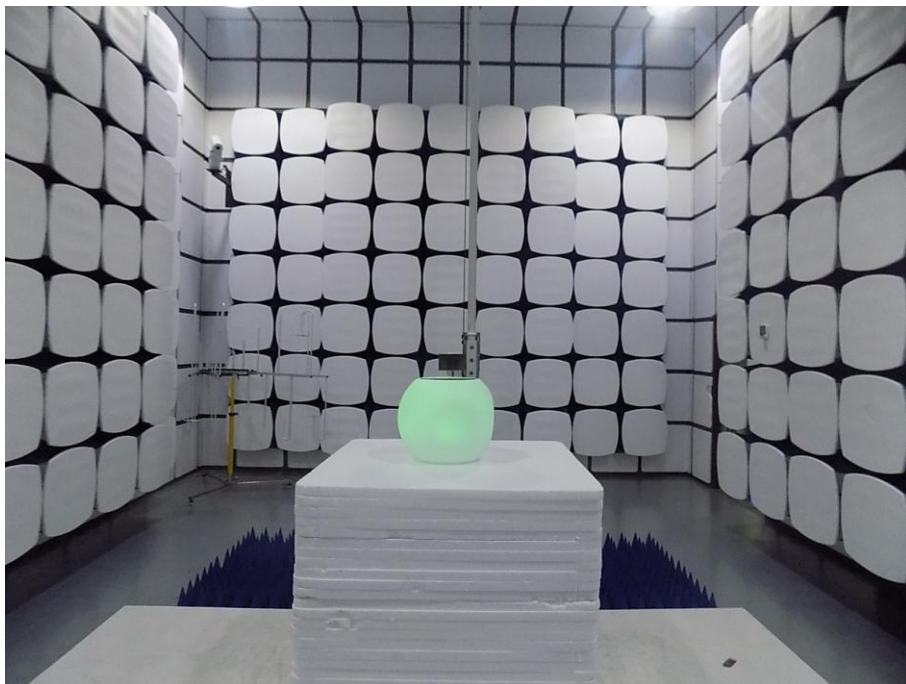
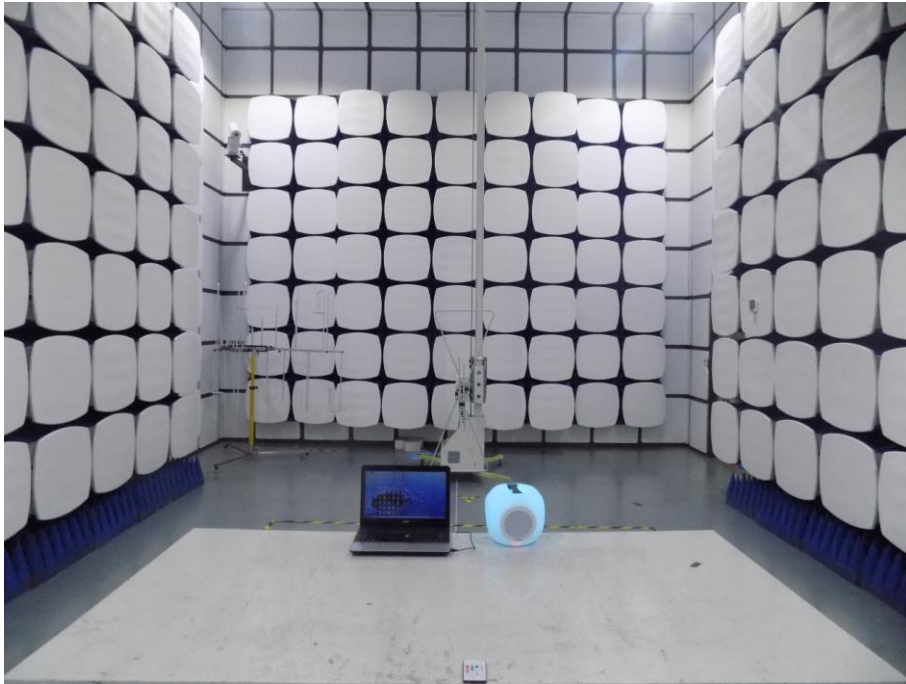

## 12.2.Photos of Conducted Emission test

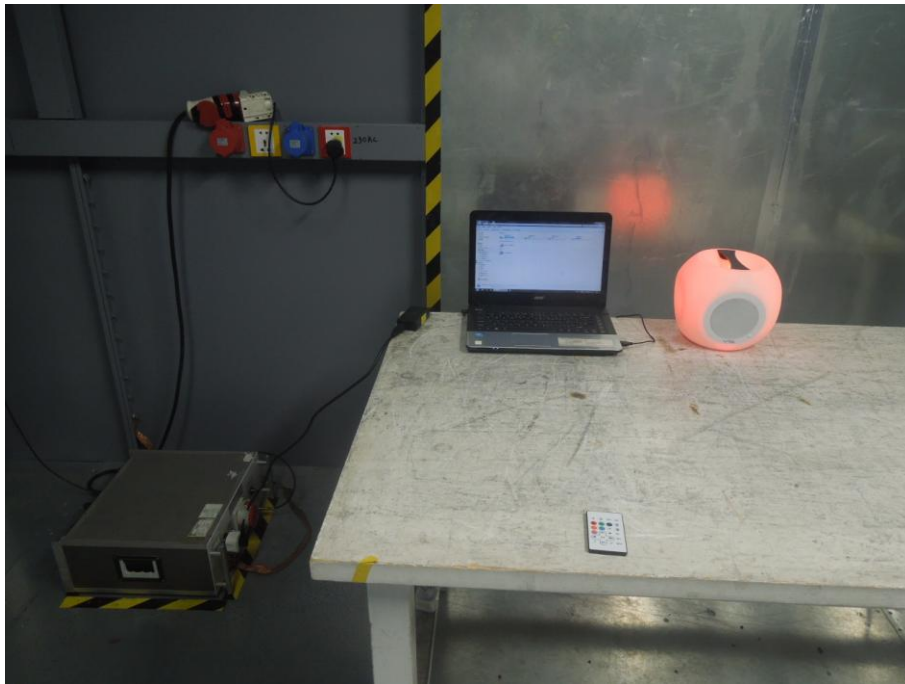

### 13. Photos of EUT

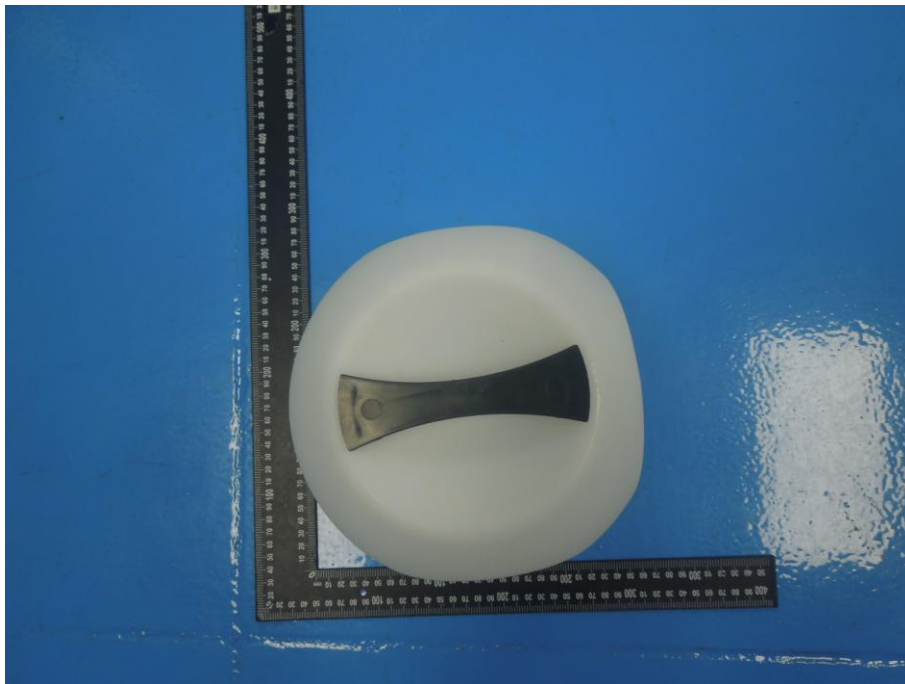
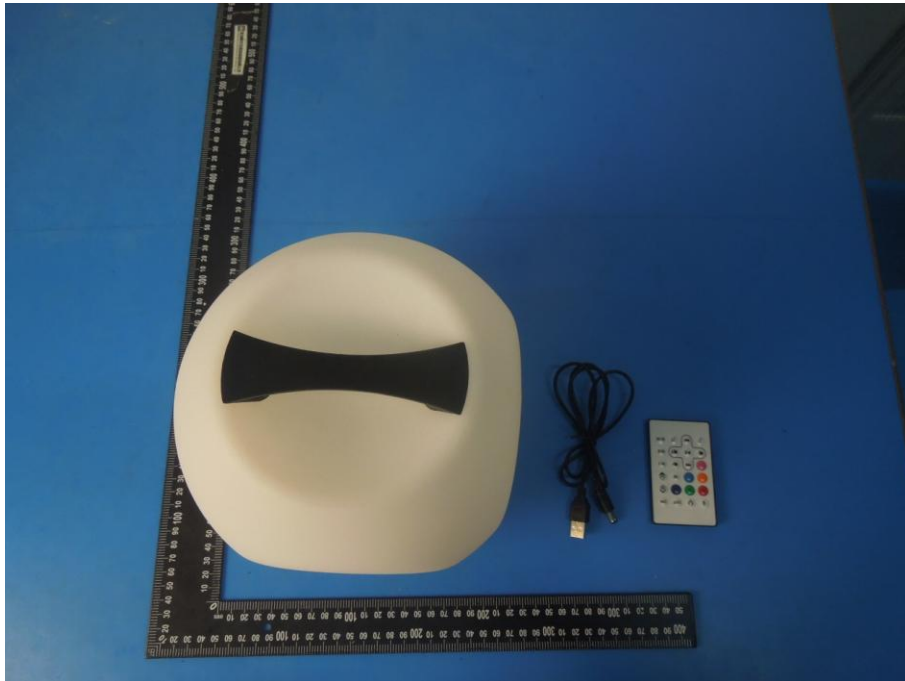

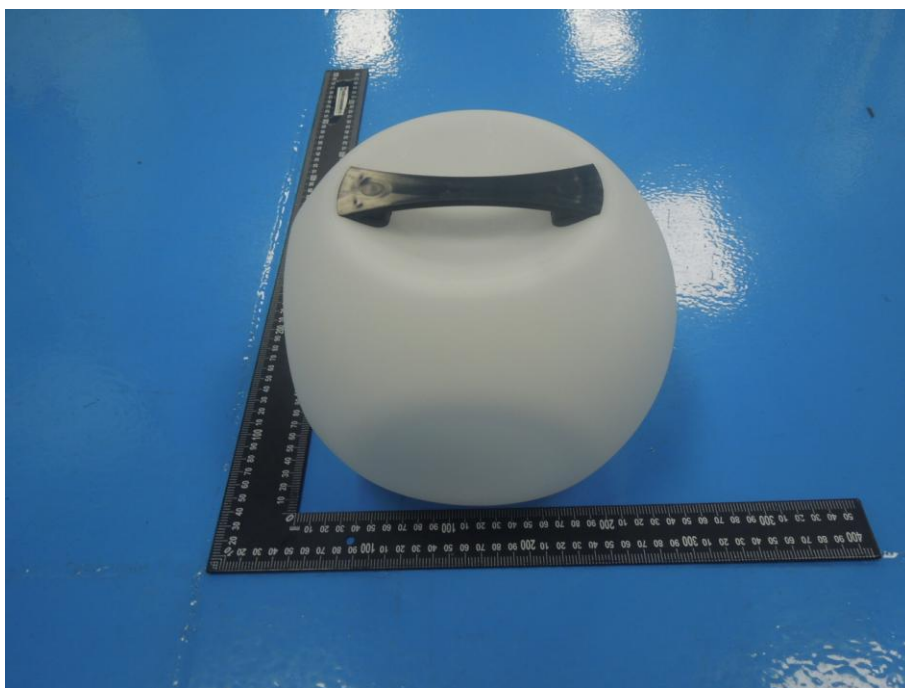
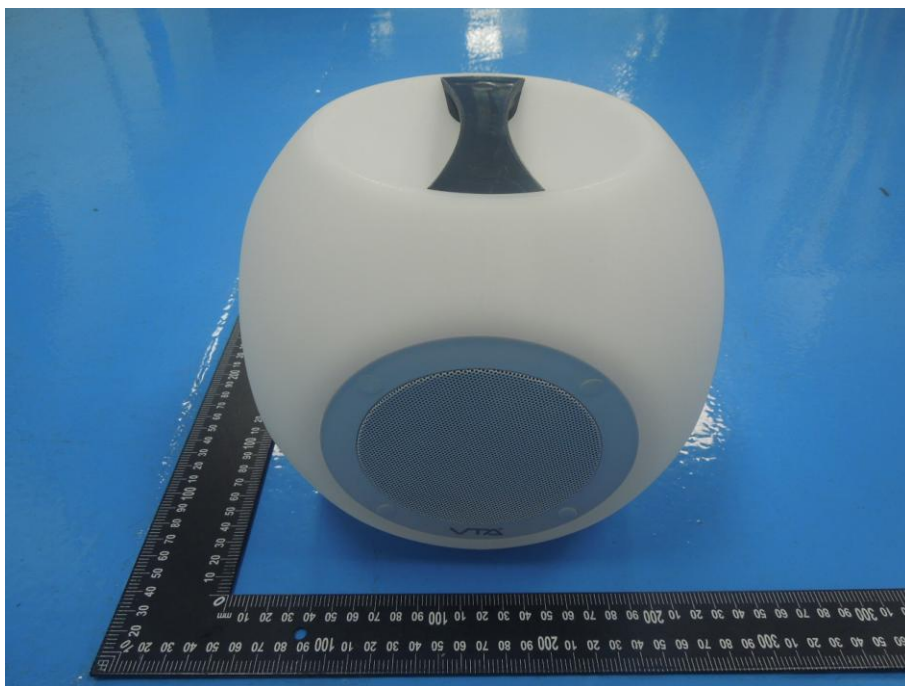

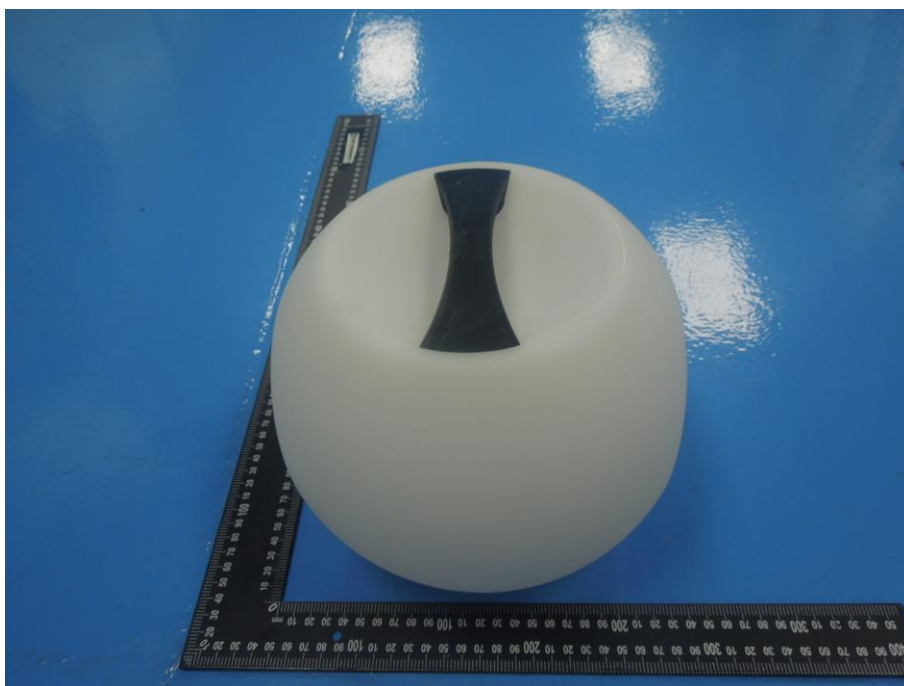
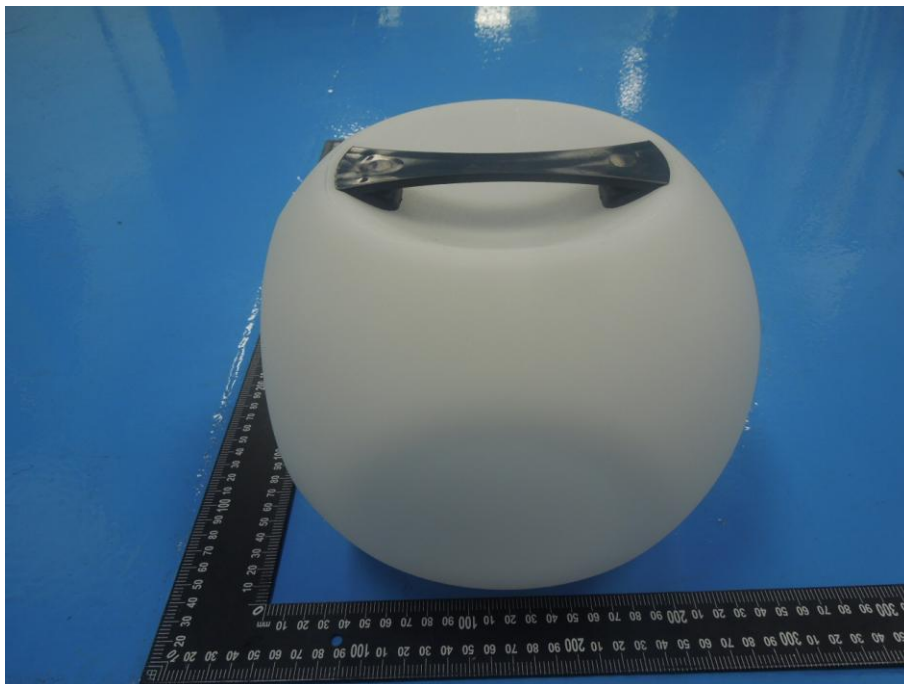



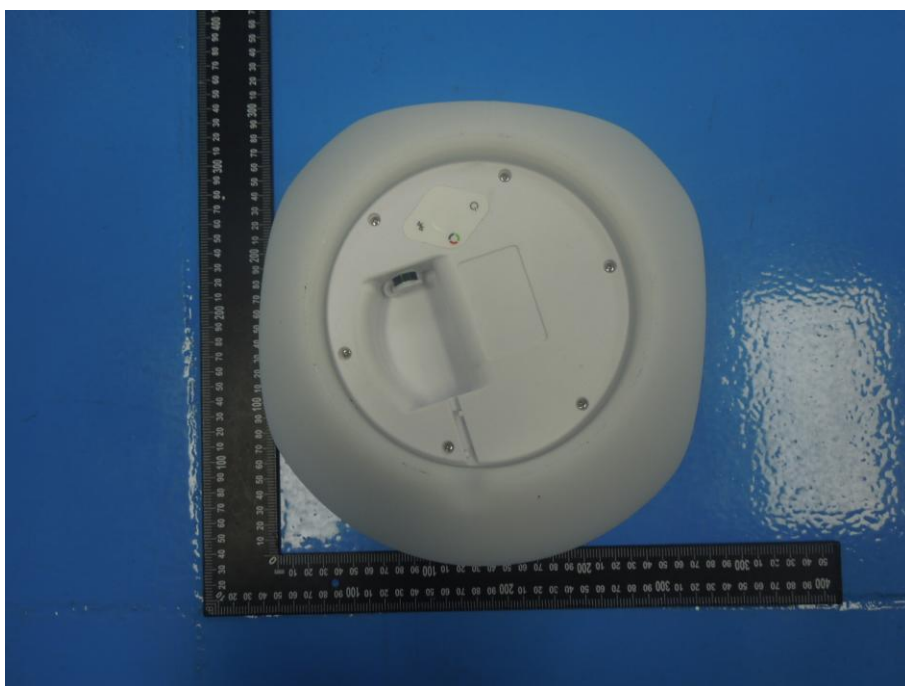
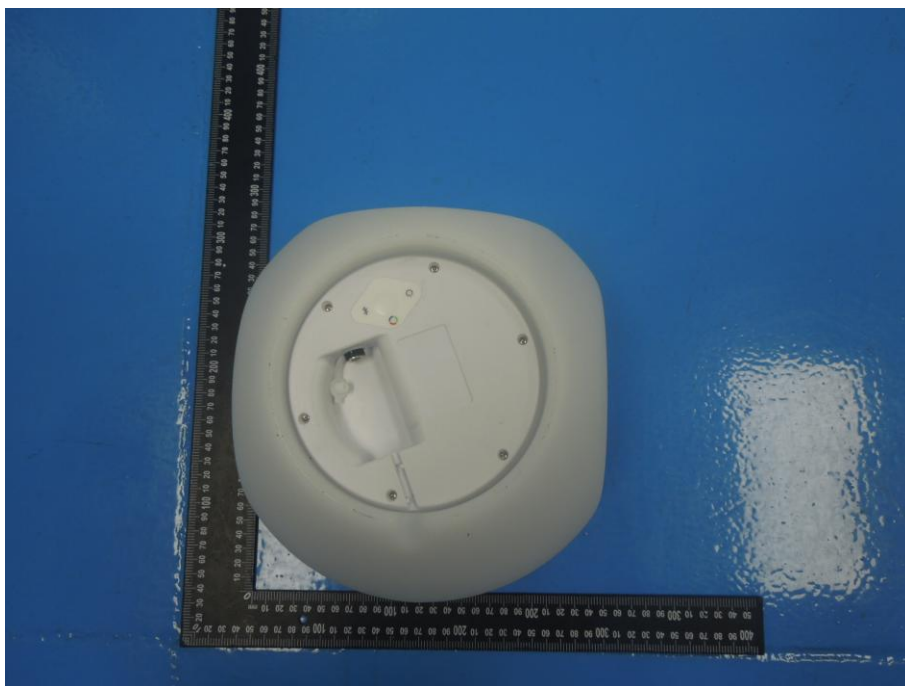

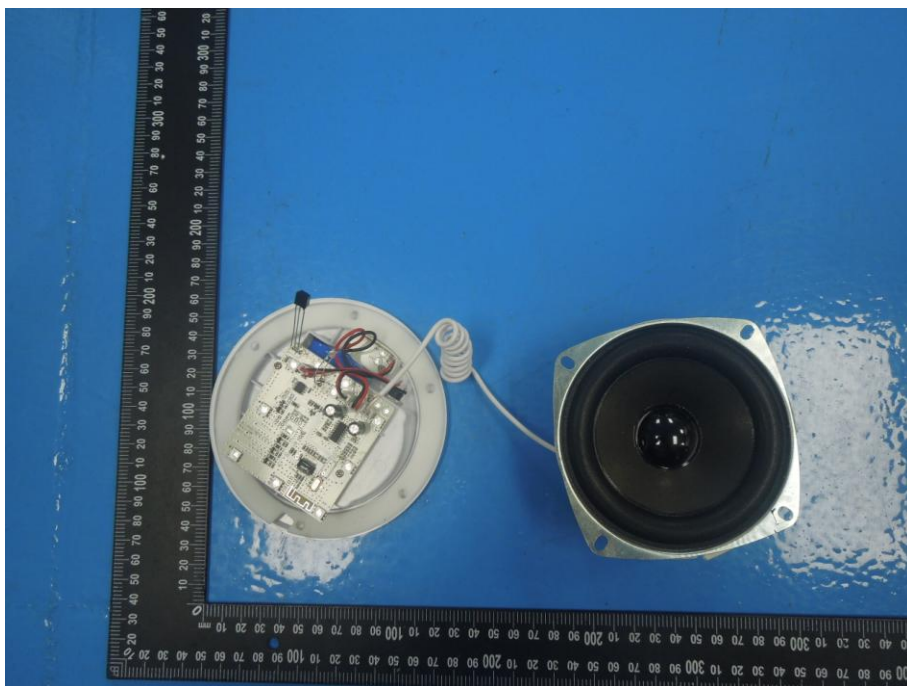
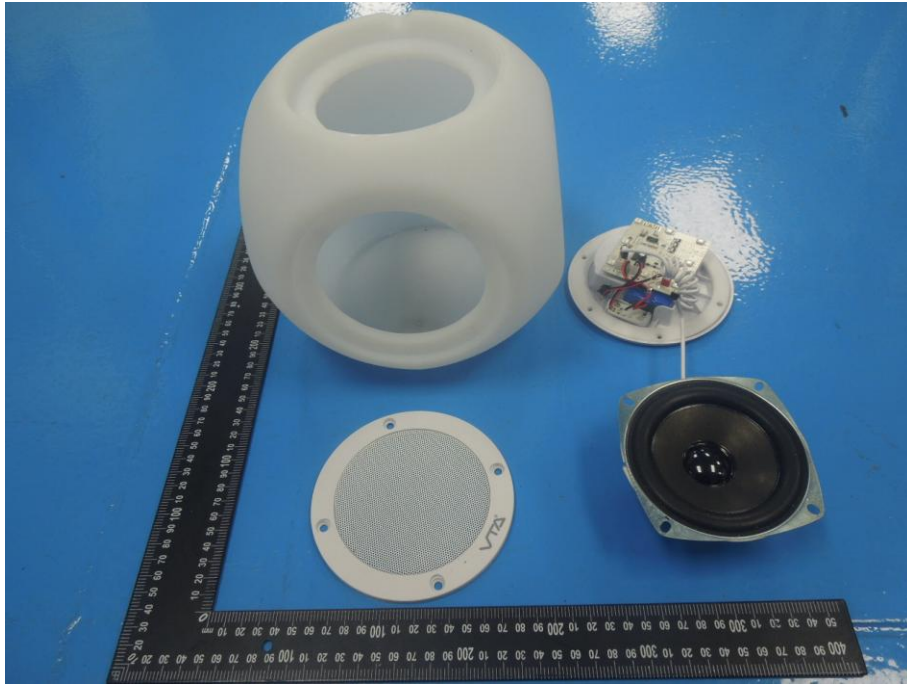

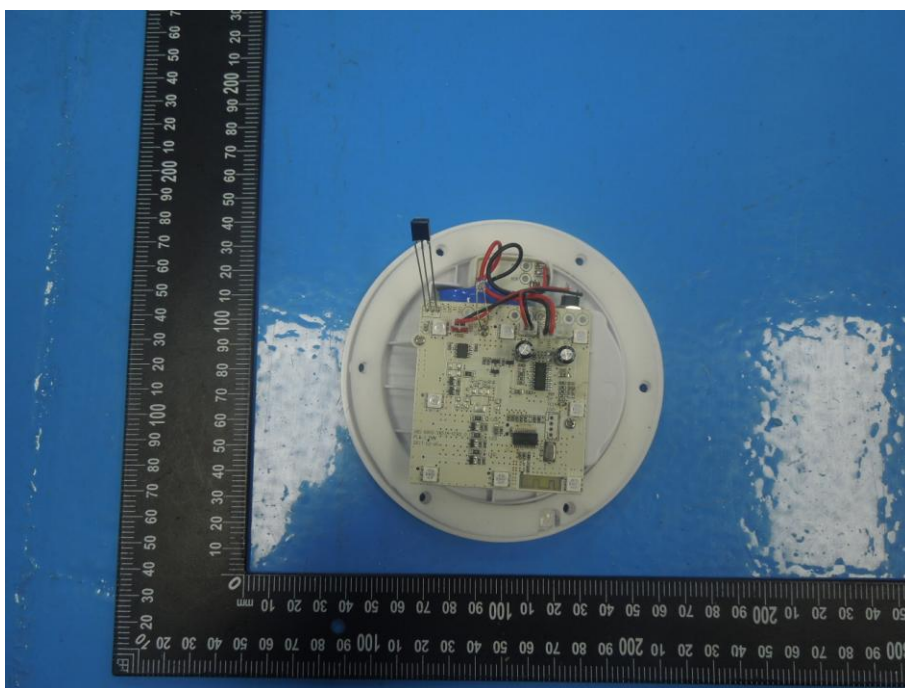
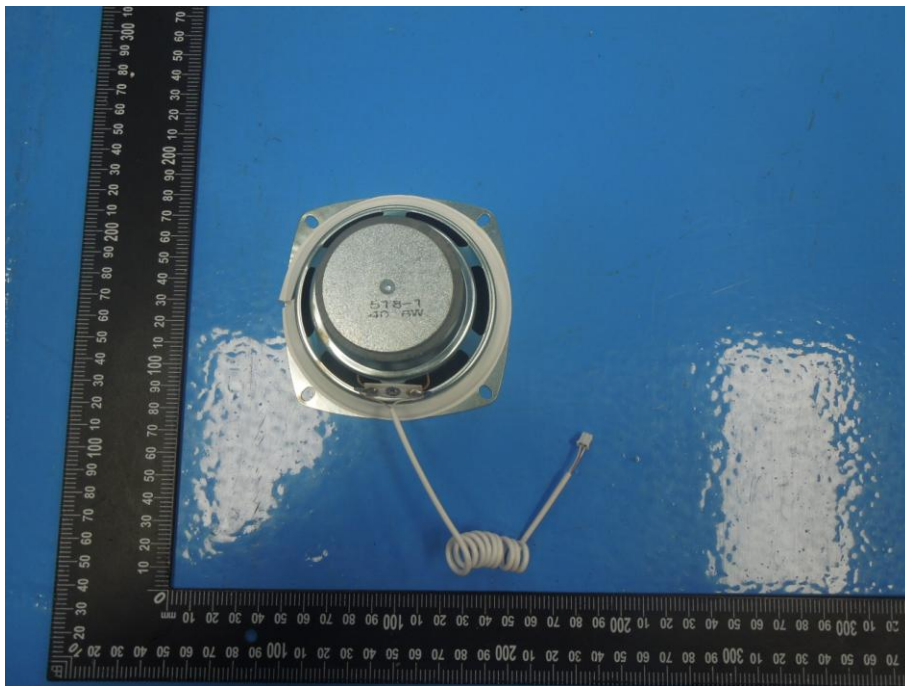

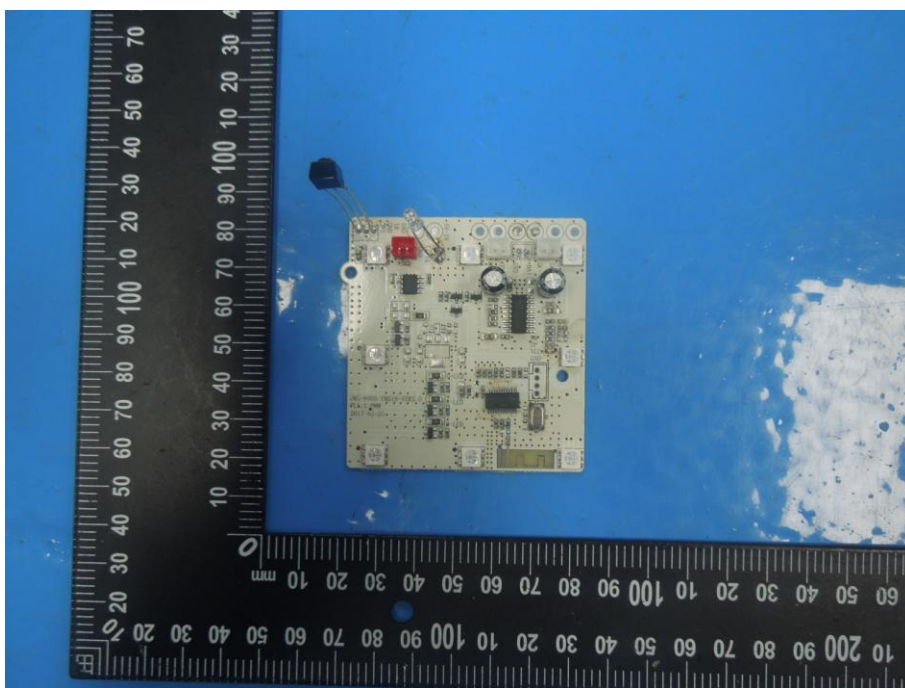
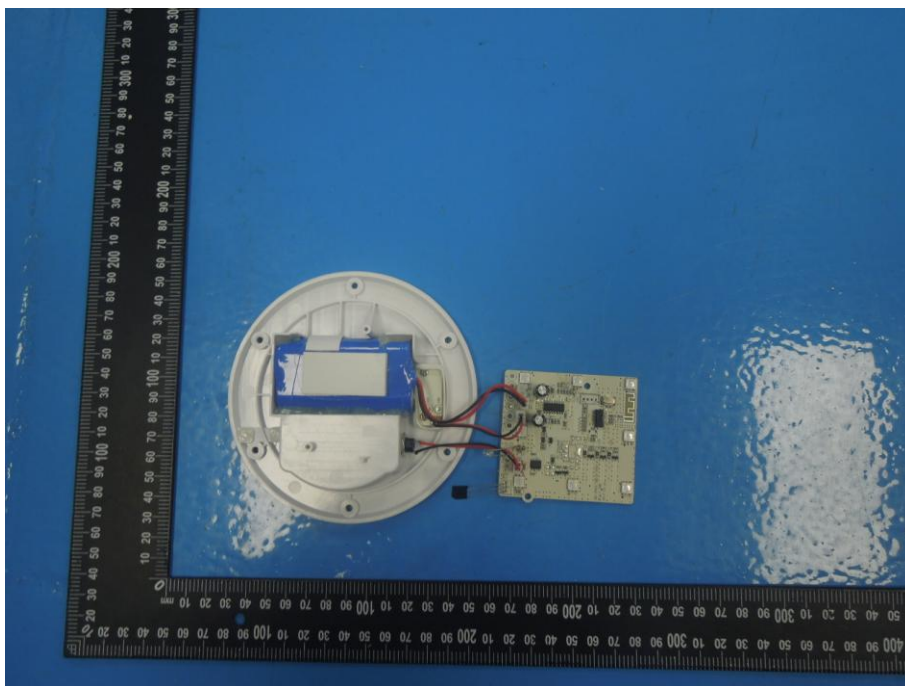

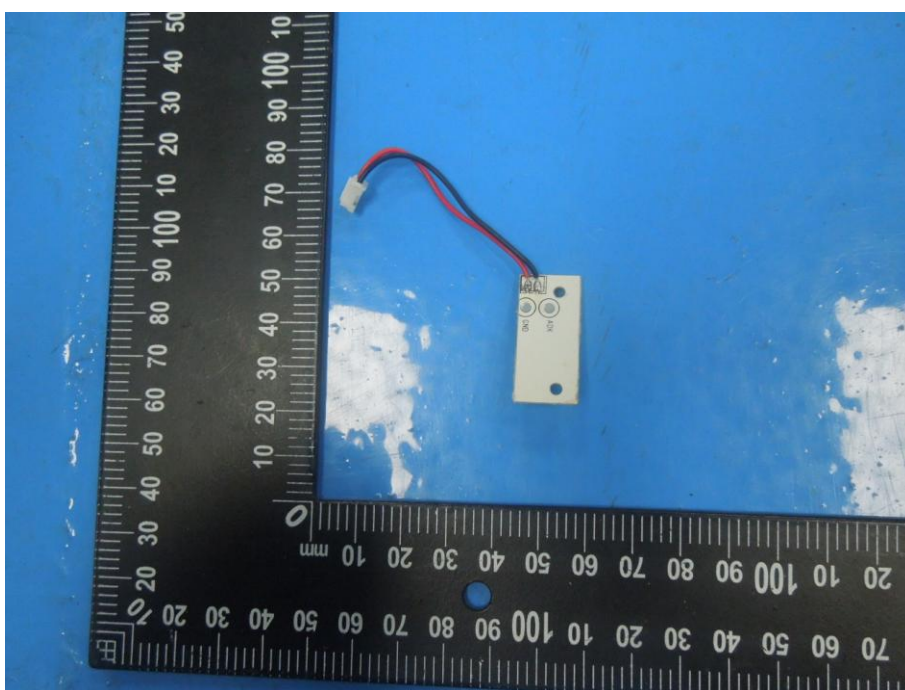
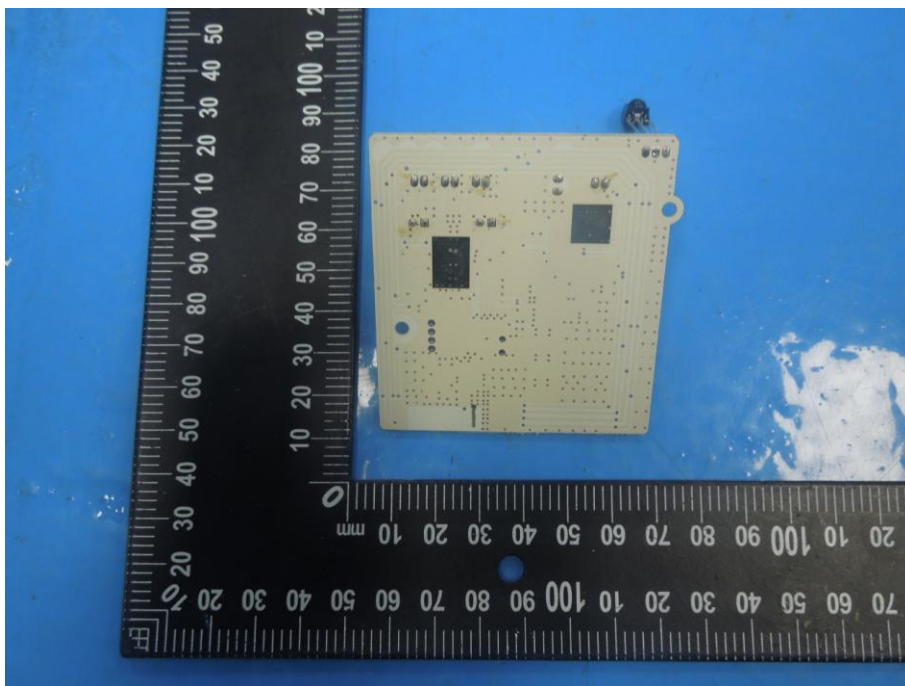

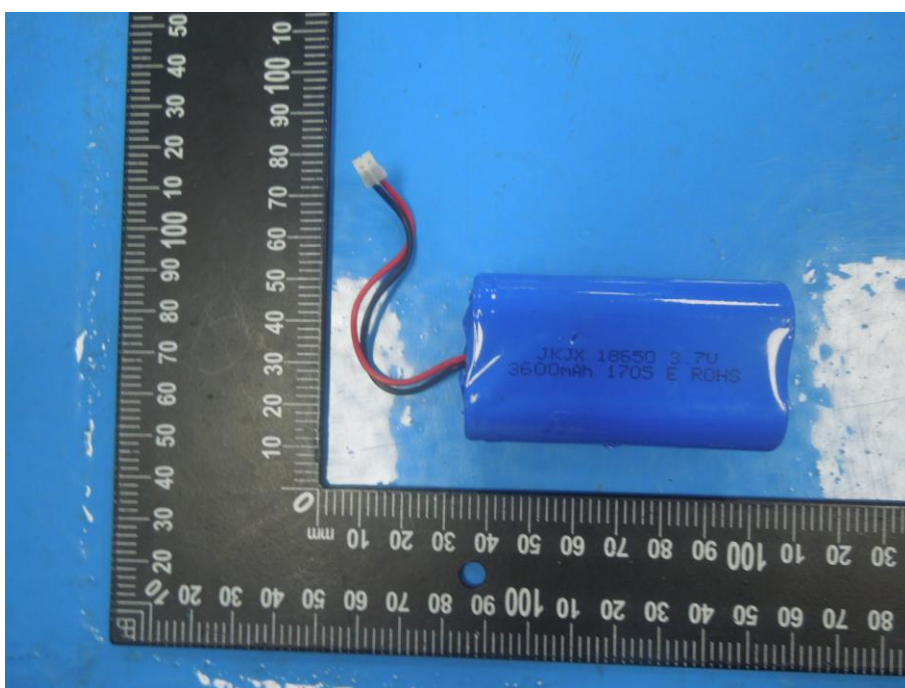
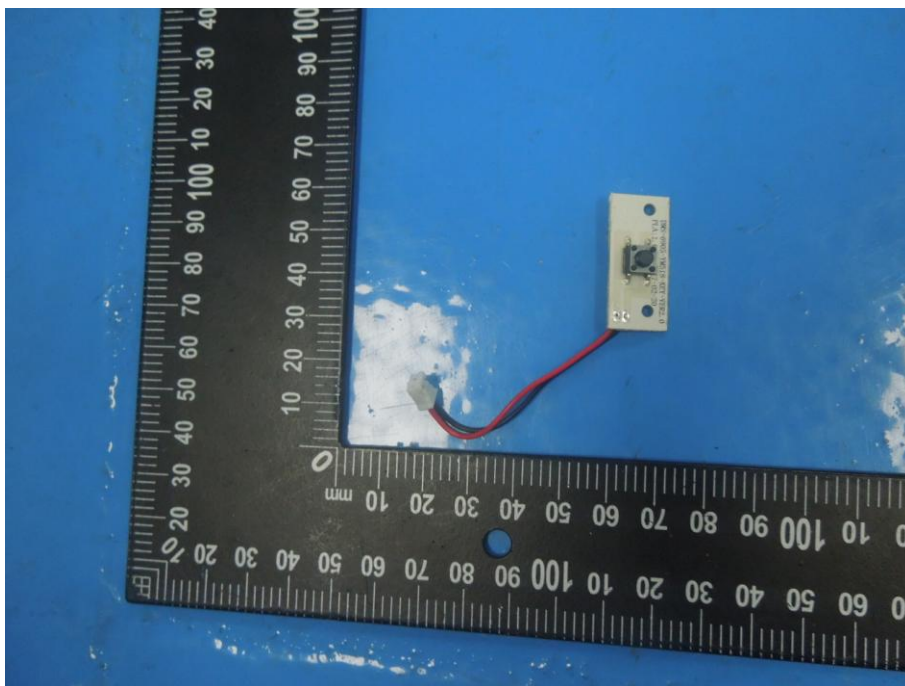

-----END OF REPORT-----