



Certification Test Report

**FCC ID: R7PS5WNODE
IC: 5294A-S5WNODE**

**FCC Rule Parts: 15.249
ISED Canada Radio Standards Specification: RSS-210**

Report Number: AT72157009-2C2

**Manufacturer: Landis + Gyr Technology, Inc.
Model: Water 520 Mi.Node/IP**

**Test Begin Date: April 6, 2020
Test End Date: August 24, 2020**

Report Issue Date: April 14, 2021



FOR THE SCOPE OF ACCREDITATION UNDER Certificate Number: 2955.09

This report must not be used by the client to claim product certification, approval, or endorsement by A2LA, NIST, or any agency of the Federal Government.

Prepared By:

**Divya Adusumilli
Senior Wireless Engineer
TÜV SÜD America Inc.**

Reviewed by:

**Kirby Munroe
EMC Technical Manager, North America
TÜV SÜD America Inc.**

This test report shall not be reproduced except in full. This report may be reproduced in part with prior written consent of ACS, Inc. The results contained in this report are representative of the sample(s) submitted for evaluation.

This report contains 23 pages

TABLE OF CONTENTS

1	GENERAL	3
1.1	PURPOSE.....	3
1.2	APPLICANT INFORMATION.....	3
1.3	PRODUCT DESCRIPTION	3
1.4	TEST METHODOLOGY AND CONSIDERATIONS	4
2	TEST FACILITIES	5
2.1	LOCATION	5
2.2	LABORATORY ACCREDITATIONS/RECOGNITIONS/CERTIFICATIONS	5
2.3	RADIATED EMISSIONS TEST SITE DESCRIPTION	6
2.3.1	<i>Semi-Anechoic Chamber Test Site – Chamber A</i>	6
2.3.2	<i>Semi-Anechoic Chamber Test Site – Chamber B</i>	7
2.4	CONDUCTED EMISSIONS TEST SITE DESCRIPTION	8
2.4.1	<i>Conducted Emissions Test Site</i>	8
3	APPLICABLE STANDARD REFERENCES	9
4	LIST OF TEST EQUIPMENT	9
5	SUPPORT EQUIPMENT	10
6	EQUIPMENT UNDER TEST SETUP BLOCK DIAGRAM	10
7	SUMMARY OF TESTS	11
7.1	ANTENNA REQUIREMENT – FCC 15.203	11
7.2	POWER LINE CONDUCTED EMISSIONS – FCC 15.207, ISED CANADA: RSS-GEN 8.8.....	11
7.2.1	<i>Measurement Procedure</i>	11
7.2.2	<i>Measurement Results</i>	11
7.3	20dB / 99% BANDWIDTH – FCC: SECTION 15.215, ISED CANADA: RSS-GEN 4.6.1	12
7.3.1	<i>Measurement Procedure</i>	12
7.3.2	<i>Measurement Results</i>	12
7.4	FUNDAMENTAL FIELD STRENGTH – FCC: SECTION 15.249(A), ISED CANADA: RSS-210 B.10.....	15
7.4.1	<i>Measurement Procedure</i>	15
7.4.2	<i>Measurement Results</i>	15
7.5	RADIATED SPURIOUS EMISSIONS – FCC: SECTION 15.249(A)(D)(E), ISED CANADA: RSS-210 B.10 16	
7.5.1	<i>Measurement Procedure</i>	16
7.5.1.1	<i>Distance Correction for Measurements Below 30 MHz – Part 15.31</i>	16
7.5.1.2	<i>Measurement Results</i>	17
7.5.2	<i>Sample Calculation:</i>	18
8	ESTIMATION OF MEASUREMENT UNCERTAINTY	19
9	CONCLUSION	19
	APPENDIX A: PLOTS	20

1 GENERAL**1.1 Purpose**

The purpose of this report is to demonstrate compliance with Part 15 Subpart C of the FCC's Code of Federal Regulations and Innovation, Science and Economic Development Canada's Radio Standards Specification RSS-210 for certification.

1.2 Applicant Information

Landis+Gyr Technology, Inc.
30000 Mill Creek Ave., Suite 100
Alpharetta, GA 30022

1.3 Product description

The Water 520 Mi.Node/IP is designed for water meter reading. It has a 2-way radio operating in the 902-928 MHz LAN unlicensed frequency band. The main function of the radio is to measure, process, and send the data to the utility through Landis+Gyr's RF Mesh and Mesh IP networks.

The EUT has two different antenna sleeve types including a plastic antenna cover and fitted with a metal antenna cover. The plastic antenna cover is the basic installation, while the metal antenna cover is for use in a metal water meter pit installation.

Technical Information:

The model Water 520 Mi.Node/IP provides three distinct modes of operation as outlined below.

Mode of Operation	Frequency Range (MHz)	Number of Channels	Chanel Spacing (kHz)	Data Rates Supported (kbps)
1. RF Mesh	902.3 - 927.7	255	100	19.2
2. RF Mesh IP	902.4 - 927.6	64	400	50.0

Modulation Format: FSK/GFSK
Antenna Type / Gain: Wire Antenna / 0.0 dBi
Operating Voltage: 3.6 Vdc (battery)

EUT Serial Numbers: RF Mesh #08 (Radiated Emissions Mode 1)
RF Mesh IP #07 (Radiated Emissions Mode 2)
RF Mesh #04 (RF Conducted Mode 1)
RF Mesh IP #01 (RF Conducted Mode 2)

Test Sample Condition: The test samples were provided in good working order with no visible defects.

1.4 Test Methodology and Considerations

All modes of operation, including all available data rates, were evaluated. The data presented in this report represents the worst case where applicable.

For radiated emissions, the EUT was evaluated in one orthogonal orientation (Y-orientation) as it is intended to be installed for each antenna cover. See test setup photos for more information. The EUT was programmed to generate a continuously modulated signal on each channel evaluated. The fundamental field strength was measured for all data rates in all configurations. The radiated spurious emissions measurements were reported for the worst-case data rate of 19.2kbps only.

For RF Conducted measurements, the EUT was connected to the test equipment with a temporary SMA connector. The EUT was programmed to generate a continuously modulated signal on each channel evaluated.

Power setting during test: A0

2 TEST FACILITIES

2.1 Location

The radiated and conducted emissions test sites are located at the following addresses:

TÜV SÜD America, Inc.
5945 Cabot Pkwy, Suite 100
Alpharetta, GA 30005
Phone: (678) 341-5900

2.2 Laboratory Accreditations/Recognitions/Certifications

TÜV SÜD America, Inc. is accredited to ISO/IEC 17025 by the American Association for Laboratory Accreditation/A2LA accreditation program and has been issued certificate number 2955.09 in recognition of this accreditation.

Unless otherwise specified, all tests methods described within this report are covered under the ISO/IEC 17025 scopes of accreditation.

The Semi-Anechoic Chamber Test Sites and Conducted Emissions Sites have been fully described, submitted to, and accepted by the FCC, ISED Canada and the Japanese Voluntary Control Council for Interference by information technology equipment.

FCC Designation Accreditation Number:	US1233
FCC Test Site Registration Number:	967699
ISED Canada Lab Code:	23932
VCCI Member Number:	1831
• VCCI Registration Number	A-0295

2.3 Radiated Emissions Test Site Description

2.3.1 Semi-Anechoic Chamber Test Site – Chamber A

The Semi-Anechoic Chamber Test Site consists of a 20' x 30' x 18' shielded enclosure. The chamber is lined with Toyo Ferrite Grid Absorber, model number FFG-1000. The ferrite tile grid is 101 x 101 x 19mm thick and weighs approximately 550 grams. These tiles are mounted on steel panels and installed directly on the inner walls of the chamber.

The turntable is 5' in diameter and is located 5'6" from the back wall of the chamber. The chamber is grounded via 1 - 8' copper ground rod, installed at the center of the back wall, it is bound to the ground plane using 3/4" stainless steel braided cable.

The turntable is all steel, flush mounted EMCO Model 1060 installed in an all steel frame. The table is remotely operated from inside the control room located 25' from the range. The turntable is electrically bonded to the surrounding ground plane via steel fingers installed on the edge of the turn table. The steel fingers make constant contact with the ground plane during operation.

Behind the turntable is a 3' x 6' x 4' deep shielded pit used for support equipment if necessary. The pit is equipped with 1 - 4" PVC chase from the turntable to the pit that allows for cabling to the EUT if necessary. The underside of the turntable can be accessed from the pit so cables can be supplied to the EUT from the pit.

The chamber rear wall is covered with a mixture of Siepel pyramidal absorber. The side walls of the chamber are partially covered with Siepel pyramidal absorber.

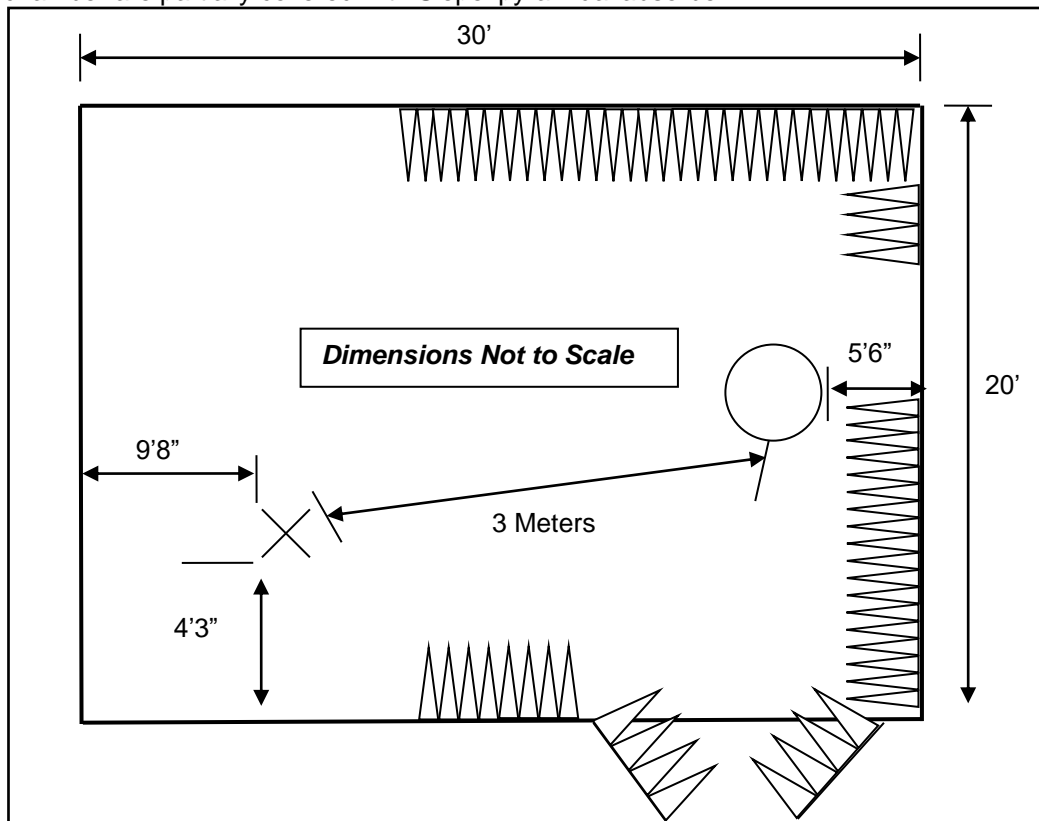

Figure 2.3.1-1: Semi-Anechoic Chamber Test Site – Chamber A

2.3.2 Semi-Anechoic Chamber Test Site – Chamber B

The Semi-Anechoic Chamber Test Site consists of a 20'W x 30'L x 20'H shielded enclosure. The chamber is lined with ETS-Lindgren Ferrite Absorber, model number FT-1500. The ferrite tile 600 mm x 600 mm (2.62 in x 23.62 in) panels and are mounted directly on the inner walls of the chamber shield.

The specular regions of the chamber are lined with additional ETS-Lindgren PS-600 hybrid absorber to extend its frequency range up to 18GHz and beyond.

The turntable is a 2m ETS-Lindgren Model 2170 and installed off the center axis is located 5'6" from the back wall of the chamber. The chamber is grounded via 1 - 8' copper ground rod, installed at the center of the back wall, it is bound to the shield using #8 solid copper wire.

The antenna mast is an EMCO 1060 and is remotely controlled from the control room for both antenna height and polarization.

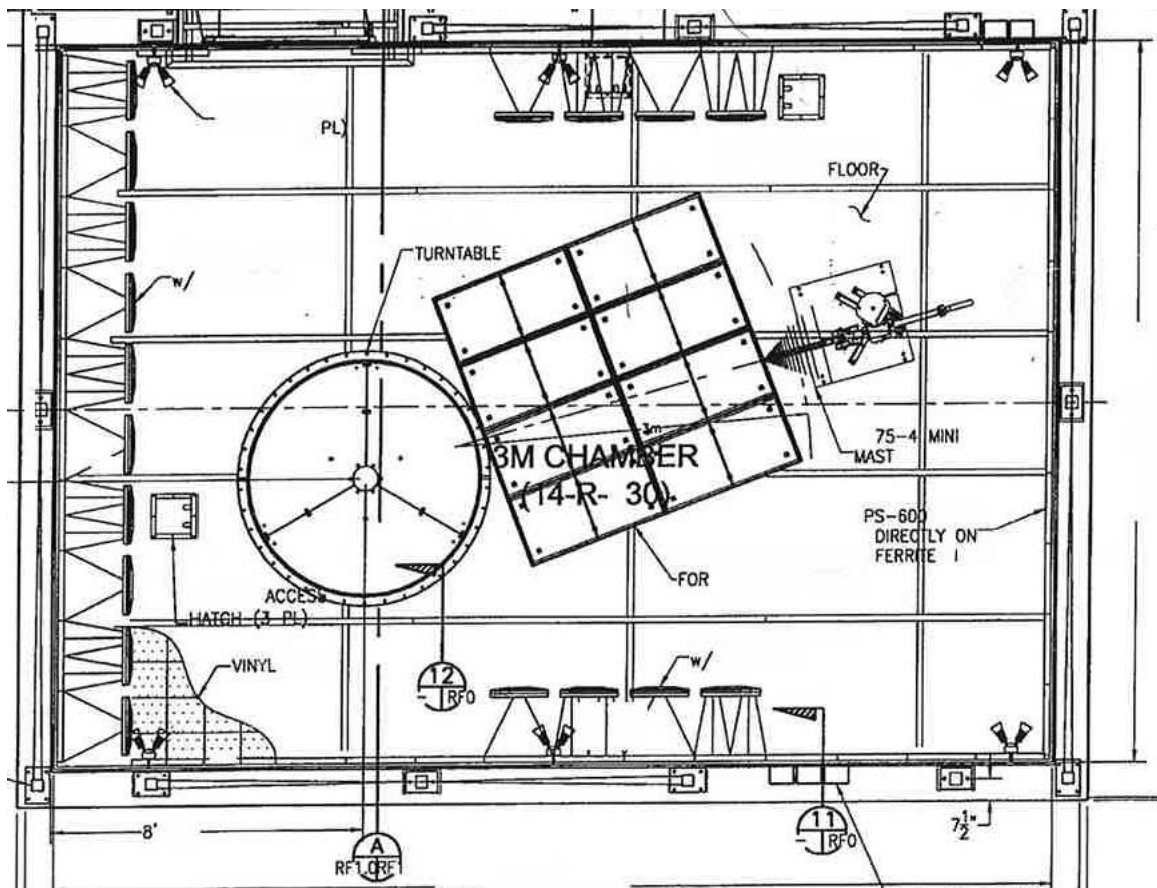

Figure 2.3.2-1: Semi-Anechoic Chamber Test Site – Chamber B

2.4 Conducted Emissions Test Site Description

2.4.1 Conducted Emissions Test Site

The AC mains conducted EMI site is located in the main EMC lab. It consists of a 12' x 10' horizontal coupling plane (HCP) as well as a 12'x8' vertical coupling plane (VCP). The HCP is constructed of 4' x 10' sheets of particle board sandwiched by galvanized steel sheets. These panels are bonded using 11AWG 1/8" x 2" by 10' galvanized sheet steel secured to the panels via by screws. The VCP is constructed of three 4'x8' sheets of 11AWG solid aluminum.

The HCP and VCP are electrically bonded together using 1"x1" angled aluminum secured with screws.

The site is of sufficient size to test tabletop and floor standing equipment in accordance with section 6.1.4 of ANSI C63.10.

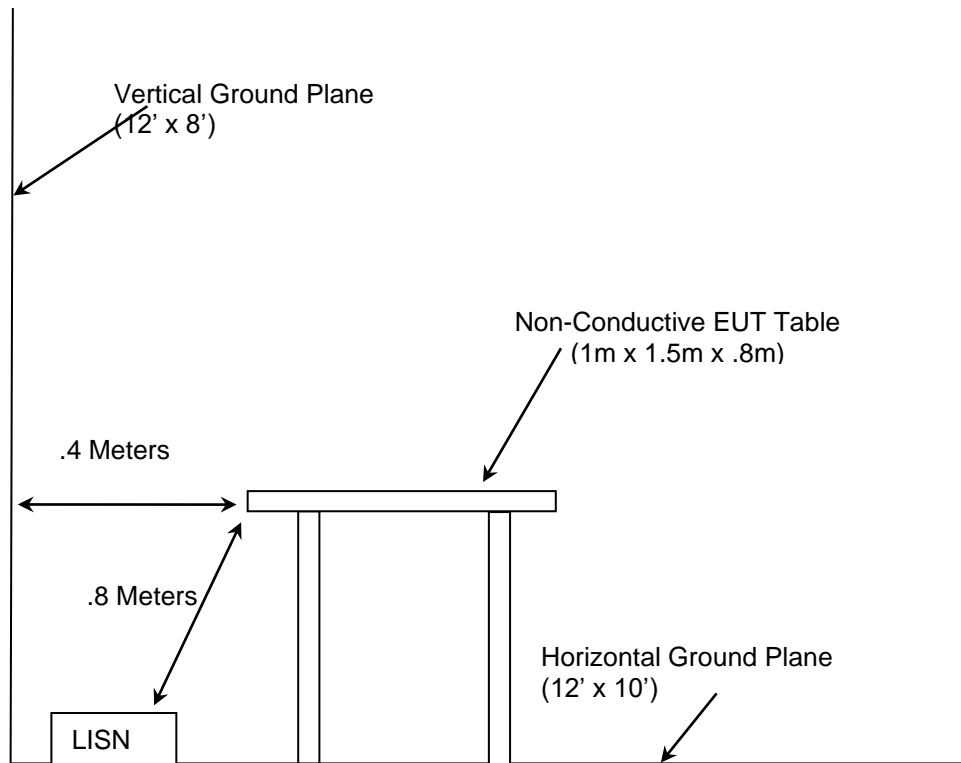

Figure 2.4.1-1: AC Mains Conducted EMI Site

3 APPLICABLE STANDARD REFERENCES

The following standards were used:

- ❖ ANSI C63.10-2013: American National Standard of Procedures for Compliance Testing of Unlicensed Wireless Devices.
- ❖ US Code of Federal Regulations (CFR): Title 47, Part 2, Subpart J: Equipment Authorization Procedures, 2020
- ❖ US Code of Federal Regulations (CFR): Title 47, Part 15, Subpart C: Radio Frequency Devices, Intentional Radiators, 2020
- ❖ Innovation, Science and Economic Development Canada Radio Standards Specification: RSS-210 – Licence-Exempt Radio Apparatus: Category I Equipment, Issue 10, December 2019
- ❖ Innovation, Science and Economic Development Canada Radio Standards Specification: RSS-GEN – General Requirements for Compliance of Radio Apparatus, Issue 5, April 2018, Amendment March 2019

4 LIST OF TEST EQUIPMENT

The calibration interval of test equipment is annually or the manufacturer's recommendations. Where the calibration interval deviates from the annual cycle based on the instrument manufacturer's recommendations, it shall be stated below.

Table 4-1: Test Equipment

Asset ID	Manufacturer	Model	Equipment Type	Serial Number	Last Calibration Date	Calibration Due Date
22	Hewlett Packard	8449B	High Frequency Pre-Amp	3008A00526	07/11/2018	07/11/2020
213	TEC	PA 102	Amplifier	44927	7/22/2019	7/22/2020
267	Hewlett Packard	N1911A	Power Meter	MY45100129	7/26/2019	7/26/2021
268	Hewlett Packard	N1921A	Power Sensor	MY45240184	7/26/2019	7/26/2021
324	ACS	Belden	Conducted EMI Cable	8214	3/19/2019	3/19/2020
329	A.H.Systems	SAS-571	Horn Antenna	721	8/27/2019	8/27/2021
331	Microwave Circuits	H1G513G1	Microwave Bandpass Filter	31417	5/31/2019	5/31/2020
628	EMCO	6502	Active Loop Antenna 10kHz-30MHz	9407-2877	2/11/2019	2/11/2021
813	PMM	9010	EMI Receiver; RF Input 50ohm; 10Hz-50MHz; 10Hz-30MHz	697WW30606	02/25/2019	02/25/2020
819	Rohde & Schwarz	ESR26	EMI Test Receiver	101345	11/1/2018	5/1/2020
851	TUV ATLANTA	FMC0101951-100CM	ASAC Cable Set Consisting of 566, 619, and 564	N/A	10/1/2019	10/1/2020
852	Teseq	CBL 6112D	Bilog Antenna; Attenuator	51617	10/15/2018	10/15/2020
628	EMCO	6502	Active Loop Antenna 10kHz-30MHz	9407-2877	2/11/2019	2/11/2021
3010	Rohde & Schwarz	ENV216	Two-Line V-Network	3010	7/10/2019	7/10/2020

NOTE: All test equipment was used only during active calibration cycles.

5 SUPPORT EQUIPMENT

Table 5-1: Support Equipment

Item	Equipment Type	Manufacturer	Model Number	Serial Number
1	Triple output DC power supply	Hewlett Packard	E3630A	KR64308603

Table 5-2: Cable Description

Item	Cable Type	Length	Shield	Termination
A	DC Wires	180cm	No	1 - EUT
B	AC input	180cm	Yes	1 - AC

6 EQUIPMENT UNDER TEST SETUP BLOCK DIAGRAM

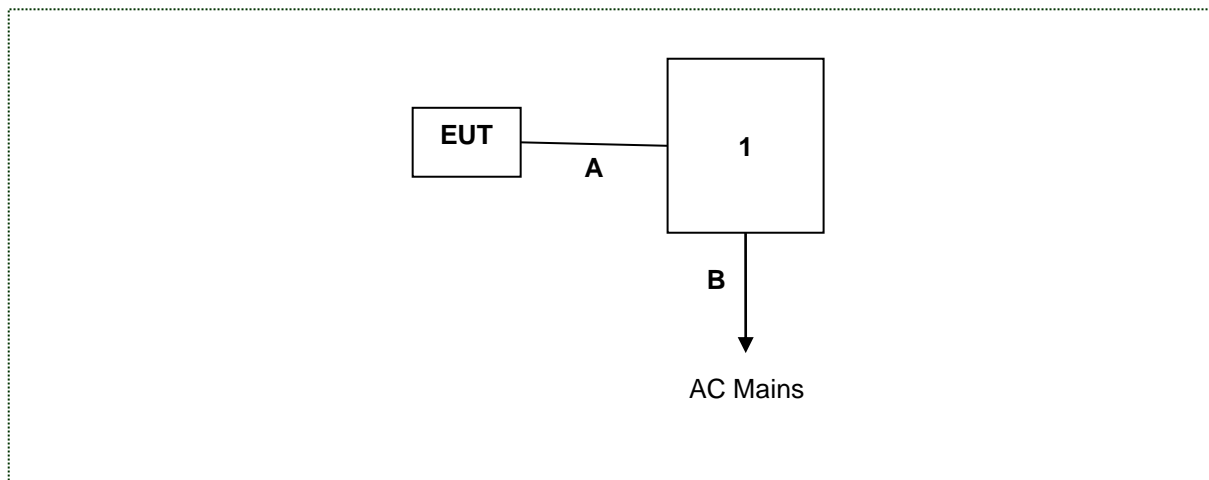

Figure 6-1: Test Setup Block Diagram

7 SUMMARY OF TESTS

Along with the tabular data shown below, plots were taken of all signals deemed important enough to document.

7.1 Antenna Requirement – FCC 15.203

The antenna is a Wire Antenna with 0.0dBi gain and is permanently attached to the board, therefore satisfying the requirements of Section 15.203.

7.2 Power Line Conducted Emissions – FCC 15.207, ISED Canada: RSS-Gen 8.8

7.2.1 Measurement Procedure

ANSI C63.10 section 6 was the guiding documents for this evaluation. Conducted emissions were performed from 150kHz to 30MHz with the spectrum analyzer's resolution bandwidth set to 9kHz and the video bandwidth set to 30kHz. The calculation for the conducted emissions is as follows:

Corrected Reading = Analyzer Reading + LISN Loss + Cable Loss

Margin = Corrected Reading – Applicable Limit

7.2.2 Measurement Results

The EUT is a battery powered device with no provision for connection to the public utility mains, therefore AC Power Line Conducted Emissions is not applicable.

7.3 20dB / 99% Bandwidth – FCC: Section 15.215, ISED Canada: RSS-Gen 4.6.1**7.3.1 Measurement Procedure**

The span of the spectrum analyzer display was set between two times and five times the occupied bandwidth (OBW) of the emission. The RBW of the spectrum analyzer was set to approximately 1 % to 5 % of the OBW. The trace was set to max hold with a peak detector active. The ndB down and delta function of the analyzer was utilized to determine the 20 dB bandwidth of the emission.

The occupied bandwidth measurement function of the spectrum analyzer was used to measure the 99% bandwidth. The span of the analyzer was set to capture all products of the modulation process, including the emission sidebands. The resolution bandwidth was set to 1% to 5% of the occupied bandwidth. The video bandwidth was set to 3 times the resolution bandwidth. A peak detector was used.

7.3.2 Measurement Results

Performed by: Chris Gormley

Table 7.3.2-1: 20dB / 99% Bandwidth

Frequency [MHz]	20dB Bandwidth [kHz]	99% Bandwidth [kHz]	Mode
902.3	41.3576	42.6034	1
915	41.2118	42.5752	1
927.8	41.1690	42.5612	1
902.2	88.4042	86.0364	2
915	88.3341	86.1379	2
927.8	88.2637	86.0286	2

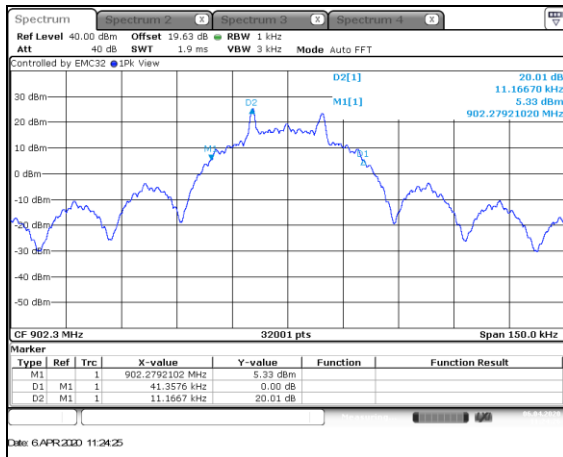

Figure 7.3.2-1: 20dB BW Low Channel – 19.2kbps

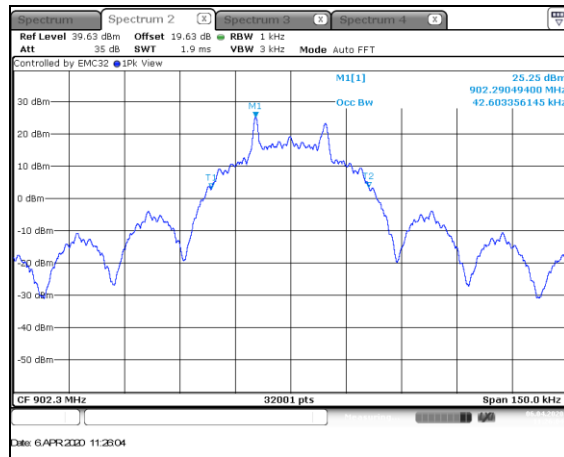

Figure 7.3.2-2: 99% BW Low Channel – 19.2kbps

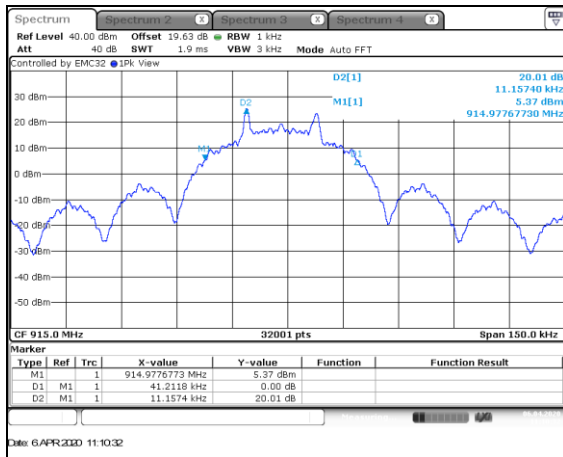

Figure 7.3.2-3: 20dB BW Middle Channel – 19.2kbps

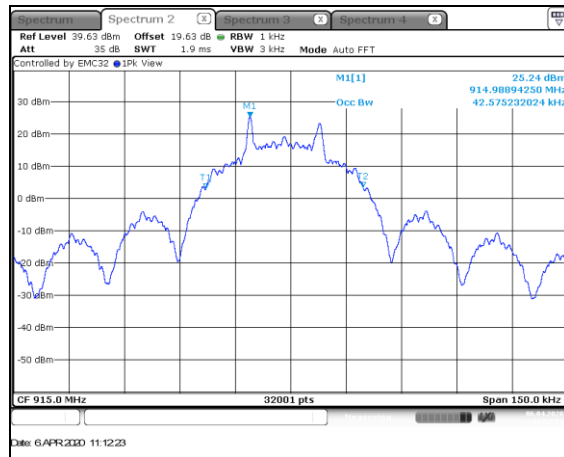

Figure 7.3.2-4: 99% BW Middle Channel – 19.2kbps

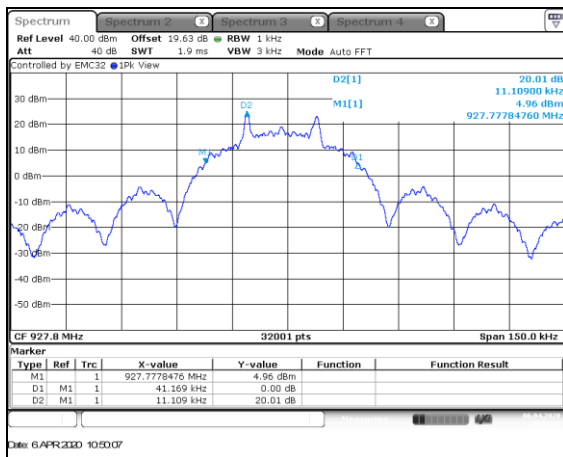

Figure 7.3.2-5: 20dB BW High Channel – 19.2kbps

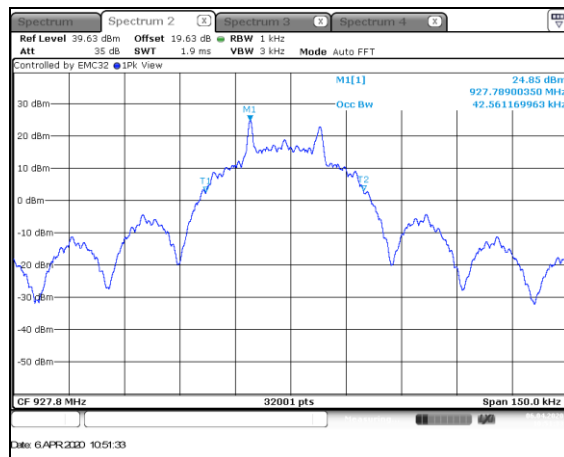

Figure 7.3.2-6: 99% BW High Channel – 19.2kbps

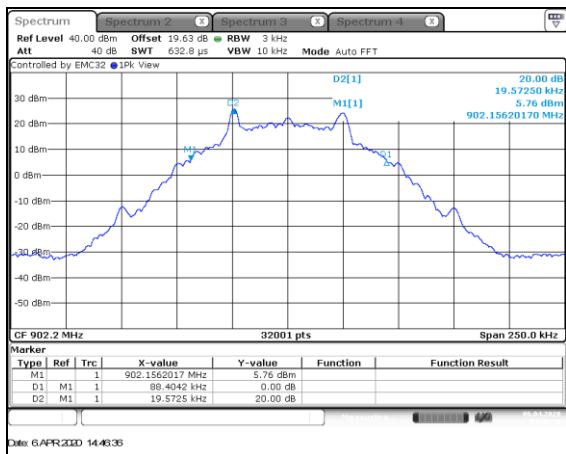

Figure 7.3.2-7: 20dB BW Low Channel – 50kbps

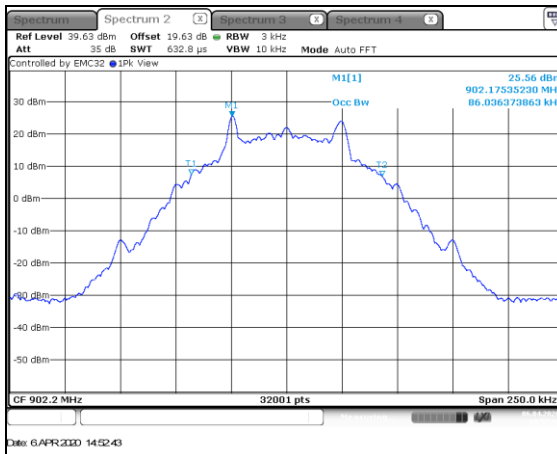

Figure 7.3.2-8: 99% BW Low Channel – 50kbps

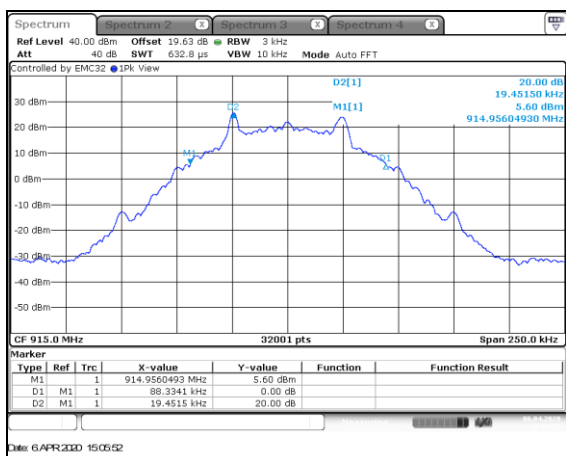

Figure 7.3.2-9: 20dB BW Middle Channel - 50kbps

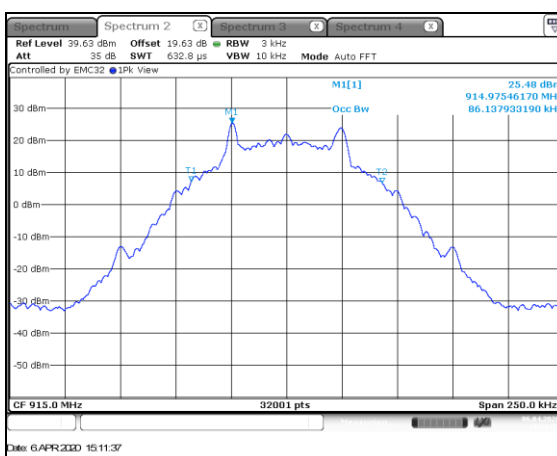

Figure 7.3.2-10: 99% BW Middle Channel – 50kbps

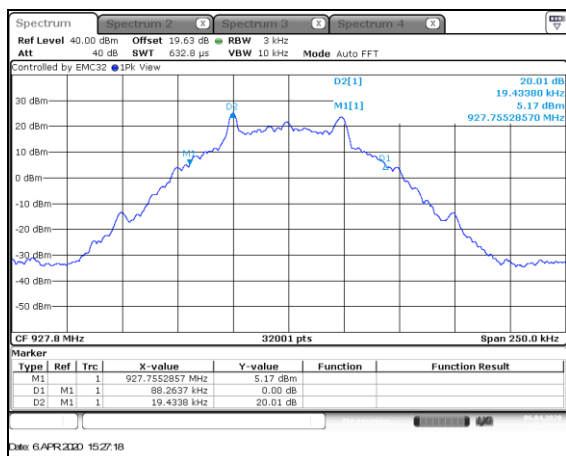

Figure 7.3.2-11: 20dB BW High Channel – 50kbps

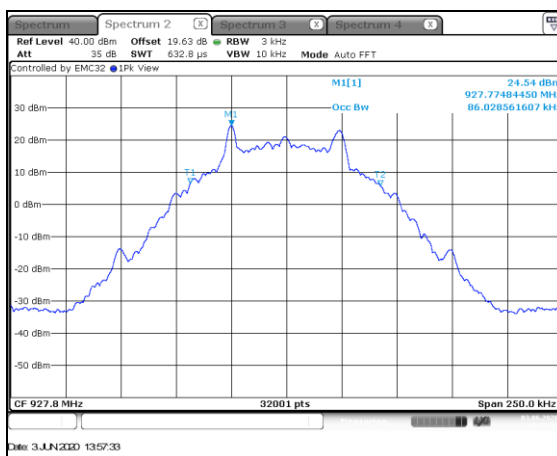

Figure 7.3.2-12: 99% BW High Channel – 50kbps

7.4 Fundamental Field Strength – FCC: Section 15.249(a), ISED Canada: RSS-210 B.10

7.4.1 Measurement Procedure

The EUT was rotated through 360° and the receive antenna height was varied from 1m to 4m so that the maximum radiated emissions level would be detected. Quasi-peak measurements were made with RBW and VBW of 120 kHz and 300 kHz respectively.

7.4.2 Measurement Results

Performed By: Christopher O'Steen

Table 7.4.2-1: Fundamental Field Strength – Mode 1

Frequency (MHz)	Level (dBuV)		Antenna Polarity (H/V)	Correction Factors (dB)	Corrected Level (dBuV/m)		Limit (dBuV/m)		Margin (dB)	
	pk	Qpk/Avg			pk	Qpk/Avg	pk	Qpk/Avg	pk	Qpk/Avg
Metal Enclosure										
902.3		76.50	H	2.54	-----	79.04	-----	94.0	-----	14.9
902.3		87.90	V	2.54	-----	90.44	-----	94.0	-----	3.5
915		78.70	H	2.56	-----	81.26	-----	94.0	-----	12.7
915		90.00	V	2.56	-----	92.56	-----	94.0	-----	1.4
927.8		76.00	H	2.62	-----	78.62	-----	94.0	-----	15.4
927.8		89.80	V	2.62	-----	92.42	-----	94.0	-----	1.6
Plastic Enclosure										
902.3		80.20	H	2.54	-----	82.74	-----	94.0	-----	11.2
902.3		86.02	V	2.54	-----	88.56	-----	94.0	-----	5.4
915		77.80	H	2.56	-----	80.36	-----	94.0	-----	13.6
915		85.80	V	2.56	-----	88.36	-----	94.0	-----	5.6
927.8		79.40	H	2.62	-----	82.02	-----	94.0	-----	12.0
927.8		86.10	V	2.62	-----	88.72	-----	94.0	-----	5.3

Table 7.4.2-2: Fundamental Field Strength – Mode 2

Frequency (MHz)	Level (dBuV)		Antenna Polarity (H/V)	Correction Factors (dB)	Corrected Level (dBuV/m)		Limit (dBuV/m)		Margin (dB)	
	pk	Qpk/Avg			pk	Qpk/Avg	pk	Qpk/Avg	pk	Qpk/Avg
Metal Enclosure										
902.2	-----	71.00	H	2.54	-----	73.54	-----	94.0	-----	20.4
902.2	-----	88.50	V	2.54	-----	91.04	-----	94.0	-----	2.9
915	-----	77.50	H	2.56	-----	80.06	-----	94.0	-----	13.9
915	-----	89.51	V	2.56	-----	92.07	-----	94.0	-----	1.9
927.8	-----	73.10	H	2.62	-----	75.72	-----	94.0	-----	18.3
927.8	-----	88.30	V	2.62	-----	90.92	-----	94.0	-----	3.1
Plastic Enclosure										
902.2	-----	76.00	H	2.54	-----	78.54	-----	94.0	-----	15.4
902.2	-----	87.30	V	2.54	-----	89.84	-----	94.0	-----	4.1
915	-----	77.20	H	2.56	-----	79.76	-----	94.0	-----	14.2
915	-----	86.50	V	2.56	-----	89.06	-----	94.0	-----	4.9
927.8	-----	77.61	H	2.62	-----	80.23	-----	94.0	-----	13.7
927.8	-----	86.10	V	2.62	-----	88.72	-----	94.0	-----	5.3

7.5 Radiated Spurious Emissions – FCC: Section 15.249(a)(d)(e), ISED Canada: RSS-210 B.10

7.5.1 Measurement Procedure

Section 15.33(a)(4) specifies, if the intentional radiator contains a digital device, regardless of whether this digital device controls the functions of the intentional radiator or the digital device is used for additional control or function purposes other than to enable the operation of the intentional radiator, the frequency range shall be investigated up to frequency specified in 15.33(b)(1) for unintentional radiators. The upper frequency range for the digital device is 18GHz which greater than the 10th harmonic of the fundamental frequency. The upper frequency range measured was 18GHz.

Measurements below 30MHz were performed in a semi-anechoic chamber with a 3 meter separation distance between the EUT and measurement antenna. The EUT was rotated 360° and the loop antenna rotated through three orthogonal axis. The magnetic loop receiving antenna was positioned with its lowest point 1 meter above the ground.

The spectrum analyzer's resolution and video bandwidth was set to 200 Hz and 1 kHz respectively for frequencies below 150 kHz and 9 kHz and 30 kHz respectively for frequencies above 150 kHz and below 30 MHz. For measurements in the frequency bands 9-90 kHz and 110-490 kHz, an peak detector was used. When average measurements are specified, the peak emissions were also compared to a limit corresponding to 20 dB above the maximum permitted average limit according to Part 15.35. All other emissions were measured using a peak detector.

Measurements above 30 MHz were performed in a semi-anechoic chamber with a 3 meter separation distance between the EUT and measurement antenna. The EUT was rotated through 360° and the receive antenna height was varied from 1m to 4m so that the maximum radiated emissions level would be detected. For frequencies below 1000 MHz, quasi-peak measurements were made using a resolution bandwidth (RBW) of 120 kHz and a video bandwidth (VBW) of 300 kHz. For frequencies above 1000 MHz, peak and average measurements were made using a resolution bandwidth (RBW) of 1 MHz and a video bandwidth (VBW) of 3 MHz. Prescan plots were collected at a horizontal measurement distance of 1 meter. See Appendix A for more information.

For measurements of fundamental emissions where average measurements are specified, the spectrum analyzer's resolution bandwidth (RBW) was adjusted equal to or greater than the emission bandwidth (EBW).

7.5.1.1 Distance Correction for Measurements Below 30 MHz – Part 15.31

Radiated measurements were performed at a distance closer than 300 meters and 30m as required, according to Part 15.209. Therefore a correction factor was applied to account for propagation loss at the specified distance. The propagation loss was determined by using the square of an inverse linear distance extrapolation factor (40dB/decade) according to 15.31. A sample calculation of the distance correction factor is shown below for limits expressed at a 300m measurement distance and a 30m measurement distance.

$$\begin{aligned}\text{Distance correction factor (300m Specified Test Distance)} &= 40 \cdot \text{Log} (\text{Test Distance}/300) \\ &= 40 \cdot \text{Log} (3/300) \\ &= - 80 \text{ dB}\end{aligned}$$

$$\begin{aligned}\text{Distance correction factor (30m Specified Test Distance)} &= 40 \cdot \text{Log} (\text{Test Distance}/30) \\ &= 40 \cdot \text{Log} (3/30) \\ &= - 40 \text{ dB}\end{aligned}$$

7.5.1.2 Measurement Results

Performed by: Christopher O'Steen

Table 7.5.1.2-1: Radiated Spurious Emissions – Metal Antenna Sleeve – 19.2kbps

Frequency (MHz)	Level (dBuV)		Antenna Polarity (H/V)	Correction Factors (dB)	Corrected Level (dBuV/m)		Limit (dBuV/m)		Margin (dB)	
	pk	Qpk/Avg			pk	Qpk/Avg	pk	Qpk/Avg	pk	Qpk/Avg
Low Channel										
1804.6	47.60	36.10	H	-1.81	45.79	34.29	74.0	54.0	28.2	19.7
1804.6	49.80	37.20	V	-1.81	47.99	35.39	74.0	54.0	26.0	18.6
3609.2	48.50	37.10	H	2.39	50.89	39.49	74.0	54.0	23.1	14.5
3609.2	50.80	38.70	V	2.39	53.19	41.09	74.0	54.0	20.8	12.9
Middle Channel										
1830	48.60	35.14	H	-1.57	47.03	33.57	74.0	54.0	27.0	20.4
1830	49.70	35.60	V	-1.57	48.13	34.03	74.0	54.0	25.9	20.0
3660	48.60	35.21	H	2.56	51.16	37.77	74.0	54.0	22.8	16.2
3660	50.10	36.94	V	2.56	52.66	39.50	74.0	54.0	21.3	14.5
High Channel										
1855.6	48.10	34.70	H	-1.33	46.77	33.37	74.0	54.0	27.2	20.6
1855.6	49.70	36.70	V	-1.33	48.37	35.37	74.0	54.0	25.6	18.6
3711.2	48.10	36.50	H	2.72	50.82	39.22	74.0	54.0	23.2	14.8
3711.2	49.00	37.40	V	2.72	51.72	40.12	74.0	54.0	22.3	13.9

Table 7.5.1.2-2: Radiated Spurious Emissions – Plastic Antenna Sleeve – 19.2kbps

Frequency (MHz)	Level (dBuV)		Antenna Polarity (H/V)	Correction Factors (dB)	Corrected Level (dBuV/m)		Limit (dBuV/m)		Margin (dB)	
	pk	Qpk/Avg			pk	Qpk/Avg	pk	Qpk/Avg	pk	Qpk/Avg
Low Channel										
1804.6	48.30	34.80	H	-1.81	46.49	32.99	74.0	54.0	27.5	21.0
1804.6	50.10	36.20	V	-1.81	48.29	34.39	74.0	54.0	25.7	19.6
3609.2	48.10	36.40	H	2.39	50.49	38.79	74.0	54.0	23.5	15.2
3609.2	46.50	35.10	V	2.39	48.89	37.49	74.0	54.0	25.1	16.5
Middle Channel										
1830	49.50	35.50	H	-1.57	47.93	33.93	74.0	54.0	26.1	20.1
1830	49.30	36.40	V	-1.57	47.73	34.83	74.0	54.0	26.3	19.2
3660	49.40	36.70	H	2.56	51.96	39.26	74.0	54.0	22.0	14.7
3660	47.90	34.70	V	2.56	50.46	37.26	74.0	54.0	23.5	16.7
High Channel										
1855.6	47.70	34.40	H	-1.33	46.37	33.07	74.0	54.0	27.6	20.9
1855.6	47.80	34.20	V	-1.33	46.47	32.87	74.0	54.0	27.5	21.1
3711.2	46.70	34.90	H	2.72	49.42	37.62	74.0	54.0	24.6	16.4
3711.2	48.10	35.80	V	2.72	50.82	38.52	74.0	54.0	23.2	15.5

7.5.2 Sample Calculation:

$$R_C = R_U + CF_T$$

Where:

 $CF_T =$ Total Correction Factor (AF+CA+AG)-DC (Average Measurements Only) $R_U =$ Uncorrected Reading $R_C =$ Corrected Level $AF =$ Antenna Factor $CA =$ Cable Attenuation $AG =$ Amplifier Gain $DC =$ Duty Cycle Correction Factor**Example Calculation: Quasi-Peak – Metal Antenna Sleeve – Mode 1/2 Middle Channel**Corrected Level: $90.0 + 2.56 = 92.56\text{dBuV}$ Margin: $94\text{dBuV} - 92.56\text{dBuV} = 1.4\text{dB}$ **Example Calculation: Peak – Metal Antenna Sleeve – Low Channel**Corrected Level: $50.8 + 2.39 = 53.19\text{dBuV/m}$ Margin: $74\text{dBuV/m} - 53.19\text{dBuV/m} = 20.8\text{dB}$ **Example Calculation: Average – Metal Antenna Sleeve – Low Channel**Corrected Level: $38.70 + 2.39 = 41.09\text{dBuV/m}$ Margin: $54\text{dBuV/m} - 41.09\text{dBuV/m} = 12.9\text{dB}$

8 ESTIMATION OF MEASUREMENT UNCERTAINTY

The expanded laboratory measurement uncertainty figures (U_{Lab}) provided below correspond to an expansion factor (coverage factor) $k = 1.96$ which provide confidence levels of 95%.

Table 8-1: Estimation of Measurement Uncertainty

Parameter	U_{lab}
Occupied Channel Bandwidth	$\pm 0.009 \%$
RF Conducted Output Power	$\pm 0.349 \text{ dB}$
Power Spectral Density	$\pm 0.372 \text{ dB}$
Antenna Port Conducted Emissions	$\pm 1.264 \text{ dB}$
Radiated Emissions $\leq 1 \text{ GHz}$	$\pm 5.814 \text{ dB}$
Radiated Emissions $> 1 \text{ GHz}$	$\pm 4.318 \text{ dB}$
Temperature	$\pm 0.860 \text{ }^\circ\text{C}$
Radio Frequency	$\pm 2.832 \times 10^{-8}$
AC Power Line Conducted Emissions	$\pm 3.360 \text{ dB}$

9 CONCLUSION

In the opinion of TÜV SÜD the Water 520 Mi.Node/IP, manufactured by Landis+Gyr meets the requirements of the FCC's Code of Federal Regulations Part 15 Subpart C and Innovation, Science and Economic Development Canada's Radio Standards Specification RSS-210 for the tests documented in this test report.

Appendix A: Plots

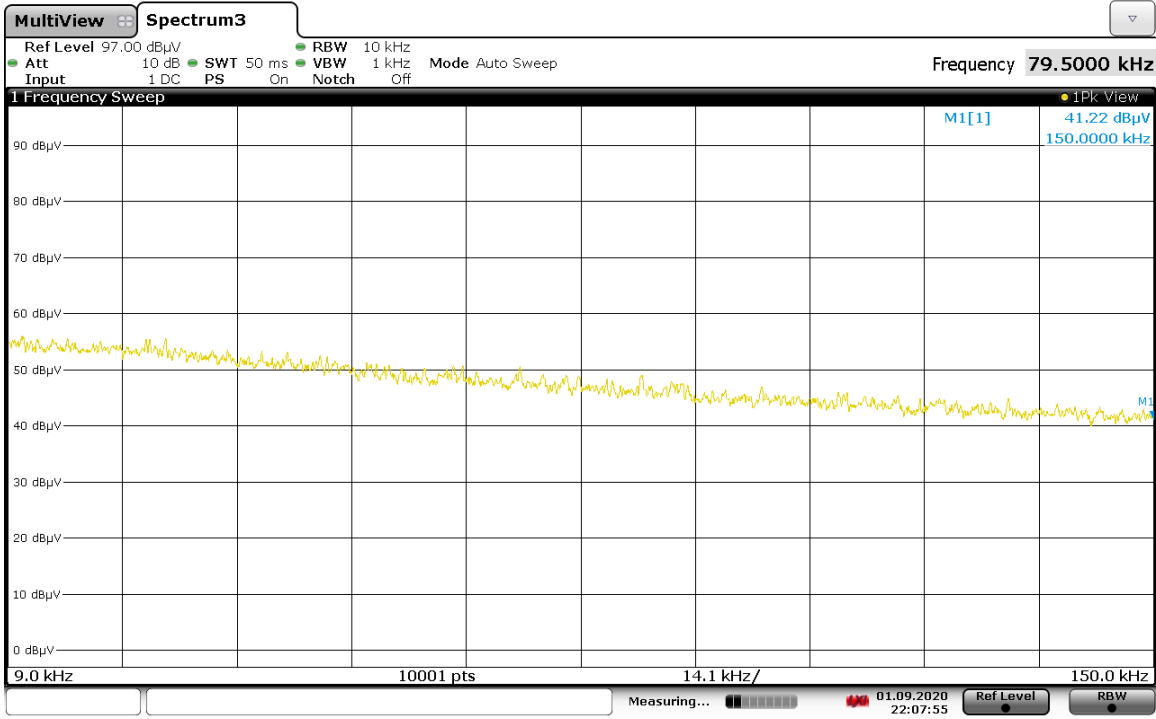
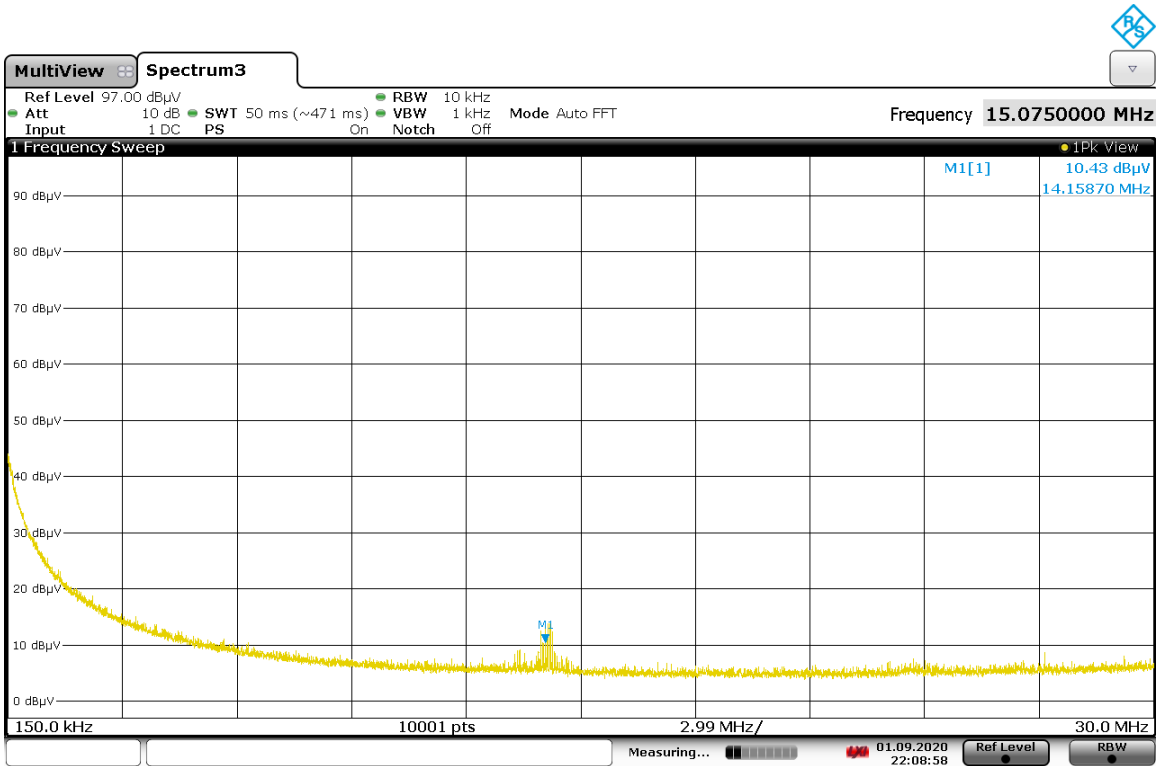

Figure A-1: Radiated Emissions – 9kHz-150kHz



Note: Emissions designated with markers are related to ambient emissions in the laboratory.

Figure A-2: Radiated Emissions – 150kHz-30MHz

Full Spectrum

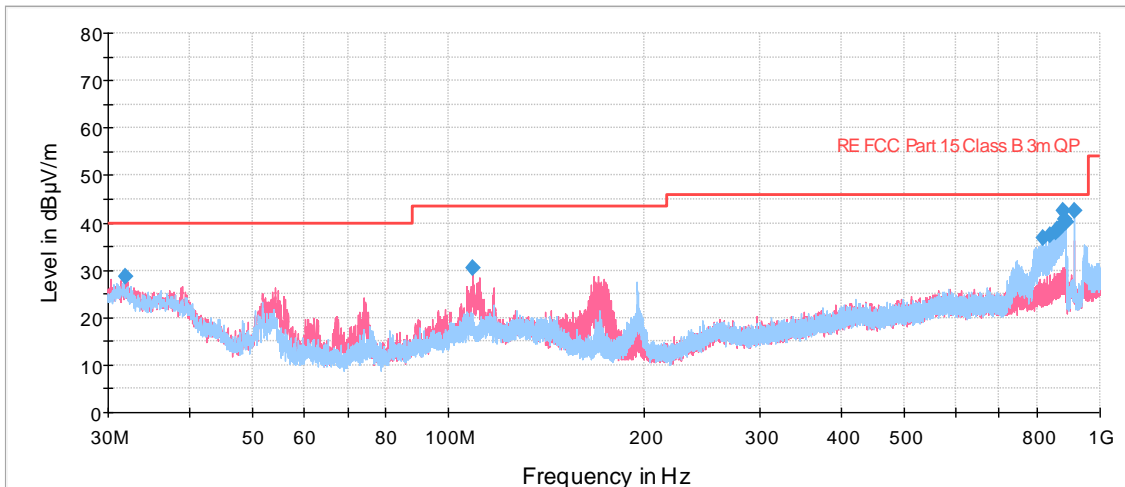

Note: Emissions designated with markers are related to the digital device or ambient emissions in the laboratory.

Figure A-3: Radiated Emissions – 30MHz-1GHz

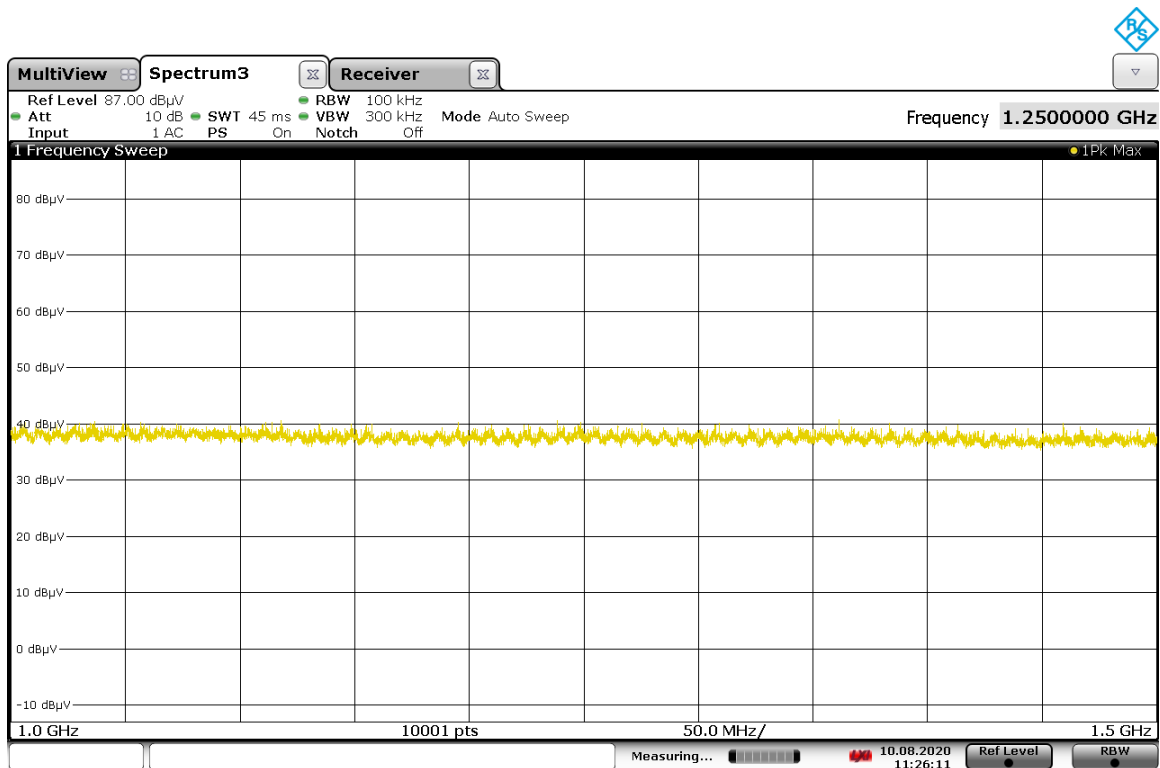

11:26:11 10.08.2020

Figure A-4: Radiated Emissions – 1GHz-1.5GHz

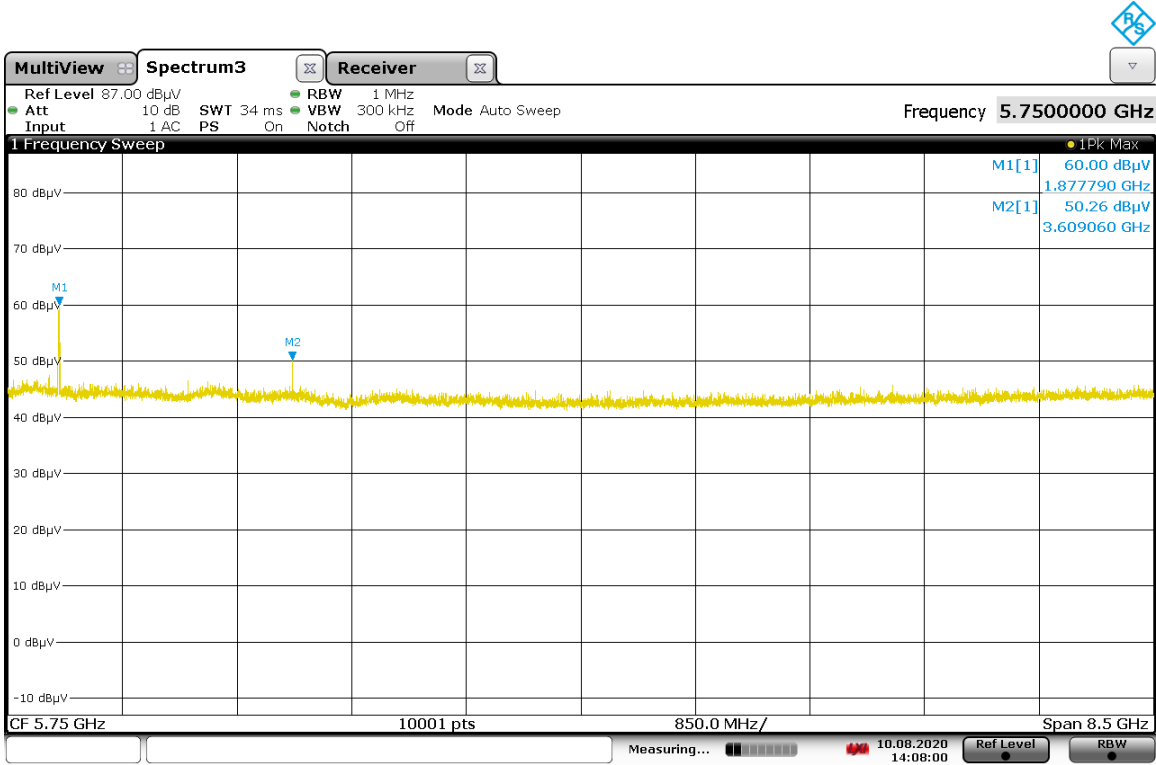

Figure A-5: Radiated Emissions – 1.5GHz-10GHz

END REPORT