

Landis+Gyr



S5-MCM0

Product FCC and IC
Compliance Manual

Rev AB



Limitation on Warranties and Liability

Information in this document is subject to change without notice. This manual or any part of it thereof may not be reproduced in any form unless permitted by contract or by written permission of Landis+Gyr.

In no event will Landis+Gyr be liable for any incidental, indirect, special, or consequential damages (including lost profits) arising out of or relating to this publication or the information contained in it, even if Landis+Gyr has been advised, knew, or should have known of the possibility of such damages.

Covered by both issued and pending patents.

For further patent information see: <https://www.landisgyr.com/about/patent-notice/>

© 2020 Landis+Gyr, Inc. | Proprietary + Confidential

Contact Us:

To provide feedback about this document, email us at ustechnicaldocumentation@landisgyr.com

Technical Support: 1-888-390-5733 | solutionsupport.na@landisgyr.com

S5-MCM0 Compliance Manual



Introduction

S5-MCM0 is a small module with a radio operating in the unlicensed sub-GHz frequency range of 902 – 928 MHz, designed to be compatible with Landis+Gyr Gridstream RF, Series 5 radios. This module is Landis+Gyr designed and is intended for integration with Landis+Gyr products or third-party products as host board. The package design conforms to the land grid array (LGA) package, with terminal pads on the bottom surface (see drawing below, measurements are in mm).

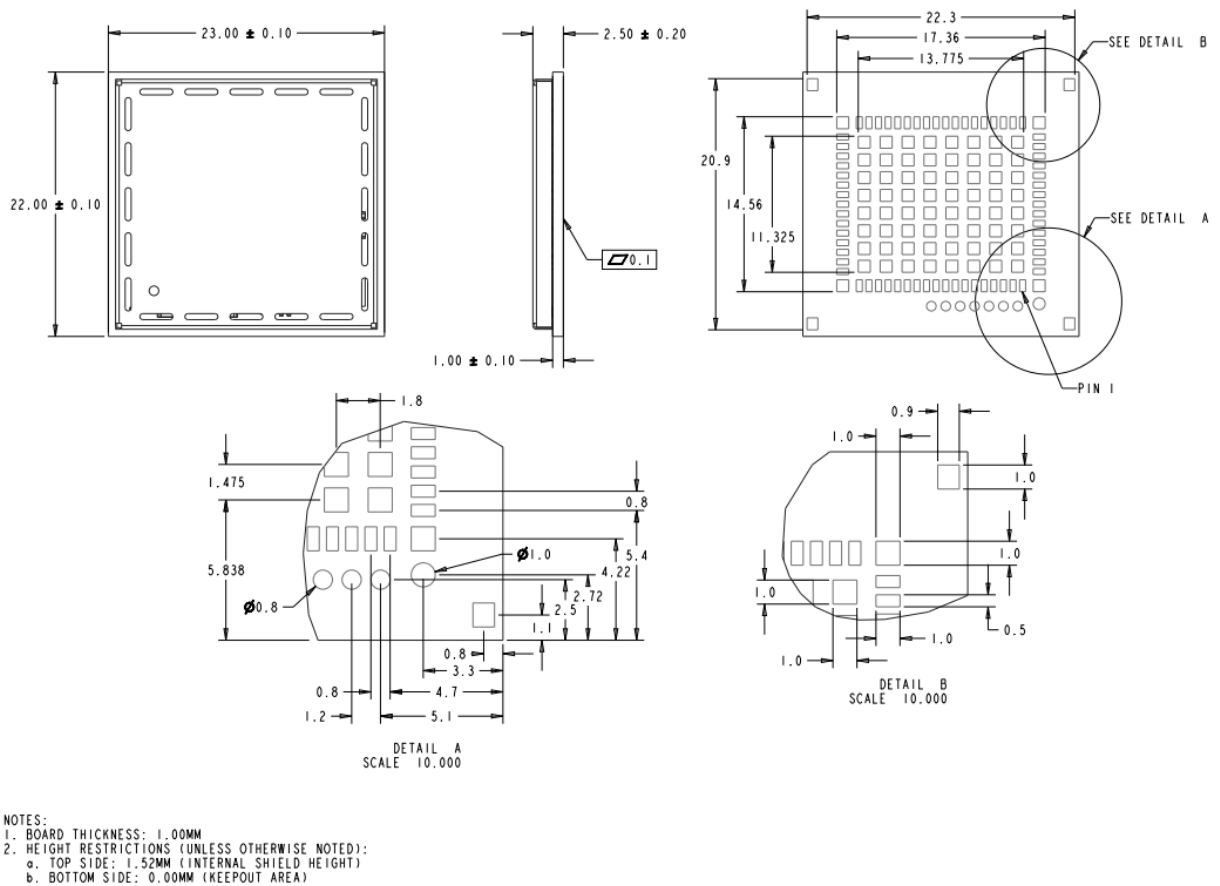

Figure 1. Size and package dimensions

The module is manufactured by a contract manufacturer, to design specifications and building materials controlled and specified by Landis+Gyr. The main components include a PCB, transceiver, frontend module, LDO, and an RF shield. Module assembly instructions are found in the document 73-2484.

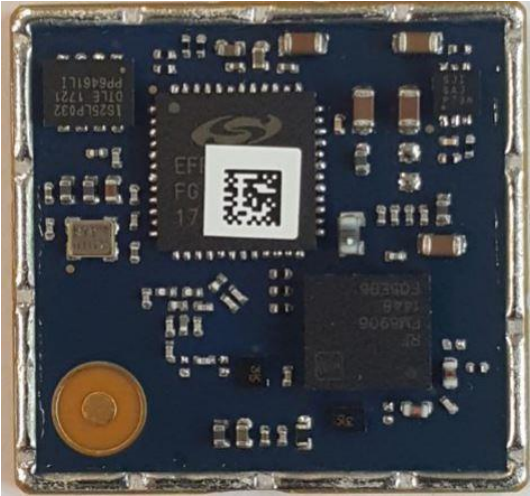

Figure 2. Top side view, RF shield removed

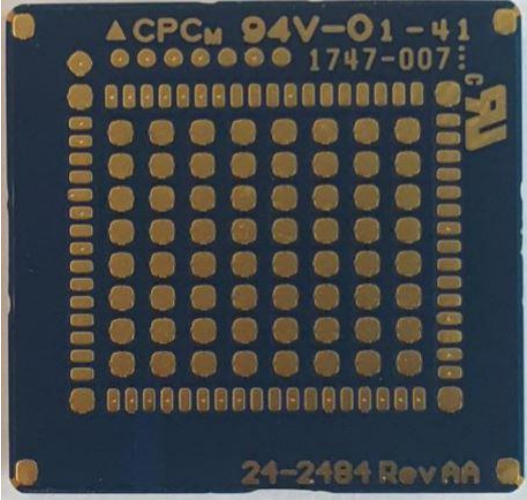

Figure 3. Bottom side view

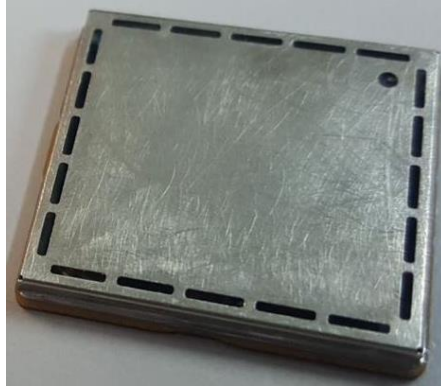

Figure 4. Top side view, with RF shield installed

An antenna is required but is not part of the module. The antenna is to be on the host board. The S5-MCM0 is certified with a PIFA (antenna) on the Gridstream RF, Series 5, I210+c host board. The PCB design file number is 24-2468, revision AE. When integrating the S5-MCM0 on a different host, if the antenna design on the host board is identical to that of the Gridstream RF, Series 5, I210+c, no additional certification effort is needed. The PCB layout and fabrication information necessary to duplicate the PIFA is provided below.

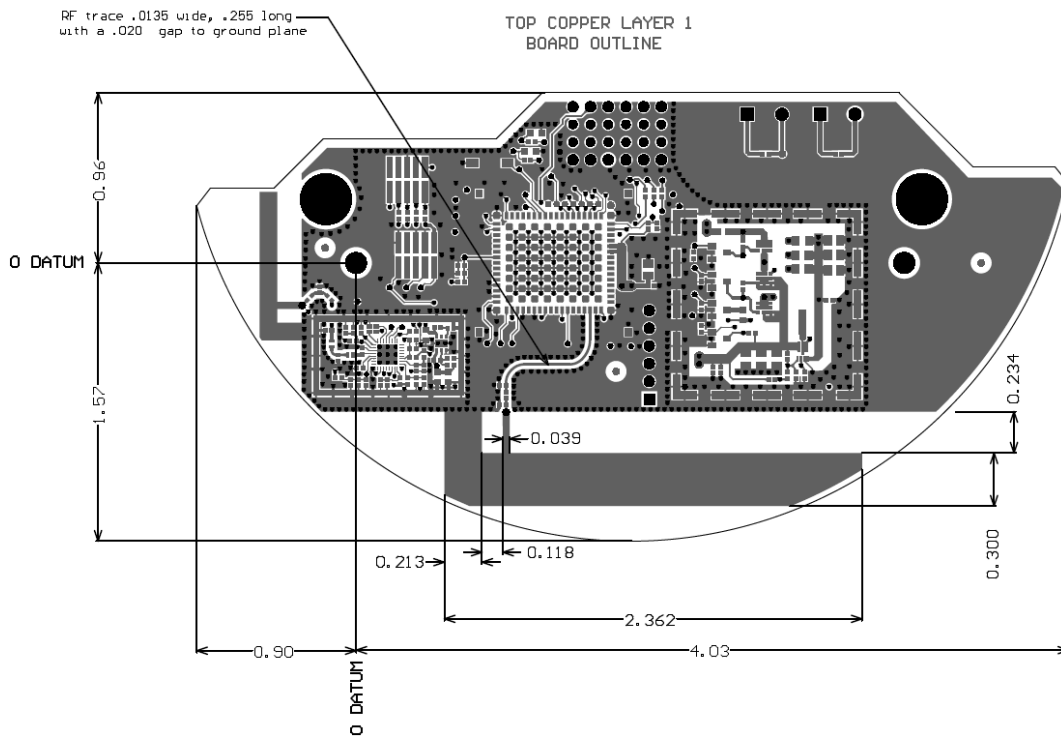

Figure 5. Top layer PIFA dimensions

The top layer copper design is shown in the figure above. The second layer, shown below, is critical for RF trace impedance control, but is not critical for the PIFA. For multiple layer PCB, the space below the top layer antenna should be kept clear of copper as shown in the figure below.

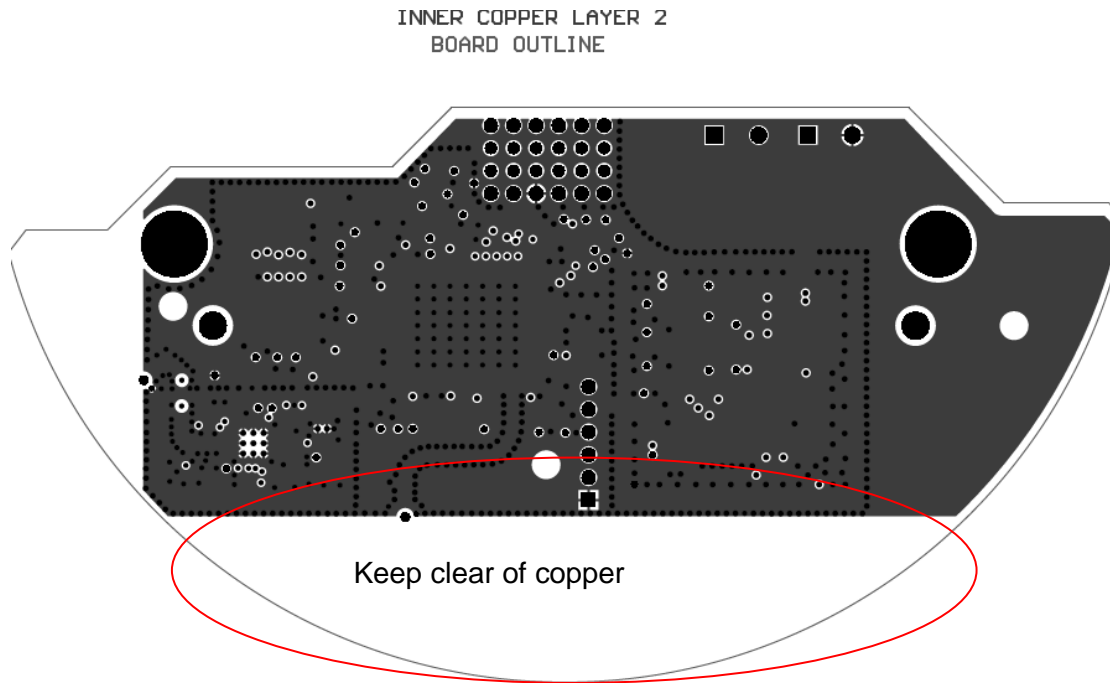

Figure 6. Inner layer design for antenna

Fabrication Specifications

1. FABRICATE IN ACCORDANCE WITH LANDIS+GYR PCB FABRICATION / QUALITY SPEC 89-1131.
2. MATERIAL OPTIONS:
FR4 MINIMUM TG 150 ROHS SAFE, DIELECTRIC CONSTANT OF 4.3 +/-0.2 @ 1 GHz ,MEET OR EXCEED UL94-V0 FLAMMABILITY.
3. CORE LAMINATE MUST CONFORM TO IPC-4101 W/ MOISTURE ABSORPTION LEVEL <=0.35% PER IPC TM 650 2.6.2.1.
LANDIS+GYR WILL TEST PCBs AT 85c AND 85% RELATIVE HUMIDITY FOR 1100 HOURS.
THE NETS WILL BE BOTH POWERED AND UNPOWERED DURING THE TESTING. PCB MUST MEET BOTH MECHANICAL AND ELECTRICAL SPECIFICATIONS AFTER TESTING AND HAVE NO SHORTED NETS, NO ORGANIC RESIDUE, NO FUNGUS GROWTH, NO DELAMINATION, AND NO CONDUCTIVE ANODIC FLAMENT (CAF) FORMATION.

4. PLATING IN HOLES SHALL BE 0.001 INCH AVERAGE WITH NO HOLE LESS THAN .0008 INCH.
5. HOLE SIZES SHOWN IN DRILL CHART ARE FINISHED HOLE SIZES AND PLATED UNLESS OTHERWISE INDICATED
6. HOLE LOCATIONS $\pm .0038$, MAX LAYER TO LAYER MISREGISTRATION SHALL BE .005
7. SOLDERMASK, GLOSSY GREEN BOTH SIDES. SILKSCREEN WHITE BOTH SIDES.
8. VENDOR TO SILKSCREEN LOGO, LOT, AND UL RATING IN SUITABLE LOCATION.
9. DRAWING IS VIEWED FROM COMPONENT OR PRIMARY SIDE.
10. FEATURE GROWTH OR REDUCTION TO BE NO GREATER THAN $\pm .002$ " OF GERBER DATA FABRICATOR SHALL ADJUST FOR MANUFACTURING PROCESS
11. UN-USED INNER LAYER PADS MAY BE REMOVED BY FABRICATOR.
12. ELECTRICAL TESTING TO BE NETLIST TEST WITH 100% COVERAGE OF NETS, INCLUDING
TESTPADS ON THE SOLDER SIDE OF PCB. PRODUCTION TEST PARAMETERS: INPUT VOLTAGE 40V MINIMUM
13. NO ADDITIONAL COPPER MARKINGS OR BALANCING SHALL BE ADDED TO THE PCB.
14. PCB SOLDER FINISH OPTIONS:
ELECTROLESS NICKEL IMMERSION GOLD (ENIG). COATING/PLATING SHALL BE
MINIMUM 0.0000028 THICKNESS GOLD OVER MINIMUM THICKNESS 0.0001" NICKEL.

NOTE: ASSUMED VALUES AND FINISHED DIMENSIONS ARE AS FOLLOWS:

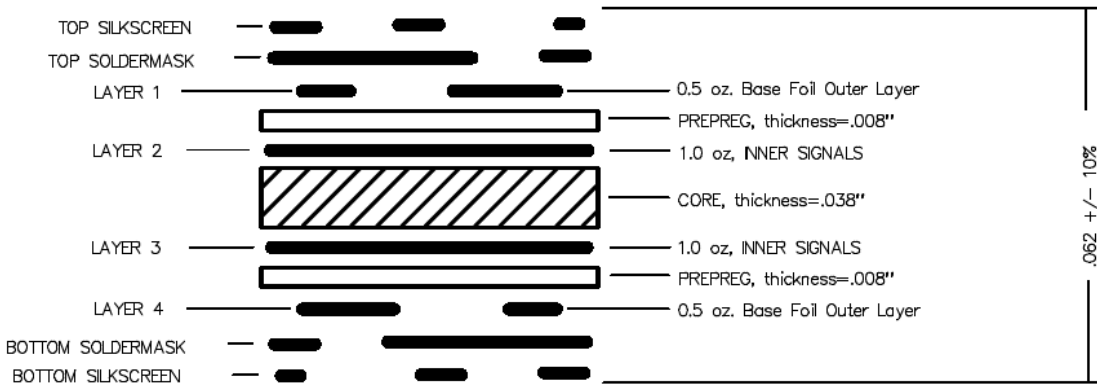

If the antenna design on the new host board deviates from the approved antenna, it would be treated as a new antenna and, therefore, will be subject to a class II permissive change application. The class II permissive change can add the new antenna to the modular approval if evaluated stand-alone (i.e. open platform such as an eval board or host PCB without enclosure) or limited to a specific host device where stand-alone testing is not feasible.

The pin-out definition of the S5-MCM0 is a Landisgyr+Gyr custom specification. For a host board to be compatible, the interface design must follow the definitions and specifications defined in the document 98-2391.

Radio Characteristics

| Hardware Capabilities | |
|---|--|
| Supply voltage range | 3.6 – 5.0 VDC |
| Supply Current | 1A minimum required for full output power |
| Clock Speed | 120 MHz |
| RAM Memory | 640 Kb |
| FLASH Memory | 2 MB + 4 MB External |
| RF Modulation | 2-FSK, 2-GFSK |
| RF Bands | Sub-GHz |
| RF Output Port (Antenna) | SMT Pin on device, 50 Ohms |
| Frequency Range | 902.2 MHz – 927.8 MHz |
| Data Rate Coverage | 9.6 – 115.2 kbps |
| Transmitter Output Power | 500 mW max |
| Receiver Sensitivity (10% PER, conducted) | 9.6kbps = -113dBm 19.2kbps = -111dBm 19.2 (0.5) kbps = -110dBm 38.4kbps = -108dBm 115.2kbs = -103dBm |

Federal Communications Commission (FCC) Compliance Notice

This device complies with Part 15 of the FCC rules. Operation is subject to the following two conditions:

1. This device may not cause harmful interference, and
2. This device must accept any interference received, including interference that may cause undesired operation.

This equipment has been tested and found to comply with the limits for a Class B digital device, pursuant to Part 15 of the FCC Rules. These limits are designed to provide reasonable protection against harmful interference in a residential installation. This equipment generates, uses, and can radiate radio frequency energy and, if not installed and used in accordance with the Instructions, may cause harmful interference to radio communications. However, there is no guarantee that interference will not occur in a particular installation. If this equipment does cause harmful interference to radio or television reception, which can be determined by turning the equipment off and on, the user is encouraged to try to correct the interference by one or more of the following measures:

- Reorient or relocate the receiving antenna.
- Increase the separation between the equipment and receiver.
- Consult Landis+Gyr or an experienced radio technician for help.



WARNING: Changes or modifications to this device not expressly approved by Landis+Gyr could void the user's authority to operate the equipment.

Industry Canada (IC) Compliance Notice

This device complies with Industry Canada license-exempt RSS standard(s). Operation is subject to the following two conditions: (1) this device may not cause interference, and (2) this device must accept any interference, including interference that may cause undesired operation of the device.

Le présent appareil est conforme aux CNR d'Industrie Canada applicables aux appareils radio exempts de licence. L'exploitation est autorisée aux deux conditions suivantes : (1) l'appareil ne doit pas produire de brouillage, et (2) l'utilisateur de l'appareil doit accepter tout brouillage radioélectrique subi, même si le brouillage est susceptible d'en compromettre le fonctionnement.

Under Industry Canada regulations, this radio transmitter may only operate using an antenna of a type and maximum (or lesser) gain approved for the transmitter by Industry Canada. To reduce potential radio interference to other users, the antenna type and its gain should be so chosen that the equivalent isotropically radiated power (e.i.r.p.) is not more than that necessary for successful communication.

Conformément à la réglementation d'Industrie Canada, le présent émetteur radio peut fonctionner avec une antenne d'un type et d'un gain maximal (ou inférieur) approuvé pour l'émetteur par Industrie Canada. Dans le but de réduire les risques de brouillage radioélectrique à l'intention des autres utilisateurs, il faut choisir le type d'antenne et son gain de sorte que la puissance isotrope rayonnée équivalente (p.i.r.e.) ne dépasse pas l'intensité nécessaire à l'établissement d'une communication satisfaisante.

RF Exposure

This equipment complies with FCC radiation exposure limits set forth for an uncontrolled environment. This equipment should be installed and operated with a minimum distance of 20 cm between the radiator and your body. This transmitter must not be co-located or operated in conjunction with any other antenna or transmitter.

Cet équipement est conforme aux limites FCC d'exposition aux radiations définies pour un environnement non contrôlé. Cet équipement doit être installé et utilisé à une distance minimale de 20cm entre le radiateur et votre corps. Cet émetteur ne doit pas être co-implantés ou exploités en conjonction avec une autre antenne ou émetteur.

FCC and IC Label Requirements

The S5-MCM0 is a modular approved radio module. The label requirement is as follows.

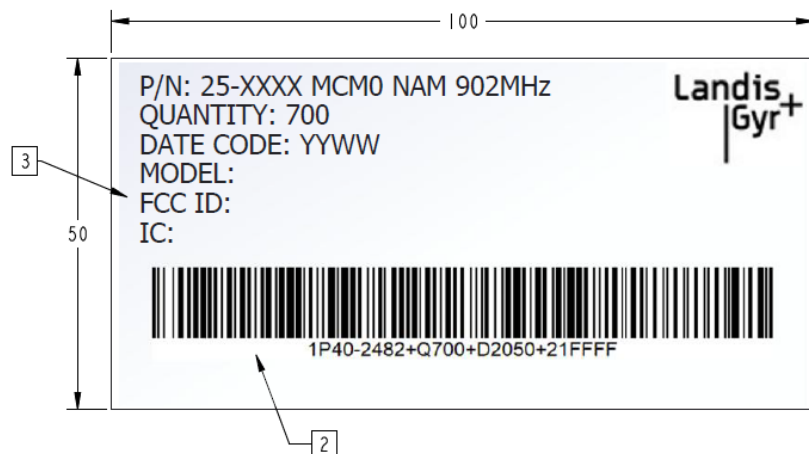

Figure 7. S5-MCM0 FCC/IC label

For the S5-MCM0, the label in Figure 5 will be populated with the FCC/IC information below.

Model: S5-MCM0
FCC ID: R7PNG0R1S7
IC: 5294A-NG0R1S7

Due to size limitation, the label is placed on the reel and packaging material containing the module.



Figure 8. Placement location of FCC/IC label

Host FCC and IC Label Requirement

In the final installation, a label with the following information must be visible on the host.

Contains FCC ID: R7PNG0R1S7

Contains IC: 5294A-NG0R1S7