



Shenzhen Certification Technology Service Co., Ltd
 2F, Building B, East Area of Nanchang Second Industrial
 Zone, Gushu 2nd Road, Bao'an District, Shenzhen
 518126, P.R. China.

TEST REPORT

FCC ID: R7F-S3

Applicant : Hame Technology Co., Limited
Address : 4F, Plant 1st, Huahan Industrial Park, Jinniu West Rd., Pingshan New District, Shenzhen, China.

Equipment under Test (EUT):

Name : Wi-Fi Disk
 Model : S3, C1, SD1, Z1

Standards : FCC PART 15, SUBPART C : 2011 (Section 15.247)

Report No. : STI130106008
Date of Test : January 10-March 07, 2013
Date of Issue : March 07, 2013

Test Result :	PASS *
----------------------	---------------

* In the configuration tested, the EUT complied with the standards specified above

Authorized Signature

(Mark Zhu)
 General Manager

The manufacture should ensure that all the products in series production are in conformity with the product sample detailed in this report.

If the product in this report is used in any configuration other than that detailed in the report, the manufacturer must ensure the new system complies with all relevant standards. Any mention of Shenzhen Certification Technology Service Co., Ltd. Or test done by Shenzhen Certification Technology Service Co., Ltd. Approvals in connection with, distribution or use of the product described in this report must be approved by Shenzhen Certification Technology Service Co., Ltd. Approvals in writing.

TABLE OF CONTENT

Description	Page
1 General Information-----	3
1.1 Description of Device (EUT)-----	3
1.2 Description of Test Facility-----	4
2 EMC Equipment List-----	4
3 Test Procedure-----	5
4 Summary of Measurement-----	6
4.1 Summary of test result-----	6
4.2 Test connection-----	6
4.3 Assistant equipment used for test-----	6
4.4 Test mode-----	7
5 Spurious Emission-----	8
5.1 Radiation Emission-----	8
6 POWER LINE CONDUCTED EMISSION-----	25
6.1 Conducted Emission Limits(15.207)-----	25
6.2 Test Setup-----	25
6.3 Test Procedure-----	26
6.4 Test Results-----	26
7 Conducted Maximum Output Power-----	29
7.1 Test limit-----	29
7.2 Test Procedure-----	29
7.3 Test Setup-----	29
7.4 Test Results-----	29
8 PEAK POWER SPECTRAL DENSITY-----	49
8.1 Test limit-----	49
8.2 Method of measurement-----	49
8.3 Test Setup-----	49
8.4 Test Results-----	50
9 6dB Bandwidth-----	57
9.1 Test limit-----	57
9.2 Method of measurement-----	57
9.3 Test Setup-----	57
9.4 Test Results-----	57
10 Band Edge Check-----	65
10.1 Test limit-----	65
10.2 Test Procedure-----	65
10.3 Test Setup-----	65
10.4 Test Result-----	65
11 Antenna Requirement-----	82
11.1 Standard Requirement-----	82
11.2 Antenna Connected Construction-----	82
11.3 Result-----	82
12 Photographs of Test Setup-----	83
13 Photographs of EUT-----	86

1 General Information

1.1 Description of Device (EUT)

Trade Name	: 
EUT	: Wi-Fi Disk
Model No.	: S3, C1, SD1, Z1
DIFF.	: Only different in appearance, the other the same. : The test model: S3.
Type of Antenna	: Built Antenna
Antenna Specification	: 1dBi
Operation Frequency	: 2412~2462MHz for 802.11b.g.n/HT20 : 2422-2452MHz for 802.11n/HT40
Channel number	: 11 for 802.11b.g.n/HT20 : 7 for 802.11n/HT40 : IEEE 802.11b: DSSS(CCK,DQPSK,DBPSK)
Modulation type	: IEEE 802.11g: OFDM(64QAM, 16QAM, QPSK, BPSK) : IEEE 802.11n :OFDM(64QAM, 16QAM, QPSK, BPSK)
Power Supply	: DC 3.7V Supply by battery : DC 5V from PC with AC 120V/60Hz adapter
Rated PF output Power	: 8.79dBm for 802.11b.g.n/HT20 (peak) : 7.91dBm for 802.11n/HT40 (peak) : 7.97dBm for 802.11b.g.n/HT20(AV) : 7.65dBm for 802.11n/HT40(AV)
Applicant	: Hame Technology Co., Limited
Address	: 4F, Plant 1st, Huahan Industrial Park, Jinniu West Rd., Pingshan New District, Shenzhen, China.
Manufacturer	: Hame Technology Co., Limited
Address	: 4F, Plant 1st, Huahan Industrial Park, Jinniu West Rd., Pingshan New District, Shenzhen, China.

1.2 Description of Test Facility

Shenzhen Certification Technology Service Co., Ltd.
 2F, Building B, East Area of Nanchang Second Industrial Zone,
 Gushu 2nd Road, Bao'an District, Shenzhen 518126, P.R. China
 FCC Registered No.:197647

2 EMC Equipment List

Equipment	Manufacture	Model No.	Serial No.	Last cal.	Cal Interval
3m Semi-Anechoic	ETS-LINDGREN	N/A	SEL0017	Oct. 31, 12	1Year
Spectrum analyzer	Agilent	E4443A	MY46185649	Oct. 31, 12	1Year
Receiver	R&S	ESCI	100492	Oct. 31, 12	1Year
Receiver	R&S	ESCI	101202	Oct. 31, 12	1Year
Bilog Antenna	Sunol	JB3	A121206	Feb.12, 13	1Year
Horn Antenna	EMCO	3115	640201028-06	Feb.12, 13	1Year
ETS Horn Antenna	ETS	3160	SEL0076	Feb.12, 13	1Year
Active Loop Antenna	Beijing Daze	ZN30900A	SEL0097	Oct. 31, 12	1Year
Cable	Resenberger	N/A	No.1	Oct. 31, 12	1Year
Cable	SCHWARZBECK	N/A	No.2	Oct. 31, 12	1Year
Cable	SCHWARZBECK	N/A	No.3	Oct. 31, 12	1Year
Pre-amplifier	R&S	AFS42-00101 800-25-S-42	SEL0081	Oct. 31, 12	1Year
Pre-amplifier	R&S	AFS33-1800265 0-30-8P-44	SEL0080	Oct. 31, 12	1Year

3 Test Procedure

POWER LINE CONDUCTED INTERFERENCE: The test procedure used was ANSI Standard C63.4-2003 using a 50 u H LISN. Both Lines were observed. The bandwidth of the receiver was 10kHz with an appropriate sweep speed. The ambient temperature of the EUT was 25°C with a humidity of 58%.

RADIATION INTERFERENCE: The test procedure used was ANSI Standard C63.4-2003 using a ANRITSU spectrum analyzer with a pre-selector. The analyzer was calibrated in dB above a micro volt at the output of the antenna. The resolution bandwidth was 100kHz and the video bandwidth was 300 kHz up to 1 GHz and 1 MHz with a video BW of 3MHz above 1 GHz. The ambient temperature of the EUT was 25°C with a humidity of 58%.

FORMULA OF CONVERSION FACTORS: The Field Strength at 3m was established by adding the meter reading of the spectrum analyzer (which is set to read in units of dBuV) to the antenna correction factor supplied by the antenna manufacturer and cable loss. The antenna correction factors and cable loss are stated in terms of dB. The gain of the Pre-selector was accounted for in the Spectrum Analyzer Meter Reading.

Example:

Freq (MHz) METER READING + ACF + CABLE = FS

33.20 dBuV + 10.36 dB + 0.9 dB= 44.46 dBuV/m @ 3m

ANSI STANDARD C63.4-2003 10.1.7 MEASUREMENT PROCEDURES: The EUT was placed on a table 80 cm high and with dimensions of 1m by 1.5m. The EUT was placed in the center of the table (1.5m side). The table used for radiated measurements is capable of continuous rotation. When an emission was found, the table was rotated to produce the maximum signal strength. At this point, the antenna was raised and lowered from 1m to 4m. The antenna was placed in both the horizontal and vertical planes. The situation was similar for the conducted measurement except that the table did not rotate. The EUT was setup as described in ANSI Standard C63.4-2003 10.1.7 with the EUT 40 cm from the vertical ground wall.

4 Summary of Measurement

4.1 Summary of test result

Test Item	Test Requirement	Standards Paragraph	Result
Spurious Emission	FCC PART 15 : 2011	Section 15.247&15.209	Compliance
Conduction Emission	FCC PART 15: 2011	Section 15.207	Compliance
6dB Bandwidth Test	FCC PART 15: 2011	Section 15.247	Compliance
Peak Power	FCC PART 15: 2011	Section 15.247	Compliance
Power Density	FCC PART 15: 2011	Section 15.247	Compliance
Band Edge	FCC PART 15: 2011	Section 15.247	Compliance
Antenna Requirement	FCC PART 15 : 2011	Section 15.203	Compliance

Note: The EUT has been tested as an independent unit. And Continual Transmitting in maximum power (The Notebook be used during Test)

4.2 Test connection

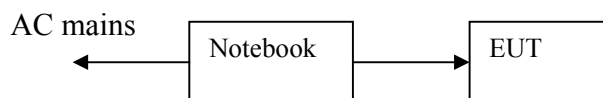

4.3 Assistant equipment used for test

Description	:	Notebook
Manufacturer	:	acer
Model No.	:	4552G

4.4 Test mode

Tested mode, channel, and data rate information			
Mode	data rate (Mbps)(see Note)	Channel	Frequency (MHz)
IEEE 802.11b	1	Low :CH1	2412
	1	Middle: CH6	2437
	1	High: CH11	2462
IEEE 802.11g	6	Low :CH1	2412
	6	Middle: CH6	2437
	6	High: CH11	2462
IEEE 802.11n/HT20	6.5	Low :CH1	2412
	6.5	Middle: CH6	2437
	6.5	High: CH11	2462
IEEE 802.11n/HT40	13.5	Low :CH3	2422
	13.5	Middle:CH6	2437
	13.5	High:CH9	2452
Note: According exploratory test, EUT will have maximum output power in those data rate. so those data rate were used for all test.			

5 Spurious Emission

5.1 Radiation Emission

5.1.1 Radiation Emission Limits(15.209)

Frequencies (MHz)	Field Strength (micorvolts/meter)	Measurement Distance (meters)
0.009~0.490	2400/F(KHz)	300
0.490~1.705	24000/F(KHz)	30
1.705~30.0	30	30
30~88	100	3
88~216	150	3
216~960	200	3
Above 960	500	3

Harmonic emissions limits comply with below 54 dBuV/m at 3m. Other emissions radiated outside of the specified frequency bands, except for harmonics, shall be attenuated by at least 50 dB below the level of the fundamental or comply with the radiated emissions limits specified in section 15.209(a) limit in the table below has to be followed.

NOTE:

- a) The tighter limit applies at the band edges.
- b) Emission Level(dB uV/m)=20log Emission Level(Uv/m)

5.1.2 Test Setup

See the next page

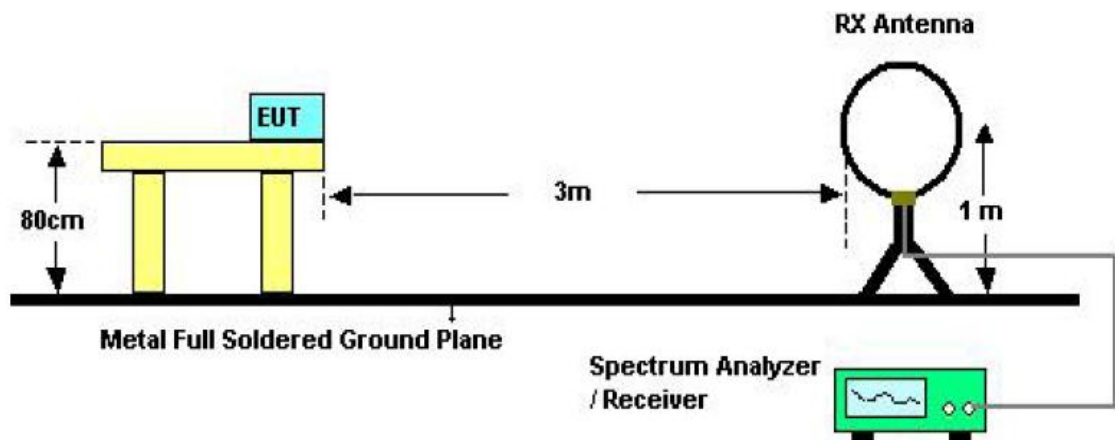

Below 30MHz Test Setup

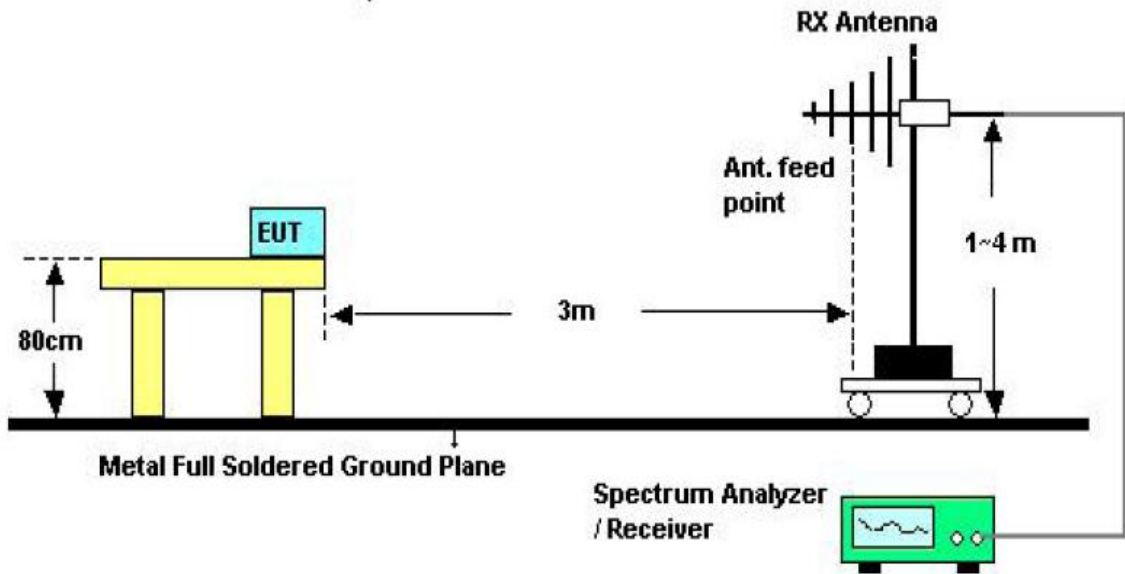

Above 30MHz Test Setup

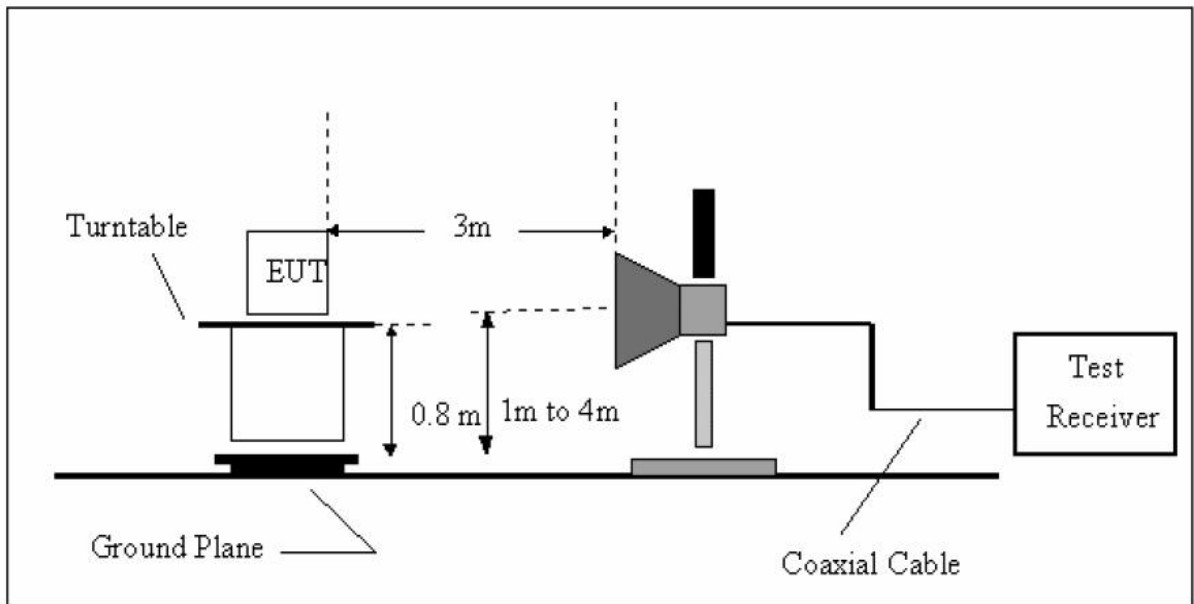

Above 1GHz Test Setup

5.1.3 Test Procedure

- a) The measuring distance of 3m shall be used for measurements at frequency up to 1GHz and above 1GHz, The EUT was placed on a rotating 0.8 m high above ground, The table was rotated 360 degrees to determine the position of the highest radiation
- b) The Test antenna shall vary between 1m and 4m, Both Horizontal and Vertical antenna are set of make measurement.
- c) The initial step in collecting conducted emission data is a spectrum analyzer Peak detector mode pre-scanning the measurement frequency range. Significant Peaks are then marked. and then Qusia Peak Detector mode premeasured
- d) If Peak value comply with QP limit Below 1GHz. The EUT deemed to comply with QP limit. But the Peak value and average value both need to comply with applicable limit above 1GHz.
- e) For the actual test configuration, please see the test setup photo.

5.1.4 Test Equipment Setting For emission test Result

9KHz~150KHz	RBW 200Hz	VBW 1KHz
150KHz~30MHz	RBW 9KHz	VBW 30KHz
30MHz~1GHz	RBW 120KHz	VBW 300KHz
Above 1GHz	RBW 1MHz	VBW 3MHz

5.1.5 Test Condition

Continual Transmitting in maximum power.

5.1.6 Test Result

We have scanned the 10th harmonic from 9KHz to the EUT.

Detailed information please see the following page.

From 9KHz to 30MHz: Conclusion: PASS

Note: The amplitude of spurious emissions which are attenuated by more than 20dB below the permissible value has no need to be reported.



Shenzhen Certification Technology Service Co., Ltd
 2F, Building B, East Area of Nanchang Second Industrial Zone,
 Gushu 2nd Road, Bao'an District, Shenzhen 518126, P.R. China
 Tel: 4006786199 FAX: +86-755-26736857
 Website: <http://www.cessz.com> Email: Service@cessz.com

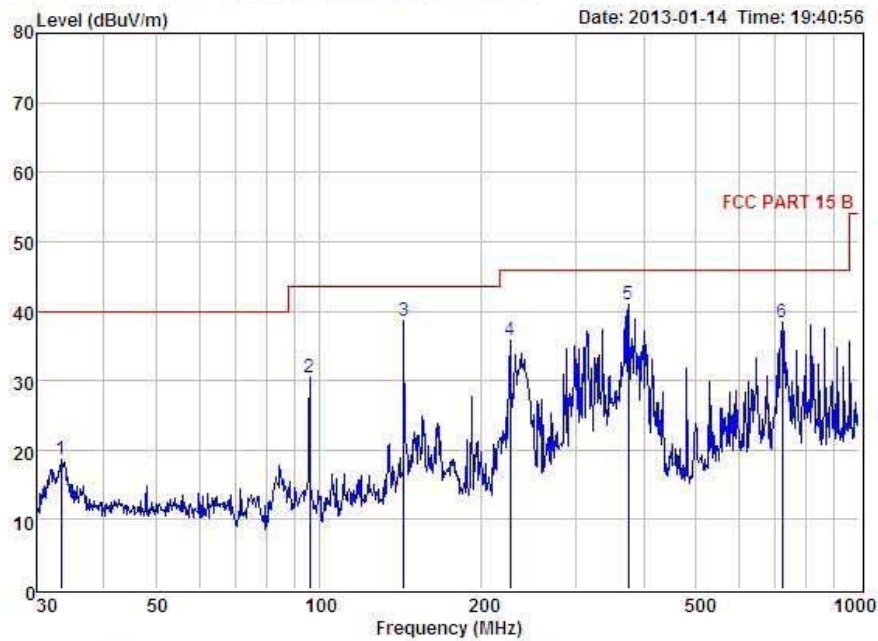

Condition : FCC PART 15 B 3m POL: HORIZONTAL
 EUT : Wi-Fi Disk
 Model No : S3
 Test Mode : Link Mode
 Power : DC 5V From PC with AC 120V/60Hz adapter
 Test Engineer : Eric
 Remark :

Item	Freq MHz	Read Level dBuV	Antenna Factor dB	Preamp Factor dB	Cable Loss dB	Level dBuV	Limit dBuV	Margin dBuV	Remark
1	33.33	32.80	13.33	27.58	0.11	18.66	40.00	-21.34	QP
2	96.10	47.06	9.87	26.83	0.41	30.51	43.50	-12.99	QP
3	143.83	51.25	13.77	26.90	0.38	38.50	43.50	-5.00	QP
4	226.10	51.32	10.98	27.08	0.51	35.73	46.00	-10.27	QP
5	374.62	52.90	14.32	27.35	1.07	40.94	46.00	-5.06	QP
6	721.73	44.86	19.92	27.73	1.26	38.31	46.00	-7.69	QP

Remark: Level = Read Level + Antenna Factor - Preamp Factor + Cable Loss



Shenzhen Certification Technology Service Co., Ltd
 2F, Building B, East Area of Nanchang Second Industrial Zone,
 Gushu 2nd Road, Bao'an District, Shenzhen 518126, P.R. China
 Tel: 4006786199 FAX: +86-755-26736857
 Website: <http://www.cessz.com> Email: Service@cessz.com

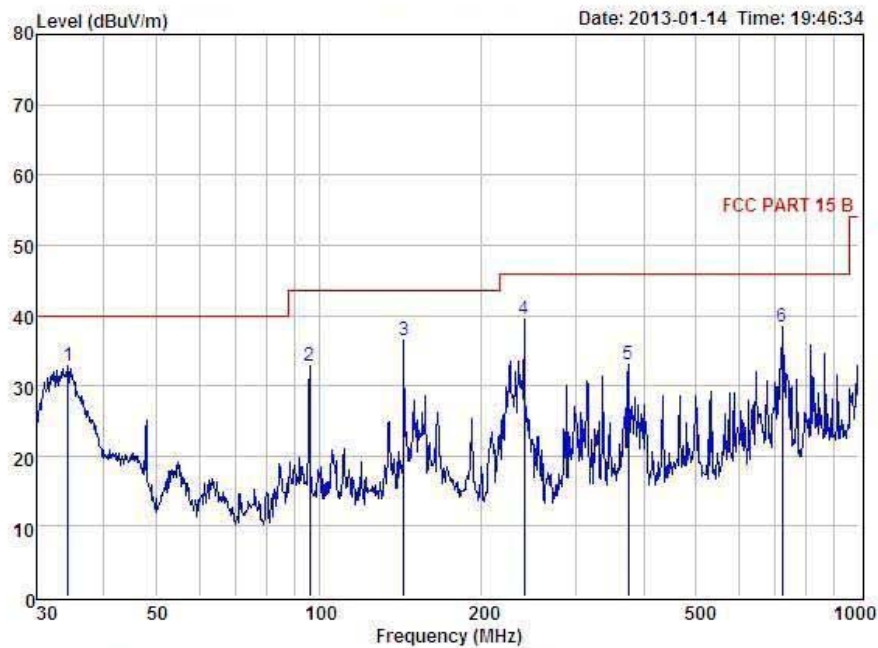

Condition : FCC PART 15 B 3m POL: VERTICAL
 EUT : Wi-Fi Disk
 Model No : S3
 Test Mode : Link Mode
 Power : DC 5V From PC with AC 120V/60Hz adapter
 Test Engineer : Eric
 Remark :

Item	Freq MHz	Read Level dBuV	Antenna Factor dB	Preamp Factor dB	Cable Loss dB	Level dBuV	Limit dBuV	Margin dBuV	Remark
1	34.28	46.96	13.33	27.58	0.12	32.83	40.00	-7.17	QP
2	96.10	49.29	9.87	26.83	0.41	32.74	43.50	-10.76	QP
3	143.83	49.16	13.77	26.90	0.38	36.41	43.50	-7.09	QP
4	239.99	54.86	11.45	27.09	0.53	39.45	46.00	-6.55	QP
5	374.62	44.97	14.32	27.35	1.07	33.01	46.00	-12.99	QP
6	721.73	44.95	19.92	27.73	1.26	38.40	46.00	-7.60	QP

Remark: Level = Read Level + Antenna Factor - Preamp Factor + Cable Loss

IEEE 802.11b

EUT	Wi-Fi Disk	Model Name	S3
Temperature	26°C	Relative Humidity	56%
Pressure	960hPa	Test voltage	DC 5V From PC
Test Mode	TX Low		

Freq. (MHz)	Ant. Pol H/V	Peak Reading (dBuV)	AV Reading (dBuV)	Ant. / CL CF (dB)	Actual Fs		Peak Limit (dBuV/m)	AV Limit (dBuV/m)	Margin (dB)	Remarks
					Peak (dBuV/m)	AV (dBuV/m)				
1120	V	56.05	---	-11.24	44.81	---	74.00	54.00	-9.19	Peak
1745	V	50.71	---	-9.53	41.18	---	74.00	54.00	-12.82	Peak
2289	V	46.42	---	-8.07	38.35	---	74.00	54.00	-15.65	Peak
4824	V	43.12	---	0.64	43.76	---	74.00	54.00	-10.24	Peak
N/A										

EUT	Wi-Fi Disk	Model Name	S3
Temperature	26°C	Relative Humidity	56%
Pressure	960hPa	Test voltage	DC 5V From PC
Test Mode	TX Low		

Freq. (MHz)	Ant. Pol H/V	Peak Reading (dBuV)	AV Reading (dBuV)	Ant. / CL CF (dB)	Actual Fs		Peak Limit (dBuV/m)	AV Limit (dBuV/m)	Margin (dB)	Remarks
					Peak (dBuV/m)	AV (dBuV/m)				
1295	H	54.59	---	-10.96	43.63	---	74.00	54.00	-10.37	Peak
1932	H	48.15	---	-8.86	39.29	---	74.00	54.00	-14.71	Peak
2913	H	43.88	---	-5.95	37.93	---	74.00	54.00	-16.07	Peak
4824	H	42.14	---	0.64	42.78	---	74.00	54.00	-11.22	Peak
N/A										

Notes: AV Means AV detector test data, Peak Means Peak detector test data.
Emissions attenuated more than 20 dB below the permissible value are not reported.

EUT	Wi-Fi Disk	Model Name	S3
Temperature	26°C	Relative Humidity	56%
Pressure	960hPa	Test voltage	DC 5V From PC
Test Mode	TX Mid		

Freq. (MHz)	Ant. Pol H/V	Peak Reading (dBuV)	AV Reading (dBuV)	Ant. / CL CF (dB)	Actual Fs		Peak Limit (dBuV/m)	AV Limit (dBuV/m)	Margin (dB)	Remark
					Peak (dBuV/m)	AV (dBuV/m)				
1289	V	55.78	---	-10.96	44.82	---	74.00	54.00	-9.18	Peak
2042	V	46.29	---	-8.58	37.71	---	74.00	54.00	-16.29	Peak
2953	V	47.44	---	-5.86	41.58	---	74.00	54.00	-12.42	Peak
4874	V	42.15	---	0.76	42.91	---	74.00	54.00	-11.09	Peak

EUT	Wi-Fi Disk	Model Name	S3
Temperature	26°C	Relative Humidity	56%
Pressure	960hPa	Test voltage	DC 5V From PC
Test Mode	TX Mid		

Freq. (MHz)	Ant. Pol H/V	Peak Reading (dBuV)	AV Reading (dBuV)	Ant. / CL CF (dB)	Actual Fs		Peak Limit (dBuV/m)	AV Limit (dBuV/m)	Margin (dB)	Remark
					Peak (dBuV/m)	AV (dBuV/m)				
1245	H	52.64	---	-11.52	41.12	---	74.00	54.00	-12.88	Peak
1959	H	48.44	---	-8.64	39.80	---	74.00	54.00	-14.20	Peak
3452	H	49.22	---	-4.95	44.27	---	74.00	54.00	-9.73	Peak
4874	H	41.69	---	0.76	42.45	---	74.00	54.00	-11.55	Peak

Notes: AV Means AV detector test data, Peak Means Peak detector test data.
Emissions attenuated more than 20 dB below the permissible value are not reported.

EUT	Wi-Fi Disk	Model Name	S3
Temperature	26°C	Relative Humidity	56%
Pressure	960hPa	Test voltage	DC 5V From PC
Test Mode	TX High		

Freq. (MHz)	Ant. Pol H/V	Peak Reading (dBuV)	AV Reading (dBuV)	Ant. / CL CF (dB)	Actual Fs		Peak Limit (dBuV/m)	AV Limit (dBuV/m)	Margin (dB)	Remark
					Peak (dBuV/m)	AV (dBuV/m)				
1395	V	55.25	---	-10.43	44.82	---	74.00	54.00	-9.18	Peak
2276	V	47.06	---	-8.07	38.99	---	74.00	54.00	-15.01	Peak
3112	V	49.11	---	-5.63	43.48	---	74.00	54.00	-10.52	Peak
4924	V	38.36	---	0.87	39.23	---	74.00	54.00	-14.77	Peak

EUT	Wi-Fi Disk	Model Name	S3
Temperature	26°C	Relative Humidity	56%
Pressure	960hPa	Test voltage	DC 5V From PC
Test Mode	TX High		

Freq. (MHz)	Ant. Pol H/V	Peak Reading (dBuV)	AV Reading (dBuV)	Ant. / CL CF (dB)	Actual Fs		Peak Limit (dBuV/m)	AV Limit (dBuV/m)	Margin (dB)	Remark
					Peak (dBuV/m)	AV (dBuV/m)				
1344	H	51.56	---	-10.84	40.72	---	74.00	54.00	-13.28	Peak
2387	H	51.85	---	-7.59	44.26	---	74.00	54.00	-9.74	Peak
3704	H	44.19	---	-4.24	39.95	---	74.00	54.00	-14.05	Peak
4924	H	41.14	---	0.87	42.01	---	74.00	54.00	-11.99	Peak

Notes: AV Means AV detector test data, Peak Means Peak detector test data.
Emissions attenuated more than 20 dB below the permissible value are not reported.

IEEE 802.11 g:

EUT	Wi-Fi Disk	Model Name	S3
Temperature	26°C	Relative Humidity	56%
Pressure	960hPa	Test voltage	DC 5V From PC
Test Mode	TX Low		

Freq. (MHz)	Ant. Pol H/V	Peak Reading (dBuV)	AV Reading (dBuV)	Ant. / CL CF (dB)	Actual Fs		Peak Limit (dBuV/m)	AV Limit (dBuV/m)	Margin (dB)	Remark
					Peak (dBuV/m)	AV (dBuV/m)				
1145	V	54.47	---	-11.24	43.23	---	74.00	54.00	-10.77	Peak
2586	V	48.60	---	-7.13	41.47	---	74.00	54.00	-12.53	Peak
3062	V	46.47	---	-5.74	40.73	---	74.00	54.00	-13.27	Peak
4824	V	41.48	---	0.64	42.12	---	74.00	54.00	-11.88	Peak
N/A										

EUT	Wi-Fi Disk	Model Name	S3
Temperature	26°C	Relative Humidity	56%
Pressure	960hPa	Test voltage	DC 5V From PC
Test Mode	TX Low		

Freq. (MHz)	Ant. Pol H/V	Peak Reading (dBuV)	AV Reading (dBuV)	Ant. / CL CF (dB)	Actual Fs		Peak Limit (dBuV/m)	AV Limit (dBuV/m)	Margin (dB)	Remark
					Peak (dBuV/m)	AV (dBuV/m)				
1294	H	51.92	---	-10.96	40.96	---	74.00	54.00	-13.04	Peak
2038	H	48.41	---	-8.58	39.83	---	74.00	54.00	-14.17	Peak
3483	H	49.10	---	-4.95	44.15	---	74.00	54.00	-9.85	Peak
4824	H	43.27	---	0.64	43.91	---	74.00	54.00	-10.09	Peak
N/A										

Notes: AV Means AV detector test data, Peak Means Peak detector test data.
Emissions attenuated more than 20 dB below the permissible value are not reported.

EUT	Wi-Fi Disk	Model Name	S3
Temperature	26°C	Relative Humidity	56%
Pressure	960hPa	Test voltage	DC 5V From PC
Test Mode	TX Mid		

Freq. (MHz)	Ant. Pol H/V	Peak Reading (dBuV)	AV Reading (dBuV)	Ant. / CL CF (dB)	Actual Fs		Peak Limit (dBuV/m)	AV Limit (dBuV/m)	Margin (dB)	Remark
					Peak (dBuV/m)	AV (dBuV/m)				
1374	V	51.42	---	-10.43	40.99	---	74.00	54.00	-13.01	Peak
2589	V	45.88	---	-7.13	38.75	---	74.00	54.00	-15.25	Peak
3365	V	49.51	---	-5.18	44.33	---	74.00	54.00	-9.67	Peak
4874	V	41.81	---	0.76	42.57	---	74.00	54.00	-11.43	Peak

EUT	Wi-Fi Disk	Model Name	S3
Temperature	26°C	Relative Humidity	56%
Pressure	960hPa	Test voltage	DC 5V From PC
Test Mode	TX Mid		

Freq. (MHz)	Ant. Pol H/V	Peak Reading (dBuV)	AV Reading (dBuV)	Ant. / CL CF (dB)	Actual Fs		Peak Limit (dBuV/m)	AV Limit (dBuV/m)	Margin (dB)	Remark
					Peak (dBuV/m)	AV (dBuV/m)				
1321	H	52.89	---	-10.84	42.05	---	74.00	54.00	-11.95	Peak
2314	H	46.12	---	-7.46	38.66	---	74.00	54.00	-15.34	Peak
3577	H	48.14	---	-4.76	43.38	---	74.00	54.00	-10.62	Peak
4874	H	36.22	---	0.76	36.98	---	74.00	54.00	-17.02	Peak

Notes: AV Means AV detector test data, Peak Means Peak detector test data.
Emissions attenuated more than 20 dB below the permissible value are not reported.

EUT	Wi-Fi Disk	Model Name	S3
Temperature	26°C	Relative Humidity	56%
Pressure	960hPa	Test voltage	DC 5V From PC
Test Mode	TX High		

Freq. (MHz)	Ant. Pol H/V	Peak Reading (dBuV)	AV Reading (dBuV)	Ant. / CL CF (dB)	Actual Fs		Peak Limit (dBuV/m)	AV Limit (dBuV/m)	Margin (dB)	Remark
					Peak (dBuV/m)	AV (dBuV/m)				
1302	V	53.25	---	-10.84	42.41	---	74.00	54.00	-11.59	Peak
2982	V	45.42	---	-5.86	39.56	---	74.00	54.00	-14.44	Peak
3831	V	47.89	---	-3.96	43.93	---	74.00	54.00	-10.07	Peak
4924	V	39.80	---	0.87	40.67	---	74.00	54.00	-13.33	Peak

EUT	Wi-Fi Disk	Model Name	S3
Temperature	26°C	Relative Humidity	56%
Pressure	960hPa	Test voltage	DC 5V From PC
Test Mode	TX High		

Freq. (MHz)	Ant. Pol H/V	Peak Reading (dBuV)	AV Reading (dBuV)	Ant. / CL CF (dB)	Actual Fs		Peak Limit (dBuV/m)	AV Limit (dBuV/m)	Margin (dB)	Remark
					Peak (dBuV/m)	AV (dBuV/m)				
1446	H	53.63	---	-10.29	43.34	---	74.00	54.00	-10.66	Peak
2198	H	47.01	---	-8.24	38.77	---	74.00	54.00	-15.23	Peak
3905	H	46.09	---	-3.68	42.41	---	74.00	54.00	-11.59	Peak
4924	H	43.42	---	0.87	44.29	---	74.00	54.00	-9.71	Peak

Notes: AV Means AV detector test data, Peak Means Peak detector test data.
Emissions attenuated more than 20 dB below the permissible value are not reported.

IEEE 802.11n/HT20

EUT	Wi-Fi Disk	Model Name	S3
Temperature	26°C	Relative Humidity	56%
Pressure	960hPa	Test voltage	DC 5V From PC
Test Mode	TX Low		

Freq. (MHz)	Ant. Pol H/V	Peak Reading (dBuV)	AV Reading (dBuV)	Ant. / CL CF (dB)	Actual Fs		Peak Limit (dBuV/m)	AV Limit (dBuV/m)	Margin (dB)	Remark
					Peak (dBuV/m)	AV (dBuV/m)				
1492	V	53.75	---	-10.27	43.48	---	74.00	54.00	-10.52	Peak
2671	V	47.79	---	-6.94	40.85	---	74.00	54.00	-13.15	Peak
3948	V	45.47	---	-3.68	41.79	---	74.00	54.00	-12.21	Peak
4824	V	37.74	---	0.64	38.38	---	74.00	54.00	-15.62	Peak
N/A										

EUT	Wi-Fi Disk	Model Name	S3
Temperature	26°C	Relative Humidity	56%
Pressure	960hPa	Test voltage	DC 5V From PC
Test Mode	TX Low		

Freq. (MHz)	Ant. Pol H/V	Peak Reading (dBuV)	AV Reading (dBuV)	Ant. / CL CF (dB)	Actual Fs		Peak Limit (dBuV/m)	AV Limit (dBuV/m)	Margin (dB)	Remark
					Peak (dBuV/m)	AV (dBuV/m)				
1451	H	52.70	---	-10.27	42.43	---	74.00	54.00	-11.57	Peak
2839	H	47.56	---	-6.17	41.39	---	74.00	54.00	-12.61	Peak
3607	H	45.07	---	-4.52	40.55	---	74.00	54.00	-13.45	Peak
4824	H	43.42	---	0.64	44.06	---	74.00	54.00	-9.94	Peak
N/A										

Notes: AV Means AV detector test data, Peak Means Peak detector test data.
Emissions attenuated more than 20 dB below the permissible value are not reported.

EUT	Wi-Fi Disk	Model Name	S3
Temperature	26°C	Relative Humidity	56%
Pressure	960hPa	Test voltage	DC 5V From PC
Test Mode	TX Mid		

Freq. (MHz)	Ant. Pol H/V	Peak Reading (dBuV)	AV Reading (dBuV)	Ant. / CL CF (dB)	Actual Fs		Peak Limit (dBuV/m)	AV Limit (dBuV/m)	Margin (dB)	Remark
					Peak (dBuV/m)	AV (dBuV/m)				
1262	V	52.12	---	-10.96	41.16	---	74.00	54.00	-12.84	Peak
2013	V	52.42	---	-8.58	43.84	---	74.00	54.00	-10.16	Peak
3798	V	42.80	---	-4.07	38.73	---	74.00	54.00	-15.27	Peak
4874	V	41.31	---	0.76	42.07	---	74.00	54.00	-11.93	Peak

EUT	Wi-Fi Disk	Model Name	S3
Temperature	26°C	Relative Humidity	56%
Pressure	960hPa	Test voltage	DC 5V From PC
Test Mode	TX Mid		

Freq. (MHz)	Ant. Pol H/V	Peak Reading (dBuV)	AV Reading (dBuV)	Ant. / CL CF (dB)	Actual Fs		Peak Limit (dBuV/m)	AV Limit (dBuV/m)	Margin (dB)	Remark
					Peak (dBuV/m)	AV (dBuV/m)				
1511	H	53.65	---	-10.14	43.51	---	74.00	54.00	-10.49	Peak
2353	H	49.34	---	-7.59	41.75	---	74.00	54.00	-12.25	Peak
3266	H	44.66	---	-5.39	39.27	---	74.00	54.00	-14.73	Peak
4874	H	43.27	---	0.76	44.03	---	74.00	54.00	-9.97	Peak

Notes: AV Means AV detector test data, Peak Means Peak detector test data.
Emissions attenuated more than 20 dB below the permissible value are not reported.

EUT	Wi-Fi Disk	Model Name	S3
Temperature	26°C	Relative Humidity	56%
Pressure	960hPa	Test voltage	DC 5V From PC
Test Mode	TX High		

Freq. (MHz)	Ant. Pol H/V	Peak Reading (dBuV)	AV Reading (dBuV)	Ant. / CL CF (dB)	Actual Fs		Peak Limit (dBuV/m)	AV Limit (dBuV/m)	Margin (dB)	Remark
					Peak (dBuV/m)	AV (dBuV/m)				
1477	V	51.88	---	-10.27	41.61	---	74.00	54.00	-12.39	Peak
2703	V	48.98	---	-6.43	42.55	---	74.00	54.00	-11.45	Peak
3561	V	49.72	---	-4.76	44.96	---	74.00	54.00	-9.04	Peak
4924	V	38.80	---	0.87	39.67	---	74.00	54.00	-14.33	Peak

EUT	Wi-Fi Disk	Model Name	S3
Temperature	26°C	Relative Humidity	56%
Pressure	960hPa	Test voltage	DC 5V From PC
Test Mode	TX High		

Freq. (MHz)	Ant. Pol H/V	Peak Reading (dBuV)	AV Reading (dBuV)	Ant. / CL CF (dB)	Actual Fs		Peak Limit (dBuV/m)	AV Limit (dBuV/m)	Margin (dB)	Remark
					Peak (dBuV/m)	AV (dBuV/m)				
1503	H	49.37	---	-10.14	39.23	---	74.00	54.00	-14.77	Peak
3588	H	47.67	---	-4.96	42.71	---	74.00	54.00	-11.29	Peak
4153	H	43.28	---	-2.48	40.80	---	74.00	54.00	-13.20	Peak
4924	H	43.69	---	0.87	44.56	---	74.00	54.00	-9.44	Peak

Notes: AV Means AV detector test data, Peak Means Peak detector test data.
Emissions attenuated more than 20 dB below the permissible value are not reported.

IEEE 802.11n/HT40

EUT	Wi-Fi Disk	Model Name	S3
Temperature	26°C	Relative Humidity	56%
Pressure	960hPa	Test voltage	DC 5V From PC
Test Mode	TX Low		

Freq. (MHz)	Ant. Pol H/V	Peak Reading (dBuV)	AV Reading (dBuV)	Ant. / CL CF (dB)	Actual Fs		Peak Limit (dBuV/m)	AV Limit (dBuV/m)	Margin (dB)	Remark
					Peak (dBuV/m)	AV (dBuV/m)				
1551	V	51.52	---	-10.07	41.45	---	74.00	54.00	-12.55	Peak
2695	V	51.05	---	-6.94	44.11	---	74.00	54.00	-9.89	Peak
3463	V	44.22	---	-4.95	39.27	---	74.00	54.00	-14.73	Peak
4844	V	40.31	---	0.64	40.95	---	74.00	54.00	-13.05	Peak
N/A										

EUT	Wi-Fi Disk	Model Name	S3
Temperature	26°C	Relative Humidity	56%
Pressure	960hPa	Test voltage	DC 5V From PC
Test Mode	TX Low		

Freq. (MHz)	Ant. Pol H/V	Peak Reading (dBuV)	AV Reading (dBuV)	Ant. / CL CF (dB)	Actual Fs		Peak Limit (dBuV/m)	AV Limit (dBuV/m)	Margin (dB)	Remark
					Peak (dBuV/m)	AV (dBuV/m)				
1542	H	51.37	---	-10.14	41.23	---	74.00	54.00	-12.77	Peak
2358	H	50.73	---	-7.59	43.14	---	74.00	54.00	-10.86	Peak
3096	H	49.79	---	-5.74	44.05	---	74.00	54.00	-9.95	Peak
4844	H	40.15	---	0.64	40.79	---	74.00	54.00	-13.21	Peak
N/A										

Notes: AV Means AV detector test data, Peak Means Peak detector test data.
Emissions attenuated more than 20 dB below the permissible value are not reported.

EUT	Wi-Fi Disk	Model Name	S3
Temperature	26°C	Relative Humidity	56%
Pressure	960hPa	Test voltage	DC 5V From PC
Test Mode	TX Mid		

Freq. (MHz)	Ant. Pol H/V	Peak Reading (dBuV)	AV Reading (dBuV)	Ant. / CL CF (dB)	Actual Fs		Peak Limit (dBuV/m)	AV Limit (dBuV/m)	Margin (dB)	Remark
					Peak (dBuV/m)	AV (dBuV/m)				
1628	V	48.82	---	-9.84	38.98	---	74.00	54.00	-15.02	Peak
2593	V	48.14	---	-7.13	41.01	---	74.00	54.00	-12.99	Peak
3301	V	50.49	---	-5.31	45.18	---	74.00	54.00	-8.82	Peak
4874	V	39.73	---	0.76	40.49	---	74.00	54.00	-13.51	Peak

EUT	Wi-Fi Disk	Model Name	S3
Temperature	26°C	Relative Humidity	56%
Pressure	960hPa	Test voltage	DC 5V From PC
Test Mode	TX Mid		

Freq. (MHz)	Ant. Pol H/V	Peak Reading (dBuV)	AV Reading (dBuV)	Ant. / CL CF (dB)	Actual Fs		Peak Limit (dBuV/m)	AV Limit (dBuV/m)	Margin (dB)	Remark
					Peak (dBuV/m)	AV (dBuV/m)				
1564	H	53.65	---	-10.07	43.58	---	74.00	54.00	-10.42	Peak
2248	H	50.78	---	-8.13	42.65	---	74.00	54.00	-11.35	Peak
3159	H	44.51	---	-5.52	38.99	---	74.00	54.00	-15.01	Peak
4874	H	40.35	---	0.76	41.11	---	74.00	54.00	-12.89	Peak

Notes: AV Means AV detector test data, Peak Means Peak detector test data.
Emissions attenuated more than 20 dB below the permissible value are not reported.

EUT	Wi-Fi Disk	Model Name	S3
Temperature	26°C	Relative Humidity	56%
Pressure	960hPa	Test voltage	DC 5V From PC
Test Mode	TX High		

Freq. (MHz)	Ant. Pol H/V	Peak Reading (dBuV)	AV Reading (dBuV)	Ant. / CL CF (dB)	Actual Fs		Peak Limit (dBuV/m)	AV Limit (dBuV/m)	Margin (dB)	Remark
					Peak (dBuV/m)	AV (dBuV/m)				
1645	V	53.27	---	-9.84	43.43	---	74.00	54.00	-10.57	Peak
2590	V	49.17	---	-7.13	42.04	---	74.00	54.00	-11.96	Peak
3851	V	41.81	---	-3.84	37.97	---	74.00	54.00	-16.03	Peak
4904	V	40.75	---	0.87	41.62	---	74.00	54.00	-12.38	Peak

EUT	Wi-Fi Disk	Model Name	S3
Temperature	26°C	Relative Humidity	56%
Pressure	960hPa	Test voltage	DC 5V From PC
Test Mode	TX High		

Freq. (MHz)	Ant. Pol H/V	Peak Reading (dBuV)	AV Reading (dBuV)	Ant. / CL CF (dB)	Actual Fs		Peak Limit (dBuV/m)	AV Limit (dBuV/m)	Margin (dB)	Remark
					Peak (dBuV/m)	AV (dBuV/m)				
1792	H	49.56	---	-9.27	40.29	---	74.00	54.00	-13.71	Peak
2804	H	45.09	---	-6.17	38.92	---	74.00	54.00	-15.08	Peak
3743	H	47.78	---	-4.24	43.54	---	74.00	54.00	-10.46	Peak
4904	H	43.79	---	0.87	44.66	---	74.00	54.00	-9.34	Peak

Notes: AV Means AV detector test data, Peak Means Peak detector test data.
Emissions attenuated more than 20 dB below the permissible value are not reported.

6 POWER LINE CONDUCTED EMISSION

6.1 Conducted Emission Limits(15.207)

Frequency MHz	Limits dB(μ V)	
	Quasi-peak Level	Average Level
0.15 -0.50	66 -56*	56 - 46*
0.50 -5.00	56	46
5.00 -30.00	60	50

Notes: 1. *Decreasing linearly with logarithm of frequency.

2. The lower limit shall apply at the transition frequencies.

3. The limit decreases in line with the logarithm of the frequency in the rang of 0.15 to 0.50 MHz.

6.2 Test Setup

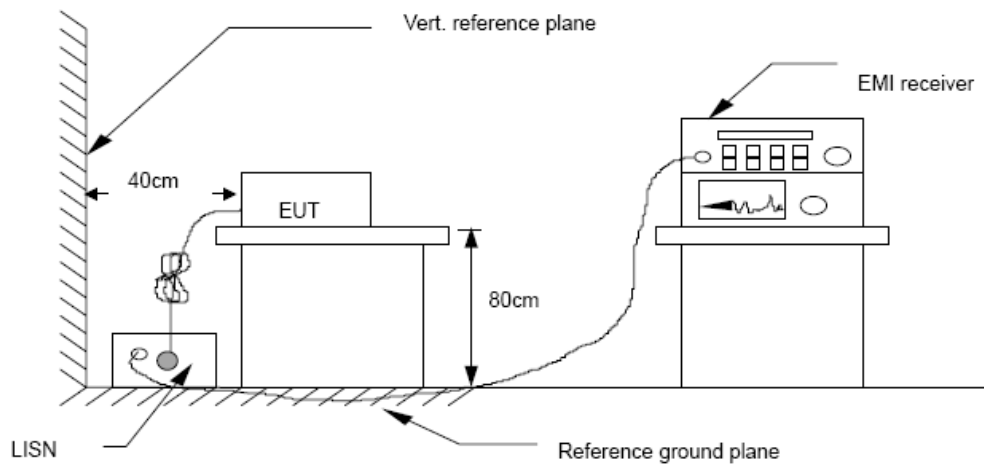

6.3 Test Procedure

The EUT is put on the plane 0.8m high above the ground by insulating support and is connected to the power mains through a line impedance stabilization network (L.I.S.N.). This provides a 50ohm coupling impedance for the EUT system. Please refer the block diagram of the test setup and photographs. Both sides of AC lines are checked to find out the maximum conducted emission. In order to find the maximum emission levels, the relative positions of equipment and all of the interface cables shall be changed according to ANSI C63.4-2003 on Conducted Emission Measurement. The bandwidth of test receiver (R & S ESCS30) is set at 9 kHz.

6.4 Test Results

PASS

Detailed information please see the following page.

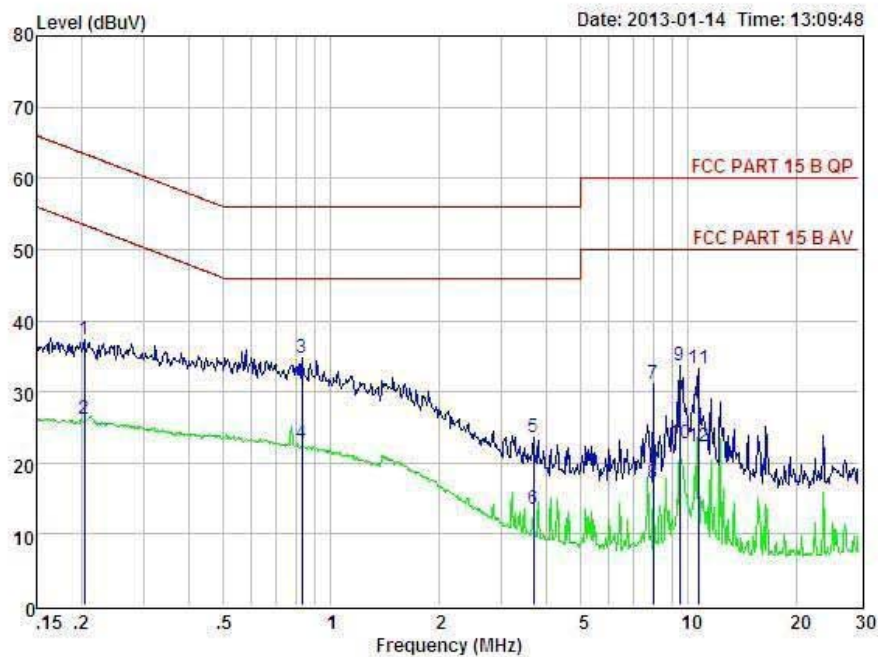

Condition : FCC PART 15 B QP POL: LINE Temp:24 °C Hum:56 %
 EUT : Wi-Fi Disk
 Model No : S3
 Test Mode : Link Mode
 Power : DC 5V From PC with AC 120V/60Hz adapter
 Test Engineer: Eric
 Remark :

Item	Freq MHz	Read dBuV	LISN Factor dB	Preamp Factor dB	Cable Loss dB	Level dBuV	Limit dBuV	Margin dBuV	Remark
1	0.204	27.40	0.03	-9.72	0.10	37.25	63.45	-26.20	QP
2	0.204	16.40	0.03	-9.72	0.10	26.25	53.45	-27.20	Average
3	0.830	24.87	0.02	-9.71	0.10	34.70	56.00	-21.30	QP
4	0.830	12.87	0.02	-9.71	0.10	22.70	46.00	-23.30	Average
5	3.681	13.65	0.08	-9.69	0.12	23.54	56.00	-32.46	QP
6	3.681	3.65	0.08	-9.69	0.12	13.54	46.00	-32.46	Average
7	7.977	21.41	0.14	-9.48	0.16	31.19	60.00	-28.81	QP
8	7.977	7.41	0.14	-9.48	0.16	17.19	50.00	-32.81	Average
9	9.451	23.95	0.17	-9.38	0.19	33.69	60.00	-26.31	QP
10	9.451	12.95	0.17	-9.38	0.19	22.69	50.00	-27.31	Average
11	10.676	23.34	0.21	-9.50	0.22	33.27	60.00	-26.73	QP
12	10.676	12.34	0.21	-9.50	0.22	22.27	50.00	-27.73	Average

Remarks: Level = Read + LISN Factor - Preamp Factor + Cable loss



Shenzhen Certification Technology Service Co., Ltd.
 2F, Building B, East Area of Nanchang Second Industrial Zone,
 Gushu 2nd Road, Bao'an District, Shenzhen 518126, P.R. China
 Tel: 4006786199 Fax: +86-755-26736857
 Website: <http://www.cessz.com> Email: Service@cessz.com

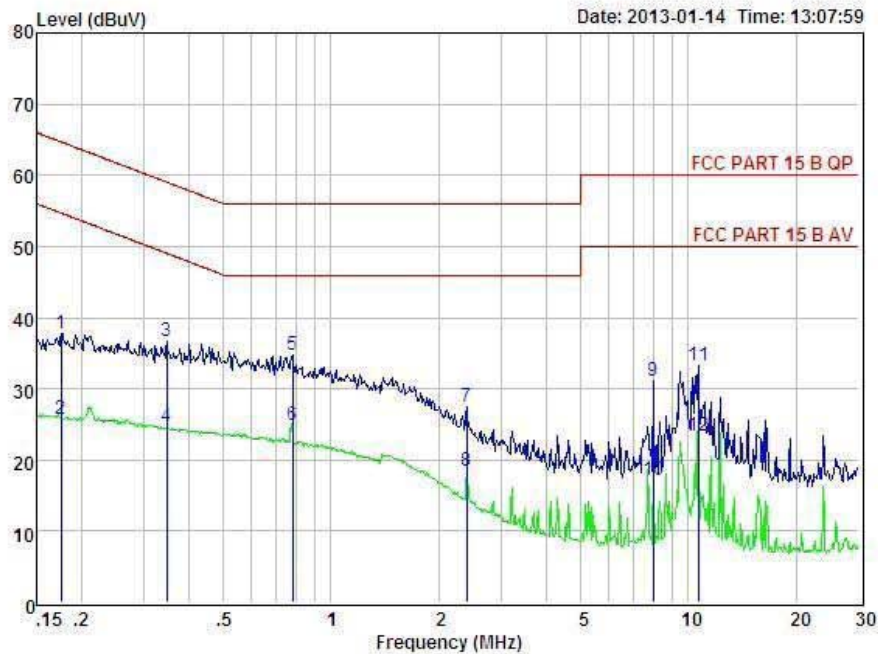

Condition : FCC PART 15 B QP POL: NEUTRAL Temp:24 °C Hum:56 %
 EUT : Wi-Fi Disk
 Model No : S3
 Test Mode : Link Mode
 Power : DC 5V From PC with AC 120V/60Hz adapter
 Test Engineer: Eric
 Remark :

Item	Freq MHz	Read dBuV	LISN Factor dB	Preamp Factor dB	Cable Loss dB	Level dBuV	Limit dBuV	Margin dBuV	Remark
1	0.176	27.97	0.03	-9.72	0.10	37.82	64.68	-26.86	QP
2	0.176	15.97	0.03	-9.72	0.10	25.82	54.68	-28.86	Average
3	0.346	26.83	0.03	-9.72	0.10	36.68	59.05	-22.37	QP
4	0.346	14.83	0.03	-9.72	0.10	24.68	49.05	-24.37	Average
5	0.779	25.03	0.00	-9.71	0.10	34.84	56.00	-21.16	QP
6	0.779	15.03	0.00	-9.71	0.10	24.84	46.00	-21.16	Average
7	2.396	17.67	0.06	-9.70	0.11	27.54	56.00	-28.46	QP
8	2.396	8.67	0.06	-9.70	0.11	18.54	46.00	-27.46	Average
9	7.977	21.32	0.14	-9.48	0.16	31.10	60.00	-28.90	QP
10	7.977	7.32	0.14	-9.48	0.16	17.10	50.00	-32.90	Average
11	10.676	23.40	0.21	-9.50	0.22	33.33	60.00	-26.67	QP
12	10.676	13.40	0.21	-9.50	0.22	23.33	50.00	-26.67	Average

Remarks: Level = Read + LISN Factor - Preamp Factor + Cable loss

7 Conducted Maximum Output Power

7.1 Test limit

Please refer section 15.247.

Regulation 15.247(b) The limit of Maximum Peak Output Power Measurement is 1W(30dBm)

7.2 Test Procedure

Details see the KDB558074 Meas Guidance V02

7.2.1 Place the EUT on the table and set it in transmitting mode.

7.2.2 Remove the antenna from the EUT and then connect a low loss RF cable from the antenna port to the spectrum analyzer.

7.2.3 Set the spectrum analyzer as RBW = 1MHz, VBW = 3MHz, Sweep=auto.

7.2.4 Record the max. reading.

7.2.5 Repeat the above procedure until the measurements for all frequencies are completed.

Details see the KDB558074 DTS Meas Guidance V02

7.3 Test Setup

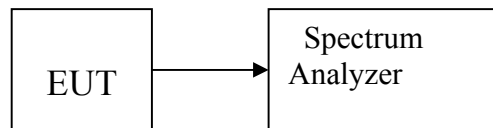

7.4 Test Results

PASS

Detailed information please see the following page.

Channel	Frequency (MHz)	Data Rate (Mbps)	PK Output Power (dBm)	AVG Output Power (dBm)	Limit (dBm)
IEEE802.11b					
Low	2412	1	8.29	7.23	30
Mid	2437	1	8.79	7.97	30
High	2462	1	7.85	7.44	30
IEEE802.11g					
Low	2412	6	8.01	6.98	30
Mid	2437	6	8.10	7.73	30
High	2462	6	8.30	6.96	30
IEEE802.11n HT20					
Low	2412	6.5	8.60	7.03	30
Mid	2437	6.5	8.24	7.43	30
High	2462	6.5	8.00	7.06	30
IEEE802.11n HT40					
Low	2422	13	7.91	7.26	30
Mid	2437	13	7.77	7.65	30
High	2452	13	7.65	7.02	30

26dB bandwidth(EBW)

IEEE 802.11b: CH Low :

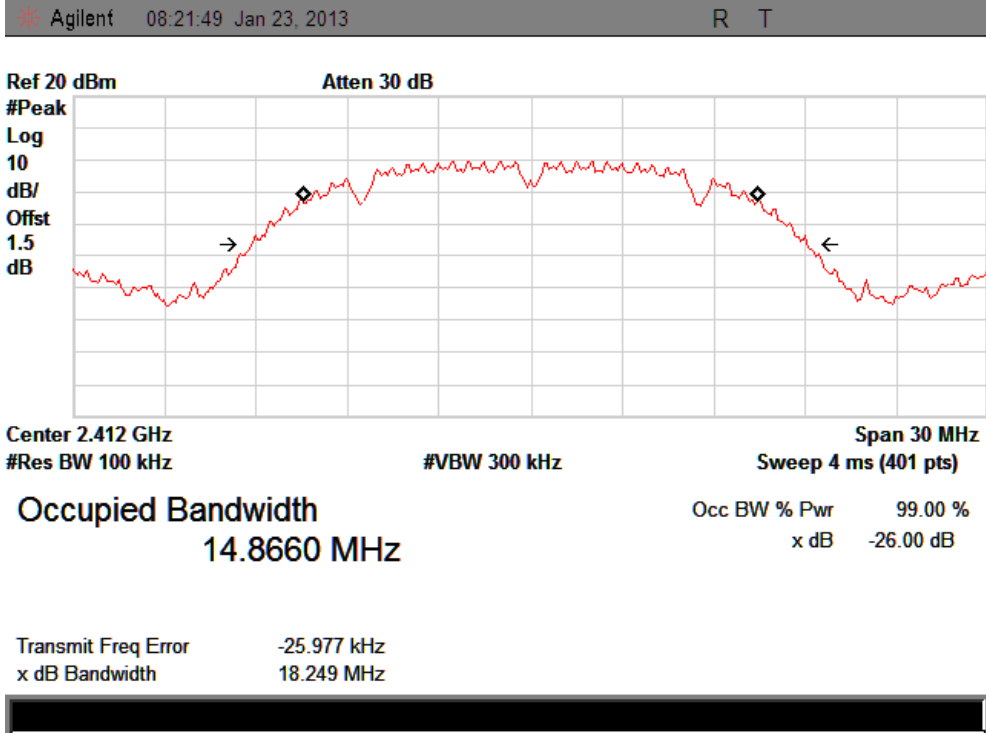

CH Mid:

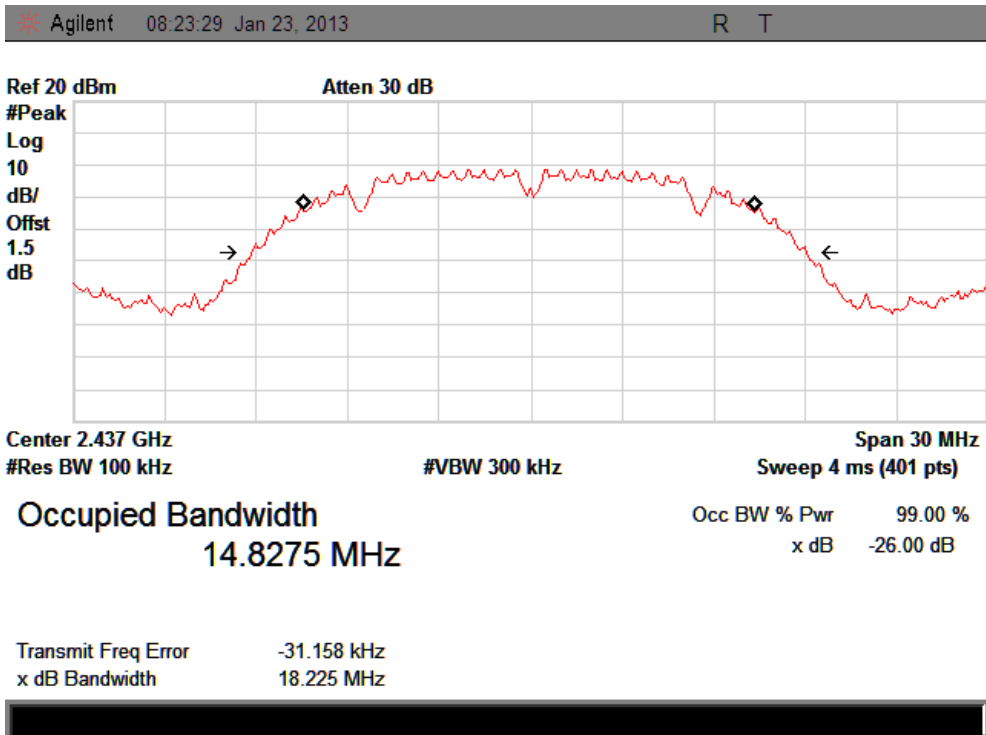

CH High:

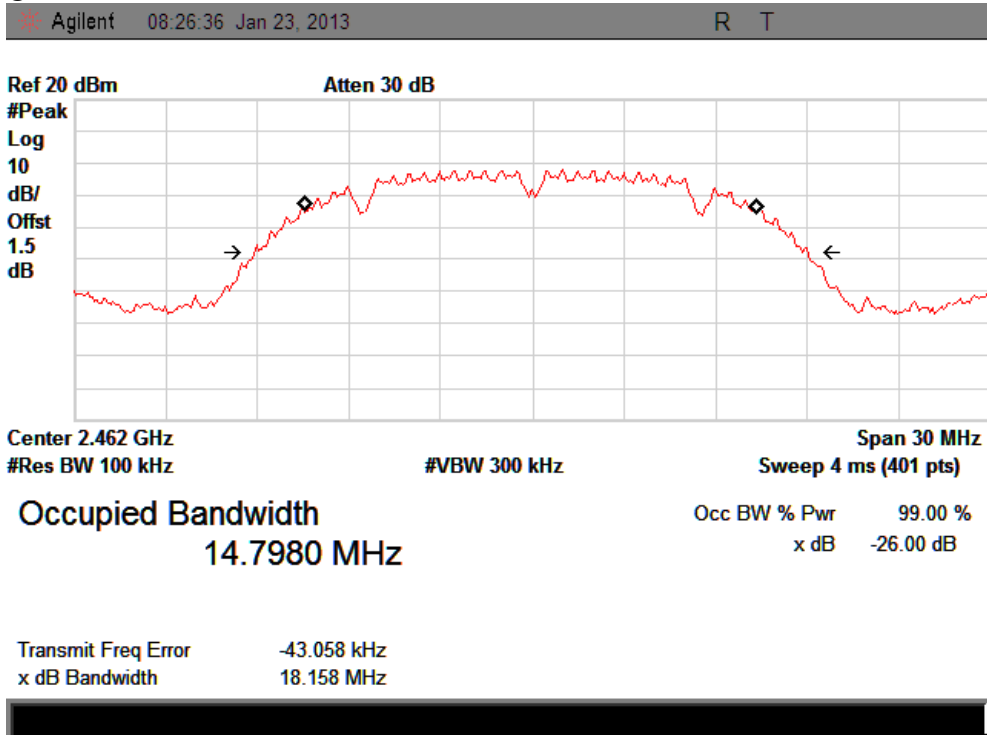

IEEE 802.11g: CH Low :

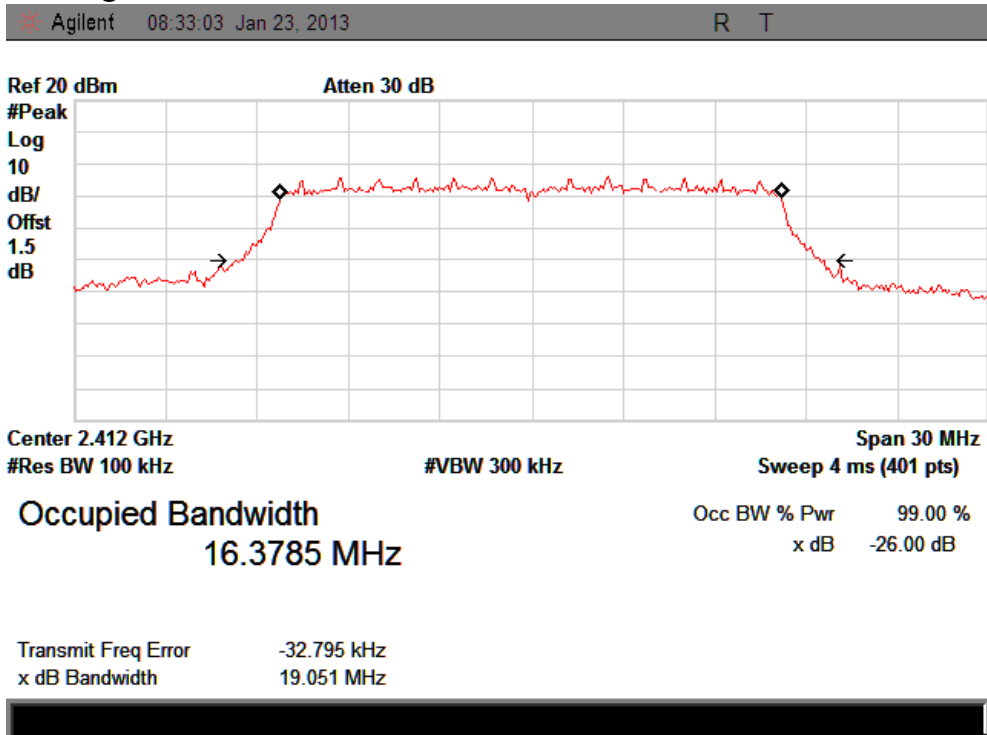

CH Mid:

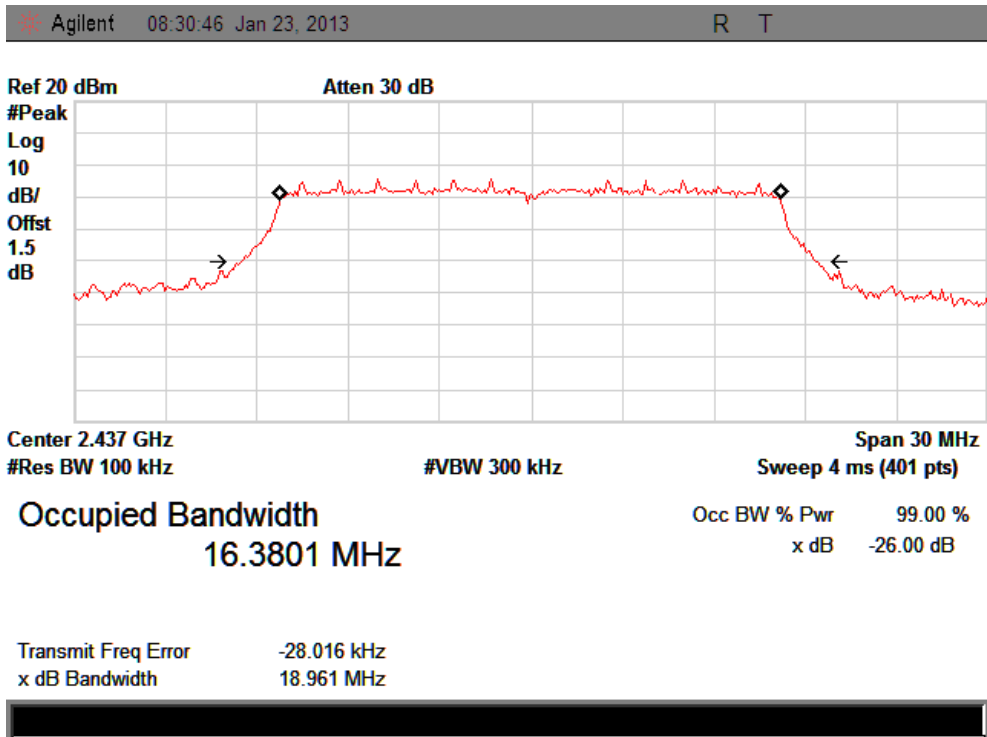

CH High:

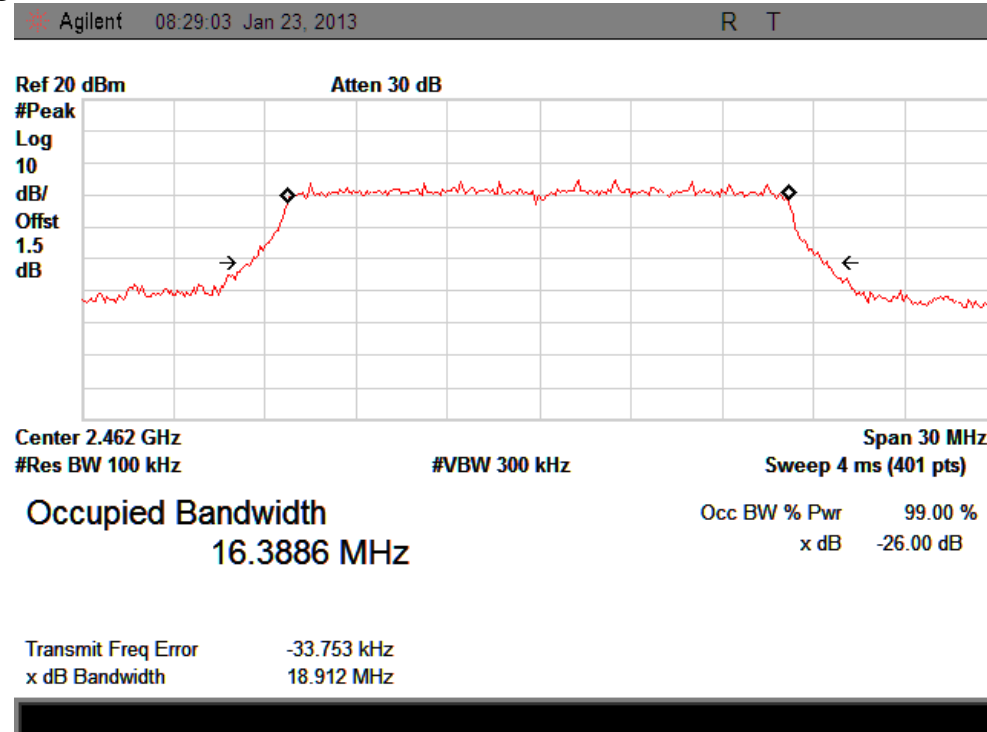

IEEE 802.11n/HT20: CH Low :

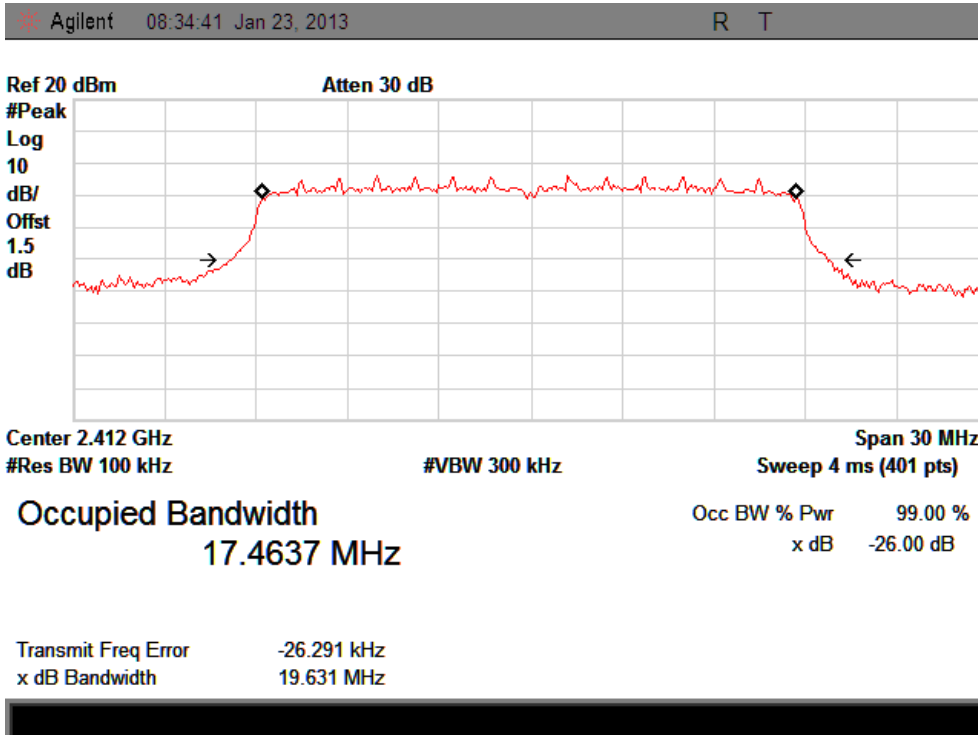

CH Mid :

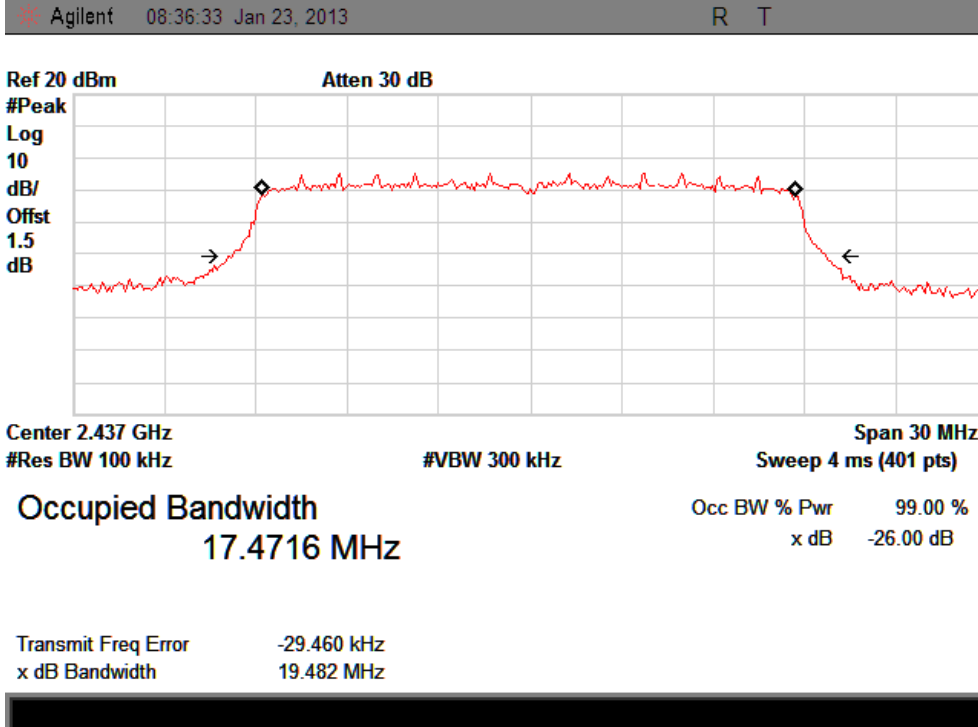

CH High :

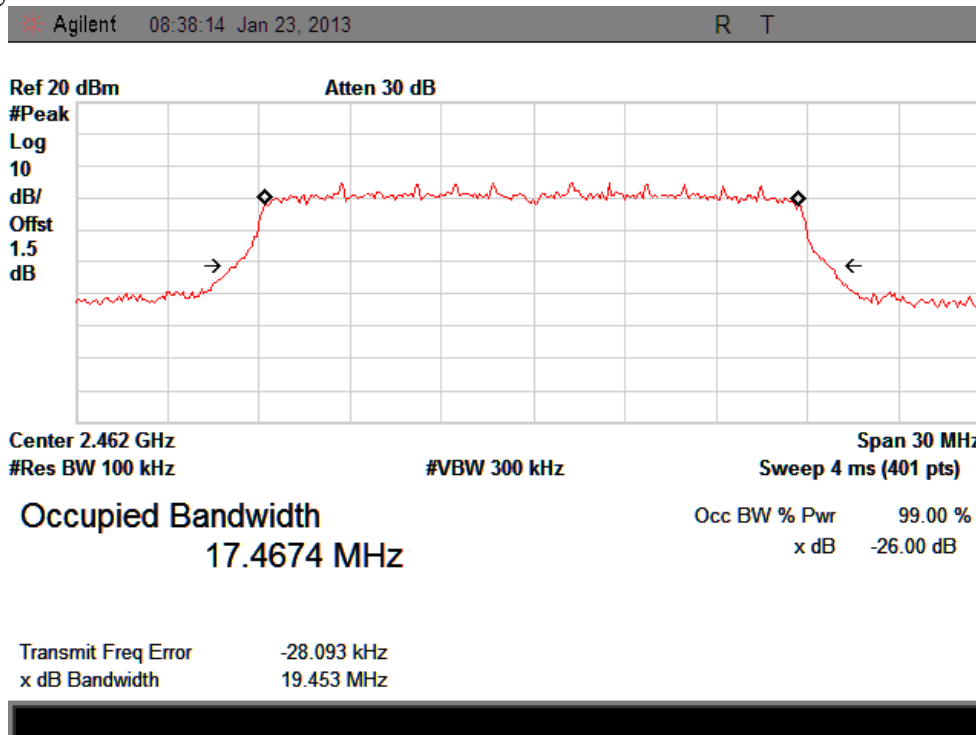

IEEE 802.11n/HT40: CH Low :

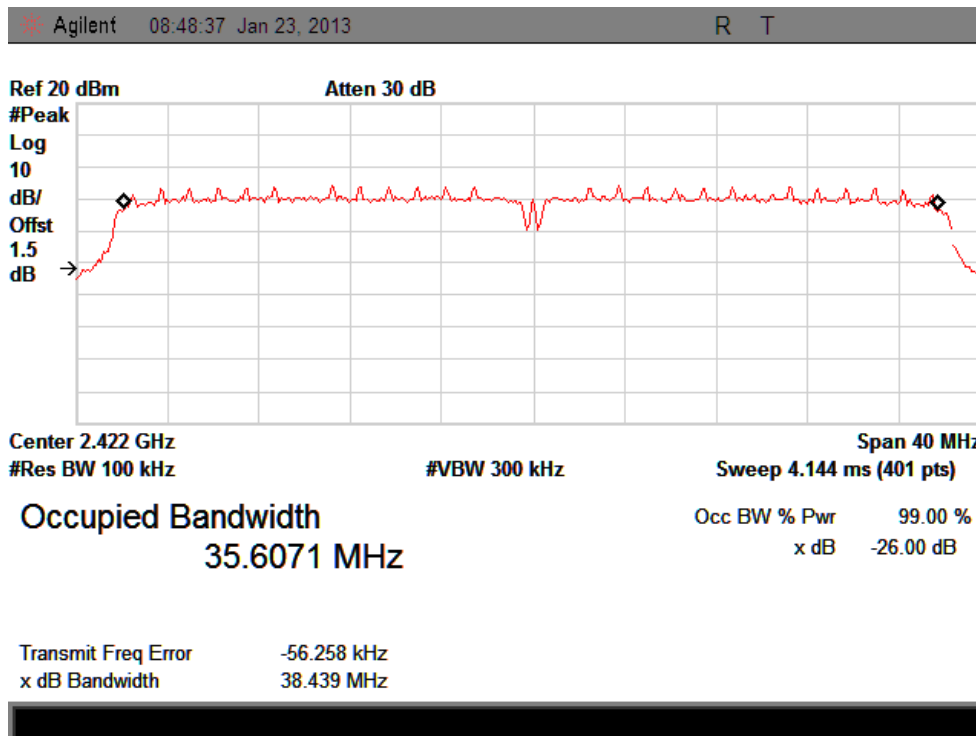

CH Mid :

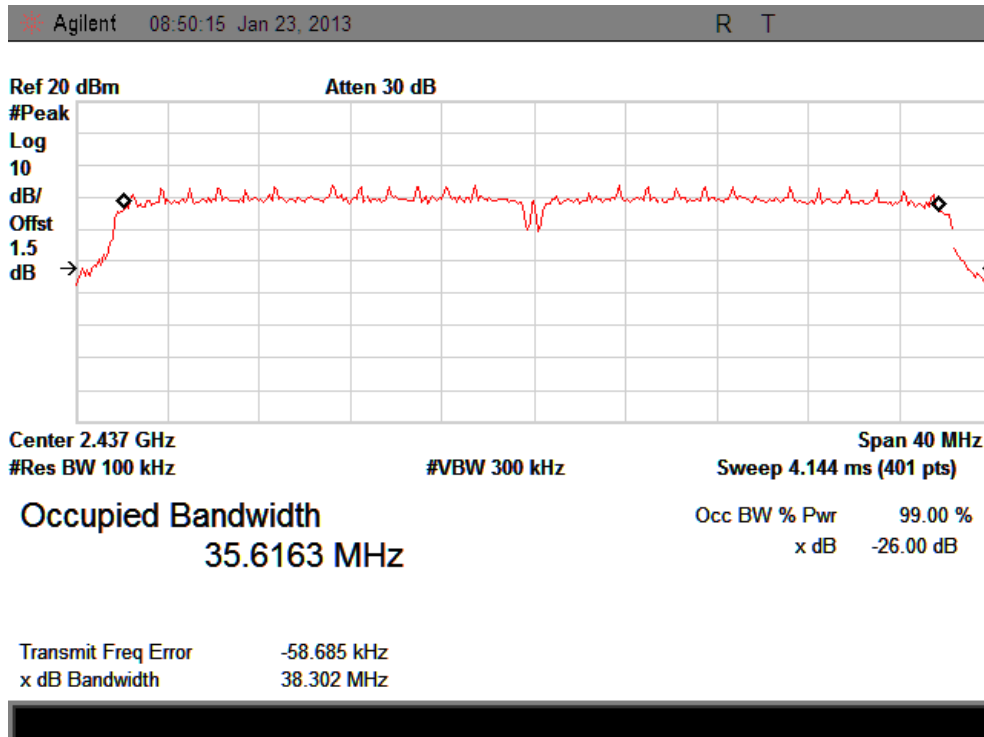

CH High :

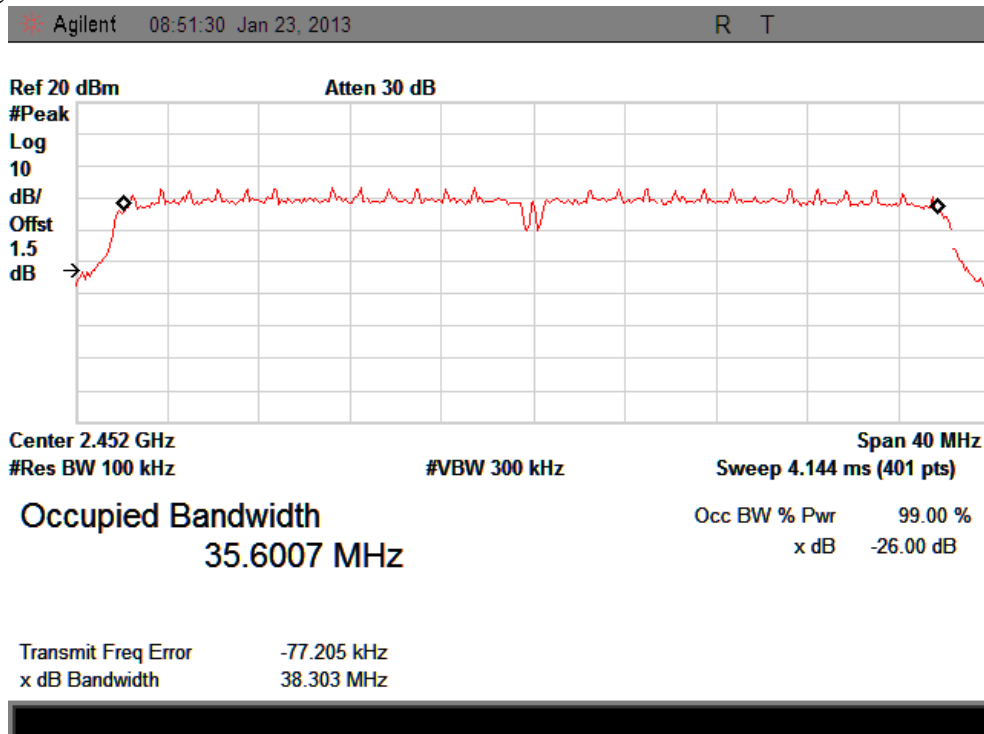

Maximum Peak Conducted Output Power

IEEE 802.11b: CH Low :

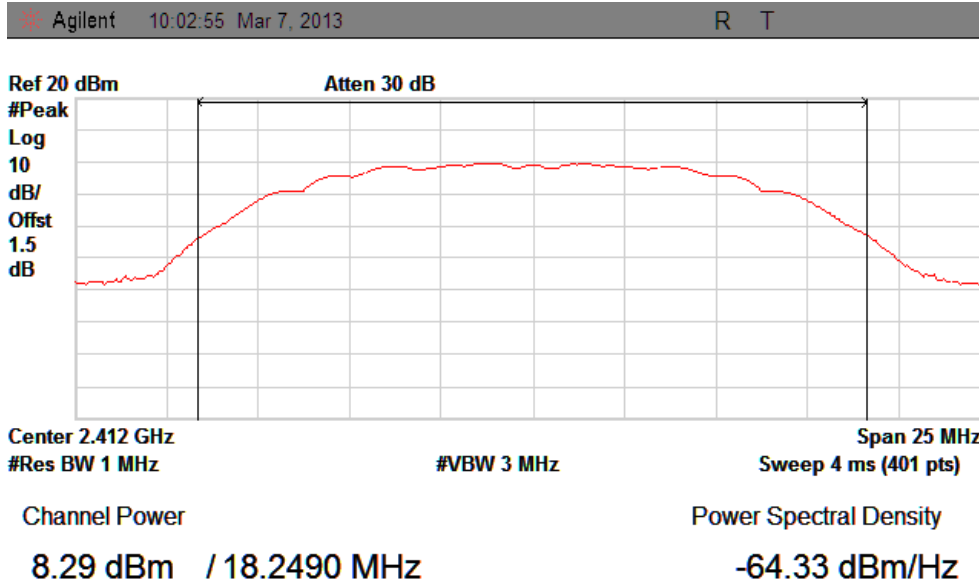

CH Mid :

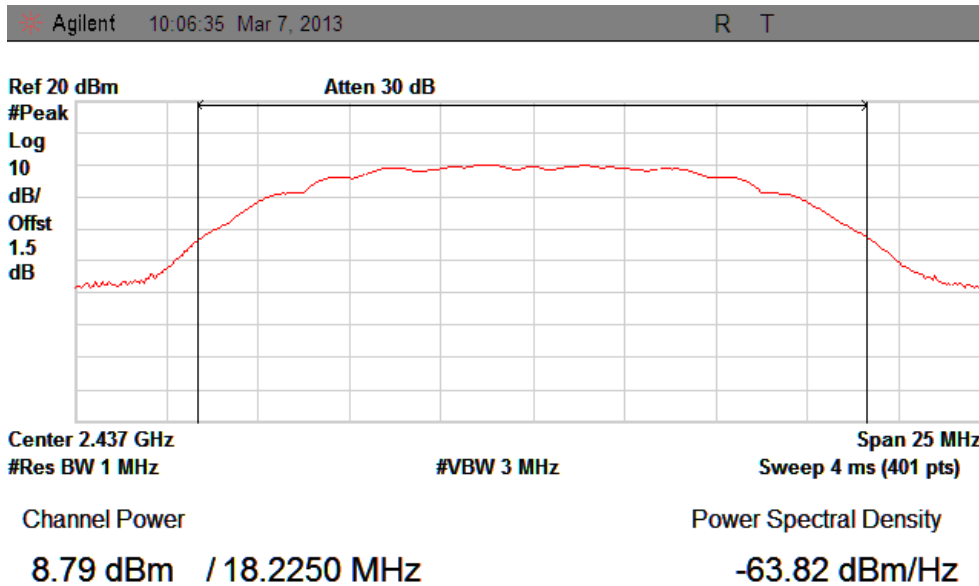

CH High :

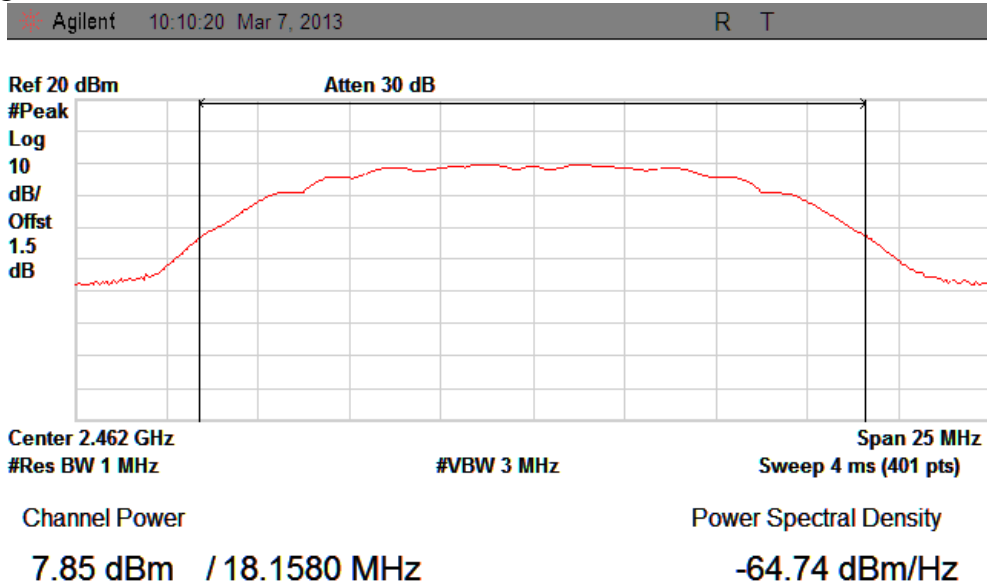

IEEE 802.11g: CH Low :

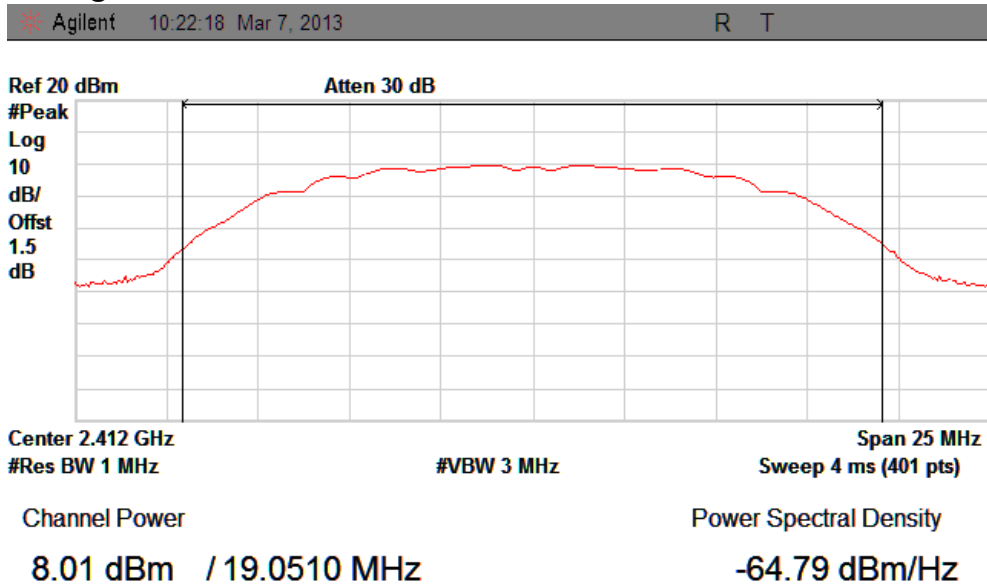

CH Mid :

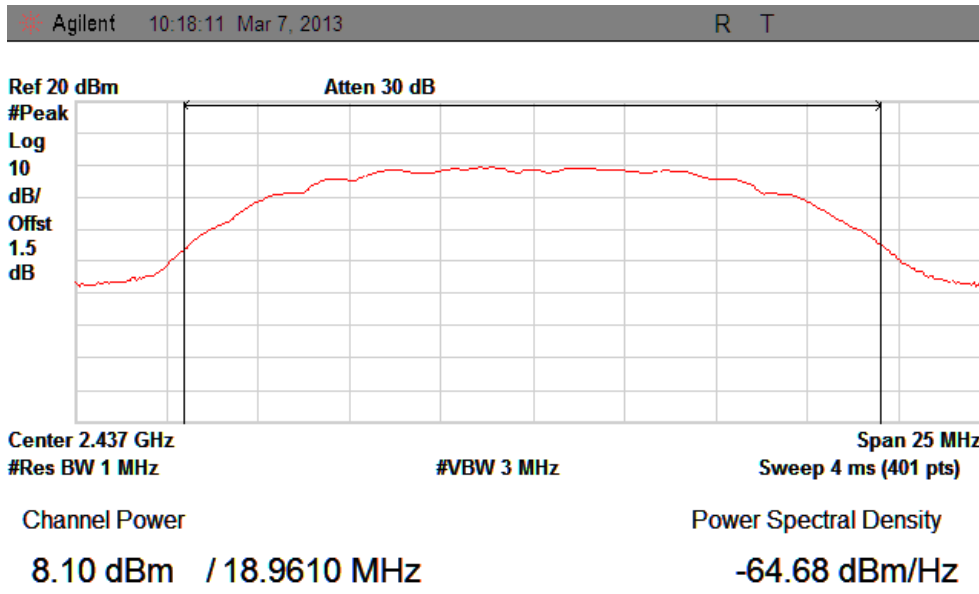

CH High :

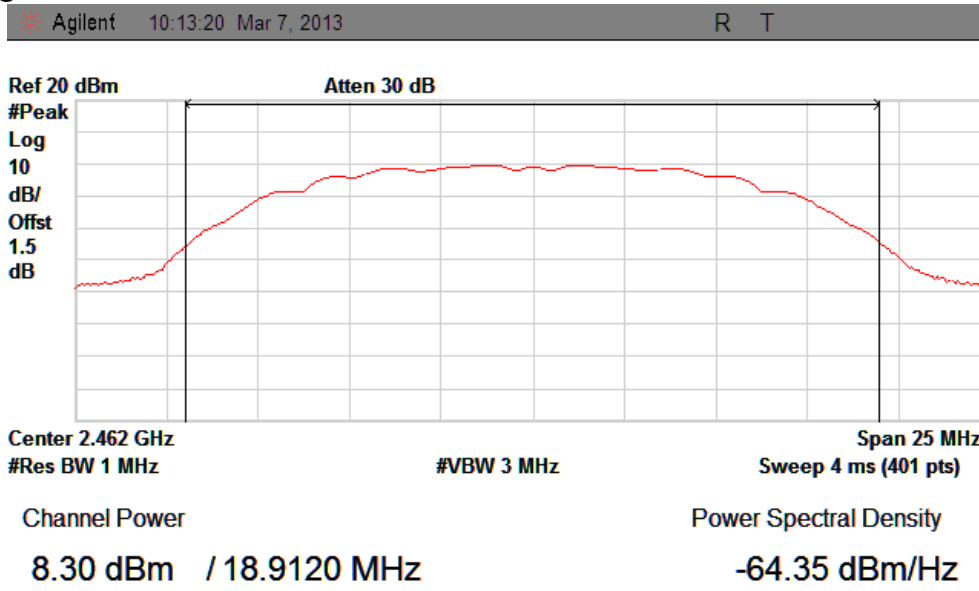

IEEE 802.11n/HT20: CH Low :

Agilent 10:25:14 Mar 7, 2013 R T

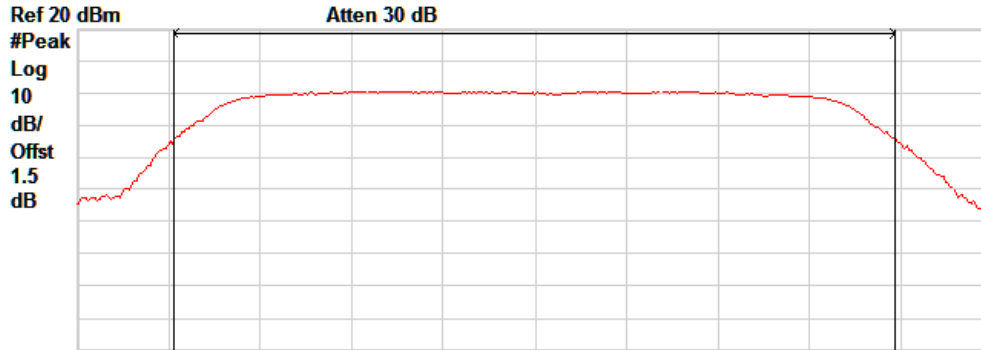

Center 2.412 GHz #Res BW 1 MHz #VBW 3 MHz Span 25 MHz Sweep 4 ms (401 pts)

Channel Power 8.60 dBm / 19.6310 MHz
Power Spectral Density -64.03 dBm/Hz



CH Mid :

Agilent 10:27:49 Mar 7, 2013 R T

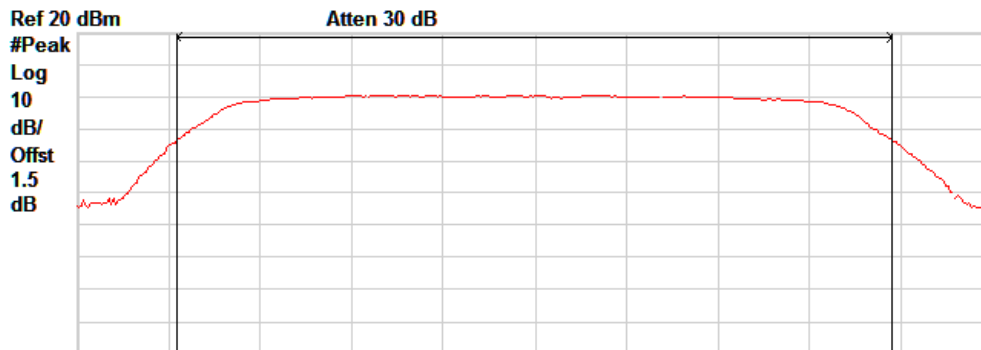

Center 2.437 GHz #Res BW 1 MHz #VBW 3 MHz Span 25 MHz Sweep 4 ms (401 pts)

Channel Power 8.24 dBm / 19.4820 MHz
Power Spectral Density -64.66 dBm/Hz



CH High :

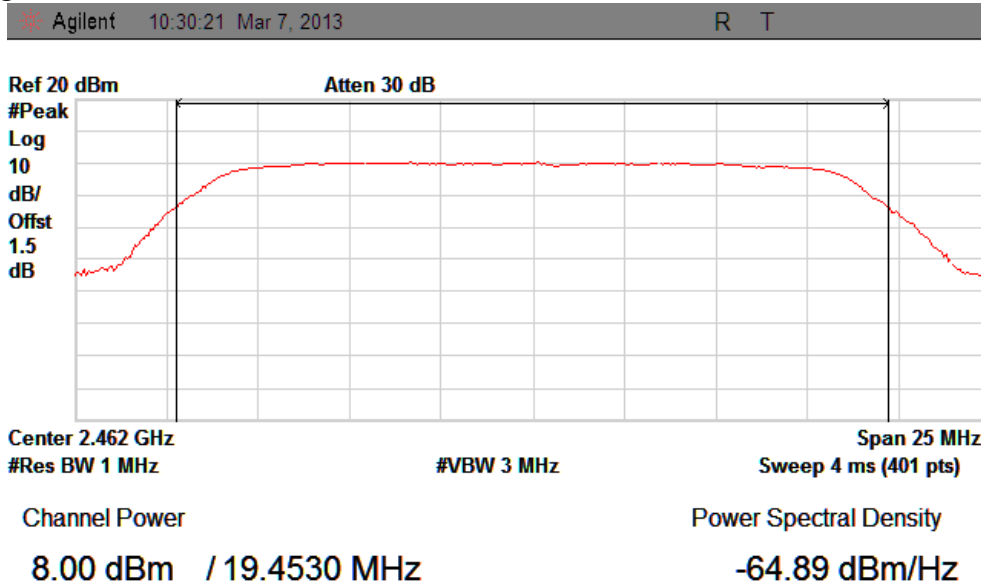

IEEE 802.11n/HT40: CH Low :

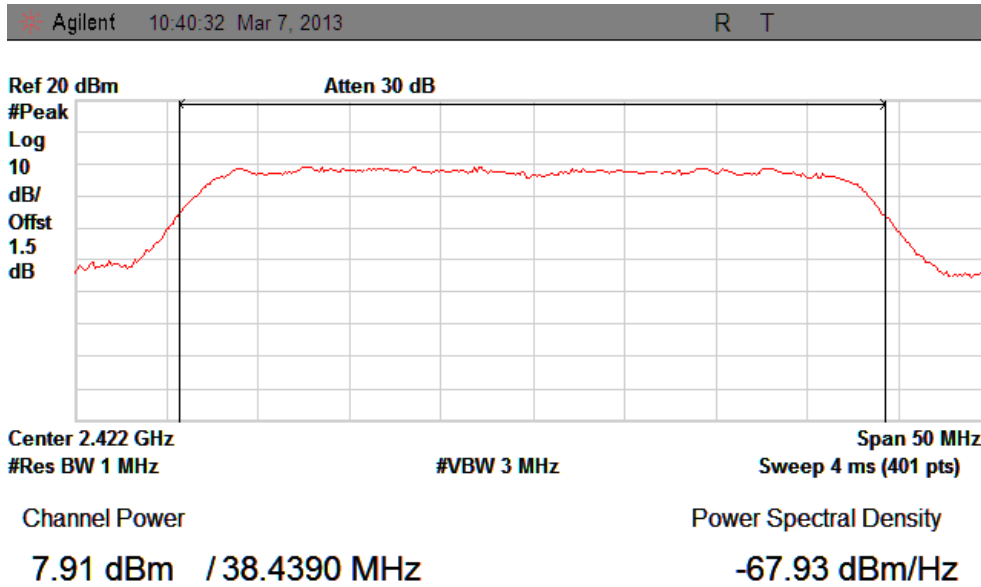

CH Mid :

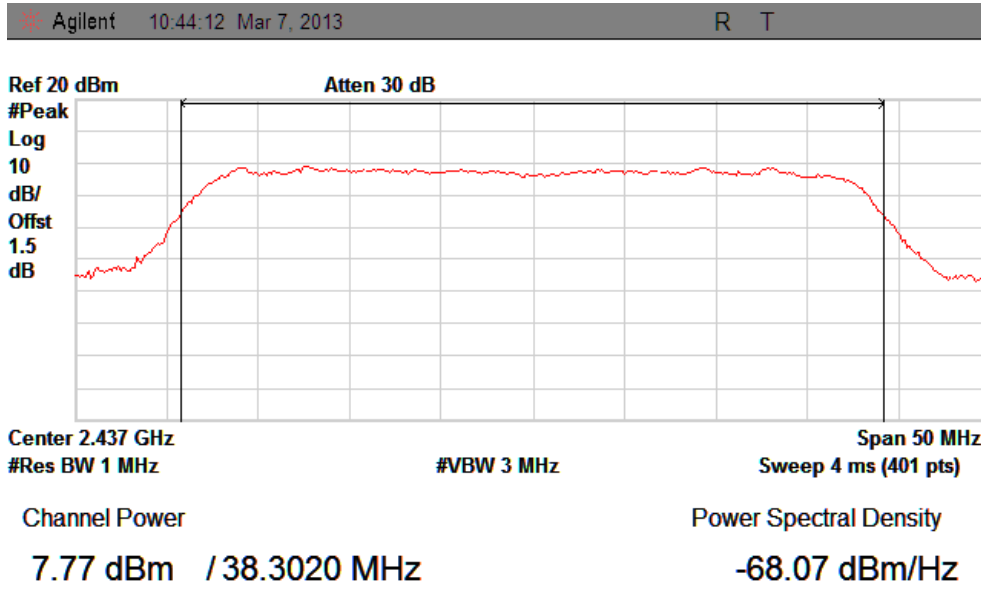

CH High :

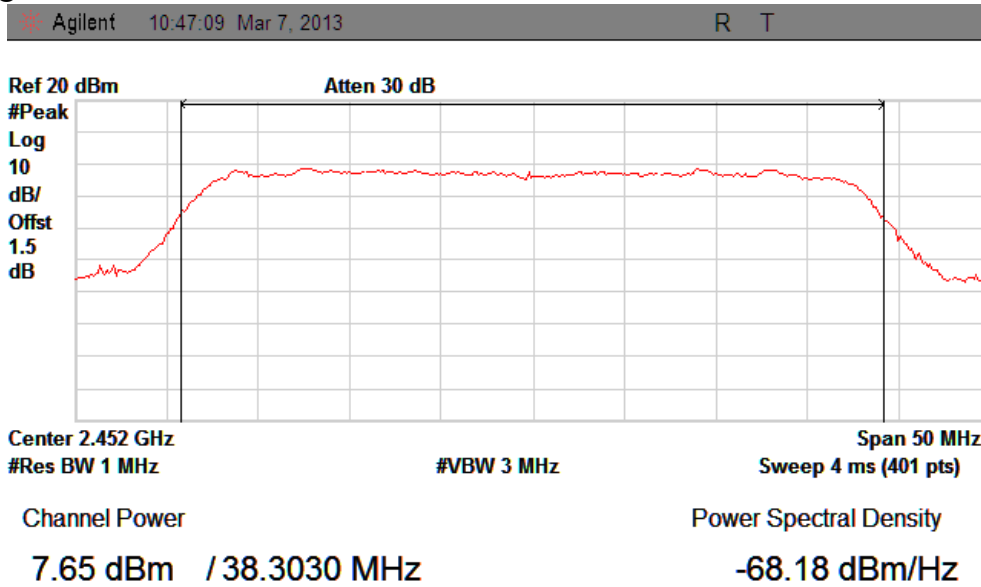

Maximum Average Conducted Output Power

IEEE 802.11b: CH Low :

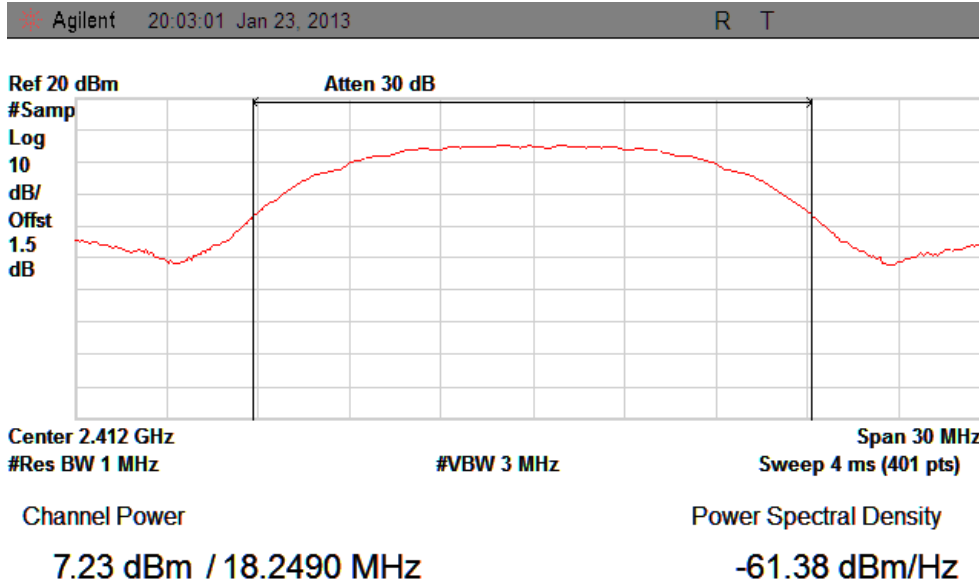

CH Mid :

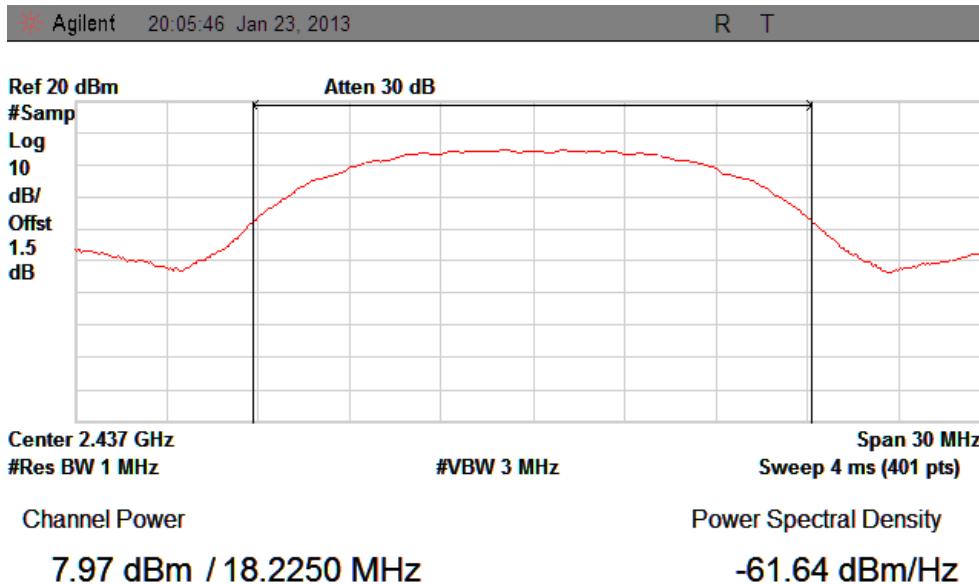

CH High :

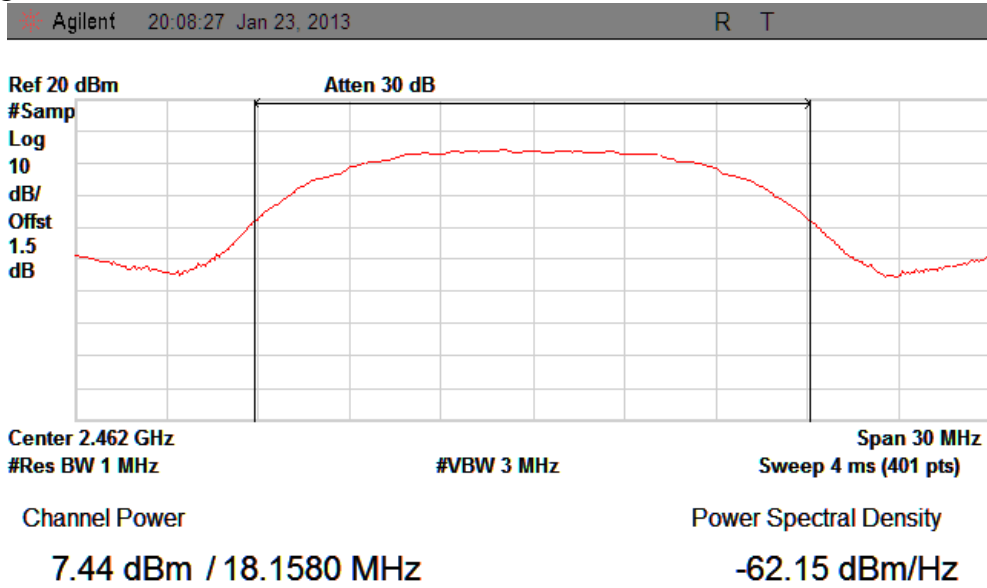

IEEE 802.11g: CH Low :

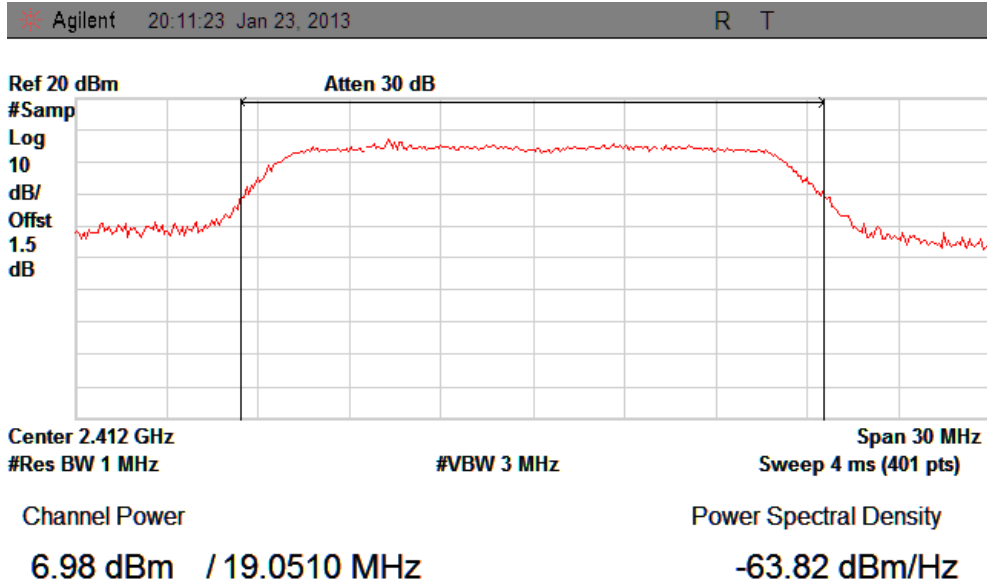

CH Mid :

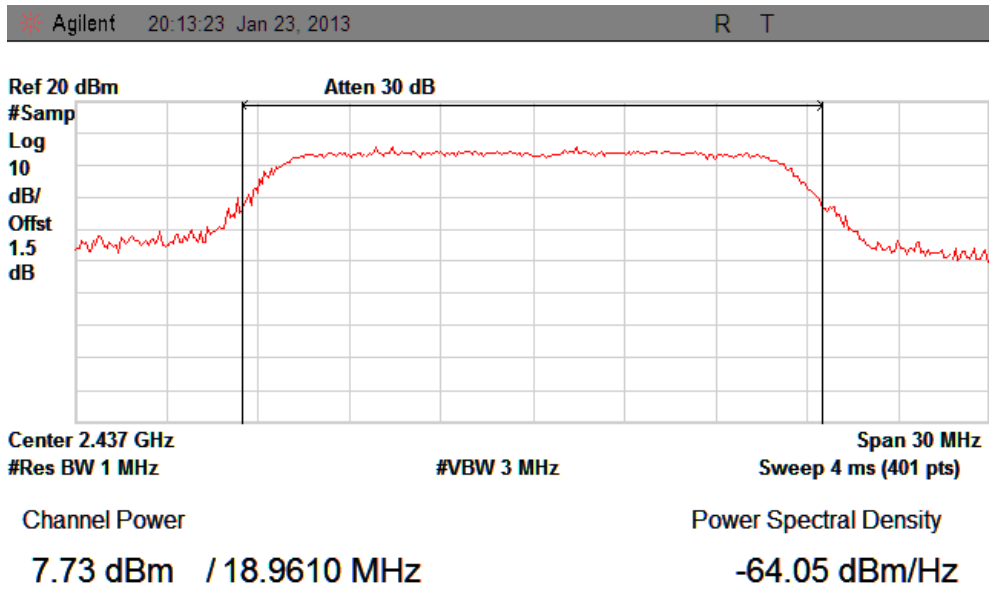

CH High :

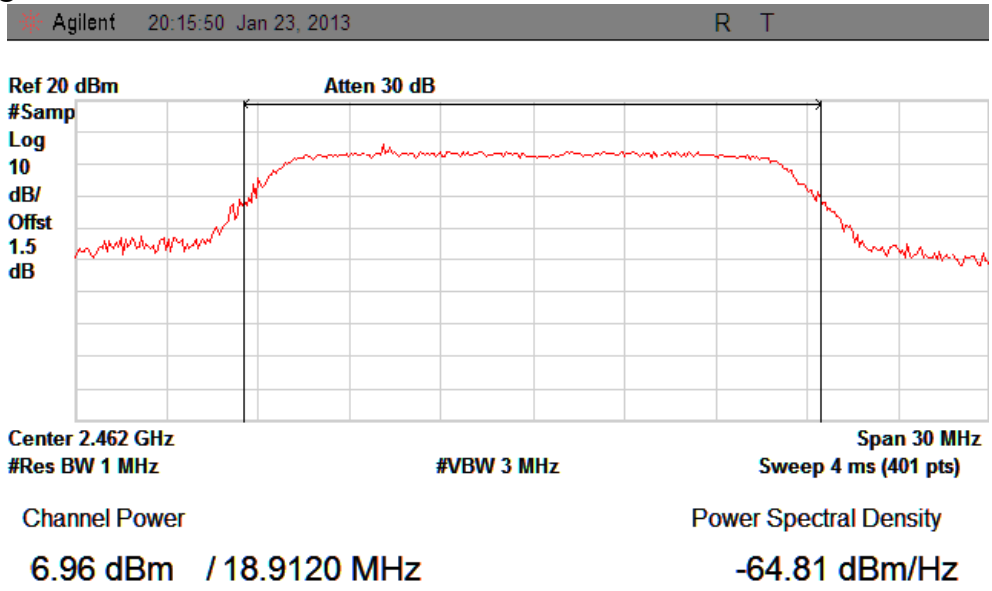

IEEE 802.11n/HT20: CH Low :

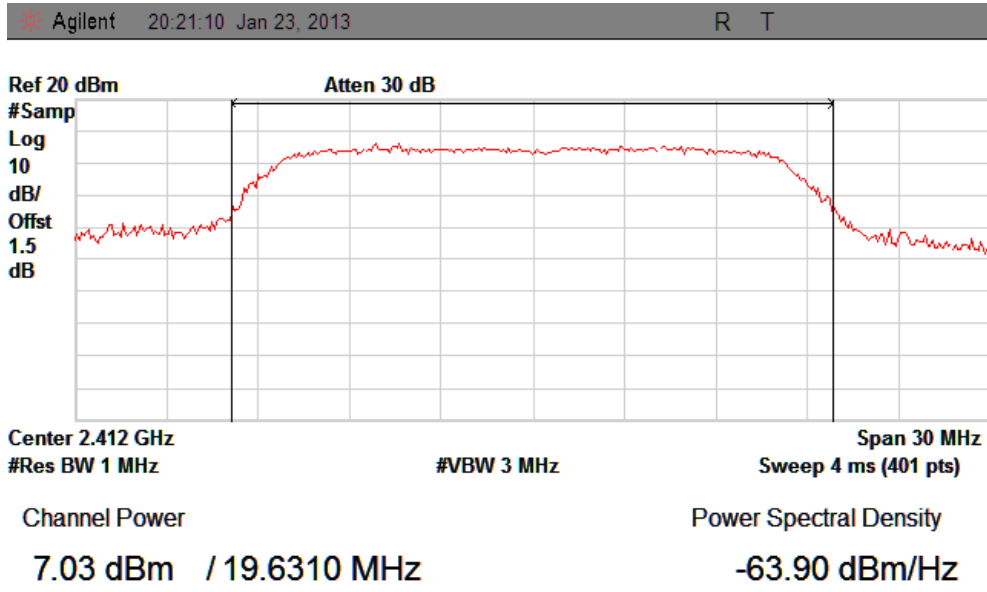

CH Mid :

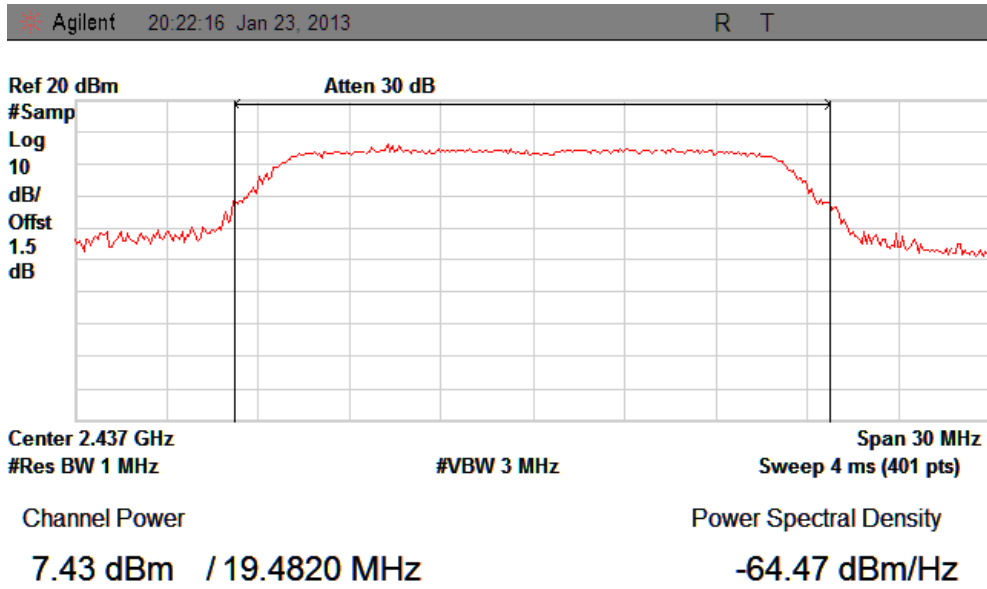

CH High :

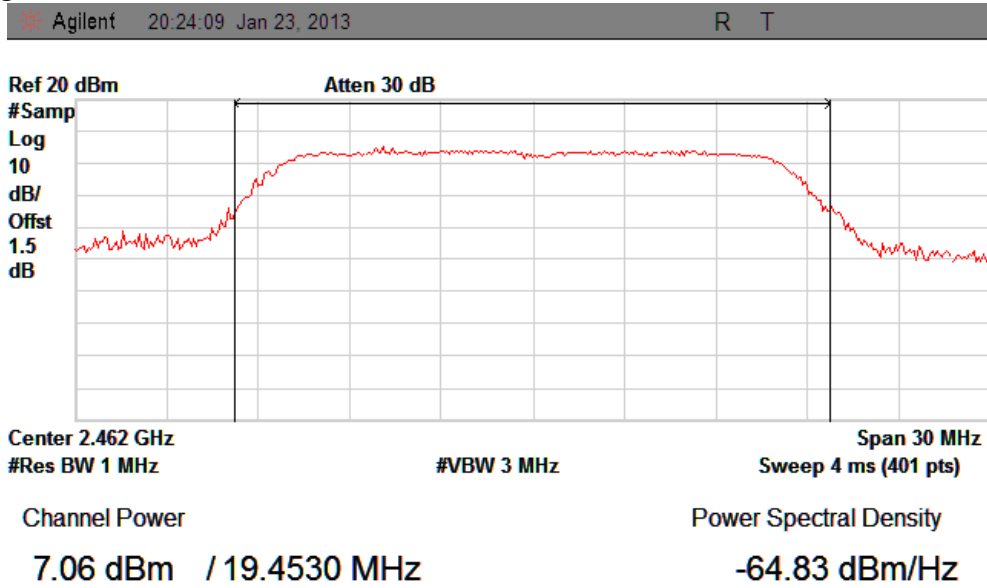

IEEE 802.11n/HT40: CH Low :

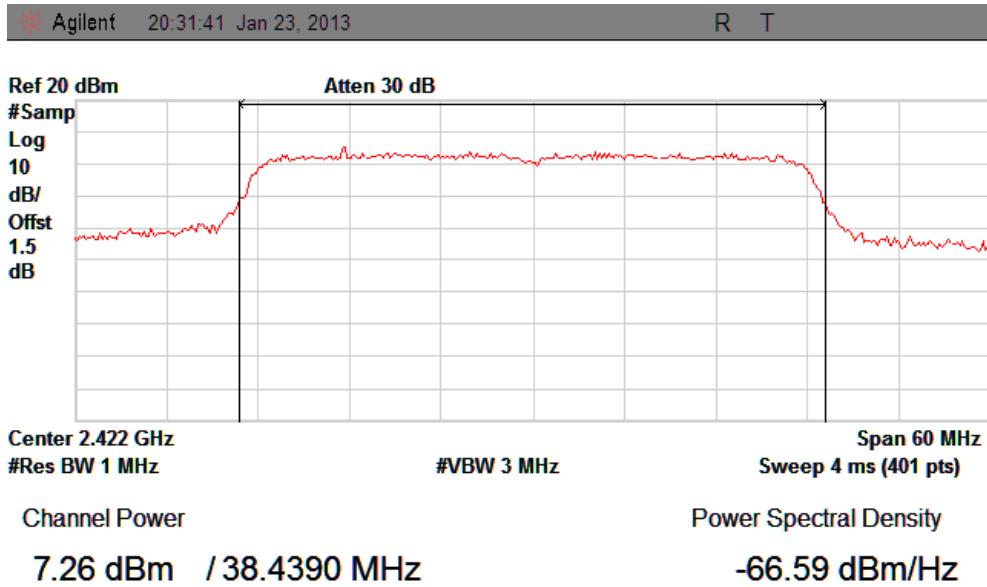

CH Mid :

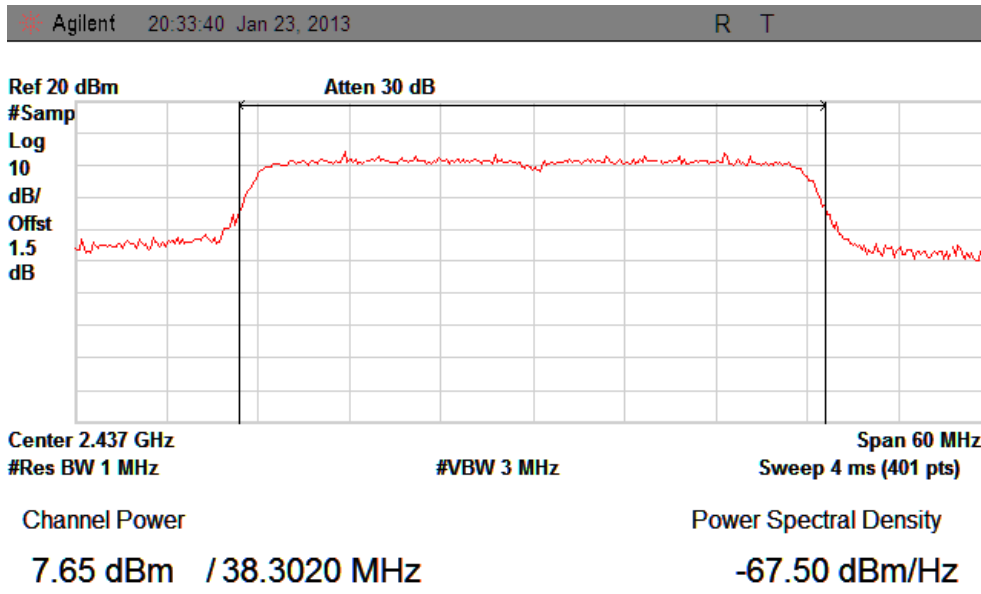

CH High :

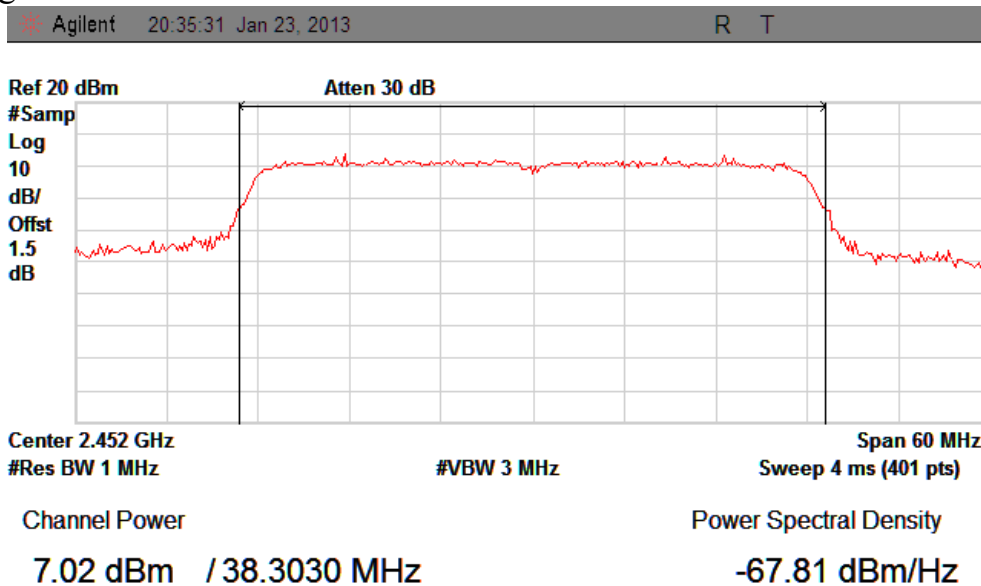

8 PEAK POWER SPECTRAL DENSITY

8.1 Test limit

8.1.1 Please refer section 15.247.

8.1.2 For direct sequence systems, the peak power spectral density conducted from the intentional radiator to the antenna shall not be greater than 8dBm in any 3kHz band during any time interval of continuous transmission.

8.1.3 The direct sequence operating of the hybrid system, with the frequency hopping operation turned off, shall comply with the power density requirements of paragraph (d) of this section.

8.2 Method of measurement

Details see the KDB558074 D01 Meas Guidance

8.2.1 Place the EUT on the table and set it in transmitting mode.

8.2.2 Remove the antenna from the EUT and then connect a low loss RF cable from the antenna port to the spectrum analyzer.

8.2.3 Set the spectrum analyzer as RBW = 3kHz, VBW = 10kHz, span=5-30%EBW, detail see the test plot.

8.2.4 Record the max reading.

8.2.5 Repeat the above procedure until the measurements for all frequencies are completed.

8.3 Test Setup

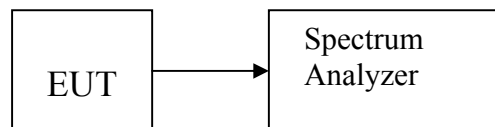

8.4 Test Results

PASS.

Detailed information please see the following page.

Channel	Frequency (MHz)	Power Spectral Density (dBm)	Limit (dBm)	Result
IEEE 802.11b:				
Low	2412	-12.82	8	PASS
Mid	2437	-13.20	8	PASS
High	2462	-13.72	8	PASS
IEEE 802.11g:				
Low	2412	-11.11	8	PASS
Mid	2437	-11.57	8	PASS
High	2462	-12.21	8	PASS
IEEE 802.11n/HT20:				
Low	2412	-11.05	8	PASS
Mid	2437	-11.42	8	PASS
High	2462	-12.06	8	PASS
IEEE 802.11n/HT40:				
Low	2422	-12.11	8	PASS
Mid	2437	-12.43	8	PASS
High	2452	-12.60	8	PASS

IEEE 802.11b:

CH Low :

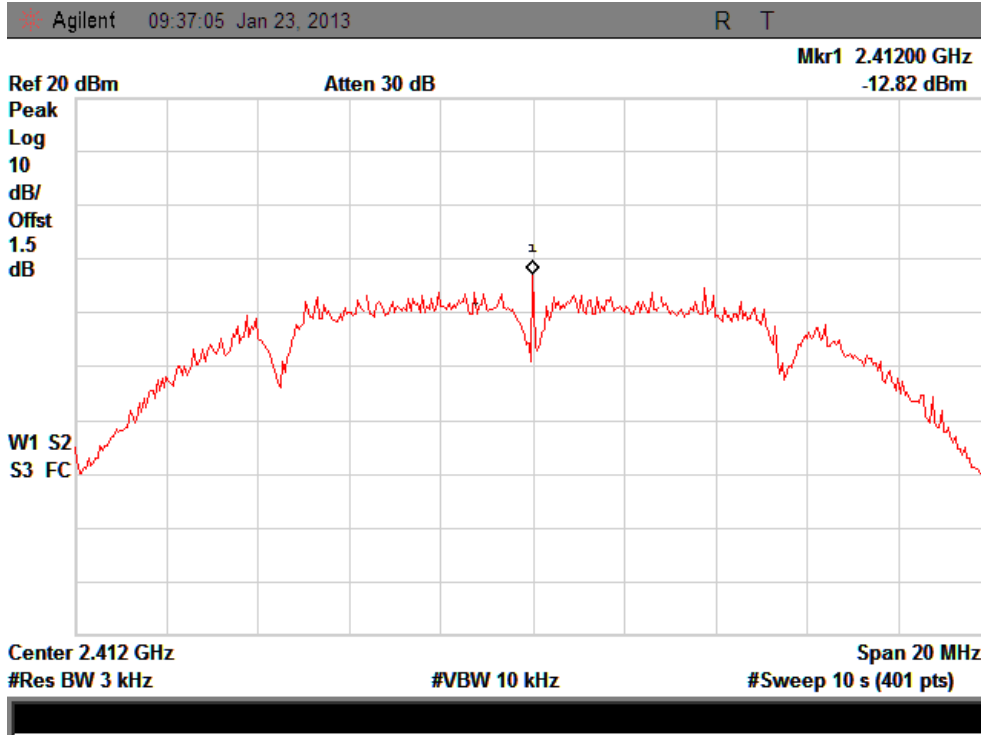

CH Mid :

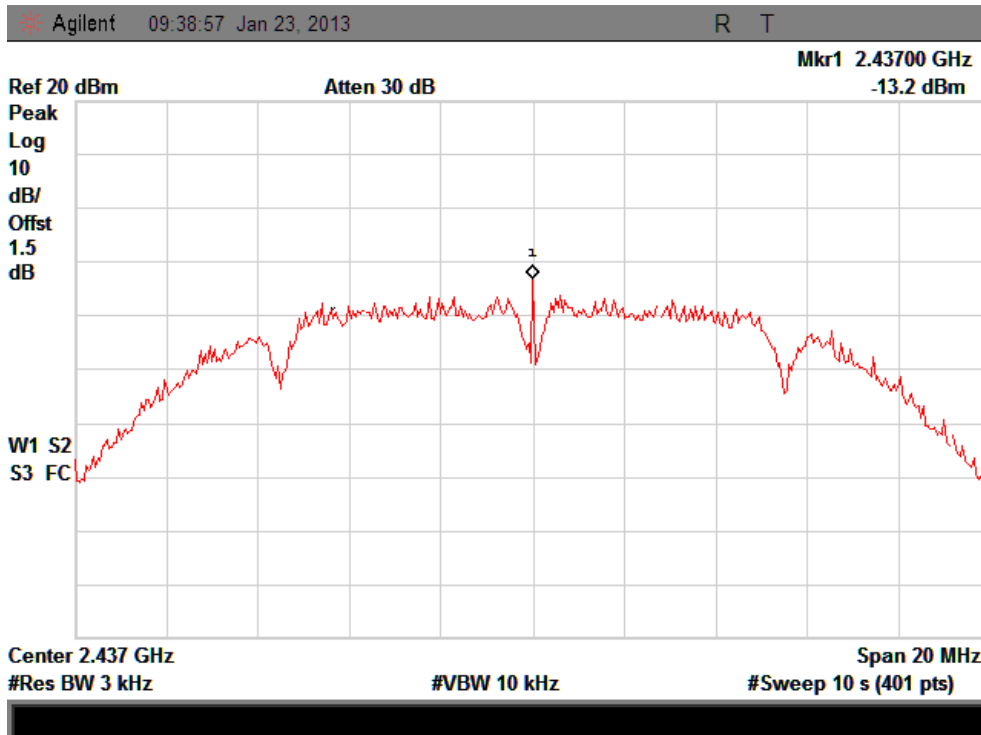

CH High :

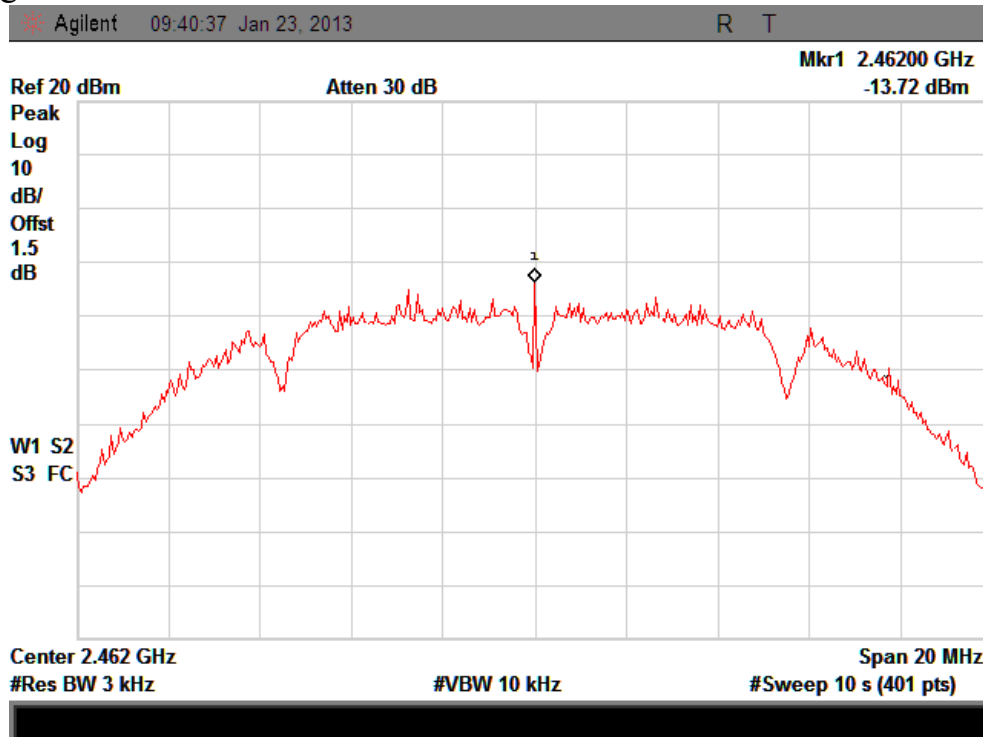

IEEE 802.11g:

CH Low :

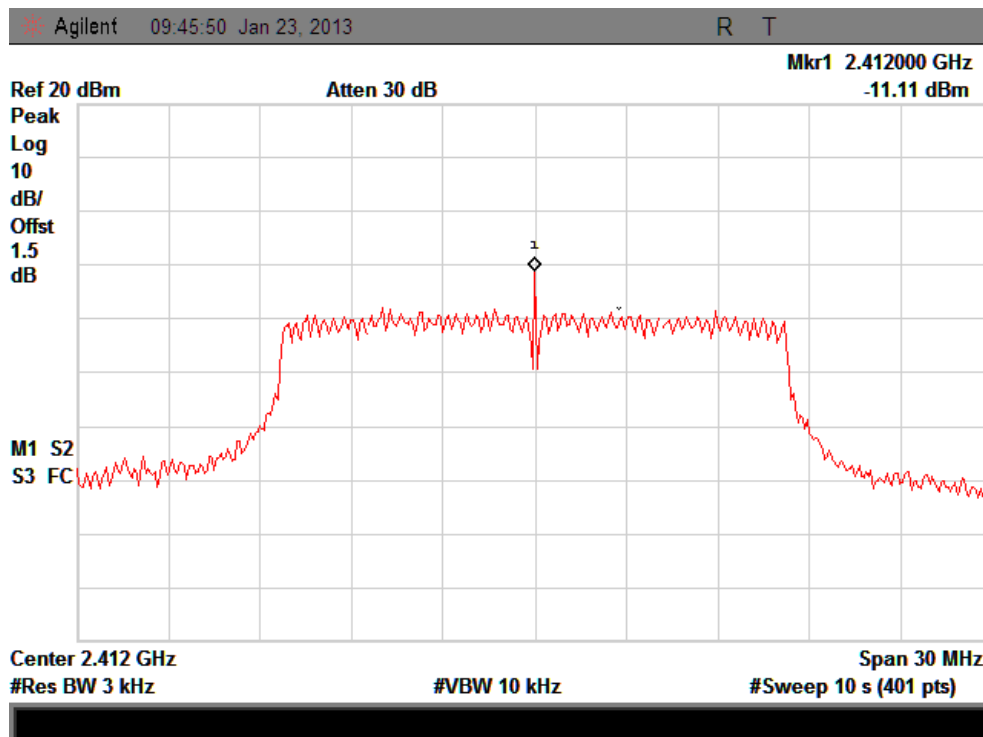

CH Mid :

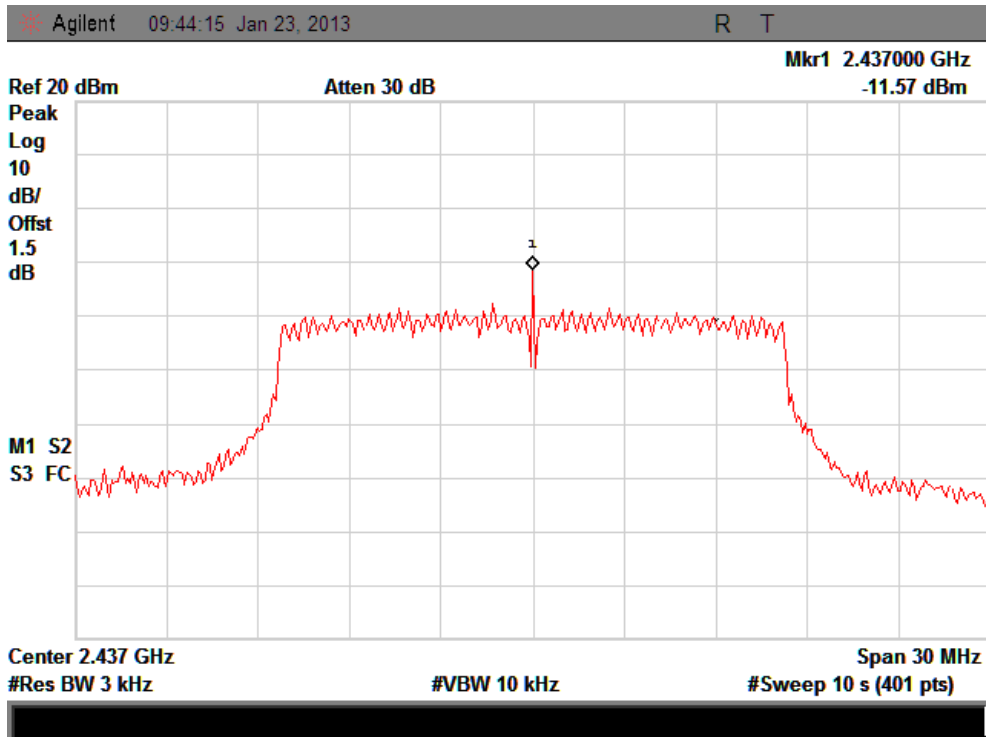

CH High :

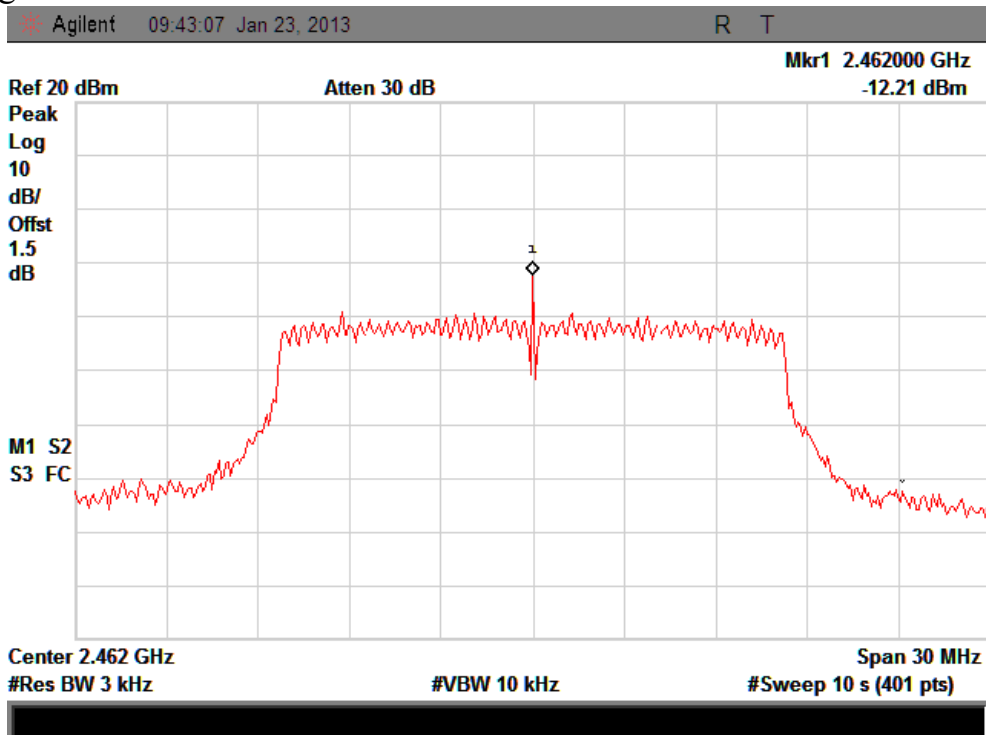

IEEE 802.11n/HT20:

CH Low :

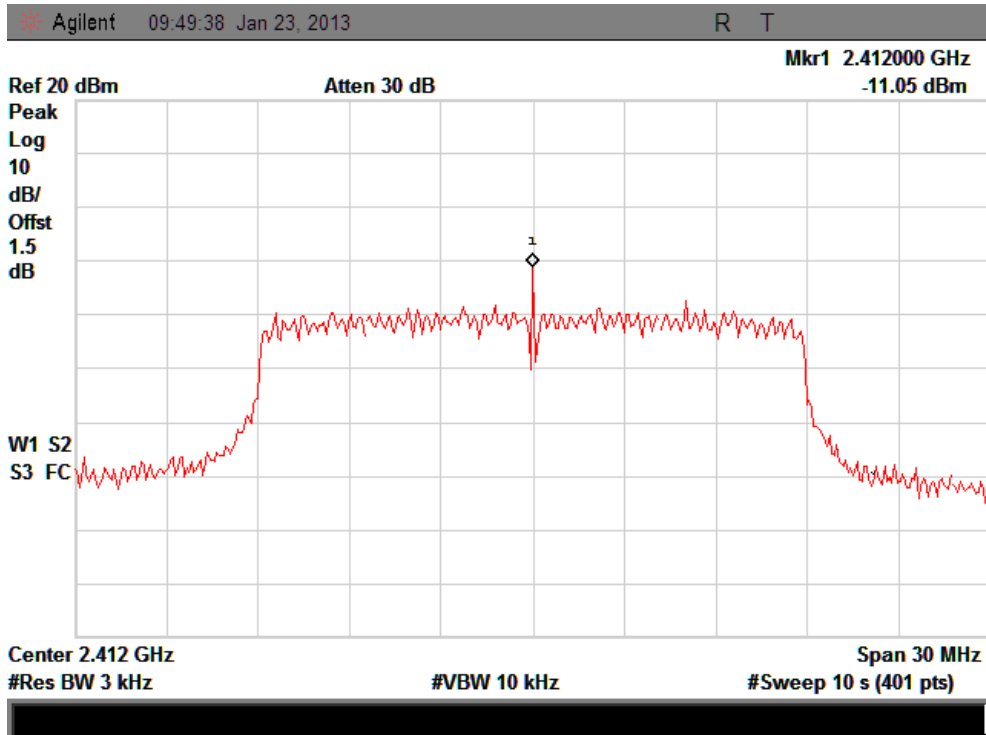

CH Mid :

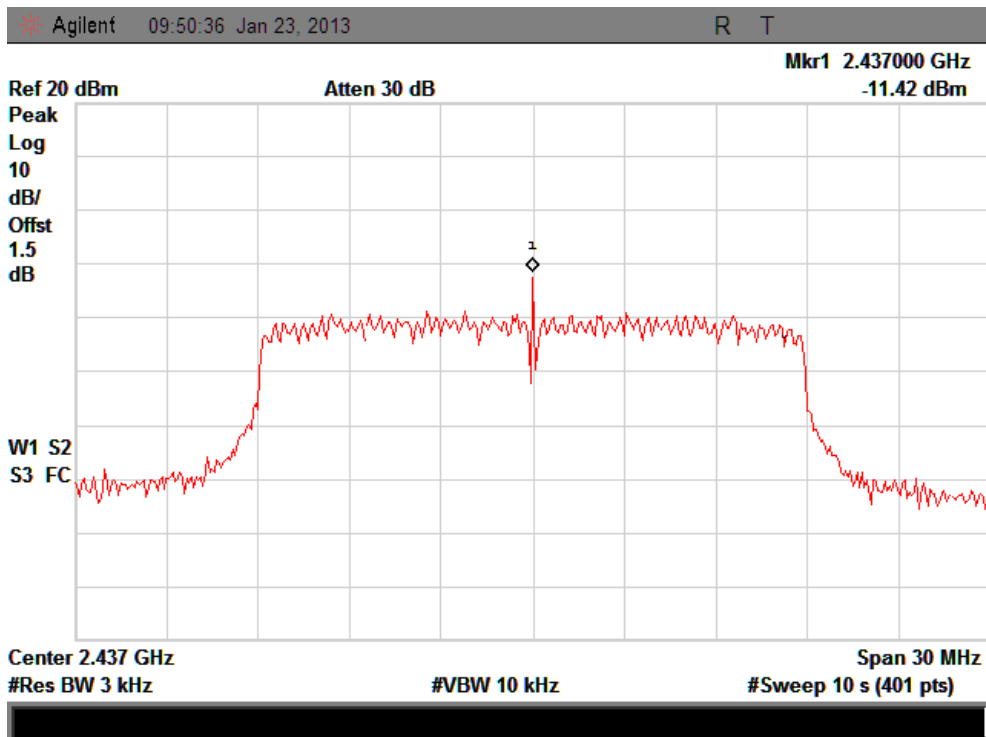

CH High :

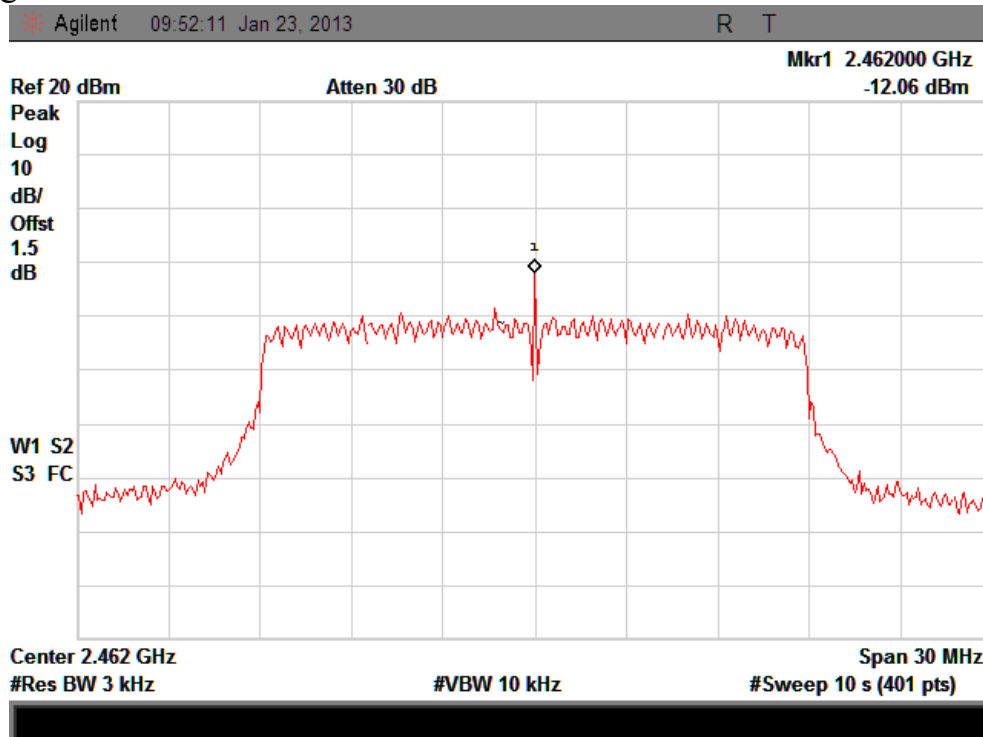

IEEE 802.11n/HT40:

CH Low :

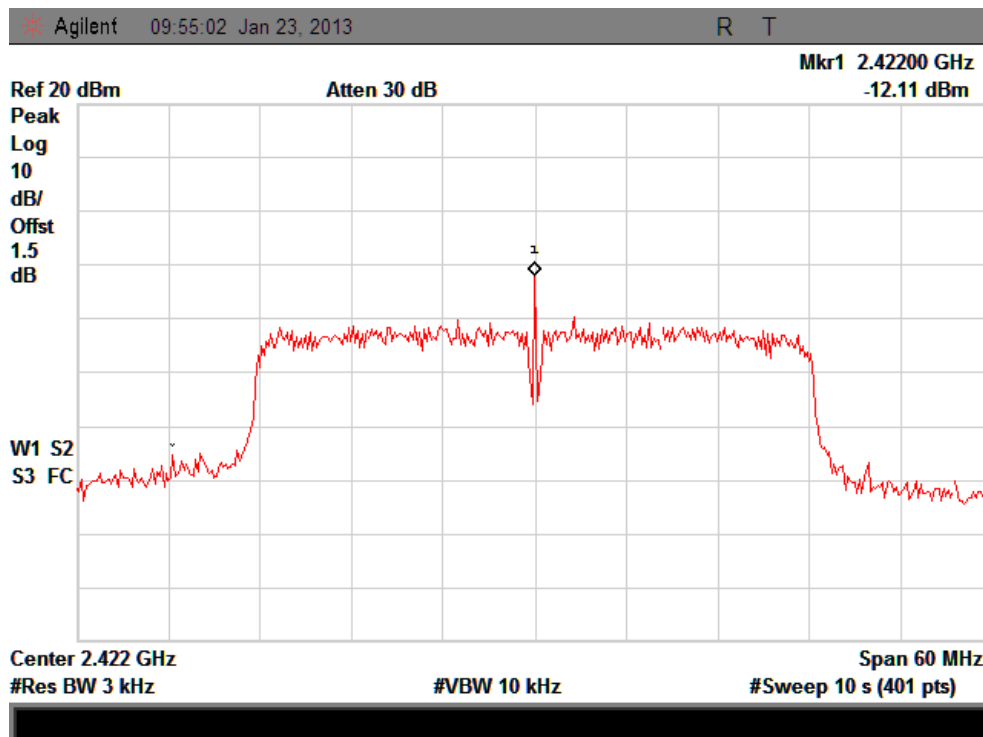

CH Mid :

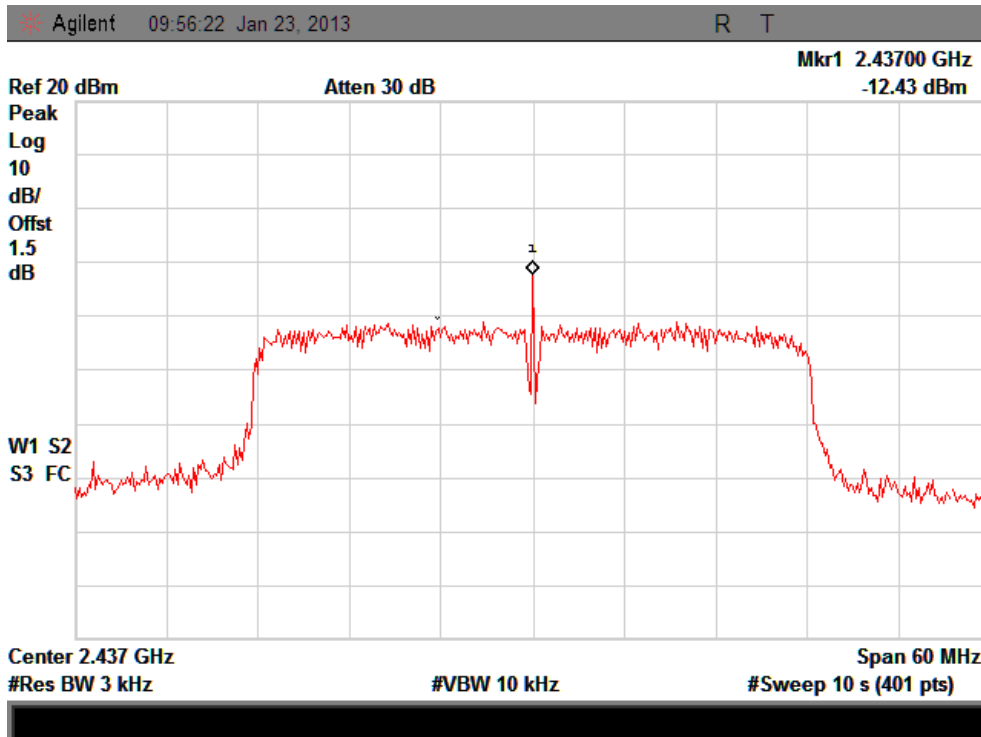

CH High :

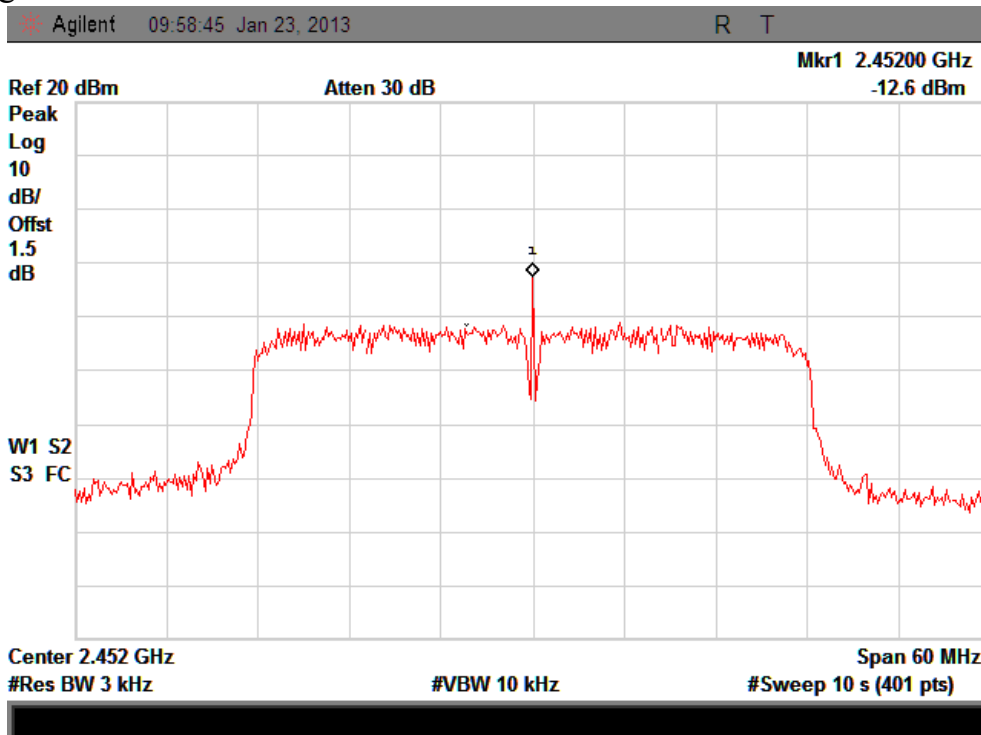

9 6dB Bandwidth

9.1 Test limit

Please refer section 15.247

For direct sequence systems, the minimum 6dB bandwidth shall be at least 500kHz.

9.2 Method of measurement

Details see the KDB558074 D01 Meas Guidance

- a) The bandwidth is measured at an amplitude level reduced 20dB from the reference level. The reference level is the level of the highest amplitude signal observed from the transmitter at the fundamental frequency. Once the reference level is established, the equipment is conditioned with typical modulating signal to produce the worst-case (i.e. the widest) bandwidth.
- b) The test receiver set $RBW = 1-5 \% EBW$, $VBW \geq 3RBW$, Sweep time set auto, detail see the test plot.

9.3 Test Setup

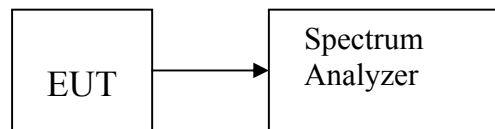

9.4 Test Results

PASS.

Detailed information please see the following page.

Channel	Frequency (MHz)	6dB Bandwidth (MHz)	Limit (MHz)	Result
IEEE 802.11b:				
Low	2412	12.115	0.5	PASS
Mid	2437	12.139	0.5	PASS
High	2462	12.140	0.5	PASS
IEEE 802.11g:				
Low	2412	16.313	0.5	PASS
Mid	2437	16.318	0.5	PASS
High	2462	16.329	0.5	PASS
IEEE 802.11n/HT20:				
Low	2412	17.154	0.5	PASS
Mid	2437	17.161	0.5	PASS
High	2462	17.160	0.5	PASS
IEEE 802.11n/HT40:				
Low	2422	35.259	0.5	PASS
Mid	2437	35.384	0.5	PASS
High	2452	35.267	0.5	PASS

IEEE 802.11b:

CH Low :

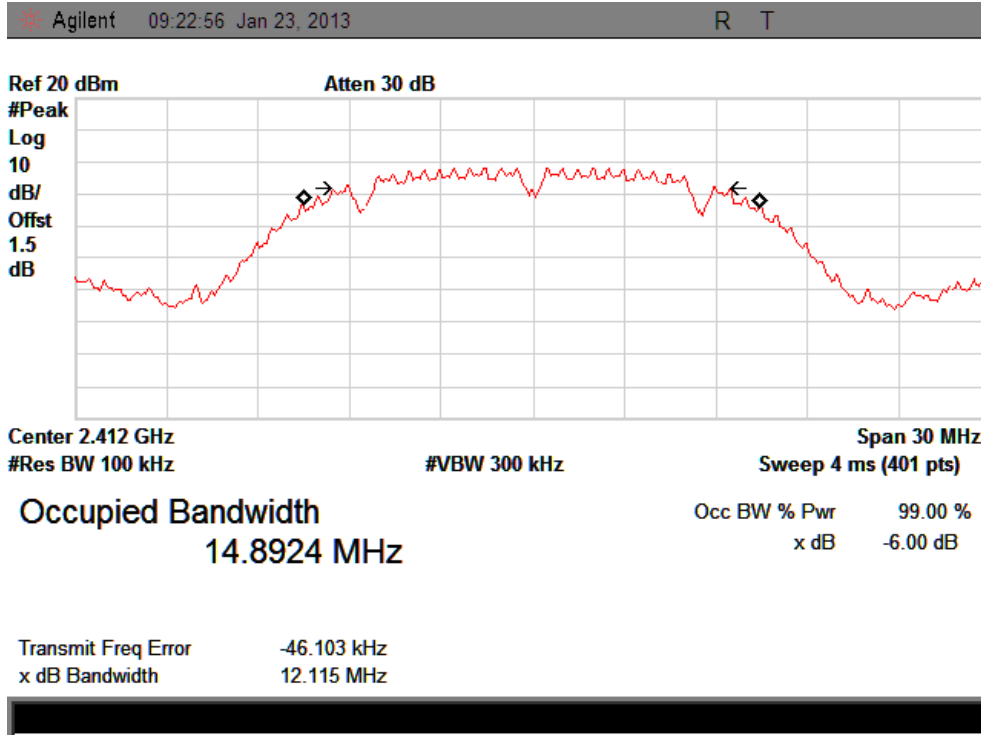

CH Mid :

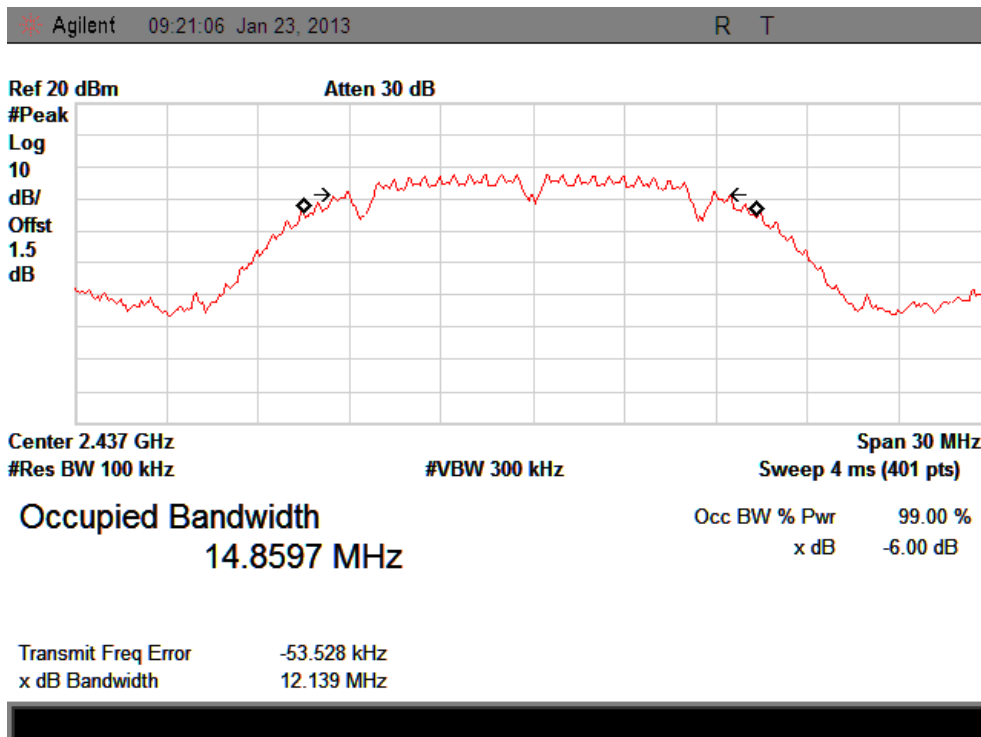

CH High :

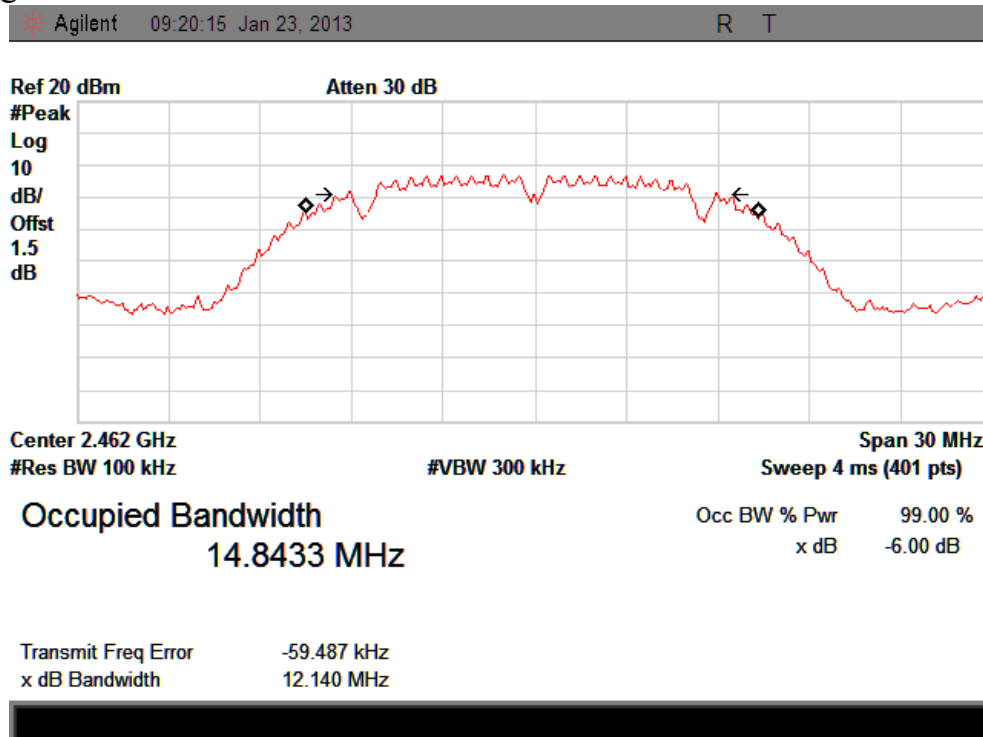

IEEE 802.11g:

CH Low :

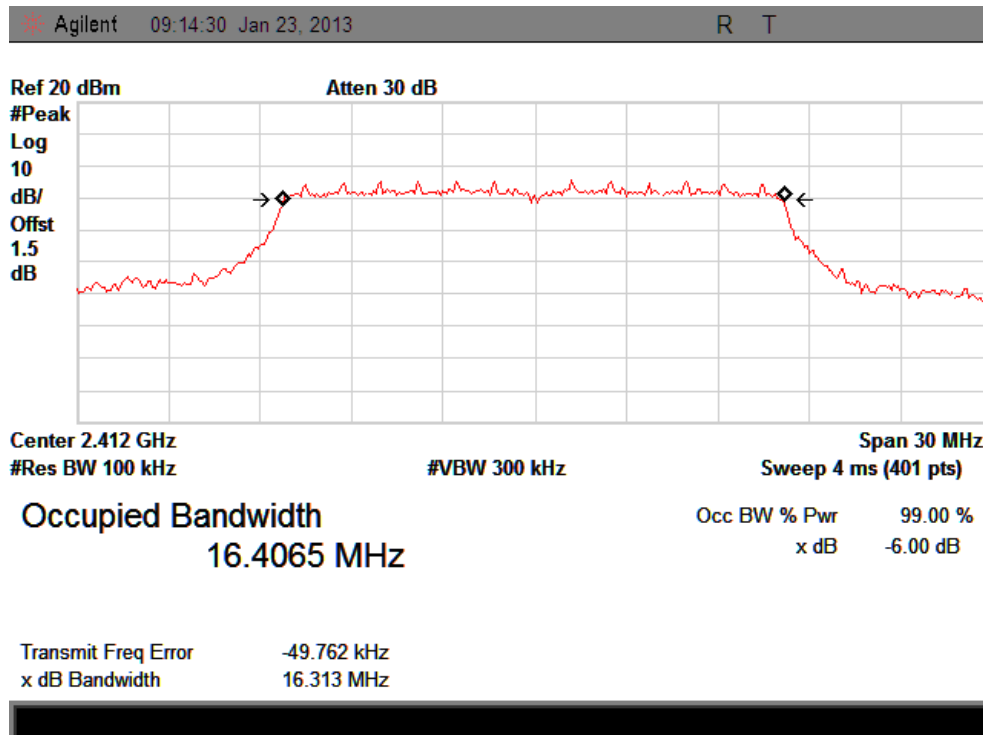

CH Mid :

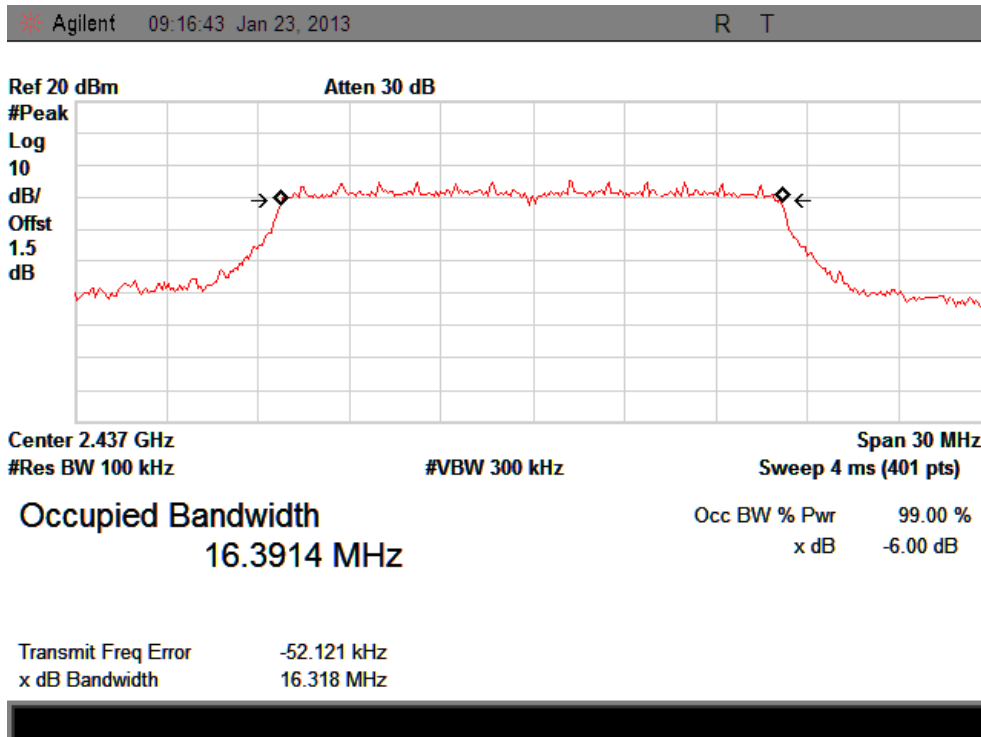

CH High :

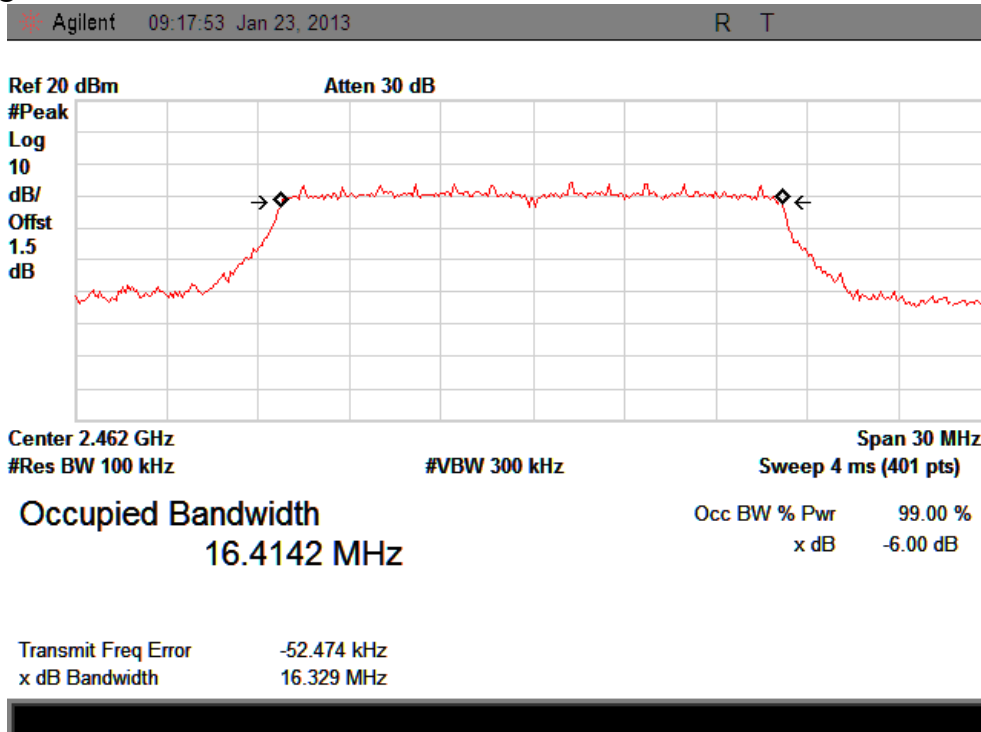

IEEE 802.11n/HT20:

CH Low :

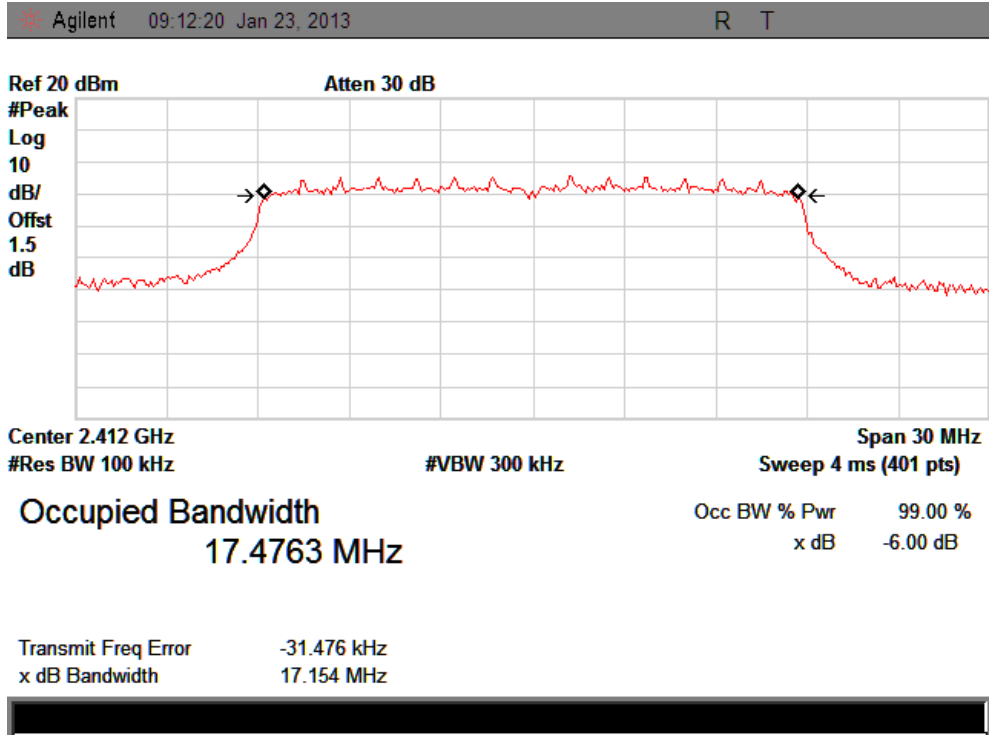

CH Mid :

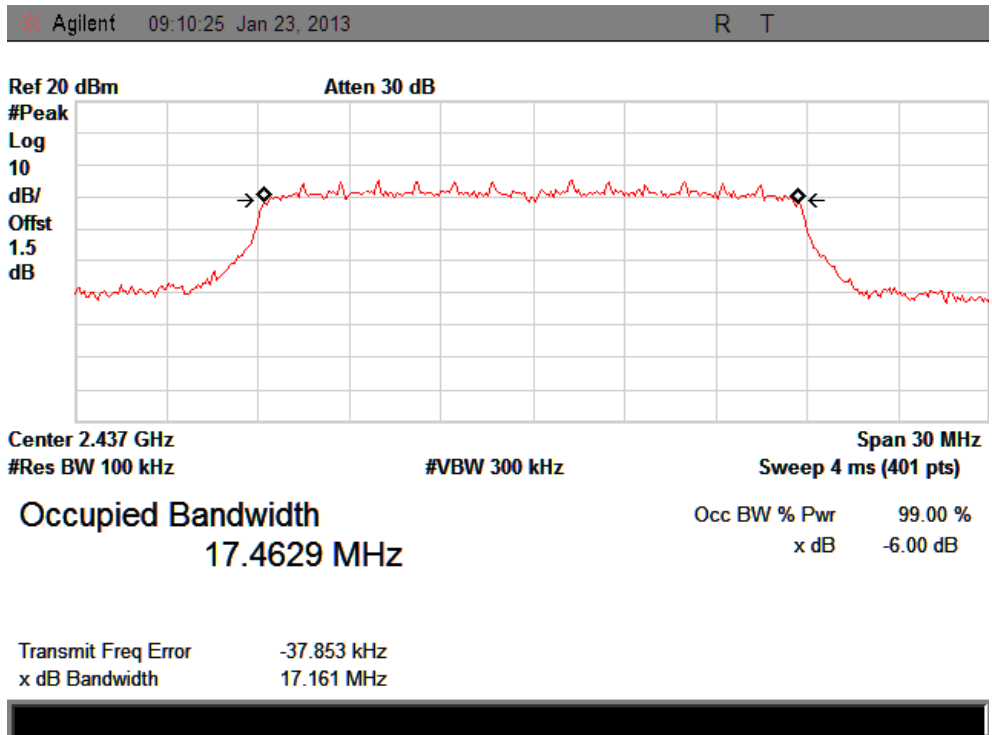

CH High :

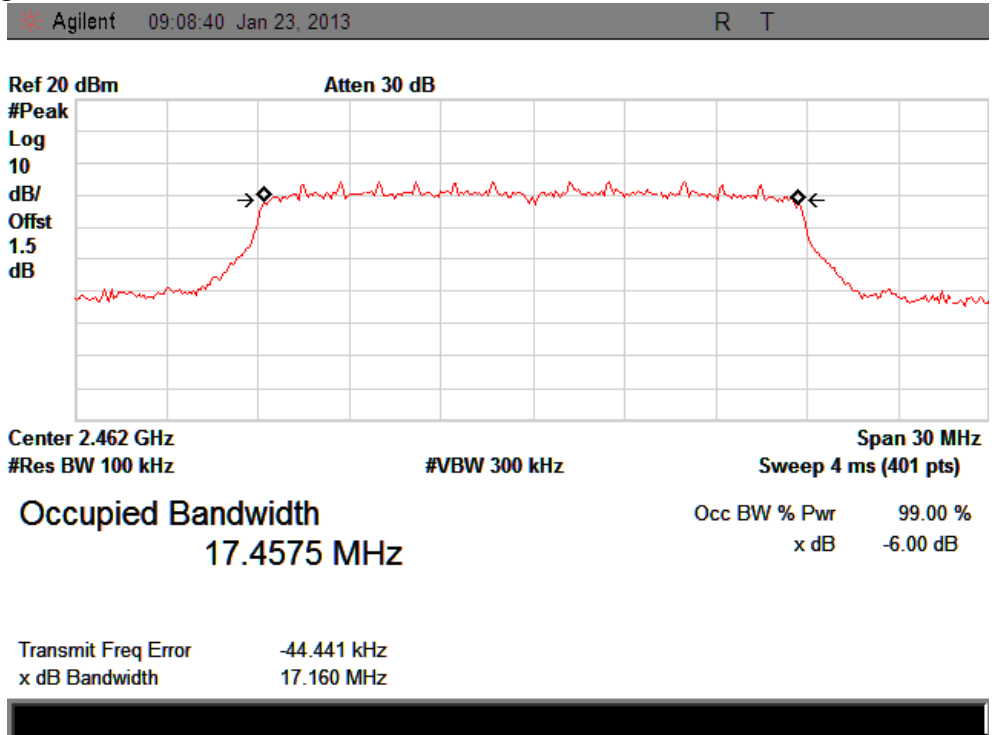

IEEE 802.11n/HT40:

CH Low :

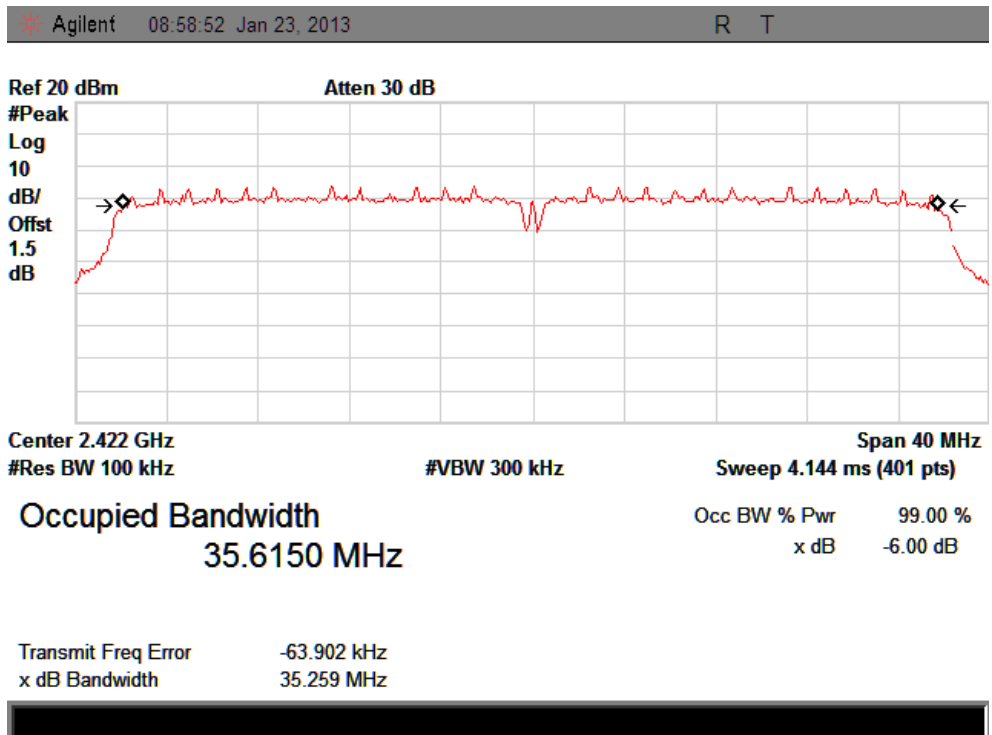

CH Mid :

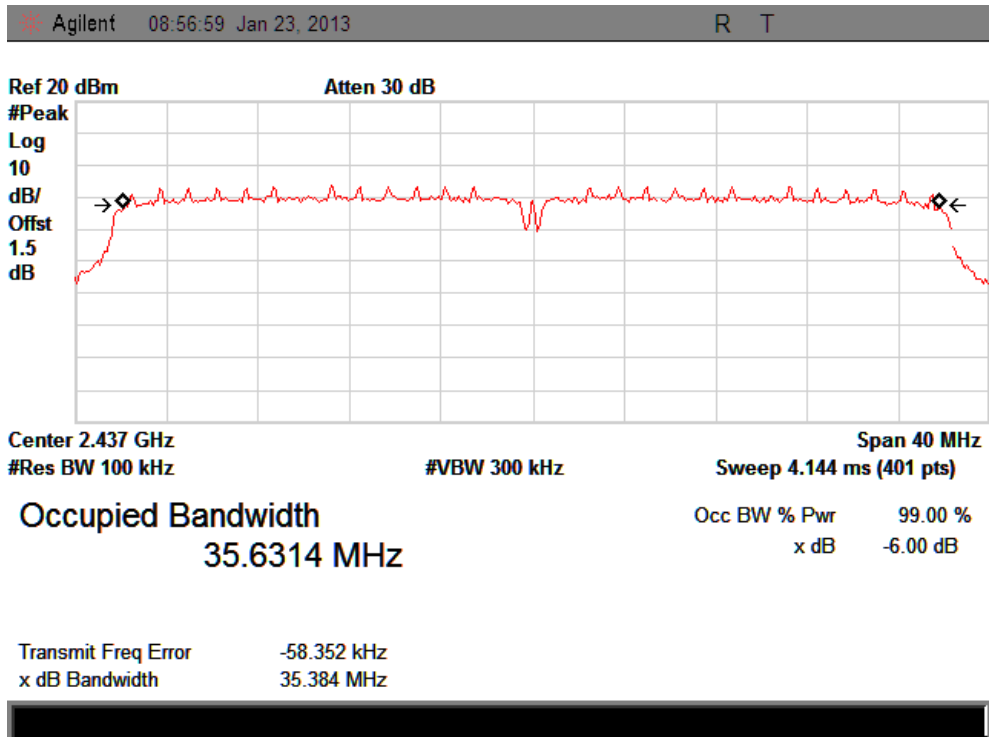

CH High :

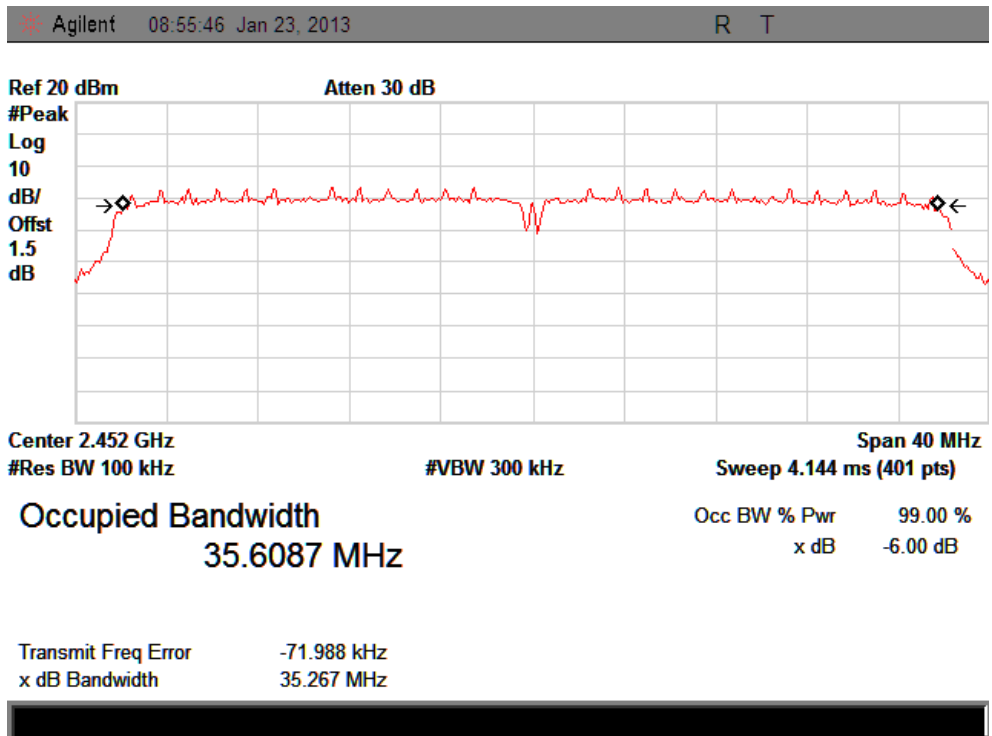

10 Band Edge Check

10.1 Test limit

Please refer section 15.247

All the lower and upper band-edges emissions appearing within 2310MHz to 2390MHz and 2483.5MHz to 2500MHz restricted frequency bands shall not exceed the limits shown in 15.209, all the other emissions outside operation frequency band 2400MHz to 2483.5MHz shall be at least 20dB below the fundamental emissions, or comply with 15.209 limits.

10.2 Test Procedure

12.2.1 Put the EUT on a 0.8m high table, power on the EUT. Emissions were scanned and measured rotating the EUT to 360 degrees, Find the maximum Emission

12.2.2 Check the spurious emissions out of band.

12.2.3 RBW,VBW Setting, please see the following test plot.

10.3 Test Setup

Same as 5.2.2.

10.4 Test Result

PASS.

Detailed information please see the following page.

Report No.: STI130106008

IEEE 802.11b:
CH LOW :



Shenzhen Certification Technology Service Co., Ltd
2F, Building B, East Area of Nanchang Second Industrial Zone,
Gushu 2nd Road, Bao'an District, Shenzhen 518126, P.R. China
Tel: 4006786199 FAX: +86-755-26736857
Website: <http://www.cessz.com> Email: Service@cessz.com

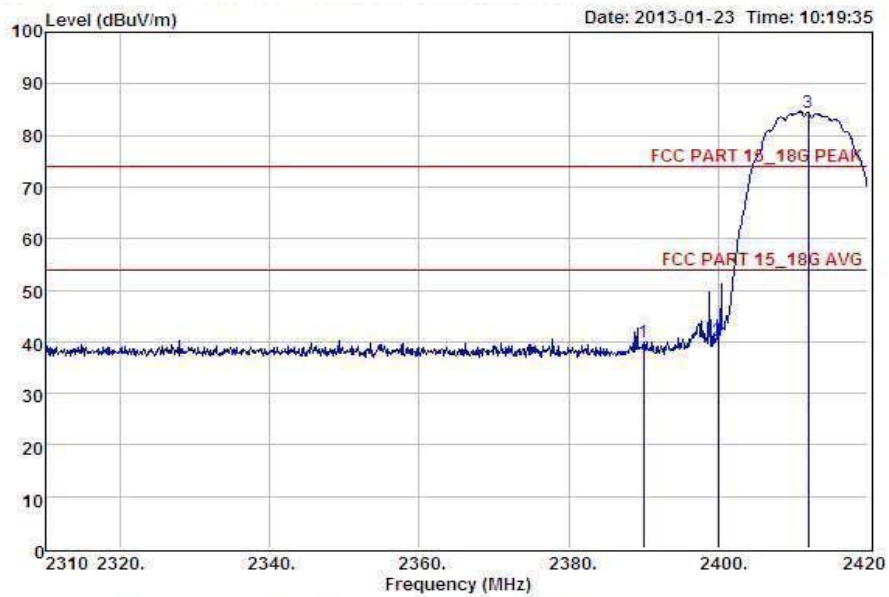

Condition : FCC PART 15_18G PEAK 3m POL: HORIZONTAL
EUT : Wi-Fi Disk
Model No : S3
Test Mode : IEEE.802.b CH Low: 2412
Power : DC 5V From PC With AC 120V/60Hz adapter
Test Engineer : Eric
Remark :

Item	Freq MHz	Read Level dBuV	Antenna Factor dB	Preamp Factor dB	Cable Loss dB	Level dBuV	Limit dBuV	Margin dBuV	Remark
1	2390.00	43.25	27.62	34.97	3.92	39.82	74.00	-34.18	Peak
2	2400.00	43.52	27.62	34.97	3.94	40.11	74.00	-33.89	Peak
3	2412.00	87.90	27.61	34.97	3.95	84.49	74.00	10.49	Peak

Remark: Level = Read Level + Antenna Factor - Preamp Factor + Cable Loss



Shenzhen Certification Technology Service Co., Ltd
 2F, Building B, East Area of Nanchang Second Industrial Zone,
 Gushu 2nd Road, Bao'an District, Shenzhen 518126, P.R. China
 Tel: 4006786199 FAX: +86-755-26736857
 Website: <http://www.cessz.com> Email: Service@cessz.com

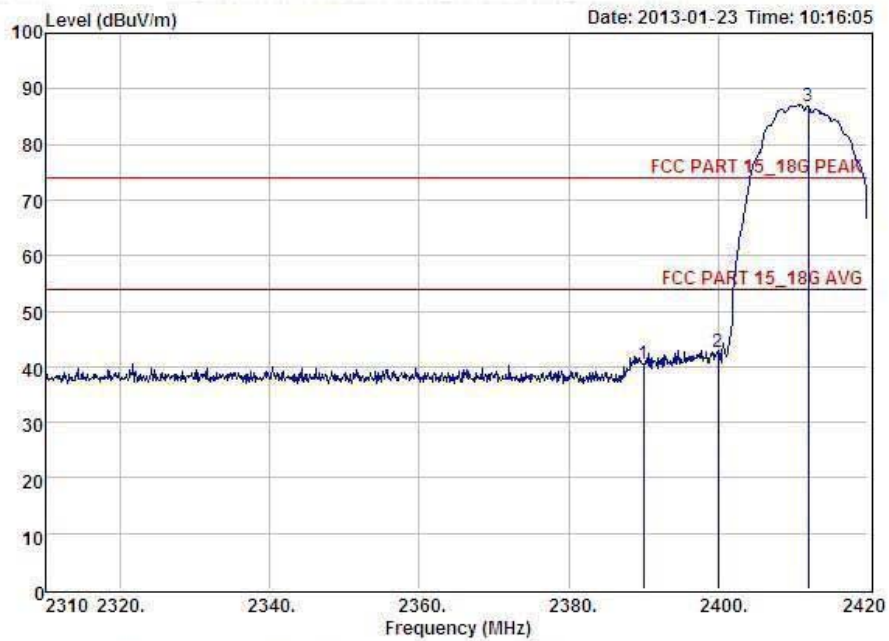

Condition : FCC PART 15_18G PEAK 3m POL: VERTICAL
 EUT : Wi-Fi Disk
 Model No : S3
 Test Mode : IEEE.802.b CH Low: 2412
 Power : DC 5V From PC With AC 120V/60Hz adapter
 Test Engineer : Eric
 Remark :

Item	Freq MHz	Read Level dBuV	Antenna Factor dB	Preamp Factor dB	Cable Loss dB	Level dBuV	Limit dBuV	Margin dBuV	Remark
1	2390.00	43.85	27.62	34.97	3.92	40.42	74.00	-33.58	
2	2400.00	45.98	27.62	34.97	3.94	42.57	74.00	-31.43	
3	2412.00	90.28	27.61	34.97	3.95	86.87	74.00	12.87	

Remark: Level = Read Level + Antenna Factor - Preamp Factor + Cable Loss

CH High :



Shenzhen Certification Technology Service Co., Ltd
 2F, Building B, East Area of Nanchang Second Industrial Zone
 Gushu 2nd Road, Bao'an District, Shenzhen 518126, P.R. China
 Tel: 4006786199 FAX: +86-755-26736857
 Website: <http://www.cessz.com> Email: Service@cessz.com

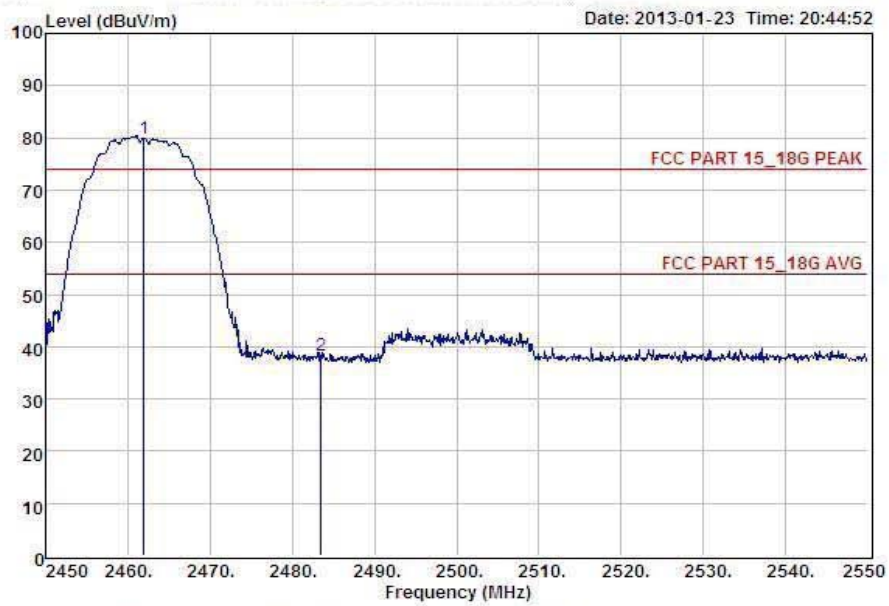

Condition : FCC PART 15_18G PEAK Sm. POL: HORIZONTAL
 EUT : Wi-Fi Disk
 Model No : S3
 Test Mode : IEEE.802.b CH High: 2462
 Power : DC 5V From PC With AC 120V/60Hz adapter
 Test Engineer : Eric
 Remark :

Item	Freq MHz	Read Level dBuV	Antenna Factor dB	Preamp Factor dB	Cable Loss dB	Level dBuV	Limit dBuV	Margin dBuV	Remark
1	2462.00	83.37	27.59	34.97	3.98	79.97	74.00	5.97	Peak
2	2483.50	41.83	27.59	34.97	4.00	38.45	74.00	-35.55	Peak

Remark: Level = Read Level + Antenna Factor - Preamp Factor + Cable Loss



Shenzhen Certification Technology Service Co., Ltd
 2F, Building B, East Area of Nanchang Second Industrial Zone,
 Gushu 2nd Road, Bao'an District, Shenzhen 518126, P.R. China
 Tel: 4006786199 FAX: +86-755-26736857
 Website: <http://www.cessz.com> Email: Service@cessz.com

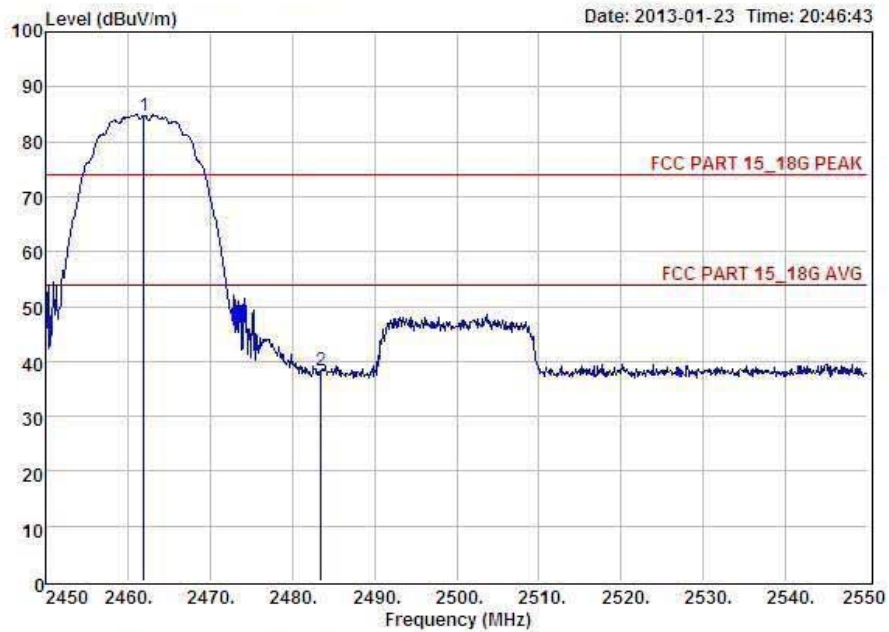

Condition : FCC PART 15_18G PEAK 3m. POL: VERTICAL
 EUT : Wi-Fi Disk
 Model No : S3
 Test Mode : IEEE.802.b CH High: 2462
 Power : DC 5V From PC With AC 120V/60Hz adapter
 Test Engineer : Eric
 Remark :

Item	Freq MHz	Read Level dBuV	Antenna Factor dB	Preamp Factor dB	Cable Loss dB	Level dBuV	Limit dBuV	Margin dBuV	Remark
1	2462.00	88.22	27.59	34.97	3.98	84.82	74.00	10.82	Peak
2	2483.50	41.73	27.59	34.97	4.00	38.35	74.00	-35.65	Peak

Remark: Level = Read Level + Antenna Factor - Preamp Factor + Cable Loss

Report No.: ST1130106008

IEEE 802.11g:
CH LOW :



Shenzhen Certification Technology Service Co., Ltd
2F, Building B, East Area of Nanchang Second Industrial Zone,
Gushu 2nd Road, Bao'an District, Shenzhen 518126, P.R. China
Tel: 4006786199 FAX: +86-755-26736857
Website: <http://www.cessz.com> Email: Service@cessz.com

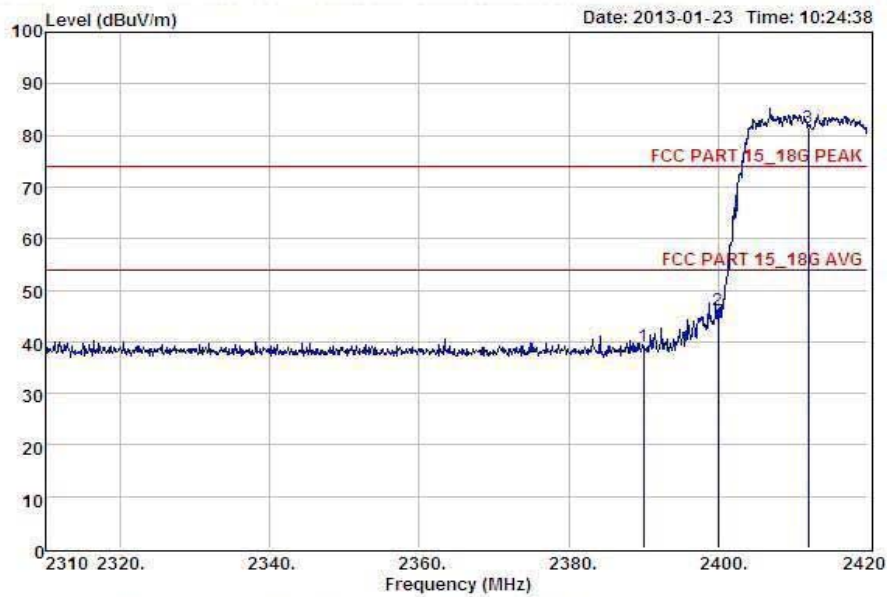

Condition : FCC PART 15_18G PEAK 3m POL: HORIZONTAL
EUT : Wi-Fi Disk
Model No : S3
Test Mode : IEEE.802.g CH Low: 2412
Power : DC 5V From PC With AC 120V/60Hz adapter
Test Engineer : Eric
Remark :

Item	Freq MHz	Read Level dBuV	Antenna Factor dB	Preamp Factor dB	Cable Loss dB	Level dBuV	Limit dBuV	Margin dBuV	Remark
1	2390.00	42.46	27.62	34.97	3.92	39.03	74.00	-34.97	Peak
2	2400.00	49.52	27.62	34.97	3.94	46.11	74.00	-27.89	Peak
3	2412.00	64.89	27.61	34.97	3.95	61.48	74.00	-7.48	Peak

Remark: Level = Read Level + Antenna Factor - Preamp Factor + Cable Loss



Shenzhen Certification Technology Service Co., Ltd
 2F, Building B, East Area of Nanchang Second Industrial Zone,
 Gushu 2nd Road, Bao'an District, Shenzhen 518126, P.R. China
 Tel: 4006786199 FAX: +86-755-26736857
 Website: <http://www.cessz.com> Email: Service@cessz.com

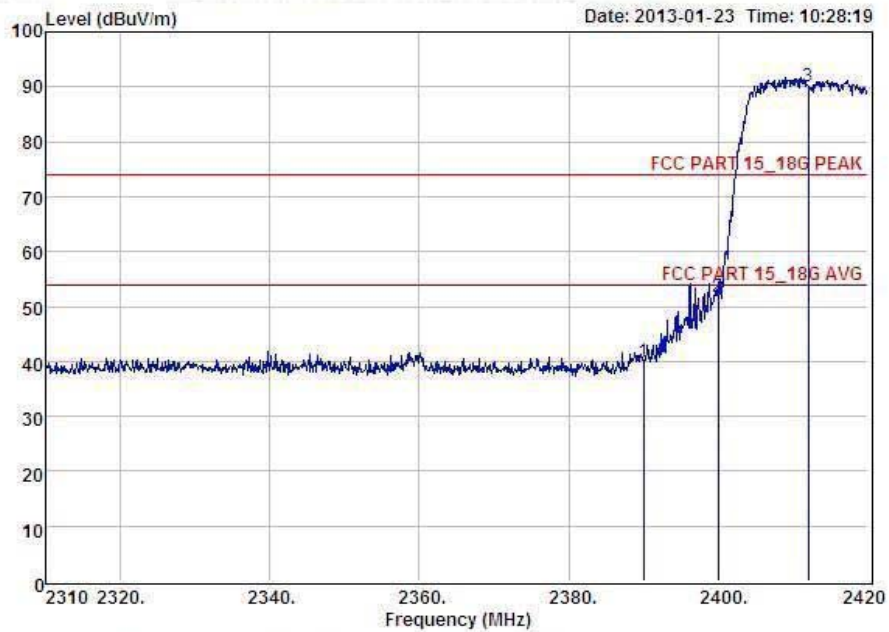

Condition : FCC PART 15_18G PEAK 3m. POL: VERTICAL
 EUT : Wi-Fi Disk
 Model No : S3
 Test Mode : IEEE.802.g CH Low: 2412
 Power : DC 5V From PC With AC 120V/60Hz adapter
 Test Engineer : Eric
 Remark :

Item	Freq MHz	Read Level dBuV	Antenna Factor dB	Preamp Factor dB	Cable Loss dB	Level dBuV	Limit dBuV	Margin dBuV	Remark
1	2390.00	43.44	27.62	34.97	3.92	40.01	74.00	-33.99	Peak
2	2400.00	55.06	27.62	34.97	3.94	51.65	74.00	-22.35	Peak
3	2412.00	93.57	27.61	34.97	3.95	90.16	74.00	16.16	Peak

Remark: Level = Read Level + Antenna Factor - Preamp Factor + Cable Loss

CH High :



Shenzhen Certification Technology Service Co., Ltd
 2F, Building B, East Area of Nanchang Second Industrial Zone,
 Gushu 2nd Road, Bao'an District, Shenzhen 518126, P.R. China
 Tel: 4006786199 FAX: +86-755-26736857
 Website: <http://www.cessz.com> Email: Service@cessz.com

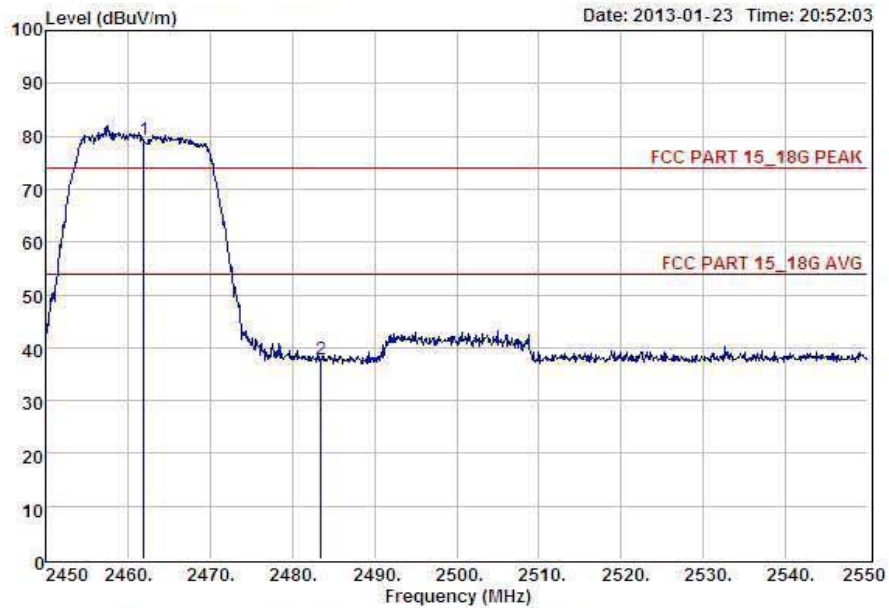

Condition : FCC PART 15_18G PEAK 3m. POL: HORIZONTAL
 EUT : Wi-Fi Disk
 Model No : S3
 Test Mode : IEEE.802.g CH High: 2462
 Power : DC 5V From PC With AC 120V/60Hz adapter
 Test Engineer : Eric
 Remark :

Item	Freq MHz	Read Level dBuV	Antenna Factor dB	Preamp Factor dB	Cable Loss dB	Level dBuV	Limit dBuV	Margin dBuV	Remark
1	2462.00	82.73	27.59	34.97	3.98	79.33	74.00	5.33	Peak
2	2483.50	41.19	27.59	34.97	4.00	37.81	74.00	-36.19	Peak

Remark: Level = Read Level + Antenna Factor - Preamp Factor + Cable Loss



Shenzhen Certification Technology Service Co., Ltd
 2F, Building B, East Area of Nanchang Second Industrial Zone,
 Gushu 2nd Road, Bao'an District, Shenzhen 518126, P.R. China
 Tel: 4006786199 FAX: +86-755-26736857
 Website: <http://www.cessz.com> Email: Service@cessz.com

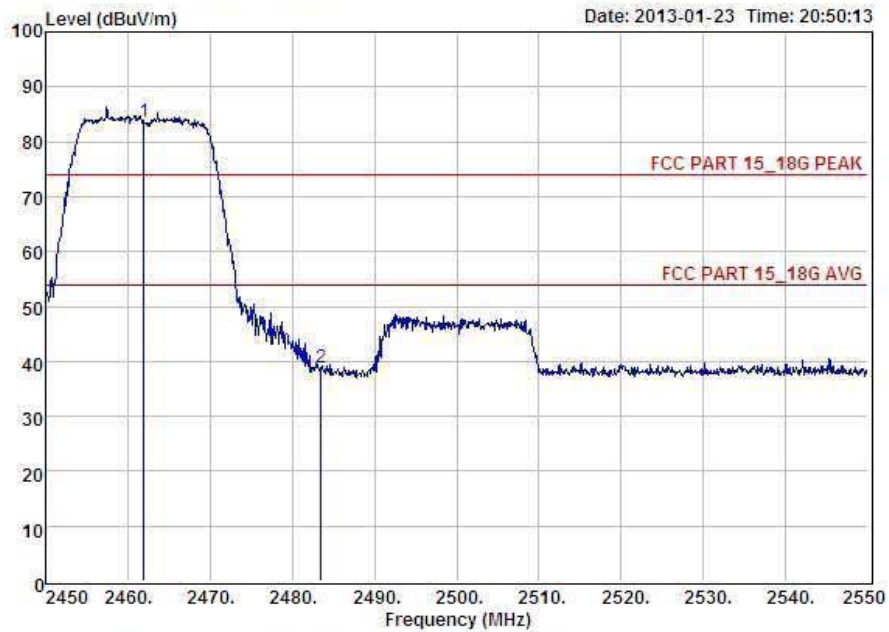

Condition : FCC PART 15_18G PEAK 3m. POL: VERTICAL
 EUT : Wi-Fi Disk
 Model No : S3
 Test Mode : IEEE.802.g CH High: 2462
 Power : DC 5V From PC With AC 120V/60Hz adapter
 Test Engineer : Eric
 Remark :

Item	Freq MHz	Read Level dBuV	Antenna Factor dB	Preamp Factor dB	Cable Loss dB	Level dBuV	Limit dBuV	Margin dBuV	Remark
1	2462.00	87.16	27.59	34.97	3.98	83.76	74.00	9.76	Peak
2	2483.50	42.26	27.59	34.97	4.00	38.88	74.00	-35.12	Peak

Remark: Level = Read Level + Antenna Factor - Preamp Factor + Cable Loss

Report No.: STI130106008

IEEE 802.11n/HT20:
CH LOW :



Shenzhen Certification Technology Service Co., Ltd
2F, Building B, East Area of Nanchang Second Industrial Zone,
Gushu 2nd Road, Bao'an District, Shenzhen 518126, P.R. China
Tel: 4006786199 FAX: +86-755-26736857
Website: <http://www.cessz.com> Email: Service@cessz.com

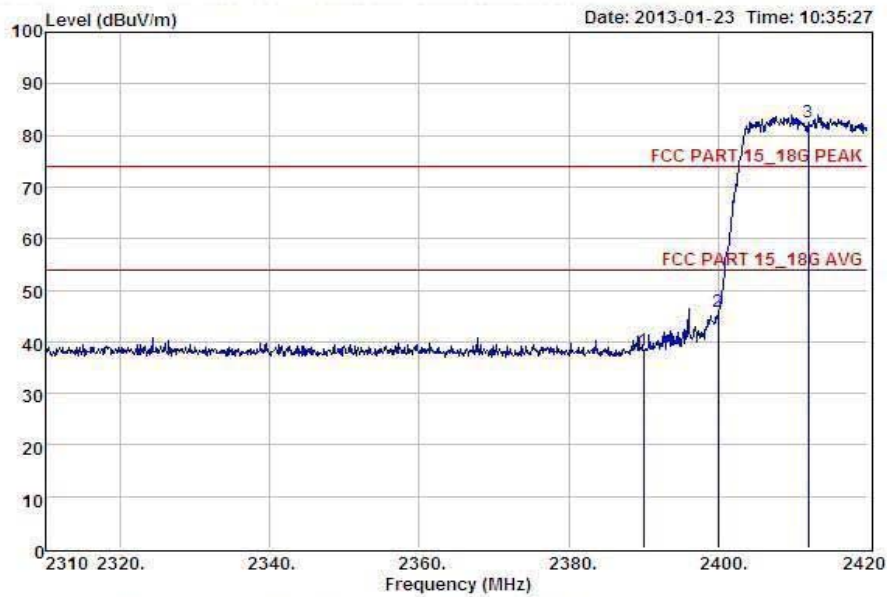

Condition : FCC PART 15_18G PEAK 3m POL: HORIZONTAL
EUT : Wi-Fi Disk
Model No : S3
Test Mode : IEEE.802.n/HT20 CH Low: 2412
Power : DC 5V From PC With AC 120V/60Hz adapter
Test Engineer : Eric
Remark :

Item	Freq MHz	Read Level dBuV	Antenna Factor dB	Preamp Factor dB	Cable Loss dB	Level dBuV	Limit dBuV	Margin dBuV	Remark
1	2390.00	41.76	27.62	34.97	3.92	38.33	74.00	-35.67	Peak
2	2400.00	49.35	27.62	34.97	3.94	45.94	74.00	-28.06	Peak
3	2412.00	65.87	27.61	34.97	3.95	82.46	74.00	8.46	Peak

Remark: Level = Read Level + Antenna Factor - Preamp Factor + Cable Loss



Shenzhen Certification Technology Service Co., Ltd
 2F, Building B, East Area of Nanchang Second Industrial Zone,
 Gushu 2nd Road, Bao'an District, Shenzhen 518126, P.R. China
 Tel: 4006786199 FAX: +86-755-26736857
 Website: <http://www.cessz.com> Email: Service@cessz.com

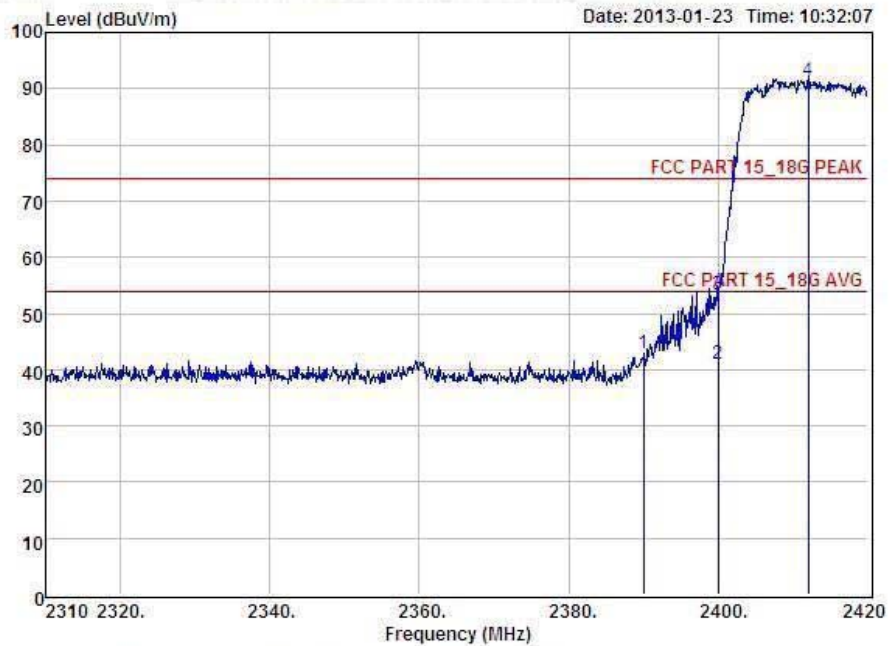

Condition : FCC PART 15_18G PEAK 3m POL: VERTICAL
 EUT : Wi-Fi Disk
 Model No : S3
 Test Mode : IEEE.802.n/HT20 CH Low: 2412
 Power : DC 5V From PC With AC 120V/60Hz adapter
 Test Engineer : Eric
 Remark :

Item	Freq MHz	Read Level dBuV	Antenna Factor dB	Preamp Factor dB	Cable Loss dB	Level dBuV	Limit dBuV	Margin dBuV	Remark
1	2390.00	46.39	27.62	34.97	3.92	42.96	74.00	-31.04	Peak
2	2400.00	44.35	27.62	34.97	3.94	40.94	54.00	-13.06	Average
3	2400.00	56.66	27.62	34.97	3.94	53.25	74.00	-20.75	Peak
4	2412.00	94.84	27.61	34.97	3.95	91.43	74.00	17.43	Peak

Remark: Level = Read Level + Antenna Factor - Preamp Factor + Cable Loss

CH High :



Shenzhen Certification Technology Service Co., Ltd
 2F, Building B, East Area of Nanchang Second Industrial Zone,
 Gushu 2nd Road, Bao'an District, Shenzhen 518126, P.R. China
 Tel: 4006786199 FAX: +86-755-26736857
 Website: <http://www.cessz.com> Email: Service@cessz.com

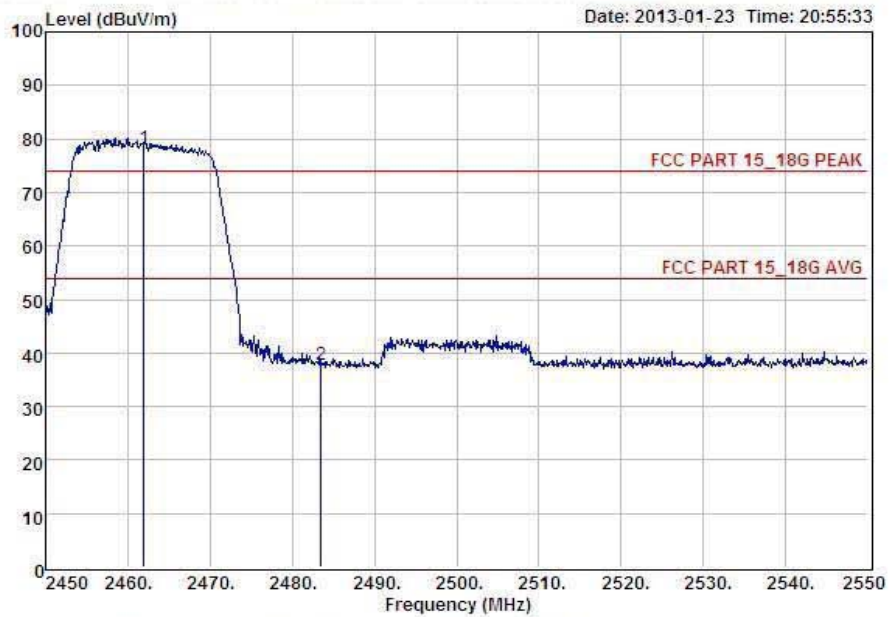

Condition : FCC PART 15_18G PEAK 3m POL: HORIZONTAL
 EUT : Wi-Fi Disk
 Model No : S3
 Test Mode : IEEE.802.n/HT20 CH High: 2462
 Power : DC 5V From PC With AC 120V/60Hz adapter
 Test Engineer : Eric
 Remark :

Item	Freq MHz	Read Level dBuV	Antenna Factor dB	Preamp Factor dB	Cable Loss dB	Level dBuV	Limit dBuV	Margin dBuV	Remark
1	2462.00	81.59	27.59	34.97	3.98	78.19	74.00	4.19	Peak
2	2483.50	41.12	27.59	34.97	4.00	37.74	74.00	-36.26	Peak

Remark: Level = Read Level + Antenna Factor - Preamp Factor + Cable Loss



Shenzhen Certification Technology Service Co., Ltd
 2F, Building B, East Area of Nanchang Second Industrial Zone,
 Gushu 2nd Road, Bao'an District, Shenzhen 518126, P.R. China
 Tel: 4006786199 FAX: +86-755-26736857
 Website: <http://www.cessz.com> Email: Service@cessz.com



Condition : FCC PART 15_18G PEAK 3m POL: VERTICAL
 EUT : Wi-Fi Disk
 Model No : S3
 Test Mode : IEEE.802.n/HT20 CH High: 2462
 Power : DC 5V From PC With AC 120V/60Hz adapter
 Test Engineer : Eric
 Remark :

Item	Freq MHz	Read Level dBuV	Antenna Factor dB	Preamp Factor dB	Cable Loss dB	Level dBuV	Limit dBuV	Margin dBuV	Remark
1	2462.00	87.29	27.59	34.97	3.98	83.89	74.00	9.89	Peak
2	2483.50	42.56	27.59	34.97	4.00	39.18	74.00	-34.82	Peak

Remark: Level = Read Level + Antenna Factor - Preamp Factor + Cable Loss

Report No.: STI130106008

IEEE 802.11n/HT40:
CH LOW :



Shenzhen Certification Technology Service Co., Ltd
2F, Building B, East Area of Nanchang Second Industrial Zone,
Gushu 2nd Road, Bao'an District, Shenzhen 518126, P.R. China
Tel: 4006786199 FAX: +86-755-26736857
Website: <http://www.cessz.com> Email: Service@cessz.com

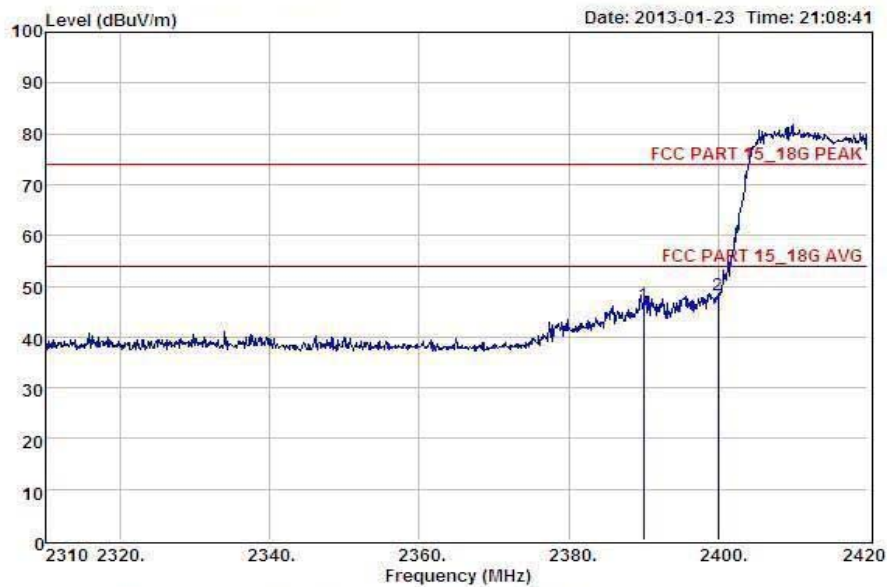

Condition : FCC PART 15_18G PEAK 3m POL: HORIZONTAL
EUT : Wi-Fi Disk
Model No : S3
Test Mode : IEEE.802.n/HT40 CH Low: 2422
Power : DC 5V From PC With AC 120V/60Hz adapter
Test Engineer : Eric
Remark :

Item	Freq MHz	Read Level dBuV	Antenna Factor dB	Preamp Factor dB	Cable Loss dB	Level dBuV	Limit dBuV	Margin dBuV	Remark
1	2390.00	49.71	27.62	34.97	3.92	46.28	74.00	-27.72	Peak
2	2400.00	51.56	27.62	34.97	3.94	48.15	74.00	-25.85	Peak

Remark: Level = Read Level + Antenna Factor - Preamp Factor + Cable Loss



Shenzhen Certification Technology Service Co., Ltd
 2F, Building B, East Area of Nanchang Second Industrial Zone,
 Gushu 2nd Road, Bao'an District, Shenzhen 518126, P.R. China
 Tel: 4006786199 FAX: +86-755-26736857
 Website: <http://www.cessz.com> Email: Service@cessz.com

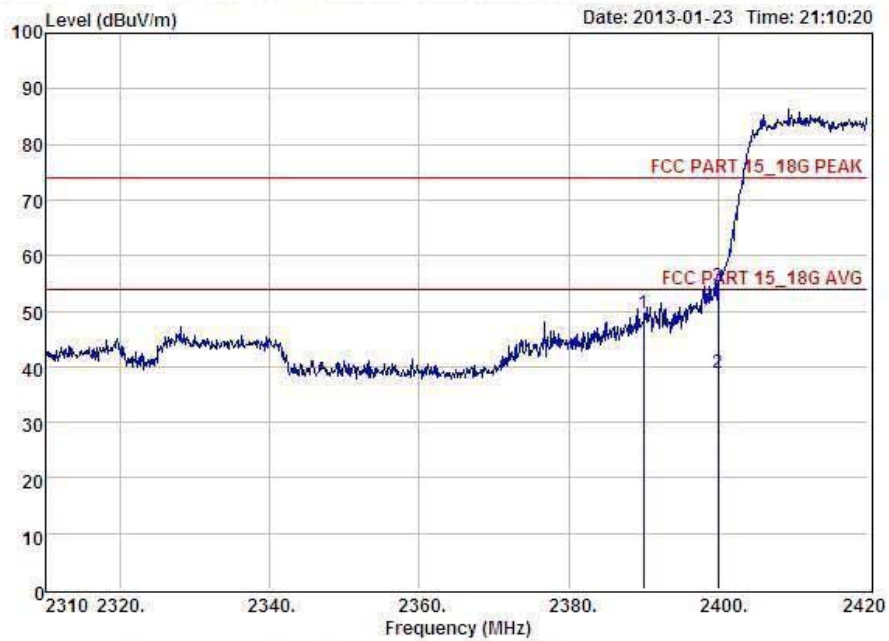

Condition : FCC PART 15_18G PEAK 3m POL: VERTICAL
 EUT : Wi-Fi Disk
 Model No : S3
 Test Mode : IEEE.802.n/HT40 CH Low: 2422
 Power : DC 5V From PC With AC 120V/60Hz adapter
 Test Engineer : Eric
 Remark :

Item	Freq MHz	Read Level dBuV	Antenna Factor dB	Preamp Factor dB	Cable Loss dB	Level dBuV	Limit dBuV	Margin dBuV	Remark
1	2390.00	52.98	27.62	34.97	3.92	49.55	74.00	-24.45	Peak
2	2400.00	42.33	27.62	34.97	3.94	36.92	54.00	-15.08	Average
3	2400.00	57.80	27.62	34.97	3.94	54.39	74.00	-19.61	Peak

Remark: Level = Read Level + Antenna Factor - Preamp Factor + Cable Loss

CH High :



Shenzhen Certification Technology Service Co., Ltd
 2F, Building B, East Area of Nanchang Second Industrial Zone,
 Gushu 2nd Road, Bao'an District, Shenzhen 518126, P.R. China
 Tel: 4006786199 FAX: +86-755-26736857
 Website: <http://www.cessz.com> Email: Service@cessz.com

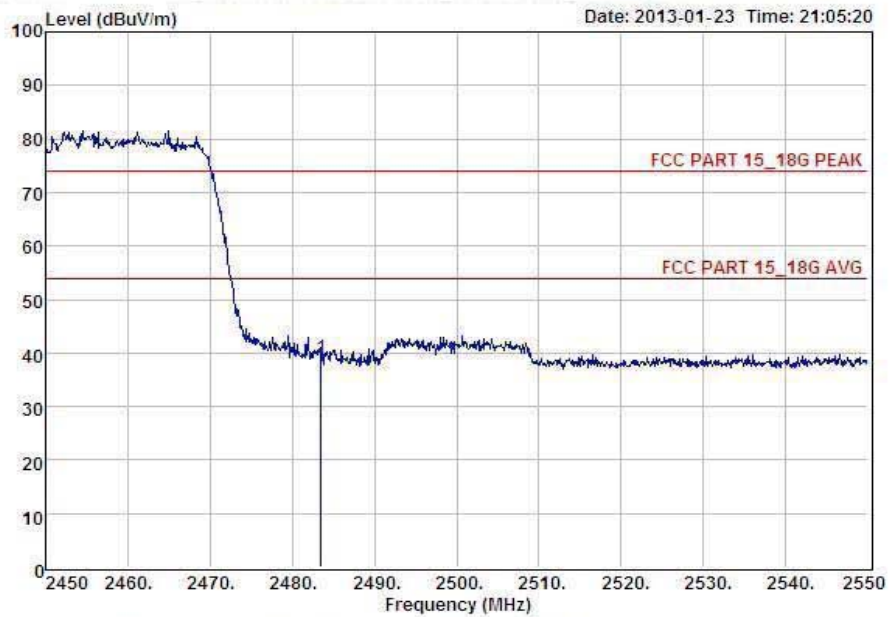

Condition : FCC PART 15_18G PEAK 3m POL: HORIZONTAL
 EUT : Wi-Fi Disk
 Model No : S3
 Test Mode : IEEE.802.n/HT40 CH High: 2452
 Power : DC 5V From PC With AC 120V/60Hz adapter
 Test Engineer : Eric
 Remark :

Item	Freq MHz	Read Level dBuV	Antenna Factor dB	Preamp Factor dB	Cable Loss dB	Level dBuV	Limit dBuV	Margin dBuV	Remark
1	2483.50	42.41	27.59	34.97	4.00	39.03	74.00	-34.97	Peak

Remark: Level = Read Level + Antenna Factor - Preamp Factor + Cable Loss



Shenzhen Certification Technology Service Co., Ltd
 2F, Building B, East Area of Nanchang Second Industrial Zone,
 Gushu 2nd Road, Bao'an District, Shenzhen 518126, P.R. China
 Tel: 4006786199 FAX: +86-755-26736857
 Website: <http://www.cessz.com> Email: Service@cessz.com



Condition : FCC PART 15_18G PEAK 3m POL: VERTICAL
 EUT : Wi-Fi Disk
 Model No : S3
 Test Mode : IEEE.802.n/HT40 CH High: 2452
 Power : DC 5V From PC With AC 120V/60Hz adapter
 Test Engineer : Eric
 Remark :

Item	Freq MHz	Read Level dBuV	Antenna Factor dB	Preamp Factor dB	Cable Loss dB	Level dBuV	Limit dBuV	Margin dBuV	Remark
1	2483.50	46.91	27.59	34.97	4.00	45.53	74.00	-28.47	Peak

Remark: Level = Read Level + Antenna Factor - Preamp Factor + Cable Loss

11 Antenna Requirement

11.1 Standard Requirement

An intentional radiator shall be designed to ensure that no antenna other than that furnished by the responsible party shall be used with the device. The use of a permanently attached antenna or of an antenna that uses a unique coupling to the intentional radiator shall be considered sufficient to comply with the provisions of this Section. The manufacturer may design the unit so that a broken antenna can be replaced by the user, but the use of a standard antenna jack or electrical connector is prohibited.

11.2 Antenna Connected Construction

The directional gains of antenna used for transmitting is 1 dBi, and the antenna connector is de-signed with permanent attachment and no consideration of replacement. Please see EUT photo for details.

11.3 Result

The EUT antenna is built Antenna. It comply with the standard requirement.

12 Photographs of Test Setup

Photographs-Radiated Emission Test Setup in Chamber

Below 1G

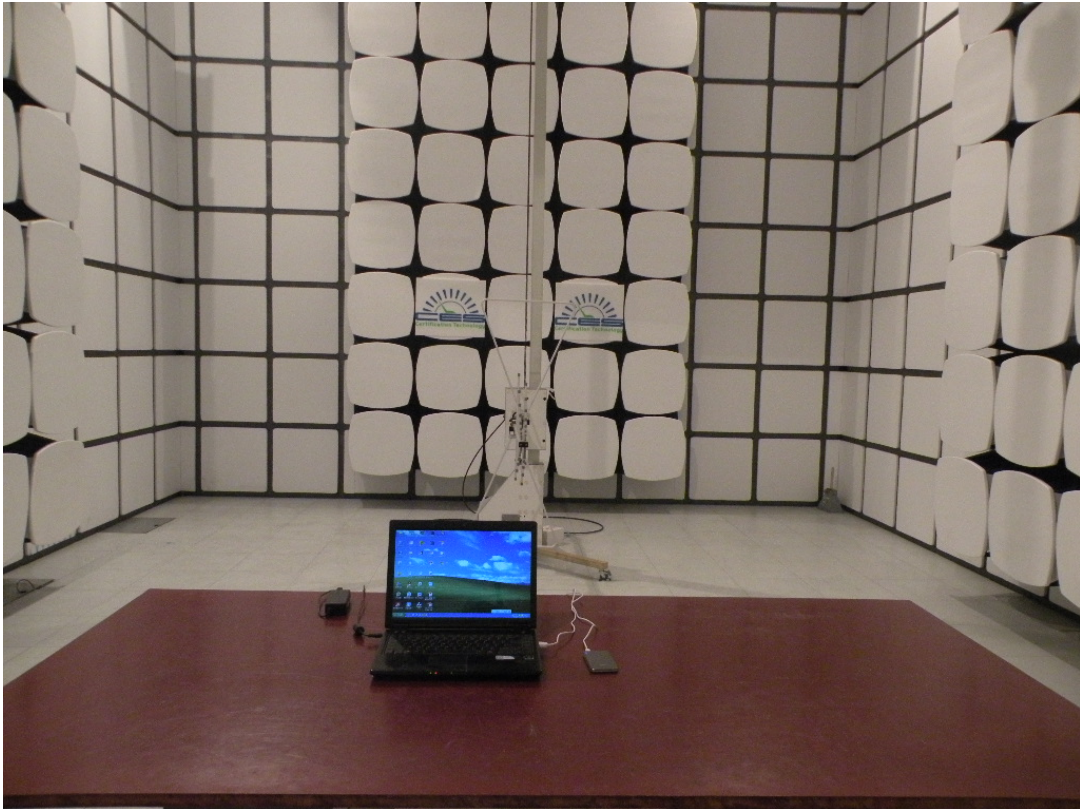

Above 1G



Photographs-Conducted Emission Test Setup



13 Photographs of EUT







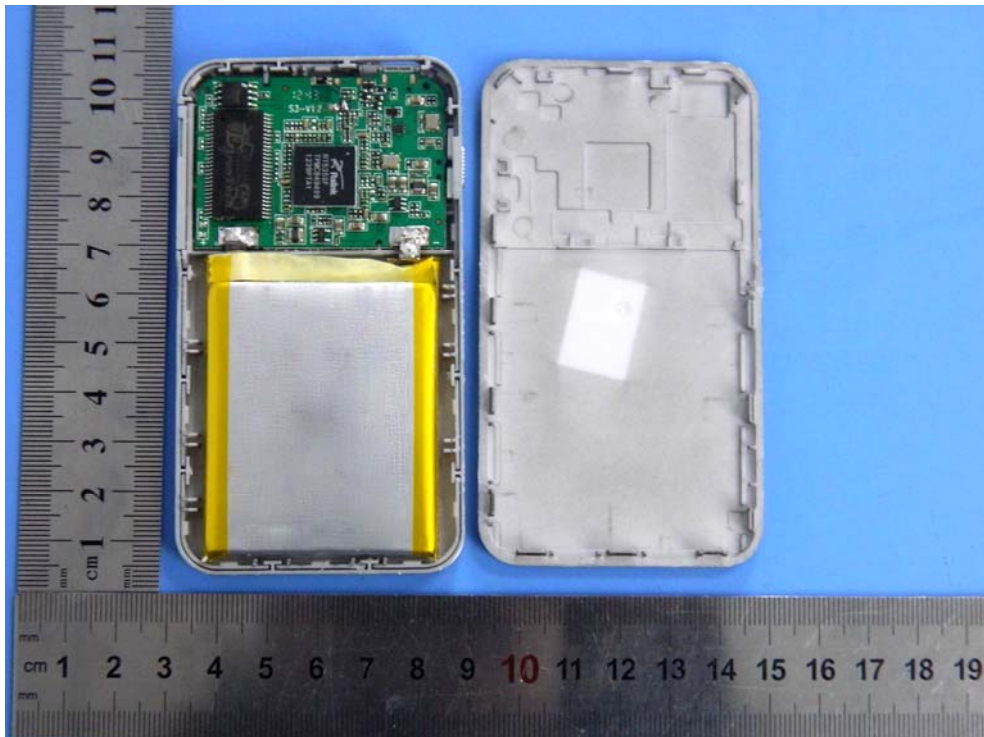

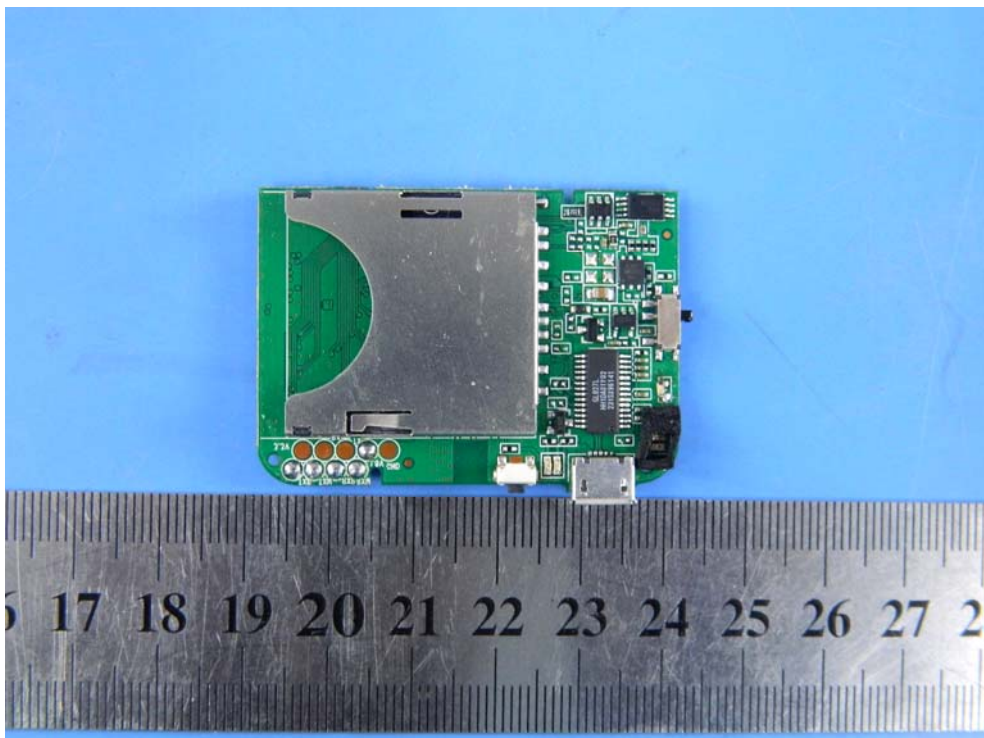
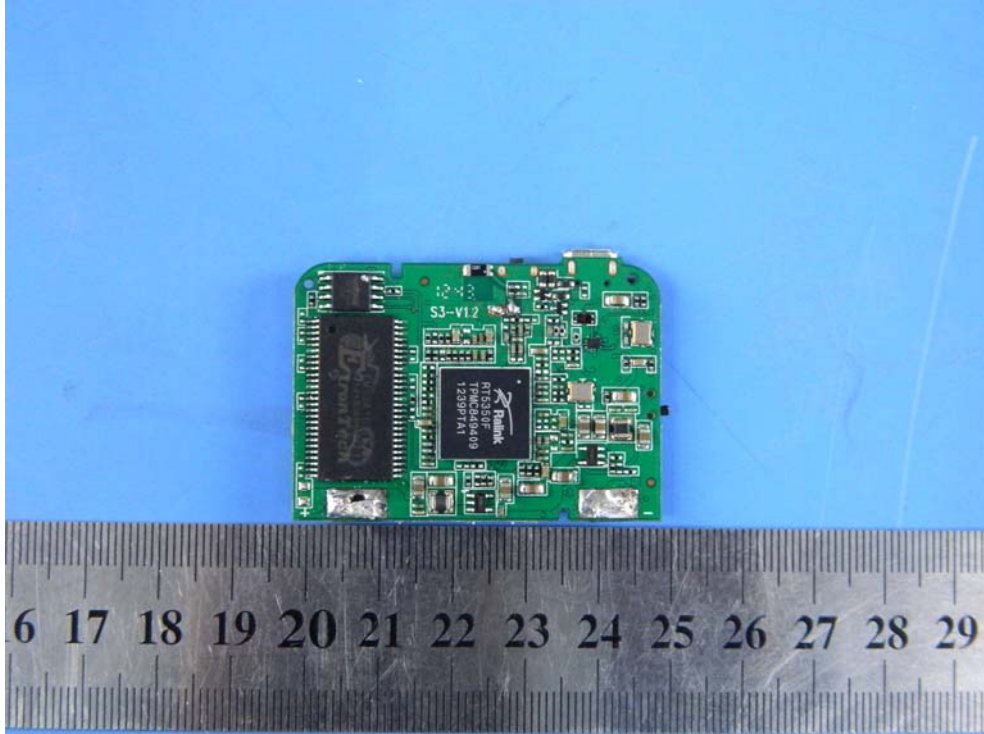

-----END OF THE REPORT-----