

8+ AGES



Submarine



Mini Remote Control Nuclear Submarine

Before starting to use SUBMARINE, please read through the operating manual and all the cautions.

NO.777-586

There is important information in the manual, please do not throw it away

Parts



SUBMARINE

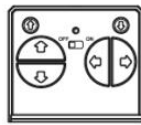

Transmitter

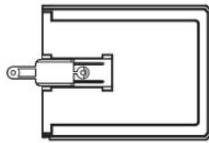

Spare part box



Antenna



USB Charging line



Instruction Manual

Parts Identification

SUBMARINE

Light

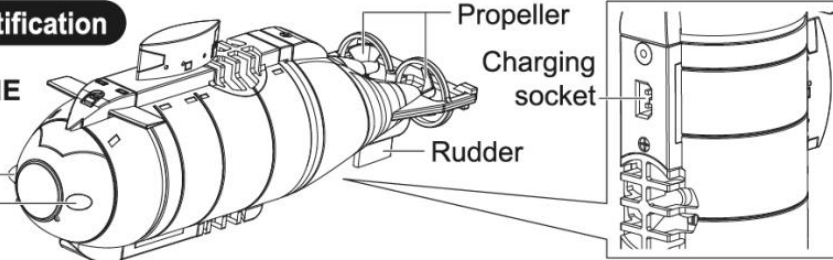

Transmitter

Antenna hole
Surface
Forward
Backward
Power switch

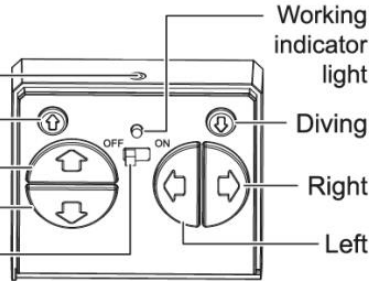

Spare part box

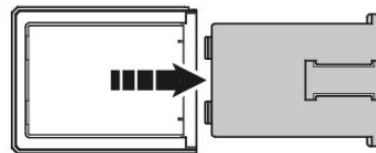

Open the spare part box take the USB charging cable and manu away.

Preparation

1. Take the product out from the capsule case

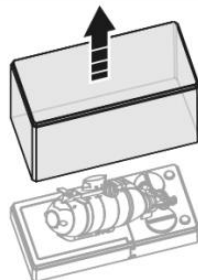

2. Figure out the remote control

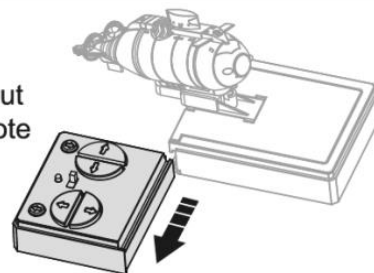

3. Take the product out.

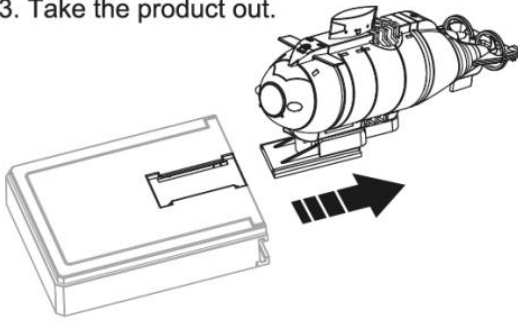

4. Use crossing screwdriver to wrench the screws under the fixed seat as per anticlockwise direction.

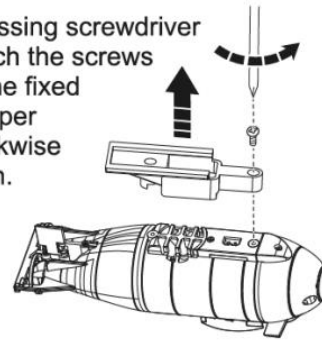

5. Insert the antenna into the hole at the top of the transmitter, and tighten it.

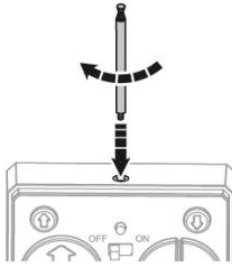

6. Use a screwdriver to loosen the screw on the battery cover by the counter-clockwise, insert 2x"AAA" batteries with the correct polarity, replace the battery cover and tighten the screws.

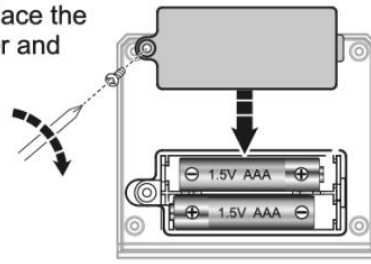

7. Turn the controller power switch to "ON" position, Press any key on the controller and the working indicator of the controller is "ON" it shows that has signal output this time.

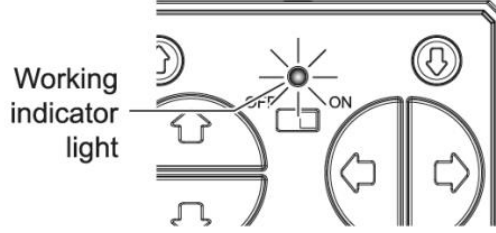
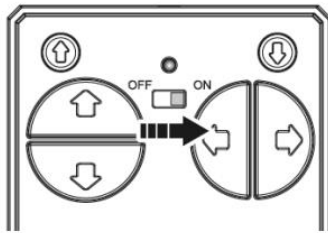

8. USB Charging

(1). Insert the USB charging cable to power source, red light on.(Pic.1)

(2). Insert the other end of the charging cable into the charging hole of the submarine. When charging, the product submarine light comes on, and the indicator light goes off when it is full.(Pic.2)

(3). When charge about 25 minutes, the charging indicator will be "OFF" and charging is finished, The submarine works about 10 minutes when fully charged.

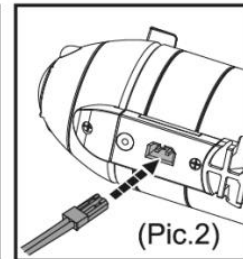
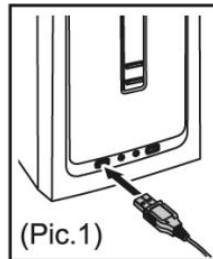

9. Put the submarine in the water and the lights up. Turn on the power of the remote control and the power indicator is on. Press any key on the remote control, the work indicator of the remote control lights up, and the submarine moves.

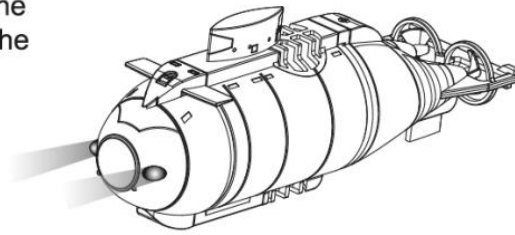

⚠ Attention

1. Do not pull the charging cable and plug during charging.
2. Before charge the product pls make sure fully discharge to avoid any damage of battery
3. The power indicator of the product begins to Flash, which means the power is low. Please charge it in time.

Operation

When playing, please pull out the antenna of the transmitter to maximum first and then put the submarine into the water.

1. Press forward key, the submarine is moving to forward.

Press forward key

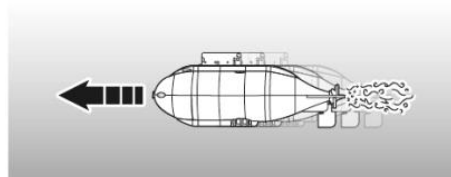
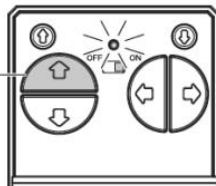

2. Press backward key, the submarine is moving to backward.

Press backward key

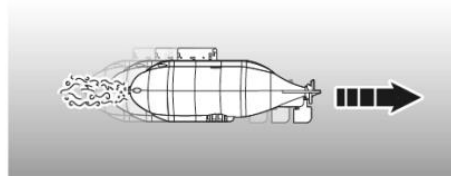
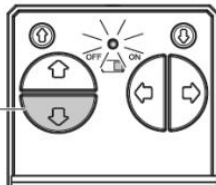

3. Press turn left key, the submarine will be turning left;

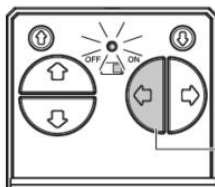

Press left key

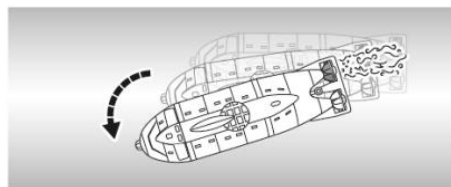

4. Press turn right key, the submarine will be turning right.

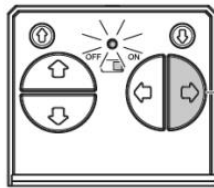

Press right key

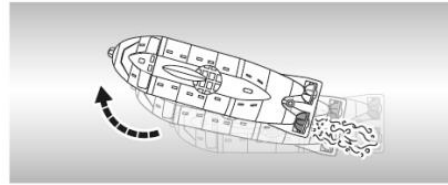

5. Press the left side of this key, submarine will be surface.

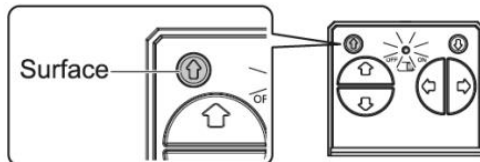

Surface

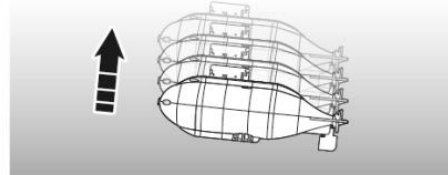

6. Press the right side of this key, submarine will be diving.

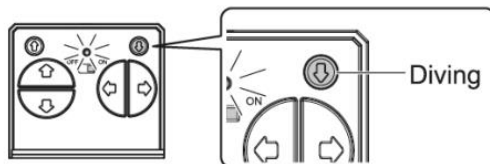

Diving

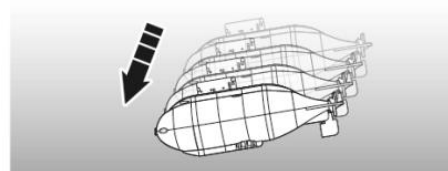

Store SUBMARINE

1. After use, wipe the submarine dry with a fabric and wait for it to dry up.
2. To prolong useful life of batteries in the transmitter, always turn off the transmitter.
3. Before the next use, check to make sure the SUBMARINE battery has been fully charged and the controller still has sufficient power.

ATTENTION

1. Please use the product in strict accordance with the instructions in the manual.
2. This product must be assembled and used under the supervision of adults.
3. This product contains small components. Please do not swallow the components to avoid suffocation hazards.
4. This product is not suitable for kids under three years old.
5. If there is radio interference to operate the venue, please select the venue operator.
6. On backout after the removal, please do not place discarded to avoid contamination sanitation.
7. Do not place near fire and high temperature, moist storage.
8. When the battery is water wet, add water to fully clean.

FCC ID: R6Z20224777586

FCC compliance statement

This device complies with Part 15 of the FCC Rules. Operation is subject to the following two conditions: (1) this device may not cause harmful interference, and (2) this device must accept any interference received, including interference that may cause undesired operation.

changes or modifications not expressly approved by the party responsible for compliance could void the user's authority to operate the equipment.

This equipment has been tested and found to comply with the limits for a Class B digital device, pursuant to Part 15 of the FCC Rules. These limits are designed to provide reasonable protection against harmful interference in a residential installation. This equipment generates, uses and can radiate radio frequency energy and, if not installed and used in accordance with the instructions, may cause harmful interference to radio communications. However, there is no guarantee that interference will not occur in a particular installation.

If this equipment does cause harmful interference to radio or television reception, which can be determined by turning the equipment off and on, the user is encouraged to try to correct the interference by one or more of the following measures:

- Reorient or relocate the receiving antenna.
- Increase the separation between the equipment and receiver.
- Connect the equipment into an outlet on a circuit different from that to which the receiver is connected.
- Consult the dealer or an experienced radio/TV technician for help.