

Schematic Diagram(49.862MHz)

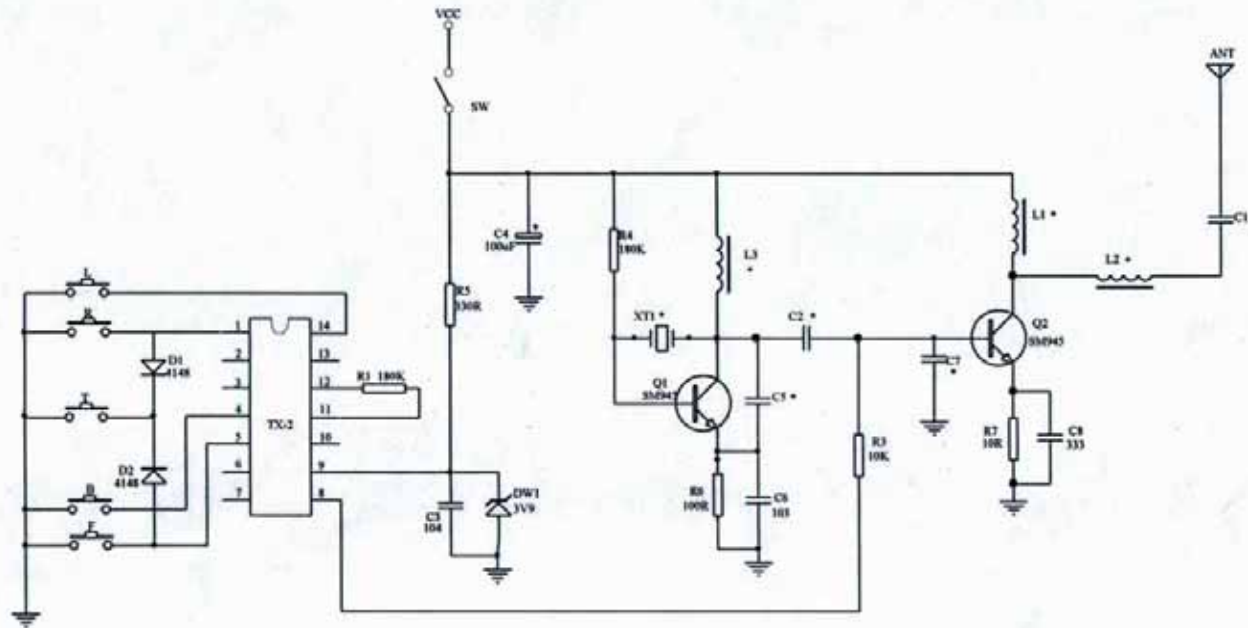

	C1	C2	C3	C4	L1	L2	L3	XT1
49M	47P	27P	27P	47P	1UH	1.5UH	1UH	49.860
27M	68P	47P	47P	68P	2.2UH	4.7UH	2.2UH	27.143

Title		
BT1005T 原理图		
Size	Number	Revision
B		
Date	11-May-2005	Sheet of
File	D:\BT1005T\BT1005T.SCH	Drawn By