

Block Diagram (49.86MHz)

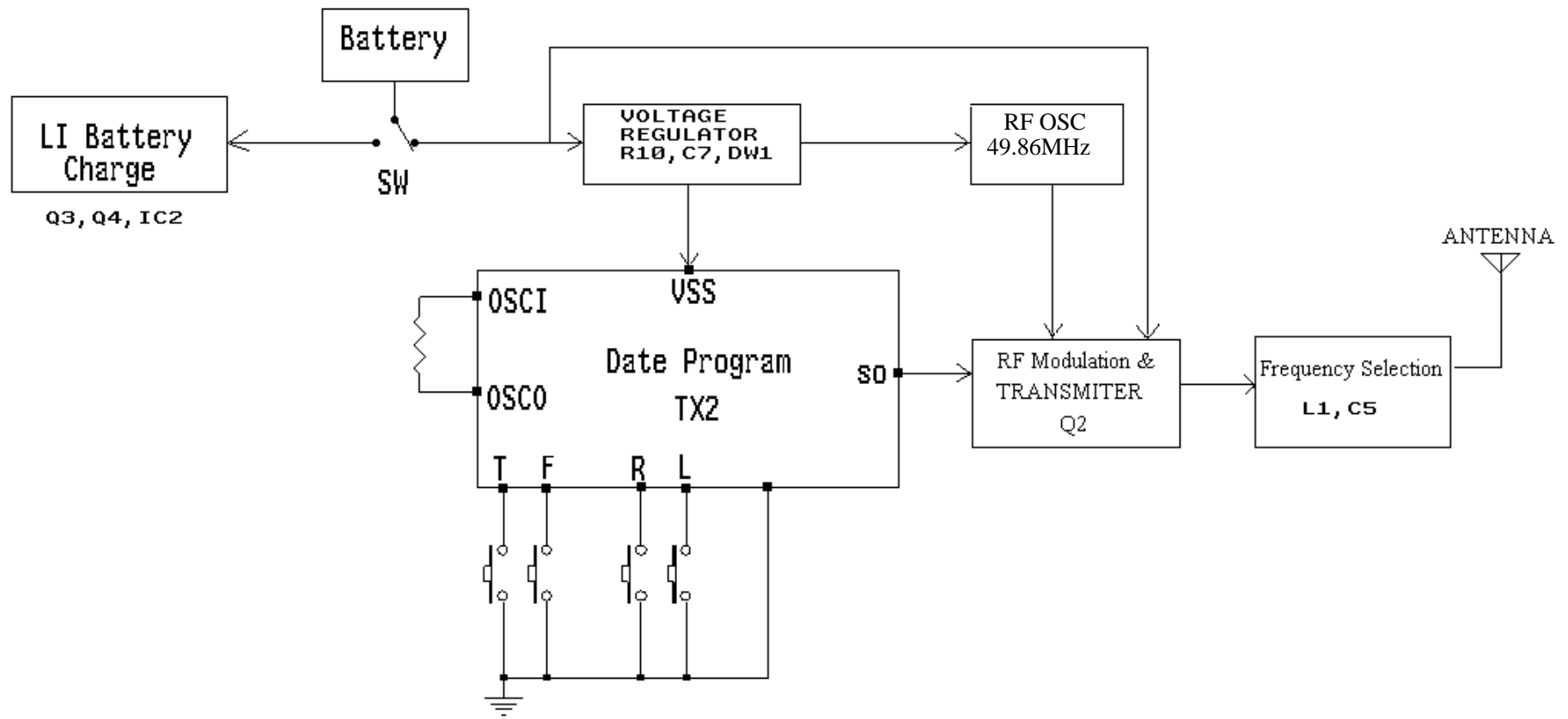

BT1095T