

# LANTRONIX®



## xPico® 200 Series Embedded Wi-Fi® Gateway Data Sheet

Part Number 900-818  
Revision QP TBD August 2023

## Table of Contents

<b>1. Functional Description</b>	<b>7</b>
Overview _____	7
Applications _____	7
Product Features _____	8
<b>2. Hardware and Software Description</b>	<b>9</b>
xPico 200 Block Diagram _____	11
Software Features _____	11
<b>3. Pin and Pad Definitions</b>	<b>16</b>
<b>4. Interfaces</b>	<b>23</b>
Configurable General Purpose I/O Pins (GPIO) _____	25
System Pins _____	26
Strap Pins _____	27
<b>5. IEEE 802.11 Wireless Lan Specifications</b>	<b>28</b>
<b>6. Bluetooth Specifications</b>	<b>32</b>
<b>7. Antenna Connection Options</b>	<b>33</b>
<b>8. Electrical Characteristics</b>	<b><a href="#">3534</a></b>
Recommended Operating Conditions _____	<a href="#">3534</a>
DC Characteristics – Digital I/O Signals _____	<a href="#">3534</a>
Dynamic Power Management Modes _____	<a href="#">3635</a>
Output Power _____	<a href="#">3837</a>
Input Power _____	<a href="#">3938</a>
EVM _____	<a href="#">4039</a>
RX Sensitivity _____	<a href="#">4039</a>
Power, Reset, Wake, Shutdown and Default Timing _____	<a href="#">4140</a>
SPI Slave Timing _____	<a href="#">4342</a>
SPI Master Timing _____	<a href="#">4443</a>
Memory _____	<a href="#">4544</a>
<b>9. Package Description and Mechanical Footprint</b>	<b><a href="#">4645</a></b>
Dimensions _____	<a href="#">4645</a>
Material and Weight _____	<a href="#">4847</a>

<b>10. Product Information Label</b>	<b><u>4948</u></b>
<b>11. Compliance</b>	<b><u>5049</u></b>
Labeling of the End Product _____	<u>5150</u>
Federal Communication Commission Interference Statement (xPico 240/250/270) _____	<u>5254</u>
Industry Canada Statement (xPico 240/250/270): _____	<u>5352</u>
RoHS, REACH, and WEEE Compliance Statement _____	<u>5958</u>
<b>12. Ordering Information</b>	<b><u>6059</u></b>
Warranty _____	<u>6160</u>
Contact Information _____	<u>6160</u>

## List of Figures

Figure 2-1 xPico 240 Module Options _____	10
Figure 2-2 xPico 250 and xPico 270 Module Options _____	10
Figure 2-3 xPico 200 Block Diagram _____	11
Figure 2-4 Wi-Fi Integration Mode _____	12
Figure 2-5 Wireless Microcontroller Mode _____	12
Figure 3-1 xPico 200 Edge Connector Pin & Signal Location _____	16
Figure 3-2 xPico 200 PCB Interface Pin & Signal Location _____	18
Figure 8-1 Reset Timing _____	<a href="#">4140</a>
Figure 8-2 Reset to Defaults Timing _____	<a href="#">4140</a>
Figure 8-3 Wake Timing _____	<a href="#">4140</a>
Figure 8-4 SPI Slave Timing _____	<a href="#">4342</a>
Figure 8-5 SPI Master Timing _____	<a href="#">4443</a>
Figure 9-1 xPico 200 Embedded Wi-Fi Gateway (On-Module Antenna) _____	<a href="#">4645</a>
Figure 9-2 xPico 200 Embedded Wi-Fi Gateway (Dual U.FL) _____	<a href="#">4645</a>
Figure 9-3 Layout Footprint for xPico 200 Enterprise Wi-Fi IoT Module _____	<a href="#">4746</a>
Figure 9-4 xPico 200 Edge Connector Footprint Dimensions _____	<a href="#">4847</a>
Figure 10-1 xPico 200 Module Label _____	<a href="#">4948</a>
Figure 11-2 EU Declaration of Conformity (xPico 240 / xPico 250 / xPico 270) _____	<a href="#">5655</a>
Figure 11-3 UK Declaration of Conformity (xPico 240 / xPico 250 / xPico 270) _____	<a href="#">5756</a>

## List of Tables

Table 3-1: xPico 200 Edge Connector Signal Descriptions	17
Table 3-2: xPico 200 PCB Interface Signal Descriptions	19
Table 4-1: xPico 200 UART Signal Definitions	23
Table 4-2: xPico 200 USB Host Interface Signal Definitions	24
Table 4-3: xPico 200 SPI Slave Interface Signal Definitions	25
Table 4-4: xPico 200 SPI Master Interface Signal Definitions	25
Table 4-5: xPico 200 Module GPIO Signal Definitions	26
Table 4-6: xPico 200 Strap Pins	27
Table 5-1: xPico 200 Module Radio Specification	28
Table 5-2: 20 MHz Channels	28
Table 5-3: 40 MHz Channels	30
Table 5-4: 80 MHz Channels (xPico 270 only)	30
Table 5-5: Wireless Throughput, 802.11ac, TCP	30
Table 5-6: Wireless Throughput, 802.11ac, UDP	30
Table 5-7: Wireless Throughput, 802.11n, TCP	31
Table 5-8: Wireless Throughput, 802.11n, UDP	31
Table 6-1: xPico 200 BT Radio Specification (xPico 250/270 only)	32
Table 7-1: External Antenna Options	33
Table 7-2: On-module Antenna Options	<a href="#">3433</a>
Table 8-1: Recommended Operating Conditions for xPico 200 Module	<a href="#">3534</a>
Table 8-2: DC Characteristics & Digital I/O Signals	<a href="#">3534</a>
Table 8-3: xPico 200 Power Consumption 2.4 GHz (@ 3.3 V, 25° C), Bluetooth Disabled	<a href="#">3635</a>
Table 8-4: xPico 200 Power Consumption 5 GHz (@ 3.3 V, 25° C), Bluetooth Disabled	<a href="#">3736</a>
Table 8-5: xPico 250/270 Power Consumption with Bluetooth Enabled (@ 3.3 V, 25° C)	<a href="#">3736</a>
Table 8-6: xPico 200 Module RF Output Power (Wi-Fi Conducted)	<a href="#">3837</a>
Table 8-7: xPico 200 Module RF Output Power (BT Conducted)	<a href="#">3837</a>
Table 8-8: xPico 200 Module RF Input Power Wi-Fi 2.4 GHz	<a href="#">3938</a>
Table 8-9: xPico 200 Module RF Input Power Wi-Fi 5 GHz	<a href="#">3938</a>
Table 8-10: xPico 200 Module RF Input Power BT	<a href="#">3938</a>
Table 8-11: xPico 200 Module Wi-Fi EVM	<a href="#">4039</a>
Table 8-12: xPico 200 Module Rx Sensitivity @ 3.3 V input power, +25° C	<a href="#">4039</a>
Table 8-13: Shutdown Pin Timing	<a href="#">4241</a>
Table 8-14: SPI Slave Timing	<a href="#">4342</a>
Table 8-15: SPI Master Timing	<a href="#">4443</a>
Table 9-1: Material and Weight	<a href="#">4847</a>
Table 10-1: Datamatrix ECC200 Barcode Standard Descriptions	<a href="#">4948</a>
Table 11-1: Country Certifications (xPico 240/250/270)	<a href="#">5049</a>
Table 11-2: Country Transmitter IDs (xPico 240)	<a href="#">5150</a>
Table 11-3: Country Transmitter IDs (xPico 250)	<a href="#">5150</a>
Table 11-4: Country Transmitter IDs (xPico 270)	<a href="#">5150</a>
Table 11-5: Europe – EU Declaration of Conformity (xPico 240/250/270)	<a href="#">5857</a>
Table 12-1: xPico 240 Order Information	<a href="#">6059</a>

Table 12-2: xPico 250 Order Information	<a href="#">6059</a>
Table 12-3: xPico 270 Order Information	<a href="#">6059</a>

# 1. Functional Description

## Overview

The Lantronix® xPico® 200 series of embedded IoT gateways is one of the smallest and most highly integrated industrial Wi-Fi®, Ethernet and Bluetooth® combo solutions, allowing you to deliver and manage secure connected products without added complexity and risk.

The xPico 200 series delivers always-on dual-band enterprise Wi-Fi, dual-mode Bluetooth (Bluetooth Classic v2.1+EDR and Bluetooth Low Energy v4.2) as well as Ethernet connectivity for business-critical assets.

It is a standalone module that does not require an external host processor for the wireless and network stack. With customer proven **TruPort** technology that includes production-ready essential IoT connectivity firmware, cloud-based management and an integrated device security framework, xPico 200 series delivers a complete network and IoT connectivity offload solution for any microcontroller.

Device manufacturers can use xPico 200 series as the wireless microcontroller within their device and focus on the application firmware components while leveraging the integrated secure connectivity network and cloud service enablement capabilities within the module.

The high performance xPico 200 series is available in different versions (see [Product Features](#)).

With the xPico 200 family, design engineers and system architects can reduce product development time and deploy their secure connected devices with confidence that their products will connect and work as expected.

## Applications

For applications that need Ethernet and wireless connectivity options, xPico 200 delivers a compact combo solution without needing to integrate two different network stacks from different modules or controllers.

Integrated Bluetooth capability on xPico 250/270 enables gateway functions that need to aggregate Bluetooth sensor devices or communicate with Bluetooth peripherals and mobile devices.

Key applications include:

- ◆ Medical devices
- ◆ Industrial machines
- ◆ Retail/POS
- ◆ Weighing scales
- ◆ Asset and warehouse management
- ◆ Environmental monitoring
- ◆ Transportation and Telematics

The xPico 200 series is designed for applications in a variety of industries where reliability, extended operating temperature range, and robust wireless connectivity are business-critical.

The xPico 200 series is also particularly well-suited for products with long lifecycles in highly

regulated industries where the constant change in Wi-Fi technologies and certification would typically make it difficult or cost prohibitive to incorporate a wireless solution.

## Product Features

- ◆ Dual-band (802.11 a/b/g/n) for high performance industrial Wi-Fi
- ◆ xPico 270 adds 802.11ac
- ◆ 2.4 GHz and 5 GHz bands supported
- ◆ IEEE 802.3 10/100 Mbps Ethernet (RMII)
- ◆ Compliant with Bluetooth Core Specification version 4.2 including BLE - xPico 250/270
- ◆ Support for Bluetooth Generic Access Profile (GAP), Generic Attribute Profile (GATT), Device ID Profile - xPico 250/270
- ◆ On-module antenna or Dual U.FL
- ◆ UART (x1), SPI Master (x1), SPI Slave (x1), USB Host/Device and GPIO
- ◆ Ethernet MAC (RMII), USB, UART – host interfaces
- ◆ Simultaneous AP and client (STA), AP only, client (STA) only modes
- ◆ Support for up to 5 simultaneous client connections to Soft AP interface
- ◆ TruPort® Serial and TruPort Socket providing industry's most compatible device data access technology
- ◆ InfiniShield Security – adding integrated root of trust security and data-at-rest and data-in-motion encryption, authentication and identification
- ◆ Direct mobile to device service interface via Soft AP technology (xPico 240/250/270) or Bluetooth (xPico 250/270)
- ◆ WPA/WPA2/WPA3-Personal, WPA2-Enterprise, and WPA3-Enterprise Transition Mode Wi-Fi Security (WPA3 supported in STA mode only)
- ◆ SSL/TLS 1.2 with X.509 Certificate Management
- ◆ Dual Network Support
- ◆ Bridge Ethernet to Wi-Fi STA or to Soft AP
- ◆ Integrated Cloud Based Device Management via ConsoleFlow® platform
- ◆ Web Service API, XML Configuration, Serial Command API
- ◆ Modular RF Certification (FCC, IC, ETSI, Japan, AU/NZS, China)
- ◆ Compact SMT (LGA) Footprint (17mm x 25 mm) or Edge Connector Card Footprint (22 mm x 35.5 mm)
- ◆ Operating temperature range: -40°C to +85°C
- ◆ 5-year limited warranty



## 2. Hardware and Software Description

The xPico 200 series is a highly integrated module that includes a Cortex R4 controller, 802.11 a/b/g/n MAC/BB, 10/100 Mbps Ethernet MAC, Bluetooth 4.2 (on xPico 250/270), RAM, flash, and two U.FL antenna connectors or a single on-module antenna (on the xPico 240 only). xPico 270 adds 802.11ac.

The module also includes the following data communication interfaces:

- ◆ One 10/100 Mbps Ethernet MAC with RMI interface for connection to an external PHY
- ◆ One USB 2.0 high speed Host/Device port
- ◆ One 300 to 4Mbps UART with hardware flow control
- ◆ One SPI Slave port operating up to 50 MHz clock rate (5 Mbps application throughput)
- ◆ Up to 12 GPIO lines

The xPico 200 series operates on 3.3V power with 3.3V logic, and has a built-in voltage supervisory circuit.

xPico 200 series offers two main variants depending on the connectivity interfaces available:

- ◆ **xPico 240** - Provides dual-band 802.11 abgn Wi-Fi and Ethernet combo
- ◆ **xPico 250** - Provides dual-band 802.11 abgn Wi-Fi, Ethernet and dual-mode Bluetooth (Bluetooth Classic and Bluetooth Low Energy)
- ◆ **xPico 270** - Provides dual-band 802.11 ac/abgn Wi-Fi, Ethernet and dual-mode Bluetooth (Bluetooth Classic and Bluetooth Low Energy)

The xPico 200 comes in two form factors:

- ◆ Small form factor SMT module
- ◆ Edge connector module with standard connector

xPico 240 has two antenna options:

- ◆ Two U.FL for connection to external antennas for single stream diversity. See [Antenna Connection Options](#) for recommended antennas.
- ◆ Single on-module antenna

xPico 250 and xPico 270 have one antenna option:

- ◆ Two U.FL for connection to external antennas. One antenna dedicated for Wi-Fi and one dedicated for BT. See [Antenna Connection Options](#) for recommended antennas.

**Figure 2-1 xPico 240 Module Options**



XPC2401 – LGA, Dual U.FL



XPC2402 – LGA, On-Module Antenna



XP2403 – Edge Connector, Dual U.FL



XPC2404 – Edge Connector, On-Module Antenna

**Figure 2-2 xPico 250 and xPico 270 Module Options**



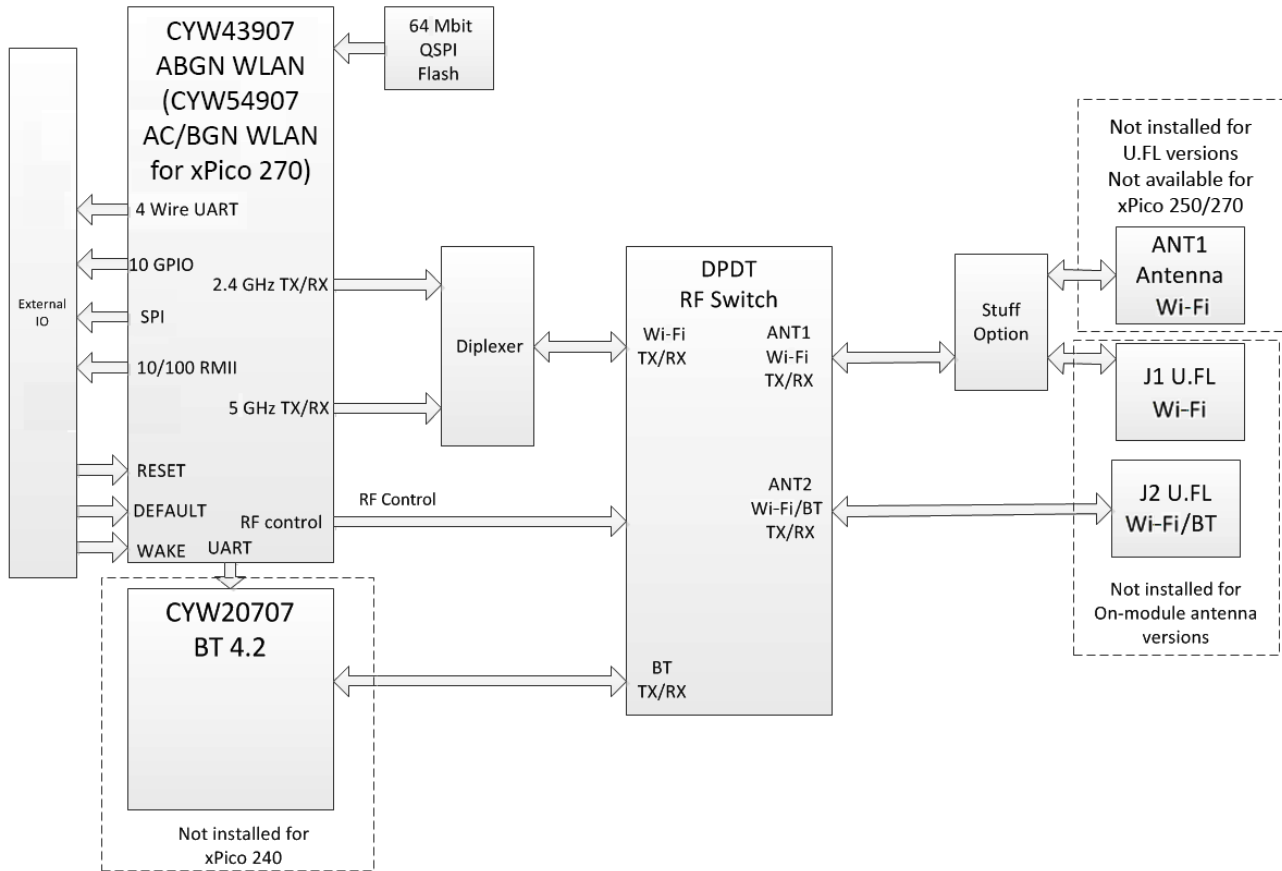
XPC2501, XPC2701 – LGA, Dual U.FL



XPC2503, XPC2703 – Edge Connector, Dual U.FL

## xPico 200 Block Diagram

Figure 2-3 xPico 200 Block Diagram



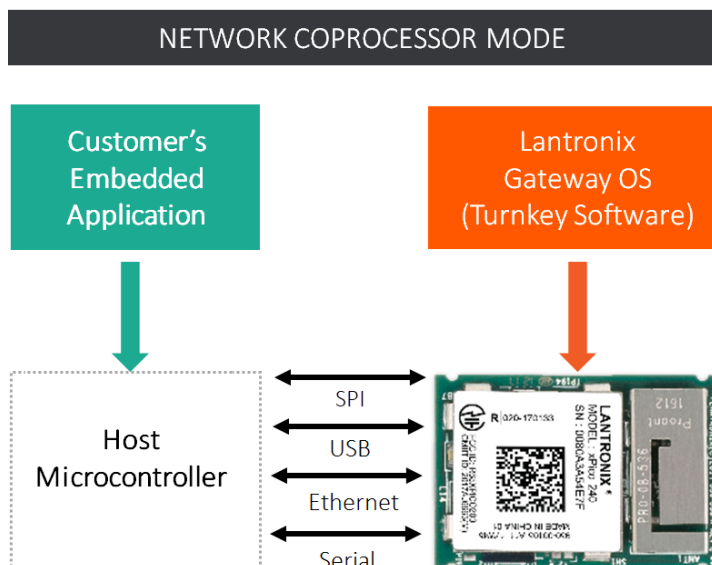
## Software Features

The xPico 200 embedded gateway software stack provides essential IoT connectivity infrastructure for building secure connected products. Device manufacturers can offload this complexity from their application microcontroller when interfacing with the module in **Network Co-processor Mode** or use the module standalone in **Wireless Microcontroller Mode** (Hostless).

## Network Co-Processor Mode

The module completely offloads all Wi-Fi and secure network connectivity requirements for attached microcontrollers thereby reducing device firmware complexity while accelerating OEM's time to introduce and support secure connected products in the market. The host interfaces available for connecting to the microcontroller are UART, USB, SPI Slave, and Ethernet.

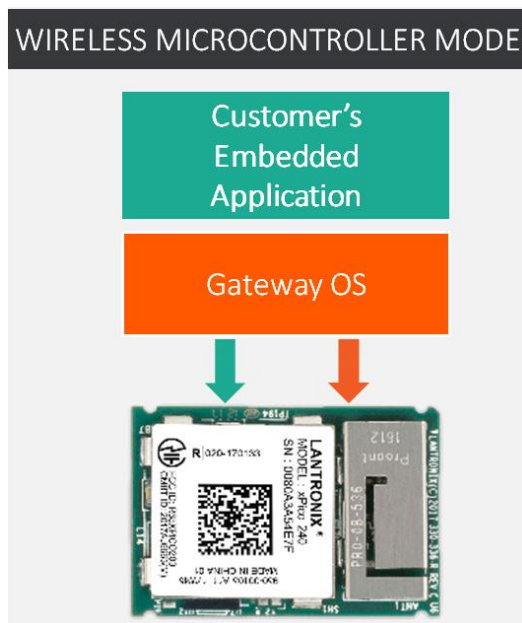
Figure 2-4 Wi-Fi Integration Mode



### Wireless Microcontroller Mode

In addition, the xPico 200 series also can be used as a wireless microcontroller in standalone mode. With the provided SDK, device manufacturers can leverage not only network and wireless stacks, but also the complete application framework that includes the configuration management system, reliable remote OTA firmware upgrades and automated connection management features described below.

Figure 2-5 Wireless Microcontroller Mode



## TruPort Serial

TruPort Serial, a robust serial to Wi-Fi and serial to Ethernet application that supports the transparent transport of hundreds of serial protocols over the network. TruPort Serial is very suitable for use in network co-processor mode based applications requiring very little to no programming and development effort.

Key capabilities included are:

- ◆ Support RS232 serial and USB (CDC Serial and CDC ACM device classes)
- ◆ Advanced connectivity modes and configuration knobs to tune the connection parameters for a specific protocol without requiring custom software programming
- ◆ Automatic and Manual connect modes
- ◆ Inbound (Accept Mode) and Outbound (Connect Mode) connections
- ◆ Modem Emulation Mode enables connecting to different servers using a standard AT command set
- ◆ AES (128-bit, 192-bit, 256-bit) Encrypted session and TLS session modes for secure tunneling

## TruPort Socket

Connect your device microcontroller to multiple services and communicate directly with mobile devices and cloud services at the same time via TruPort Socket. The simple API for TruPort Socket is available via the UART, SPI Slave, or USB interface operating in CDC ACM mode.

Seamlessly switch between Data Mode and Module Management Mode (CLI access) for total control and data channel access from your device host microcontroller.

Access TCP, UDP, TLS, HTTP, SMTP channels and communicate with external services through these channels without implementing these protocol stacks within your microcontroller.

## Ethernet to Wi-Fi Bridge

For devices with microcontrollers that include a network stack and also have Ethernet connectivity available, the gateway module software provides wireless connectivity to these devices via the Ethernet to Wi-Fi Bridge mode. Ethernet connected host devices can be accessed remotely via the Wi-Fi Client interface or via the Wi-Fi Soft AP interface. In this mode, the Wi-Fi stack is fully offloaded and managed via the configuration interface. This mode is most suitable for networked microcontrollers that do not have the resources to integrate wireless device drivers and add-on the complexity of managing the wireless stack.

## Concurrent Soft AP and Client Mode

In addition to supporting the standard Soft AP only mode, Client only mode, xPico 200 series also supports concurrent Soft AP and Client mode.

In this mode, clients can create a direct connection to the Soft AP interface of the gateway, while the Client interface is connected to the Enterprise Wi-Fi network.

This enables OEM service and support teams to setup a direct connection to their machines to diagnose, troubleshoot and service them via mobile devices without requiring access to the customer's Wi-Fi network.

## Enterprise Wi-Fi Security (802.11i, 802.1X/EAP)

Centralized control of security policies and ability to permit and revoke access rights and scaling to support the large number of devices deployed within the enterprise are primary considerations that Enterprise Wi-Fi Security addresses. With support for 802.1X, 802.11i and EAP authentication methods along with support PKI support and X.509 certificate management, connectivity to the enterprise network is handled via configuration and without any integration, testing and certification of supplicant and authenticator software.

## InfiniShield Security

Device manufacturers are exposed to new security risks that emerge with having connected products. They also have to navigate the engineering complexity of providing integrated security within their connected devices. Lantronix InfiniShield Security provides an integrated device security framework that lets device manufacturers build this into their connected products from the start of their design cycle instead of as an after-thought or bolted on component.

InfiniShield Security enables building secure connected products quickly and easily with a full range of features including:

- ◆ Secure Boot – run only signed software on device
- ◆ Secure Firmware Over the Air (FOTA) – accept signed firmware and reliable over the air updates
- ◆ Secure Connectivity – enterprise Wi-Fi security, data-in-motion authentication and encryption
- ◆ Encrypted Storage – stored configuration and device data securely
- ◆ Fine Grained Port Access Control – prevent back-doors with fine grained control over network ports
- ◆ Root of Trust and Device Identity – certificate management, secure key storage, OEM keys

## Wi-Fi Connection Profiles

Connect to multiple wireless networks autonomously by configuring the network parameters once and then letting the module automatically select the best network to connect to or set policies for connecting to specific networks. Wi-Fi connection profiles eliminate the need to manage the state of connection management from the device microcontroller or writing this via the SDK in wireless microcontroller mode.

## Configuration and Management Interface

Access the module configuration and management engine via the microcontroller or via the network. Command Line Interface (CLI) mode offers a text based interactive interface versus writing an elaborate driver interface for the AT command and control interface on the device microcontroller. XML provides a programmatic interface to the module configuration and status that is accessible via the available host interfaces or over the network interface. Web API offer the ability to program the module configuration via the Over-The-Air (OTA) or Network interface. For more details on the usage of these management interfaces, refer to the *xPico 240/250 Embedded Wi-Fi Gateway User Guide* available at <https://www.lantronix.com/products/xpico-200/> for more details.

## Reliable Firmware Over-The-Air (FOTA) Updates

As device requirements evolve and new product features are provided, device manufacturers can leverage the reliable OTA firmware upgrade capabilities to prevent “system bricks.” OTA firmware upgrade always ensures there is at-least one known version of firmware available in the event an upgrade operation does not succeed. It operates over the connected network and does not require placing the module into specific operational modes in order to trigger the update. Updates can be performed remotely and securely using the included Secure Boot features.

## Power Management

xPico 200 series gateways support IEEE 802.11 power save modes for radio power management. The gateways also include application aware power management framework that enables battery powered operation.

## Pre-integration with ConsoleFlow Platform

Quickly deliver secure and robust web-scale device management and monitoring for your connected products with ConsoleFlow management software.

Pre-integrated support within xPico 200 series gateways enables your connected products and the gateway to be managed across the product lifecycle from deployment to decommissioning.

## Remote Gateway Management with Lantronix Gateway Central

Leverage powerful monitoring and management capabilities for Lantronix gateways using Lantronix Gateway Central. Use Google-like search to quickly locate gateways, trigger centralized remote firmware updates and setup customized alerts and notifications on monitoring parameters across your fleet of Lantronix gateways.

With Lantronix Gateway Central, you can maintain a consistent factory configuration or default field configuration or stay on an approved firmware baseline without paying for custom programming services.

## Integrated Bluetooth Classic and Bluetooth Low Energy Stacks (xPico 250/270)

Implement custom BLE profiles with the available SDK and leverage the underlying Bluetooth Stack that complies with Bluetooth Core Specification version 4.2 including BR/EDR/BLE, supports Generic Access Profile (GAP) and Generic Attribute Profile (GATT). It provides support for BLE Central role to enable communication with various BLE sensors and peripherals. As a BLE peripheral it enables communication with mobile devices.

Utilize the pre-integrated Lantronix Gateway Provisioning Profile along with the Gateway Provisioning mobile application to bootstrap initial gateway wireless and network configuration from mobile devices.

Leverage the integrated connection management to pair, bond, and connect with Bluetooth Classic (BR/EDR) device. Supports the following BT Classic Profiles:

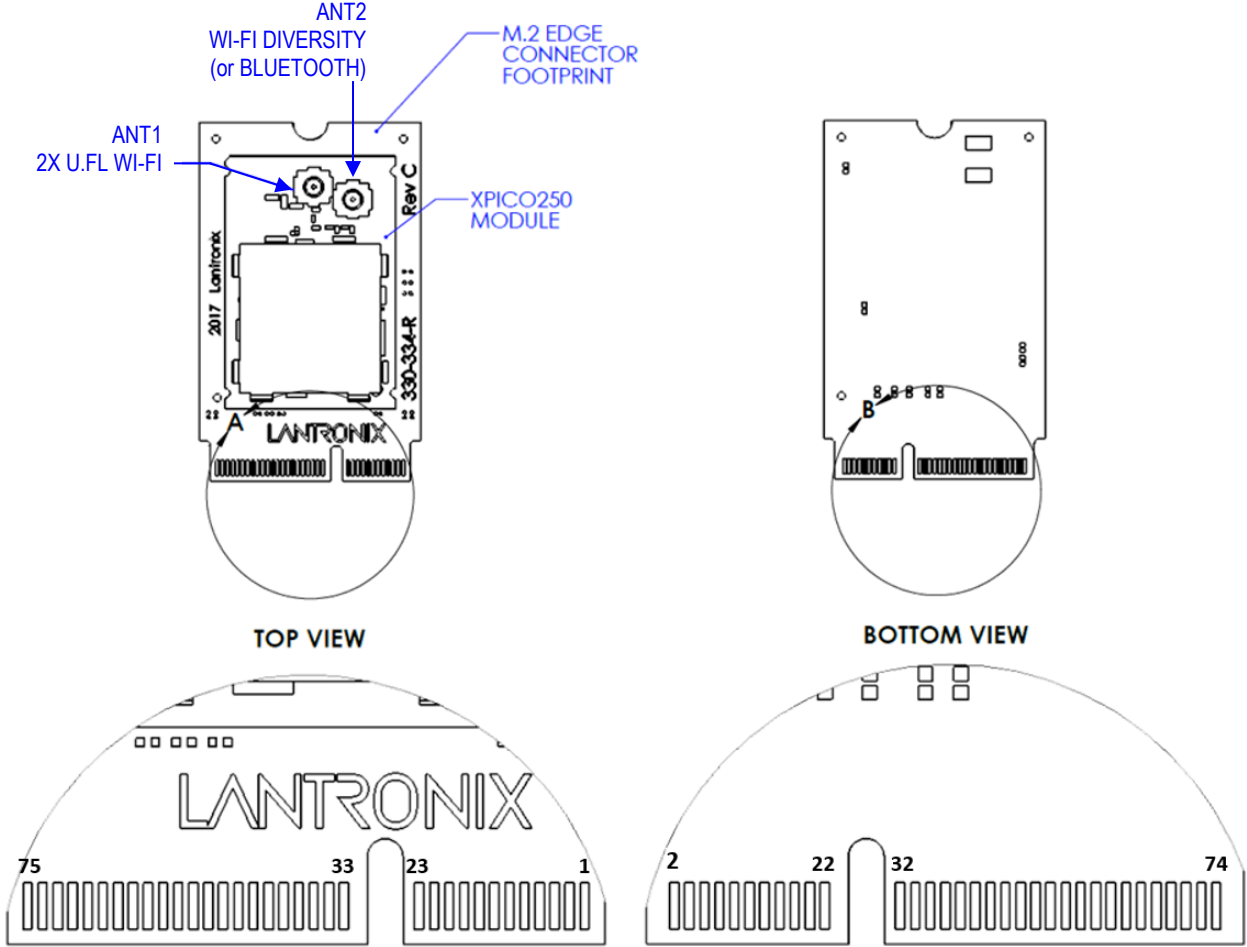
- ◆ Serial Port Profile (SPP) – Client and Server\* mode
- ◆ A2DP\* (Data mode only)



### 3. Pin and Pad Definitions

Table 3-2 describes the xPico 200 Wi-Fi interface signal definition. The **Signal Name** column identifies the signal pin being described while the **Primary Function** column provides definitions of the signal pin depending upon the member of the xPico 200 family being used. Differentiating the signal pins is beneficial when using multiple xPico 200 device types on a single platform.

Figure 3-1 xPico 200 Edge Connector Pin & Signal Location

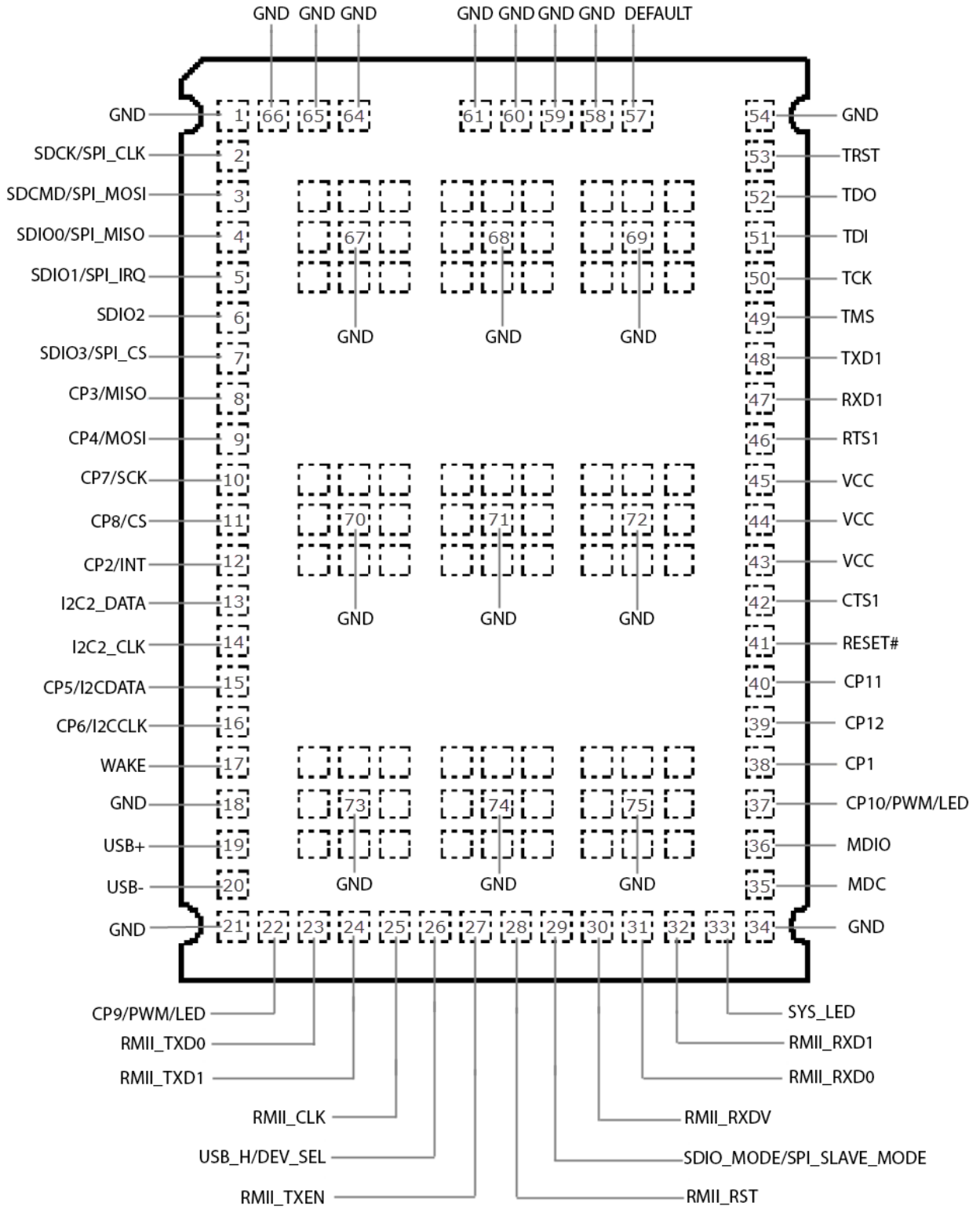




**Table 3-1: xPico 200 Edge Connector Signal Descriptions**

Pin	Signal	Pin	Signal
1	GND	2	3.3V
3	USB_D+	4	3.3V
5	USB_D-	6	SYS_LED
7	GND	8	NC
9	SDIO_SCK/SPI_CLK (slave)	10	NC
11	SDIO_CMD/SPI_MOSI (slave)	12	USB_H/D_SEL
13	SDIO_DATA0/SPI_MISO (slave)	14	SDIO_MODE/SPI_SLAVE_MODE
15	SDIO_DATA1/SPI_IRQ (slave)	16	CP9/LED
17	SDIO_DATA2	18	GND
19	SDIO_DATA3/SPI_CS (slave)	20	WAKE
21	NC	22	UART_TXD
23	DEFAULT#	32	UART_RXD
33	GND	34	UART_RTS
35	TDO	36	UART_CTS
37	TDI	38	TRST
39	GND	40	CP8/CS (master)
41	TCK	42	CP7/SCK (master)
43	TMS	44	CP4/MOSI (master)
45	GND	46	CP3/MISO (master)
47	RMII_MDC	48	CP2/INT (master)
49	RMII_MDIO	50	CP1
51	GND	52	RESET#
53	RMII_RXD1	54	I2C2_CLK
55	RMII_RXD0	56	I2C2_DATA
57	GND	58	CP5/I2C_DATA
59	NC	60	CP6/I2C_CLK
61	RMII_CLK	62	CP10/PWM
63	GND	64	NC
65	RMII_RXDV	66	RSVD_CP12
67	RMII_TXEN	68	RSVD_CP11
69	GND	70	RMII_RST
71	RMII_TXD1	72	3.3V
73	RMII_TXD0	74	3.3V
75	GND		

Figure 3-2 xPico 200 PCB Interface Pin & Signal Location



**Table 3-2: xPico 200 PCB Interface Signal Descriptions**

Signal Name	Primary Function	xPico 200 SMT Pin	Edge Connector Pin	Driver Strength
GND	Signal Ground	1	1	
SDCK/SPI_CLK (slave)	SDIO Clock/SPI Slave Clock	2	9	8 mA
SDCMD/SPI_MOSI (slave)	SDIO CMD/SPI Master Out-Slave In	3	11	8 mA
SDIO0/SPI_MISO (slave)	SDIO Data 0/SPI Master In-Slave Out	4	13	8 mA
SDIO1/SPI_IRQ (slave)	SDIO Data 1/SPI Slave Interrupt	5	15	8 mA
SDIO2	SDIO Data 2	6	17	8 mA
SDIO3/SPI_CS (slave)	SDIO Data 3/SPI Slave chip select	7	19	8 mA
CP3/MISO (master)	Configurable I/O- SPI MISO	8	46	8 mA
CP4/MOSI (master)	Configurable I/O-SPI MOSI	9	44	8 mA
CP7/SCK (master)	Configurable I/O-SPI Clock	10	42	8 mA
CP8/CS (master)	Configurable I/O-SPI Chip Select	11	40	8 mA
CP2/INT (master)	Configurable I/O-SPI interrupt input	12	48	8 mA
I2C Data 2	I2C Bus 2 data	13	56	8 mA
I2C Clock 2	I2C Bus 2 clock	14	54	8 mA
CP5/I2CDATA*	Configurable I/O-I2CDATA	15	58	8 mA
CP6/I2CCLK*	Configurable I/O-I2CCLK	16	60	8 mA
WAKE	Toggle signal from low to high to WAKE from Power down (Standby) state. This pin must be pulled high with a 100K ohm resistor. <b>Note:</b> signal is noise sensitive. Filter as close as possible to module pin.	17	20	
GND	Signal Ground	18	7	
USB+	USB Port Positive pin	19	3	
USB-	USB Port Negative pin	20	5	
GND	Signal Ground	21	33	
CP9/PWM/LED	Configurable I/O-PWM	22	16	8 mA
RMII_TXD0	RMII TXD0 transmit output	23	73	

Signal Name	Primary Function	xPico 200 SMT Pin	Edge Connector Pin	Driver Strength
RMII_TXD1	RMII TXD1 transmit output	24	71	
RMII_CLK	RMII interface clock	25	61	
USB_H/DEV_SEL	USB Host/Device Mode Select Pull high for device mode on USB Pull low for host mode on USB Connect to ID pin of USB connector	26	12	
RMII_TXEN	RMII transmit enable output	27	67	
RMII_RST	RMII reset output	28	70	
SDIO_MODE/SPI_SLAVE_MODE	SDIO Master/Slave select Pull high for master mode on SDIO. Pull low for slave mode on SDIO/SPI.	29	14	
RMII_RXDV	RMII RX data valid input	30	65	
RMII_RXD0	RMII RXD0 receive input	31	55	
RMII_RXD1	RMII RXD1 receive input	32	53	
SYS_LED	System status LED, active high	33	6	
GND	Signal Ground	34	39	
MDC	MDIO clock	35	47	
MDIO	MDIO data	36	49	
CP10/PWM	Configurable I/O-PWM	37	62	8 mA
CP1	Configurable I/O	38	50	8 mA
RESERVED1	Reserved for future UART RX output	39	66	
RESERVED2	Reserved for future UART TX output	40	68	
EXT_RESET#	Unit hardware reset, active low. Drive low for 50ms to reboot unit. Signal should be driven high or pulled high after assertion. EXT_RESET# is inactive during module power down (standby) state. Assert WAKE signal to come out of low power states prior to asserting reset.	41	52	
CTS1	Serial clear-to-send input	42	36	8 mA

Signal Name	Primary Function	xPico 200 SMT Pin	Edge Connector Pin	Driver Strength
VCC	Power input. Must be connected to 3.3V power supply	43	74	
VCC	Power input. Must be connected to 3.3V power supply	44	72	
VCC	Power input. Must be connected to 3,3V power supply	45	2,4	
RTS1	Serial ready-to-send (232) / serial transmit enable (485) output	46	34	8 mA
RXD1	Serial receive data input	47	32	8 mA
TXD1	Serial transmit data output	48	22	
TMS	JTAG TMS Input	49	43	
TCK	JTAG Clock Input	50	41	
TDI	JTAG Data Input	51	37	
TDO	JTAG Data Output	52	35	
TRST	JTAG Reset Input	53	38	
GND	Signal Ground	54	45	
DEFAULT	Drive low for 6 seconds or longer to reset unit to default settings.	57	23	
GND	Signal Ground	58	51	
GND	Signal Ground	59	57	
GND	Signal Ground	60	63	
GND	Signal Ground	61	69	
GND	Signal Ground	64	75	
GND	Signal Ground	65	18	
GND	Signal Ground	66		
GND_PADS	Signal Ground	67,68,69,70,71,72,73,74,75		

Notes:

1. The current module supports an external 10/100 Mbps Ethernet PHY via the RMII interface.
2. The logic IO pins are 3.3V tolerant.
3. SMT Pins 67 to 75 are the ground pads under the module. These pads must be connected to ground. These pads also provide thermal relief for the module. It is recommended that multiple vias for each pad be used to connect the ground pads to the ground plane. Please see the evaluation board layout as a reference for the ground pad

and multiple via in pad recommendation. Contact your local FAE or sales support for the evaluation kit artwork.

4. All unused IO pins may be left floating, except for the required straps on pins 17, 26, and 29.

5. Asterisk (\*) indicates feature available in a future release. Contact your local sales representative for availability.

## 4. Interfaces

The xPico 200 module offers a number of interfaces to allow for easy connectivity to the module. These include 10/100 Mbps Ethernet MAC with RMII, UART for asynchronous serial communication, SPI Master and SPI Slave for synchronous formatted data, and USB interface.

### Ethernet

The xPico 200 module has an integrated 10/100 Mbps Ethernet MAC and with an RMII interface. External PHY, magnetics and RJ45 are required for connection to a standard Ethernet network. See the *xPico 200 Series Embedded Wi-Fi Gateway Integration Guide* available at <https://www.lantronix.com/products/xpico-200/> for more details.

### UART

- ◆ The xPico 200 module supports one UART interface
- ◆ The UART supports asynchronous data rate up to 4 Mbps, with Odd/Even parity, and 1 & 2 stop bits
- ◆ Software flow control (Xon, Xoff)
- ◆ Operational mode as a DTE device
- ◆ UART supports TX, RX, RTS, CTS (hardware flow control)

**Table 4-1 xPico 200 UART Signal Definitions**

Pin Name	Description	SMT Pin	Edge Conn. Pin
TXD1	Serial transmit data output	48	22
RTS1	Serial ready-to-send/serial transmit enable output	46	34
RXD1	Serial receive data input	47	32
CTS1	Serial clear-to-send input	42	36

## USB Host Interface

**Table 4-2 xPico 200 USB Host Interface Signal Definitions**

Pin Name	Description	SMT Pin	Edge Conn. Pin	Signal Requirement	Type A USB Host Conn. Pin
USB+/HHSDPB	USB HS Host Port A Positive pin	19	3	Route as 90 ohm differential pair	3
USB-/HHSDPM	USB HS Host Port A Negative pin	20	5	Route as 90 ohm differential pair	2
5V (User-supplied)	5V power for USB connector			Current limit to 500 mA per port	1
Ground	Signal Ground	Ground	Ground	Ground plane	4
USB_H/D_SEL	USB Host/Device Mode Select	26	12	Pull low for host mode. Connect to ID pin of USB connector if using A/B or Type C connector	
USB Host Power Enable (CP2)	Output to enable external USB power switch for host port connector (Use configurable CP2)	12	48	Pull high for Host Mode	
USB Host Port Over Current Flag (CP1)	Input from external USB power switch indicating the host port is over current (Use configurable CP1)	38	50	Pull high for Host Mode	



## SPI Slave Interface

The xPico 200 gateway has one external SPI slave interface for connection an external SPI master using the gSPI implementation. The signal levels on the SPI slave interface are 3.3V tolerant. This interface is shared with the SDIO interface pins. SDIO is not available in the current product release.

**Note:** The SPI master interface uses different pins than the SPI slave interface.

**Table 4-3: xPico 200 SPI Slave Interface Signal Definitions**

Pin Name	Description	SMT Pin	Edge Conn. Pin
SPI_CLK	SPI Slave Clock	2	9
SPI_MOSI	SPI Master Out-Slave In	3	11
SPI_MISO	SPI Master In-Slave Out	4	13
SPI_IRQ	SPI Slave Interrupt	5	15
SPI_CS	SPI Slave Chip Select	7	19
SDIO_MODE/SPI_SLAVE_MODE	Master/Slave <ul style="list-style-type: none"><li>• Pull high for master mode (not currently supported)</li><li>• Pull low for slave mode</li></ul>	29	14

## SPI Master Interface

The xPico 200 gateway has one external SPI master interface for connection an external SPI slave. The signal levels on the SPI interface are 3.3V tolerant. This interface is shared with the configurable GPIO pins.

**Note:** The SPI slave interface uses different pins than the SPI master interface.

**Table 4-4: xPico 200 SPI Master Interface Signal Definitions**

Pin Name	Description	SMT Pin	Edge Conn. Pin
CP7/SPI_CLK	SPI Clock	10	42
CP4/SPI_MOSI	SPI Master Out-Slave In	9	44
CP3/SPI_MISO	SPI Master In-Slave Out	8	46
CP2/SPI_IRQ	SPI Interrupt	12	48
CP8/SPI_CS	SPI Chip Select	11	40

## Configurable General Purpose I/O Pins (GPIO)

The xPico 200 module provides up to 12 configurable General Purpose Input/Output (GPIO) pins. Certain GPIOs are multiplexed with other interface functions (e.g. SPI). Mapping of these functions to CPs will be driven via configuration and applied at system initialization.

Each CP can be configured as a general purpose input, general purpose output, micro-controller peripheral block or a soft function. These pins are 3.3V CMOS logic level tolerant.

**Table 4-5: xPico 200 Module GPIO Signal Definitions**

Pin Name	Description	Reset State	xPico 200 SMT Pin	Edge Connector Pin
CP1	Configurable I/O-USB Over Current Flag	Input	38	50
CP2/INT	Configurable I/O-SPI interrupt input-USB Host Port Power Enable Output	Input	12	48
CP3	Configurable I/O-SPI MISO <sup>1</sup>	Input	8	46
CP4	Configurable I/O-SPI MOSI <sup>1</sup>	Input	9	44
CP5	Configurable I/O-I2C bus data <sup>1</sup>	Input	15	58
CP6	Configurable I/O-I2C bus clock <sup>1</sup>	Input	16	60
CP7	Configurable I/O-SPI Clock <sup>1</sup>	Input	10	42
CP8	Configurable I/O-SPI Chip Select <sup>1</sup>	Input	11	40
CP9	Configurable I/O-PWM	Input	22	16
CP10	Configurable I/O-PWM	Input	37	62
CP11	Configurable I/O	Input	40	68
CP12	Configurable I/O	Input	39	66

<sup>1</sup> SPI/I2C Interfaces (SPI Master) are reserved for a future update. Contact your local sales representative for availability.

## System Pins

The xPico 200 module has three system pins:

- ◆ **EXT\_RESET#** is the unit hardware reset, active low. Drive low for 50 ms to reboot unit. Signal should be driven high or pulled high after reset. EXT\_RESET# is inactive during module power down (standby) state. Assert WAKE signal to come out of low power states prior to asserting reset.
- ◆ **DEFAULT#** is the unit reset to default, active low. Drive low for 6 seconds or longer to reset unit to default settings. May be left floating if unused.
- ◆ **WAKE** is the toggle signal to WAKE from the STANDBY state. WAKE signal is noise sensitive. Filter as close as possible to the module pin.

See the *xPico 200 Series Embedded Wi-Fi Gateway Integration Guide* available at <https://www.lantronix.com/products/xpico-200/> for more details.

## Strap Pins

The xPico 200 module has two strap pins for setting the mode of the USB and SDIO ports. The SDIO port is reserved for a future update. These pins must be strapped high or low. The mode definitions are listed below.

**Table 4-6: xPico 200 Strap Pins**

<b>Pin Name</b>	<b>Description</b>	<b>xPico 200 SMT Pin</b>	<b>Edge Connector Pin</b>
USB_H/D_SEL	Pull high for device mode on USB port. Pull low for host mode on USB port.	26	12
SDIO_MODE/SPI_SLAVE_MODE	Pull high for master mode on SDIO port. Pull low for slave mode on SDIO port.	29	14

## 5. IEEE 802.11 Wireless Lan Specifications

Table 5-1 below provides the specifications and performance attributes for the xPico 200 module IEEE 802.11 radio.

**Table 5-1: xPico 200 Module Radio Specification**

Feature	Description
Frequency Band	2.412 – 2.484 GHz (20 MHz channels) 5.18 to 5.845 GHz (20 and 40 MHz channels) 5.18 to 5.845 GHz (20, 40, and 80 MHz channels) (xPico 270 only) Channels dependent on assigned country code. See channel list below.
Supported Data Rates xPico 240/250	802.11abgn a, b, g data rates up to 54 Mbps n data rates up to MCS7
Supported Data Rates xPico 270 only	802.11ac/abgn a, b, g data rates up to 54 Mbps n data rates up to MCS7 ac data rates up to MCS9
Modulation	OFDM with BPSK, QPSK, 16-QAM, 64-QAM (xPico 270 up to 256QAM) IEEE 801.11b with CCK and DSSS
802.11 MAC Features	WEP, WPA, WPA2, WPA3, WMM, WMM-PS (UAPSD), WMM-SA, AES, TKIP
802.11 Modes	a/b/g/n/d/h/l (xPico 270 includes ac)

**Table 5-2: 20 MHz Channels**

	Frequency	Channel	FCC/ USA	Canada	Europe	Australia New Zealand	Japan	China	India	Taiwan	Mexico	
2.4 GHz Band	2412	1	Yes	Yes	Yes	Yes	Yes	Yes	Yes	Yes	Yes	
	2417	2	Yes	Yes	Yes	Yes	Yes	Yes	Yes	Yes	Yes	
	2422	3	Yes	Yes	Yes	Yes	Yes	Yes	Yes	Yes	Yes	
	2427	4	Yes	Yes	Yes	Yes	Yes	Yes	Yes	Yes	Yes	
	2432	5	Yes	Yes	Yes	Yes	Yes	Yes	Yes	Yes	Yes	
	2437	6	Yes	Yes	Yes	Yes	Yes	Yes	Yes	Yes	Yes	
	2442	7	Yes	Yes	Yes	Yes	Yes	Yes	Yes	Yes	Yes	
	2447	8	Yes	Yes	Yes	Yes	Yes	Yes	Yes	Yes	Yes	
	2452	9	Yes	Yes	Yes	Yes	Yes	Yes	Yes	Yes	Yes	
	2457	10	Yes	Yes	Yes	Yes	Yes	Yes	Yes	Yes	Yes	
	2462	11	Yes	Yes	Yes	Yes	Yes	Yes	Yes	Yes	Yes	
	2467	12	-	-	Yes	Yes	Yes	Yes	Yes	Yes	-	-
	2472	13	-	-	Yes	Yes	Yes	Yes	Yes	Yes	-	-
	2484	14	-	-	-	-	-	-	-	-	-	-

Frequency	Channel	FCC/ USA	Canada	Europe	Australia	New Zealand	Japan	China	India	Taiwan	Mexico
-----------	---------	-------------	--------	--------	-----------	----------------	-------	-------	-------	--------	--------

Frequency	Channel	FCC/ USA	Canada	Europe	Australia	New Zealand	Japan	China	India	Taiwan	Mexico
5180	36	Yes	Yes	Yes	Yes	Yes	Yes	Yes	Yes	Yes	-
5200	40	Yes	Yes	Yes	Yes	Yes	Yes	Yes	Yes	Yes	-
5220	44	Yes	Yes	Yes	Yes	Yes	Yes	Yes	Yes	Yes	-
5240	48	Yes	Yes	Yes	Yes	Yes	Yes	Yes	Yes	Yes	-
5260	52	Yes*	Yes*	Yes*	Yes*	Yes*	Yes*	Yes*	Yes*	Yes*	-
5280	56	Yes*	Yes*	Yes*	Yes*	Yes*	Yes*	Yes*	Yes*	Yes*	-
5300	60	Yes*	Yes*	Yes*	Yes*	Yes*	Yes*	Yes*	Yes*	Yes*	-
5320	64	Yes*	Yes*	Yes*	Yes*	Yes*	Yes*	Yes*	Yes*	Yes*	-
5500	100	Yes*	Yes*	Yes*	Yes*	Yes*	Yes*	-	-	Yes*	-
5520	104	Yes*	Yes*	Yes*	Yes*	Yes*	Yes*	-	-	Yes*	-
5540	108	Yes*	Yes*	Yes*	Yes*	Yes*	Yes*	-	-	Yes*	-
5560	112	Yes*	Yes*	Yes*	Yes*	Yes*	Yes*	-	-	Yes*	-
5580	116	Yes*	Yes*	Yes*	Yes*	Yes*	Yes*	-	-	Yes*	-
5600	120	Yes*	Yes*	Yes*	-	Yes*	Yes*	-	-	Yes*	-
5620	124	Yes*	Yes*	Yes*	-	Yes*	Yes*	-	-	Yes*	-
5640	128	Yes*	Yes*	Yes*	-	Yes*	Yes*	-	-	Yes*	-
5660	132	Yes*	Yes*	Yes*	Yes*	Yes*	Yes*	-	-	Yes*	-
5680	136	Yes*	Yes*	Yes*	Yes*	Yes*	Yes*	-	-	Yes*	-
5700	140	Yes*	Yes*	Yes*	Yes*	Yes*	Yes*	-	-	Yes*	-
5720	144	Yes*	Yes*	-	-	-	Yes*	-	-	Yes*	-
5745	149	Yes	Yes	-	Yes	Yes	-	Yes	Yes	Yes	Yes
5765	153	Yes	Yes	-	Yes	Yes	-	Yes	Yes	Yes	Yes
5785	157	Yes	Yes	-	Yes	Yes	-	Yes	Yes	Yes	Yes
5805	161	Yes	Yes	-	Yes	Yes	-	Yes	Yes	Yes	Yes
5825	165	Yes	Yes	-	Yes	Yes	-	Yes	Yes	Yes	Yes

\* - Channel not available for ap0 when operating in standalone mode, i.e. wlan0 is disabled or not associated.

**Table 5-3: 40 MHz Channels**

	Frequency	Channel	FCC/ USA	Canada	Europe	Australia	New Zealand	Japan	China	India	Taiwan	Mexico
5 GHz Band	5190	38	Yes	Yes	Yes	Yes	Yes	Yes	Yes	Yes	Yes	-
	5230	46	Yes	Yes	Yes	Yes	Yes	Yes	Yes	Yes	Yes	-
	5270	54	Yes*	Yes*	Yes*	Yes*	Yes*	Yes*	Yes*	Yes*	Yes*	-
	5310	62	Yes*	Yes*	Yes*	Yes*	Yes*	Yes*	Yes*	Yes*	Yes*	-
	5510	102	Yes*	Yes*	Yes*	Yes*	Yes*	Yes*	-	-	Yes*	-
	5550	110	Yes*	Yes*	Yes*	Yes*	Yes*	Yes*	-	-	Yes*	-
	5590	118	Yes*	Yes*	Yes*	-	Yes*	Yes*	-	-	Yes*	-
	5630	126	Yes*	Yes*	Yes*	-	Yes*	Yes*	-	-	Yes*	-
	5670	134	Yes*	Yes*	Yes*	-	Yes*	Yes*	-	-	Yes*	-
	5755	151	Yes	Yes	-	Yes	Yes	-	Yes	Yes	Yes	-
	5795	159	Yes	Yes	-	Yes	Yes	-	Yes	Yes	Yes	-

\* - Channel not available for ap0 when operating in standalone mode, i.e. wlan0 is disabled or not associated.

**Table 5-4: 80 MHz Channels (xPico 270 only)**

	Frequency	Channel	FCC/ USA	Canada	Europe	Australia	New Zealand	Japan	China	India	Taiwan	Mexico
5 GHz Band	5210	42	Yes	Yes	Yes	Yes	Yes	Yes	Yes	Yes	Yes	-
	5290	58	Yes*	Yes*	Yes*	Yes*	Yes*	Yes*	Yes*	Yes*	Yes*	-
	5530	106	Yes*	Yes*	Yes*	Yes*	Yes*	Yes*	-	-	Yes*	-
	5610	122	Yes*	Yes*	Yes*	-	Yes*	Yes*	-	-	Yes*	-
	5690	138	Yes*	Yes*	Yes*	-	Yes*	Yes*	-	-	Yes*	-
	5775	155	Yes	Yes	-	Yes	Yes	-	Yes	Yes	Yes	Yes

\* - Channel not available for ap0 when operating in standalone mode, i.e. wlan0 is disabled or not associated.

**Table 5-5: Wireless Throughput, 802.11ac, TCP**

	TCP 20 MHz		TCP 40 MHz		TCP 80 MHz	
	Downlink	Uplink	Downlink	Uplink	Downlink	Uplink
Mbps	47.1	54	71.3	88.1	87.6	115

**Table 5-6: Wireless Throughput, 802.11ac, UDP**

	UDP 20 MHz		UDP 40 MHz		UDP 80 MHz	
	Downlink	Uplink	Downlink	Uplink	Downlink	Uplink
Mbps	69.2	65.7	134	125	218	201

**Table 5-7: Wireless Throughput, 802.11n, TCP**

	TCP 20 MHz		TCP 40 MHz	
	Downlink	Uplink	Downlink	Uplink
Mbps	45	49.3	67.4	77.5

**Table 5-8: Wireless Throughput, 802.11n, UDP**

	UDP 20 MHz		UDP 40 MHz	
	Downlink	Uplink	Downlink	Uplink
Mbps	59.2	58.8	109	105

**Notes:**

1. Frequencies from 5150 MHz to 5250 MHz for indoor use only.
2. The unit supports 20 MHz bandwidth channels for 2.4 GHz channels.
3. The unit supports 20, 40 MHz bandwidth channels for 5 GHz channels.
4. xPico 270 supports 80Mhz bandwidth channels for 5 GHz channels.
5. Country code modifications are not available to the end user.
6. If the unit is connected as a client to an external AP, the Soft AP channel follows the external AP. Otherwise, the Soft AP defaults to automatically choosing a channel based on RSSI and channel usage. A unit that is not connected to an external AP may also be configured for a specific channel.
7. In Soft AP mode, the product will not initiate any connection or active scan in 5G DFS bands and will only follow external AP or master device to use a channel.
8. Wireless throughput tests performed with iPerf in 5 GHz band, channel 36. UDP throughputs measured at approximately 0.1% packet loss. 802.11n throughput tests performed as single stream. 802.11ac and 80 MHz wireless throughput values apply only to xPico 270.

## 6. Bluetooth Specifications

The table below provides the specifications and performance attributes for the xPico 250/270 Bluetooth radio.

**Table 6-1: xPico 200 BT Radio Specification (xPico 250/270 only)**

<b>Feature</b>	<b>Description</b>
Frequency Band	2.402 – 2.480 GHz
Supported Standards	Bluetooth core specification 4.2 including BR/EDR/BLE
Modulation	GFSK, $\pi/4$ -DQPSK, 8-DPSK
Power	Class 1, Class 2



## 7. Antenna Connection Options

The xPico 200 module supports wireless connectivity via two U.FL connectors for single stream transmit and receive diversity.

An on-module stamped metal antenna version is also available as a product SKU option. The single antenna is used for transmit and receive. Diversity is not available on the module with the on-module antenna.

The xPico 200 modules are certified using the antennas listed in [Table 7-1](#) and [Table 7-2](#) below.

Refer to the compliance section below for certification requirements related to antenna selection.

**Table 7-1: External Antenna Options**

Antenna Type	Peak Gain Typical	Lantronix Part Number	Vendor	Vendor Part Number	Approved Region
PCB strip antenna with 50 mm cable to U.FL connector With tape backing	2.5 dBi, 2.39 GHz to 2.49 GHz 5dBi, 4.9 GHz to 5.9 GHz	XPW100A 003-01-B 50 piece bulk pack	Ethertronics	1001077	FCC, IC, EU, AUS/NZS, JPN, China, Mexico
PCB strip antenna with 50 mm cable to U.FL connector Without tape backing	2.5 dBi, 2.39 GHz to 2.49 GHz 5 dBi, 4.9 GHz to 5.9 GHz		Ethertronics	1000668	FCC, IC, EU, AUS/NZS, JPN, China, Mexico
Swivel type antenna, with RP-SMA(M) connector	2 dBi, 2.4 GHz to 2.5 GHz, 2 dBi, 5.15 GHz to 5.85 GHz	ACC-930-033-R	Wanshih	WSS002	FCC, IC, EU, AUS/NZS, JPN, China, Mexico
Swivel type antenna, with RP-SMA(M) connector	3.8 dBi, 2.4 GHz to 2.5 GHz, 5.5 dBi, 4.9 GHz to 5.8 GHz		Taoglas	GW.71.5153 (Not for EU use)	FCC, IC, AUS/NZS, JPN, China, Mexico
<a href="#">PIFA</a>	<a href="#">4.00 dBi for 2.4 GHz,</a> <a href="#">4.6 dBi for 5.2 Ghz to 5.3 Ghz,</a> <a href="#">5.20 dBi for 5.4Ghz to 5.7Ghz</a>		<a href="#">Wha Yu Industrial Co., Ltd.</a>	<a href="#">C056-511080-A</a>	<a href="#">FCC, IC, NCC, JPN</a>
<a href="#">Chip</a>	<a href="#">3.00 dBi for 2.4 GHz</a>		<a href="#">GainForce Technology Co., Ltd.</a>	<a href="#">AT9520-B2R4HAAT-LF</a>	<a href="#">FCC, IC, NCC, JPN</a>

**Note:** Antenna gain listed above excludes cable loss.

**Table 7-2: On-module Antenna Options**

<b>.Antenna Type</b>	<b>.Peak Gain Typical</b>
On module stamped metal antenna	0 dBi 2.4 GHz, 4 dBi 5 GHz

## 8. Electrical Characteristics

### Recommended Operating Conditions

Table 8-1 specifies the recommended operation conditions and parameters for optimum performance of the xPico 200 module.

**Table 8-1: Recommended Operating Conditions for xPico 200 Module**

Parameter	Symbol	Min	Typ	Max	Units
Voltage	VCC	3.15	3.3	3.45	V DC
Supply Voltage Ripple/droop	VCC pp			± 1%	
Extended Operating Temperature	T <sub>a</sub>	-40		+85	°C
Extended Storage Temperature	T <sub>a</sub>	-40		+85	°C
Humidity (non-condensing, relative)		5%		85	%
Power Supply ramp rate	VCC	40		1000 <sup>1</sup>	Us
Vibration (Operational)				40	G
Non-operational Shock				65	G

<sup>1</sup>For slower power supply ramp rates it is recommended to assert reset for 50ms after power reaches 3.15V.

### DC Characteristics – Digital I/O Signals

Table 8-2 describes the DC characteristics and digital I/O signals of the xPico 200 module.

The RMII pins are managed by the VDDIO\_RMII power segment as mentioned in the “Power Supply Segments” section of the [datasheet](#) (refer to Table 19 on page 51). The VDDIO\_RMII has a minimum supply voltage requirement of 1.71V and a maximum of 3.63V; the same would hold for these pins.

**Table 8-2: DC Characteristics & Digital I/O Signals**

Symbol	Parameter/Signal	Min	Typ	Max	Unit
VIL	RESET#	-0.5		0.8	V
VIH	RESET#	2.0		VCC + 0.5	V
VIL	CPx, UART, JTAG	-0.5		0.8	V
VIH	CPx, UART, JTAG	2.0		VCC + 0.5	V
VOL	CPx, UART, JTAG			0.4	V
VOH	CPx, UART, JTAG	VCC-0.4			V
VIL	SDIO pins			0.25*VCC	V
VIH	SDIO pins	0.625*VCC			V
VOL	SDIO pins			0.125*VCC	V
VOH	SDIO pins	0.75*VCC			V
RPU			39.58		kΩ
RPD	SDIO_MODE/SPI_SLAVE_MODE		44.57		kΩ
RPU			44.57		kΩ

## Dynamic Power Management Modes

The table below describes the power management modes for the xPico 200 module, along with their typical and maximum current consumption values.

The xPico 200 module supports power-up and standby modes within its dynamic application-aware power management framework.

**Table 8-3: xPico 200 Power Consumption 2.4 GHz (@ 3.3 V, 25° C), Bluetooth Disabled**

Parameter	Power Mgmt	Soft AP	Typical IxPico 240	Typical xPico 250/270	Max xPico 240	Max xPico 250/270	Units
Boot sequence peak	N/A	N/A	580	600			mA
Idle current average-unit connected to AP on client 11n Ch6	OFF	ON	95	123			mA
Idle current average-unit connected to AP on client 11n Ch6	ON, Beacon 100 ms, DTIM 5	ON	95	123			mA
Idle current average unit connected to AP on client 11n Ch6	ON, Beacon 100 ms, DTIM 5	OFF	41	66			mA
Iperf (UDP) in bridge mode to AP on client interface 1 Mbps-Sustained 11n Ch6	ON, Beacon 100 ms, DTIM 5	OFF	95	128			mA
Transmitter surge, 11g 54 Mbps, 15 dBm	N/A	N/A	345	379	399	427	mA
Transmitter surge, 11n, 20 MHz BW, MCS7, 17 dBm	N/A	N/A	345	380	398	430	mA
Transmitter surge, 11g 54 Mbps, 0 dBm	N/A	N/A	298	328	358	383	mA
Transmitter surge, 11n, 20 MHz BW, MCS7, 0 dBm	N/A	N/A	299	330	356	386	mA
Stand by, external IO connections removed @ +25C	N/A	N/A	30	38			uA
Stand by with external PHY, other external IO connections removed @ +25C	N/A	N/A	97	97			uA
Ethernet ping, Wi-Fi disabled. External PHY current not included	N/A	N/A	37	37			mA

**Table 8-4: xPico 200 Power Consumption 5 GHz (@ 3.3 V, 25° C), Bluetooth Disabled**

<b>Parameter</b>	<b>Power Mgmt</b>	<b>Soft AP</b>	<b>Typical xPico 240</b>	<b>Typical xPico 250/270</b>	<b>Max xPico 240</b>	<b>Max xPico 250/270</b>	<b>Units</b>
Boot sequence peak	N/A	N/A	580	600			mA
Idle current average-unit connected to AP on client 11n Ch48	OFF	ON	148	174			mA
Idle current average-unit connected to AP on client 11n Ch48	ON, Beacon 100 ms, DTIM 5	ON	148	172			mA
Idle current average unit connected to AP on client 11n Ch48	ON, Beacon 100 ms, DTIM 5	OFF	40	66			mA
lperf (UDP) in bridge mode to AP on client interface 1 Mbps-Sustained, 11n Ch48	ON, Beacon 100 ms, DTIM 5	OFF	134	166			mA
Transmitter surge, 11a 54 Mbps, 14 dBm	N/A	N/A	390	429	465	499	mA
Transmitter surge, 11n, 40 MHz BW, MCS7, 14 dBm	N/A	N/A	401	440	494	532	mA
Transmitter surge, 11a 54 Mbps, 0 dBm	N/A	N/A	316	350	395	457	mA
Transmitter surge, 11n, 40 MHz BW, MCS7, 0 dBm	N/A	N/A	334	360	419	494	mA
Stand by, external IO connections removed @ +25 C	N/A	N/A	30	38			uA
Stand by with external PHY, other external IO connections removed @ +25 C	N/A	N/A	97	97			uA
Ethernet ping, Wi-Fi disabled. External PHY current not included	N/A	N/A	37	37			mA

**Table 8-5: xPico 250/270 Power Consumption with Bluetooth Enabled (@ 3.3 V, 25°C)**

Parameter	Power Mgmt	Soft AP/ Wi-Fi Client	Average Current	Peak Current Typical	Units
BLE peripheral not connected. Wi-Fi client and Soft AP disabled	OFF	Disable	44	120	mA
BLE peripheral not connected. Wi-Fi Client connected (2.4 GHz) ping. Soft AP enabled.	OFF	Enabled	110	556	mA
BLE peripheral not connected. Wi-Fi Client connected (5 GHz) ping. Soft AP enabled.	OFF	Enabled	124	600	mA
BLE peripheral connected. Wi-Fi client and Soft AP disabled	OFF	Disabled	45	121	mA
BLE peripheral connected. Wi-Fi Client connected (2.4 GHz) ping. Soft AP enabled.	OFF	Enabled	112	556	mA
BLE peripheral connected. Wi-Fi Client connected (5 GHz) ping. Soft AP enabled.	OFF	Enabled	126	600	mA

## Output Power

The xPico 200 module RF output power is listed in the [Table 8-6](#) below.

**Table 8-6: xPico 200 Module RF Output Power (Wi-Fi Conducted)**

Mode	Rate	TYP.	Tolerance	Unit
RF Average Output Power, 802.11b	1 Mbps	17	+ 2	dBm
	11 Mbps	17	+ 2	dBm
RF Average Output Power, 802.11g	6 Mbps	15	+ 2	dBm
	54 Mbps	15	+ 2	dBm
RF Average Output Power, 802.11n (2.4 GHz)	MCS0	15	+ 2	dBm
	MCS7	15	+ 2	dBm
RF Average Output Power, 802.11a	6 Mbps	15	+ 2	dBm
	54 Mbps	15	+ 2	dBm
RF Average Output Power, 802.11n (5 GHz)	MCS0	13	+ 2	dBm
	MCS7	13	+ 2	dBm
RF Average Output Power, 802.11ac (5 GHz) (xPico 270 only)	MCS9	12	+2	dBm

**Table 8-7: xPico 200 Module RF Output Power (BT Conducted)**

Mode	Rate	Min.	TYP.	Max	Unit
RF Average Output Power	BLE		6 <sup>1</sup>		dBm
Power Class 1 <sup>2</sup>	BR/EDR	0		20	dBm
Power Class 2 <sup>2</sup>	BR/EDR	-6	3	4	dBm
Power Class 3 <sup>2</sup>	BR/EDR			0	dBm

<sup>1</sup>Max EIRP for BLE 10 dBm per BT specification

<sup>2</sup>Refer to BT Sig power transmitter power specifications

## Input Power

The xPico 200 module RF input power is listed in [Table 8-8](#), [Table 8-9](#), and [Table 8-10](#) below.

**Table 8-8: xPico 200 Module RF Input Power Wi-Fi 2.4 GHz**

Maximum RF Receive Level	Maximum	Unit
Absolute Maximum Wi-Fi Signal	+5	dBm
@ 1, 2 Mbps (8% PER, 1024 octets)	-3.5	dBm
@ 5.5, 11 Mbps (8% PER, 1024 octets)	-9.5	dBm
@ 6, 9, 12 Mbps (10% PER, 1024 octets)	-9.5	dBm
@ MCS0–2 rates (10% PER, 4095 octets)	-9.5	dBm
@ 18, 24, 36, 48, 54 Mbps (10% PER, 1024 octets)	-14.5	dBm
@ MCS3–7 rates (10% PER, 4095 octets)	-14.5	dBm

**Table 8-9: xPico 200 Module RF Input Power Wi-Fi 5 GHz**

Maximum RF Receive Level	Maximum	Unit
Absolute Maximum Wi-Fi Signal	+5	dBm
@ 6, 9, 12 Mbps (10% PER, 1024 octets)	-9.5	dBm
@ MCS0–2 rates (10% PER, 4095 octets)	-9.5	dBm
@ 18, 24, 36, 48, 54 Mbps (10% PER, 1024 octets)	-14.5	dBm
@ MCS3–9 rates (10% PER, 4095 octets)	-14.5	dBm

**Table 8-10: xPico 200 Module RF Input Power BT**

Maximum RF Receive Level	Maximum	Unit
Maximum RF Input Level CW signal	-5	dBm
Maximum RF Input (High Peak to Average, ex Wi-Fi)	-10	dBm

## EVM

The xPico 200 module TX EVM follow the IEEE specification listed in [Table 8-11](#) below.

**Table 8-11: xPico 200 Module Wi-Fi EVM**

Mode	Rate	Max	Unit
RF Average Output EVM (11g)	6 Mbps	-5	dB
	54 Mbps	-25	dB
RF Average Output EVM (11n 2.4 GHz)	MCS0	-5	dB
	MCS7	-27	dB
RF Average Output EVM (11a)	6 Mbps	-5	dB
	54 Mbps	-25	dB
RF Average Output EVM (11n 5 GHz)	MCS0	-5	dB
	MCS7	-27	dB
RF Average Output EVM (11ac 5 GHz) (xPico 270 only)	MCS9	-32	dB

## RX Sensitivity

The xPico 200 module Rx sensitivity is listed in [Table 8-12](#) below.

**Table 8-12: xPico 200 Module Rx Sensitivity @ 3.3 V input power, +25° C**

Receiver Characteristics	Typical
PER <10%, Rx Sensitivity @ 802.11g 6 Mbps	-92.6 dBm
PER <10%, Rx Sensitivity @ 802.11g 54 Mbps	-75.5 dBm
PER <10%, Rx Sensitivity @ 802.11a 6 Mbps	-88.7 dBm
PER <10%, Rx Sensitivity @ 802.11a 54 Mbps	-73.7 dBm
PER <10%, Rx Sensitivity @ 802.11n 5 GHz MCS7 HT20	-72.0 dBm
PER <10%, Rx Sensitivity @ 802.11n 5 GHz MCS7 HT40	-68.8 dBm
BER <0.1%, Rx Sensitivity @ Bluetooth BR, 1 Mbps GFSK	-89.2 dBm
BER <0.01%, Rx Sensitivity @ Bluetooth EDR, 3 Mbps D8PSK	-85.6 dBm



## Power, Reset, Wake, Shutdown and Default Timing

The diagrams below show the timing requirement for VCC, RESET#, DEFAULT#, WAKE and SHDN.

Figure 8-1 Reset Timing

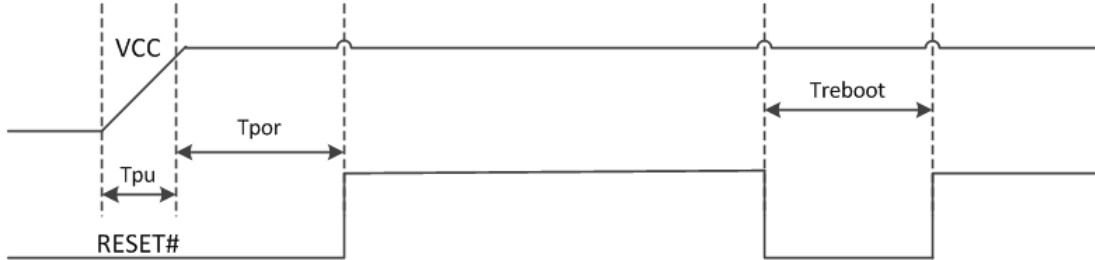


Figure 8-2 Reset to Defaults Timing

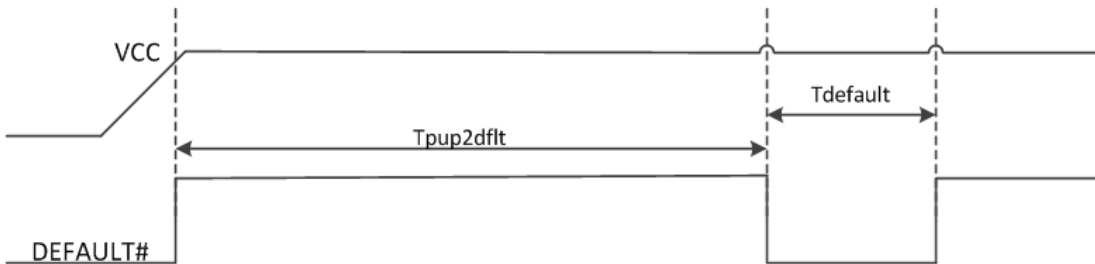
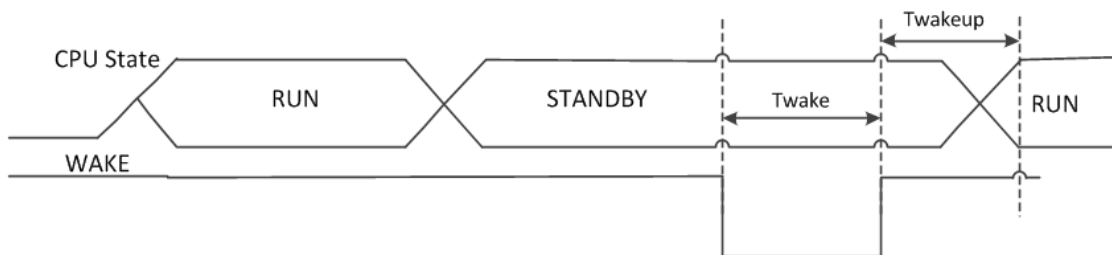


Figure 8-3 Wake Timing

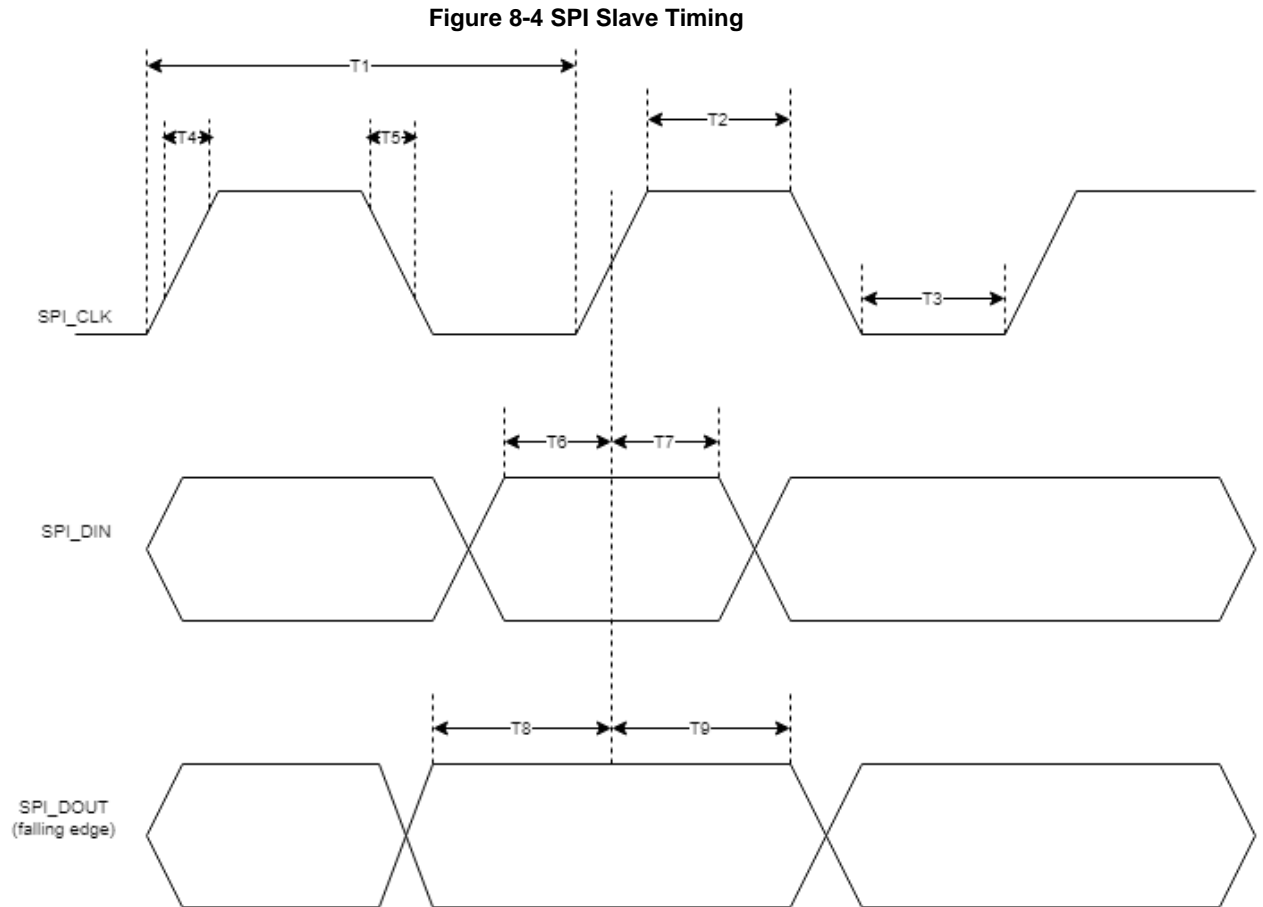


**Table 8-13: Shutdown Pin Timing**

<b>Parameter</b>	<b>Description</b>	<b>Minimum</b>	<b>Maximum</b>	<b>Unit</b>
T <sub>pu</sub>	Time for VCC to reach 90% of its maximum value	40	1000	us
T <sub>por</sub>	Time from VCC to reach 90% of its maximum value and de-assertion of external reset.	50		ms
T <sub>reboot</sub>	Recommended reset pulse for system reboot	50		ms
T <sub>pup2dflt</sub>	Time from VCC power up to DEFAULT# assertion. Note DEFAULT# can be left floating if unused.	0		ns
T <sub>default</sub>	Assertion time for DEFAULT# to unit reset to default and reboot.	6		S
T <sub>wake</sub>	Wake pulse width. Note wakeup is triggered on the rising edge.	100		us
T <sub>ei0_off</sub>	Time recommended to shut off external IO to prevent leakage into module	0		ms

## SPI Slave Timing

The diagram below shows the timing requirement for SPI\_CLK, SPI\_DIN, and SPI\_DOUT. Data is sampled on the rising edge of the clock.

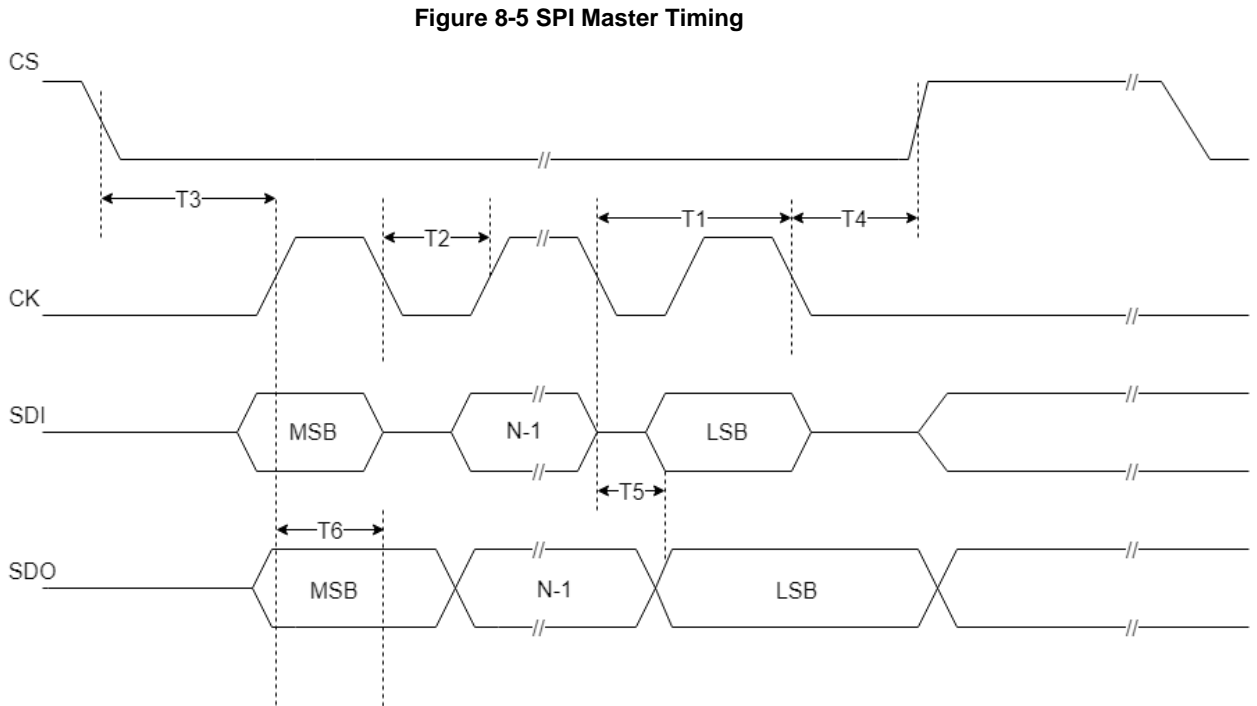


**Table 8-14: SPI Slave Timing**

Parameter	Description	Minimum	Maximum	Unit
T1	Clock period. $F_{max} = 50$ MHz.	2.08	-	ns
T2/T3	Clock high/low.	$(0.45 \times T1) - T4$	$(0.55 \times T1) - T4$	ns
T4/T5	Clock rise/fall time.	-	2.5	ns
T6	Input setup time, SIMO valid to SPI_CLK active edge.	5.0	-	ns
T7	Input hold time, SPI_CLK active edge to SIMO invalid.	5.0	-	ns
T8	Output setup time, SOMI valid before SPI_CLK rising.	5.0	-	ns
T9	Output hold time, SPI_CLK active edge to SOMI invalid.	5.0	-	ns
CSX to clock	CSX fall to 1 <sup>st</sup> rising edge. SPI_CSx remains active for the entire duration of SPI Slave read/write/write_read transaction.	7.86	-	ns
Clock to CSX	Last falling edge to CSX high.	-	-	ns

## SPI Master Timing

The diagram below shows the timing requirement for CS, CK, SDI, and SDO.



**Table 8-15: SPI Master Timing**

Parameter	Description	Minimum	Maximum	Unit
	Operating Voltage		VDDIO	V
	Frequency of operation	1	26.7	MHz
T1	SCK output cycle time	1/26.7MHz		ns
T2	SCK output high/low time	18		ns
T3	CS Active to SCK delay	880		ns
T4	SCK to CS inactive delay	756		ns
T5	SCK to MOSI valid	-	13	ns
T6	SCK to MOSI invalid	35.6		ns

## Memory

The xPico 200 module comes with the following memory profile:

### Flash Memory

The xPico 200 module has 8 MB serial NOR flash that is shared between the boot, OS, and user space.

### SRAM

The xPico 200 module has 2 MB SRAM.

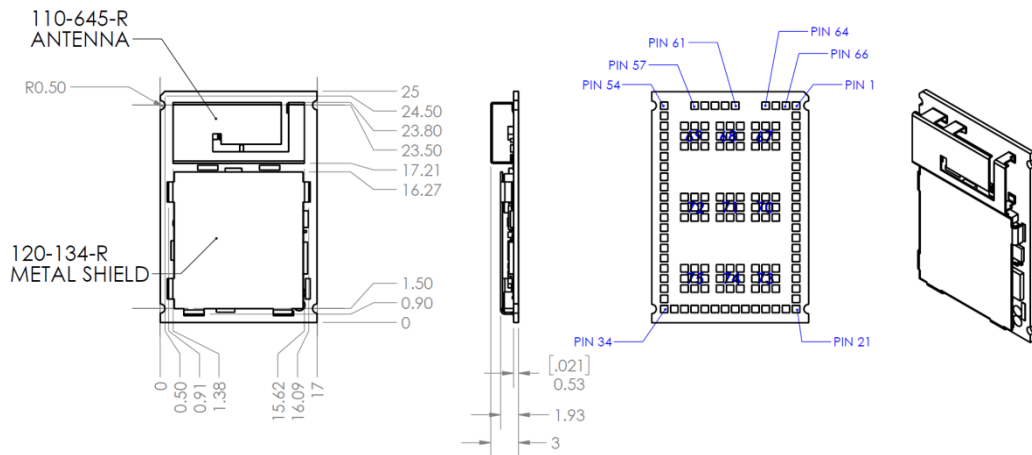
## 9. Package Description and Mechanical Footprint

The xPico 200 module comes in two different mechanical packages. The first is an SMT module with an LGA footprint. The LGA footprint version is for SMT applications. The second mechanical package is the xPico 200 module mounted on an edge card. The mechanical dimensions for both options are shown below. Both mechanical packages also come with options for two U.FL connectors for connection to external antennas or a single on-module antenna. Note, Bluetooth is not available for the options with on-module antenna.

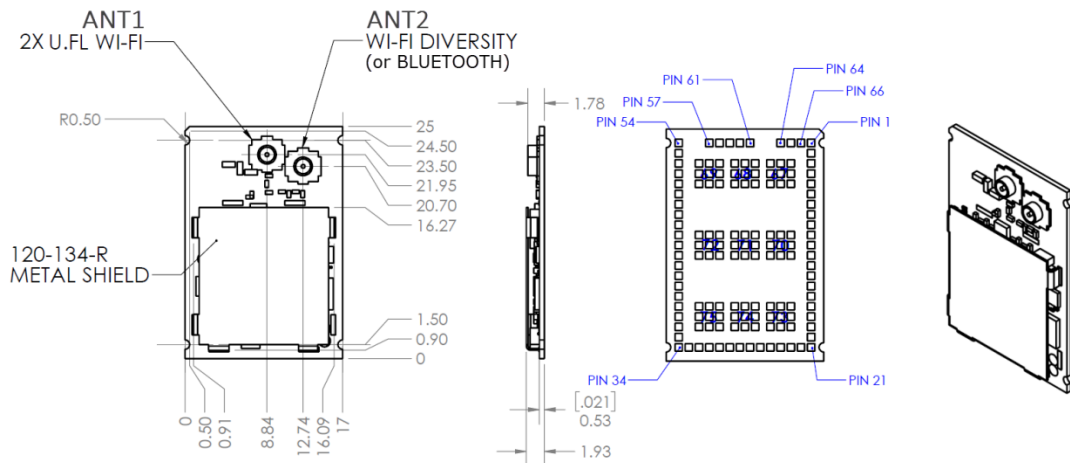
### Dimensions

The size and thickness of the xPico 200 module is 25 mm (L) x 17 mm (W) x 2.53 mm (H) +/- 0.3 mm (including shielding). The PCB footprint is shown in [Figure 9-3](#).

**Figure 9-1 xPico 200 Embedded Wi-Fi Gateway (On-Module Antenna)**

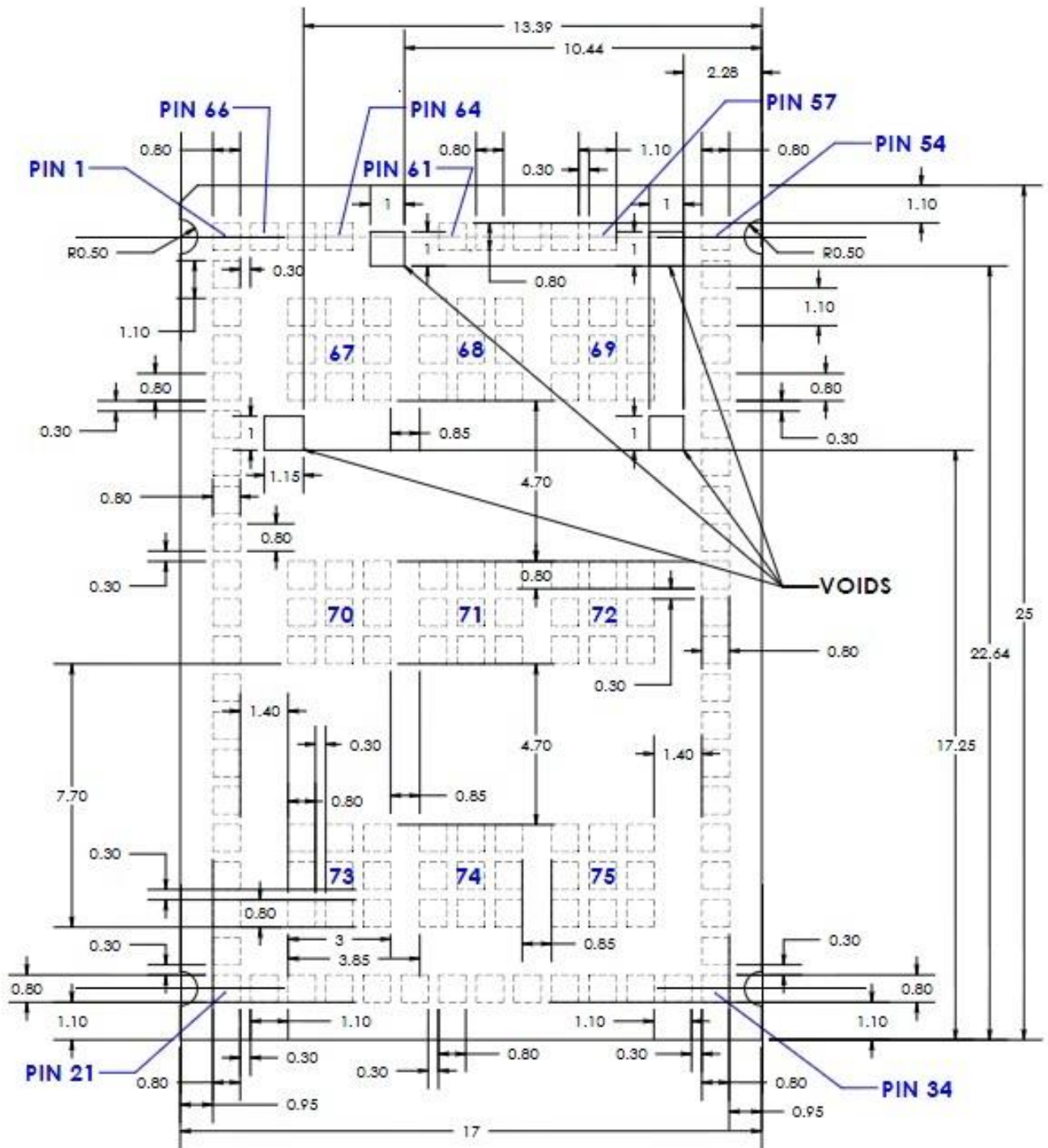


**Figure 9-2 xPico 200 Embedded Wi-Fi Gateway (Dual U.FL)**



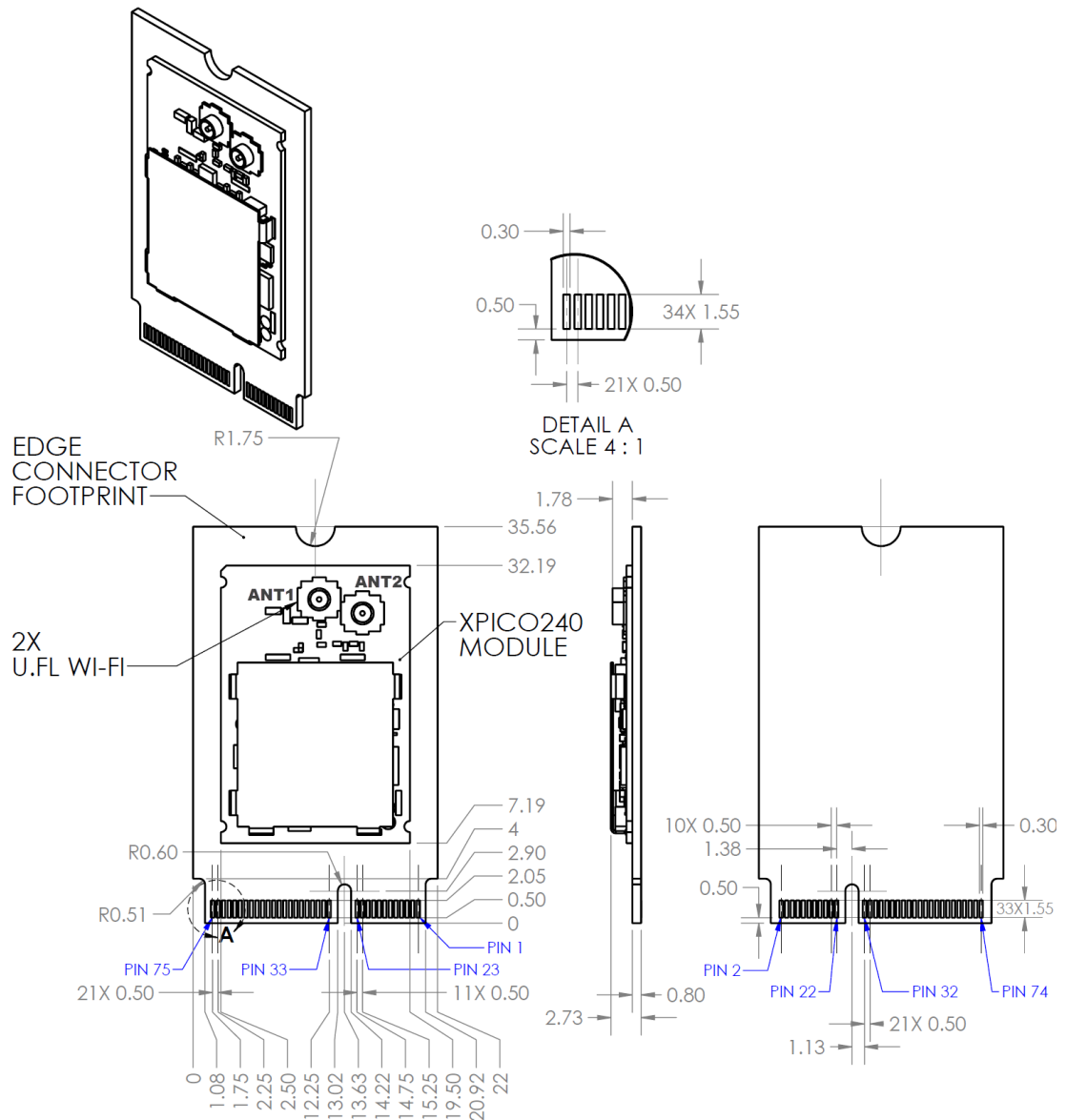
**Note:** Wi-Fi Diversity not available on units with Bluetooth.

**Figure 9-3 Layout Footprint for xPico 200  
Enterprise Wi-Fi IoT Module**



**Note:** It is recommended to follow the evaluation platform layout. Find this within the Platform PCB Package, which can be downloaded at <https://www.lantronix.com/products/xpico-200/>.

Figure 9-4 xPico 200 Edge Connector Footprint Dimensions



**Note:** The Edge Connector Module mates to TE Connectivity part number 2199230-4.

## Material and Weight

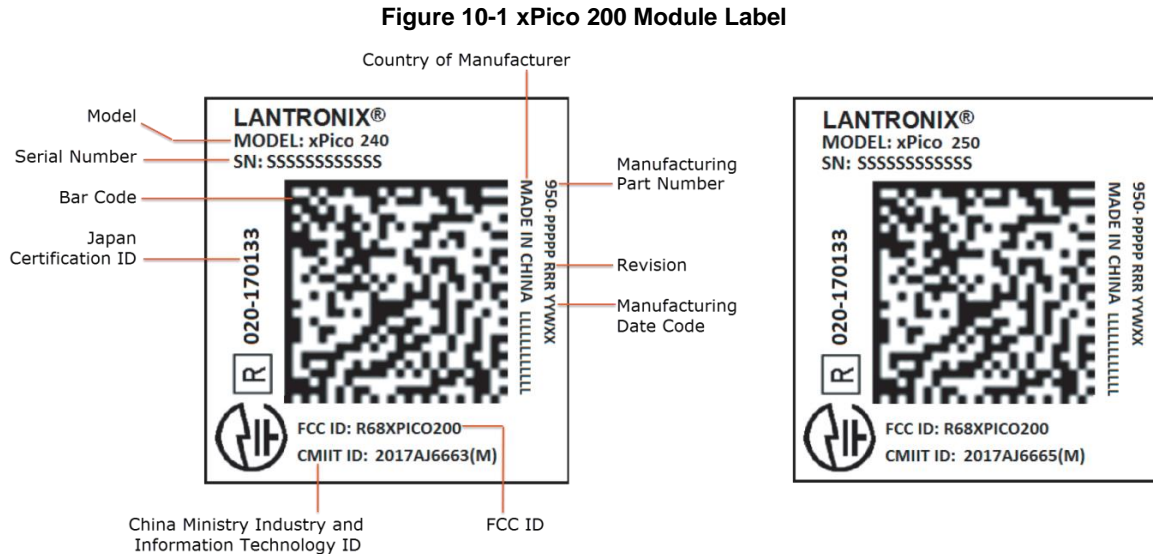
Table 9-1: Material and Weight

Category	Description
Weight	1.654 g (with on module antenna option), 1.552 g (with two U.FL option)
Material	Metal shell



## 10. Product Information Label

The product information label contains important information about your specific module, including the part number, revision, manufacturing date code, product model, country of origin, Datamatrix barcode, and MAC address.



The xPico 200 module uses the Datamatrix ECC200 bar code standard. The field definitions are as follows:

**Table 10-1: Datamatrix ECC200 Barcode Standard Descriptions**

Field	Description	Example
V1	Barcode revision	4
C1	Count of tags	3
P1	Part number of the module	950-00101
R1	Revision of the module	A11
D1	Manufacturing date code of the module	14W20
L1	Manufacturing location/factory	CHINA 01
S1	Serial number	0080A3980404
S2	ConsoleFlow Device ID	AAAABBBBCCCCDDDDDEEEEEEFFFGGGGHHHH
E1	End of barcode	

## 11. Compliance

(According to ISO/IEC Guide and EN 45014)

### Manufacturer's Name & Address:



Lantronix, Inc., 48 Discovery, Suite 250, Irvine, CA 92618 USA

Declares that the following product:

**Product Name Model:** xPico 200

Conforms to the following standards or other normative documents:

**Table 11-1: Country Certifications (xPico 240/250/270)**

Country	Specification	xPico 240	xPico 250	xPico 270
USA 	FCC Part 15, Subpart B, Class B FCC Part 15, Subpart C 15.247 (WLAN) FCC Part 15, Subpart C 15.247 (BT) FCC Part 15, Subpart E 15.407 (DFS)	Yes	Yes	Yes
Canada	ICES-003:2012 Issue 5, Class B RSS-Gen, Issue 4, 2014-11 RSS-102, Issue 5, 2015-03 RSS-247, Issue 2, 2017-02	Yes	Yes	Yes
EU	See EU Declaration of Conformity below.	Yes	Yes	Yes
UK	See UK Declaration of Conformity below.	Yes	Yes	Yes
Australia, New Zealand  N11206	AS/NZS 4268 2017 AS/NZS 2772.2	Yes	Yes	Yes
Japan	ARIB STD-T66(v3.7), MIC notice 88 Appendix 43 ARIB STD-T71(v6.1), MIC notice 88 Appendix 45	Yes	Yes	Yes
China	SRRC	Yes	Yes	Yes
India	WPC ETA	**	Yes	Yes
Taiwan	LP002	**	Yes	Yes
Mexico	NOM, IFETEL	**	Yes	Yes
Safety	EN 62368-1	Yes	Yes	Yes

\*\*For additional regional certification requests please contact your local Lantronix sales team member.

## Labeling of the End Product

The label on the end product incorporating the xPico 200 gateway must clearly state that it contains an FCC-approved RF module. Canada and Japan also require a similar statement.

For example, “This product contains RF transmitter ID # (put FCC, IC, CMIIT, and/or Japan module grant numbers here).” The label must include the ID numbers for the regions where the end product is installed. The grant numbers are below.

**Table 11-2: Country Transmitter IDs (xPico 240)**

Country	Specification
USA FCC ID	R68XPICO200
Canada IC ID	3867A-XPICO200
Japan ID	020-170133
China SRRC	2017AJ6663(M)
India ID	**Contact Lantronix Sales
Taiwan ID	**Contact Lantronix Sales
Mexico ID	**Contact Lantronix Sales

**Table 11-3: Country Transmitter IDs (xPico 250)**

Country	Specification
USA FCC ID	R68XPICO200
Canada IC ID	3867A-XPICO200
Japan ID	020-170133
China SRRC	2017AJ6665(M)
India ID	ETA-SD-20190501074
Taiwan ID	CCAJ19LP6150T9
Mexico ID	RCPLAXP19-1127

**Table 11-4: Country Transmitter IDs (xPico 270)**

Country	Specification
USA FCC ID	R68XPICO200
Canada IC ID	3867A-XPICO200
Japan ID	201-200880
China SRRC	2021AJ0636(M)
India ID	ETA-SD-20190601953
Taiwan ID	CCAJ19LP6151T1
Mexico ID	RCPLAXP19-1125

\*\*For additional regional certification requests please contact your local Lantronix sales team member.

## Federal Communication Commission Interference Statement (xPico 240/250/270)

This device complies with Part 15 of the FCC Rules. Operation is subject to the following two conditions: (1) This device may not cause harmful interference, and (2) this device must accept any interference received, including interference that may cause undesired operation.

This equipment has been tested and found to comply with the limits for a Class B digital device, pursuant to Part 15 of the FCC Rules. These limits are designed to provide reasonable protection against harmful interference in a residential installation. This equipment generates, uses, and can radiate radio frequency energy and, if not installed and used in accordance with the instructions, may cause harmful interference to radio communications. However, there is no guarantee that interference will not occur in a particular installation. If this equipment does cause harmful interference to radio or television reception, which can be determined by turning the equipment off and on, the user is encouraged to try to correct the interference by one of the following measures:

- ◆ Reorient or relocate the receiving antenna.
- ◆ Increase the separation between the equipment and receiver.
- ◆ Connect the equipment into an outlet on a circuit different from that to which the receiver is connected.
- ◆ Consult the dealer or an experienced radio/TV technician for help.

**FCC Caution:** Any changes or modifications not expressly approved by the party responsible for compliance could void the user's authority to operate this equipment.

This transmitter must not be co-located or operating in conjunction with any other antenna or transmitter.

*Operations in the 5.15-5.25 GHz band are restricted to indoor usage only.*

### Radiation Exposure Statement:

This equipment complies with FCC radiation exposure limits set forth for an uncontrolled environment. This equipment should be installed and operated with minimum distance 20cm between the radiator & your body.

### This device is intended only for OEM integrators under the following conditions:

- 1) The antenna must be installed such that 20 cm is maintained between the antenna and users, and
- 2) The transmitter module may not be co-located with any other transmitter or antenna.

As long as 2 conditions above are met, further transmitter test will not be required. However, the OEM integrator is still responsible for testing their end-product for any additional compliance requirements required with this module installed.

**IMPORTANT NOTE:** *In the event that these conditions cannot be met (for example certain laptop configurations or colocation with another transmitter), then the FCC authorization is no longer considered valid and the FCC ID cannot be used on the final product. In these circumstances, the OEM integrator will be responsible for re-evaluating the end product (including the transmitter) and obtaining a separate FCC authorization.*

### End Product Labeling

This transmitter module is authorized only for use in device where the antenna may be installed such that 20 cm may be maintained between the antenna and users. The final end product must

be labeled in a visible area with the following: "Contains FCC ID: R68XPICO200". The grantee's FCC ID can be used only when all FCC compliance requirements are met.

### **Manual Information to the End User**

The OEM integrator must not provide information to the end user regarding how to install or remove this RF module in the user's manual of the end product which integrates this module.

The end user manual shall include all required regulatory information/warning as show in this manual.

### **Industry Canada Statement (xPico 240/250/270):**

This device complies with RSS-247 of the Industry Canada Rules. Operation is subject to the following two conditions: (1) This device may not cause harmful interference, and (2) this device must accept any interference received, including interference that may cause undesired operation.

Ce dispositif est conforme à la norme CNR-247 d'Industrie Canada applicable aux appareils radio exempts de licence. Son fonctionnement est sujet aux deux conditions suivantes: (1) le dispositif ne doit pas produire de brouillage préjudiciable, et (2) ce dispositif doit accepter tout brouillage reçu, y compris un brouillage susceptible de provoquer un fonctionnement indésirable.

### **Radiation Exposure Statement:**

This equipment complies with IC radiation exposure limits set forth for an uncontrolled environment. This equipment should be installed and operated with minimum distance 20cm between the radiator & your body.

### **Déclaration d'exposition aux radiations:**

Cet équipement est conforme aux limites d'exposition aux rayonnements IC établies pour un environnement non contrôlé. Cet équipement doit être installé et utilisé avec un minimum de 20 cm de distance entre la source de rayonnement et votre corps.

### **This device is intended only for OEM integrators under the following conditions: (For module device use)**

- 1) The antenna must be installed such that 20 cm is maintained between the antenna and users, and
- 2) The transmitter module may not be co-located with any other transmitter or antenna.

As long as 2 conditions above are met, further transmitter test will not be required. However, the OEM integrator is still responsible for testing their end-product for any additional compliance requirements required with this module installed.

### **Cet appareil est conçu uniquement pour les intégrateurs OEM dans les conditions suivantes: (Pour utilisation de dispositif module)**

- 1) L'antenne doit être installée de telle sorte qu'une distance de 20 cm est respectée entre l'antenne et les utilisateurs, et
- 2) Le module émetteur peut ne pas être coïmplanté avec un autre émetteur ou antenne.

Tant que les 2 conditions ci-dessus sont remplies, des essais supplémentaires sur l'émetteur ne seront pas nécessaires. Toutefois, l'intégrateur OEM est toujours responsable des essais sur son produit final pour toutes exigences de conformité supplémentaires requis pour ce module installé.

### **IMPORTANT NOTE:**

*In the event that these conditions can not be met (for example certain laptop configurations or co-location with another transmitter), then the Canada authorization is no longer considered valid and the IC ID can not be used on the final product. In these circumstances, the OEM integrator will be responsible for re-evaluating the end product (including the transmitter) and obtaining a separate Canada authorization.*

### **NOTE IMPORTANTE:**

*Dans le cas où ces conditions ne peuvent être satisfaites (par exemple pour certaines configurations d'ordinateur portable ou de certaines co-localisation avec un autre émetteur), l'autorisation du Canada n'est plus considéré comme valide et l'ID IC ne peut pas être utilisé sur le produit final. Dans ces circonstances, l'intégrateur OEM sera chargé de réévaluer le produit final (y compris l'émetteur) et l'obtention d'une autorisation distincte au Canada.*

### **Plaque signalétique du produit final**

Ce module émetteur est autorisé uniquement pour une utilisation dans un dispositif où l'antenne peut être installée de telle sorte qu'une distance de 20cm peut être maintenue entre l'antenne et les utilisateurs. Le produit final doit être étiqueté dans un endroit visible avec l'inscription suivante: "Contient des IC: 3867A-XPICO200".

### **Manual Information To the End User**

The OEM integrator has to be aware not to provide information to the end user regarding how to install or remove this RF module in the user's manual of the end product which integrates this module.

The end user manual shall include all required regulatory information/warning as show in this manual.

### **Manuel d'information à l'utilisateur final**

L'intégrateur OEM doit être conscient de ne pas fournir des informations à l'utilisateur final quant à la façon d'installer ou de supprimer ce module RF dans le manuel de l'utilisateur du produit final qui intègre ce module.

Le manuel de l'utilisateur final doit inclure toutes les informations réglementaires requises et avertissements comme indiqué dans ce manuel.

### **Caution :**

*(i) the device for operation in the band 5150-5250 MHz is only for indoor use to reduce the potential for harmful interference to cochannel mobile satellite systems;*

*(ii) the maximum antenna gain permitted for devices in the bands 5250-5350 MHz and 5470-5725 MHz shall be such that the equipment still complies with the e.i.r.p. limit;*

*(iii) the maximum antenna gain permitted for devices in the band 5725-5850 MHz shall be such that the equipment still complies with the e.i.r.p. limits specified for point-to-point and non-point-to-point operation as appropriate; and*

*(iv) Users should also be advised that high-power radars are allocated as primary users (i.e. priority users) of the bands 5250-5350 MHz and 5650-5850 MHz and that these radars could cause interference and/or damage to LE-LAN devices.*

### **Avertissement :**

Le guide d'utilisation des dispositifs pour réseaux locaux doit inclure des instructions précises sur les restrictions susmentionnées, notamment :

(i) les dispositifs fonctionnant dans la bande 5150-5250 MHz sont réservés uniquement pour une utilisation à l'intérieur afin de réduire les risques de brouillage préjudiciable aux systèmes de satellites mobiles utilisant les mêmes canaux;

(ii) le gain maximal d'antenne permis pour les dispositifs utilisant les bandes de 5250 à 5350 MHz et de 5470 à 5725 MHz doit être conforme à la limite de la p.i.r.e.;

(iii) le gain maximal d'antenne permis (pour les dispositifs utilisant la bande de 5725 à 5850 MHz) doit être conforme à la limite de la p.i.r.e. spécifiée pour l'exploitation point à point et l'exploitation non point à point, selon le cas;

(iv) De plus, les utilisateurs devraient aussi être avisés que les utilisateurs de radars de haute puissance sont désignés utilisateurs principaux (c.-à-d., qu'ils ont la priorité) pour les bandes 5250-5350 MHz et 5650-5850 MHz et que ces radars pourraient causer du brouillage et/ou des dommages aux dispositifs LAN-EL.

Figure 11-12 EU Declaration of Conformity (xPico 240 / xPico 250 / xPico 270)

**LANTRONIX®**


**CE**

**EU DECLARATION OF CONFORMITY**

**Manufacturer's Name:** LANTRONIX INC.  
**Manufacturer's Address:** 7535 Irvine Center Drive, Suite 100 Irvine, CA. 92618. USA

**Product Type:** xPico® 200 Series Wi-Fi® IoT Gateway  
**Product Family:** xPico 240 / xPico 250 / xPico 270

**Manufacturer's Quality System:**

 **ISO 9001:2015 Certificate No. 74 300 4282 TUV Rheinland**

**Applicable EU Directives:**

**Low Voltage Directive (2014/35/EU)**

- EN 62368-1:2014/AC:2015
- EN62311:2020

**EMC Directive (2014/30/EU)**

- EN301489-1 V2.2.3
- EN301489-3 V2.2.0
- EN301 489-17 V3.2.4


**RF Radio Directive (2014 / 53 / EU)**

- EN 300 328 V2.2.2
- EN 301 893 V2.1.1
- EN 300 440 V2.2.1

**RoHS**

- 1) 2011/65/EU Restriction of the use of Hazardous Substances in EEE (RoHS)
- 2) 2015/863/EU Change of Annex II from 2011/65/EU
- 3) Directive 2018/736/EU and 2018/741/EU
  - EN 63000-2018

**Statement of Conformity:** The product specified above complies with applicable EU directive referenced, including the application of sound engineering practice.

Signature:  \_\_\_\_\_ Date: April 18, 2022

Name: Fathi Hakam Title: VP of Engineering

CERT-00160 rev C



Figure 11-23 UK Declaration of Conformity (xPico 240 / xPico 250 / xPico 270)

**LANTRONIX®**


**UK  
CA**

**UK DECLARATION OF CONFORMITY**

UK-type examination certificate: 222340202/AA/00

**Manufacturer's Name:** LANTRONIX INC.  
**Manufacturer's Address:** 48 Discovery, Suite 250, Irvine, CA 92618 USA  
**Product Type:** xPico® 200 Series Wi-Fi® IoT Gateway  
**Product Type:** xPico 250, xPico 240, xPico 270  
**Software version:** 3.3.0.0T3+  
**Intended use:** Commercial installations, indoor use

**Manufacturer's Quality System:**

 TUV Rheinland  
ISO 9001:2015 Certificate No. 74 300 4282 TUV Rheinland

We hereby declare that the above named product is conformity to all the essential requirements of the UK Radio Equipment Regulations 2017 SI 2017/1206

- EN 62368-1:2014/AC:2015
- EN62311:2020
- EN301489-1 V2.2.3
- EN301489-3 V2.1.1
- EN301 489-17 V3.2.4
- EN 300 328 V2.2.2
- EN 301 893 V2.1.1
- EN 300 440 V2.2.1

The conformity assessment procedure under the provisions of Regulation 41 and Schedule 3 of the Radio Equipment Regulations 2017 (SI 2017/1206) has been followed with the involvement of the following Approved Body:


**Bureau Veritas Consumer Products Services, Inc. (AB2200)**  
775 Montague Expressway, Milpitas, CA 95035, USA

**UK SI 2012 No. 3032 for Restriction of Hazardous Substance (RoHS2) with exemption 7(c)-I and 6(c).**

- 1) 2011/65/EU Restriction of the use of Hazardous Substances in EEE (RoHS)
- 2) 2015/863/EU Change of Annex II from 2011/65/EU
- 3) Directive 2018/736/EU[7(c)-I] and 2018/741/EU[6(c)]

**BS EN IEC 63000 : 2018**

**Statement of Conformity:** The product specified above meets the test requirements of the relevant legislation of United Kingdom, including the application of sound engineering practice.

Signature:  Date: November 14, 2022

Name: Fathi Hskam Title: VP of Engineering

**Table 11-5: Europe – EU Declaration of Conformity (xPico 240/250/270)**

<b>cs</b>	Česky [Czech]	Lantronix tímto prohlašuje, že tento xPico 200 je ve shodě se základními požadavky a dalšími příslušnými ustanoveními směrnice 2014/53/EU.
<b>da</b>	Dansk [Danish]	Undertegnede Lantronix erklærer herved, at følgende udstyr xPico 200 overholder de væsentlige krav og øvrige relevante krav i direktiv 2014/53/EU.
<b>de</b>	Deutsch [German]	Hiermit erkläre Lantronix, dass sich das Gerät xPico 200 in Übereinstimmung mit den grundlegenden Anforderungen und den übrigen einschlägigen Bestimmungen der Richtlinie 2014/53/EU befindet.
<b>et</b>	Eesti [Estonian]	Käesolevaga kinnitab Lantronix seadme xPico 200 vastavust direktiivi 2014/53/EU põhinõuetele ja nimetatud direktiivist tulenevatele teistele asjakohastele sätetele.
<b>en</b>	English	Hereby, Lantronix, declares that this xPico 200 is in compliance with the essential requirements and other relevant provisions of Directive 2014/53/EU.
<b>es</b>	Español [Spanish]	Por medio de la presente Lantronix declara que el xPico 200 module cumple con los requisitos esenciales y cualesquiera otras disposiciones aplicables o exigibles de la Directiva 2014/53/EU.
<b>el</b>	Ελληνική [Greek]	ΜΕ ΤΗΝ ΠΑΡΟΥΣΑ Lantronix ΔΗΛΩΝΕΙ ΟΤΙ xPico 200 ΣΥΜΜΟΡΦΩΝΕΤΑΙ ΠΡΟΣ ΤΙΣ ΟΥΣΙΩΔΕΙΣ ΑΠΑΙΤΗΣΕΙΣ ΚΑΙ ΤΙΣ ΛΟΙΠΕΣ ΣΧΕΤΙΚΕΣ ΔΙΑΤΑΞΕΙΣ ΤΗΣ ΟΔΗΓΙΑΣ 2014/53/EU.
<b>fr</b>	Français [French]	Par la présente Lantronix déclare que l'appareil xPico 200 est conforme aux exigences essentielles et aux autres dispositions pertinentes de la directive 2014/53/EU.
<b>it</b>	Italiano [Italian]	Con la presente Lantronix dichiara che questo xPico 200 è conforme ai requisiti essenziali ed alle altre disposizioni pertinenti stabilite dalla direttiva 2014/53/EU.
	Latviski [Latvian]	Ar šo Lantronix deklarē, ka xPico 200 atbilst Direktīvas 2014/53/EU būtiskajām prasībām un citiem ar to saistītajiem noteikumiem.
	Lietuvių [Lithuanian]	Šiuo Lantronix deklaruoja, kad šis xPico 200 atitinka esminius reikalavimus ir kitas 2014/53/EU Direktyvos nuostatas.
<b>nl</b>	Nederlands [Dutch]	Hierbij verklaart Lantronix dat het toestel xPico 200 overeenstemming is met de essentiële eisen en de andere relevante bepalingen van richtlijn 2014/53/EU.
<b>mt</b>	Malti [Maltese]	Hawnhekk, Lantronix, jiddikjara li dan xPico 200 jikkonforma malhtigijiet essenzjali u ma provvedimenti oħrajn rilevanti li hemm fid-Direttiva 2014/53/EU.
<b>hu</b>	Magyar [Hungarian]	Alulírott, Lantronix nyilatkozom, hogy a xPico 200 megfelel a vonatkozó alapvető követelményeknek és az 2014/53/EU irányelv egyéb előírásainak.
<b>pl</b>	Polski [Polish]	Niniejszym Lantronix oświadcza, że xPico 200 jest zgodny z zasadniczymi wymogami oraz pozostałymi stosownymi postanowieniami Dyrektywy 2014/53/EU.
<b>pt</b>	Português [Portuguese]	Lantronix declara que este xPico 200 está conforme com os requisitos essenciais e outras disposições da Directiva 2014/53/EU.
<b>sl</b>	Slovensko [Slovenian]	Lantronix izjavlja, da je ta xPico 200 v skladu z bistvenimi zahtevami in ostalimi relevantnimi določili direktive 2014/53/EU.
	Slovensky [Slovak]	Lantronix týmto vyhlasuje, že xPico 200 enterprise Wi-Fi IoT module spĺňa základné požiadavky a všetky príslušné ustanovenia Smernice 2014/53/EU.
<b>fi</b>	Suomi [Finnish]	Lantronix vakuuttaa täten että xPico 200 tyyppinen laite on direktiivin 2014/53/EU oleellisten vaatimusten ja sitä koskevien direktiivin muiden ehtojen mukainen.
<b>sv</b>	Svenska [Swedish]	Härmed intygar Lantronix att denna xPico 200 står i överensstämmelse med de väsentliga egenskapskrav och övriga relevanta bestämmelser som framgår av direktiv 2014/53/EU.

查詢 NB no.

<https://eur-lex.europa.eu/legal-content/EN/TXT/?uri=CELEX%3A32014L0053>

## RoHS, REACH, and WEEE Compliance Statement

Please visit <https://www.lantronix.com/legal/rohs/> for Lantronix's statement about RoHS, REACH and WEEE compliance.

## 12. Ordering Information

**Table 12-1: xPico 240 Order Information**

Part Number	Description
XPC240100B-02	xPico 240 Embedded IoT Gateway, 802.11 a/b/g/n, Ethernet, Dual U.FL, Ind Temp, LGA T&R 250
XPC240200B-02	xPico 240 Embedded IoT Gateway, 802.11 a/b/g/n, Ethernet, On-Module Ant, Ind Temp, LGA T&R 250
XPC240300B-02	xPico 240 Embedded IoT Gateway, 802.11 a/b/g/n, Ethernet, Dual U.FL, Ind Temp, Edge Conn, Tray
XPC240400B-02	xPico 240 Embedded IoT Gateway, 802.11 a/b/g/n, Ethernet, On-Module Ant, Ind Temp, Edge Conn, Tray
XPC240100S-02	xPico 240 Embedded IoT Gateway, 802.11 a/b/g/n, Ethernet, Dual U.FL, Ind Temp, LGA T&R 25
XPC240200S-02	xPico 240 Embedded IoT Gateway, 802.11 a/b/g/n, Ethernet, On-Module Ant, Ind Temp, LGA T&R 25
XPC240300S-02	xPico 240 Embedded IoT Gateway, 802.11 a/b/g/n, Ethernet, Dual U.FL, Ind Temp, Edge Conn, Single
XPC240400S-02	xPico 240 Embedded IoT Gateway, 802.11 a/b/g/n, Ethernet, On-Module Ant, Ind Temp, Edge Conn, Single
XPC240300EK	xPico 240 Evaluation Kit with Edge Connector Module, Dual U.FL Antenna
XPC240400EK	xPico 240 Evaluation Kit with Edge Connector Module, On-Module Antenna

**Table 12-2: xPico 250 Order Information**

Part Number	Description
XPC250100B-02	xPico 250 Embedded IoT Gateway, 802.11 a/b/g/n, Ethernet, BT 4.2, Dual U.FL, Ind Temp, LGA T&R 250
XPC250300B-02	xPico 250 Embedded IoT Gateway, 802.11 a/b/g/n, Ethernet, BT 4.2, Dual U.FL, Ind Temp, Edge Conn, Tray
XPC250100S-02	xPico 250 Embedded IoT Gateway, 802.11 a/b/g/n, Ethernet, BT 4.2, Dual U.FL, Ind Temp, LGA T&R 25
XPC250300S-02	xPico 250 Embedded IoT Gateway, 802.11 a/b/g/n, Ethernet, BT 4.2, Dual U.FL, Ind Temp, Edge Conn, Single
XPC250300EK	xPico 250 Evaluation Kit with Edge Connector Module

**Table 12-3: xPico 270 Order Information**

Part Number	Description
XPC270100B	xPico 270 Embedded IoT Gateway, 802.11 ac/a/b/g/n, Ethernet, BT 4.2, Dual U.FL, Ind Temp, LGA T&R 250
XPC270300B	xPico 270 Embedded IoT Gateway, 802.11 ac/a/b/g/n, Ethernet, BT 4.2, Dual U.FL, Ind Temp, Edge Conn, Tray
XPC270100S	xPico 270 Embedded IoT Gateway, 802.11 ac/a/b/g/n, Ethernet, BT 4.2, Dual U.FL, Ind Temp, LGA T&R 25
XPC270300S	xPico 270 Embedded IoT Gateway, 802.11 ac/a/b/g/n, Ethernet, BT 4.2, Dual U.FL, Ind Temp, Edge Conn, Single
XPC270300EK	xPico 270 Evaluation Kit with Edge Connector Module

## Warranty

The xPico 200 module comes with an industry best 5-year warranty. For more details on the Lantronix warranty replacement policy, please go to our web site at <http://https://www.lantronix.com/technical-support/warranty/>.

## Contact Information

For details contact your local Lantronix representative or Lantronix directly:

- ◆ Asia Pacific Region via e-mail at [asiapacific\\_sales@lantronix.com](mailto:asiapacific_sales@lantronix.com)
- ◆ Europe via e-mail at [eu\\_sales@lantronix.com](mailto:eu_sales@lantronix.com)
- ◆ Japan via e-mail at [japan\\_sales@lantronix.com](mailto:japan_sales@lantronix.com)
- ◆ United States via e-mail at [sales@lantronix.com](mailto:sales@lantronix.com) or call OEM sales support at 800-526-8764.

## Manufacturer's Contact

Lantronix, Inc.  
48 Discovery, Suite 250  
Irvine, CA 92618 USA

Tel: 949-453-3990  
Fax: 949-453-3995

© 2023 Lantronix, Inc. All rights reserved. *Lantronix*, *ConsoleFlow* and *xPico* are registered trademarks of Lantronix, Inc. in the United States and other countries. Patented: <https://patents.lantronix.com/>; additional patents pending.

---