

Modular Approval
 Test Report
 And Application for Grant of Equipment Authorization

TEST REPORT PERTAINING TO:

Equipment Under Test	Model Number(s)
Wireless Embedded Device Server	WiPort

CONFIGURATION
802.11g module with a US Robotics 5 dBi Antenna (USR5481)

MEASUREMENTS PERFORMED IN ACCORDANCE WITH THE FOLLOWING STANDARD (S)

Regulatory Standard(s)
47 CFR Part 15, Subpart C Section 15.247
Test Method: ANSI C63.4: 2003 American National Standard for Methods of Measurement of Radio-Noise Emissions from Low-Voltage Electrical and Electronic Equipment in the Range of 9 kHz to 40 GHz



Certificate Number: 1111.01

PREPARED FOR:
 Lantronix Inc.
 15353 Barranca Parkway
 Irvine, California 92618
 Contact(s): Mr. Daryl Miller

PREPARED BY:
 Aegis Labs, Inc.
 22431 Antonio Parkway B160-417
 Rancho S. Margarita, CA 92688
 Agent(s): Mr. Rick Candelas
 Mr. Johnny Candelas



Test Report #: LANTR-060321F
 Test Report Revision: NONE

PAGES	REPORT BODY	APPENDICES		TOTAL PAGES
		A	B	
13	34	1	48	

The contents of this report shall not be reproduced except in full, without the written approval of Aegis Labs, Inc.
 The Lantronix Inc. logo is used for identification purposes only and is a registered trademark of Lantronix Inc.



TABLE OF CONTENTS

SECTION	TITLE	PAGE
	COVER SHEET.....	01
	TABLE OF CONTENTS.....	02
1.0	REGULATORY COMPLIANCE GUIDELINES.....	03
1.1	Guidelines For Testing To Emissions Standards.....	03
2.0	SUMMARY OF REGULATORY LIMITS.....	04
3.0	ADMINISTRATIVE DATA AND TEST DESCRIPTION.....	05
4.0	DESCRIPTION OF EUT CONFIGURATION.....	06
4.1	EUT Description	06
4.2	EUT Configuration.....	07
4.3	List of EUT Sub-Assemblies and Host Equipment.....	08
4.4	I/O Cabling Diagram and Description	09
4.5	EMC Test Hardware and Software Measurement Equipment.....	11
5.0	CONDITIONS DURING EMISSIONS MEASUREMENTS.....	12
5.1	General.....	12
5.2	Conducted Emissions Test Setup.....	12
5.3	Radiated Emissions Test Setup.....	13

APPENDICES

A	Test Data
B	Modifications And Recommendations



1.0 REGULATORY COMPLIANCE GUIDELINES

Aegis Labs, Inc. operates as both a Nevada and California Corporation with no organizational or financial relationship with any company, institution, or private individual. Testing and engineering functions provided by Aegis Labs were furnished by RF technicians and engineers with accredited qualifications and training credentials to carry out their duties.

The object of this report was to publish verifiable test results of an EUT subjected to the tests outlined in the standard listed on the cover page of this report.

1.1 Guidelines For Testing To Emissions Standards

This standard for EMC emission requirements apply to electrical equipment for Information Technology Equipment (ITE). Compliance to these standards and in combination with the other standards listed in this test report can be used to demonstrate presumption of compliance with the protection requirements of the appropriate agency standard.

The purpose of this standard is to specify minimum requirements for emissions regarding electromagnetic compatibility (EMC) and protect the radio frequency spectrum 9 kHz. – 400 GHz. from unwanted interference generated from electrical/digital systems that intentionally or unintentionally generated RF energy. The emissions standards, normative documents and/or publications were used to conduct all tests performed on the equipment herein referred to as “Equipment Under Test”.

2.0 SUMMARY OF TEST RESULTS

802.11g Mode (2400-2483.5 MHz)

EMISSIONS STANDARD

FCC Part 15 Section	Description	Results	Comments
15.247(a)(2)	The minimum 6dB bandwidth shall be at least 500 kHz.	PASSED	2412 MHz = 16.50 MHz 2437 MHz = 16.58 MHz 2462 MHz = 16.58 MHz
15.247(b)(3)	The maximum peak output power of the intentional radiator shall not exceed 1 watt.	PASSED	2412 MHz = 20.81 dBm = 120.50 mW 2437 MHz = 20.93 dBm = 123.88 mW 2462 MHz = 20.23 dBm = 105.44 mW
15.247(b)(5)	The intentional radiator shall be operated in a manner that ensures that the public is not exposed to radio frequency energy levels in excess of the FCC guidelines per Section 1.1307(b)(1).	PASSED	Refer to MPE Calculations Exhibit
15.247(c)	In any 100 kHz bandwidth outside the frequency band in which the spread spectrum intentional radiator is operating, the radio frequency power that is produced by the intentional radiator shall be at least 20 dB below that in the 100 kHz bandwidth within the band that contains the highest level of the desired power.	PASSED	See Data Sheets
15.247(c)	Radiated emissions, which fall in the restricted bands, as defined in Sec. 15.205(a), must also comply with the radiated emission limits specified in Sec. 15.209(a). All others must be < -20dBc.	PASSED	See Data Sheets
15.247(d)	The peak power spectral density conducted from the intentional radiator to the antenna shall not be greater than 8 dBm in any 3 kHz band during any time interval of continuous transmission.	PASSED	2412 MHz = -19.17 dB 2437 MHz = -17.33 dB 2462 MHz = -19.50 dB
15.207	AC Conducted Emissions	PASSED	See Data Sheets
15.209	Radiated Emissions (30-1000 MHz)	PASSED	See Data Sheets

ANALYSIS AND CONCLUSIONS

Based upon the measurement results we find that this equipment is within the limits of the standard listed on the cover page of this test report. All results are based on a test of one sample. If any significant changes are made to the unit, the changes shall be evaluated and a retest may be required.

Approval Signatories

Test and Report Completed By:

06/06/06

Johnny Candelas
Test Technician
Aegis Labs, Inc.

Date:

Report Approved By:

06/06/06

Rick Candelas
Quality Assurance Manager
Aegis Labs, Inc.

Date:

3.0 ADMINISTRATIVE DATA AND TEST DESCRIPTION

DEVICE TESTED:	ITE Type: Wireless Embedded Device Server Model Number(s): WiPort Serial Number: 00-20-4A-89-46-88 FCC ID: R68WIPORTG
DATE EUT RECEIVED:	May 3 rd , 2006
TEST DATE(S):	May 3 rd – June 6 th , 2006
ORIGIN OF TEST SAMPLE(S):	Production
EQUIPMENT CLASS:	EUT tested as CLASS B device
RESPONSIBLE PARTY:	Lantronix Inc. 15353 Barranca Parkway Irvine, CA 92618
CLIENT CONTACT:	Mr. Daryl Miller
MANUFACTURER:	Lantronix Inc.
TEST LOCATION:	Aegis Labs, Inc. 32231 Trabuco Creek Road Trabuco Canyon, CA 92678 Open Area Test Site #1 & #2
ACCREDITATION CERTIFICATE(S):	A2LA Certificate Number: 1111.01, Valid through February 28, 2008
PURPOSE OF TEST:	To demonstrate compliance with the standards as described in Sections 1.0 & 2.0 of this report.
UNCERTAINTY BUDGET:	Proficiency Testing and Uncertainty Calculations for all tests indicated in this report have been conducted in accordance with ISO 17025: 2005 requirements Section 5.4.6, and 5.9. Uncertainty Budgets and Proficiency Test results available upon request.
STATEMENT OF CALIBRATION:	All accredited equipment calibrations were performed by Liberty Labs, Inc. and World Cal. with typical calibration uncertainty estimates derived from ISO Guide to the determination of uncertainties with a Coverage Factor of k=2 for 95% level of confidence.

4.0 DESCRIPTION OF EUT CONFIGURATION

4.1 EUT Description

Equipment Under Test (EUT)	
Trade Name:	Wireless Embedded Device Server
Model Number:	WiPort
Frequency Range:	802.11g = 2400 – 2483.5 MHz
Type of Transmission:	Direct Sequence Spread Spectrum
Transfer Rate:	6/36/54 Mbps for 802.11g mode
Number of Channels:	802.11g mode (2400-2483.5 MHz) = 11
Modulation Type:	OFDM
Antenna Type:	External Swivel Antenna with Reverse SMA connector
Antenna Gain (See Note 2):	2.4 GHz = 5.00 dBi
Transmit Output Power:	Ch. 1-10: 14dBm Average & Ch. 11: 12dBm Average(Typical) for 802.11g mode Please see Appendix A (Data Sheets) for actual output power.
Power Supply:	3.3VDC input from external 120VAC Adapter
Number of External Test Ports Exercised:	1 Antenna Port, 2 Serial Ports, 1 Network Port

The Wireless Embedded Device Server provides a network-enabling solution based on the IEEE 802.11g wireless standard. WiPort allows Original Equipment Manufacturers (OEMs) to add wireless connectivity to their products by incorporating it onto a circuit board.

It was tested as a standalone device with a US Robotics (MN: USR5481) antenna continuously transmitting and receiving from the antenna port.

NOTE 1: For a more detailed description, please refer to the manufacture’s specifications or User’s Manual.

NOTE 2: The EUT was tested with a US Robotics antenna. (Refer to the antenna specifications exhibits).



4.2 EUT Configuration

For Testing Above 1GHz

The EUT was tested as a standalone device connected to a remotely located Lantronix Hub via its network port & a Dell computer via its serial port 1. The Lantronix Hub was then connected to a Dell computer via its network port. The Dell computer was then connected to a Dell monitor, a Dell keyboard and Logitech mouse via its video, keyboard and mouse ports respectively. A US Robotics external antenna (USR5481) was connected to the EUT's antenna ports via its reverse SMA antenna connector. Data for the US Robotics antenna can be found in Appendix A (Data Sheets).

The low, middle, and high channels were tested in 802.11g mode. The EUT was placed in either continuous transmit or continuous receive mode by a program provided by the manufacturer (*Linktest*).

4.3 List of EUT, Sub-Assemblies and Host Equipment

Equipment Under Test			
Manufacturer	Equipment Name	Model or Part Number	Serial Number
Lantronix Inc.	Wireless Embedded Device Server	WiPort	00-20-4A-89-46-88

EUT Sub Assemblies			
Manufacturer	Equipment Name	Model or Part Number	Serial Number
US Robotics	External Antenna	USR5481	N/A
Group-West	Power Adapter	TRC-12-0830	N/A
Hon-Kwang	Power Adapter	D12-10-1000	N/A
CUI	Power Adapter	3A-161WP12-S20-080	N/A

Remotely Located Support Equipment			
Manufacturer	Equipment Name	Model or Part Number	Serial Number
Dell	Host Computer	XPS T450	4ZFAW
Dell	Monitor	E550	MY-07753T-46632-9BR-23D1
Dell	Keyboard	RT7D5JTW	37171 03H S341
Logitech	Mouse	M-S3S	LZK13810013
Lantronix	Hub	LTR8T	0718130
Linksys	Router	WRTS4G5 V.2	CGN30E436355

NOTE: All the power cords of the above support equipment are standard and non-shielded.

4.4 I/O Cabling Diagram and Description

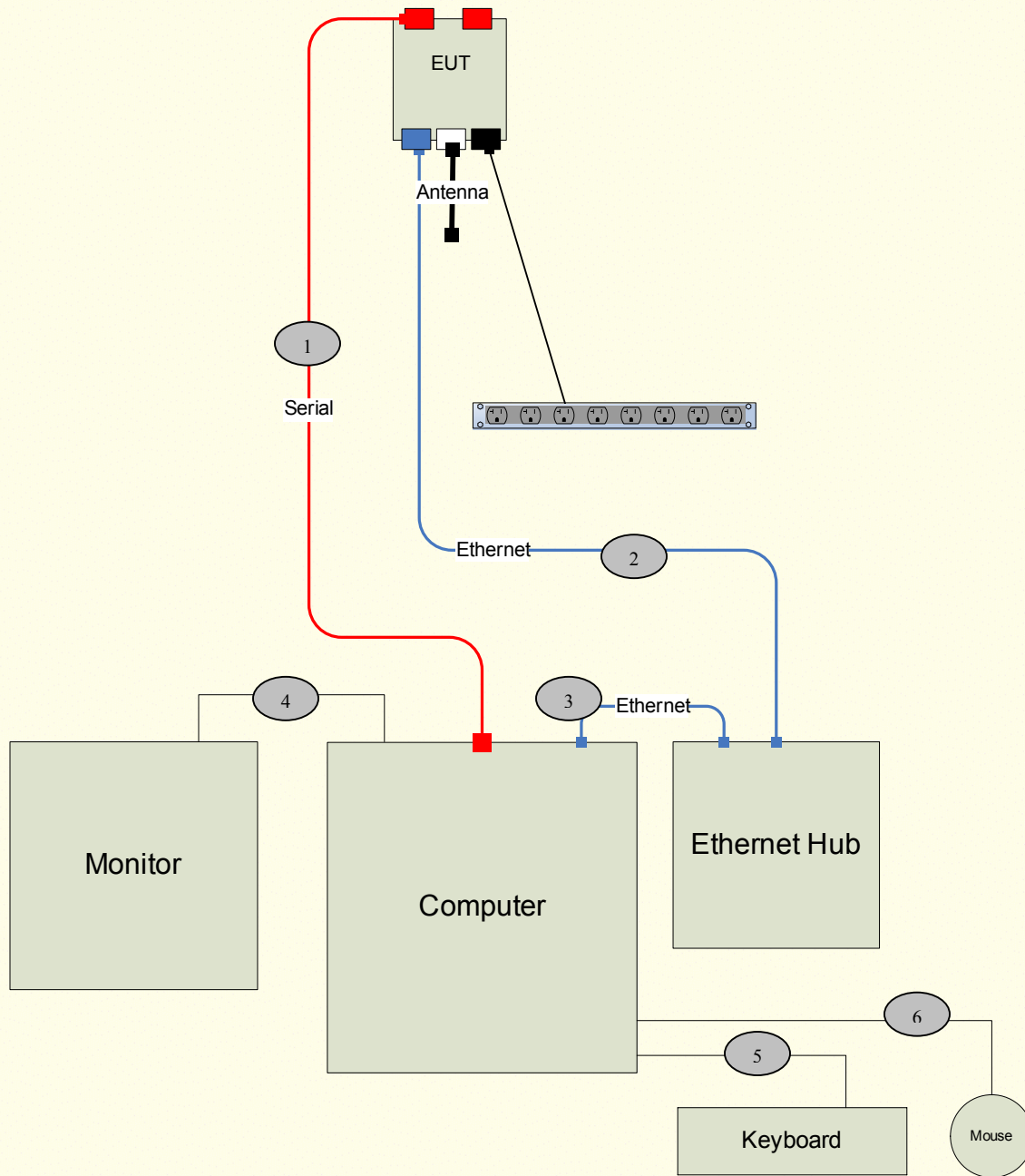

4.4 I/O Cabling Diagram and Description (continued)

Signal Line Cable Description							
Cable	Length	Construction	Source Connector	Destination Connector	Bundled Length	Ferrite Attached	Note
1	10.0m	Serial Cable	EUT's Port 1: Metallic DB-9	Host Computer: Metallic DB-9	N/A	N/A	N/A
2	10.0m	Round, Un-Shielded Twisted Pair (CAT 5)	EUT's Ethernet Port: Plastic RJ-45	Lantronix Hub: Plastic RJ-45	N/A	N/A	N/A
3	1.5m	Round, Un-Shielded Twisted Pair (CAT 5)	Lantronix Hub: Plastic RJ-45	Host Computer: Plastic RJ-45	N/A	N/A	N/A
4	1.5m	Round, Braid & Foil Shielded	Host Computer: Metallic DB-15	Monitor: Hardwired	N/A	N/A	N/A
5	1.5m	Round, Braid & Foil Shielded	Host Computer: Metallic 8-pin Mini DIN	Keyboard: Hardwired	N/A	N/A	N/A
6	1.5m	Round, Braid & Foil Shielded	Host Computer: Metallic 8-pin Mini DIN	Mouse: Hardwired	N/A	N/A	N/A



4.5 EMC Test Hardware and Software Measurement Equipment

TEST EQUIPMENT LIST - Emissions					
Equipment Name	Manufacturer	Model Number	Serial Number	Calibration Due Date	Maintenance Calibration Cycle
EMI Receiver - RF Section	Hewlett Packard	85462A	3737A00407	09/02/06	1 Year
EMI Receiver - RF Filter Section	Hewlett Packard	85460A	3704A00399	09/02/06	1 Year
10dB Attenuator	Radiall	R412710000	Lot:9624	07/09/06	1 Year
EUT LISN	Solar	9252-50-R-24-BNC	961025	03/30/08	2 Years
Accessory LISN	Solar	9252-50-R-24-BNC	961024	07/05/07	2 Years
Antenna - Biconical	EMCO	3110	9108-1421	11/17/06	1.5 Year
Antenna - Log Periodic	ETS	3148	4947	11/11/06	1.5 Year
Spectrum Analyzer	Agilent	8564EC	4046A00387	08/15/06	1 Year
Antenna - Horn	ETS	3117	57423	12/21/06	1 Year
Preamp	Miteq	JS42-01001800-25-10P	815980	07/21/06	1 Year
Cable	Semflex	X118BFSX10216	406	11/04/06	1 Year
2.4 GHz Notch Filter	Micro-Tronics	BRM50702-02	003	10/21/06	1.5 Year
Antenna - 18-26.5 GHz Pre-amplified Horn	Aegis Labs, Inc.	H042	SLK-35-3W	02/08/07	1 Year
Power Meter	Anritsu	ML2487A	6K00001785	05/30/07	1 Year
Wide Bandwidth Sensor	Anritsu	MA2491A	31193	05/30/07	1 Year
12dB Attenuator	Narda	4779-12	203	07/09/06	1 Year
Temperature/Humidity Monitor	Dickson	TH550	7255185	03/24/07	1 Year

5.0 CONDITIONS DURING EMISSIONS MEASUREMENTS

5.1 General

All measurements were made according to the procedures defined in or referred to by the standard listed on the cover page of this report. The measurements were made in the operating mode producing the largest emissions consistent with normal operation and connected to the minimum configuration of auxiliary devices.

5.2 Conducted Emissions Test Setup

The following was the test configuration.

EUT signal cables that hung closer than 40 cm to the horizontal metal ground plane were folded back and forth forming a bundle 30 cm to 40 cm long. The power cord of the EUT was also bundled in the center and plugged into one of the artificial mains network (AMN). All peripheral equipment was powered from a second AMN via a multiple outlet strip placed at a distance on 10cm from each other. The AMN and ISN were positioned 80cm from the EUT. Signal cables that were not connected to an AE were terminated using the correct termination. If applicable, the current probe was placed at 0.1 m from the ISN.

Peak, quasi-peak and/or average detectors were used for testing performed between 150 kHz and 30 MHz. A swept frequency scan was performed for both Line 1 and Line 2. The six highest readings were compared against the limit and recorded in the data sheet along with a snapshot image of the sweep scan. The graphical scans in Appendix A only reflect peak readings while the tabulated data sheets reflect peak, average, and/or quasi-peak measurements.

Climatic Conditions:

The EUT was tested within its intended operating and climatic conditions.

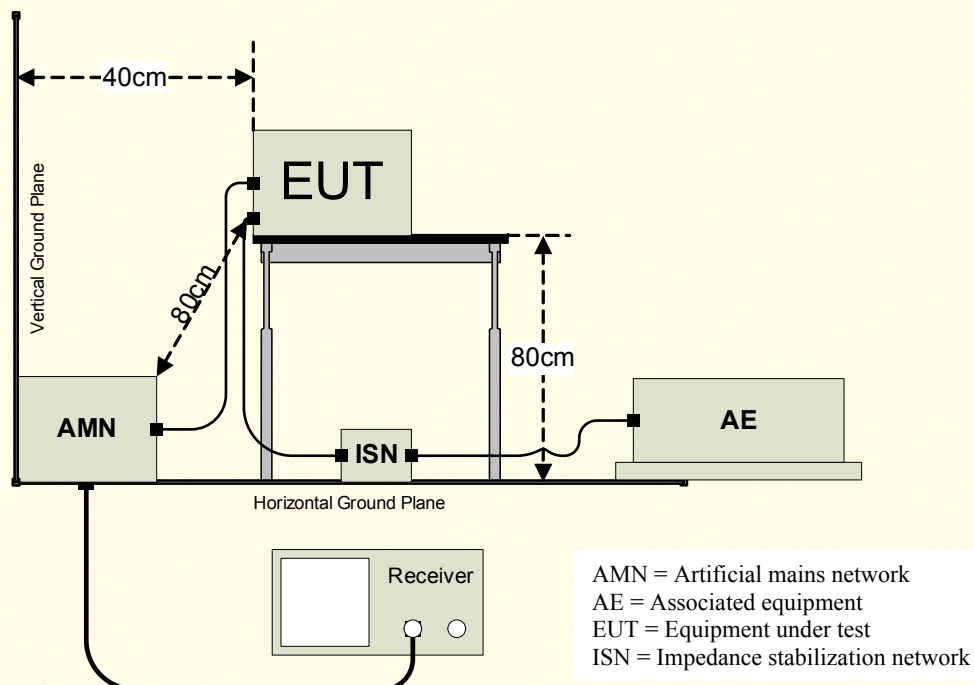

5.3 Radiated Emissions Test Setup

The Open Area Test Site (OATS) was used for radiated emission testing. The receiving (Rx) antenna(s) was placed 10m from the nearest side of the EUT facing the Rx antenna. The EUT (if floor-standing) was placed directly on the flush-mounted 360 degree rotating turntable. The EUT (if table-top) was placed directly on an 80cm high non-metallic table, and the table was placed on the rotating turntable. During the initial EMI scan, all the suspect frequencies, i.e.; harmonics, broadband signals were checked with the Rx broadband antennas in both vertical and horizontal polarities. The biconical Rx, log periodic Rx, and horn Rx antennas were used from 30MHz – 299.99MHz, 300MHz – 1000MHz, and 1GHz – 18GHz respectively.

Upon completion of all harmonic and broadband measurements, the balance of any remaining frequencies was checked between 30MHz – 18GHz. Any signals appearing within 20 dB of the classification limit was measured. Each signal was maximized by first rotating the turntable at least 360 degrees and recording the azimuth in the data sheet. Lastly, the Rx antenna was raised and/or lowered to maximize the signal elevation. If the measured signal was obtained using the peak detector and that signal appeared within 3 dB of the regulatory limit line, then the same signal was re-measured using the quasi-peak detector on the EMI receiver. Both meter readings if necessary were recorded on the data sheet.

Climatic Conditions:

The EUT was tested within its intended operating and climatic conditions.

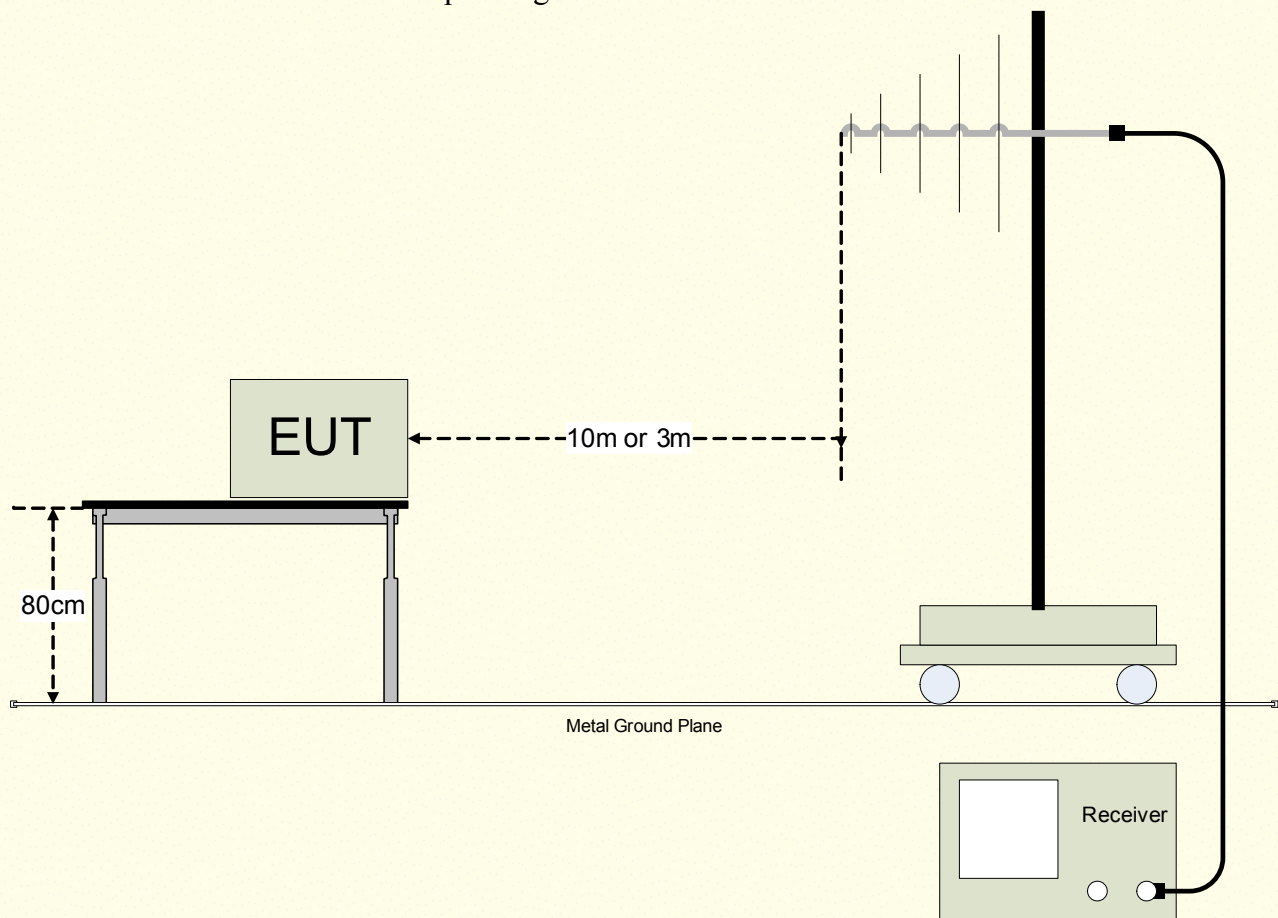



APPENDIX A

TEST DATA



AC POWER PORT - CONDUCTED EMISSIONS TEST RESULTS

CLIENT:	Lantronix Inc.	DATE:	05/03/06
EUT:	Wireless Embedded Device Server	PROJECT NUMBER:	LANTR-060321
MODEL NUMBER:	WiPort	TEST ENGINEER:	BM
SERIAL NUMBER:	00-20-4A-89-46-88	SITE #:	1
CONFIGURATION:	Tested with a Group West, CUI, & Hon-Kwang power adapter	TEMPERATURE:	21 deg. C
		HUMIDITY:	56%
		TIME:	2:45 PM

Description:	Conducted Power RF Emissions (150 kHz – 30 MHz)
Results:	PASSED LINE 1 and LINE 2 Limits
Note:	Conducted Emissions Measurements were performed on the EUT with power supplies set at the following voltage and frequency. <ul style="list-style-type: none">• 120VAC / 60 Hz.

Conducted Limits		
Frequency (MHz)	Quasi-Peak Limit (dBuV)	Average Limit (dBuV)
0.15-0.5	66 to 56*	56 to 46*
0.5-5	56	46
5-30	60	50

AC Power Port – Conducted Emissions Test Results (Continued)

Group West Power Adapter @ 120VAC/60Hz (LANTR-060321-06)

FCC Part 15 CLASS B CONDUCTED EMISSIONS – LINE 1

Freq. (MHz)	Meter Reading (dBuV)	Detector (PK/QP/AV)	Average Limit (dBuV)	Average Delta(dB)	Quasi-Peak Limit (dBuV)	Quasi-Peak Delta(dB)
0.1700	55.96	PK	55.43	0.53	65.43	-9.47
0.1700	43.48	AV	55.43	-11.95	65.43	-21.95
0.3500	46.42	PK	50.28	-3.86	60.28	-13.86
1.0600	45.67	PK	46.00	-0.33	56.00	-10.33
1.0600	22.22	AV	46.00	-23.78	56.00	-33.78
1.5700	44.83	PK	46.00	-1.17	56.00	-11.17
1.5700	32.33	AV	46.00	-13.67	56.00	-23.67
1.7700	45.78	PK	46.00	-0.22	56.00	-10.22
1.7700	12.91	AV	46.00	-33.09	56.00	-43.09
2.2900	44.51	PK	46.00	-1.49	56.00	-11.49
2.2900	11.73	AV	46.00	-34.27	56.00	-44.27

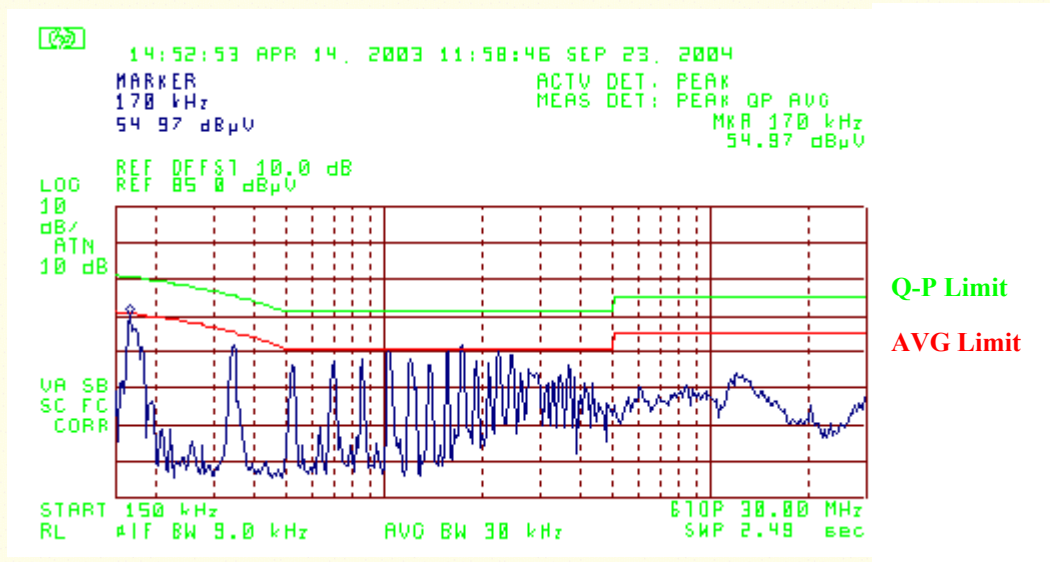

AC Power Port – Conducted Emissions Test Results (Continued)

Group West Power Adapter @ 120VAC/60Hz (LANTR-060321-06)

FCC Part 15 CLASS B CONDUCTED EMISSIONS – LINE 2

Freq. (MHz)	Meter Reading (dBuV)	Detector (PK/QP/AV)	Average Limit (dBuV)	Average Delta(dB)	Quasi-Peak Limit (dBuV)	Quasi-Peak Delta(dB)
0.1700	50.91	PK	55.43	-4.52	65.43	-14.52
0.3400	45.01	PK	50.57	-5.56	60.57	-15.56
0.8600	43.78	PK	46.00	-2.22	56.00	-12.22
0.8600	35.81	AV	46.00	-10.19	56.00	-20.19
1.0300	45.21	PK	46.00	-0.79	56.00	-10.79
1.0300	32.80	AV	46.00	-13.20	56.00	-23.20
1.5500	43.96	PK	46.00	-2.04	56.00	-12.04
1.5500	33.75	AV	46.00	-12.25	56.00	-22.25
1.7200	43.87	PK	46.00	-2.13	56.00	-12.13
1.7200	31.21	AV	46.00	-14.79	56.00	-24.79

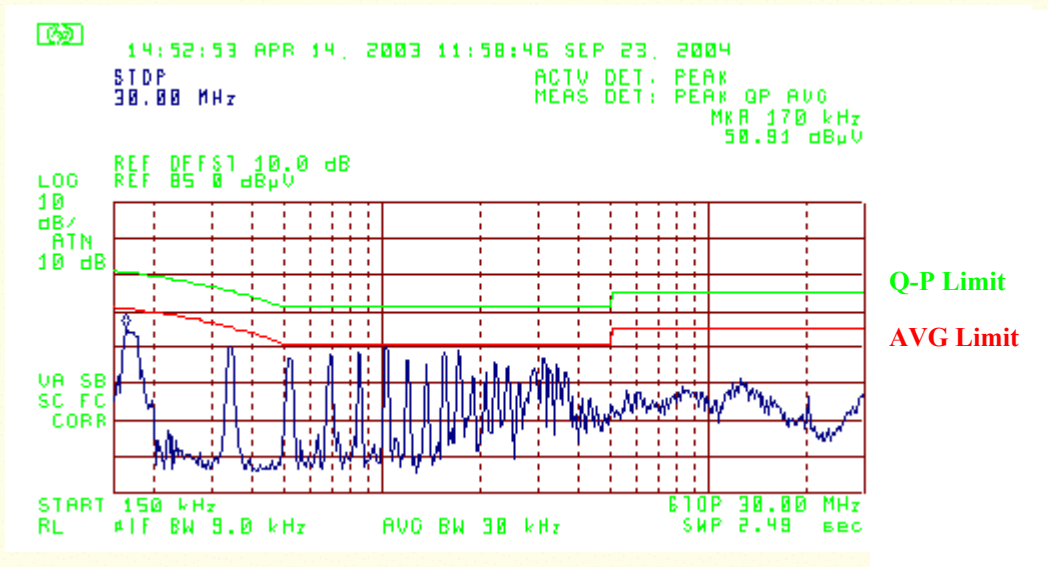

AC Power Port – Conducted Emissions Test Results (Continued)

CUI Power Adapter @ 120VAC/60Hz (LANTR-060321-07)

FCC Part 15 CLASS B CONDUCTED EMISSIONS – LINE 1

Freq. (MHz)	Meter Reading (dBuV)	Detector (PK/QP/AV)	Average Limit (dBuV)	Average Delta(dB)	Quasi-Peak Limit (dBuV)	Quasi-Peak Delta(dB)
0.1700	44.84	PK	55.43	-10.59	65.43	-20.59
0.1800	40.65	PK	55.14	-14.49	65.14	-24.49
0.1900	38.13	PK	54.86	-16.73	64.86	-26.73
0.2100	37.21	PK	54.29	-17.08	64.29	-27.08
0.2200	36.74	PK	54.00	-17.26	64.00	-27.26
11.9300	36.90	PK	50.00	-13.10	60.00	-23.10

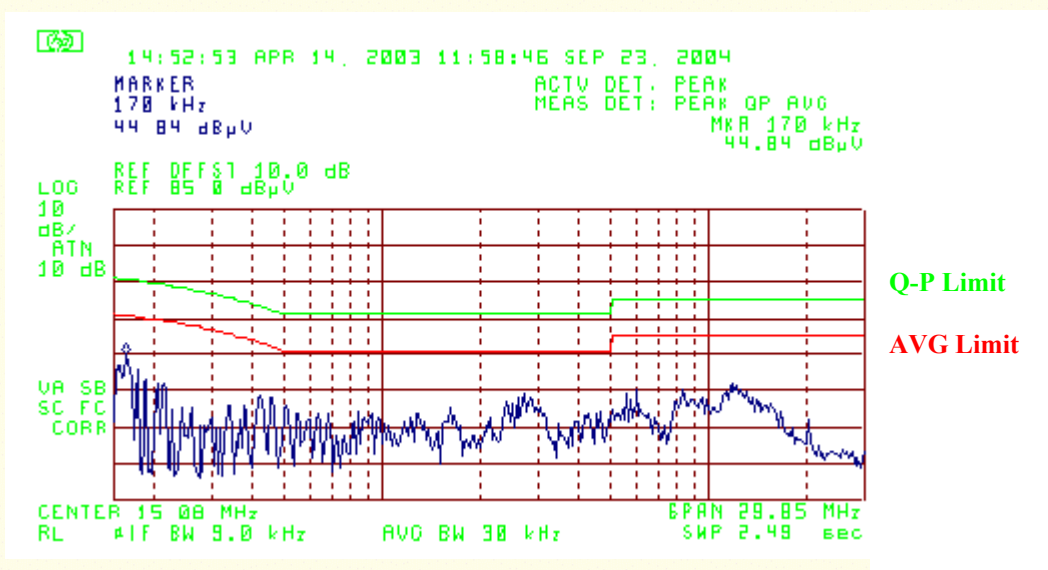

AC Power Port – Conducted Emissions Test Results (Continued)

CUI Power Adapter @ 120VAC/60Hz (LANTR-060321-07)

FCC Part 15 CLASS B CONDUCTED EMISSIONS - LINE 2

Freq. (MHz)	Meter Reading (dBuV)	Detector (PK/QP/AV)	Average Limit (dBuV)	Average Delta(dB)	Quasi-Peak Limit (dBuV)	Quasi-Peak Delta(dB)
0.1600	41.32	PK	55.71	-14.39	65.71	-24.39
0.1700	42.97	PK	55.43	-12.46	65.43	-22.46
0.1800	38.63	PK	55.14	-16.51	65.14	-26.51
0.2000	34.28	PK	54.57	-20.29	64.57	-30.29
0.2100	34.74	PK	54.29	-19.55	64.29	-29.55
12.6400	34.92	PK	50.00	-15.08	60.00	-25.08

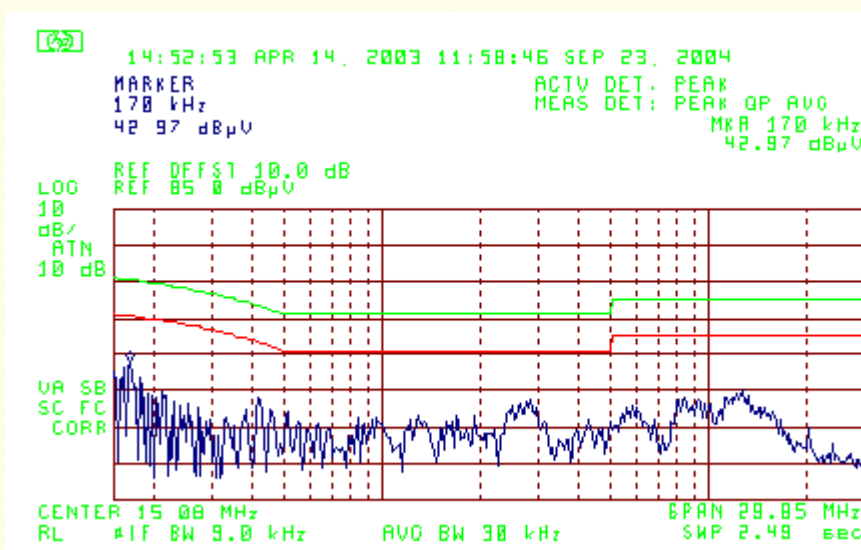

Q-P Limit
AVG Limit

AC Power Port – Conducted Emissions Test Results (Continued)

Hon-Kwang Power Adapter @ 120VAC/60Hz (LANTR-060321-08)

FCC Part 15 CLASS B CONDUCTED EMISSIONS – LINE 1

Freq. (MHz)	Meter Reading (dBuV)	Detector (PK/QP/AV)	Average Limit (dBuV)	Average Delta(dB)	Quasi-Peak Limit (dBuV)	Quasi-Peak Delta(dB)
0.1500	49.49	PK	56.00	-6.51	66.00	-16.51
0.1600	49.26	PK	55.71	-6.45	65.71	-16.45
0.1700	48.95	PK	55.43	-6.48	65.43	-16.48
0.1700	48.94	PK	55.43	-6.49	65.43	-16.49
0.1800	48.80	PK	55.14	-6.34	65.14	-16.34
0.1900	48.61	PK	54.86	-6.25	64.86	-16.25

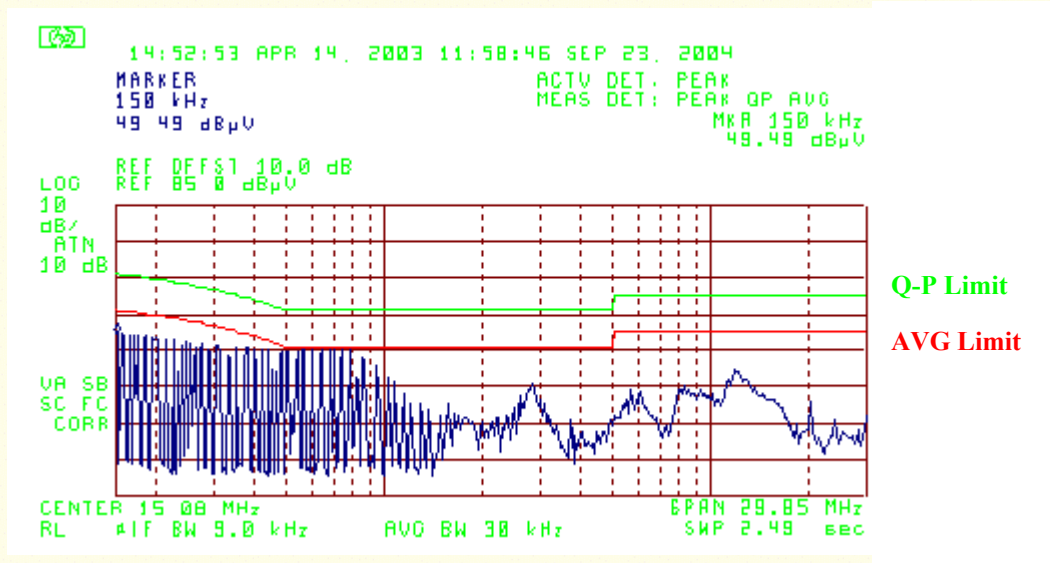

AC Power Port – Conducted Emissions Test Results (Continued)

Hon-Kwang Power Adapter @ 120VAC/60Hz (LANTR-060321-08)

FCC Part 15 CLASS B CONDUCTED EMISSIONS – LINE 2

Freq. (MHz)	Meter Reading (dBuV)	Detector (PK/QP/AV)	Average Limit (dBuV)	Average Delta(dB)	Quasi-Peak Limit (dBuV)	Quasi-Peak Delta(dB)
0.1600	52.08	PK	55.71	-3.63	65.71	-13.63
0.1600	51.89	PK	55.71	-3.82	65.71	-13.82
0.1700	49.91	PK	55.43	-5.52	65.43	-15.52
0.1800	51.52	PK	55.14	-3.62	65.14	-13.62
0.1800	51.35	PK	55.14	-3.79	65.14	-13.79
0.2100	50.35	PK	54.29	-3.94	64.29	-13.94

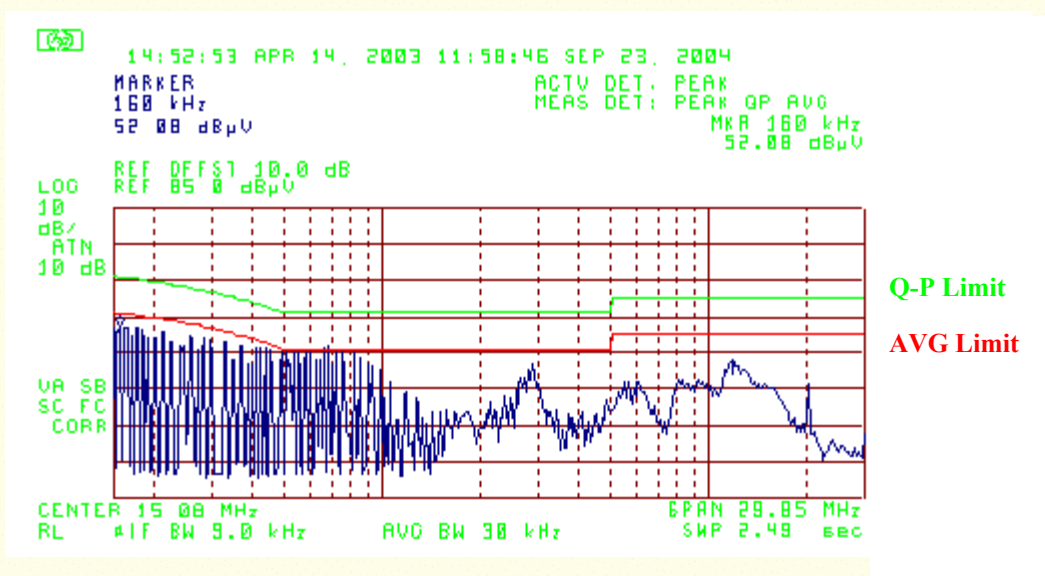



RADIATED EMISSIONS TEST RESULTS

CLIENT:	Lantronix Inc.	DATE:	06/05/06
EUT:	Wireless Embedded Device Server	PROJECT NUMBER:	LANTR-060321
MODEL NUMBER:	WiPort	TEST ENGINEER:	JC
SERIAL NUMBER:	00-20-4A-89-46-88	SITE #:	2
CONFIGURATION:	Tested with a US Robotics 5 dBi antenna & a Group West power adapter	TEMPERATURE:	27 deg. C
		HUMIDITY:	49% RH
		TIME:	3:45 PM

Description:	Radiated RF Emissions (30 MHz – 1000 MHz)
Results:	PASSED Horizontal and Vertical Antenna Polarizations Class B Limits
Note:	During preliminary scans, there wasn't any difference which channel or data rate was used with the EUT; therefore only 802.11g mode at Channel 1 with a data rate of 6 Mbps was used for final testing. Also, the scan was only done with the US Robotics antenna.

Radiated Limits	
Frequency (MHz)	Quasi-Peak Limit (dBuV)
30-88	40
88-216	43.52
216-960	46.02
960-1000	54

Radiated Emissions Sample Calculations

$$\text{Corrected Meter Reading} = \text{Meter Reading} + F + C - D$$

Where, F = Antenna Factor

C = Cable Factor

G = Amplifier Gain

D = Distance Factor (if applicable)

Therefore, the equation for determining the Corrected Meter Reading Limit (CML) is:

$$\text{CML} = \text{Specification Limit} - F - C + D$$

Radiated Emissions Test Results (Continued)

US Robotics Antenna with Group West Power Adapter @ 120VAC/60Hz (LANTR-060321-22)

RADIATED EMISSIONS - Horizontal Antenna Polarization											
<i>Freq. (MHz)</i>	<i>Meter Reading (dBuV)</i>	<i>Antenna Height (cm)</i>	<i>Azimuth (degrees)</i>	<i>Quasi pk or AVG (dBuV)</i>		<i>Cable Factor (dB)</i>	<i>Ant. Factor (dB)</i>	<i>10 Meter Distance Factor (dB)</i>	<i>Corrected Reading (dBuV)</i>	<i>Limits (dBuV)</i>	<i>Diff (dB) +=FAIL</i>
49.86	7.98	400	225			1.20	11.85	10.46	31.49	40.00	-8.51
191.99	10.10	400	45	7.82	Q	2.18	16.74	10.46	39.48	43.50	-4.02
240.00	7.86	350	135			2.69	17.42	10.46	38.43	46.00	-7.57
249.99	9.13	350	315			2.78	17.50	10.46	30.74	46.00	-15.26
373.27	5.67	300	315			3.44	14.81	10.46	34.39	46.00	-11.61
375.06	6.77	300	315			3.45	14.80	10.46	35.48	46.00	-10.52
385.03	7.43	300	0			3.49	14.84	10.46	36.22	46.00	-9.78
480.01	5.17	250	90			3.96	18.14	10.46	37.73	46.00	-8.27
625.00	5.20	175	225			4.44	18.30	10.46	38.40	46.00	-7.60

RADIATED EMISSIONS - Vertical Antenna Polarization											
<i>Freq. (MHz)</i>	<i>Meter Reading (dBuV)</i>	<i>Antenna Height (cm)</i>	<i>Azimuth (degrees)</i>	<i>Quasi pk or AVG (dBuV)</i>		<i>Cable Factor (dB)</i>	<i>Ant. Factor (dB)</i>	<i>10 Meter Distance Factor (dB)</i>	<i>Corrected Reading (dBuV)</i>	<i>Limits (dBuV)</i>	<i>Diff (dB) +=FAIL</i>
49.85	11.16	100	315			1.20	10.55	10.46	33.37	40.00	-6.63
126.01	6.60	100	270			1.88	12.88	10.46	31.82	43.50	-11.68
192.00	11.40	100	315	9.66	Q	2.18	17.90	10.46	40.20	43.50	-3.30
240.00	13.33	100	135	9.15	Q	2.69	18.10	10.46	44.58	46.00	-1.42
250.01	7.31	100	0			2.78	18.50	10.46	39.05	46.00	-6.95
373.19	8.41	100	180			3.44	16.03	10.46	38.34	46.00	-7.66
375.02	10.00	100	315			3.45	16.10	10.46	40.01	46.00	-5.99
385.00	11.37	100	270			3.49	15.82	10.46	41.14	46.00	-4.86
480.02	6.96	100	315			3.96	17.44	10.46	38.82	46.00	-7.18
624.99	5.44	100	0			4.44	19.60	10.46	39.94	46.00	-6.06

NOTE: The measurements were taken at 10 meters and extrapolated to 3 meters.



RADIATED EMISSIONS TEST RESULTS

CLIENT:	Lantronix Inc.	DATE:	06/02/06
EUT:	Wireless Embedded Device Server	PROJECT NUMBER:	LANTR-060321
MODEL NUMBER:	WiPort	TEST ENGINEER:	JC
SERIAL NUMBER:	00-20-4A-89-46-88	SITE #:	2
CONFIGURATION:	Tested with a US Robotics 5 dBi antenna & a Group West power adapter	TEMPERATURE:	35 deg. C
		HUMIDITY:	29% RH
		TIME:	2:20 PM

Description:	Radiated RF Emissions (1 GHz – 18 GHz)
Results:	PASSED Horizontal and Vertical Antenna Polarizations Class B Limits
Note:	Radiated Emissions Measurements were performed on the EUT with power supply set at the following voltage and frequency. <ul style="list-style-type: none"> • 120VAC / 60 Hz.

Unwanted Spurious Emissions Limits			
Frequency (MHz)	Field Strength (uV/m)	Field Strength (dBuV/m) (Emissions in the restricted bands)	Field Strength (dBm/MHz) (Emissions outside the restricted bands)
Above 960	500	54.00 (Average) 74.00 (Peak)	< -20 dBc

Radiated Emissions Sample Calculations

$$\text{Corrected Meter Reading} = \text{Meter Reading} + F + C - D$$

Where, F = Antenna Factor

C = Cable Factor

G = Amplifier Gain

D = Distance Factor (if applicable)

Therefore, the equation for determining the Corrected Meter Reading Limit (CML) is:

$$\text{CML} = \text{Specification Limit} - F - C + D$$

Radiated Emissions Test Results (Continued)

*Fundamental Measurements in 802.11g mode (2400-2483.5 MHz)
 Channels 1, 6, 10, & 11
 Continuous TX at MAIN Antenna port with US Robotics Antenna
 Aegis Labs, Inc. File #: LANTR-060321-19*

RADIATED EMISSIONS - Horizontal Antenna Polarization											
Freq. (MHz)	Meter Reading (dBuV)	Antenna Height (cm)	Azimuth (degrees)	Quasi pk or AVG (dBuV)		Cable Factor (dB)	Ant. Factor (dB)	Corrected Reading (dBuV)	Limits (dBuV)	Diff (dB) +=FAIL	Comments
2412.00	58.83	100	135			3.19	32.60	94.62			Ch. 1
2412.00				50.43	A	3.19	32.60	86.22			
2437.00	59.67	100	135			3.20	32.60	95.47			Ch. 6
2437.00				51.12	A	3.20	32.60	86.92			
2457.00	60.17	100	45			3.22	32.60	95.99			Ch. 10
2457.00				51.51	A	3.22	32.60	87.33			
2462.00	58.83	125	45			3.22	32.60	94.65			Ch. 11
2462.00				50.06	A	3.22	32.60	85.88			

RADIATED EMISSIONS – Vertical Antenna Polarization											
Freq. (MHz)	Meter Reading (dBuV)	Antenna Height (cm)	Azimuth (degrees)	Quasi pk or AVG (dBuV)		Cable Factor (dB)	Ant. Factor (dB)	Corrected Reading (dBuV)	Limits (dBuV)	Diff (dB) +=FAIL	Comments
2412.00	73.67	100	135			3.19	32.46	109.32			Ch. 1
2412.00				65.30	A	3.19	32.46	100.95			
2437.00	75.00	100	135			3.20	32.47	110.68			Ch. 6
2437.00				66.54	A	3.20	32.47	102.22			
2457.00	74.33	100	225			3.22	32.48	110.03			Ch. 10
2457.00				65.69	A	3.22	32.48	101.39			
2462.00	73.17	100	225			3.22	32.48	108.88			Ch. 11
2462.00				64.13	A	3.22	32.48	99.84			

NOTE: Fundamental signals measured to calculate the band edge field strengths using the “Marker Delta Method”.



Radiated Emissions Test Results (Continued)

*Band Edge Field Strength Measurements in 802.11g mode (2400-2483.5 MHz)
 Channels 1, 10, & 11
 Continuous TX at MAIN Antenna port with US Robotics Antenna
 Aegis Labs, Inc. File #: LANTR-060321-19*

RADIATED EMISSIONS - Horizontal Antenna Polarization										
Freq. (MHz)	Meter Reading (dBuV)	Antenna Height (cm)	Azimuth (degrees)	Quasi pk or AVG (dBuV)	Cable Factor (dB)	Ant. Factor (dB)	Corrected Reading (dBuV)	Limits (dBuV)	Diff (dB) +=FAIL	Comments
2390.00							53.79	74.00	-20.21	Ch. 1
2390.00				A			39.05	54.00	-14.95	
2400.00	35.83	100	135		3.18	32.60	71.61	74.62	-3.01	
2483.50							50.99	74.00	-23.01	Ch. 10
2483.50				A			39.33	54.00	-14.67	
2483.50							48.99	74.00	-25.01	Ch. 11
2483.50				A			36.22	54.00	-17.78	

RADIATED EMISSIONS – Vertical Antenna Polarization										
Freq. (MHz)	Meter Reading (dBuV)	Antenna Height (cm)	Azimuth (degrees)	Quasi pk or AVG (dBuV)	Cable Factor (dB)	Ant. Factor (dB)	Corrected Reading (dBuV)	Limits (dBuV)	Diff (dB) +=FAIL	Comments
2390.00							68.49	74.00	-5.51	Ch. 1
2390.00				A			53.78	54.00	-0.22	
2400.00	49.83	100	135		3.18	32.46	85.47	89.32	-3.85	
2483.50							65.03	74.00	-8.97	Ch. 10
2483.50				A			53.39	54.00	-0.61	
2483.50							63.22	74.00	-10.78	Ch. 11
2483.50				A			50.18	54.00	-3.82	

NOTE: The “Band Edge Field Strength” was calculated using the “Fundamental” and “Conducted Band Edge” measurements per the “Marker-Delta Method” with the following formula:

$$BE = F_m - \Delta_m$$

Where





BE = Band Edge Field Strength

F_m = Measured Fundamental (Peak or Average)

Δ_m = Measured Conducted Band Edge Delta (Peak or Average)

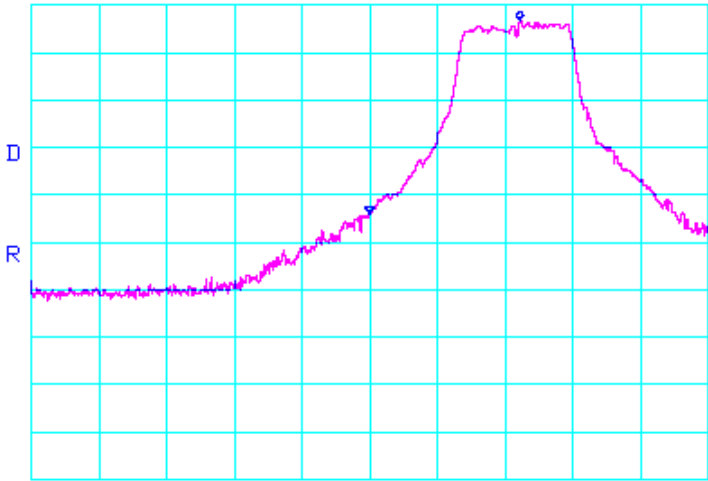
Radiated Emissions Test Results (Continued)

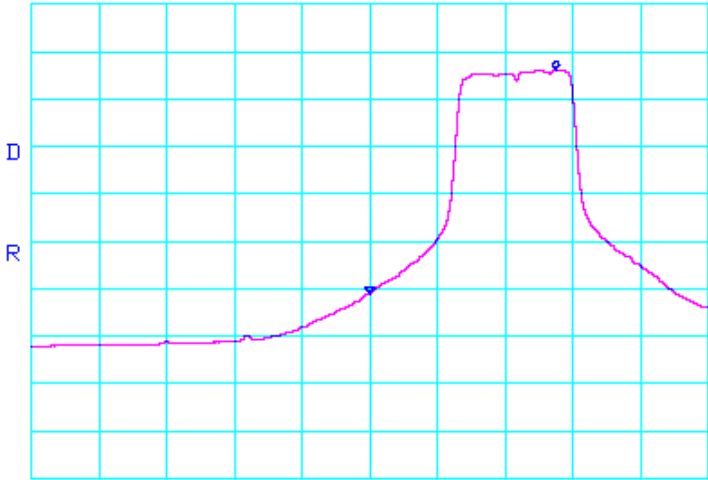
Plots Showing Out-Of-Band Emissions (Peak RBW=VBW=1MHz; Average RBW = 1MHz, VBW = 10Hz)

Test Date	Data	Test Eng.
05/23/06	2.412 GHz band edge PEAK DELTA (LANTR-060321-11a01)	JC
<div style="display: flex; justify-content: space-between;"> <div style="width: 60%;"> <p>*ATTEN 20dB RL 16.0dBm</p> <p>10dB/</p> <p>ΔMKR 40.83dB 22.2MHz</p>  <p>CENTER 2.3900GHz SPAN 100.0MHz *RBW 1.0MHz *VBW 1.0MHz SWP 50.0ms</p> </div> <div style="width: 35%; text-align: center;">  </div> </div>		
Test Date	Data	Test Eng.
05/23/06	2.412 GHz band edge AVERAGE DELTA (LANTR-060321-11a02)	JC
<div style="display: flex; justify-content: space-between;"> <div style="width: 60%;"> <p>*ATTEN 20dB RL 16.0dBm</p> <p>10dB/</p> <p>ΔMKR 47.17dB 27.5MHz</p>  <p>CENTER 2.3900GHz SPAN 100.0MHz *RBW 1.0MHz *VBW 10Hz SWP 37.0sec</p> </div> <div style="width: 35%; text-align: center;">  </div> </div>		

Radiated Emissions Test Results (Continued)

Plots Showing Out-Of-Band Emissions (Peak RBW=VBW=1MHz; Average RBW = 1MHz, VBW = 10Hz)

Test Date	Data	Test Eng.
06/05/06	2.457 GHz band edge PEAK DELTA (LANTR-060321-17a07)	JC
<p>*ATTEN 20dB ΔMKR 45.00dB RL 16.0dBm 10dB/ -25.2MHz</p> <p>CENTER 2.4835GHz SPAN 100.0MHz *RBW 1.0MHz *VBW 1.0MHz SWP 50.0ms</p>		
Test Date	Data	Test Eng.
06/05/06	2.457 GHz band edge AVERAGE DELTA (LANTR-060321-17a08)	JC
<p>*ATTEN 20dB ΔMKR 48.00dB RL 16.0dBm 10dB/ -23.2MHz</p> <p>CENTER 2.4835GHz SPAN 100.0MHz *RBW 1.0MHz *VBW 10Hz SWP 37.0sec</p>		



Radiated Emissions Test Results (Continued)

*Spurious Emissions Measurements in 802.11g mode (2400-2483.5 MHz)
 Channels 1, 6, & 11
 Continuous TX at MAIN Antenna port with US Robotics Antenna
 Aegis Labs, Inc. File #: LANTR-060321-20*

RADIATED EMISSIONS - Horizontal Antenna Polarization											
<i>Freq. (MHz)</i>	<i>Meter Reading (dBuV)</i>	<i>Antenna Height (cm)</i>	<i>Azimuth (degrees)</i>	<i>Quasi pk or AVG (dBuV)</i>	<i>Preamp Factor (dB)</i>	<i>Cable Factor (dB)</i>	<i>Ant. Factor (dB)</i>	<i>Corrected Reading (dBuV)</i>	<i>Limits (dBuV)</i>	<i>Diff (dB)</i>	<i>+=FAIL</i>
EUT in Continuous Transmit Mode on Channel 1 (2.412 GHz)											
1000.00	53.50	100	135			46.50	2.04	27.60	36.64	74.00	-37.36
1000.00				42.18	A	46.50	2.04	27.60	25.32	54.00	-28.68
3216.00	56.00	100	225			46.82	3.71	33.43	46.32	74.62	-28.30
4824.00	56.33	100	135			46.57	4.57	35.90	50.23	74.00	-23.77
4824.00				43.80	A	46.57	4.57	35.90	37.70	54.00	-16.30
EUT in Continuous Transmit Mode on Channel 6 (2.437 GHz)											
1000.00	53.67	100	135			46.50	2.04	27.60	36.81	74.00	-37.19
1000.00				42.32	A	46.50	2.04	27.60	25.46	54.00	-28.54
3249.32	56.83	125	225			46.82	3.72	33.45	47.18	75.47	-28.29
4873.99	57.17	100	135			46.57	4.59	35.90	51.08	74.00	-22.92
4873.99				44.36	A	46.57	4.59	35.90	38.27	54.00	-15.73
EUT in Continuous Transmit Mode on Channel 11 (2.462 GHz)											
1000.00	52.00	100	135			46.50	2.04	27.60	35.14	74.00	-38.86
1000.00				40.81	A	46.50	2.04	27.60	23.95	54.00	-30.05
3282.66	54.00	100	225			46.82	3.74	33.47	44.39	74.65	-30.26
4924.00	54.33	100	135			46.58	4.61	35.90	48.26	74.00	-25.74
4924.00				41.79	A	46.58	4.61	35.90	35.72	54.00	-18.28



Radiated Emissions Test Results (Continued)

RADIATED EMISSIONS - Vertical Antenna Polarization											
<i>Freq. (MHz)</i>	<i>Meter Reading (dBuV)</i>	<i>Antenna Height (cm)</i>	<i>Azimuth (degrees)</i>	<i>Quasi pk or AVG (dBuV)</i>	<i>Preamp Factor (dB)</i>	<i>Cable Factor (dB)</i>	<i>Ant. Factor (dB)</i>	<i>Corrected Reading (dBuV)</i>	<i>Limits (dBuV)</i>	<i>Diff (dB) +=FAIL</i>	
EUT in Continuous Transmit Mode on Channel 1 (2.412 GHz)											
1000.00	53.83	100	135			46.50	2.04	28.10	37.47	74.00	-36.53
1000.00				42.73	A	46.50	2.04	28.10	26.37	54.00	-27.63
3216.00	60.67	100	135			46.82	3.71	33.53	51.09	89.32	-38.23
4824.01	63.83	100	135			46.57	4.57	35.34	57.16	74.00	-16.84
4824.01				52.71	A	46.57	4.57	35.34	46.04	54.00	-7.96
EUT in Continuous Transmit Mode on Channel 6 (2.437 GHz)											
1000.00	54.17	100	135			46.50	2.04	28.10	37.81	74.00	-36.19
1000.00				42.90	A	46.50	2.04	28.10	26.54	54.00	-27.46
3249.32	58.33	100	135			46.82	3.72	33.55	48.78	90.68	-41.90
4873.99	64.33	100	135			46.57	4.59	35.33	57.67	74.00	-16.33
4873.99				52.06	A	46.57	4.59	35.33	45.40	54.00	-8.60
EUT in Continuous Transmit Mode on Channel 11 (2.462 GHz)											
1000.00	52.33	100	135			46.50	2.04	28.10	35.97	74.00	-38.03
1000.00				41.13	A	46.50	2.04	28.10	24.77	54.00	-29.23
3282.66	55.00	100	135			46.82	3.74	33.57	45.49	88.88	-43.39
4924.00	60.50	100	135			46.58	4.61	35.32	53.85	74.00	-20.15
4924.00				48.28	A	46.58	4.61	35.32	41.63	54.00	-12.37



Radiated Emissions Test Results (Continued)

*Spurious Emissions Measurements in 802.11g mode (2400-2483.5 MHz)
Channels 1, 6, & 11
Continuous RX at MAIN Antenna port with US Robotics Antenna
Aegis Labs, Inc. File #: LANTR-060321-20*

RADIATED EMISSIONS - Horizontal Antenna Polarization										
<i>Freq. (MHz)</i>	<i>Meter Reading (dBuV)</i>	<i>Antenna Height (cm)</i>	<i>Azimuth (degrees)</i>	<i>Quasi pk or AVG (dBuV)</i>	<i>Preamp Factor (dB)</i>	<i>Cable Factor (dB)</i>	<i>Ant. Factor (dB)</i>	<i>Corrected Reading (dBuV)</i>	<i>Limits (dBuV)</i>	<i>Diff (dB) +=FAIL</i>
No Signals Found										

RADIATED EMISSIONS - Vertical Antenna Polarization										
<i>Freq. (MHz)</i>	<i>Meter Reading (dBuV)</i>	<i>Antenna Height (cm)</i>	<i>Azimuth (degrees)</i>	<i>Quasi pk or AVG (dBuV)</i>	<i>Preamp Factor (dB)</i>	<i>Cable Factor (dB)</i>	<i>Ant. Factor (dB)</i>	<i>Corrected Reading (dBuV)</i>	<i>Limits (dBuV)</i>	<i>Diff (dB) +=FAIL</i>
No Signals Found										



PEAK TRANSMIT POWER

CLIENT:	Lantronix Inc.	DATE:	06/06/06
EUT:	Wireless Embedded Device Server	PROJECT NUMBER:	LANTR-060321
MODEL NUMBER:	WiPort	TEST ENGINEER:	JC
SERIAL NUMBER:	00-20-4A-89-46-88	SITE #:	2
CONFIGURATION:	Tested with a US Robotics 5 dBi antenna & a Group West power adapter	TEMPERATURE:	21 deg. C
		HUMIDITY:	63% RH
		TIME:	1:10 PM

Description:	The maximum peak output power of the intentional radiator shall not exceed 1 watt.
Results:	See Data Sheet
Note:	Conducted Emissions Measurements were performed on the EUT with power supply set at the following voltage and frequency. <ul style="list-style-type: none">• 120VAC / 60 Hz.

Peak Transmit Power Limits

Frequency (MHz)	Output Power (W)
2412-2462	1



Peak Transmit Power (Continued)

Mode	Channel	Frequency (MHz)	Rate (Mbps)	Average Power (dBm)	Average Power (mW)	Peak Power (dBm)	Peak Power (mW)
802.11g	1	2412	6	13.50	22.39	20.81	120.50
802.11g	1	2412	36	13.31	21.43	20.69	117.22
802.11g	1	2412	54	13.25	21.13	20.62	115.35
802.11g	6	2437	6	13.85	24.27	20.93	123.88
802.11g	6	2437	36	13.80	23.99	20.92	123.59
802.11g	6	2437	54	13.77	23.82	20.89	122.74
802.11g	10	2457	6	14.46	27.93	21.08	128.23
802.11g	10	2457	36	13.81	24.04	20.80	120.23
802.11g	10	2457	54	13.89	24.49	20.83	121.06
802.11g	11	2462	6	12.12	16.29	20.23	105.44
802.11g	11	2462	36	12.06	16.07	20.18	104.23
802.11g	11	2462	54	12.10	16.22	20.17	103.99

NOTE: The output power measurement is conducted.



6dB EMISSIONS BANDWIDTH

CLIENT:	Lantronix Inc.	DATE:	06/02/06
EUT:	Wireless Embedded Device Server	PROJECT NUMBER:	LANTR-060321
MODEL NUMBER:	WiPort	TEST ENGINEER:	JC
SERIAL NUMBER:	00-20-4A-89-46-88	SITE #:	2
CONFIGURATION:	Tested with a US Robotics 5 dBi antenna & a Group West power adapter	TEMPERATURE:	21 deg. C
		HUMIDITY:	46% RH
		TIME:	10:45 AM

Description:	The minimum 6 dB bandwidth shall be at least 500 kHz.
Results:	See Data Sheet
Note:	Conducted Emissions Measurements were performed on the EUT with power supply set at the following voltage and frequency. <ul style="list-style-type: none">• 120VAC / 60 Hz.

6 dB Emissions Bandwidth (Continued)

802.11g Mode

Test Date	Data	Test Eng.
06/02/06	2.412 GHz (LANTR-060321-17b1)	JC

*ATTEN 20dB ΔMKR .67dB
 RL 16.0dBm 10dB/ 16.50MHz

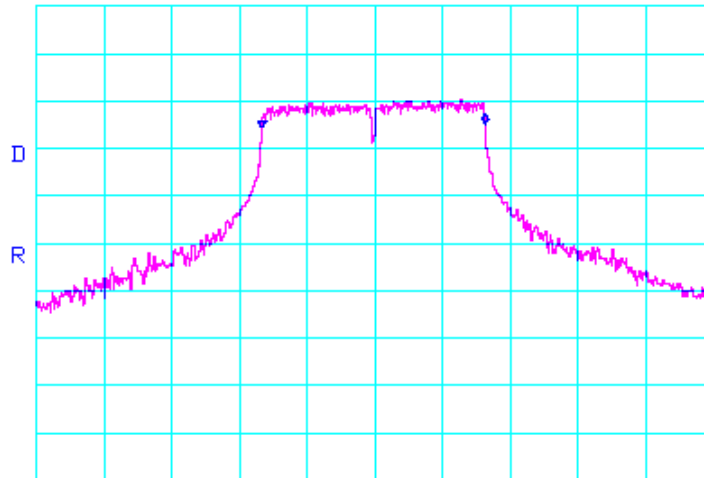

CENTER 2.41200GHz SPAN 50.00MHz
 *RBW 100kHz *VBW 300kHz SWP 50.0ms

Test Date	Data	Test Eng.
06/02/06	2.437 GHz (LANTR-060321-17b2)	JC

*ATTEN 20dB ΔMKR .67dB
 RL 16.0dBm 10dB/ 16.58MHz

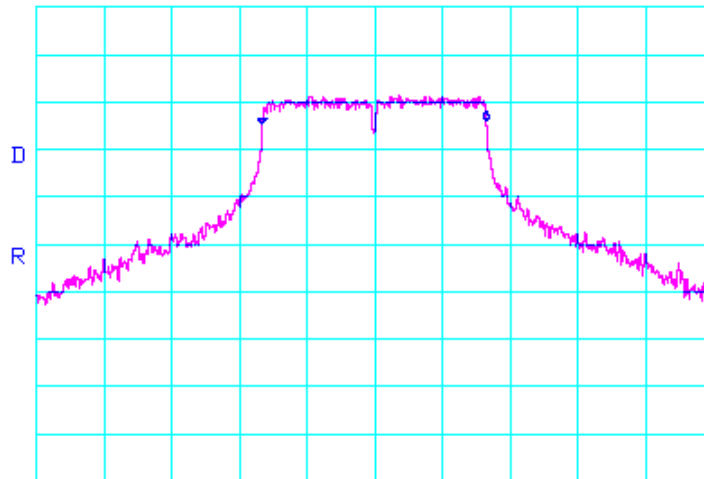

CENTER 2.43700GHz SPAN 50.00MHz
 *RBW 100kHz *VBW 300kHz SWP 50.0ms



PEAK POWER SPECTRAL DENSITY

CLIENT:	Lantronix Inc.	DATE:	06/02/06
EUT:	Wireless Embedded Device Server	PROJECT NUMBER:	LANTR-060321
MODEL NUMBER:	WiPort	TEST ENGINEER:	JC
SERIAL NUMBER:	00-20-4A-89-46-88	SITE #:	2
CONFIGURATION:	Tested with a US Robotics 5 dBi antenna & a Group West power adapter	TEMPERATURE:	21 deg. C
		HUMIDITY:	46% RH
		TIME:	10:45 AM

Description:	The peak power spectral density conducted from the intentional radiator to the antenna shall not be greater than 8 dBm in any 3 kHz band during any time interval of continuous transmission.
Results:	See Data Sheet
Note:	Conducted Emissions Measurements were performed on the EUT with power supply set at the following voltage and frequency. <ul style="list-style-type: none">• 120VAC / 60 Hz.

Peak Power Spectral Density Limits	
Frequency (MHz)	Limit (dBm)
2412-2462	8



CONDUCTED OUT OF BAND EMISSIONS

CLIENT:	Lantronix Inc.	DATE:	06/02/06
EUT:	Wireless Embedded Device Server	PROJECT NUMBER:	LANTR-060321
MODEL NUMBER:	WiPort	TEST ENGINEER:	JC
SERIAL NUMBER:	00-20-4A-89-46-88	SITE #:	2
CONFIGURATION:	Tested with a US Robotics 5 dBi antenna & a Group West power adapter	TEMPERATURE:	21 deg. C
		HUMIDITY:	46% RH
		TIME:	10:45 AM

Description:	In any 100 kHz bandwidth outside the frequency band in which the spread spectrum intentional radiator is operating, the radio frequency power that is produced by the intentional radiator shall be at least 20 dB below that in the 100 kHz bandwidth within the band that contains the highest level of the desired power.
Results:	See Data Sheet
Note:	Conducted Emissions Measurements were performed on the EUT with power supply set at the following voltage and frequency. <ul style="list-style-type: none">• 120VAC / 60 Hz.

Peak Power Spectral Density (Continued)

802.11g Mode

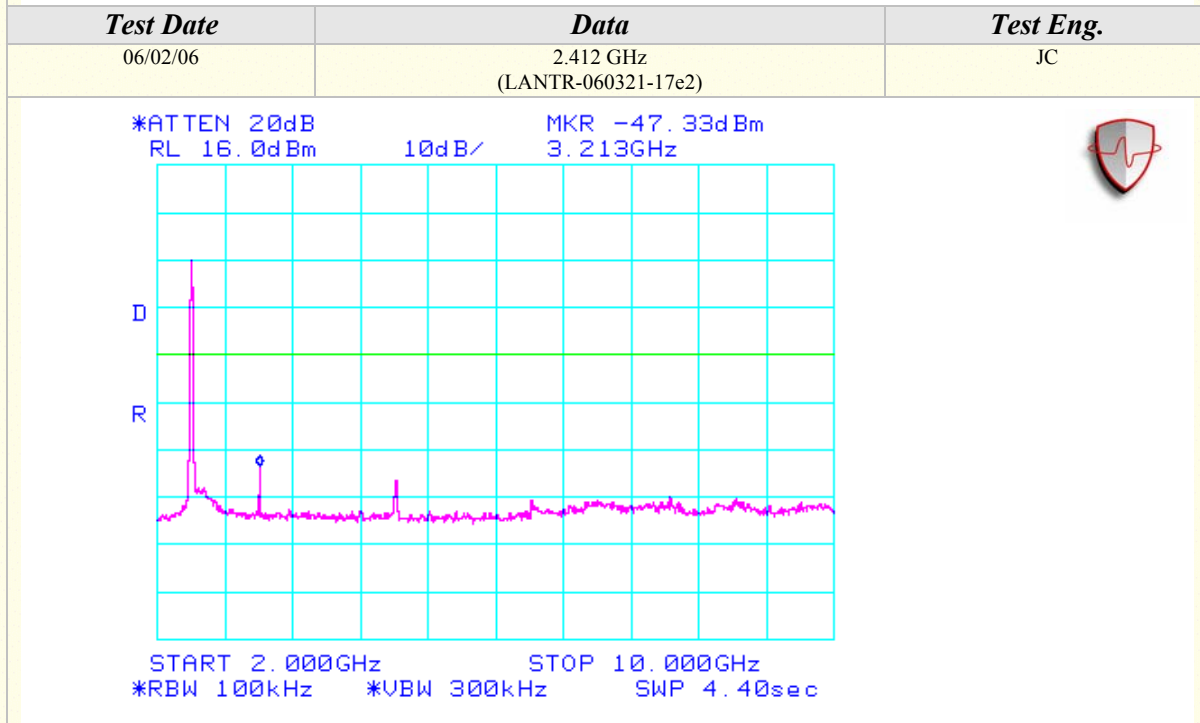
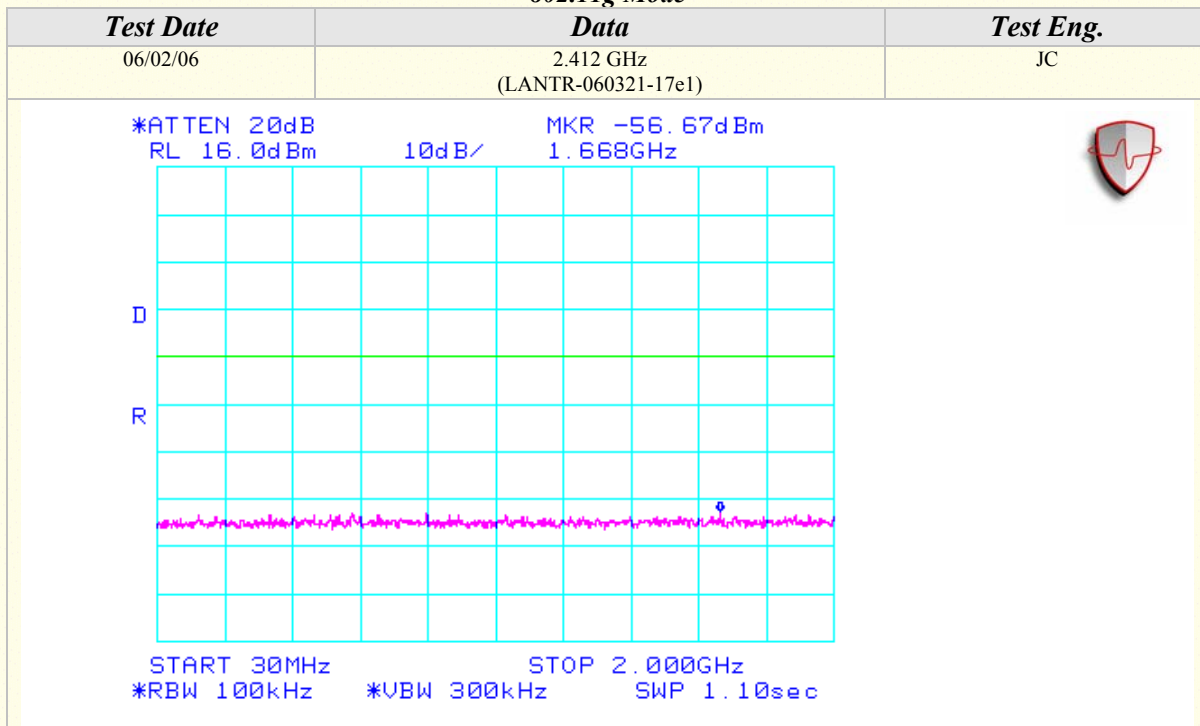



APPENDIX B

MODIFICATIONS AND RECOMMENDATIONS

1.0	NONE