

FCC Test Report (Co-Located)

Report No.: RFBHAT-WTW-P20110381-5

FCC ID: R68OQ865S

Test Model: OPEN-Q 865XR SOM

Received Date: Nov. 12, 2020

Test Date: Mar. 12, 2021

Issued Date: Mar. 15, 2021

Applicant: Lantronix

Address: 7535 Irvine Center Drive, Suite 100, Irvine, CA 92618 USA

Issued By: Bureau Veritas Consumer Products Services (H.K.) Ltd., Taoyuan Branch
Lin Kou Laboratories

Lab Address: No. 47-2, 14th Ling, Chia Pau Vil., Lin Kou Dist., New Taipei City, Taiwan

Test Location: No. 19, Hwa Ya 2nd Rd., Wen Hwa Vil., Kwei Shan Dist., Taoyuan City
33383, TAIWAN

**FCC Registration /
Designation Number:** 788550 / TW0003



This report is for your exclusive use. Any copying or replication of this report to or for any other person or entity, or use of our name or trademark, is permitted only with our prior written permission. This report sets forth our findings solely with respect to the test samples identified herein. The results set forth in this report are not indicative or representative of the quality or characteristics of the lot from which a test sample was taken or any similar or identical product unless specifically and expressly noted. Our report includes all of the tests requested by you and the results thereof based upon the information that you provided to us. You have 60 days from date of issuance of this report to notify us of any material error or omission caused by our negligence, provided, however, that such notice shall be in writing and shall specifically address the issue you wish to raise. A failure to raise such issue within the prescribed time shall constitute your unqualified acceptance of the completeness of this report, the tests conducted and the correctness of the report contents. Unless specific mention, the uncertainty of measurement has been explicitly taken into account to declare the compliance or non-compliance to the specification.

Table of Contents

Release Control Record	3
1 Certificate of Conformity	4
2 Summary of Test Results	5
2.1 Measurement Uncertainty	5
2.2 Modification Record	5
3 General Information	6
3.1 General Description of EUT	6
3.2 Description of Test Modes	9
3.2.1 Test Mode Applicability and Tested Channel Detail	12
3.3 Description of Support Units	13
3.3.1 Configuration of System under Test	13
3.4 General Description of Applied Standards	13
4 Test Types and Results	14
4.1 Radiated Emission and Bandedge Measurement	14
4.1.1 Limits of Radiated Emission and Bandedge Measurement	14
4.1.2 Test Instruments	15
4.1.3 Test Procedures	16
4.1.4 Deviation from Test Standard	16
4.1.5 Test Setup	17
4.1.6 EUT Operating Conditions	18
4.1.7 Test Results	19
Annex A - Radiated Out of Band Emission (OOBE) Measurement (For U-NII-3 band)	25
5 Pictures of Test Arrangements	26
Appendix – Information of the Testing Laboratories	27



Release Control Record

Issue No.	Description	Date Issued
RFBHAT-WTW-P20110381-5	Original release	Mar. 15, 2021

1 Certificate of Conformity

Product: Open-Q 865 SOM

Brand: Lantronix

Test Model: OPEN-Q 865XR SOM

Sample Status: Engineering sample

Applicant: Lantronix

Test Date: Mar. 12, 2021

Standards: 47 CFR FCC Part 15, Subpart C (Section 15.247)

47 CFR FCC Part 15, Subpart E (Section 15.407)

ANSI C63.10:2013

The above equipment has been tested by **Bureau Veritas Consumer Products Services (H.K.) Ltd., Taoyuan Branch**, and found compliance with the requirement of the above standards. The test record, data evaluation & Equipment Under Test (EUT) configurations represented herein are true and accurate accounts of the measurements of the sample's RF characteristics under the conditions specified in this report.

Prepared by :  , **Date:** Mar. 15, 2021
Polly Chien / Specialist

Approved by :  , **Date:** Mar. 15, 2021
Bruce Chen / Senior Project Engineer

2 Summary of Test Results

Applied Standard:	47 CFR FCC Part 15, Subpart C (Section 15.247) 47 CFR FCC Part 15, Subpart E (Section 15.407)		
FCC Clause	Test Item	Result	Remarks
15.205 / 15.209 / 15.247(d) 15.407(b) (1/2/3/4(i/ii)/6)	Radiated Emissions	Pass	Meet the requirement of limit. Minimum passing margin is -4.8dB at 714.82MHz.

Note:

1. For U-NII-3 band compliance with rule part 15.407(b)(4)(i), the OOB test plots were recorded in Annex A.
2. Determining compliance based on the results of the compliance measurement, not taking into account measurement instrumentation uncertainty.

2.1 Measurement Uncertainty

Where relevant, the following measurement uncertainty levels have been estimated for tests performed on the EUT as specified in CISPR 16-4-2:

Measurement	Frequency	Expanded Uncertainty (k=2) (±)
Radiated Emissions up to 1 GHz	9kHz ~ 30MHz	3.04 dB
	30MHz ~ 200MHz	3.59 dB
	200MHz ~ 1000MHz	3.60 dB
Radiated Emissions above 1 GHz	1GHz ~ 18GHz	2.29 dB
	18GHz ~ 40GHz	2.29 dB

2.2 Modification Record

There were no modifications required for compliance.

3 General Information

3.1 General Description of EUT

Product	Open-Q 865 SOM	
Brand	Lantronix	
Test Model	OPEN-Q 865XR SOM	
Sample Status	Engineering sample	
Power Supply Rating	12Vdc (adapter)	
Modulation Type	WLAN	CCK, DQPSK, DBPSK for DSSS 256QAM, 64QAM, 16QAM, QPSK, BPSK for OFDM 1024QAM, 256QAM, 64QAM, 16QAM, QPSK, BPSK for OFDMA
	BT EDR	GFSK, $\pi/4$ -DQPSK, 8DPSK
	Bluetooth LE	GFSK
Modulation Technology	WLAN	DSSS, OFDM, OFDMA
Transfer Rate	WLAN	802.11b: 11.0/ 5.5/ 2.0/ 1.0Mbps 802.11g: 54.0/ 48.0/ 36.0/ 24.0/ 18.0/ 12.0/ 9.0/ 6.0Mbps 802.11a: 54/48/36/24/18/12/9/6Mbps 802.11n: up to 400Mbps (For 2.4G Band) 802.11n: up to 300Mbps (For 5G Band) 802.11ac: up to 867Mbps (For 5G Band) 802.11ax: up to 574Mbps (For 2.4G Band) 802.11ax: up to 1200Mbps (For 5G Band)
	BT EDR	1/2/3 Mbps
	Bluetooth LE	Bluetooth LE 4.0: 1Mbps Bluetooth LE 5.0: 2Mbps
Operating Frequency	WLAN	2.4GHz: 2412 ~ 2462MHz 5.0GHz: 5180 ~ 5240MHz, 5260 ~ 5320MHz, 5500 ~ 5720MHz, 5745 ~ 5825MHz
	BT EDR	2402 ~ 2480 MHz
	Bluetooth LE	2402 ~ 2480MHz
Number of Channel	WLAN	2412 ~ 2462MHz: 802.11b, 802.11g, 802.11n (HT20), 802.11ac (VHT20), 802.11ax (HE20): 11 802.11n (HT40), 802.11ac (VHT40), 802.11ax (HE40): 7 5180 ~ 5240MHz: 802.11a, 802.11n (HT20), 802.11ac (VHT20), 802.11ax (HE20): 4 802.11n (HT40), 802.11ac (VHT40), 802.11ax (HE40): 2 802.11ac (VHT80), 802.11ax (HE80): 1 5260 ~ 5320MHz: 802.11a, 802.11n (HT20), 802.11ac (VHT20), 802.11ax (HE20): 4 802.11n (HT40), 802.11ac (VHT40), 802.11ax (HE40): 2 802.11ac (VHT80), 802.11ax (HE80): 1

Number of Channel	WLAN	5500 ~ 5720MHz: 802.11a, 802.11n (HT20), 802.11ac (VHT20), 802.11ax (HE20): 9 802.11n (HT40), 802.11ac (VHT40), 802.11ax (HE40): 4 802.11ac (VHT80), 802.11ax (HE80): 2 5745 ~ 5825MHz: 802.11a, 802.11n (HT20), 802.11ac (VHT20), 802.11ax (HE20): 5 802.11n (HT40), 802.11ac (VHT40), 802.11ax (HE40): 2 802.11ac (VHT80), 802.11ax (HE80): 1
	BT EDR	79
	Bluetooth LE	40
Output Power	WLAN	CDD Mode: 2412 ~ 2462MHz: 391.412mW 5180 ~ 5240MHz: 48.096mW 5260 ~ 5320MHz: 40.354mW 5500 ~ 5720MHz: 241.341mW 5745 ~ 5825MHz: 261.411mW Beamforming Mode: 2412 ~ 2462MHz: 342.004mW 5180 ~ 5240MHz: 24.110mW 5260 ~ 5320MHz: 20.201mW 5500 ~ 5720MHz: 120.957mW 5745 ~ 5825MHz: 261.411mW
	BT EDR	48.417mW
	Bluetooth LE	Bluetooth LE 4.0: 37.844mW Bluetooth LE 5.0: 41.783mW
Antenna Type	Refer to note	
Antenna Connector	Refer to note	
Accessory Device	NA	
Cable Supplied	NA	

Note:

1. The EUT incorporates a MIMO function. Physically, the EUT provides 2 completed transmitters and 2 receivers.

Band	Modulation Mode	Beamforming Mode	TX Function
2.4GHz Band	802.11b	Not Support	2TX
	802.11g	Not Support	2TX
	802.11n (HT20)	Not Support	2TX
	802.11n (HT40)	Not Support	2TX
	802.11n (VHT20)	Support	2TX
	802.11n (VHT40)	Support	2TX
	802.11ax (HE20)	Support	2TX
	802.11ax (HE40)	Support	2TX

Band	Modulation Mode	Beamforming Mode	TX Function
5GHz Band	802.11a	Not Support	2TX
	802.11n (HT20)	Not Support	2TX
	802.11n (HT40)	Not Support	2TX
	802.11ac (VHT20)	Support	2TX
	802.11ac (VHT40)	Support	2TX
	802.11ac (VHT80)	Support	2TX
	802.11ax (HE20)	Support	2TX
	802.11ax (HE40)	Support	2TX
	802.11ax (HE80)	Support	2TX

* The bandwidth and modulation are similar for HT20/HT40 on 802.11n mode and VHT20/VHT40/VHT80 on 802.11ac mode and HE20/HE40/HE80 on 802.11ax mode. Therefore the investigated worst case is the representative mode in test report. (Final test mode refer section 3.2.1)

* For 802.11n and 802.11ac, CDD mode and Beamforming mode are presented in power output test item.

2. The following antennas were provided to the EUT.

Ant. Type	Flexible Dipole Antenna	
Connector Type	U.FL	
Antenna Gain (dBi)		
Item	2.4~2.5G	4.9~5.8G
Ant 1	3.32	6.11
Ant 2	3.32	6.11

*BT is transmitted through antenna 1.

*The above Antenna information is declared by manufacturer and for more detailed features description, please refer to the manufacturer's specifications, the laboratory shall not be held responsible.

3. The EUT contains following adapter. (Support unit)

Brand	YINGHUIYUAN
Model	YHY-12003000
Input Power	100-240Vac, 50-60Hz, 1.2A
Output Power	12Vdc, 13.0A
Data Cable	1.2m shielded power cable with 1 core

4. The BT could transmit simultaneously either with WLAN 2.4GHz or 5GHz at the same time.

The WLAN 2.4GHz and 5GHz could transmit at the same time.

5. The EUT doesn't operate in 5600 ~ 5650MHz via software controls.

3.2 Description of Test Modes

WLAN

For 2.4GHz

11 channels are provided for 802.11b, 802.11g, 802.11n (HT20), 802.11n (VHT20), 802.11ax (HE20):

Channel	Frequency	Channel	Frequency
1	2412MHz	7	2442MHz
2	2417MHz	8	2447MHz
3	2422MHz	9	2452MHz
4	2427MHz	10	2457MHz
5	2432MHz	11	2462MHz
6	2437MHz		

7 channels are provided for 802.11n (HT40), 802.11n (VHT40), 802.11ax (HE40):

Channel	Frequency	Channel	Frequency
3	2422MHz	7	2442MHz
4	2427MHz	8	2447MHz
5	2432MHz	9	2452MHz
6	2437MHz		

For 5180 ~ 5240MHz:

4 channels are provided for 802.11a, 802.11n (HT20), 802.11ac (VHT20), 802.11ax (HE20):

Channel	Frequency	Channel	Frequency
36	5180 MHz	44	5220 MHz
40	5200 MHz	48	5240 MHz

2 channels are provided for 802.11n (HT40), 802.11ac (VHT40), 802.11ax (HE40):

Channel	Frequency	Channel	Frequency
38	5190 MHz	46	5230 MHz

1 channel is provided for 802.11ac (VHT80), 802.11ax (HE80):

Channel	Frequency
42	5210MHz

For 5260 ~ 5320MHz:

4 channels are provided for 802.11a, 802.11n (HT20), 802.11ac (VHT20), 802.11ax (HE20):

Channel	Frequency	Channel	Frequency
52	5260 MHz	60	5300 MHz
56	5280 MHz	64	5320 MHz

2 channels are provided for 802.11n (HT40), 802.11ac (VHT40), 802.11ax (HE40):

Channel	Frequency	Channel	Frequency
54	5270 MHz	62	5310 MHz

1 channel is provided for 802.11ac (VHT80), 802.11ax (HE80):

Channel	Frequency
58	5290MHz

For 5500 ~ 5720MHz:

9 channels are provided for 802.11a, 802.11n (HT20), 802.11ac (VHT20), 802.11ax (HE20):

Channel	Frequency	Channel	Frequency
100	5500 MHz	132	5660 MHz
104	5520 MHz	136	5680 MHz
108	5540 MHz	140	5700 MHz
112	5560 MHz	144	5720 MHz
116	5580 MHz		

4 channels are provided for 802.11n (HT40), 802.11ac (VHT40), 802.11ax (HE40):

Channel	Frequency	Channel	Frequency
102	5510 MHz	134	5670 MHz
110	5550 MHz	142	5710 MHz

2 channels are provided for 802.11ac (VHT80), 802.11ax (HE80):

Channel	Frequency	Channel	Frequency
106	5530 MHz	138	5690 MHz

For 5745 ~ 5825MHz:

5 channels are provided for 802.11a, 802.11n (HT20), 802.11ac (VHT20), 802.11ax (HE20):

Channel	Frequency	Channel	Frequency
149	5745MHz	161	5805MHz
153	5765MHz	165	5825MHz
157	5785MHz		

2 channels are provided for 802.11n (HT40), 802.11ac (VHT40), 802.11ax (HE40):

Channel	Frequency	Channel	Frequency
151	5755MHz	159	5795MHz

1 channel is provided for 802.11ac (VHT80), 802.11ax (HE80):

Channel	Frequency
155	5775MHz

BT EDR

79 channels are provided to this EUT:

Channel	Freq. (MHz)	Channel	Freq. (MHz)	Channel	Freq. (MHz)	Channel	Freq. (MHz)
0	2402	20	2422	40	2442	60	2462
1	2403	21	2423	41	2443	61	2463
2	2404	22	2424	42	2444	62	2464
3	2405	23	2425	43	2445	63	2465
4	2406	24	2426	44	2446	64	2466
5	2407	25	2427	45	2447	65	2467
6	2408	26	2428	46	2448	66	2468
7	2409	27	2429	47	2449	67	2469
8	2410	28	2430	48	2450	68	2470
9	2411	29	2431	49	2451	69	2471
10	2412	30	2432	50	2452	70	2472
11	2413	31	2433	51	2453	71	2473
12	2414	32	2434	52	2454	72	2474
13	2415	33	2435	53	2455	73	2475
14	2416	34	2436	54	2456	74	2476
15	2417	35	2437	55	2457	75	2477
16	2418	36	2438	56	2458	76	2478
17	2419	37	2439	57	2459	77	2479
18	2420	38	2440	58	2460	78	2480
19	2421	39	2441	59	2461		

BT LE

40 channels are provided to this EUT:

Channel	Freq. (MHz)	Channel	Freq. (MHz)	Channel	Freq. (MHz)	Channel	Freq. (MHz)
0	2402	10	2422	20	2442	30	2462
1	2404	11	2424	21	2444	31	2464
2	2406	12	2426	22	2446	32	2466
3	2408	13	2428	23	2448	33	2468
4	2410	14	2430	24	2450	34	2470
5	2412	15	2432	25	2452	35	2472
6	2414	16	2434	26	2454	36	2474
7	2416	17	2436	27	2456	37	2476
8	2418	18	2438	28	2458	38	2478
9	2420	19	2440	29	2460	39	2480

3.2.1 Test Mode Applicability and Tested Channel Detail

EUT Configure Mode	Applicable to		Description
	RE≥1G	RE<1G	
-	√	√	-

Where RE≥1G: Radiated Emission above 1GHz & Bandedge Measurement
 RE<1G: Radiated Emission below 1GHz
 OB: Conducted Out-Band Emission Measurement

Radiated Emission Test (Above 1GHz):

- Pre-Scan has been conducted to determine the worst-case mode from all possible combinations between available modulations, data rates and antenna ports (if EUT with antenna diversity architecture).
- Following channel(s) was (were) selected for the final test as listed below.

EUT Configure Mode	Mode	Freq. Range (MHz)	Available Channel	Tested Channel	Modulation Technology
-	802.11b + BT	2412 ~ 2462	1 to 11	6 + 39	DSSS
		BT	0 to 78		GFSK
-	BT + 802.11ax (HE40)+	BT	0 to 78	39 + 159	GFSK
		5745-5825	151 to 159		OFDMA

Radiated Emission Test (Below 1GHz):

- Pre-Scan has been conducted to determine the worst-case mode from all possible combinations between available modulations, data rates and antenna ports (if EUT with antenna diversity architecture).
- Following channel(s) was (were) selected for the final test as listed below.

EUT Configure Mode	Mode	Freq. Range (MHz)	Available Channel	Tested Channel	Modulation Technology
-	802.11b + BT	2412 ~ 2462	1 to 11	6 + 39	DSSS
		BT	0 to 78		GFSK
-	BT + 802.11ax (HE40)+	BT	0 to 78	39 + 159	GFSK
		5745-5825	151 to 159		OFDMA

Test Condition:

Applicable to	Environmental Conditions	Input Power (System)	Tested by
RE≥1G	22 deg. C, 66% RH	120Vac, 60Hz	Han Wu
RE<1G	21 deg. C, 68% RH	120Vac, 60Hz	Han Wu

3.3 Description of Support Units

The EUT has been tested as an independent unit together with other necessary accessories or support units. The following support units or accessories were used to form a representative test configuration during the tests.

ID	Product	Brand	Model No.	Serial No.	FCC ID	Remarks
A.	Notebook	Lenovo	81A4	YD02TWF5	FCC DoC Approved	-
B.	Jig	N/A	N/A	N/A	N/A	Provided by client
C.	Adapter	YINGHUIYUAN	YHY-12003000	N/A	N/A	Provided by client

Note:

1. All power cords of the above support units are non-shielded (1.8m).
2. Item A acted as a communication partner to transfer data.

ID	Cable Descriptions	Qty.	Length (m)	Shielding (Yes/No)	Cores (Qty.)	Remarks
1.	Type C USB Cable	1	1	Y	0	Provided by client
2.	Adapter Cable	1	1.2	Y	1	Provided by client
3.	Power Cable	1	1.15	N	0	Provided by client

3.3.1 Configuration of System under Test

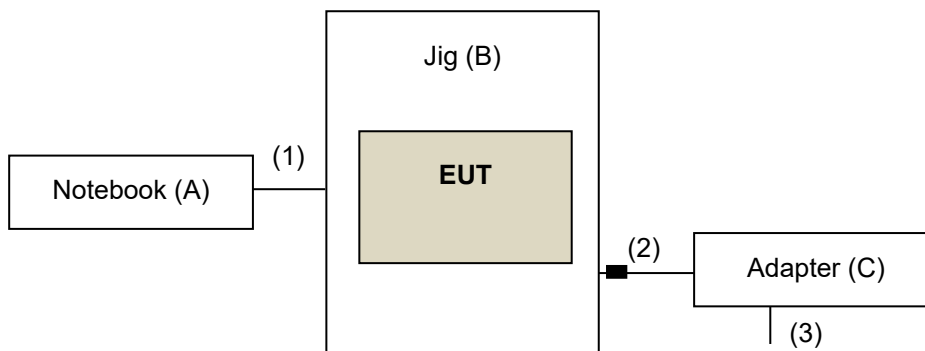

3.4 General Description of Applied Standards

The EUT is a RF Product. According to the specification of the EUT declared by the manufacturer, it must comply with the requirements of the following standards:

FCC Part 15, Subpart C (15.247)

FCC Part 15, Subpart E (15.407)

ANSI C63.10:2013

All test items have been performed and recorded as per the above standards.

4 Test Types and Results

4.1 Radiated Emission and Bandedge Measurement

4.1.1 Limits of Radiated Emission and Bandedge Measurement

Radiated emissions which fall in the restricted bands must comply with the radiated emission limits specified as below table. Other emissions shall be at least 30dB below the highest level of the desired power:

Frequencies (MHz)	Field Strength (microvolts/meter)	Measurement Distance (meters)
0.009 ~ 0.490	2400/F(kHz)	300
0.490 ~ 1.705	24000/F(kHz)	30
1.705 ~ 30.0	30	30
30 ~ 88	100	3
88 ~ 216	150	3
216 ~ 960	200	3
Above 960	500	3

Note:

1. The lower limit shall apply at the transition frequencies.
2. Emission level (dBuV/m) = 20 log Emission level (uV/m).
3. For frequencies above 1000MHz, the field strength limits are based on average detector, however, the peak field strength of any emission shall not exceed the maximum permitted average limits, specified above by more than 20dB under any condition of modulation.

Limits of unwanted emission out of the restricted bands

Applicable To		Limit	
789033 D02 General UNII Test Procedure New Rules v02r01		Field Strength at 3m	
		PK: 74 (dBµV/m)	AV: 54 (dBµV/m)
Frequency Band	Applicable To	EIRP Limit	Equivalent Field Strength at 3m
5150~5250 MHz	15.407(b)(1)	PK: -27 (dBm/MHz)	PK: 68.2(dBµV/m)
5250~5350 MHz	15.407(b)(2)		
5470~5725 MHz	15.407(b)(3)		
5725~5850 MHz	<input checked="" type="checkbox"/> 15.407(b)(4)(i)	PK: -27 (dBm/MHz) ^{*1} PK: 10 (dBm/MHz) ^{*2} PK: 15.6 (dBm/MHz) ^{*3} PK: 27 (dBm/MHz) ^{*4}	PK: 68.2(dBµV/m) ^{*1} PK: 105.2 (dBµV/m) ^{*2} PK: 110.8(dBµV/m) ^{*3} PK: 122.2 (dBµV/m) ^{*4}
	<input type="checkbox"/> 15.407(b)(4)(ii)	Emission limits in section 15.247(d)	
^{*1} beyond 75 MHz or more above of the band edge.		^{*2} below the band edge increasing linearly to 10 dBm/MHz at 25 MHz above.	
^{*3} below the band edge increasing linearly to a level of 15.6 dBm/MHz at 5 MHz above.		^{*4} from 5 MHz above or below the band edge increasing linearly to a level of 27 dBm/MHz at the band edge.	

Note: The following formula is used to convert the equipment isotropic radiated power (eirp) to field strength:

$$E = \frac{1000000\sqrt{30P}}{3} \mu\text{V/m, where P is the eirp (Watts).}$$

4.1.2 Test Instruments

Description & Manufacturer	Model No.	Serial No.	Cal. Date	Cal. Due
Test Receiver KEYSIGHT	N9038A	MY55420137	Apr. 16, 2020	Apr. 15, 2021
Spectrum Analyzer ROHDE & SCHWARZ	FSP40	100039	Jun. 12, 2020	Jun. 11, 2021
BILOG Antenna SCHWARZBECK	VULB9168	9168-160	Nov. 06, 2020	Nov. 05, 2021
HORN Antenna SCHWARZBECK	BBHA 9120 D	9120D-1169	Nov. 22, 2020	Nov. 21, 2021
HORN Antenna SCHWARZBECK	BBHA 9170	BBHA9170241	Nov. 22, 2020	Nov. 21, 2021
Loop Antenna TESEQ	HLA 6121	45745	Jul. 06, 2020	Jul. 05, 2021
Preamplifier Agilent (Below 1GHz)	8447D	2944A10638	Jun. 08, 2020	Jun. 07, 2021
Preamplifier Agilent (Above 1GHz)	8449B	3008A02367	Feb. 17, 2021	Feb. 16, 2022
RF signal cable HUBER+SUHNER&EMCI	SUCOFLEX 104 & EMC104-SM-SM8000	CABLE-CH9-02 (248780+171006)	Jan. 16, 2021	Jan. 15, 2022
RF signal cable HUBER+SUHNER	SUCOFLEX 104	CABLE-CH9- (250795/4)	Jan. 16, 2021	Jan. 15, 2022
RF signal cable Woken	8D-FB	Cable-CH9-01	Jun. 08, 2020	Jun. 07, 2021
Software BV ADT	ADT_Radiated_ V7.6.15.9.5	NA	NA	NA
Antenna Tower EMCO	2070/2080	512.835.4684	NA	NA
Turn Table EMCO	2087-2.03	NA	NA	NA
Antenna Tower & Turn BV ADT	AT100	AT93021705	NA	NA
Turn Table BV ADT	TT100	TT93021705	NA	NA
Turn Table Controller BV ADT	SC100	SC93021705	NA	NA
Boresight Antenna Fixture	FBA-01	FBA-SIP01	NA	NA
Pre-amplifier (18GHz-40GHz) EMC	EMC184045B	980175	Sep. 04, 2020	Sep. 03, 2021

Note: 1. The calibration interval of the above test instruments is 12 months and the calibrations are traceable to NML/ROC and NIST/USA.
2. The test was performed in HwaYa Chamber 9.

4.1.3 Test Procedures

For Radiated emission below 30MHz

- a. The EUT was placed on the top of a rotating table 0.8 meters above the ground at a 3 meter chamber room. The table was rotated 360 degrees to determine the position of the highest radiation.
- b. The EUT was set 3 meters away from the interference-receiving antenna, which was mounted on the top of a variable-height antenna tower.
- c. Parallel, perpendicular, and ground-parallel orientations of the antenna are set to make the measurement.
- d. For each suspected emission, the EUT was arranged to its worst case and the rotatable table was turned from 0 degrees to 360 degrees to find the maximum reading.
- e. The test-receiver system was set to Quasi-Peak Detect Function and Specified Bandwidth with Maximum Hold Mode.

Note:

1. The resolution bandwidth and video bandwidth of test receiver/spectrum analyzer is 9kHz at frequency below 30MHz.

For Radiated emission above 30MHz

- a. The EUT was placed on the top of a rotating table 0.8 meters (for 30MHz ~ 1GHz) / 1.5 meters (for above 1GHz) above the ground at 3 meter chamber room for test. The table was rotated 360 degrees to determine the position of the highest radiation.
- b. The EUT was set 3 meters away from the interference-receiving antenna, which was mounted on the top of a variable-height antenna tower.
- c. The height of antenna is varied from one meter to four meters above the ground to determine the maximum value of the field strength. Both horizontal and vertical polarizations of the antenna are set to make the measurement.
- d. For each suspected emission, the EUT was arranged to its worst case and then the antenna was tuned to heights from 1 meter to 4 meters and the rotatable table was turned from 0 degrees to 360 degrees to find the maximum reading.
- e. The test-receiver system was set to quasi-peak detect function and specified bandwidth with maximum hold mode when the test frequency is below 1 GHz.
- f. The test-receiver system was set to peak and average detect function and specified bandwidth with maximum hold mode when the test frequency is above 1 GHz. If the peak reading value also meets average limit, measurement with the average detector is unnecessary.

Note:

1. The resolution bandwidth and video bandwidth of test receiver/spectrum analyzer is 120kHz for Quasi-peak detection (QP) at frequency below 1GHz.
2. The resolution bandwidth of test receiver/spectrum analyzer is 1 MHz and the video bandwidth is 3 MHz for Peak detection (PK) at frequency above 1GHz.
3. The resolution bandwidth of test receiver/spectrum analyzer is 1MHz and the video bandwidth is $\geq 1/T$ (Duty cycle < 98%) or 10Hz (Duty cycle $\geq 98\%$) for Average detection (AV) at frequency above 1GHz.
4. All modes of operation were investigated and the worst-case emissions are reported.

4.1.4 Deviation from Test Standard

No deviation.

4.1.5 Test Setup

For Radiated emission below 30MHz

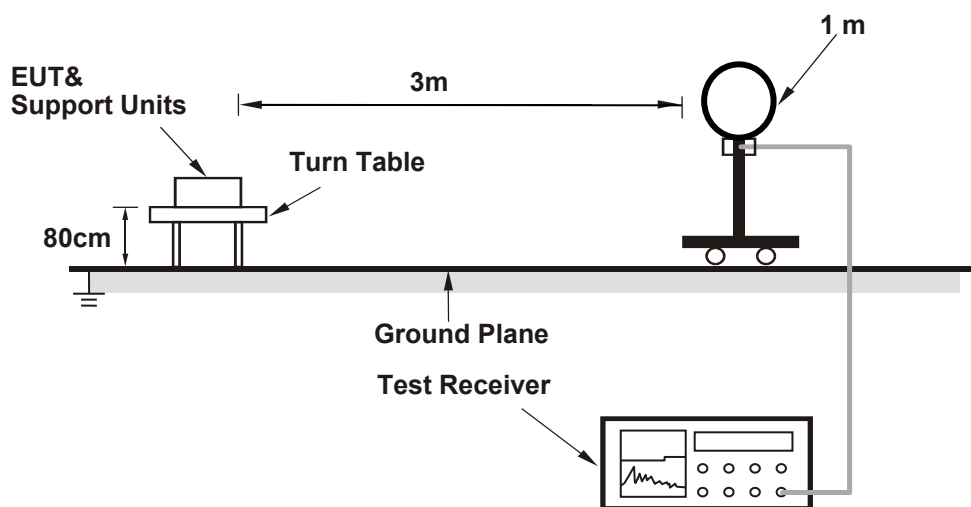

For Radiated emission 30MHz to 1GHz

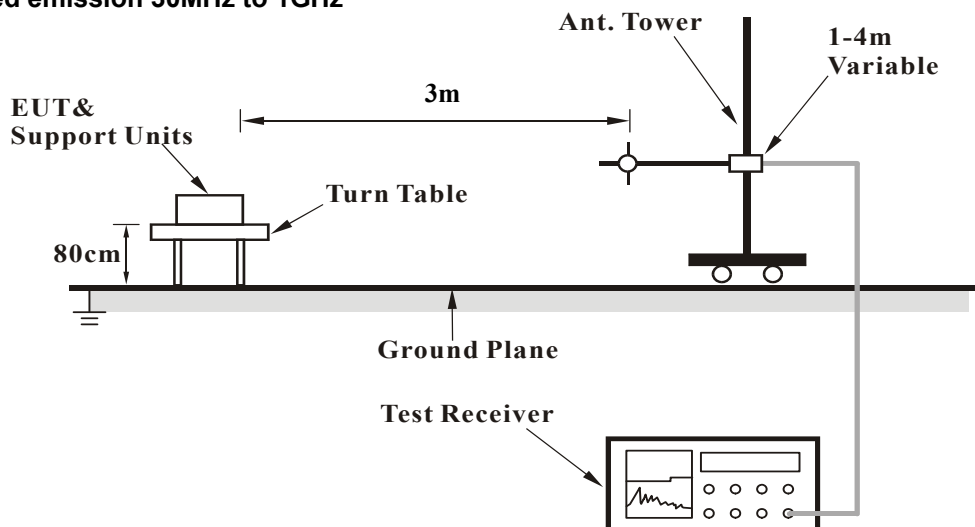

For Radiated emission above 1GHz

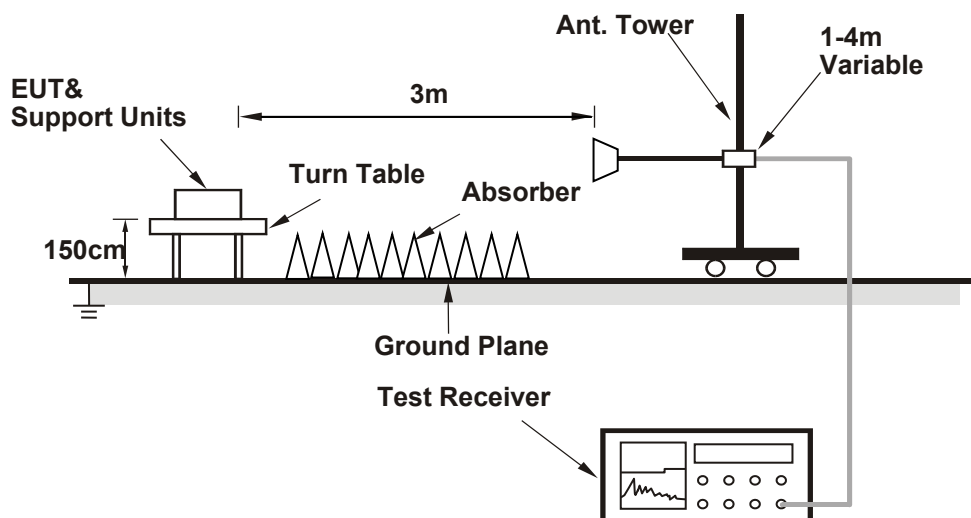

For the actual test configuration, please refer to the attached file (Test Setup Photo).

4.1.6 EUT Operating Conditions

- Installed the EUT into the jig.
- Prepared a notebook to act as a communication partner and placed it outside of testing area.
- The communication partner connected with EUT via USB cable and ran a test program (provided by manufacturer) to enable EUT under transmission condition continuously at specific channel frequency.

4.1.7 Test Results

Above 1GHz Data:

802.11b + BT

CHANNEL	CH 6 + CH 39	DETECTOR FUNCTION	Peak (PK) Average (AV)
FREQUENCY RANGE	1GHz ~ 40GHz		

Antenna Polarity & Test Distance : Horizontal at 3 m								
No	Frequency (MHz)	Emission Level (dBuV/m)	Limit (dBuV/m)	Margin (dB)	Antenna Height (m)	Table Angle (Degree)	Raw Value (dBuV)	Correction Factor (dB/m)
1	*2437.00	116.6 PK			1.21 H	39	85.5	31.1
2	*2437.00	112.7 AV			1.21 H	39	81.6	31.1
3	*2441.00	108.2 PK			1.20 H	359	77.1	31.1
4	*2441.00	77.5 AV			1.20 H	359	46.4	31.1
5	4874.00	45.9 PK	74.0	-28.1	3.21 H	183	43.9	2.0
6	4874.00	33.0 AV	54.0	-21.0	3.21 H	183	31.0	2.0
7	4882.00	43.2 PK	74.0	-30.8	2.60 H	150	41.2	2.0
8	4882.00	12.5 AV	54.0	-41.5	2.60 H	150	10.5	2.0

Antenna Polarity & Test Distance : Vertical at 3 m								
No	Frequency (MHz)	Emission Level (dBuV/m)	Limit (dBuV/m)	Margin (dB)	Antenna Height (m)	Table Angle (Degree)	Raw Value (dBuV)	Correction Factor (dB/m)
1	*2437.00	110.0 PK			3.02 V	211	78.9	31.1
2	*2437.00	105.6 AV			3.02 V	211	74.5	31.1
3	*2441.00	104.7 PK			3.50 V	166	73.6	31.1
4	*2441.00	74.0 AV			3.52 V	166	42.9	31.1
5	4874.00	44.0 PK	74.0	-30.0	3.00 V	66	42.0	2.0
6	4874.00	31.2 AV	54.0	-22.8	3.00 V	66	29.2	2.0
7	4882.00	44.7 PK	74.0	-29.3	2.79 V	125	42.7	2.0
8	4882.00	14.0 AV	54.0	-40.0	2.79 V	125	12.0	2.0

Remarks:

1. Emission Level(dBuV/m) = Raw Value(dBuV) + Correction Factor(dB/m).
2. Correction Factor(dB/m) = Antenna Factor(dB/m) + Cable Factor(dB) – Pre-Amplifier Factor(dB).
3. Margin value = Emission Level – Limit value.
4. The other emission levels were very low against the limit.
5. " * ": Fundamental frequency.
6. " # ": The radiated frequency is out of the restricted band.

BT+ 802.11ax (HE40)

CHANNEL	CH 39 + CH 159	DETECTOR FUNCTION	Peak (PK) Average (AV)
FREQUENCY RANGE	1GHz ~ 40GHz		

Antenna Polarity & Test Distance : Horizontal at 3 m								
No	Frequency (MHz)	Emission Level (dBuV/m)	Limit (dBuV/m)	Margin (dB)	Antenna Height (m)	Table Angle (Degree)	Raw Value (dBuV)	Correction Factor (dB/m)
1	*2441.00	107.8 PK			1.22 H	355	76.7	31.1
2	*2441.00	77.1 AV			1.22 H	355	46.0	31.1
3	4882.00	42.8 PK	74.0	-31.2	2.46 H	180	40.8	2.0
4	4882.00	12.1 AV	54.0	-41.9	2.46 H	180	10.1	2.0
5	#5627.20	52.4 PK	68.2	-15.8	1.99 H	0	49.8	2.6
6	*5795.00	113.0 PK			1.99 H	0	75.5	37.5
7	*5795.00	100.0 AV			1.99 H	0	62.5	37.5
8	#5931.20	53.8 PK	68.2	-14.4	1.99 H	0	50.5	3.3
9	11590.00	57.9 PK	74.0	-16.1	2.12 H	199	42.8	15.1
10	11590.00	44.5 AV	54.0	-9.5	2.12 H	199	29.4	15.1

Antenna Polarity & Test Distance : Vertical at 3 m								
No	Frequency (MHz)	Emission Level (dBuV/m)	Limit (dBuV/m)	Margin (dB)	Antenna Height (m)	Table Angle (Degree)	Raw Value (dBuV)	Correction Factor (dB/m)
1	*2441.00	104.7 PK			3.33 V	133	73.6	31.1
2	*2441.00	74.0 AV			3.33 V	133	42.9	31.1
3	4882.00	42.7 PK	74.0	-31.3	2.61 V	177	40.7	2.0
4	4882.00	12.0 AV	54.0	-42.0	2.61 V	177	10.0	2.0
5	#5640.00	51.8 PK	68.2	-16.4	3.59 V	250	49.2	2.6
6	*5795.00	110.5 PK			3.59 V	250	73.0	37.5
7	*5795.00	98.3 AV			3.59 V	250	60.8	37.5
8	#5925.80	53.4 PK	68.2	-14.8	3.59 V	250	50.1	3.3
9	11590.00	56.2 PK	74.0	-17.8	3.12 V	267	41.1	15.1
10	11590.00	43.1 AV	54.0	-10.9	3.12 V	267	28.0	15.1

Remarks:

1. Emission Level(dBuV/m) = Raw Value(dBuV) + Correction Factor(dB/m).
2. Correction Factor(dB/m) = Antenna Factor(dB/m) + Cable Factor(dB) – Pre-Amplifier Factor(dB).
3. Margin value = Emission Level – Limit value.
4. The other emission levels were very low against the limit.
5. " * " : Fundamental frequency.
6. " # " : The radiated frequency is out of the restricted band.

Below 1GHz data

802.11b + BT

CHANNEL	CH 6 + CH 39	DETECTOR FUNCTION	Quasi-Peak (QP)
FREQUENCY RANGE	9kHz ~ 1GHz		

ANTENNA POLARITY & TEST DISTANCE: HORIZONTAL AT 3 M								
NO.	FREQ. (MHz)	EMISSION LEVEL (dBuV/m)	LIMIT (dBuV/m)	MARGIN (dB)	ANTENNA HEIGHT (m)	TABLE ANGLE (Degree)	RAW VALUE (dBuV)	CORRECTION FACTOR (dB/m)
1	33.88	32.8 QP	40.0	-7.2	1.50 H	45	42.9	-10.1
2	152.22	32.8 QP	43.5	-10.7	1.50 H	167	41.2	-8.4
3	563.50	36.4 QP	46.0	-9.6	1.50 H	204	37.9	-1.5
4	714.82	41.2 QP	46.0	-4.8	1.50 H	114	39.8	1.4
5	870.02	34.4 QP	46.0	-11.6	1.50 H	352	30.1	4.3
6	982.54	36.2 QP	54.0	-17.8	1.50 H	243	30.0	6.2

Remarks:

1. Emission Level(dBuV/m) = Raw Value(dBuV) + Correction Factor(dB/m).
2. Correction Factor(dB/m) = Antenna Factor(dB/m) + Cable Factor(dB) – Pre-Amplifier Factor(dB).
3. The other emission levels were very low against the limit of frequency range 30MHz ~ 1000MHz.
4. Margin value = Emission Level – Limit value.
5. The emission levels were very low against the limit of frequency range 9kHz ~ 30MHz: the amplitude of spurious emissions attenuated more than 20 dB below the permissible value to be report.

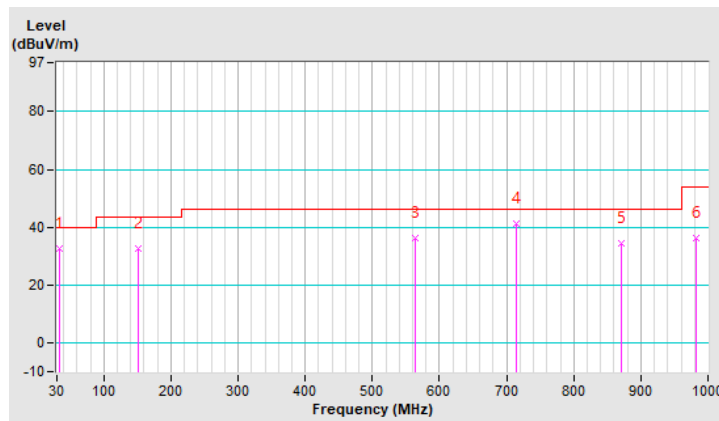

CHANNEL	CH 6 + CH 39	DETECTOR FUNCTION	Quasi-Peak (QP)
FREQUENCY RANGE	9kHz ~ 1GHz		

ANTENNA POLARITY & TEST DISTANCE: VERTICAL AT 3 M								
NO.	FREQ. (MHz)	EMISSION LEVEL (dBuV/m)	LIMIT (dBuV/m)	MARGIN (dB)	ANTENNA HEIGHT (m)	TABLE ANGLE (Degree)	RAW VALUE (dBuV)	CORRECTION FACTOR (dB/m)
1	37.76	30.2 QP	40.0	-9.8	1.50 V	30	40.1	-9.9
2	70.74	29.6 QP	40.0	-10.4	1.50 V	14	40.5	-10.9
3	588.72	35.3 QP	46.0	-10.7	1.50 V	263	36.1	-0.8
4	720.64	40.6 QP	46.0	-5.4	1.50 V	167	39.1	1.5
5	901.06	36.3 QP	46.0	-9.7	1.50 V	149	31.3	5.0
6	998.06	36.3 QP	54.0	-17.7	1.50 V	16	30.1	6.2

Remarks:

1. Emission Level(dBuV/m) = Raw Value(dBuV) + Correction Factor(dB/m).
2. Correction Factor(dB/m) = Antenna Factor(dB/m) + Cable Factor(dB) – Pre-Amplifier Factor(dB).
3. The other emission levels were very low against the limit of frequency range 30MHz ~ 1000MHz.
4. Margin value = Emission Level – Limit value.
5. The emission levels were very low against the limit of frequency range 9kHz ~ 30MHz: the amplitude of spurious emissions attenuated more than 20 dB below the permissible value to be report.

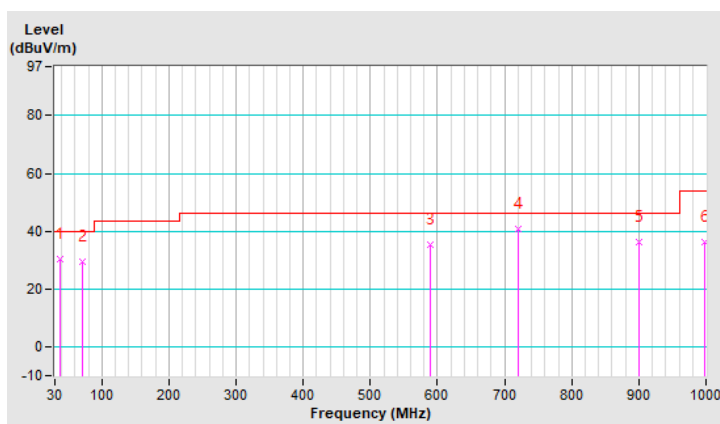

BT+ 802.11ax (HE40)

CHANNEL	CH 39 + CH 159	DETECTOR FUNCTION	Quasi-Peak (QP)
FREQUENCY RANGE	9kHz ~ 1GHz		

ANTENNA POLARITY & TEST DISTANCE: HORIZONTAL AT 3 M								
NO.	FREQ. (MHz)	EMISSION LEVEL (dBuV/m)	LIMIT (dBuV/m)	MARGIN (dB)	ANTENNA HEIGHT (m)	TABLE ANGLE (Degree)	RAW VALUE (dBuV)	CORRECTION FACTOR (dB/m)
1	59.10	30.1 QP	40.0	-9.9	1.50 H	243	39.4	-9.3
2	150.28	32.6 QP	43.5	-10.9	1.50 H	277	41.0	-8.4
3	450.98	37.8 QP	46.0	-8.2	1.50 H	126	41.2	-3.4
4	718.70	39.1 QP	46.0	-6.9	1.50 H	338	37.7	1.4
5	870.02	34.4 QP	46.0	-11.6	1.50 H	352	30.1	4.3
6	990.30	40.2 QP	54.0	-13.8	1.50 H	198	34.1	6.1

Remarks:

1. Emission Level(dBuV/m) = Raw Value(dBuV) + Correction Factor(dB/m).
2. Correction Factor(dB/m) = Antenna Factor(dB/m) + Cable Factor(dB) – Pre-Amplifier Factor(dB).
3. The other emission levels were very low against the limit of frequency range 30MHz ~ 1000MHz.
4. Margin value = Emission Level – Limit value.
5. The emission levels were very low against the limit of frequency range 9kHz ~ 30MHz: the amplitude of spurious emissions attenuated more than 20 dB below the permissible value to be report.

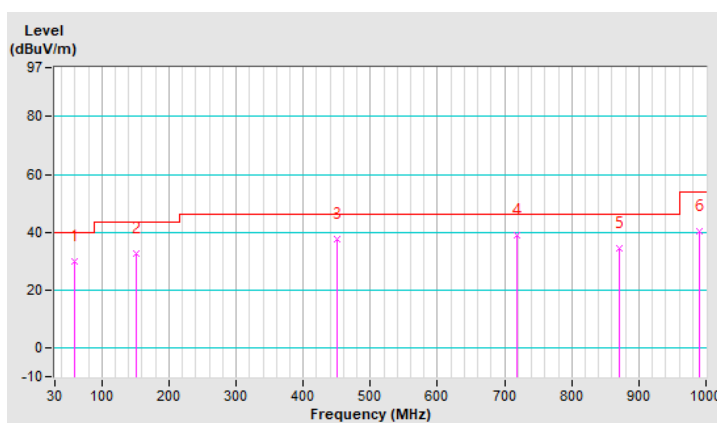

CHANNEL	CH 39 + CH 159	DETECTOR FUNCTION	Quasi-Peak (QP)
FREQUENCY RANGE	9kHz ~ 1GHz		

ANTENNA POLARITY & TEST DISTANCE: VERTICAL AT 3 M								
NO.	FREQ. (MHz)	EMISSION LEVEL (dBuV/m)	LIMIT (dBuV/m)	MARGIN (dB)	ANTENNA HEIGHT (m)	TABLE ANGLE (Degree)	RAW VALUE (dBuV)	CORRECTION FACTOR (dB/m)
1	30.00	30.8 QP	40.0	-9.2	1.00 V	314	41.1	-10.3
2	70.74	29.6 QP	40.0	-10.4	1.50 V	14	40.5	-10.9
3	602.30	39.8 QP	46.0	-6.2	1.50 V	286	40.3	-0.5
4	714.82	40.4 QP	46.0	-5.6	1.50 V	145	39.0	1.4
5	891.36	34.7 QP	46.0	-11.3	1.50 V	358	30.0	4.7
6	972.84	35.7 QP	54.0	-18.3	2.00 V	32	29.6	6.1

Remarks:

1. Emission Level(dBuV/m) = Raw Value(dBuV) + Correction Factor(dB/m).
2. Correction Factor(dB/m) = Antenna Factor(dB/m) + Cable Factor(dB) – Pre-Amplifier Factor(dB).
3. The other emission levels were very low against the limit of frequency range 30MHz ~ 1000MHz.
4. Margin value = Emission Level – Limit value.
5. The emission levels were very low against the limit of frequency range 9kHz ~ 30MHz: the amplitude of spurious emissions attenuated more than 20 dB below the permissible value to be report.

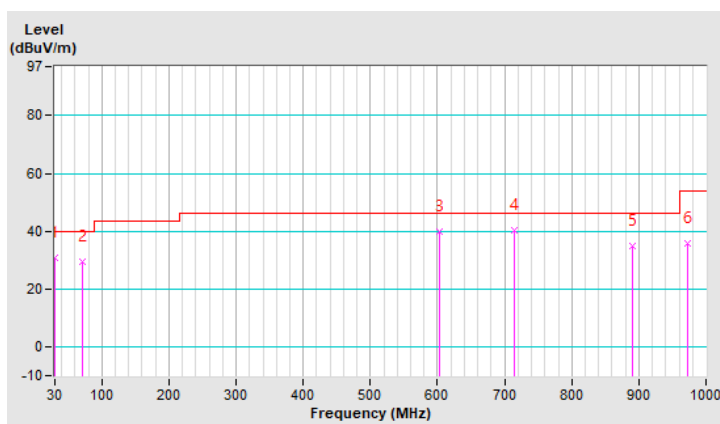

Annex A - Radiated Out of Band Emission (OOBE) Measurement (For U-NII-3 band)

802.11ax (HE40)

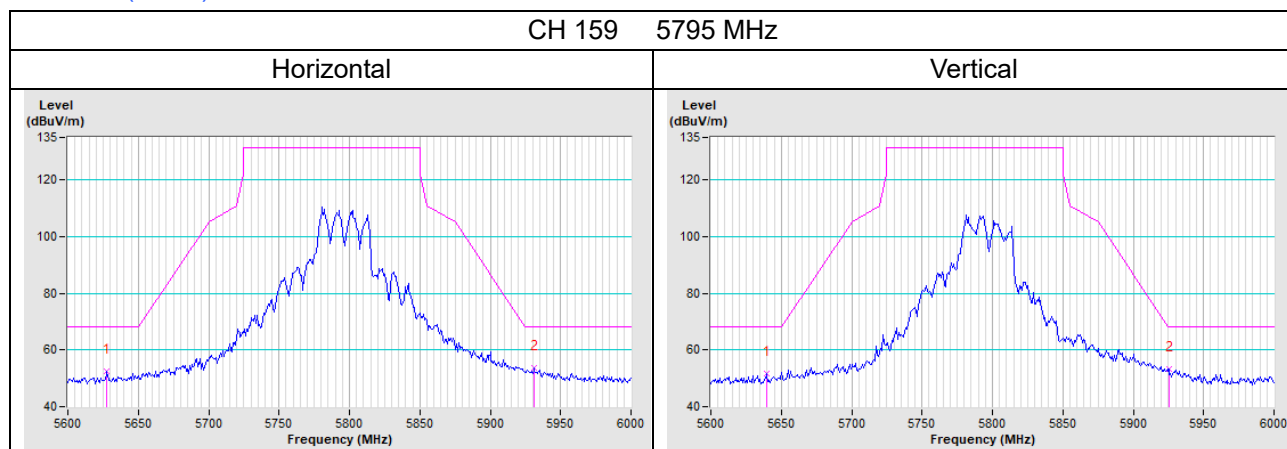

5 Pictures of Test Arrangements

Please refer to the attached file (Test Setup Photo).

Appendix – Information of the Testing Laboratories

We, Bureau Veritas Consumer Products Services (H.K.) Ltd., Taoyuan Branch, were founded in 1988 to provide our best service in EMC, Radio, Telecom and Safety consultation. Our laboratories are FCC recognized accredited test firms and accredited and approved according to ISO/IEC 17025.

If you have any comments, please feel free to contact us at the following:

Lin Kou EMC/RF Lab

Tel: 886-2-26052180

Fax: 886-2-26051924

Hsin Chu EMC/RF/Telecom Lab

Tel: 886-3-6668565

Fax: 886-3-6668323

Hwa Ya EMC/RF/Safety

Tel: 886-3-3183232

Fax: 886-3-3270892

Email: service.adt@tw.bureauveritas.com

Web Site: www.bureauveritas-adt.com

The address and road map of all our labs can be found in our web site also.

--- END ---