

FCC Test Report

Report No.: RFBHAT-WTW-P21030696-3 R1

FCC ID: R68OQ660US

Test Model: Open-Q 660 uSOM

Received Date: Mar. 18, 2021

Test Date: Apr. 08 ~ Jun. 10, 2021

Issued Date: Nov. 08, 2021

Applicant: Lantronix, Inc.

Address: 7535 Irvine Center Drive, Suite 100, Irvine, CA 92618 USA

Issued By: Bureau Veritas Consumer Products Services (H.K.) Ltd., Taoyuan Branch
Lin Kou Laboratories

Lab Address: No. 47-2, 14th Ling, Chia Pau Vil., Lin Kou Dist., New Taipei City, Taiwan

Test Location: No.19, Hwa Ya 2nd Rd., Wen Hwa Vil., Kwei Shan Dist., Taoyuan City
33383, Taiwan

**FCC Registration /
Designation Number:** 788550 / TW0003



This report is for your exclusive use. Any copying or replication of this report to or for any other person or entity, or use of our name or trademark, is permitted only with our prior written permission. This report sets forth our findings solely with respect to the test samples identified herein. The results set forth in this report are not indicative or representative of the quality or characteristics of the lot from which a test sample was taken or any similar or identical product unless specifically and expressly noted. Our report includes all of the tests requested by you and the results thereof based upon the information that you provided to us. You have 60 days from date of issuance of this report to notify us of any material error or omission caused by our negligence, provided, however, that such notice shall be in writing and shall specifically address the issue you wish to raise. A failure to raise such issue within the prescribed time shall constitute your unqualified acceptance of the completeness of this report, the tests conducted and the correctness of the report contents. Unless specific mention, the uncertainty of measurement has been explicitly taken into account to declare the compliance or non-compliance to the specification.

Table of Contents

Release Control Record	4
1 Certificate of Conformity	5
2 Summary of Test Results	6
2.1 Measurement Uncertainty	6
2.2 Modification Record	6
3 General Information	7
3.1 General Description of EUT	7
3.2 Description of Test Modes	9
3.2.1 Test Mode Applicability and Tested Channel Detail	11
3.3 Duty Cycle of Test Signal	13
3.4 Description of Support Units	14
3.4.1 Configuration of System under Test	14
3.5 General Description of Applied Standards and References	14
4 Test Types and Results	15
4.1 Radiated Emission and Bandedge Measurement	15
4.1.1 Limits of Radiated Emission and Bandedge Measurement	15
4.1.2 Test Instruments	17
4.1.3 Test Procedures	19
4.1.4 Deviation from Test Standard	19
4.1.5 Test Setup	20
4.1.6 EUT Operating Conditions	21
4.1.7 Test Results	22
4.2 Conducted Emission Measurement	65
4.2.1 Limits of Conducted Emission Measurement	65
4.2.2 Test Instruments	65
4.2.3 Test Procedures	66
4.2.4 Deviation from Test Standard	66
4.2.5 Test Setup	66
4.2.6 EUT Operating Conditions	66
4.2.7 Test Results	67
4.3 Transmit Power Measurement	69
4.3.1 Limits of Transmit Power Measurement	69
4.3.2 Test Setup	69
4.3.3 Test Instruments	70
4.3.4 Test Procedure	70
4.3.5 Deviation from Test Standard	71
4.3.6 EUT Operating Conditions	71
4.3.7 Test Results	72
4.4 Occupied Bandwidth Measurement	88
4.4.1 Test Setup	88
4.4.2 Test Instruments	88
4.4.3 Test Procedure	88
4.4.4 Test Results	89
4.5 Peak Power Spectral Density Measurement	96
4.5.1 Limits of Peak Power Spectral Density Measurement	96
4.5.2 Test Setup	96
4.5.3 Test Instruments	96
4.5.4 Test Procedures	96
4.5.5 Deviation from Test Standard	97
4.5.6 EUT Operating Conditions	97
4.5.7 Test Results	98
4.6 Frequency Stability	106
4.6.1 Limit of Frequency Stability Measurement	106

4.6.2	Test Setup	106
4.6.3	Test Instruments	106
4.6.4	Test Procedure	106
4.6.5	Deviation from Test Standard	106
4.6.6	EUT Operating Condition	106
4.6.7	Test Results	107
4.7	6 dB Bandwidth Measurement.....	108
4.7.1	Limits of 6 dB Bandwidth Measurement.....	108
4.7.2	Test Setup.....	108
4.7.3	Test Instruments	108
4.7.4	Test Procedure	108
4.7.5	Deviation from Test Standard	108
4.7.6	EUT Operating Condition	108
4.7.7	Test Results	109
5	Pictures of Test Arrangements.....	111
	Annex A- Radiated Out of Band Emission (OOBE) Measurement (For U-NII-3 band)	112
	Annex B- Band Edge Measurement.....	115
	Appendix – Information of the Testing Laboratories	130

Release Control Record

Issue No.	Description	Date Issued
RFBHAT-WTW-P21030696-3	Original Release	Sep. 10, 2021
RFBHAT-WTW-P21030696-3 R1	Revise Applicant	Nov. 08, 2021

1 Certificate of Conformity

Product: Open-Q 660 uSOM
Brand: Lantronix
Test Model: Open-Q 660 uSOM
Sample Status: Engineering Sample
Applicant: Lantronix, Inc.
Test Date: Apr. 08 ~ Jun. 10, 2021
Standards: 47 CFR FCC Part 15, Subpart E (Section 15.407)
ANSI C63.10:2013

The above equipment has been tested by **Bureau Veritas Consumer Products Services (H.K.) Ltd., Taoyuan Branch**, and found compliance with the requirement of the above standards. The test record, data evaluation & Equipment Under Test (EUT) configurations represented herein are true and accurate accounts of the measurements of the sample's RF characteristics under the conditions specified in this report.

Lena Wang
Prepared by : _____, **Date:** Nov. 08, 2021
Lena Wang / Specialist

Dylan Chiou
Approved by : _____, **Date:** Nov. 08, 2021
Dylan Chiou / Senior Engineer

2 Summary of Test Results

47 CFR FCC Part 15, Subpart E (Section 15.407)			
FCC Clause	Test Item	Result	Remarks
15.407(b)(8)	AC Power Conducted Emissions	Pass	Meet the requirement of limit. Minimum passing margin is -25.28 dB at 0.40600 MHz.
15.407(b) (1/2/3/4(i/ii)/8)	Radiated Emissions & Band Edge Measurement	Pass	Meet the requirement of limit. Minimum passing margin is -0.3 dB at 5470.00 MHz.
15.407(a)(1/2/3)	Max Average Transmit Power	Pass	Meet the requirement of limit.
---	Occupied Bandwidth Measurement	-	Reference only
15.407(a)(1/2/3)	Peak Power Spectral Density	Pass	Meet the requirement of limit.
15.407(e)	6 dB Bandwidth	Pass	Meet the requirement of limit. (U-NII-3 Band only)
15.407(g)	Frequency Stability	Pass	Meet the requirement of limit.
15.203	Antenna Requirement	Pass	Antenna connector is U.FL.

Note:

- For U-NII-3 band compliance with rule part 15.407(b)(4)(i), the OOB test plots were recorded in Annex A.
- For U-NII-1, U-NII-2A, U-NII-2C band compliance with rule 15.407(b) of the band-edge items, the test plots were recorded in Annex B. Test Procedures refer to report 4.1.3.
- Determining compliance based on the results of the compliance measurement, not taking into account measurement instrumentation uncertainty.

2.1 Measurement Uncertainty

Where relevant, the following measurement uncertainty levels have been estimated for tests performed on the EUT as specified in CISPR 16-4-2:

Measurement	Frequency	Expanded Uncertainty (k=2) (\pm)
Conducted Emissions at mains ports	150 kHz ~ 30 MHz	2.79 dB
Radiated Emissions up to 1 GHz	9 kHz ~ 30 MHz	3.04 dB
	30 MHz ~ 200 MHz	2.93 dB
	200 MHz ~ 1000 MHz	2.95 dB
Radiated Emissions above 1 GHz	1 GHz ~ 18 GHz	2.26 dB
	18 GHz ~ 40 GHz	1.94 dB

2.2 Modification Record

There were no modifications required for compliance.

3 General Information

3.1 General Description of EUT

Product	Open-Q 660 uSOM
Brand	Lantronix
Test Model	Open-Q 660 uSOM
Status of EUT	Engineering Sample
Power Supply Rating	12 Vdc (Adapter)
Modulation Type	256QAM, 64QAM, 16QAM, QPSK, BPSK
Modulation Technology	OFDM
Transfer Rate	802.11a: 54.0/ 48.0/ 36.0/ 24.0/ 18.0/ 12.0/ 9.0/ 6.0 Mbps 802.11n: up to 300 Mbps 802.11ac: up to 866.7 Mbps
Operating Frequency	5180 ~ 5240 MHz, 5260 ~ 5320 MHz, 5500 ~ 5720 MHz, 5745 ~ 5825 MHz
Number of Channel	5180 ~ 5240 MHz: 4 for 802.11a, 802.11n (HT20), 802.11ac (VHT20) 2 for 802.11n (HT40), 802.11ac (VHT40) 1 for 802.11ac (VHT80) 5260 ~ 5320 MHz: 4 for 802.11a, 802.11n (HT20), 802.11ac (VHT20) 2 for 802.11n (HT40), 802.11ac (VHT40) 1 for 802.11ac (VHT80) 5500 ~ 5720 MHz: 9 for 802.11a, 802.11n (HT20), 802.11ac (VHT20) 4 for 802.11n (HT40), 802.11ac (VHT40) 2 for 802.11ac (VHT80) 5745 ~ 5825 MHz: 5 for 802.11a, 802.11n (HT20), 802.11ac (VHT20) 2 for 802.11n (HT40), 802.11ac (VHT40) 1 for 802.11ac (VHT80)
Output Power	CDD mode: 47.017 mW for 5180 ~ 5240 MHz 48.663 mW for 5260 ~ 5320 MHz 217.795 mW for 5500 ~ 5720 MHz 411.182 mW for 5745 ~ 5825 MHz Beamforming mode: 23.837 mW for 5180 ~ 5240 MHz 48.663 mW for 5260 ~ 5320 MHz 119.687 mW for 5500 ~ 5720 MHz 411.182 mW for 5745 ~ 5825 MHz
Antenna Type	Refer to Note as below
Antenna Connector	Refer to Note as below
Accessory Device	Refer to Note as below
Data Cable Supplied	N/A

Note:

1. The EUT incorporates a MIMO function. Physically, the EUT provides two completed transmitters and two receivers.

Modulation Mode	Tx Function	CDD Mode	Beamforming Mode
802.11a	2TX	Support	Not Support
802.11n (HT20)	2TX	Support	Support
802.11n (HT40)	2TX	Support	Support
802.11ac (VHT20)	2TX	Support	Support
802.11ac (VHT40)	2TX	Support	Support
802.11ac (VHT80)	2TX	Support	Support

* The modulation and bandwidth are similar for 802.11n mode for HT20 / HT40 and 802.11ac mode for VHT20 / VHT40, therefore investigated worst case to representative mode in test report. (Final test mode refer section 3.2.1)

2. The following antennas were provided to the EUT.

Ant. Type	Flexible Dipole Antenna	
Connector Type	U.FL	
Antenna Gain (dBi)		
Item	2.4~2.5G	4.9~5.8G
Ant 1	3.32	6.11
Ant 2	3.32	6.11

3. The above Antenna information is declared by manufacturer and for more detailed features description, please refer to the manufacturer's specifications, the laboratory shall not be held responsible.
4. The above EUT information is declared by manufacturer and for more detailed features description, please refers to the manufacturer's specifications or user's manual.
5. BT, 2.4G and 5GHz WLAN can transmit simultaneously. The emission of the simultaneous operation has been evaluated and non-compliance was found.

3.2 Description of Test Modes

For 5180 ~ 5240 MHz

4 channels are provided for 802.11a, 802.11n (HT20), 802.11ac (VHT20):

Channel	Frequency (MHz)	Channel	Frequency (MHz)
36	5180	44	5220
40	5200	48	5240

2 channels are provided for 802.11n (HT40), 802.11ac (VHT40):

Channel	Frequency (MHz)	Channel	Frequency (MHz)
38	5190	46	5230

1 channel is provided for 802.11ac (VHT80):

Channel	Frequency (MHz)
42	5210

For 5260 ~ 5320 MHz

4 channels are provided for 802.11a, 802.11n (HT20), 802.11ac (VHT20):

Channel	Frequency (MHz)	Channel	Frequency (MHz)
52	5260	60	5300
56	5280	64	5320

2 channels are provided for 802.11n (HT40), 802.11ac (VHT40):

Channel	Frequency (MHz)	Channel	Frequency (MHz)
54	5270	62	5310

1 channel is provided for 802.11ac (VHT80):

Channel	Frequency (MHz)
58	5290

For 5500 ~ 5720 MHz

9 channels are provided for 802.11a, 802.11n (HT20), 802.11ac (VHT20):

Channel	Frequency (MHz)	Channel	Frequency (MHz)
100	5500	132	5660
104	5520	136	5680
108	5540	140	5700
112	5560	144	5720
116	5580		

4 channels are provided for 802.11n (HT40), 802.11ac (VHT40):

Channel	Frequency (MHz)	Channel	Frequency (MHz)
102	5510	134	5670
110	5550	142	5710

2 channels are provided for 802.11ac (VHT80):

Channel	Frequency (MHz)	Channel	Frequency (MHz)
106	5530	138	5690

For 5745 ~ 5825 MHz:

5 channels are provided for 802.11a, 802.11n (HT20), 802.11ac (VHT20):

Channel	Frequency (MHz)	Channel	Frequency (MHz)
149	5745	161	5805
153	5765	165	5825
157	5785		

2 channels are provided for 802.11n (HT40), 802.11ac (VHT40):

Channel	Frequency (MHz)	Channel	Frequency (MHz)
151	5755	159	5795

1 channel is provided for 802.11ac (VHT80):

Channel	Frequency (MHz)
155	5775

3.2.1 Test Mode Applicability and Tested Channel Detail

EUT Configure Mode	Applicable To				Description
	RE \geq 1G	RE $<$ 1G	PLC	APCM	
-	√	√	√	√	-

Where **RE \geq 1G**: Radiated Emission above 1 GHz **RE $<$ 1G**: Radiated Emission below 1 GHz
PLC: Power Line Conducted Emission **APCM**: Antenna Port Conducted Measurement

Note:

1. The EUT had been pre-tested on the positioned of each 3 axis. The worst case was found when positioned on **Z-plane**.
2. "-" means no effect.
3. Radiated emission test (below 1GHz) and power line conducted emission test items chosen the worst fundamental frequency emission level.

Radiated Emission Test (Above 1 GHz):

- Pre-Scan has been conducted to determine the worst-case mode from all possible combinations between available modulations, data rates and antenna ports (if EUT with antenna diversity architecture).
- Following channel(s) was (were) selected for the final test as listed below.

EUT Configure Mode	Frequency Band (MHz)	Mode	Available Channel	Tested Channel	Modulation Technology	Modulation Type	Data Rate (Mbps)
-	5180-5240	802.11a	36 to 48	36, 40, 48	OFDM	BPSK	6.0
-		802.11ac (VHT20)	36 to 48	36, 40, 48	OFDM	BPSK	7.2
-		802.11ac (VHT40)	38 to 46	38, 46	OFDM	BPSK	15
-		802.11ac (VHT80)	42	42	OFDM	BPSK	29.3
-	5260-5320	802.11a	52 to 64	52, 60, 64	OFDM	BPSK	6.0
-		802.11ac (VHT20)	52 to 64	52, 60, 64	OFDM	BPSK	7.2
-		802.11ac (VHT40)	54 to 62	54, 62	OFDM	BPSK	15
-		802.11ac (VHT80)	58	58	OFDM	BPSK	29.3
-	5500-5720	802.11a	100 to 144	100, 116, 140, 144	OFDM	BPSK	6.0
-		802.11ac (VHT20)	100 to 144	100, 116, 140, 144	OFDM	BPSK	7.2
-		802.11ac (VHT40)	102 to 142	102, 110, 134, 142	OFDM	BPSK	15
-		802.11ac (VHT80)	106 to 138	106, 138	OFDM	BPSK	29.3
-	5745-5825	802.11a	149 to 165	149, 157, 165	OFDM	BPSK	6.0
-		802.11ac (VHT20)	149 to 165	149, 157, 165	OFDM	BPSK	7.2
-		802.11ac (VHT40)	151 to 159	151, 159	OFDM	BPSK	15
-		802.11ac (VHT80)	155	155	OFDM	BPSK	29.3

Radiated Emission Test (Below 1 GHz):

- Pre-Scan has been conducted to determine the worst-case mode from all possible combinations between available modulations, data rates and antenna ports (if EUT with antenna diversity architecture).
- Following channel(s) was (were) selected for the final test as listed below.

EUT Configure Mode	Frequency Band (MHz)	Mode	Available Channel	Tested Channel	Modulation Technology	Modulation Type	Data Rate (Mbps)
-	5260-5320	802.11ac (VHT20)	100 to 144	100	OFDM	BPSK	7.2

Power Line Conducted Emission Test:

- Pre-Scan has been conducted to determine the worst-case mode from all possible combinations between available modulations, data rates and antenna ports (if EUT with antenna diversity architecture).
- Following channel(s) was (were) selected for the final test as listed below.

EUT Configure Mode	Frequency Band (MHz)	Mode	Available Channel	Tested Channel	Modulation Technology	Modulation Type	Data Rate (Mbps)
-	5260-5320	802.11ac (VHT20)	100 to 144	100	OFDM	BPSK	7.2

Antenna Port Conducted Measurement:

- This item includes all test value of each mode, but only includes spectrum plot of worst value of each mode.
- Pre-Scan has been conducted to determine the worst-case mode from all possible combinations between available modulations, data rates and antenna ports (if EUT with antenna diversity architecture).
- Following channel(s) was (were) selected for the final test as listed below.

EUT Configure Mode	Frequency Band (MHz)	Mode	Available Channel	Tested Channel	Modulation Technology	Modulation Type	Data Rate (Mbps)
-	5180-5240	802.11a	36 to 48	36, 40, 48	OFDM	BPSK	6.0
-		802.11ac (VHT20)	36 to 48	36, 40, 48	OFDM	BPSK	7.2
-		802.11ac (VHT40)	38 to 46	38, 46	OFDM	BPSK	15
-		802.11ac (VHT80)	42	42	OFDM	BPSK	29.3
-	5260-5320	802.11a	52 to 64	52, 60, 64	OFDM	BPSK	6.0
-		802.11ac (VHT20)	52 to 64	52, 60, 64	OFDM	BPSK	7.2
-		802.11ac (VHT40)	54 to 62	54, 62	OFDM	BPSK	15
-		802.11ac (VHT80)	58	58	OFDM	BPSK	29.3
-	5500-5720	802.11a	100 to 144	100, 116, 140, 144	OFDM	BPSK	6.0
-		802.11ac (VHT20)	100 to 144	100, 116, 140, 144	OFDM	BPSK	7.2
-		802.11ac (VHT40)	102 to 142	102, 110, 134, 142	OFDM	BPSK	15
-		802.11ac (VHT80)	106 to 138	106, 138	OFDM	BPSK	29.3
-	5745-5825	802.11a	149 to 165	149, 157, 165	OFDM	BPSK	6.0
-		802.11ac (VHT20)	149 to 165	149, 157, 165	OFDM	BPSK	7.2
-		802.11ac (VHT40)	151 to 159	151, 159	OFDM	BPSK	15
-		802.11ac (VHT80)	155	155	OFDM	BPSK	29.3

Test Condition:

Applicable To	Environmental Conditions	Input Power	Tested by
RE \geq 1G	25 deg. C, 65 % RH	120 Vac, 60 Hz	Adair Peng
RE $<$ 1G	25 deg. C, 65 % RH	120 Vac, 60 Hz	Adair Peng
PLC	25 deg. C, 65 % RH	120 Vac, 60 Hz	Edison Lee
APCM	25 deg. C, 65 % RH	120 Vac, 60 Hz	Ivan Tseng

3.3 Duty Cycle of Test Signal

Duty cycle of test signal is < 98 %, duty factor is required.

802.11a: Duty cycle = 2.02/2.13 = 0.948, Duty factor = $10 * \log(1/0.948) = 0.23$

802.11ac (VHT20): Duty cycle = 1.895/1.995 = 0.95, Duty factor = $10 * \log(1/0.95) = 0.22$

802.11ac (VHT40): Duty cycle = 0.927/1.042 = 0.89, Duty factor = $10 * \log(1/0.89) = 0.51$

802.11ac (VHT80): Duty cycle = 0.451/0.553 = 0.816, Duty factor = $10 * \log(1/0.816) = 0.89$

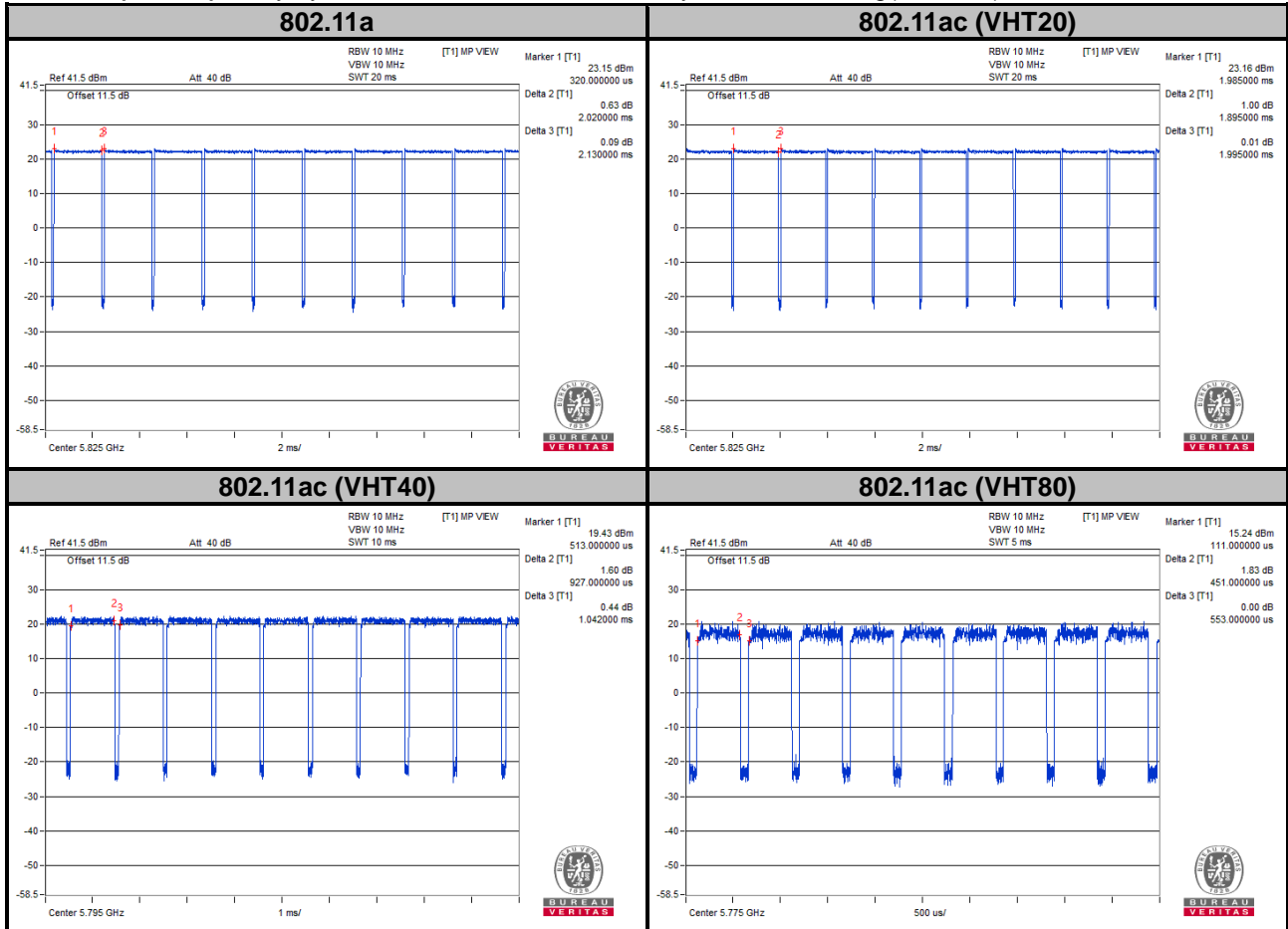

3.4 Description of Support Units

The EUT has been tested as an independent unit together with other necessary accessories or support units. The following support units or accessories were used to form a representative test configuration during the tests.

ID	Product	Brand	Model No.	Serial No.	FCC ID	Remarks
A	Notebook	DELL	Latitude E6420	HPFC5Q1	N/A	-
B	Jig	N/A	N/A	N/A	N/A	Provided by client
C	Adapter	YINGHUIYUAN	YHY-12003000	N/A	N/A	Provided by client

Note:

1. All power cords of the above support units are non-shielded (1.8m).
2. Item A acted as a communication partner to transfer data.

ID	Cable Descriptions	Qty.	Length (m)	Shielding (Yes/No)	Cores (Qty.)	Remarks
1.	Type C USB Cable	1	1	Y	0	Provided by client
2.	Adapter Cable	1	1.2	Y	1	Provided by client
3.	Power Cable	1	1.15	N	0	Provided by client

3.4.1 Configuration of System under Test

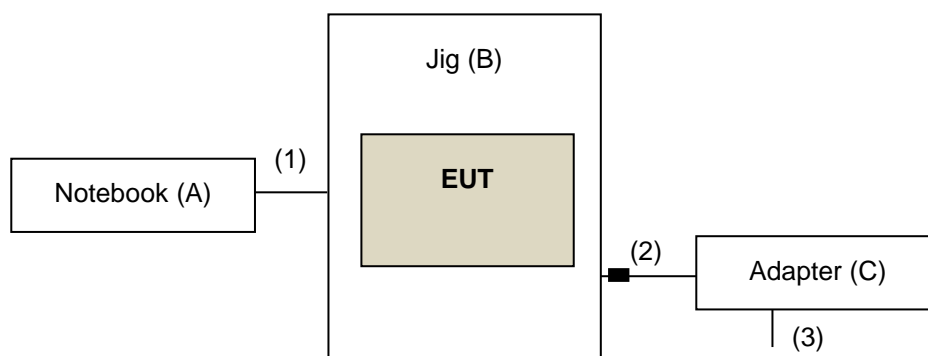

3.5 General Description of Applied Standards and References

The EUT is a RF Product. According to the specifications of the manufacturer, it must comply with the requirements of the following standards and references:

Test Standard:

FCC Part 15, Subpart E (15.407)

ANSI C63.10-2013

All test items have been performed and recorded as per the above standards.

References Test Guidance:

KDB 789033 D02 General UNII Test Procedures New Rules v02r01

KDB 662911 D01 Multiple Transmitter Output v02r01

All test items have been performed as a reference to the above KDB test guidance.

4 Test Types and Results

4.1 Radiated Emission and Bandedge Measurement

4.1.1 Limits of Radiated Emission and Bandedge Measurement

Radiated emissions which fall in the restricted bands must comply with the radiated emission limits specified as below table.

Frequencies (MHz)	Field Strength (microvolts/meter)	Measurement Distance (meters)
0.009 ~ 0.490	2400/F (kHz)	300
0.490 ~ 1.705	24000/F (kHz)	30
1.705 ~ 30.0	30	30
30 ~ 88	100	3
88 ~ 216	150	3
216 ~ 960	200	3
Above 960	500	3

Note:

1. The lower limit shall apply at the transition frequencies.
2. Emission level (dBuV/m) = 20 log Emission level (uV/m).
3. For frequencies above 1000 MHz, the field strength limits are based on average detector, however, the peak field strength of any emission shall not exceed the maximum permitted average limits, specified above by more than 20 dB under any condition of modulation.

Limits of Unwanted Emission Out of the Restricted Bands

Applicable To		Limit	
789033 D02 General UNII Test Procedures New Rules v02r01		Field Strength at 3 m	
		PK: 74 (dBµV/m)	AV: 54 (dBµV/m)
Frequency Band	Applicable To	EIRP Limit	Equivalent Field Strength at 3 m
5150~5250 MHz	15.407(b)(1)	PK: -27 (dBm/MHz)	PK: 68.2 (dBµV/m)
5250~5350 MHz	15.407(b)(2)		
5470~5725 MHz	15.407(b)(3)		
5725~5850 MHz	<input checked="" type="checkbox"/> 15.407(b)(4)(i)	PK:-27 (dBm/MHz) *1 PK:10 (dBm/MHz) *2 PK:15.6 (dBm/MHz) *3 PK:27 (dBm/MHz) *4	PK: 68.2 (dBµV/m) *1 PK:105.2 (dBµV/m) *2 PK: 110.8 (dBµV/m) *3 PK:122.2 (dBµV/m) *4
	<input type="checkbox"/> 15.407(b)(4)(ii)	Emission limits in section 15.247(d)	
<p>*1 beyond 75 MHz or more above of the band edge.</p> <p>*2 below the band edge increasing linearly to 10 dBm/MHz at 25 MHz above.</p> <p>*3 below the band edge increasing linearly to a level of 15.6 dBm/MHz at 5 MHz above.</p> <p>*4 from 5 MHz above or below the band edge increasing linearly to a level of 27 dBm/MHz at the band edge.</p>			

Note:

The following formula is used to convert the equipment isotropic radiated power (eirp) to field strength:

$$E = \frac{1000000\sqrt{30P}}{3} \quad \mu\text{V/m, where P is the eirp (Watts).$$

4.1.2 Test Instruments

Description & Manufacturer	Model No.	Serial No.	Date of Calibration	Due Date of Calibration
Test Receiver ROHDE & SCHWARZ	ESCI	100424	Dec. 31, 2020	Dec. 30, 2021
Spectrum Analyzer ROHDE & SCHWARZ	FSP40	100040	Sep. 16, 2020	Sep. 15, 2021
BILOG Antenna SCHWARZBECK	VULB9168	9168-155	Nov. 03, 2020	Nov. 02, 2021
HORN Antenna SCHWARZBECK	BBHA 9120D	9120D-1170	Nov. 22, 2020	Nov. 21, 2021
HORN Antenna SCHWARZBECK	BBHA 9170	BBHA9170241	Nov. 22, 2020	Nov. 21, 2021
Test Receiver ROHDE & SCHWARZ	ESCI	100424	Dec. 31, 2020	Dec. 30, 2021
Preamplifier Agilent (Below 1GHz)	8447D	2944A10631	Jun. 08, 2020	Jun. 07, 2021
			Jun. 05, 2021	Jun. 04, 2022
Preamplifier KEYSIGHT (Above 1GHz)	83017A	MY53270295	Jun. 08, 2020	Jun. 07, 2021
			Jun. 05, 2021	Jun. 04, 2022
RF Coaxial Cable WOKEN With 5dB PAD	8D-FB	Cable-CH4-01	Aug. 16, 2020	Aug. 15, 2021
RF Coaxial Cable EMCI	EMC102-KM-KM-3000	150929	Aug. 16, 2020	Aug. 15, 2021
RF Coaxial Cable EMCI	EMC102-KM-KM-600	150928	Aug. 16, 2020	Aug. 15, 2021
RF signal cable HUBER+SUHNER	SUCOFLEX 104	MY 13380+295012/04	Jun. 08, 2020	Jun. 07, 2021
			Jun. 05, 2021	Jun. 04, 2022
RF signal cable HUBER+SUHNER	SUCOFLEX 104	Cable-CH4-03 (250724)	Jun. 08, 2020	Jun. 07, 2021
			Jun. 05, 2021	Jun. 04, 2022
Software BV ADT	ADT_Radiated_V7.6.15.9.5	NA	NA	NA
Antenna Tower inn-co GmbH	MA 4000	010303	NA	NA
Turn Table BV ADT	TT100	TT93021703	NA	NA
Turn Table Controller BV ADT	SC100	SC93021703	NA	NA
Boresight Antenna Fixture	FBA-01	FBA-SIP01	NA	NA
USB Wideband Power Sensor KEYSIGHT	U2021XA	MY55050005/MY55 190004/MY551900 07/MY55210005	Jul. 13, 2020	Jul. 12, 2021
WIT Standard Temperature And Humidity Chamber	TH-4S-C	W981030	Jun. 01, 2020	May 31, 2021
			Jun. 01, 2021	May 31, 2022
True RMS Clamp Meter Fluke	325	31130711WS	Jun. 06, 2020	Jun. 05, 2021
			Jun. 02, 2021	Jun. 01, 2022
Digital Multimeter Fluke	87-III	70360742	Jun. 30, 2020	Jun. 29, 2021
AC Power Supply Extech	CFW-105	E000603	NA	NA

- Note: 1. The calibration interval of the above test instruments is 12 months and the calibrations are traceable to NML/ROC and NIST/USA.
2. The test was performed in HwaYa Chamber 4.

4.1.3 Test Procedures

For Radiated Emission below 30 MHz

- a. The EUT was placed on the top of a rotating table 0.8 meters above the ground at a 3 meter chamber room. The table was rotated 360 degrees to determine the position of the highest radiation.
- b. The EUT was set 3 meters away from the interference-receiving antenna, which was mounted on the top of a variable-height antenna tower.
- c. Parallel, perpendicular, and ground-parallel orientations of the antenna are set to make the measurement.
- d. For each suspected emission, the EUT was arranged to its worst case and the rotatable table was turned from 0 degrees to 360 degrees to find the maximum reading.
- e. The test-receiver system was set to Quasi-Peak Detect Function and Specified Bandwidth with Maximum Hold Mode.

Note:

1. The resolution bandwidth and video bandwidth of test receiver/spectrum analyzer is 9 kHz at frequency below 30 MHz.

For Radiated Emission above 30 MHz

- a. The EUT was placed on the top of a rotating table 0.8 meters (for 30 MHz ~ 1 GHz) / 1.5 meters (for above 1 GHz) above the ground at 3 meter chamber room for test. The table was rotated 360 degrees to determine the position of the highest radiation.
- b. The EUT was set 3 meters away from the interference-receiving antenna, which was mounted on the top of a variable-height antenna tower.
- c. The height of antenna is varied from one meter to four meters above the ground to determine the maximum value of the field strength. Both horizontal and vertical polarizations of the antenna are set to make the measurement.
- d. For each suspected emission, the EUT was arranged to its worst case and then the antenna was tuned to heights from 1 meter to 4 meters and the rotatable table was turned from 0 degrees to 360 degrees to find the maximum reading.
- e. The test-receiver system was set to quasi-peak detect function and specified bandwidth with maximum hold mode when the test frequency is below 1 GHz.
- f. The test-receiver system was set to peak and average detected function and specified bandwidth with maximum hold mode when the test frequency is above 1 GHz. If the peak reading value also meets average limit, measurement with the average detector is unnecessary.

Note:

1. The resolution bandwidth and video bandwidth of test receiver/spectrum analyzer is 120 kHz for Quasi-peak detection (QP) or Peak detection (PK) at frequency below 1 GHz.
2. The resolution bandwidth of test receiver/spectrum analyzer is 1 MHz and the video bandwidth is 3 MHz for Peak detection (PK) at frequency above 1 GHz.
3. The resolution bandwidth of test receiver/spectrum analyzer is 1 MHz and the video bandwidth is $\geq 1/T$ (Duty cycle < 98 %) or 10 Hz (Duty cycle ≥ 98 %) for Average detection (AV) at frequency above 1 GHz.
(11a: RBW = 1 MHz, VBW = 510 Hz ; 11 ac (VHT20): RBW = 1 MHz, VBW = 1 kHz ;
11 ac (VHT40): RBW = 1 MHz, VBW = 2 kHz ; 11ac (VHT80): RBW = 1 MHz, VBW = 3 kHz)
4. All modes of operation were investigated and the worst-case emissions are reported.

4.1.4 Deviation from Test Standard

No deviation.

4.1.5 Test Setup

<Radiated Emission below 30 MHz>

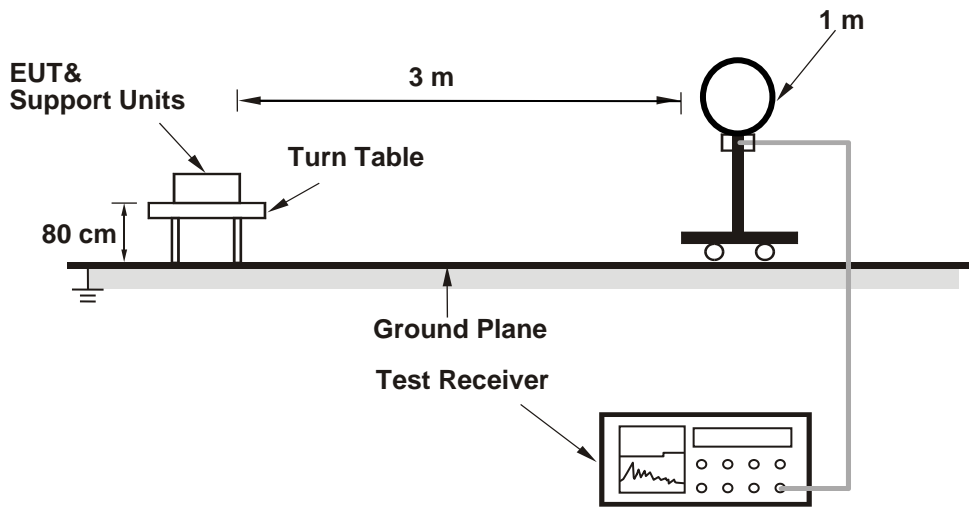

<Radiated Emission 30 MHz to 1 GHz>

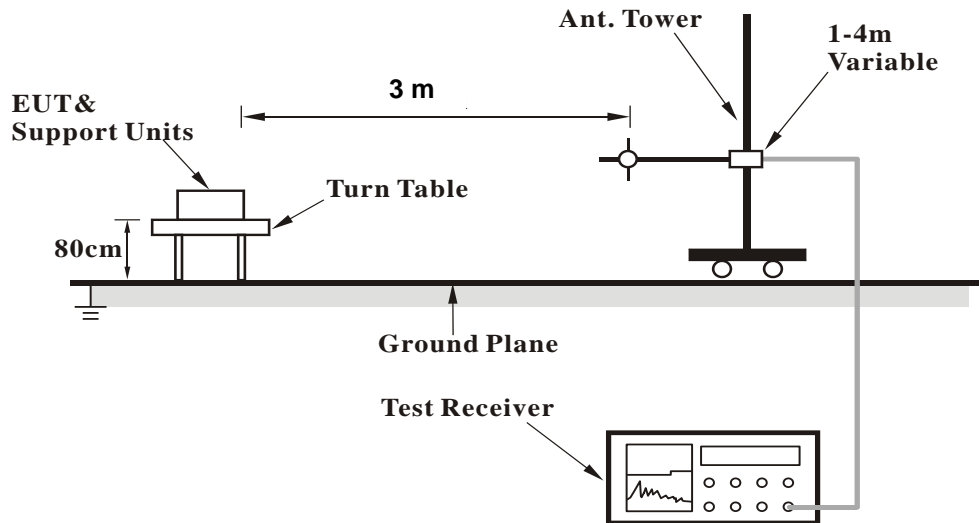

<Radiated Emission above 1 GHz>

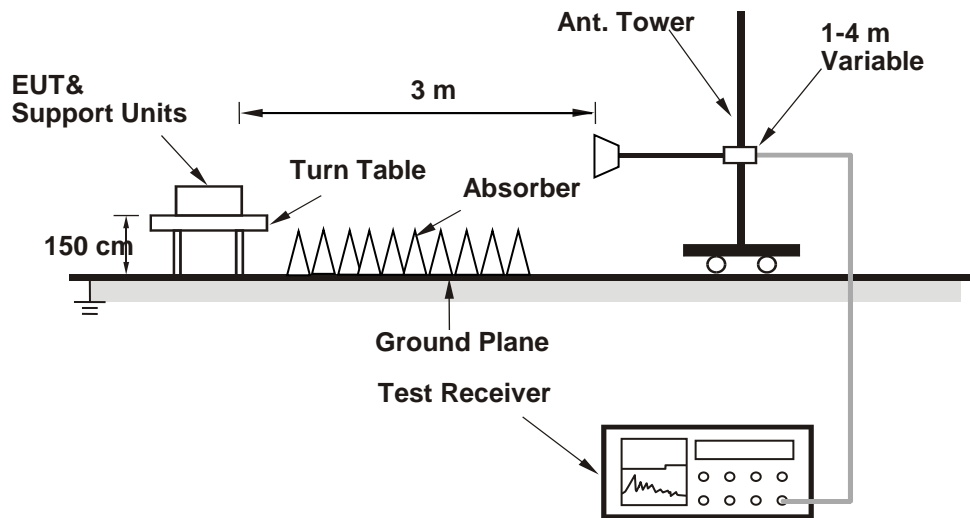

For the actual test configuration, please refer to the attached file (Test Setup Photo).

4.1.6 EUT Operating Conditions

- a. Placed the EUT on a testing table.
- b. Use the software to control the EUT under transmission condition continuously at specific channel frequency.

4.1.7 Test Results

Above 1 GHz Data :

802.11a

RF Mode	TX 802.11a	Channel	CH 36 : 5180 MHz
Frequency Range	1GHz ~ 40GHz	Detector Function	Peak (PK) Average (AV)

Antenna Polarity & Test Distance : Horizontal at 3 m

No	Frequency (MHz)	Emission Level (dBuV/m)	Limit (dBuV/m)	Margin (dB)	Antenna Height (m)	Table Angle (Degree)	Raw Value (dBuV)	Correction Factor (dB/m)
1	5150.00	66.4 PK	74.0	-7.6	1.44 H	3	63.6	2.8
2	5150.00	53.5 AV	54.0	-0.5	1.44 H	3	50.7	2.8
3	*5180.00	118.2 PK			1.44 H	3	77.2	41.0
4	*5180.00	109.6 AV			1.44 H	3	68.6	41.0
5	#10360.00	55.3 PK	68.2	-12.9	1.76 H	229	47.1	8.2

Antenna Polarity & Test Distance : Vertical at 3 m

No	Frequency (MHz)	Emission Level (dBuV/m)	Limit (dBuV/m)	Margin (dB)	Antenna Height (m)	Table Angle (Degree)	Raw Value (dBuV)	Correction Factor (dB/m)
1	5150.00	63.0 PK	74.0	-11.0	2.84 V	167	60.2	2.8
2	5150.00	49.9 AV	54.0	-4.1	2.84 V	167	47.1	2.8
3	*5180.00	116.8 PK			2.84 V	167	75.8	41.0
4	*5180.00	107.6 AV			2.84 V	167	66.6	41.0
5	#10360.00	54.7 PK	68.2	-13.5	1.53 V	172	46.5	8.2

Remarks:

1. Emission Level(dBuV/m) = Raw Value(dBuV) + Correction Factor(dB/m)
2. Correction Factor(dB/m) = Antenna Factor(dB/m) + Cable Factor(dB) – Pre-Amplifier Factor(dB)
3. Margin value = Emission Level – Limit value
4. The other emission levels were very low against the limit.
5. " * " : Fundamental frequency.
6. " # " : The radiated frequency is out of the restricted band.

RF Mode	TX 802.11a	Channel	CH 40 : 5200 MHz
Frequency Range	1GHz ~ 40GHz	Detector Function	Peak (PK) Average (AV)

Antenna Polarity & Test Distance : Horizontal at 3 m								
No	Frequency (MHz)	Emission Level (dBuV/m)	Limit (dBuV/m)	Margin (dB)	Antenna Height (m)	Table Angle (Degree)	Raw Value (dBuV)	Correction Factor (dB/m)
1	*5200.00	119.6 PK			1.73 H	12	78.6	41.0
2	*5200.00	110.8 AV			1.73 H	12	69.8	41.0
3	#10400.00	55.8 PK	68.2	-12.4	1.81 H	235	47.7	8.1
Antenna Polarity & Test Distance : Vertical at 3 m								
No	Frequency (MHz)	Emission Level (dBuV/m)	Limit (dBuV/m)	Margin (dB)	Antenna Height (m)	Table Angle (Degree)	Raw Value (dBuV)	Correction Factor (dB/m)
1	*5200.00	118.1 PK			2.88 V	170	77.1	41.0
2	*5200.00	108.9 AV			2.88 V	170	67.9	41.0
3	#10400.00	55.5 PK	68.2	-12.7	1.62 V	179	47.4	8.1

Remarks:

1. Emission Level(dBuV/m) = Raw Value(dBuV) + Correction Factor(dB/m)
2. Correction Factor(dB/m) = Antenna Factor(dB/m) + Cable Factor(dB) – Pre-Amplifier Factor(dB)
3. Margin value = Emission Level – Limit value
4. The other emission levels were very low against the limit.
5. " * ": Fundamental frequency.
6. " # ": The radiated frequency is out of the restricted band.

RF Mode	TX 802.11a	Channel	CH 48 : 5240 MHz
Frequency Range	1GHz ~ 40GHz	Detector Function	Peak (PK) Average (AV)

Antenna Polarity & Test Distance : Horizontal at 3 m

No	Frequency (MHz)	Emission Level (dBuV/m)	Limit (dBuV/m)	Margin (dB)	Antenna Height (m)	Table Angle (Degree)	Raw Value (dBuV)	Correction Factor (dB/m)
1	*5240.00	120.1 PK			1.00 H	1	79.1	41.0
2	*5240.00	111.0 AV			1.00 H	1	70.0	41.0
3	5350.00	57.7 PK	74.0	-16.3	1.50 H	1	54.8	2.9
4	5350.00	45.6 AV	54.0	-8.4	1.50 H	1	42.7	2.9
5	#10480.00	56.1 PK	68.2	-12.1	1.79 H	231	48.0	8.1

Antenna Polarity & Test Distance : Vertical at 3 m

No	Frequency (MHz)	Emission Level (dBuV/m)	Limit (dBuV/m)	Margin (dB)	Antenna Height (m)	Table Angle (Degree)	Raw Value (dBuV)	Correction Factor (dB/m)
1	*5240.00	117.5 PK			2.90 V	169	76.5	41.0
2	*5240.00	107.8 AV			2.90 V	169	66.8	41.0
3	5350.00	57.6 PK	74.0	-16.4	2.90 V	169	54.7	2.9
4	5350.00	45.3 AV	54.0	-8.7	2.90 V	169	42.4	2.9
5	#10480.00	55.7 PK	68.2	-12.5	1.61 V	180	47.6	8.1

Remarks:

1. Emission Level(dBuV/m) = Raw Value(dBuV) + Correction Factor(dB/m)
2. Correction Factor(dB/m) = Antenna Factor(dB/m) + Cable Factor(dB) – Pre-Amplifier Factor(dB)
3. Margin value = Emission Level – Limit value
4. The other emission levels were very low against the limit.
5. " * " : Fundamental frequency.
6. " # " : The radiated frequency is out of the restricted band.

RF Mode	TX 802.11a	Channel	CH 52 : 5260 MHz
Frequency Range	1GHz ~ 40GHz	Detector Function	Peak (PK) Average (AV)

Antenna Polarity & Test Distance : Horizontal at 3 m

No	Frequency (MHz)	Emission Level (dBuV/m)	Limit (dBuV/m)	Margin (dB)	Antenna Height (m)	Table Angle (Degree)	Raw Value (dBuV)	Correction Factor (dB/m)
1	5150.00	56.9 PK	74.0	-17.1	1.34 H	2	54.1	2.8
2	5150.00	45.0 AV	54.0	-9.0	1.34 H	2	42.2	2.8
3	*5260.00	119.9 PK			1.34 H	2	79.0	40.9
4	*5260.00	110.7 AV			1.34 H	2	69.8	40.9
5	#10520.00	55.1 PK	68.2	-13.1	1.80 H	231	46.9	8.2

Antenna Polarity & Test Distance : Vertical at 3 m

No	Frequency (MHz)	Emission Level (dBuV/m)	Limit (dBuV/m)	Margin (dB)	Antenna Height (m)	Table Angle (Degree)	Raw Value (dBuV)	Correction Factor (dB/m)
1	5150.00	57.4 PK	74.0	-16.6	3.03 V	174	54.6	2.8
2	5150.00	45.0 AV	54.0	-9.0	3.03 V	174	42.2	2.8
3	*5260.00	116.8 PK			3.03 V	174	75.9	40.9
4	*5260.00	107.1 AV			3.03 V	174	66.2	40.9
5	#10520.00	54.7 PK	68.2	-13.5	1.61 V	182	46.5	8.2

Remarks:

1. Emission Level(dBuV/m) = Raw Value(dBuV) + Correction Factor(dB/m)
2. Correction Factor(dB/m) = Antenna Factor(dB/m) + Cable Factor(dB) – Pre-Amplifier Factor(dB)
3. Margin value = Emission Level – Limit value
4. The other emission levels were very low against the limit.
5. " * " : Fundamental frequency.
6. " # " : The radiated frequency is out of the restricted band.

RF Mode	TX 802.11a	Channel	CH 60 : 5300 MHz
Frequency Range	1GHz ~ 40GHz	Detector Function	Peak (PK) Average (AV)

Antenna Polarity & Test Distance : Horizontal at 3 m								
No	Frequency (MHz)	Emission Level (dBuV/m)	Limit (dBuV/m)	Margin (dB)	Antenna Height (m)	Table Angle (Degree)	Raw Value (dBuV)	Correction Factor (dB/m)
1	*5300.00	120.0 PK			1.21 H	1	79.0	41.0
2	*5300.00	110.8 AV			1.21 H	1	69.8	41.0
3	10600.00	55.1 PK	74.0	-18.9	1.75 H	221	47.0	8.1
4	10600.00	42.8 AV	54.0	-11.2	1.75 H	221	34.7	8.1
Antenna Polarity & Test Distance : Vertical at 3 m								
No	Frequency (MHz)	Emission Level (dBuV/m)	Limit (dBuV/m)	Margin (dB)	Antenna Height (m)	Table Angle (Degree)	Raw Value (dBuV)	Correction Factor (dB/m)
1	*5300.00	117.0 PK			2.97 V	169	76.0	41.0
2	*5300.00	107.5 AV			2.97 V	169	66.5	41.0
3	10600.00	54.6 PK	74.0	-19.4	1.52 V	175	46.5	8.1
4	10600.00	42.2 AV	54.0	-11.8	1.52 V	175	34.1	8.1

Remarks:

1. Emission Level(dBuV/m) = Raw Value(dBuV) + Correction Factor(dB/m)
2. Correction Factor(dB/m) = Antenna Factor(dB/m) + Cable Factor(dB) – Pre-Amplifier Factor(dB)
3. Margin value = Emission Level – Limit value
4. The other emission levels were very low against the limit.
5. " * ": Fundamental frequency.

RF Mode	TX 802.11a	Channel	CH 64 : 5320 MHz
Frequency Range	1GHz ~ 40GHz	Detector Function	Peak (PK) Average (AV)

Antenna Polarity & Test Distance : Horizontal at 3 m

No	Frequency (MHz)	Emission Level (dBuV/m)	Limit (dBuV/m)	Margin (dB)	Antenna Height (m)	Table Angle (Degree)	Raw Value (dBuV)	Correction Factor (dB/m)
1	*5320.00	118.8 PK			1.31 H	3	77.8	41.0
2	*5320.00	109.7 AV			1.31 H	3	68.7	41.0
3	5350.00	68.9 PK	74.0	-5.1	1.31 H	3	66.0	2.9
4	5350.00	52.4 AV	54.0	-1.6	1.31 H	3	49.5	2.9
5	10640.00	55.2 PK	74.0	-18.8	1.77 H	225	47.1	8.1
6	10640.00	42.6 AV	54.0	-11.4	1.77 H	225	34.5	8.1

Antenna Polarity & Test Distance : Vertical at 3 m

No	Frequency (MHz)	Emission Level (dBuV/m)	Limit (dBuV/m)	Margin (dB)	Antenna Height (m)	Table Angle (Degree)	Raw Value (dBuV)	Correction Factor (dB/m)
1	*5320.00	118.1 PK			2.93 V	173	77.1	41.0
2	*5320.00	107.9 AV			2.93 V	173	66.9	41.0
3	5350.00	67.7 PK	74.0	-6.3	2.93 V	173	64.8	2.9
4	5350.00	51.2 AV	54.0	-2.8	2.93 V	173	48.3	2.9
5	10640.00	54.8 PK	74.0	-19.2	1.72 V	177	46.7	8.1
6	10640.00	42.1 AV	54.0	-11.9	1.72 V	177	34.0	8.1

Remarks:

1. Emission Level(dBuV/m) = Raw Value(dBuV) + Correction Factor(dB/m)
2. Correction Factor(dB/m) = Antenna Factor(dB/m) + Cable Factor(dB) – Pre-Amplifier Factor(dB)
3. Margin value = Emission Level – Limit value
4. The other emission levels were very low against the limit.
5. " * ": Fundamental frequency.

RF Mode	TX 802.11a	Channel	CH 100 : 5500 MHz
Frequency Range	1GHz ~ 40GHz	Detector Function	Peak (PK) Average (AV)

Antenna Polarity & Test Distance : Horizontal at 3 m

No	Frequency (MHz)	Emission Level (dBuV/m)	Limit (dBuV/m)	Margin (dB)	Antenna Height (m)	Table Angle (Degree)	Raw Value (dBuV)	Correction Factor (dB/m)
1	5460.00	64.4 PK	74.0	-9.6	1.47 H	2	61.2	3.2
2	5460.00	46.9 AV	54.0	-7.1	1.47 H	2	43.7	3.2
3	#5470.00	67.2 PK	68.2	-1.0	1.47 H	2	64.0	3.2
4	*5500.00	115.6 PK			1.47 H	2	74.2	41.4
5	*5500.00	106.4 AV			1.47 H	2	65.0	41.4
6	11000.00	55.7 PK	74.0	-18.3	1.92 H	225	47.5	8.2
7	11000.00	43.2 AV	54.0	-10.8	1.92 H	225	35.0	8.2

Antenna Polarity & Test Distance : Vertical at 3 m

No	Frequency (MHz)	Emission Level (dBuV/m)	Limit (dBuV/m)	Margin (dB)	Antenna Height (m)	Table Angle (Degree)	Raw Value (dBuV)	Correction Factor (dB/m)
1	5460.00	58.9 PK	74.0	-15.1	2.79 V	173	55.7	3.2
2	5460.00	47.0 AV	54.0	-7.0	2.79 V	173	43.8	3.2
3	#5470.00	63.5 PK	68.2	-4.7	2.79 V	173	60.3	3.2
4	*5500.00	115.4 PK			2.79 V	173	74.0	41.4
5	*5500.00	106.1 AV			2.79 V	173	64.7	41.4
6	11000.00	55.2 PK	74.0	-18.8	1.77 V	179	47.0	8.2
7	11000.00	42.7 AV	54.0	-11.3	1.77 V	179	34.5	8.2

Remarks:

1. Emission Level(dBuV/m) = Raw Value(dBuV) + Correction Factor(dB/m)
2. Correction Factor(dB/m) = Antenna Factor(dB/m) + Cable Factor(dB) – Pre-Amplifier Factor(dB)
3. Margin value = Emission Level – Limit value
4. The other emission levels were very low against the limit.
5. " * ": Fundamental frequency.
6. " # ": The radiated frequency is out of the restricted band.

RF Mode	TX 802.11a	Channel	CH 116 : 5580 MHz
Frequency Range	1GHz ~ 40GHz	Detector Function	Peak (PK) Average (AV)

Antenna Polarity & Test Distance : Horizontal at 3 m								
No	Frequency (MHz)	Emission Level (dBuV/m)	Limit (dBuV/m)	Margin (dB)	Antenna Height (m)	Table Angle (Degree)	Raw Value (dBuV)	Correction Factor (dB/m)
1	*5580.00	119.1 PK			1.34 H	2	77.3	41.8
2	*5580.00	109.4 AV			1.34 H	2	67.6	41.8
3	11160.00	56.0 PK	74.0	-18.0	1.87 H	223	47.8	8.2
4	11160.00	43.5 AV	54.0	-10.5	1.87 H	223	35.3	8.2
Antenna Polarity & Test Distance : Vertical at 3 m								
No	Frequency (MHz)	Emission Level (dBuV/m)	Limit (dBuV/m)	Margin (dB)	Antenna Height (m)	Table Angle (Degree)	Raw Value (dBuV)	Correction Factor (dB/m)
1	*5580.00	118.8 PK			2.96 V	174	77.0	41.8
2	*5580.00	109.2 AV			2.96 V	174	67.4	41.8
3	11160.00	55.5 PK	74.0	-18.5	1.75 V	177	47.3	8.2
4	11160.00	43.2 AV	54.0	-10.8	1.75 V	177	35.0	8.2

Remarks:

1. Emission Level(dBuV/m) = Raw Value(dBuV) + Correction Factor(dB/m)
2. Correction Factor(dB/m) = Antenna Factor(dB/m) + Cable Factor(dB) – Pre-Amplifier Factor(dB)
3. Margin value = Emission Level – Limit value
4. The other emission levels were very low against the limit.
5. " * ": Fundamental frequency.

RF Mode	TX 802.11a	Channel	CH 140 : 5700 MHz
Frequency Range	1GHz ~ 40GHz	Detector Function	Peak (PK) Average (AV)

Antenna Polarity & Test Distance : Horizontal at 3 m

No	Frequency (MHz)	Emission Level (dBuV/m)	Limit (dBuV/m)	Margin (dB)	Antenna Height (m)	Table Angle (Degree)	Raw Value (dBuV)	Correction Factor (dB/m)
1	*5700.00	115.0 PK			1.08 H	356	72.6	42.4
2	*5700.00	106.1 AV			1.08 H	356	63.7	42.4
3	#5725.00	66.8 PK	68.2	-1.4	1.08 H	356	62.4	4.4
4	11400.00	56.1 PK	74.0	-17.9	1.82 H	239	47.3	8.8
5	11400.00	43.9 AV	54.0	-10.1	1.82 H	239	35.1	8.8

Antenna Polarity & Test Distance : Vertical at 3 m

No	Frequency (MHz)	Emission Level (dBuV/m)	Limit (dBuV/m)	Margin (dB)	Antenna Height (m)	Table Angle (Degree)	Raw Value (dBuV)	Correction Factor (dB/m)
1	*5700.00	116.4 PK			2.81 V	172	74.0	42.4
2	*5700.00	107.1 AV			2.81 V	172	64.7	42.4
3	#5725.00	67.5 PK	68.2	-0.7	2.81 V	172	63.1	4.4
4	11400.00	55.8 PK	74.0	-18.2	1.65 V	185	47.0	8.8
5	11400.00	43.5 AV	54.0	-10.5	1.65 V	185	34.7	8.8

Remarks:

1. Emission Level(dBuV/m) = Raw Value(dBuV) + Correction Factor(dB/m)
2. Correction Factor(dB/m) = Antenna Factor(dB/m) + Cable Factor(dB) – Pre-Amplifier Factor(dB)
3. Margin value = Emission Level – Limit value
4. The other emission levels were very low against the limit.
5. " * ": Fundamental frequency.
6. " # ": The radiated frequency is out of the restricted band.

RF Mode	TX 802.11a	Channel	CH 144 : 5720 MHz
Frequency Range	1GHz ~ 40GHz	Detector Function	Peak (PK) Average (AV)

Antenna Polarity & Test Distance : Horizontal at 3 m

No	Frequency (MHz)	Emission Level (dBuV/m)	Limit (dBuV/m)	Margin (dB)	Antenna Height (m)	Table Angle (Degree)	Raw Value (dBuV)	Correction Factor (dB/m)
1	*5720.00	116.5 PK			1.06 H	9	74.1	42.4
2	*5720.00	106.9 AV			1.06 H	9	64.5	42.4
3	#5850.00	58.8 PK	68.2	-9.4	1.06 H	9	54.1	4.7
4	11440.00	56.2 PK	74.0	-17.8	1.85 H	221	47.4	8.8
5	11440.00	43.7 AV	54.0	-10.3	1.85 H	221	34.9	8.8

Antenna Polarity & Test Distance : Vertical at 3 m

No	Frequency (MHz)	Emission Level (dBuV/m)	Limit (dBuV/m)	Margin (dB)	Antenna Height (m)	Table Angle (Degree)	Raw Value (dBuV)	Correction Factor (dB/m)
1	*5720.00	117.7 PK			2.82 V	170	75.3	42.4
2	*5720.00	108.4 AV			2.82 V	170	66.0	42.4
3	#5850.00	58.9 PK	68.2	-9.3	2.82 V	170	54.2	4.7
4	11440.00	55.8 PK	74.0	-18.2	1.77 V	172	47.0	8.8
5	11440.00	43.6 AV	54.0	-10.4	1.77 V	172	34.8	8.8

Remarks:

1. Emission Level(dBuV/m) = Raw Value(dBuV) + Correction Factor(dB/m)
2. Correction Factor(dB/m) = Antenna Factor(dB/m) + Cable Factor(dB) – Pre-Amplifier Factor(dB)
3. Margin value = Emission Level – Limit value
4. The other emission levels were very low against the limit.
5. " * " : Fundamental frequency.
6. " # " : The radiated frequency is out of the restricted band.

RF Mode	TX 802.11a	Channel	CH 149 : 5745 MHz
Frequency Range	1GHz ~ 40GHz	Detector Function	Peak (PK) Average (AV)

Antenna Polarity & Test Distance : Horizontal at 3 m

No	Frequency (MHz)	Emission Level (dBuV/m)	Limit (dBuV/m)	Margin (dB)	Antenna Height (m)	Table Angle (Degree)	Raw Value (dBuV)	Correction Factor (dB/m)
1	#5650.00	57.1 PK	68.2	-11.1	2.25 H	219	52.9	4.2
2	*5745.00	117.9 PK			2.25 H	219	75.4	42.5
3	*5745.00	108.7 AV			2.25 H	219	66.2	42.5
4	#5945.20	55.8 PK	68.2	-12.4	2.25 H	219	51.0	4.8
5	11490.00	56.7 PK	74.0	-17.3	1.91 H	209	48.0	8.7
6	11490.00	44.5 AV	54.0	-9.5	1.91 H	209	35.8	8.7

Antenna Polarity & Test Distance : Vertical at 3 m

No	Frequency (MHz)	Emission Level (dBuV/m)	Limit (dBuV/m)	Margin (dB)	Antenna Height (m)	Table Angle (Degree)	Raw Value (dBuV)	Correction Factor (dB/m)
1	#5638.00	57.5 PK	68.2	-10.7	2.75 V	177	53.5	4.0
2	*5745.00	117.0 PK			2.75 V	177	74.5	42.5
3	*5745.00	107.6 AV			2.75 V	177	65.1	42.5
4	#5959.20	59.0 PK	68.2	-9.2	2.75 V	177	54.2	4.8
5	11490.00	56.9 PK	74.0	-17.1	1.82 V	193	48.2	8.7
6	11490.00	44.7 AV	54.0	-9.3	1.82 V	193	36.0	8.7

Remarks:

1. Emission Level(dBuV/m) = Raw Value(dBuV) + Correction Factor(dB/m)
2. Correction Factor(dB/m) = Antenna Factor(dB/m) + Cable Factor(dB) – Pre-Amplifier Factor(dB)
3. Margin value = Emission Level – Limit value
4. The other emission levels were very low against the limit.
5. " * " : Fundamental frequency.
6. " # " : The radiated frequency is out of the restricted band.

RF Mode	TX 802.11a	Channel	CH 157 : 5785 MHz
Frequency Range	1GHz ~ 40GHz	Detector Function	Peak (PK) Average (AV)

Antenna Polarity & Test Distance : Horizontal at 3 m

No	Frequency (MHz)	Emission Level (dBuV/m)	Limit (dBuV/m)	Margin (dB)	Antenna Height (m)	Table Angle (Degree)	Raw Value (dBuV)	Correction Factor (dB/m)
1	#5600.40	55.1 PK	68.2	-13.1	2.28 H	224	51.3	3.8
2	*5785.00	119.1 PK			2.28 H	224	76.5	42.6
3	*5785.00	109.7 AV			2.28 H	224	67.1	42.6
4	#5933.60	59.5 PK	68.2	-8.7	2.28 H	224	54.7	4.8
5	11570.00	56.9 PK	74.0	-17.1	1.97 H	215	48.3	8.6
6	11570.00	44.7 AV	54.0	-9.3	1.97 H	215	36.1	8.6

Antenna Polarity & Test Distance : Vertical at 3 m

No	Frequency (MHz)	Emission Level (dBuV/m)	Limit (dBuV/m)	Margin (dB)	Antenna Height (m)	Table Angle (Degree)	Raw Value (dBuV)	Correction Factor (dB/m)
1	#5644.80	58.8 PK	68.2	-9.4	2.72 V	177	54.7	4.1
2	*5785.00	116.8 PK			2.72 V	177	74.2	42.6
3	*5785.00	107.4 AV			2.72 V	177	64.8	42.6
4	#5980.40	60.2 PK	68.2	-8.0	2.72 V	177	55.4	4.8
5	11570.00	56.7 PK	74.0	-17.3	1.82 V	185	48.1	8.6
6	11570.00	44.5 AV	54.0	-9.5	1.82 V	185	35.9	8.6

Remarks:

1. Emission Level(dBuV/m) = Raw Value(dBuV) + Correction Factor(dB/m)
2. Correction Factor(dB/m) = Antenna Factor(dB/m) + Cable Factor(dB) – Pre-Amplifier Factor(dB)
3. Margin value = Emission Level – Limit value
4. The other emission levels were very low against the limit.
5. " * " : Fundamental frequency.
6. " # " : The radiated frequency is out of the restricted band.

RF Mode	TX 802.11a	Channel	CH 165 : 5825 MHz
Frequency Range	1GHz ~ 40GHz	Detector Function	Peak (PK) Average (AV)

Antenna Polarity & Test Distance : Horizontal at 3 m								
No	Frequency (MHz)	Emission Level (dBuV/m)	Limit (dBuV/m)	Margin (dB)	Antenna Height (m)	Table Angle (Degree)	Raw Value (dBuV)	Correction Factor (dB/m)
1	#5615.20	56.6 PK	68.2	-11.6	2.36 H	218	52.7	3.9
2	*5825.00	119.9 PK			2.36 H	218	77.2	42.7
3	*5825.00	109.3 AV			2.36 H	218	66.6	42.7
4	#5990.40	59.2 PK	68.2	-9.0	2.36 H	218	54.3	4.9
5	11650.00	56.9 PK	74.0	-17.1	1.85 H	213	48.2	8.7
6	11650.00	45.0 AV	54.0	-9.0	1.85 H	213	36.3	8.7
Antenna Polarity & Test Distance : Vertical at 3 m								
No	Frequency (MHz)	Emission Level (dBuV/m)	Limit (dBuV/m)	Margin (dB)	Antenna Height (m)	Table Angle (Degree)	Raw Value (dBuV)	Correction Factor (dB/m)
1	#5644.00	58.9 PK	68.2	-9.3	2.64 V	151	54.8	4.1
2	*5825.00	116.6 PK			2.64 V	151	73.9	42.7
3	*5825.00	106.6 AV			2.64 V	151	63.9	42.7
4	#5997.60	58.5 PK	68.2	-9.7	2.64 V	151	53.6	4.9
5	11650.00	56.7 PK	74.0	-17.3	1.79 V	175	48.0	8.7
6	11650.00	44.8 AV	54.0	-9.2	1.79 V	175	36.1	8.7

Remarks:

1. Emission Level(dBuV/m) = Raw Value(dBuV) + Correction Factor(dB/m)
2. Correction Factor(dB/m) = Antenna Factor(dB/m) + Cable Factor(dB) – Pre-Amplifier Factor(dB)
3. Margin value = Emission Level – Limit value
4. The other emission levels were very low against the limit.
5. " * " : Fundamental frequency.
6. " # " : The radiated frequency is out of the restricted band.

802.11ac (VHT20)

RF Mode	TX 802.11ac (VHT20)	Channel	CH 36 : 5180 MHz
Frequency Range	1GHz ~ 40GHz	Detector Function	Peak (PK) Average (AV)

Antenna Polarity & Test Distance : Horizontal at 3 m								
No	Frequency (MHz)	Emission Level (dBuV/m)	Limit (dBuV/m)	Margin (dB)	Antenna Height (m)	Table Angle (Degree)	Raw Value (dBuV)	Correction Factor (dB/m)
1	5150.00	67.2 PK	74.0	-6.8	1.31 H	7	64.4	2.8
2	5150.00	53.6 AV	54.0	-0.4	1.31 H	7	50.8	2.8
3	*5180.00	120.8 PK			1.31 H	7	79.8	41.0
4	*5180.00	111.3 AV			1.31 H	7	70.3	41.0
5	#10360.00	56.3 PK	68.2	-11.9	1.85 H	253	48.1	8.2

Antenna Polarity & Test Distance : Vertical at 3 m								
No	Frequency (MHz)	Emission Level (dBuV/m)	Limit (dBuV/m)	Margin (dB)	Antenna Height (m)	Table Angle (Degree)	Raw Value (dBuV)	Correction Factor (dB/m)
1	5150.00	65.2 PK	74.0	-8.8	2.88 V	167	62.4	2.8
2	5150.00	50.3 AV	54.0	-3.7	2.88 V	167	47.5	2.8
3	*5180.00	115.4 PK			2.88 V	167	74.4	41.0
4	*5180.00	106.8 AV			2.88 V	167	65.8	41.0
5	#10360.00	54.4 PK	68.2	-13.8	1.59 V	177	46.2	8.2

Remarks:

1. Emission Level(dBuV/m) = Raw Value(dBuV) + Correction Factor(dB/m)
2. Correction Factor(dB/m) = Antenna Factor(dB/m) + Cable Factor(dB) – Pre-Amplifier Factor(dB)
3. Margin value = Emission Level – Limit value
4. The other emission levels were very low against the limit.
5. " * ": Fundamental frequency.
6. " # ": The radiated frequency is out of the restricted band.

RF Mode	TX 802.11ac (VHT20)	Channel	CH 40 : 5200 MHz
Frequency Range	1GHz ~ 40GHz	Detector Function	Peak (PK) Average (AV)

Antenna Polarity & Test Distance : Horizontal at 3 m								
No	Frequency (MHz)	Emission Level (dBuV/m)	Limit (dBuV/m)	Margin (dB)	Antenna Height (m)	Table Angle (Degree)	Raw Value (dBuV)	Correction Factor (dB/m)
1	*5200.00	119.1 PK			1.37 H	1	116.2	2.9
2	*5200.00	109.6 AV			1.37 H	1	106.7	2.9
3	#10400.00	55.6 PK	68.2	-12.6	1.77 H	242	47.5	8.1
Antenna Polarity & Test Distance : Vertical at 3 m								
No	Frequency (MHz)	Emission Level (dBuV/m)	Limit (dBuV/m)	Margin (dB)	Antenna Height (m)	Table Angle (Degree)	Raw Value (dBuV)	Correction Factor (dB/m)
1	*5200.00	117.6 PK			2.81 V	165	76.6	41.0
2	*5200.00	107.7 AV			2.81 V	165	66.7	41.0
3	#10400.00	55.2 PK	68.2	-13.0	1.62 V	169	47.1	8.1

Remarks:

1. Emission Level(dBuV/m) = Raw Value(dBuV) + Correction Factor(dB/m)
2. Correction Factor(dB/m) = Antenna Factor(dB/m) + Cable Factor(dB) – Pre-Amplifier Factor(dB)
3. Margin value = Emission Level – Limit value
4. The other emission levels were very low against the limit.
5. " * ": Fundamental frequency.
6. " # ": The radiated frequency is out of the restricted band.

RF Mode	TX 802.11ac (VHT20)	Channel	CH 48 : 5240 MHz
Frequency Range	1GHz ~ 40GHz	Detector Function	Peak (PK) Average (AV)

Antenna Polarity & Test Distance : Horizontal at 3 m

No	Frequency (MHz)	Emission Level (dBuV/m)	Limit (dBuV/m)	Margin (dB)	Antenna Height (m)	Table Angle (Degree)	Raw Value (dBuV)	Correction Factor (dB/m)
1	*5240.00	120.8 PK			1.68 H	7	79.8	41.0
2	*5240.00	111.3 AV			1.68 H	7	70.3	41.0
3	5350.00	57.1 PK	74.0	-16.9	1.68 H	7	54.2	2.9
4	5350.00	45.4 AV	54.0	-8.6	1.68 H	7	42.5	2.9
5	#10480.00	55.9 PK	68.2	-12.3	1.75 H	231	47.8	8.1

Antenna Polarity & Test Distance : Vertical at 3 m

No	Frequency (MHz)	Emission Level (dBuV/m)	Limit (dBuV/m)	Margin (dB)	Antenna Height (m)	Table Angle (Degree)	Raw Value (dBuV)	Correction Factor (dB/m)
1	*5240.00	116.2 PK			2.97 V	173	75.2	41.0
2	*5240.00	106.3 AV			2.97 V	173	65.3	41.0
3	5350.00	57.1 PK	74.0	-16.9	2.97 V	173	54.2	2.9
4	5350.00	45.2 AV	54.0	-8.8	2.97 V	173	42.3	2.9
5	#10480.00	55.4 PK	68.2	-12.8	1.61 V	175	47.3	8.1

Remarks:

1. Emission Level(dBuV/m) = Raw Value(dBuV) + Correction Factor(dB/m)
2. Correction Factor(dB/m) = Antenna Factor(dB/m) + Cable Factor(dB) – Pre-Amplifier Factor(dB)
3. Margin value = Emission Level – Limit value
4. The other emission levels were very low against the limit.
5. " * " : Fundamental frequency.
6. " # " : The radiated frequency is out of the restricted band.

RF Mode	TX 802.11ac (VHT20)	Channel	CH 52 : 5260 MHz
Frequency Range	1GHz ~ 40GHz	Detector Function	Peak (PK) Average (AV)

Antenna Polarity & Test Distance : Horizontal at 3 m

No	Frequency (MHz)	Emission Level (dBuV/m)	Limit (dBuV/m)	Margin (dB)	Antenna Height (m)	Table Angle (Degree)	Raw Value (dBuV)	Correction Factor (dB/m)
1	5150.00	58.1 PK	74.0	-15.9	1.46 H	8	55.3	2.8
2	5150.00	45.2 AV	54.0	-8.8	1.46 H	8	42.4	2.8
3	*5260.00	120.6 PK			1.46 H	8	79.7	40.9
4	*5260.00	111.0 AV			1.46 H	8	70.1	40.9
5	#10520.00	55.6 PK	68.2	-12.6	1.75 H	220	47.4	8.2

Antenna Polarity & Test Distance : Vertical at 3 m

No	Frequency (MHz)	Emission Level (dBuV/m)	Limit (dBuV/m)	Margin (dB)	Antenna Height (m)	Table Angle (Degree)	Raw Value (dBuV)	Correction Factor (dB/m)
1	5150.00	57.0 PK	74.0	-17.0	2.87 V	169	54.2	2.8
2	5150.00	44.9 AV	54.0	-9.1	2.87 V	169	42.1	2.8
3	*5260.00	116.9 PK			2.87 V	169	76.0	40.9
4	*5260.00	106.8 AV			2.87 V	169	65.9	40.9
5	#10520.00	55.1 PK	68.2	-13.1	1.65 V	172	46.9	8.2

Remarks:

1. Emission Level(dBuV/m) = Raw Value(dBuV) + Correction Factor(dB/m)
2. Correction Factor(dB/m) = Antenna Factor(dB/m) + Cable Factor(dB) – Pre-Amplifier Factor(dB)
3. Margin value = Emission Level – Limit value
4. The other emission levels were very low against the limit.
5. " * " : Fundamental frequency.
6. " # " : The radiated frequency is out of the restricted band.

RF Mode	TX 802.11ac (VHT20)	Channel	CH 60 : 5300 MHz
Frequency Range	1GHz ~ 40GHz	Detector Function	Peak (PK) Average (AV)

Antenna Polarity & Test Distance : Horizontal at 3 m

No	Frequency (MHz)	Emission Level (dBuV/m)	Limit (dBuV/m)	Margin (dB)	Antenna Height (m)	Table Angle (Degree)	Raw Value (dBuV)	Correction Factor (dB/m)
1	*5300.00	119.7 PK			1.41 H	6	78.7	41.0
2	*5300.00	110.6 AV			1.41 H	6	69.6	41.0
3	10600.00	55.3 PK	74.0	-18.7	1.79 H	229	47.2	8.1
4	10600.00	42.7 AV	54.0	-11.3	1.79 H	229	34.6	8.1

Antenna Polarity & Test Distance : Vertical at 3 m

No	Frequency (MHz)	Emission Level (dBuV/m)	Limit (dBuV/m)	Margin (dB)	Antenna Height (m)	Table Angle (Degree)	Raw Value (dBuV)	Correction Factor (dB/m)
1	*5300.00	116.5 PK			2.97 V	169	75.5	41.0
2	*5300.00	107.2 AV			2.97 V	169	66.2	41.0
3	10600.00	54.9 PK	74.0	-19.1	1.68 V	179	46.8	8.1
4	10600.00	42.3 AV	54.0	-11.7	1.68 V	179	34.2	8.1

Remarks:

1. Emission Level(dBuV/m) = Raw Value(dBuV) + Correction Factor(dB/m)
2. Correction Factor(dB/m) = Antenna Factor(dB/m) + Cable Factor(dB) – Pre-Amplifier Factor(dB)
3. Margin value = Emission Level – Limit value
4. The other emission levels were very low against the limit.
5. " * ": Fundamental frequency.

RF Mode	TX 802.11ac (VHT20)	Channel	CH 64 : 5320 MHz
Frequency Range	1GHz ~ 40GHz	Detector Function	Peak (PK) Average (AV)

Antenna Polarity & Test Distance : Horizontal at 3 m

No	Frequency (MHz)	Emission Level (dBuV/m)	Limit (dBuV/m)	Margin (dB)	Antenna Height (m)	Table Angle (Degree)	Raw Value (dBuV)	Correction Factor (dB/m)
1	*5320.00	120.0 PK			1.30 H	7	79.0	41.0
2	*5320.00	110.6 AV			1.30 H	7	69.6	41.0
3	5350.00	69.8 PK	74.0	-4.2	1.30 H	7	66.9	2.9
4	5350.00	53.1 AV	54.0	-0.9	1.30 H	7	50.2	2.9
5	10640.00	55.6 PK	74.0	-18.4	1.82 H	231	47.5	8.1
6	10640.00	42.9 AV	54.0	-11.1	1.82 H	231	34.8	8.1

Antenna Polarity & Test Distance : Vertical at 3 m

No	Frequency (MHz)	Emission Level (dBuV/m)	Limit (dBuV/m)	Margin (dB)	Antenna Height (m)	Table Angle (Degree)	Raw Value (dBuV)	Correction Factor (dB/m)
1	*5320.00	117.0 PK			2.86 V	173	76.0	41.0
2	*5320.00	107.9 AV			2.86 V	173	66.9	41.0
3	5350.00	65.9 PK	74.0	-8.1	2.86 V	173	63.0	2.9
4	5350.00	52.1 AV	54.0	-1.9	2.86 V	173	49.2	2.9
5	10640.00	55.2 PK	74.0	-18.8	1.66 V	177	47.1	8.1
6	10640.00	42.3 AV	54.0	-11.7	1.66 V	177	34.2	8.1

Remarks:

1. Emission Level(dBuV/m) = Raw Value(dBuV) + Correction Factor(dB/m)
2. Correction Factor(dB/m) = Antenna Factor(dB/m) + Cable Factor(dB) – Pre-Amplifier Factor(dB)
3. Margin value = Emission Level – Limit value
4. The other emission levels were very low against the limit.
5. " * ": Fundamental frequency.

RF Mode	TX 802.11ac (VHT20)	Channel	CH 100 : 5500 MHz
Frequency Range	1GHz ~ 40GHz	Detector Function	Peak (PK) Average (AV)

Antenna Polarity & Test Distance : Horizontal at 3 m								
No	Frequency (MHz)	Emission Level (dBuV/m)	Limit (dBuV/m)	Margin (dB)	Antenna Height (m)	Table Angle (Degree)	Raw Value (dBuV)	Correction Factor (dB/m)
1	5460.00	63.3 PK	74.0	-10.7	1.08 H	21	60.1	3.2
2	5460.00	46.8 AV	54.0	-7.2	1.08 H	21	43.6	3.2
3	#5470.00	67.9 PK	68.2	-0.3	1.08 H	21	64.7	3.2
4	*5500.00	116.1 PK			1.08 H	21	74.7	41.4
5	*5500.00	106.3 AV			1.08 H	21	64.9	41.4
6	11000.00	55.9 PK	74.0	-18.1	1.87 H	220	47.7	8.2
7	11000.00	43.4 AV	54.0	-10.6	1.87 H	220	35.2	8.2

Antenna Polarity & Test Distance : Vertical at 3 m								
No	Frequency (MHz)	Emission Level (dBuV/m)	Limit (dBuV/m)	Margin (dB)	Antenna Height (m)	Table Angle (Degree)	Raw Value (dBuV)	Correction Factor (dB/m)
1	5460.00	62.3 PK	74.0	-11.7	2.79 V	177	59.1	3.2
2	5460.00	46.5 AV	54.0	-7.5	2.79 V	177	43.3	3.2
3	#5470.00	66.6 PK	68.2	-1.6	2.79 V	177	63.4	3.2
4	*5500.00	114.7 PK			2.79 V	177	73.3	41.4
5	*5500.00	105.4 AV			2.79 V	177	64.0	41.4
6	11000.00	55.5 PK	74.0	-18.5	1.65 V	174	47.3	8.2
7	11000.00	43.0 AV	54.0	-11.0	1.65 V	174	34.8	8.2

Remarks:

1. Emission Level(dBuV/m) = Raw Value(dBuV) + Correction Factor(dB/m)
2. Correction Factor(dB/m) = Antenna Factor(dB/m) + Cable Factor(dB) – Pre-Amplifier Factor(dB)
3. Margin value = Emission Level – Limit value
4. The other emission levels were very low against the limit.
5. " * ": Fundamental frequency.
6. " # ": The radiated frequency is out of the restricted band.

RF Mode	TX 802.11ac (VHT20)	Channel	CH 116 : 5580 MHz
Frequency Range	1GHz ~ 40GHz	Detector Function	Peak (PK) Average (AV)

Antenna Polarity & Test Distance : Horizontal at 3 m								
No	Frequency (MHz)	Emission Level (dBuV/m)	Limit (dBuV/m)	Margin (dB)	Antenna Height (m)	Table Angle (Degree)	Raw Value (dBuV)	Correction Factor (dB/m)
1	*5580.00	118.2 PK			1.15 H	20	76.4	41.8
2	*5580.00	108.8 AV			1.15 H	20	67.0	41.8
3	11160.00	55.4 PK	74.0	-18.6	1.90 H	229	47.2	8.2
4	11160.00	43.0 AV	54.0	-11.0	1.90 H	229	34.8	8.2
Antenna Polarity & Test Distance : Vertical at 3 m								
No	Frequency (MHz)	Emission Level (dBuV/m)	Limit (dBuV/m)	Margin (dB)	Antenna Height (m)	Table Angle (Degree)	Raw Value (dBuV)	Correction Factor (dB/m)
1	*5580.00	118.4 PK			2.85 V	176	76.6	41.8
2	*5580.00	108.9 AV			2.85 V	176	67.1	41.8
3	11160.00	55.1 PK	74.0	-18.9	1.69 V	175	46.9	8.2
4	11160.00	42.7 AV	54.0	-11.3	1.69 V	175	34.5	8.2

Remarks:

1. Emission Level(dBuV/m) = Raw Value(dBuV) + Correction Factor(dB/m)
2. Correction Factor(dB/m) = Antenna Factor(dB/m) + Cable Factor(dB) – Pre-Amplifier Factor(dB)
3. Margin value = Emission Level – Limit value
4. The other emission levels were very low against the limit.
5. " * ": Fundamental frequency.

RF Mode	TX 802.11ac (VHT20)	Channel	CH 140 : 5700 MHz
Frequency Range	1GHz ~ 40GHz	Detector Function	Peak (PK) Average (AV)

Antenna Polarity & Test Distance : Horizontal at 3 m

No	Frequency (MHz)	Emission Level (dBuV/m)	Limit (dBuV/m)	Margin (dB)	Antenna Height (m)	Table Angle (Degree)	Raw Value (dBuV)	Correction Factor (dB/m)
1	*5700.00	114.0 PK			1.18 H	1	71.6	42.4
2	*5700.00	105.0 AV			1.18 H	1	62.6	42.4
3	#5725.00	65.0 PK	68.2	-3.2	1.18 H	1	60.6	4.4
4	11400.00	56.0 PK	74.0	-18.0	1.93 H	228	47.2	8.8
5	11400.00	43.6 AV	54.0	-10.4	1.93 H	228	34.8	8.8

Antenna Polarity & Test Distance : Vertical at 3 m

No	Frequency (MHz)	Emission Level (dBuV/m)	Limit (dBuV/m)	Margin (dB)	Antenna Height (m)	Table Angle (Degree)	Raw Value (dBuV)	Correction Factor (dB/m)
1	*5700.00	114.8 PK			2.71 V	176	72.4	42.4
2	*5700.00	105.4 AV			2.71 V	176	63.0	42.4
3	#5725.00	67.8 PK	68.2	-0.4	2.71 V	176	63.4	4.4
4	11400.00	55.6 PK	74.0	-18.4	1.71 V	175	46.8	8.8
5	11400.00	43.3 AV	54.0	-10.7	1.71 V	175	34.5	8.8

Remarks:

1. Emission Level(dBuV/m) = Raw Value(dBuV) + Correction Factor(dB/m)
2. Correction Factor(dB/m) = Antenna Factor(dB/m) + Cable Factor(dB) – Pre-Amplifier Factor(dB)
3. Margin value = Emission Level – Limit value
4. The other emission levels were very low against the limit.
5. " * " : Fundamental frequency.
6. " # " : The radiated frequency is out of the restricted band.

RF Mode	TX 802.11ac (VHT20)	Channel	CH 144 : 5720 MHz
Frequency Range	1GHz ~ 40GHz	Detector Function	Peak (PK) Average (AV)

Antenna Polarity & Test Distance : Horizontal at 3 m

No	Frequency (MHz)	Emission Level (dBuV/m)	Limit (dBuV/m)	Margin (dB)	Antenna Height (m)	Table Angle (Degree)	Raw Value (dBuV)	Correction Factor (dB/m)
1	*5720.00	116.1 PK			1.26 H	15	73.7	42.4
2	*5720.00	106.7 AV			1.26 H	15	64.3	42.4
3	#5850.00	58.5 PK	68.2	-9.7	1.26 H	15	53.8	4.7
4	11440.00	55.9 PK	74.0	-18.1	1.79 H	219	47.1	8.8
5	11440.00	43.6 AV	54.0	-10.4	1.79 H	219	34.8	8.8

Antenna Polarity & Test Distance : Vertical at 3 m

No	Frequency (MHz)	Emission Level (dBuV/m)	Limit (dBuV/m)	Margin (dB)	Antenna Height (m)	Table Angle (Degree)	Raw Value (dBuV)	Correction Factor (dB/m)
1	*5720.00	117.4 PK			2.69 V	171	75.0	42.4
2	*5720.00	107.8 AV			2.69 V	171	65.4	42.4
3	#5850.00	58.7 PK	68.2	-9.5	2.69 V	171	54.0	4.7
4	11440.00	55.5 PK	74.0	-18.5	1.72 V	179	46.7	8.8
5	11440.00	43.1 AV	54.0	-10.9	1.72 V	179	34.3	8.8

Remarks:

1. Emission Level(dBuV/m) = Raw Value(dBuV) + Correction Factor(dB/m)
2. Correction Factor(dB/m) = Antenna Factor(dB/m) + Cable Factor(dB) – Pre-Amplifier Factor(dB)
3. Margin value = Emission Level – Limit value
4. The other emission levels were very low against the limit.
5. " * " : Fundamental frequency.
6. " # " : The radiated frequency is out of the restricted band.

RF Mode	TX 802.11ac (VHT20)	Channel	CH 149 : 5745 MHz
Frequency Range	1GHz ~ 40GHz	Detector Function	Peak (PK) Average (AV)

Antenna Polarity & Test Distance : Horizontal at 3 m

No	Frequency (MHz)	Emission Level (dBuV/m)	Limit (dBuV/m)	Margin (dB)	Antenna Height (m)	Table Angle (Degree)	Raw Value (dBuV)	Correction Factor (dB/m)
1	#5604.80	57.9 PK	68.2	-10.3	2.51 H	219	54.1	3.8
2	*5745.00	119.2 PK			2.51 H	219	76.7	42.5
3	*5745.00	110.3 AV			2.51 H	219	67.8	42.5
4	#5954.00	59.0 PK	68.2	-9.2	2.51 H	219	54.2	4.8
5	11490.00	57.2 PK	74.0	-16.8	1.86 H	222	48.5	8.7
6	11490.00	45.0 AV	54.0	-9.0	1.86 H	222	36.3	8.7

Antenna Polarity & Test Distance : Vertical at 3 m

No	Frequency (MHz)	Emission Level (dBuV/m)	Limit (dBuV/m)	Margin (dB)	Antenna Height (m)	Table Angle (Degree)	Raw Value (dBuV)	Correction Factor (dB/m)
1	#5626.80	57.9 PK	68.2	-10.3	2.59 V	182	53.9	4.0
2	*5745.00	116.8 PK			2.59 V	182	74.3	42.5
3	*5745.00	107.2 AV			2.59 V	182	64.7	42.5
4	#5963.20	58.6 PK	68.2	-9.6	2.59 V	182	53.8	4.8
5	11490.00	56.8 PK	74.0	-17.2	1.86 V	175	48.1	8.7
6	11490.00	44.6 AV	54.0	-9.4	1.86 V	175	35.9	8.7

Remarks:

1. Emission Level(dBuV/m) = Raw Value(dBuV) + Correction Factor(dB/m)
2. Correction Factor(dB/m) = Antenna Factor(dB/m) + Cable Factor(dB) – Pre-Amplifier Factor(dB)
3. Margin value = Emission Level – Limit value
4. The other emission levels were very low against the limit.
5. " * " : Fundamental frequency.
6. " # " : The radiated frequency is out of the restricted band.

RF Mode	TX 802.11ac (VHT20)	Channel	CH 157 : 5785 MHz
Frequency Range	1GHz ~ 40GHz	Detector Function	Peak (PK) Average (AV)

Antenna Polarity & Test Distance : Horizontal at 3 m								
No	Frequency (MHz)	Emission Level (dBuV/m)	Limit (dBuV/m)	Margin (dB)	Antenna Height (m)	Table Angle (Degree)	Raw Value (dBuV)	Correction Factor (dB/m)
1	#5630.00	58.1 PK	68.2	-10.1	2.35 H	216	54.1	4.0
2	*5785.00	119.3 PK			2.35 H	216	76.7	42.6
3	*5785.00	109.5 AV			2.35 H	216	66.9	42.6
4	#5960.00	60.0 PK	68.2	-8.2	2.35 H	216	55.2	4.8
5	11570.00	56.5 PK	74.0	-17.5	2.03 H	214	47.9	8.6
6	11570.00	44.7 AV	54.0	-9.3	2.03 H	214	36.1	8.6
Antenna Polarity & Test Distance : Vertical at 3 m								
No	Frequency (MHz)	Emission Level (dBuV/m)	Limit (dBuV/m)	Margin (dB)	Antenna Height (m)	Table Angle (Degree)	Raw Value (dBuV)	Correction Factor (dB/m)
1	#5634.40	57.9 PK	68.2	-10.3	2.69 V	168	53.9	4.0
2	*5785.00	116.2 PK			2.69 V	168	73.6	42.6
3	*5785.00	106.9 AV			2.69 V	168	64.3	42.6
4	#5950.80	58.7 PK	68.2	-9.5	2.69 V	168	53.9	4.8
5	11570.00	56.1 PK	74.0	-17.9	1.90 V	182	47.5	8.6
6	11570.00	44.2 AV	54.0	-9.8	1.90 V	182	35.6	8.6

Remarks:

1. Emission Level(dBuV/m) = Raw Value(dBuV) + Correction Factor(dB/m)
2. Correction Factor(dB/m) = Antenna Factor(dB/m) + Cable Factor(dB) – Pre-Amplifier Factor(dB)
3. Margin value = Emission Level – Limit value
4. The other emission levels were very low against the limit.
5. " * ": Fundamental frequency.
6. " # ": The radiated frequency is out of the restricted band.

RF Mode	TX 802.11ac (VHT20)	Channel	CH 165 : 5825 MHz
Frequency Range	1GHz ~ 40GHz	Detector Function	Peak (PK) Average (AV)

Antenna Polarity & Test Distance : Horizontal at 3 m

No	Frequency (MHz)	Emission Level (dBuV/m)	Limit (dBuV/m)	Margin (dB)	Antenna Height (m)	Table Angle (Degree)	Raw Value (dBuV)	Correction Factor (dB/m)
1	#5641.60	58.8 PK	68.2	-9.4	2.38 H	217	54.8	4.0
2	*5825.00	119.8 PK			2.38 H	217	77.1	42.7
3	*5825.00	110.7 AV			2.38 H	217	68.0	42.7
4	#5994.00	58.9 PK	68.2	-9.3	2.38 H	217	54.0	4.9
5	11650.00	57.2 PK	74.0	-16.8	1.88 H	224	48.5	8.7
6	11650.00	45.2 AV	54.0	-8.8	1.88 H	224	36.5	8.7

Antenna Polarity & Test Distance : Vertical at 3 m

No	Frequency (MHz)	Emission Level (dBuV/m)	Limit (dBuV/m)	Margin (dB)	Antenna Height (m)	Table Angle (Degree)	Raw Value (dBuV)	Correction Factor (dB/m)
1	#5628.40	58.2 PK	68.2	-10.0	2.69 V	167	54.2	4.0
2	*5825.00	115.9 PK			2.69 V	167	73.2	42.7
3	*5825.00	106.8 AV			2.69 V	167	64.1	42.7
4	#5978.40	58.7 PK	68.2	-9.5	2.69 V	167	53.9	4.8
5	11650.00	56.7 PK	74.0	-17.3	1.85 V	172	48.0	8.7
6	11650.00	44.7 AV	54.0	-9.3	1.85 V	172	36.0	8.7

Remarks:

1. Emission Level(dBuV/m) = Raw Value(dBuV) + Correction Factor(dB/m)
2. Correction Factor(dB/m) = Antenna Factor(dB/m) + Cable Factor(dB) – Pre-Amplifier Factor(dB)
3. Margin value = Emission Level – Limit value
4. The other emission levels were very low against the limit.
5. " * ": Fundamental frequency.
6. " # ": The radiated frequency is out of the restricted band.

802.11ac (VHT40)

RF Mode	TX 802.11ac (VHT40)	Channel	CH 38 : 5190 MHz
Frequency Range	1GHz ~ 40GHz	Detector Function	Peak (PK) Average (AV)

Antenna Polarity & Test Distance : Horizontal at 3 m

No	Frequency (MHz)	Emission Level (dBuV/m)	Limit (dBuV/m)	Margin (dB)	Antenna Height (m)	Table Angle (Degree)	Raw Value (dBuV)	Correction Factor (dB/m)
1	5150.00	64.8 PK	74.0	-9.2	1.64 H	7	62.0	2.8
2	5150.00	53.5 AV	54.0	-0.5	1.64 H	7	50.7	2.8
3	*5190.00	113.2 PK			1.64 H	7	72.2	41.0
4	*5190.00	103.9 AV			1.64 H	7	62.9	41.0
5	#10380.00	55.6 PK	68.2	-12.6	1.87 H	245	47.5	8.1

Antenna Polarity & Test Distance : Vertical at 3 m

No	Frequency (MHz)	Emission Level (dBuV/m)	Limit (dBuV/m)	Margin (dB)	Antenna Height (m)	Table Angle (Degree)	Raw Value (dBuV)	Correction Factor (dB/m)
1	5150.00	60.8 PK	74.0	-13.2	1.00 V	172	58.0	2.8
2	5150.00	48.8 AV	54.0	-5.2	1.00 V	172	46.0	2.8
3	*5190.00	109.2 PK			2.90 V	172	68.2	41.0
4	*5190.00	99.8 AV			2.90 V	172	58.8	41.0
5	#10380.00	55.1 PK	68.2	-13.1	1.52 V	181	47.0	8.1

Remarks:

1. Emission Level(dBuV/m) = Raw Value(dBuV) + Correction Factor(dB/m)
2. Correction Factor(dB/m) = Antenna Factor(dB/m) + Cable Factor(dB) – Pre-Amplifier Factor(dB)
3. Margin value = Emission Level – Limit value
4. The other emission levels were very low against the limit.
5. " * ": Fundamental frequency.
6. " # ": The radiated frequency is out of the restricted band.

RF Mode	TX 802.11ac (VHT40)	Channel	CH 46 : 5230 MHz
Frequency Range	1GHz ~ 40GHz	Detector Function	Peak (PK) Average (AV)

Antenna Polarity & Test Distance : Horizontal at 3 m

No	Frequency (MHz)	Emission Level (dBuV/m)	Limit (dBuV/m)	Margin (dB)	Antenna Height (m)	Table Angle (Degree)	Raw Value (dBuV)	Correction Factor (dB/m)
1	*5230.00	116.6 PK			1.35 H	2	75.6	41.0
2	*5230.00	107.3 AV			1.35 H	2	66.3	41.0
3	5350.00	56.4 PK	74.0	-17.6	1.35 H	2	53.5	2.9
4	5350.00	45.6 AV	54.0	-8.4	1.35 H	2	42.7	2.9
5	#10460.00	55.8 PK	68.2	-12.4	1.78 H	235	47.8	8.0

Antenna Polarity & Test Distance : Vertical at 3 m

No	Frequency (MHz)	Emission Level (dBuV/m)	Limit (dBuV/m)	Margin (dB)	Antenna Height (m)	Table Angle (Degree)	Raw Value (dBuV)	Correction Factor (dB/m)
1	*5230.00	114.9 PK			2.97 V	169	73.9	41.0
2	*5230.00	104.7 AV			2.97 V	169	63.7	41.0
3	5350.00	57.4 PK	74.0	-16.6	2.97 V	169	54.5	2.9
4	5350.00	45.1 AV	54.0	-8.9	2.97 V	169	42.2	2.9
5	#10460.00	55.2 PK	68.2	-13.0	1.65 V	173	47.2	8.0

Remarks:

1. Emission Level(dBuV/m) = Raw Value(dBuV) + Correction Factor(dB/m)
2. Correction Factor(dB/m) = Antenna Factor(dB/m) + Cable Factor(dB) – Pre-Amplifier Factor(dB)
3. Margin value = Emission Level – Limit value
4. The other emission levels were very low against the limit.
5. " * ": Fundamental frequency.
6. " # ": The radiated frequency is out of the restricted band.

RF Mode	TX 802.11ac (VHT40)	Channel	CH 54 : 5270 MHz
Frequency Range	1GHz ~ 40GHz	Detector Function	Peak (PK) Average (AV)

Antenna Polarity & Test Distance : Horizontal at 3 m

No	Frequency (MHz)	Emission Level (dBuV/m)	Limit (dBuV/m)	Margin (dB)	Antenna Height (m)	Table Angle (Degree)	Raw Value (dBuV)	Correction Factor (dB/m)
1	*5270.00	117.4 PK			1.38 H	9	76.4	41.0
2	*5270.00	108.2 AV			1.38 H	9	67.2	41.0
3	5350.00	64.4 PK	74.0	-9.6	1.38 H	9	61.5	2.9
4	5350.00	50.1 AV	54.0	-3.9	1.38 H	9	47.2	2.9
5	#10540.00	55.4 PK	68.2	-12.8	1.75 H	225	47.2	8.2

Antenna Polarity & Test Distance : Vertical at 3 m

No	Frequency (MHz)	Emission Level (dBuV/m)	Limit (dBuV/m)	Margin (dB)	Antenna Height (m)	Table Angle (Degree)	Raw Value (dBuV)	Correction Factor (dB/m)
1	*5270.00	114.2 PK			2.96 V	170	73.2	41.0
2	*5270.00	105.4 AV			2.96 V	170	64.4	41.0
3	5350.00	59.2 PK	74.0	-14.8	2.96 V	170	56.3	2.9
4	5350.00	48.0 AV	54.0	-6.0	2.96 V	170	45.1	2.9
5	#10540.00	55.2 PK	68.2	-13.0	1.72 V	185	47.0	8.2

Remarks:

1. Emission Level(dBuV/m) = Raw Value(dBuV) + Correction Factor(dB/m)
2. Correction Factor(dB/m) = Antenna Factor(dB/m) + Cable Factor(dB) – Pre-Amplifier Factor(dB)
3. Margin value = Emission Level – Limit value
4. The other emission levels were very low against the limit.
5. " * " : Fundamental frequency.
6. " # " : The radiated frequency is out of the restricted band.

RF Mode	TX 802.11ac (VHT40)	Channel	CH 62 : 5310 MHz
Frequency Range	1GHz ~ 40GHz	Detector Function	Peak (PK) Average (AV)

Antenna Polarity & Test Distance : Horizontal at 3 m

No	Frequency (MHz)	Emission Level (dBuV/m)	Limit (dBuV/m)	Margin (dB)	Antenna Height (m)	Table Angle (Degree)	Raw Value (dBuV)	Correction Factor (dB/m)
1	*5310.00	111.2 PK			1.24 H	9	70.2	41.0
2	*5310.00	101.5 AV			1.24 H	9	60.5	41.0
3	5350.00	66.5 PK	74.0	-7.5	1.24 H	9	63.6	2.9
4	5350.00	53.2 AV	54.0	-0.8	1.24 H	9	50.3	2.9
5	10620.00	55.4 PK	74.0	-18.6	1.82 H	235	47.3	8.1
6	10620.00	42.4 AV	54.0	-11.6	1.82 H	235	34.3	8.1

Antenna Polarity & Test Distance : Vertical at 3 m

No	Frequency (MHz)	Emission Level (dBuV/m)	Limit (dBuV/m)	Margin (dB)	Antenna Height (m)	Table Angle (Degree)	Raw Value (dBuV)	Correction Factor (dB/m)
1	*5310.00	108.5 PK			2.83 V	171	67.5	41.0
2	*5310.00	98.9 AV			2.83 V	171	57.9	41.0
3	5350.00	62.1 PK	74.0	-11.9	2.83 V	171	59.2	2.9
4	5350.00	50.6 AV	54.0	-3.4	2.83 V	171	47.7	2.9
5	10620.00	55.1 PK	74.0	-18.9	1.68 V	185	47.0	8.1
6	10620.00	42.2 AV	54.0	-11.8	1.68 V	185	34.1	8.1

Remarks:

1. Emission Level(dBuV/m) = Raw Value(dBuV) + Correction Factor(dB/m)
2. Correction Factor(dB/m) = Antenna Factor(dB/m) + Cable Factor(dB) – Pre-Amplifier Factor(dB)
3. Margin value = Emission Level – Limit value
4. The other emission levels were very low against the limit.
5. " * ": Fundamental frequency.

RF Mode	TX 802.11ac (VHT40)	Channel	CH 102 : 5510 MHz
Frequency Range	1GHz ~ 40GHz	Detector Function	Peak (PK) Average (AV)

Antenna Polarity & Test Distance : Horizontal at 3 m

No	Frequency (MHz)	Emission Level (dBuV/m)	Limit (dBuV/m)	Margin (dB)	Antenna Height (m)	Table Angle (Degree)	Raw Value (dBuV)	Correction Factor (dB/m)
1	5460.00	61.2 PK	74.0	-12.8	1.22 H	0	58.0	3.2
2	5460.00	48.7 AV	54.0	-5.3	1.22 H	0	45.5	3.2
3	#5470.00	67.5 PK	68.2	-0.7	1.22 H	0	64.3	3.2
4	*5510.00	111.8 PK			1.22 H	0	70.3	41.5
5	*5510.00	102.2 AV			1.22 H	0	60.7	41.5
6	11020.00	55.4 PK	74.0	-18.6	1.88 H	223	47.2	8.2
7	11020.00	43.0 AV	54.0	-11.0	1.88 H	223	34.8	8.2

Antenna Polarity & Test Distance : Vertical at 3 m

No	Frequency (MHz)	Emission Level (dBuV/m)	Limit (dBuV/m)	Margin (dB)	Antenna Height (m)	Table Angle (Degree)	Raw Value (dBuV)	Correction Factor (dB/m)
1	5460.00	62.6 PK	74.0	-11.4	2.71 V	178	59.4	3.2
2	5460.00	46.8 AV	54.0	-7.2	2.71 V	178	43.6	3.2
3	#5470.00	65.3 PK	68.2	-2.9	2.71 V	178	62.1	3.2
4	*5510.00	111.8 PK			2.71 V	178	70.3	41.5
5	*5510.00	102.3 AV			2.71 V	178	60.8	41.5
6	11020.00	55.0 PK	74.0	-19.0	1.52 V	175	46.8	8.2
7	11020.00	42.6 AV	54.0	-11.4	1.52 V	175	34.4	8.2

Remarks:

1. Emission Level(dBuV/m) = Raw Value(dBuV) + Correction Factor(dB/m)
2. Correction Factor(dB/m) = Antenna Factor(dB/m) + Cable Factor(dB) – Pre-Amplifier Factor(dB)
3. Margin value = Emission Level – Limit value
4. The other emission levels were very low against the limit.
5. " * ": Fundamental frequency.
6. " # ": The radiated frequency is out of the restricted band.

RF Mode	TX 802.11ac (VHT40)	Channel	CH 110 : 5550 MHz
Frequency Range	1GHz ~ 40GHz	Detector Function	Peak (PK) Average (AV)

Antenna Polarity & Test Distance : Horizontal at 3 m								
No	Frequency (MHz)	Emission Level (dBuV/m)	Limit (dBuV/m)	Margin (dB)	Antenna Height (m)	Table Angle (Degree)	Raw Value (dBuV)	Correction Factor (dB/m)
1	*5550.00	117.7 PK			1.13 H	2	76.0	41.7
2	*5550.00	107.6 AV			1.13 H	2	65.9	41.7
3	11100.00	55.5 PK	74.0	-18.5	1.97 H	231	47.3	8.2
4	11100.00	43.0 AV	54.0	-11.0	1.97 H	231	34.8	8.2
Antenna Polarity & Test Distance : Vertical at 3 m								
No	Frequency (MHz)	Emission Level (dBuV/m)	Limit (dBuV/m)	Margin (dB)	Antenna Height (m)	Table Angle (Degree)	Raw Value (dBuV)	Correction Factor (dB/m)
1	*5550.00	117.1 PK			2.68 V	177	75.4	41.7
2	*5550.00	107.1 AV			2.68 V	177	65.4	41.7
3	11100.00	55.2 PK	74.0	-18.8	1.59 V	175	47.0	8.2
4	11100.00	42.3 AV	54.0	-11.7	1.59 V	175	34.1	8.2

Remarks:

1. Emission Level(dBuV/m) = Raw Value(dBuV) + Correction Factor(dB/m)
2. Correction Factor(dB/m) = Antenna Factor(dB/m) + Cable Factor(dB) – Pre-Amplifier Factor(dB)
3. Margin value = Emission Level – Limit value
4. The other emission levels were very low against the limit.
5. " * ": Fundamental frequency.

RF Mode	TX 802.11ac (VHT40)	Channel	CH 134 : 5670 MHz
Frequency Range	1GHz ~ 40GHz	Detector Function	Peak (PK) Average (AV)

Antenna Polarity & Test Distance : Horizontal at 3 m								
No	Frequency (MHz)	Emission Level (dBuV/m)	Limit (dBuV/m)	Margin (dB)	Antenna Height (m)	Table Angle (Degree)	Raw Value (dBuV)	Correction Factor (dB/m)
1	*5670.00	114.0 PK			1.07 H	0	71.8	42.2
2	*5670.00	104.0 AV			1.07 H	0	61.8	42.2
3	#5725.00	67.0 PK	68.2	-1.2	1.07 H	0	62.6	4.4
4	11340.00	56.3 PK	74.0	-17.7	1.85 H	222	47.7	8.6
5	11340.00	43.8 AV	54.0	-10.2	1.85 H	222	35.2	8.6

Antenna Polarity & Test Distance : Vertical at 3 m								
No	Frequency (MHz)	Emission Level (dBuV/m)	Limit (dBuV/m)	Margin (dB)	Antenna Height (m)	Table Angle (Degree)	Raw Value (dBuV)	Correction Factor (dB/m)
1	*5670.00	115.1 PK			2.68 V	179	72.9	42.2
2	*5670.00	104.7 AV			2.68 V	179	62.5	42.2
3	#5725.00	62.8 PK	68.2	-5.4	2.68 V	179	58.4	4.4
4	11340.00	55.8 PK	74.0	-18.2	1.75 V	179	47.2	8.6
5	11340.00	43.4 AV	54.0	-10.6	1.75 V	179	34.8	8.6

Remarks:

1. Emission Level(dBuV/m) = Raw Value(dBuV) + Correction Factor(dB/m)
2. Correction Factor(dB/m) = Antenna Factor(dB/m) + Cable Factor(dB) – Pre-Amplifier Factor(dB)
3. Margin value = Emission Level – Limit value
4. The other emission levels were very low against the limit.
5. " * " : Fundamental frequency.
6. " # " : The radiated frequency is out of the restricted band.

RF Mode	TX 802.11ac (VHT40)	Channel	CH 142 : 5710 MHz
Frequency Range	1GHz ~ 40GHz	Detector Function	Peak (PK) Average (AV)

Antenna Polarity & Test Distance : Horizontal at 3 m

No	Frequency (MHz)	Emission Level (dBuV/m)	Limit (dBuV/m)	Margin (dB)	Antenna Height (m)	Table Angle (Degree)	Raw Value (dBuV)	Correction Factor (dB/m)
1	*5710.00	114.8 PK			1.09 H	4	72.4	42.4
2	*5710.00	104.4 AV			1.09 H	4	62.0	42.4
3	#5850.00	59.2 PK	68.2	-9.0	1.09 H	4	54.5	4.7
4	11420.00	56.5 PK	74.0	-17.5	1.88 H	229	47.7	8.8
5	11420.00	44.1 AV	54.0	-9.9	1.88 H	229	35.3	8.8

Antenna Polarity & Test Distance : Vertical at 3 m

No	Frequency (MHz)	Emission Level (dBuV/m)	Limit (dBuV/m)	Margin (dB)	Antenna Height (m)	Table Angle (Degree)	Raw Value (dBuV)	Correction Factor (dB/m)
1	*5710.00	116.0 PK			2.61 V	176	73.6	42.4
2	*5710.00	106.1 AV			2.61 V	176	63.7	42.4
3	#5850.00	58.9 PK	68.2	-9.3	2.61 V	176	54.2	4.7
4	11420.00	56.0 PK	74.0	-18.0	1.69 V	177	47.2	8.8
5	11420.00	43.6 AV	54.0	-10.4	1.69 V	177	34.8	8.8

Remarks:

1. Emission Level(dBuV/m) = Raw Value(dBuV) + Correction Factor(dB/m)
2. Correction Factor(dB/m) = Antenna Factor(dB/m) + Cable Factor(dB) – Pre-Amplifier Factor(dB)
3. Margin value = Emission Level – Limit value
4. The other emission levels were very low against the limit.
5. " * " : Fundamental frequency.
6. " # " : The radiated frequency is out of the restricted band.

RF Mode	TX 802.11ac (VHT40)	Channel	CH 151 : 5755 MHz
Frequency Range	1GHz ~ 40GHz	Detector Function	Peak (PK) Average (AV)

Antenna Polarity & Test Distance : Horizontal at 3 m

No	Frequency (MHz)	Emission Level (dBuV/m)	Limit (dBuV/m)	Margin (dB)	Antenna Height (m)	Table Angle (Degree)	Raw Value (dBuV)	Correction Factor (dB/m)
1	#5610.40	59.4 PK	68.2	-8.8	2.37 H	216	55.6	3.8
2	*5755.00	116.5 PK			2.37 H	216	74.0	42.5
3	*5755.00	106.6 AV			2.37 H	216	64.1	42.5
4	#5994.80	59.7 PK	68.2	-8.5	2.37 H	216	54.8	4.9
5	11510.00	56.8 PK	74.0	-17.2	2.03 H	221	48.1	8.7
6	11510.00	45.3 AV	54.0	-8.7	2.03 H	221	36.6	8.7

Antenna Polarity & Test Distance : Vertical at 3 m

No	Frequency (MHz)	Emission Level (dBuV/m)	Limit (dBuV/m)	Margin (dB)	Antenna Height (m)	Table Angle (Degree)	Raw Value (dBuV)	Correction Factor (dB/m)
1	#5603.20	59.2 PK	68.2	-9.0	2.84 V	176	55.4	3.8
2	*5755.00	114.4 PK			2.84 V	176	71.9	42.5
3	*5755.00	104.2 AV			2.84 V	176	61.7	42.5
4	#5961.20	58.1 PK	68.2	-10.1	2.84 V	176	53.3	4.8
5	11510.00	56.3 PK	74.0	-17.7	1.90 V	172	47.6	8.7
6	11510.00	44.8 AV	54.0	-9.2	1.90 V	172	36.1	8.7

Remarks:

1. Emission Level(dBuV/m) = Raw Value(dBuV) + Correction Factor(dB/m)
2. Correction Factor(dB/m) = Antenna Factor(dB/m) + Cable Factor(dB) – Pre-Amplifier Factor(dB)
3. Margin value = Emission Level – Limit value
4. The other emission levels were very low against the limit.
5. " * " : Fundamental frequency.
6. " # " : The radiated frequency is out of the restricted band.

RF Mode	TX 802.11ac (VHT40)	Channel	CH 159 : 5795 MHz
Frequency Range	1GHz ~ 40GHz	Detector Function	Peak (PK) Average (AV)

Antenna Polarity & Test Distance : Horizontal at 3 m								
No	Frequency (MHz)	Emission Level (dBuV/m)	Limit (dBuV/m)	Margin (dB)	Antenna Height (m)	Table Angle (Degree)	Raw Value (dBuV)	Correction Factor (dB/m)
1	#5644.80	58.7 PK	68.2	-9.5	2.37 H	227	54.6	4.1
2	*5795.00	116.0 PK			2.37 H	227	73.3	42.7
3	*5795.00	106.2 AV			2.37 H	227	63.5	42.7
4	#5926.40	59.0 PK	68.2	-9.2	2.37 H	227	54.2	4.8
5	11590.00	56.7 PK	74.0	-17.3	1.86 H	214	48.1	8.6
6	11590.00	44.6 AV	54.0	-9.4	1.86 H	214	36.0	8.6
Antenna Polarity & Test Distance : Vertical at 3 m								
No	Frequency (MHz)	Emission Level (dBuV/m)	Limit (dBuV/m)	Margin (dB)	Antenna Height (m)	Table Angle (Degree)	Raw Value (dBuV)	Correction Factor (dB/m)
1	#5632.00	59.1 PK	68.2	-9.1	2.66 V	152	55.1	4.0
2	*5795.00	114.3 PK			2.66 V	152	71.6	42.7
3	*5795.00	104.1 AV			2.66 V	152	61.4	42.7
4	#5983.20	59.9 PK	68.2	-8.3	2.66 V	152	55.0	4.9
5	11590.00	56.1 PK	74.0	-17.9	1.76 V	180	47.5	8.6
6	11590.00	44.1 AV	54.0	-9.9	1.76 V	180	35.5	8.6

Remarks:

1. Emission Level(dBuV/m) = Raw Value(dBuV) + Correction Factor(dB/m)
2. Correction Factor(dB/m) = Antenna Factor(dB/m) + Cable Factor(dB) – Pre-Amplifier Factor(dB)
3. Margin value = Emission Level – Limit value
4. The other emission levels were very low against the limit.
5. " * ": Fundamental frequency.
6. " # ": The radiated frequency is out of the restricted band.

802.11ac (VHT80)

RF Mode	TX 802.11ac (VHT80)	Channel	CH 42 : 5210 MHz
Frequency Range	1GHz ~ 40GHz	Detector Function	Peak (PK) Average (AV)

Antenna Polarity & Test Distance : Horizontal at 3 m								
No	Frequency (MHz)	Emission Level (dBuV/m)	Limit (dBuV/m)	Margin (dB)	Antenna Height (m)	Table Angle (Degree)	Raw Value (dBuV)	Correction Factor (dB/m)
1	5140.00	64.9 PK	74.0	-9.1	1.32 H	4	62.0	2.9
2	5140.00	53.3 AV	54.0	-0.7	1.32 H	4	50.4	2.9
3	*5210.00	109.0 PK			1.32 H	4	68.0	41.0
4	*5210.00	99.7 AV			1.32 H	4	58.7	41.0
5	5350.00	56.3 PK	74.0	-17.7	1.32 H	4	53.4	2.9
6	5350.00	45.9 AV	54.0	-8.1	1.32 H	4	43.0	2.9
7	#10420.00	55.1 PK	68.2	-13.1	1.85 H	250	47.0	8.1
Antenna Polarity & Test Distance : Vertical at 3 m								
No	Frequency (MHz)	Emission Level (dBuV/m)	Limit (dBuV/m)	Margin (dB)	Antenna Height (m)	Table Angle (Degree)	Raw Value (dBuV)	Correction Factor (dB/m)
1	5140.00	63.1 PK	74.0	-10.9	2.82 V	169	60.2	2.9
2	5140.00	51.6 AV	54.0	-2.4	2.82 V	169	48.7	2.9
3	*5210.00	105.3 PK			2.82 V	169	64.3	41.0
4	*5210.00	96.3 AV			2.82 V	169	55.3	41.0
5	5350.00	56.9 PK	74.0	-17.1	2.82 V	169	54.0	2.9
6	5350.00	45.4 AV	54.0	-8.6	2.82 V	169	42.5	2.9
7	#10420.00	54.6 PK	68.2	-13.6	1.69 V	168	46.5	8.1

Remarks:

1. Emission Level(dBuV/m) = Raw Value(dBuV) + Correction Factor(dB/m)
2. Correction Factor(dB/m) = Antenna Factor(dB/m) + Cable Factor(dB) – Pre-Amplifier Factor(dB)
3. Margin value = Emission Level – Limit value
4. The other emission levels were very low against the limit.
5. " * ": Fundamental frequency.
6. " # ": The radiated frequency is out of the restricted band.

RF Mode	TX 802.11ac (VHT80)	Channel	CH 58 : 5290 MHz
Frequency Range	1GHz ~ 40GHz	Detector Function	Peak (PK) Average (AV)

Antenna Polarity & Test Distance : Horizontal at 3 m

No	Frequency (MHz)	Emission Level (dBuV/m)	Limit (dBuV/m)	Margin (dB)	Antenna Height (m)	Table Angle (Degree)	Raw Value (dBuV)	Correction Factor (dB/m)
1	5150.00	58.4 PK	74.0	-15.6	1.13 H	0	55.6	2.8
2	5150.00	45.3 AV	54.0	-8.7	1.13 H	0	42.5	2.8
3	*5290.00	105.5 PK			1.13 H	0	64.5	41.0
4	*5290.00	96.0 AV			1.13 H	0	55.0	41.0
5	5350.00	63.2 PK	74.0	-10.8	1.13 H	0	60.3	2.9
6	5350.00	52.9 AV	54.0	-1.1	1.13 H	0	50.0	2.9
7	#10580.00	55.2 PK	68.2	-13.0	1.71 H	228	47.1	8.1

Antenna Polarity & Test Distance : Vertical at 3 m

No	Frequency (MHz)	Emission Level (dBuV/m)	Limit (dBuV/m)	Margin (dB)	Antenna Height (m)	Table Angle (Degree)	Raw Value (dBuV)	Correction Factor (dB/m)
1	5150.00	57.9 PK	74.0	-16.1	3.00 V	170	55.1	2.8
2	5150.00	45.4 AV	54.0	-8.6	3.00 V	170	42.6	2.8
3	*5290.00	103.3 PK			3.00 V	170	62.3	41.0
4	*5290.00	93.3 AV			3.00 V	170	52.3	41.0
5	5350.00	60.5 PK	74.0	-13.5	3.00 V	170	57.6	2.9
6	5350.00	50.1 AV	54.0	-3.9	3.00 V	170	47.2	2.9
7	#10580.00	54.6 PK	68.2	-13.6	1.69 V	179	46.5	8.1

Remarks:

1. Emission Level(dBuV/m) = Raw Value(dBuV) + Correction Factor(dB/m)
2. Correction Factor(dB/m) = Antenna Factor(dB/m) + Cable Factor(dB) – Pre-Amplifier Factor(dB)
3. Margin value = Emission Level – Limit value
4. The other emission levels were very low against the limit.
5. " * " : Fundamental frequency.
6. " # " : The radiated frequency is out of the restricted band.

RF Mode	TX 802.11ac (VHT80)	Channel	CH 106 : 5530 MHz
Frequency Range	1GHz ~ 40GHz	Detector Function	Peak (PK) Average (AV)

Antenna Polarity & Test Distance : Horizontal at 3 m								
No	Frequency (MHz)	Emission Level (dBuV/m)	Limit (dBuV/m)	Margin (dB)	Antenna Height (m)	Table Angle (Degree)	Raw Value (dBuV)	Correction Factor (dB/m)
1	5460.00	65.4 PK	74.0	-8.6	1.30 H	1	62.2	3.2
2	5460.00	53.0 AV	54.0	-1.0	1.30 H	1	49.8	3.2
3	#5470.00	64.8 PK	68.2	-3.4	1.30 H	1	61.6	3.2
4	*5530.00	108.3 PK			1.30 H	1	66.6	41.7
5	*5530.00	98.9 AV			1.30 H	1	57.2	41.7
6	#5725.00	58.2 PK	68.2	-10.0	1.30 H	1	53.8	4.4
7	11060.00	55.3 PK	74.0	-18.7	1.79 H	219	47.1	8.2
8	11060.00	43.7 AV	54.0	-10.3	1.79 H	219	35.5	8.2

Antenna Polarity & Test Distance : Vertical at 3 m								
No	Frequency (MHz)	Emission Level (dBuV/m)	Limit (dBuV/m)	Margin (dB)	Antenna Height (m)	Table Angle (Degree)	Raw Value (dBuV)	Correction Factor (dB/m)
1	5460.00	60.5 PK	74.0	-13.5	2.78 V	174	57.3	3.2
2	5460.00	50.2 AV	54.0	-3.8	2.78 V	174	47.0	3.2
3	#5470.00	64.4 PK	68.2	-3.8	2.78 V	174	61.2	3.2
4	*5530.00	107.9 PK			2.78 V	174	66.2	41.7
5	*5530.00	99.0 AV			2.78 V	174	57.3	41.7
6	#5725.00	59.0 PK	68.2	-9.2	2.78 V	174	54.6	4.4
7	11060.00	54.9 PK	74.0	-19.1	1.57 V	188	46.7	8.2
8	11060.00	43.3 AV	54.0	-10.7	1.57 V	188	35.1	8.2

Remarks:

1. Emission Level(dBuV/m) = Raw Value(dBuV) + Correction Factor(dB/m)
2. Correction Factor(dB/m) = Antenna Factor(dB/m) + Cable Factor(dB) – Pre-Amplifier Factor(dB)
3. Margin value = Emission Level – Limit value
4. The other emission levels were very low against the limit.
5. " * ": Fundamental frequency.
6. " # ": The radiated frequency is out of the restricted band.

RF Mode	TX 802.11ac (VHT80)	Channel	CH 138 : 5690 MHz
Frequency Range	1GHz ~ 40GHz	Detector Function	Peak (PK) Average (AV)

Antenna Polarity & Test Distance : Horizontal at 3 m

No	Frequency (MHz)	Emission Level (dBuV/m)	Limit (dBuV/m)	Margin (dB)	Antenna Height (m)	Table Angle (Degree)	Raw Value (dBuV)	Correction Factor (dB/m)
1	#5470.00	60.9 PK	68.2	-7.3	1.08 H	5	57.7	3.2
2	*5690.00	114.6 PK			1.08 H	5	72.3	42.3
3	*5690.00	105.3 AV			1.08 H	5	63.0	42.3
4	#5850.00	63.7 PK	68.2	-4.5	1.08 H	5	59.0	4.7
5	11380.00	56.3 PK	74.0	-17.7	1.82 H	235	47.5	8.8
6	11380.00	44.0 AV	54.0	-10.0	1.82 H	235	35.2	8.8

Antenna Polarity & Test Distance : Vertical at 3 m

No	Frequency (MHz)	Emission Level (dBuV/m)	Limit (dBuV/m)	Margin (dB)	Antenna Height (m)	Table Angle (Degree)	Raw Value (dBuV)	Correction Factor (dB/m)
1	#5470.00	58.0 PK	68.2	-10.2	2.80 V	170	54.8	3.2
2	*5690.00	111.8 PK			2.80 V	170	69.5	42.3
3	*5690.00	102.2 AV			2.80 V	170	59.9	42.3
4	#5850.00	59.5 PK	68.2	-8.7	2.80 V	170	54.8	4.7
5	11380.00	55.8 PK	74.0	-18.2	1.58 V	177	47.0	8.8
6	11380.00	43.5 AV	54.0	-10.5	1.58 V	177	34.7	8.8

Remarks:

1. Emission Level(dBuV/m) = Raw Value(dBuV) + Correction Factor(dB/m)
2. Correction Factor(dB/m) = Antenna Factor(dB/m) + Cable Factor(dB) – Pre-Amplifier Factor(dB)
3. Margin value = Emission Level – Limit value
4. The other emission levels were very low against the limit.
5. " * " : Fundamental frequency.
6. " # " : The radiated frequency is out of the restricted band.

RF Mode	TX 802.11ac (VHT80)	Channel	CH 155 : 5775 MHz
Frequency Range	1GHz ~ 40GHz	Detector Function	Peak (PK) Average (AV)

Antenna Polarity & Test Distance : Horizontal at 3 m

No	Frequency (MHz)	Emission Level (dBuV/m)	Limit (dBuV/m)	Margin (dB)	Antenna Height (m)	Table Angle (Degree)	Raw Value (dBuV)	Correction Factor (dB/m)
1	#5642.00	61.5 PK	68.2	-6.7	2.28 H	219	57.5	4.0
2	#5650.00	62.7 PK	68.2	-5.5	2.28 H	219	58.5	4.2
3	*5775.00	112.6 PK			2.28 H	219	70.0	42.6
4	*5775.00	103.2 AV			2.28 H	219	60.6	42.6
5	#5925.00	67.3 PK	68.2	-0.9	2.28 H	219	62.4	4.9
6	#5925.20	67.3 PK	68.2	-0.9	2.28 H	219	62.5	4.8
7	11550.00	56.6 PK	74.0	-17.4	1.95 H	208	47.9	8.7
8	11550.00	44.9 AV	54.0	-9.1	1.95 H	208	36.2	8.7

Antenna Polarity & Test Distance : Vertical at 3 m

No	Frequency (MHz)	Emission Level (dBuV/m)	Limit (dBuV/m)	Margin (dB)	Antenna Height (m)	Table Angle (Degree)	Raw Value (dBuV)	Correction Factor (dB/m)
1	#5641.20	60.0 PK	68.2	-8.2	2.85 V	178	56.0	4.0
2	#5650.00	61.7 PK	68.2	-6.5	2.85 V	178	57.5	4.2
3	*5775.00	110.2 PK			2.85 V	178	67.6	42.6
4	*5775.00	101.2 AV			2.85 V	178	58.6	42.6
5	#5925.00	60.8 PK	68.2	-7.4	2.85 V	178	55.9	4.9
6	#5963.60	60.8 PK	68.2	-7.4	2.85 V	178	56.0	4.8
7	11550.00	56.2 PK	74.0	-17.8	1.81 V	182	47.5	8.7
8	11550.00	44.4 AV	54.0	-9.6	1.81 V	182	35.7	8.7

Remarks:

1. Emission Level(dBuV/m) = Raw Value(dBuV) + Correction Factor(dB/m)
2. Correction Factor(dB/m) = Antenna Factor(dB/m) + Cable Factor(dB) – Pre-Amplifier Factor(dB)
3. Margin value = Emission Level – Limit value
4. The other emission levels were very low against the limit.
5. " * ": Fundamental frequency.
6. " # ": The radiated frequency is out of the restricted band.

9 kHz ~ 30 MHz Data:

The amplitude of spurious emissions attenuated more than 20 dB below the permissible value is not required to be report.

30 MHz ~ 1 GHz Worst-Case Data:

802.11ac (VHT20)

RF Mode	TX 802.11ac (VHT20)	Channel	CH 100 : 5500 MHz
Frequency Range	30MHz ~ 1GHz	Detector Function	Quasi-Peak (QP)

Antenna Polarity & Test Distance : Horizontal at 3 m								
No	Frequency (MHz)	Emission Level (dBuV/m)	Limit (dBuV/m)	Margin (dB)	Antenna Height (m)	Table Angle (Degree)	Raw Value (dBuV)	Correction Factor (dB/m)
1	76.39	19.5 QP	40.0	-20.5	2.00 H	194	41.8	-22.3
2	124.19	17.4 QP	43.5	-26.1	1.50 H	118	37.5	-20.1
3	177.61	19.0 QP	43.5	-24.5	1.50 H	121	38.4	-19.4
4	254.93	23.1 QP	46.0	-22.9	1.00 H	2	42.5	-19.4
5	315.38	21.6 QP	46.0	-24.4	1.00 H	2	38.8	-17.2
6	493.91	19.8 QP	46.0	-26.2	1.50 H	118	32.8	-13.0

Remarks:

1. Emission Level(dBuV/m) = Raw Value(dBuV) + Correction Factor(dB/m)
2. Correction Factor(dB/m) = Antenna Factor(dB/m) + Cable Factor(dB) – Pre-Amplifier Factor(dB)
3. Margin value = Emission Level – Limit value
4. The other emission levels were very low against the limit of frequency range 30MHz~1000MHz.
5. The emission levels were very low against the limit of frequency range 9kHz~30MHz: the amplitude of spurious emissions attenuated more than 20 dB below the permissible value to be report.

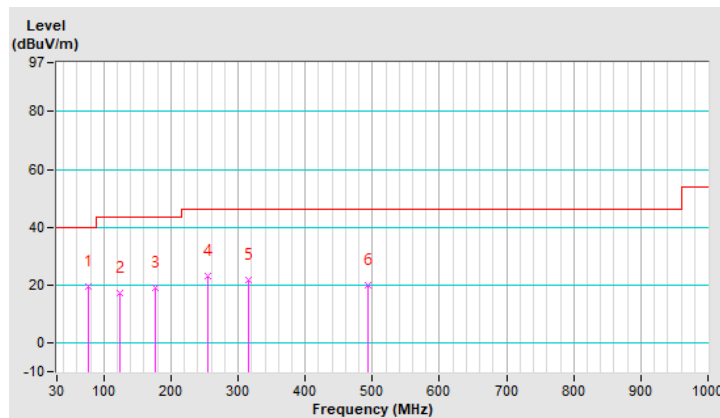

RF Mode	TX 802.11ac (VHT20)	Channel	CH 100 : 5500 MHz
Frequency Range	30MHz ~ 1GHz	Detector Function	Quasi-Peak (QP)

Antenna Polarity & Test Distance : Vertical at 3 m								
No	Frequency (MHz)	Emission Level (dBUV/m)	Limit (dBUV/m)	Margin (dB)	Antenna Height (m)	Table Angle (Degree)	Raw Value (dBUV)	Correction Factor (dB/m)
1	72.17	23.3 QP	40.0	-16.7	1.00 V	302	44.6	-21.3
2	141.06	17.8 QP	43.5	-25.7	1.50 V	160	36.4	-18.6
3	150.90	15.5 QP	43.5	-28.0	1.50 V	188	33.5	-18.0
4	176.20	15.1 QP	43.5	-28.4	2.00 V	9	34.3	-19.2
5	297.10	22.0 QP	46.0	-24.0	1.00 V	49	39.7	-17.7
6	496.72	17.4 QP	46.0	-28.6	1.50 V	50	30.3	-12.9

Remarks:

1. Emission Level(dBuV/m) = Raw Value(dBuV) + Correction Factor(dB/m)
2. Correction Factor(dB/m) = Antenna Factor(dB/m) + Cable Factor(dB) – Pre-Amplifier Factor(dB)
3. Margin value = Emission Level – Limit value
4. The other emission levels were very low against the limit of frequency range 30MHz~1000MHz.
5. The emission levels were very low against the limit of frequency range 9kHz~30MHz: the amplitude of spurious emissions attenuated more than 20 dB below the permissible value to be report.

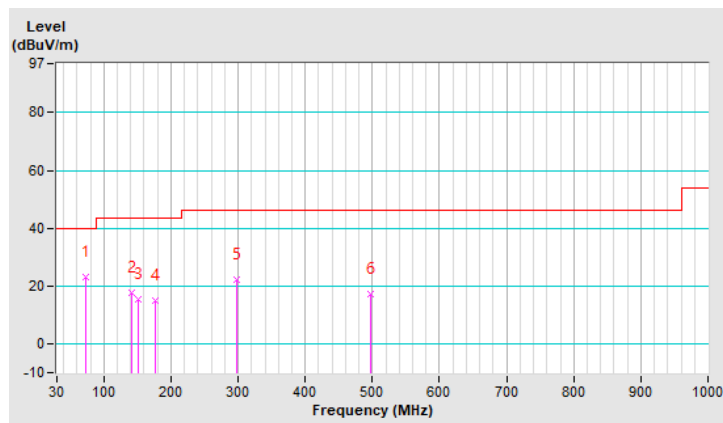

4.2 Conducted Emission Measurement

4.2.1 Limits of Conducted Emission Measurement

Frequency (MHz)	Conducted Limit (dBuV)	
	Quasi-Peak	Average
0.15 - 0.5	66 - 56	56 - 46
0.50 - 5.0	56	46
5.0 - 30.0	60	50

- Note: 1. The lower limit shall apply at the transition frequencies.
 2. The limit decreases in line with the logarithm of the frequency in the range of 0.15 to 0.50 MHz.

4.2.2 Test Instruments

Description & Manufacturer	Model No.	Serial No.	Date of Calibration	Due Date of Calibration
Test Receiver ROHDE & SCHWARZ	ESCI	100613	Dec. 04, 2020	Dec. 03, 2021
RF signal cable Woken	5D-FB	Cable-cond1-01	Jan. 16, 2021	Jan. 15, 2022
LISN/AMN ROHDE & SCHWARZ (EUT)	ENV216	101826	Feb. 25, 2021	Feb. 24, 2022
LISN/AMN ROHDE & SCHWARZ (Peripheral)	ESH3-Z5	100311	Aug. 28, 2020	Aug. 27, 2021
Software ADT	BV ADT_Cond_ V7.3.7.4	NA	NA	NA

- Note: 1. The calibration interval of the above test instruments is 12 months and the calibrations are traceable to NML/ROC and NIST/USA.
 2. The test was performed in HwaYa Shielded Room 1. (Conduction 1).
 3. The VCCI Site Registration No. is C-12040.

4.2.3 Test Procedures

- The EUT was placed 0.4 meters from the conducting wall of the shielded room with EUT being connected to the power mains through a line impedance stabilization network (LISN). Other support units were connected to the power mains through another LISN. The two LISNs provide 50 ohm/ 50uH of coupling impedance for the measuring instrument.
- Both lines of the power mains connected to the EUT were checked for maximum conducted interference.
- The frequency range from 150 kHz to 30 MHz was searched. Emission levels under (Limit -20 dB) was not recorded.

Note: All modes of operation were investigated and the worst-case emissions are reported.

4.2.4 Deviation from Test Standard

No deviation.

4.2.5 Test Setup

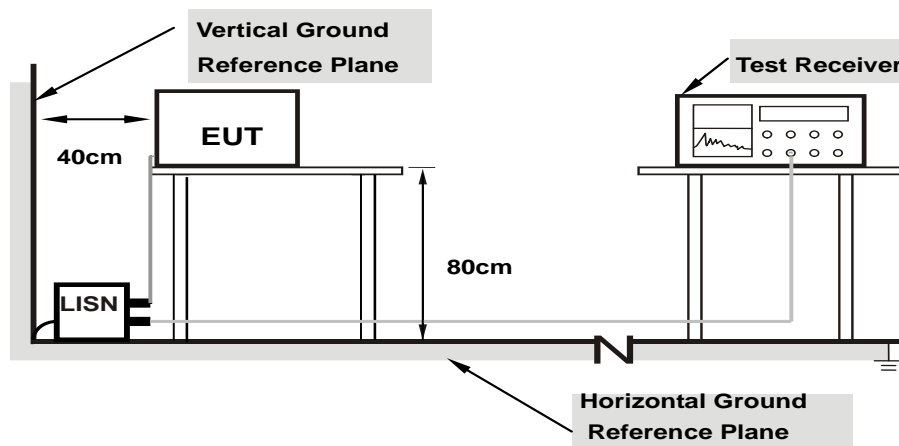

- Note:**
- Support units were connected to second LISN.
 - Both of LISNs (AMN) are 80 cm from EUT and at least 80 from other units and other metal planes

For the actual test configuration, please refer to the attached file (Test Setup Photo).

4.2.6 EUT Operating Conditions

- Placed the EUT on a testing table.
- Use the software to control the EUT under transmission condition continuously at specific channel frequency.

4.2.7 Test Results

Frequency Range	150kHz ~ 30MHz	Detector Function & Resolution Bandwidth	Quasi-Peak (QP) / Average (AV), 9kHz
Input Power	120Vac, 60Hz	Environmental Conditions	24°C, 69%RH
Tested by	Edison Lee	Test Date	2021/4/17

Phase Of Power : Line (L)										
No	Frequency (MHz)	Correction Factor (dB)	Reading Value (dBuV)		Emission Level (dBuV)		Limit (dBuV)		Margin (dB)	
			Q.P.	AV.	Q.P.	AV.	Q.P.	AV.	Q.P.	AV.
1	0.16600	10.07	25.26	1.21	35.33	11.28	65.16	55.16	-29.83	-43.88
2	0.19000	10.08	21.13	0.51	31.21	10.59	64.04	54.04	-32.83	-43.45
3	0.25800	10.08	16.01	1.35	26.09	11.43	61.50	51.50	-35.41	-40.07
4	0.39000	10.09	18.14	2.16	28.23	12.25	58.06	48.06	-29.83	-35.81
5	0.51800	10.10	4.09	3.25	14.19	13.35	56.00	46.00	-41.81	-32.65
6	17.77000	10.42	13.72	1.33	24.14	11.75	60.00	50.00	-35.86	-38.25

Remarks:

1. Q.P. and AV. are abbreviations of quasi-peak and average individually.
2. The emission levels of other frequencies were very low against the limit.
3. Margin value = Emission level – Limit value
4. Correction factor = Insertion loss + Cable loss
5. Emission Level = Correction Factor + Reading Value

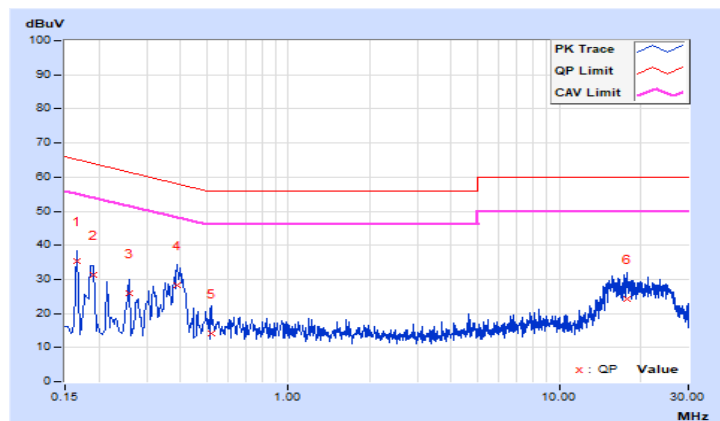

Frequency Range	150kHz ~ 30MHz	Detector Function & Resolution Bandwidth	Quasi-Peak (QP) / Average (AV), 9kHz
Input Power	120Vac, 60Hz	Environmental Conditions	24°C, 69%RH
Tested by	Edison Lee	Test Date	2021/4/17

Phase Of Power : Neutral (N)										
No	Frequency (MHz)	Correction Factor (dB)	Reading Value (dBuV)		Emission Level (dBuV)		Limit (dBuV)		Margin (dB)	
			Q.P.	AV.	Q.P.	AV.	Q.P.	AV.	Q.P.	AV.
1	0.17400	9.77	22.91	1.14	32.68	10.91	64.77	54.77	-32.09	-43.86
2	0.19400	9.77	20.08	0.50	29.85	10.27	63.86	53.86	-34.01	-43.59
3	0.21800	9.77	19.27	0.79	29.04	10.56	62.89	52.89	-33.85	-42.33
4	0.26600	9.78	16.83	0.35	26.61	10.13	61.24	51.24	-34.63	-41.11
5	0.40600	9.79	22.66	5.70	32.45	15.49	57.73	47.73	-25.28	-32.24
6	24.13800	9.99	12.76	0.92	22.75	10.91	60.00	50.00	-37.25	-39.09

Remarks:

1. Q.P. and AV. are abbreviations of quasi-peak and average individually.
2. The emission levels of other frequencies were very low against the limit.
3. Margin value = Emission level – Limit value
4. Correction factor = Insertion loss + Cable loss
5. Emission Level = Correction Factor + Reading Value

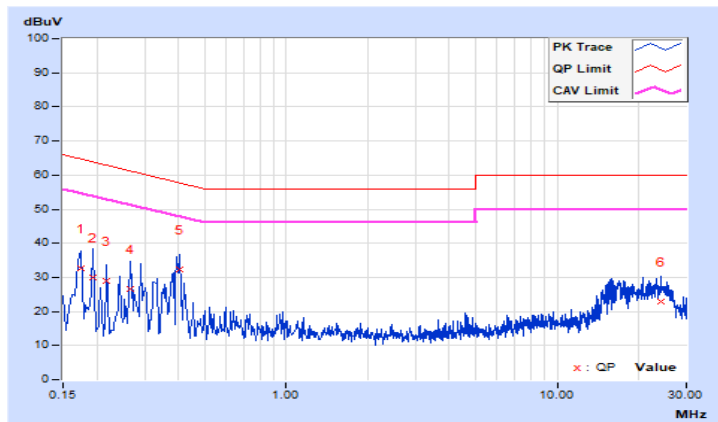

4.3 Transmit Power Measurement

4.3.1 Limits of Transmit Power Measurement

Operation Band	EUT Category		Limit
U-NII-1		Outdoor Access Point	1 Watt (30 dBm) (Max. e.i.r.p \leq 125 mW (21 dBm) at any elevation angle above 30 degrees as measured from the horizon)
		Fixed point-to-point Access Point	1 Watt (30 dBm)
		Indoor Access Point	1 Watt (30 dBm)
	√	Mobile and Portable client device	250 mW (24 dBm)
U-NII-2A	√		250 mW (24 dBm) or 11 dBm + 10 log B*
U-NII-2C	√		250 mW (24 dBm) or 11 dBm + 10 log B*
U-NII-3	√		1 Watt (30 dBm)

*B is the 26 dB emission bandwidth in megahertz

Per KDB 662911 Method of conducted output power measurement on IEEE 802.11 devices,

Array Gain = 0 dB (i.e., no array gain) for $N_{ANT} \leq 4$;

Array Gain = 0 dB (i.e., no array gain) for channel widths ≥ 40 MHz for any N_{ANT} ;

Array Gain = $5 \log(N_{ANT}/N_{SS})$ dB or 3 dB, whichever is less for 20 MHz channel widths with $N_{ANT} \geq 5$.

For power measurements on all other devices: Array Gain = $10 \log(N_{ANT}/N_{SS})$ dB.

4.3.2 Test Setup

<Power Output Measurement>

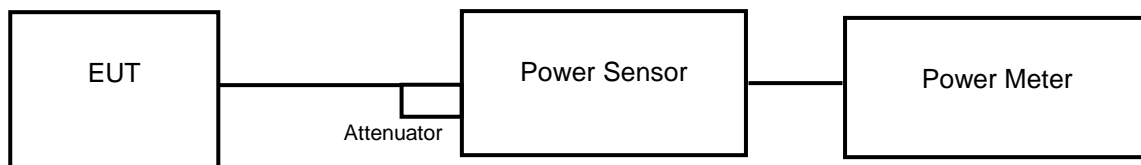

or

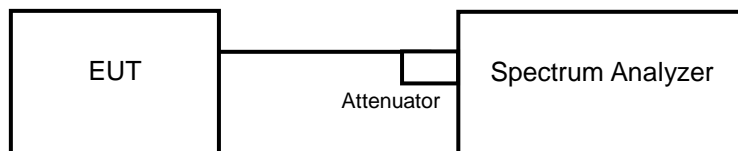

<26 dB Bandwidth>

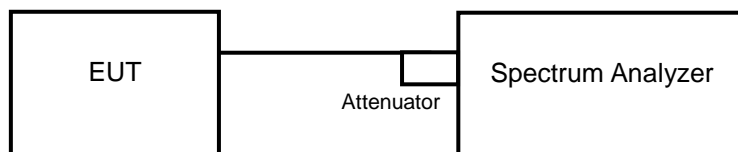

4.3.3 Test Instruments

Refer to section 4.1.2 to get information of above instrument.

4.3.4 Test Procedure

Average Power Measurement

Method PM is used to perform output power measurement, trigger and gating function of wide band power meter is enabled to measure max output power of TX on burst. Duty factor is not added to measured value.

For channel straddling 5725 MHz

Follow FCC KDB 789033 UNII test procedure:

Method SA-1

- a. Set span to encompass the entire emission bandwidth (EBW) of the signal.
- b. Set RBW = 1 MHz.
- c. Set VBW $\geq 3 \times$ RBW.
- d. Number of points in sweep ≥ 2 Span / RBW.
- e. Sweep time = auto.
- f. Set trigger to free run (duty cycle ≥ 98 percent)
- g. Detector = RMS.
- h. Trace average at least 100 traces in power averaging mode.
- i. Compute power by integrating the spectrum across the 26 dB EBW of the signal.

26 dB Bandwidth

- a. Set RBW = approximately 1 % of the emission bandwidth.
- b. Set the VBW $\geq 3 \times$ RBW.
- c. Detector = Peak.
- d. Trace mode = max hold.
- e. Measure the maximum width of the emission that is 26 dB down from the peak of the emission. Compare this with the RBW setting of the analyzer. Readjust RBW and repeat measurement as needed until the RBW/EBW ratio is approximately 1 %.

4.3.5 Deviation from Test Standard

No deviation.

4.3.6 EUT Operating Conditions

The software provided by client to enable the EUT under transmission condition continuously at lowest, middle and highest channel frequencies individually.

4.3.7 Test Results

Power Output:

CDD Mode

802.11a

Channel	Frequency (MHz)	Maximum Conducted Power (dBm)		Total Power (mW)	Total Power (dBm)	Power Limit (dBm)	Pass / Fail
		Chain 0	Chain 1				
36	5180	11.75	11.58	29.35	14.68	23.89	Pass
40	5200	11.82	11.71	30.031	14.78	23.89	Pass
48	5240	11.79	11.66	29.756	14.74	23.89	Pass
52	5260	13.73	13.65	46.779	16.70	23.89	Pass
60	5300	13.75	13.66	46.941	16.72	23.89	Pass
64	5320	13.87	13.75	48.092	16.82	23.89	Pass
100	5500	17.32	17.41	109.032	20.38	23.89	Pass
116	5580	17.43	17.38	110.037	20.42	23.89	Pass
140	5700	17.54	17.45	112.345	20.51	23.89	Pass
144	5720 (U-NII-2C)	16.38	16.42	87.304	19.41	23.14	Pass
144	5720 (U-NII-3)	10.11	10.37	21.146	13.25	29.89	Pass
149	5745	22.78	22.98	388.28	25.89	29.89	Pass
157	5785	22.37	22.91	368.018	25.66	29.89	Pass
165	5825	22.72	22.97	385.221	25.86	29.89	Pass

Note:

5180~57000MHz: Gain = 6.11dBi > 6dBi, so the limit shall be reduced to $24 - (6.11 - 6) = 23.89$ dBm.

5720 (U-NII-2C)MHz: Gain = 6.11dBi > 6dBi, so the limit shall be reduced to $23.25 - (6.11 - 6) = 23.14$ dBm

5745~5825MHz: Gain = 6.11dBi > 6dBi, so the limit shall be reduced to $30 - (6.11 - 6) = 29.89$ dBm.

For U-NII-2A, U-NII-2C Band:

Chain 0

1. $11 \text{ dBm} + 10\log (23.30) = 24.67 \text{ dBm} > 24 \text{ dBm}$.
2. $11 \text{ dBm} + 10\log (23.59) = 24.72 \text{ dBm} > 24 \text{ dBm}$.
3. $11 \text{ dBm} + 10\log (23.48) = 24.70 \text{ dBm} > 24 \text{ dBm}$.
4. $11 \text{ dBm} + 10\log (23.65) = 24.73 \text{ dBm} > 24 \text{ dBm}$.
5. $11 \text{ dBm} + 10\log (23.39) = 24.69 \text{ dBm} > 24 \text{ dBm}$.
6. $11 \text{ dBm} + 10\log (23.32) = 24.67 \text{ dBm} > 24 \text{ dBm}$.
7. $11 \text{ dBm} + 10\log (16.90) = 23.27 \text{ dBm} < 24 \text{ dBm}$.

Chain 1

1. $11 \text{ dBm} + 10\log (23.29) = 24.67 \text{ dBm} > 24 \text{ dBm}$.
2. $11 \text{ dBm} + 10\log (22.76) = 24.57 \text{ dBm} > 24 \text{ dBm}$.
3. $11 \text{ dBm} + 10\log (24.06) = 24.81 \text{ dBm} > 24 \text{ dBm}$.
4. $11 \text{ dBm} + 10\log (23.61) = 24.73 \text{ dBm} > 24 \text{ dBm}$.
5. $11 \text{ dBm} + 10\log (23.01) = 24.61 \text{ dBm} > 24 \text{ dBm}$.
6. $11 \text{ dBm} + 10\log (23.85) = 24.77 \text{ dBm} > 24 \text{ dBm}$.
7. $11 \text{ dBm} + 10\log (16.82) = 23.25 \text{ dBm} < 24 \text{ dBm}$.

802.11ac (VHT20)

Channel	Frequency (MHz)	Maximum Conducted Power (dBm)		Total Power (mW)	Total Power (dBm)	Power Limit (dBm)	Pass / Fail
		Chain 0	Chain 1				
36	5180	11.88	11.51	29.575	14.71	23.89	Pass
40	5200	11.86	11.49	29.439	14.69	23.89	Pass
48	5240	11.90	11.47	29.516	14.70	23.89	Pass
52	5260	13.88	13.45	46.565	16.68	23.89	Pass
60	5300	13.79	13.59	46.789	16.70	23.89	Pass
64	5320	13.98	13.74	48.663	16.87	23.89	Pass
100	5500	17.12	17.23	104.367	20.19	23.89	Pass
116	5580	17.43	17.17	107.454	20.31	23.89	Pass
140	5700	17.60	17.27	110.877	20.45	23.89	Pass
144	5720 (U-NII-2C)	17.10	17.05	101.985	20.09	23.22	Pass
144	5720 (U-NII-3)	9.00	9.09	16.053	12.06	29.89	Pass
149	5745	22.54	22.93	375.809	25.75	29.89	Pass
157	5785	22.89	23.01	394.522	25.96	29.89	Pass
165	5825	22.73	22.99	386.567	25.87	29.89	Pass

Note:

5180~57000MHz: Gain = 6.11dBi > 6dBi, so the limit shall be reduced to 24-(6.11-6) = 23.89dBm.

5720 (U-NII-2C)MHz: Gain = 6.11dBi > 6dBi, so the limit shall be reduced to 23.33-(6.11-6) = 23.22dBm

5745~5825MHz: Gain = 6.11dBi > 6dBi, so the limit shall be reduced to 30-(6.11-6) = 29.89dBm.

For U-NII-2A, U-NII-2C Band:
Chain 0

1. 11 dBm + 10log (25.26) = 25.02 dBm > 24 dBm.
2. 11 dBm + 10log (25.19) = 25.01 dBm > 24 dBm.
3. 11 dBm + 10log (24.35) = 24.86 dBm > 24 dBm.
4. 11 dBm + 10log (25.12) = 25.00 dBm > 24 dBm.
5. 11 dBm + 10log (25.38) = 25.04 dBm > 24 dBm.
6. 11 dBm + 10log (25.15) = 25.00 dBm > 24 dBm.
7. 11 dBm + 10log (17.27) = 23.37 dBm < 24 dBm.

Chain 1

1. 11 dBm + 10log (24.83) = 24.95 dBm > 24 dBm.
2. 11 dBm + 10log (24.63) = 24.91 dBm > 24 dBm.
3. 11 dBm + 10log (24.90) = 24.96 dBm > 24 dBm.
4. 11 dBm + 10log (25.35) = 25.04 dBm > 24 dBm.
5. 11 dBm + 10log (25.01) = 24.98 dBm > 24 dBm.
6. 11 dBm + 10log (25.29) = 25.02 dBm > 24 dBm.
7. 11 dBm + 10log (17.11) = 23.33 dBm < 24 dBm.

802.11ac (VHT40)

Channel	Frequency (MHz)	Maximum Conducted Power (dBm)		Total Power (mW)	Total Power (dBm)	Power Limit (dBm)	Pass / Fail
		Chain 0	Chain 1				
38	5190	13.58	13.71	46.3	16.66	23.89	Pass
46	5230	13.85	13.57	47.017	16.72	23.89	Pass
54	5270	13.85	13.69	47.654	16.78	23.89	Pass
62	5310	13.55	13.49	44.982	16.53	23.89	Pass
102	5510	17.31	17.11	105.231	20.22	23.89	Pass
110	5550	20.41	20.33	217.795	23.38	23.89	Pass
134	5670	19.56	19.43	178.065	22.51	23.89	Pass
142	5710 (U-NII-2C)	19.52	19.16	171.950	22.35	23.89	Pass
142	5710 (U-NII-3)	8.90	8.05	14.145	11.51	29.89	Pass
151	5755	22.78	23.22	399.565	26.02	29.89	Pass
159	5795	23.11	23.15	411.182	26.14	29.89	Pass

Note:

5190~5710 (U-NII-2C)MHz: Gain = 6.11dBi > 6dBi, so the limit shall be reduced to 24-(6.11-6) = 23.89dBm.

5710 (U-NII-3)~5795MHz: Gain = 6.11dBi > 6dBi, so the limit shall be reduced to 30-(6.11-6) = 29.89dBm.

For U-NII-2A, U-NII-2C Band:

Chain 0

1. 11 dBm + 10log (42.80) = 27.31 dBm > 24 dBm.
2. 11 dBm + 10log (42.52) = 27.28 dBm > 24 dBm.
3. 11 dBm + 10log (42.23) = 27.25 dBm > 24 dBm.
4. 11 dBm + 10log (42.47) = 27.28 dBm > 24 dBm.
5. 11 dBm + 10log (42.40) = 27.27 dBm > 24 dBm.
6. 11 dBm + 10log (36.42) = 26.61 dBm > 24 dBm.

Chain 1

1. 11 dBm + 10log (42.30) = 27.26 dBm > 24 dBm.
2. 11 dBm + 10log (42.38) = 27.27 dBm > 24 dBm.
3. 11 dBm + 10log (42.00) = 27.23 dBm > 24 dBm.
4. 11 dBm + 10log (42.46) = 27.28 dBm > 24 dBm.
5. 11 dBm + 10log (42.11) = 27.24 dBm > 24 dBm.
6. 11 dBm + 10log (36.24) = 26.59 dBm > 24 dBm.

802.11ac (VHT80)

Channel	Frequency (MHz)	Maximum Conducted Power (dBm)		Total Power (mW)	Total Power (dBm)	Power Limit (dBm)	Pass / Fail
		Chain 0	Chain 1				
42	5210	13.66	13.57	45.978	16.63	23.89	Pass
58	5290	13.25	13.72	44.685	16.50	23.89	Pass
106	5530	15.85	15.78	76.303	18.83	23.89	Pass
138	5690 (U-NII-2C)	18.76	18.46	145.308	21.62	23.89	Pass
138	5690 (U-NII-3)	3.61	3.68	4.630	6.66	29.89	Pass
155	5775	21.05	20.83	248.41	23.95	29.89	Pass

Note:

5210~5690 (U-NII-2C)MHz: Gain = 6.11dBi > 6dBi, so the limit shall be reduced to $24 - (6.11 - 6) = 23.89$ dBm.

5690 (U-NII-3)~5775MHz: Gain = 6.11dBi > 6dBi, so the limit shall be reduced to $30 - (6.11 - 6) = 29.89$ dBm.

For U-NII-2A, U-NII-2C Band:

Chain 0

1. $11 \text{ dBm} + 10 \log (83.57) = 30.22 \text{ dBm} > 24 \text{ dBm}$.
2. $11 \text{ dBm} + 10 \log (84.29) = 30.25 \text{ dBm} > 24 \text{ dBm}$.
3. $11 \text{ dBm} + 10 \log (76.78) = 29.85 \text{ dBm} > 24 \text{ dBm}$.

Chain 1

1. $11 \text{ dBm} + 10 \log (83.98) = 30.24 \text{ dBm} > 24 \text{ dBm}$.
2. $11 \text{ dBm} + 10 \log (83.79) = 30.23 \text{ dBm} > 24 \text{ dBm}$.
3. $11 \text{ dBm} + 10 \log (77.30) = 29.88 \text{ dBm} > 24 \text{ dBm}$.

Beamforming Mode

802.11ac (VHT20)

Channel	Frequency (MHz)	Maximum Conducted Power (dBm)		Total Power (mW)	Total Power (dBm)	Power Limit (dBm)	Pass / Fail
		Chain 0	Chain 1				
36	5180	10.48	10.11	21.425	13.31	20.88	Pass
40	5200	10.48	10.11	21.425	13.31	20.88	Pass
48	5240	10.55	10.12	21.63	13.35	20.88	Pass
52	5260	13.88	13.45	46.565	16.68	20.88	Pass
60	5300	13.79	13.59	46.789	16.70	20.88	Pass
64	5320	13.98	13.74	48.663	16.87	20.88	Pass
100	5500	17.12	17.23	104.367	20.19	20.88	Pass
116	5580	17.43	17.17	107.454	20.31	20.88	Pass
140	5700	17.30	16.97	103.477	20.15	20.88	Pass
144	5720 (U-NII-2C)	16.10	16.05	81.010	19.09	20.21	Pass
144	5720 (U-NII-3)	8.00	8.09	12.751	11.06	26.88	Pass
149	5745	22.54	22.93	375.809	25.75	26.88	Pass
157	5785	22.89	23.01	394.522	25.96	26.88	Pass
165	5825	22.73	22.99	386.567	25.87	26.88	Pass

Note:

5180~5240MHz: Directional Gain = 6.11dBi + 10log(2)=9.12dBi > 6dBi, so the limit shall be reduced to 24-(9.12-6) = 20.88dBm.

5260~5320MHz: Directional Gain = 6.11dBi + 10log(2)=9.12dBi > 6dBi, so the limit shall be reduced to 24-(9.12-6) = 20.88dBm.

5500~5700MHz: Directional Gain = 6.11dBi + 10log(2)=9.12dBi > 6dBi, so the limit shall be reduced to 24-(9.12-6) = 20.88dBm.

5720MHz: Directional Gain = 6.11dBi + 10log(2)=9.12dBi > 6dBi, so the limit shall be reduced to 23.33-(9.12-6) = 20.21dBm.

5745~5825MHz: Directional Gain = 6.11dBi + 10log(2)=9.12dBi > 6dBi, so the limit shall be reduced to 30-(9.12-6) = 26.88dBm.

Note:

For U-NII-2A, U-NII-2C Band:

Chain 0

1. 11 dBm + 10log (25.26) = 25.02 dBm > 24 dBm.
2. 11 dBm + 10log (25.19) = 25.01 dBm > 24 dBm.
3. 11 dBm + 10log (24.35) = 24.86 dBm > 24 dBm.
4. 11 dBm + 10log (25.12) = 25.00 dBm > 24 dBm.
5. 11 dBm + 10log (25.38) = 25.04 dBm > 24 dBm.
6. 11 dBm + 10log (25.15) = 25.00 dBm > 24 dBm.
7. 11 dBm + 10log (17.27) = 23.37 dBm < 24 dBm.

Chain 1

1. 11 dBm + 10log (24.83) = 24.95 dBm > 24 dBm.
2. 11 dBm + 10log (24.63) = 24.91 dBm > 24 dBm.
3. 11 dBm + 10log (24.90) = 24.96 dBm > 24 dBm.
4. 11 dBm + 10log (25.35) = 25.04 dBm > 24 dBm.
5. 11 dBm + 10log (25.01) = 24.98 dBm > 24 dBm.
6. 11 dBm + 10log (25.29) = 25.02 dBm > 24 dBm.
7. 11 dBm + 10log (17.11) = 23.33 dBm < 24 dBm.

802.11ac (VHT40)

Channel	Frequency (MHz)	Maximum Conducted Power (dBm)		Total Power (mW)	Total Power (dBm)	Power Limit (dBm)	Pass / Fail
		Chain 0	Chain 1				
38	5190	10.68	10.81	23.745	13.76	20.88	Pass
46	5230	10.90	10.62	23.837	13.77	20.88	Pass
54	5270	13.85	13.69	47.654	16.78	20.88	Pass
62	5310	13.55	13.49	44.982	16.53	20.88	Pass
102	5510	17.31	17.11	105.231	20.22	20.88	Pass
110	5550	17.81	17.73	119.687	20.78	20.88	Pass
134	5670	17.66	17.53	114.968	20.61	20.88	Pass
142	5710 (U-NII-2C)	17.42	17.06	106.024	20.25	20.88	Pass
142	5710 (U-NII-3)	6.80	5.95	8.722	9.41	26.88	Pass
151	5755	22.78	23.22	399.565	26.02	26.88	Pass
159	5795	23.11	23.15	411.182	26.14	26.88	Pass

Note:

5180~5240MHz: Directional Gain = 6.11dB_i + 10log(2)=9.12dB_i > 6dB_i, so the limit shall be reduced to 24-(9.12-6) = 20.88dBm.

5260~5320MHz: Directional Gain = 6.11dB_i + 10log(2)=9.12dB_i > 6dB_i, so the limit shall be reduced to 24-(9.12-6) = 20.88dBm.

5500~5720MHz: Directional Gain = 6.11dB_i + 10log(2)=9.12dB_i > 6dB_i, so the limit shall be reduced to 24-(9.12-6) = 20.88dBm.

5745~5825MHz: Directional Gain = 6.11dB_i + 10log(2)=9.12dB_i > 6dB_i, so the limit shall be reduced to 30-(9.12-6) = 26.88dBm.

For U-NII-2A, U-NII-2C Band:
Chain 0

1. 11 dBm + 10log (42.80) = 27.31 dBm > 24 dBm.
2. 11 dBm + 10log (42.52) = 27.28 dBm > 24 dBm.
3. 11 dBm + 10log (42.23) = 27.25 dBm > 24 dBm.
4. 11 dBm + 10log (42.47) = 27.28 dBm > 24 dBm.
5. 11 dBm + 10log (42.40) = 27.27 dBm > 24 dBm.
6. 11 dBm + 10log (36.42) = 26.61 dBm > 24 dBm.

Chain 1

1. 11 dBm + 10log (42.30) = 27.26 dBm > 24 dBm.
2. 11 dBm + 10log (42.38) = 27.27 dBm > 24 dBm.
3. 11 dBm + 10log (42.00) = 27.23 dBm > 24 dBm.
4. 11 dBm + 10log (42.46) = 27.28 dBm > 24 dBm.
5. 11 dBm + 10log (42.11) = 27.24 dBm > 24 dBm.
6. 11 dBm + 10log (36.24) = 26.59 dBm > 24 dBm.

802.11ac (VHT80)

Channel	Frequency (MHz)	Maximum Conducted Power (dBm)		Total Power (mW)	Total Power (dBm)	Power Limit (dBm)	Pass / Fail
		Chain 0	Chain 1				
42	5210	10.76	10.67	23.581	13.73	20.88	Pass
58	5290	13.25	13.72	44.685	16.50	20.88	Pass
106	5530	15.85	15.78	76.303	18.83	20.88	Pass
138	5690 (U-NII-2C)	16.96	16.66	96.004	19.82	20.88	Pass
138	5690 (U-NII-3)	1.81	1.88	3.059	4.86	26.88	Pass
155	5775	21.05	20.83	248.41	23.95	26.88	Pass

Note:

5180~5240MHz: Directional Gain = 6.11dBi + 10log(2)=9.12dBi > 6dBi, so the limit shall be reduced to 24-(9.12-6) = 20.88dBm.

5260~5320MHz: Directional Gain = 6.11dBi + 10log(2)=9.12dBi > 6dBi, so the limit shall be reduced to 24-(9.12-6) = 20.88dBm.

5500~5720MHz: Directional Gain = 6.11dBi + 10log(2)=9.12dBi > 6dBi, so the limit shall be reduced to 24-(9.12-6) = 20.88dBm.

5745~5825MHz: Directional Gain = 6.11dBi + 10log(2)=9.12dBi > 6dBi, so the limit shall be reduced to 30-(9.12-6) = 26.88dBm.

For U-NII-2A, U-NII-2C Band:

Chain 0

1. 11 dBm + 10log (83.57) = 30.22 dBm > 24 dBm.
2. 11 dBm + 10log (84.29) = 30.25 dBm > 24 dBm.
3. 11 dBm + 10log (76.78) = 29.85 dBm > 24 dBm.

Chain 1

1. 11 dBm + 10log (83.98) = 30.24 dBm > 24 dBm.
2. 11 dBm + 10log (83.79) = 30.23 dBm > 24 dBm.
3. 11 dBm + 10log (77.30) = 29.88 dBm > 24 dBm.

Straddle channel power plots:

802.11a

Chain 0

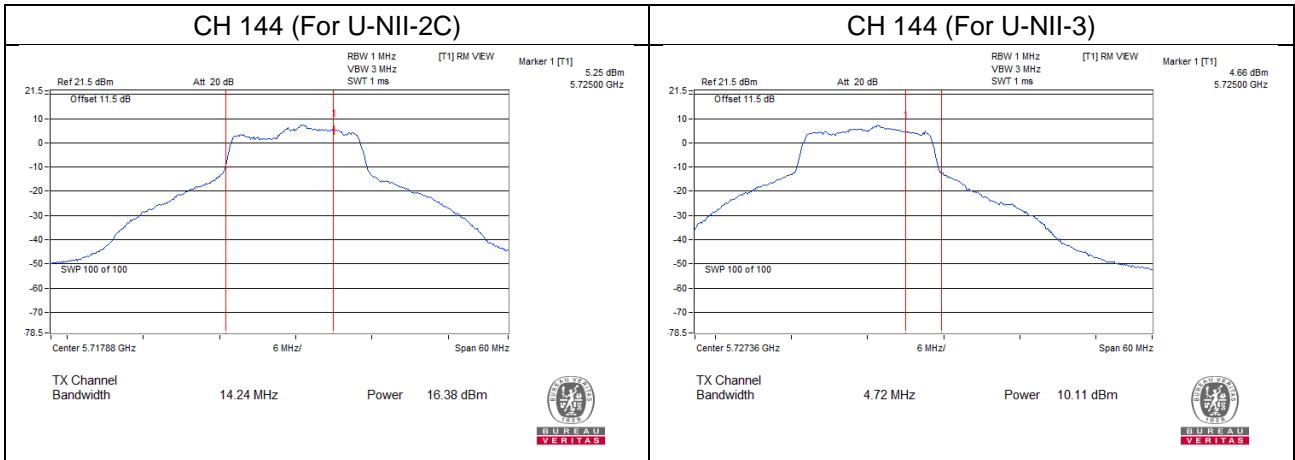

Chain 1

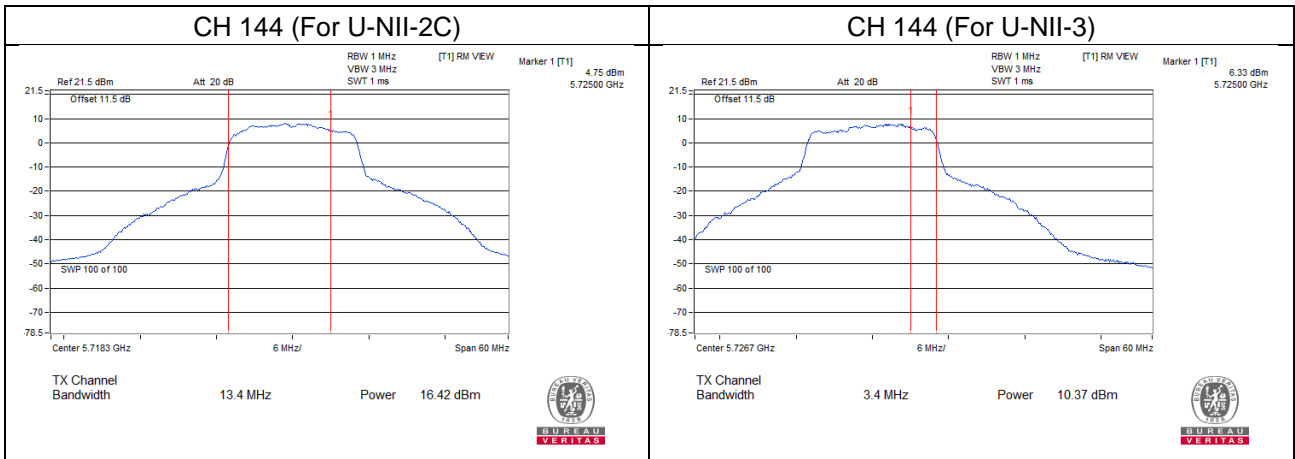

802.11ac (VHT20)
Chain 0

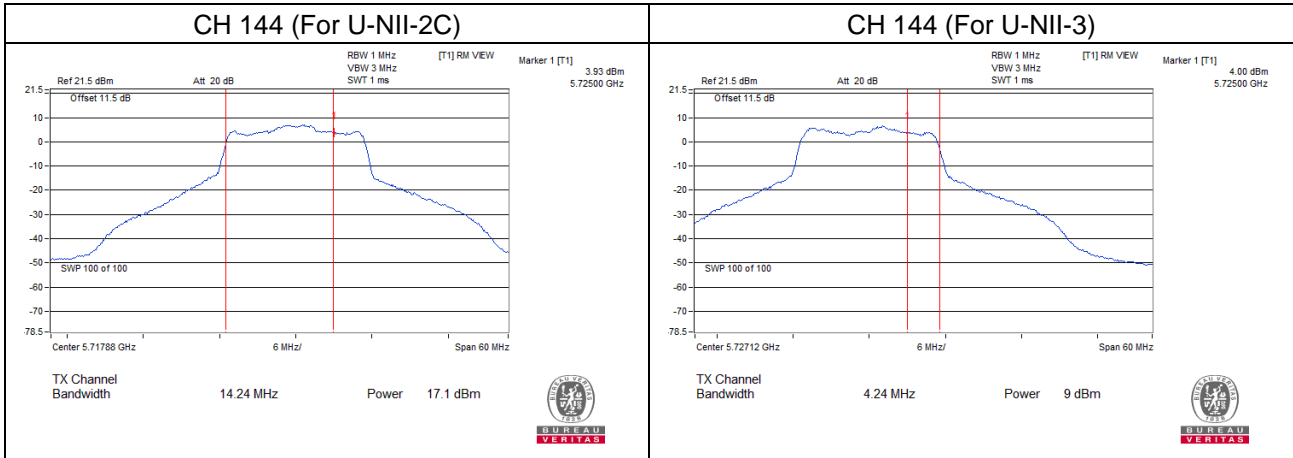

Chain 1

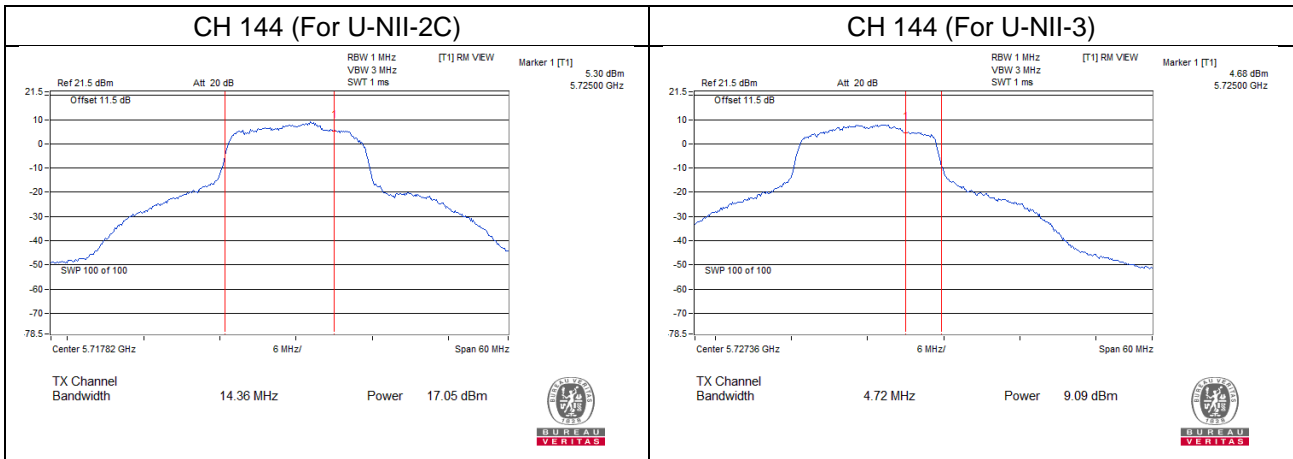

802.11ac (VHT40)
Chain 0

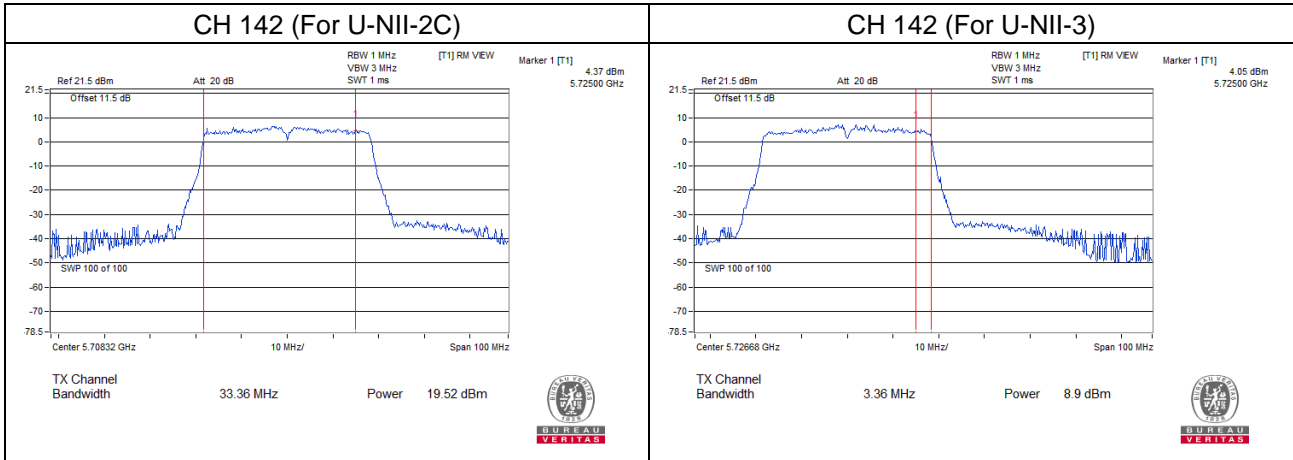

Chain 1

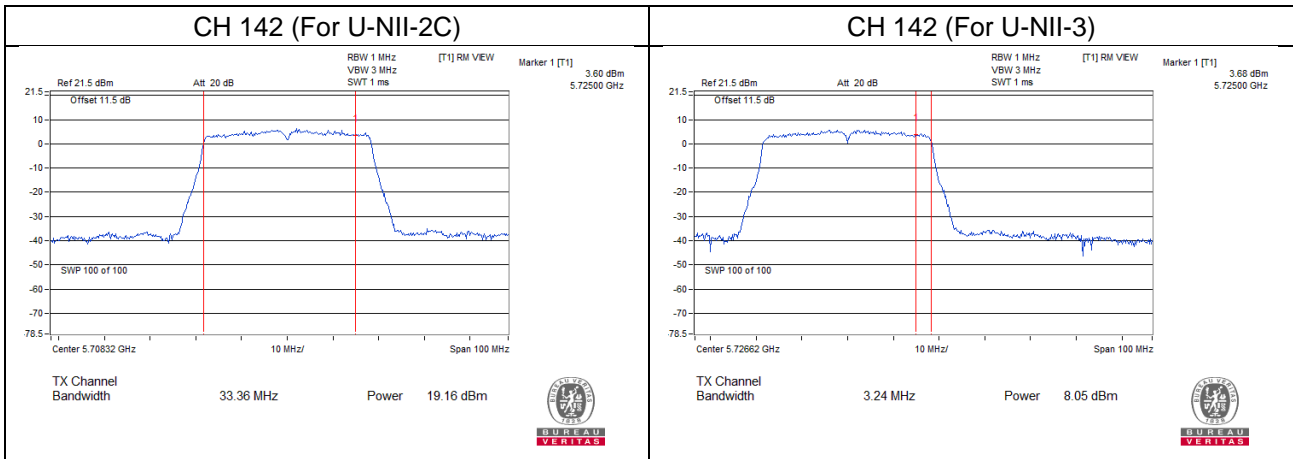

802.11ac (VHT80)
Chain 0

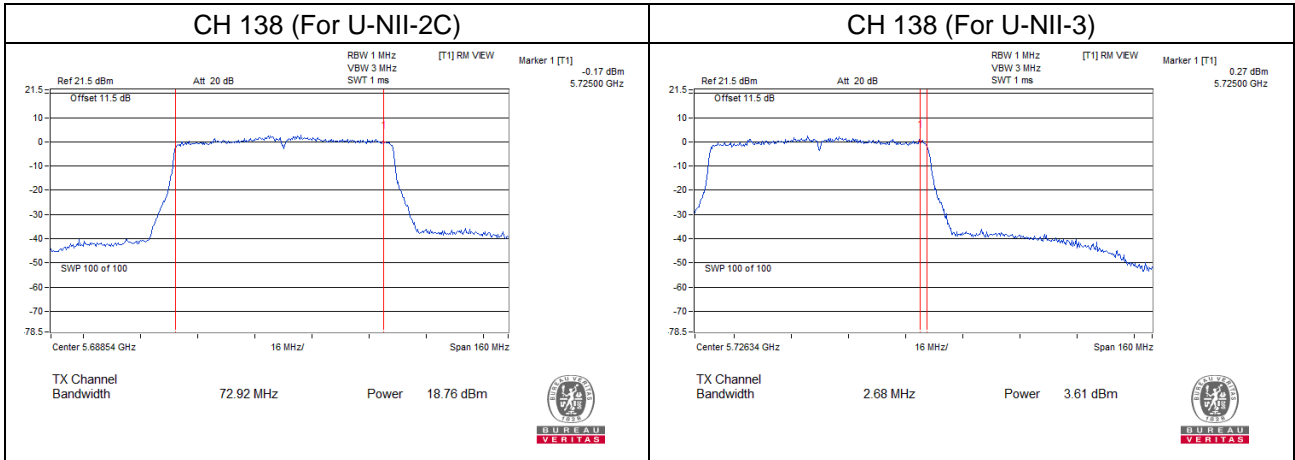

Chain 1

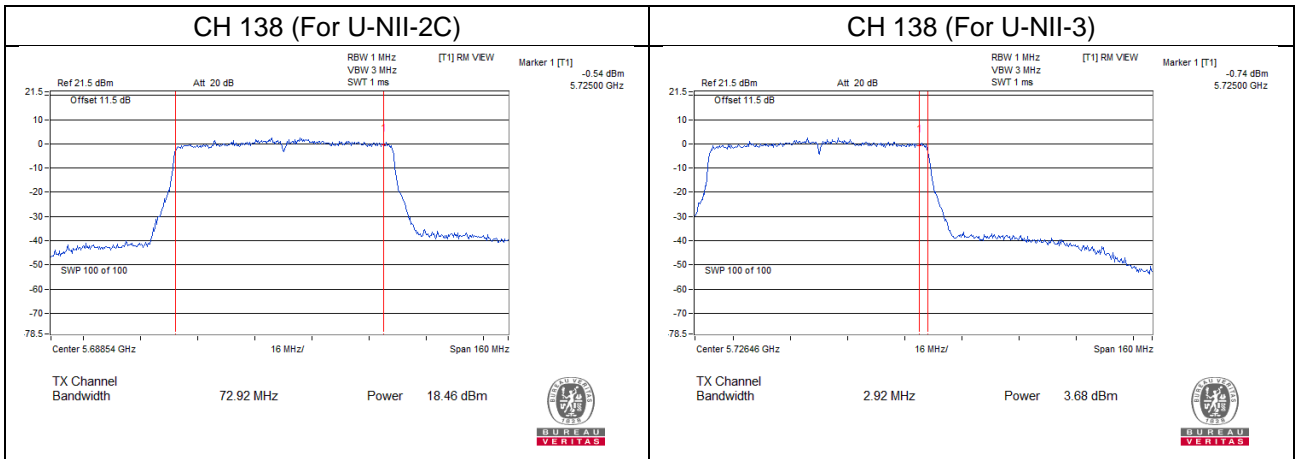

26 dB Bandwidth:
802.11a

Channel	Frequency (MHz)	26 dBc Bandwidth (MHz)	
		Chain 0	Chain 1
36	5180	22.71	22.92
40	5200	23.75	23.23
48	5240	23.06	23.16
52	5260	23.30	23.29
60	5300	23.59	22.76
64	5320	23.48	24.06
100	5500	23.65	23.61
116	5580	23.39	23.01
140	5700	23.32	23.85
144	5720 (U-NII-2C)	16.90	16.82
144	5720 (U-NII-3)	6.95	6.49

802.11 ac (VHT20)

Channel	Frequency (MHz)	26 dBc Bandwidth (MHz)	
		Chain 0	Chain 1
36	5180	24.97	24.38
40	5200	25.37	24.39
48	5240	24.24	25.15
52	5260	25.26	24.83
60	5300	25.19	24.63
64	5320	24.35	24.90
100	5500	25.12	25.35
116	5580	25.38	25.01
140	5700	25.15	25.29
144	5720 (U-NII-2C)	17.27	17.11
144	5720 (U-NII-3)	7.77	7.47

802.11 ac (VHT40)

Channel	Frequency (MHz)	26 dBc Bandwidth (MHz)	
		Chain 0	Chain 1
38	5190	42.54	42.25
46	5230	42.15	42.22
54	5270	42.80	42.30
62	5310	42.52	42.38
102	5510	42.23	42.00
110	5550	42.47	42.46
134	5670	42.40	42.11
142	5710 (U-NII-2C)	36.42	36.24
142	5710 (U-NII-3)	6.36	6.15

802.11ac (VHT80)

Channel	Frequency (MHz)	26 dBc Bandwidth (MHz)	
		Chain 0	Chain 1
42	5210	83.82	84.55
58	5290	83.57	83.98
106	5530	84.29	83.79
138	5690 (U-NII-2C)	76.78	77.30
138	5690 (U-NII-3)	7.73	7.24

Spectrum Plot of Worst Value

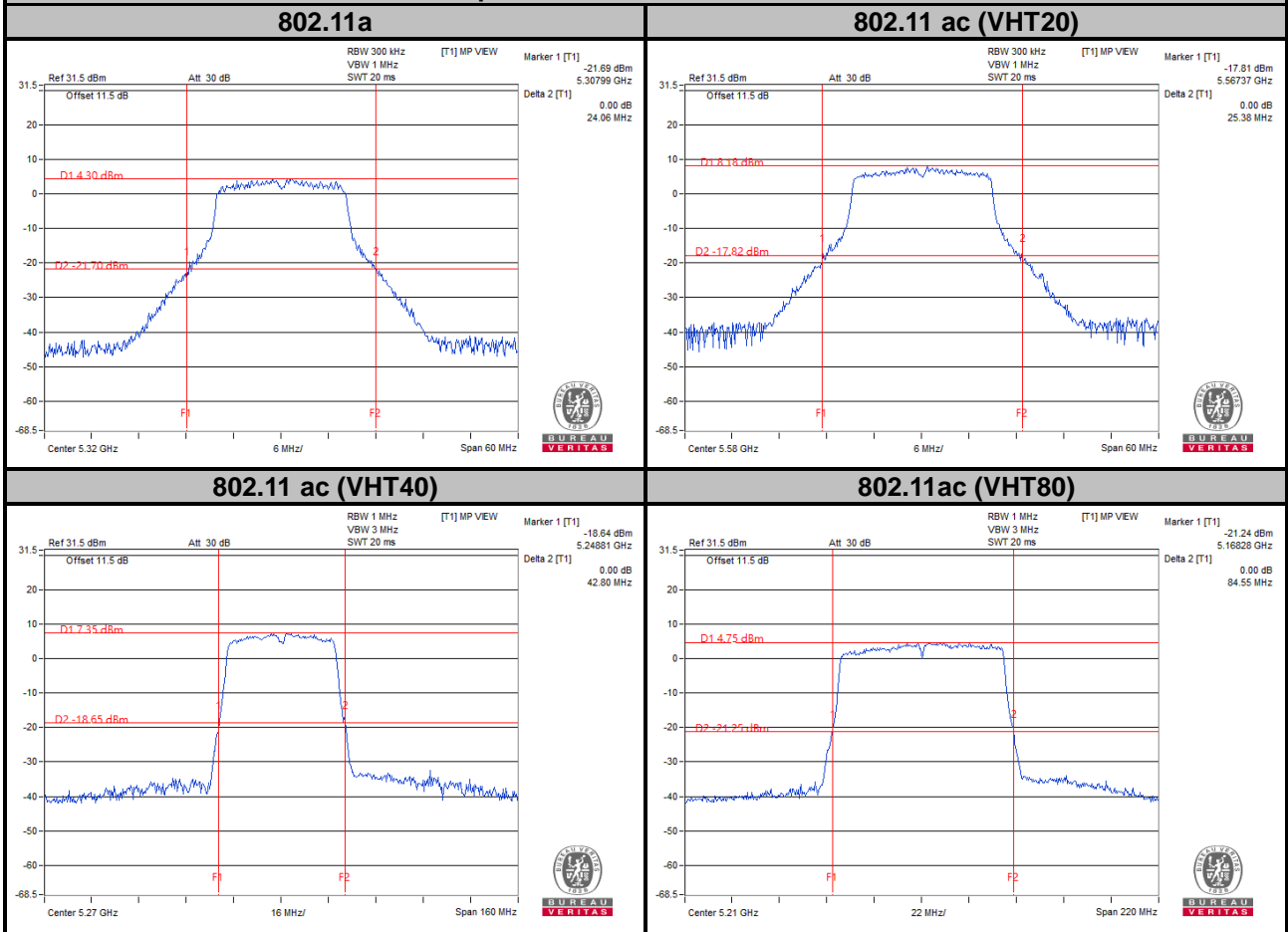

EUT HIGHEST AND LOWEST CONDUCTED POWER

CDD Mode

802.11a

Frequency Band (MHz)	Max. Power	
	Output Power (mW)	Output Power (dBm)
5250~5350	48.092	16.82
5470~5725	112.345	20.51

802.11ac (VHT20)

Frequency Band (MHz)	Max. Power	
	Output Power (mW)	Output Power (dBm)
5250~5350	48.663	16.87
5470~5725	110.877	20.45

802.11ac (VHT40)

Frequency Band (MHz)	Max. Power	
	Output Power (mW)	Output Power (dBm)
5250~5350	47.654	16.78
5470~5725	217.795	23.38

802.11ac (VHT80)

Frequency Band (MHz)	Max. Power	
	Output Power (mW)	Output Power (dBm)
5250~5350	44.685	16.50
5470~5725	145.308	21.62

Beamforming Mode

802.11ac (VHT20)

Frequency Band (MHz)	Max. Power	
	Output Power (mW)	Output Power (dBm)
5250~5350	48.663	16.87
5470~5725	107.454	20.31

802.11ac (VHT40)

Frequency Band (MHz)	Max. Power	
	Output Power (mW)	Output Power (dBm)
5250~5350	47.654	16.78
5470~5725	119.687	20.78

802.11ac (VHT80)

Frequency Band (MHz)	Max. Power	
	Output Power (mW)	Output Power (dBm)
5250~5350	44.685	16.50
5470~5725	96.004	19.82

4.4 Occupied Bandwidth Measurement

4.4.1 Test Setup

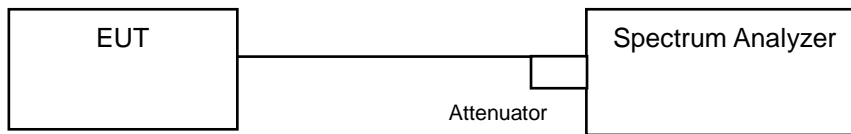

4.4.2 Test Instruments

Refer to section 4.1.2 to get information of above instrument.

4.4.3 Test Procedure

The transmitter output was connected to the spectrum analyzer through an attenuator. The bandwidth of the fundamental frequency was measured by spectrum analyzer with resolution bandwidth in the range of 1 % to 5 % of the anticipated emission bandwidth, and a video bandwidth at least 3x the resolution bandwidth and set the detector to SAMPLE. The width of a frequency band such that, below the lower and above the upper frequency limits, the mean powers emitted are each equal to a specified percentage 0.5 % of the total mean power of a given emission.

4.4.4 Test Results

802.11a

Channel	Channel Frequency (MHz)	Occupied Bandwidth (MHz)	
		Chain 0	Chain 1
36	5180	16.80	16.80
40	5200	16.80	16.80
48	5240	16.80	16.68
52	5260	16.80	16.80
60	5300	16.80	16.80
64	5320	16.68	16.80
100	5500	16.80	16.80
116	5580	16.80	16.80
140	5700	16.80	16.80
144	5720 (U-NII-2C)	13.40	13.40
144	5720 (U-NII-3)	3.40	3.40
149	5745	29.64	28.68
157	5785	31.08	27.48
165	5825	32.28	30.00

802.11ac (VHT20)

Channel	Channel Frequency (MHz)	Occupied Bandwidth (MHz)	
		Chain 0	Chain 1
36	5180	17.88	17.88
40	5200	17.88	18.00
48	5240	18.00	18.00
52	5260	18.00	18.00
60	5300	18.00	18.00
64	5320	18.00	18.00
100	5500	18.00	18.00
116	5580	18.00	18.00
140	5700	17.88	18.00
144	5720 (U-NII-2C)	14.00	14.00
144	5720 (U-NII-3)	4.00	4.00
149	5745	32.04	29.40
157	5785	33.24	28.56
165	5825	33.48	31.68

802.11ac (VHT40)

Channel	Channel Frequency (MHz)	Occupied Bandwidth (MHz)	
		Chain 0	Chain 1
38	5190	36.48	36.48
46	5230	36.60	36.48
54	5270	36.48	36.48
62	5310	36.48	36.48
102	5510	36.60	36.60
110	5550	36.72	36.60
134	5670	36.60	36.60
142	5710 (U-NII-2C)	33.36	33.36
142	5710 (U-NII-3)	3.36	3.24
151	5755	45.48	41.52
159	5795	46.92	40.80

802.11ac (VHT80)

Channel	Channel Frequency (MHz)	Occupied Bandwidth (MHz)	
		Chain 0	Chain 1
42	5210	75.84	75.84
58	5290	75.84	75.84
106	5530	75.84	75.84
138	5690 (U-NII-2C)	72.92	72.92
138	5690 (U-NII-3)	2.68	2.92
155	5775	76.32	76.32

Spectrum Plot of Worst Value

802.11a

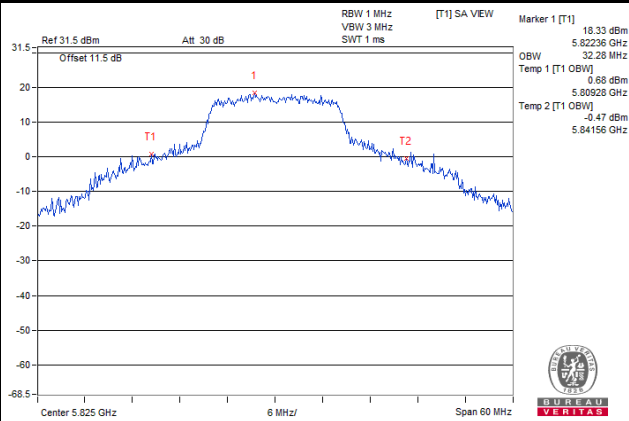

802.11ac (VHT20)

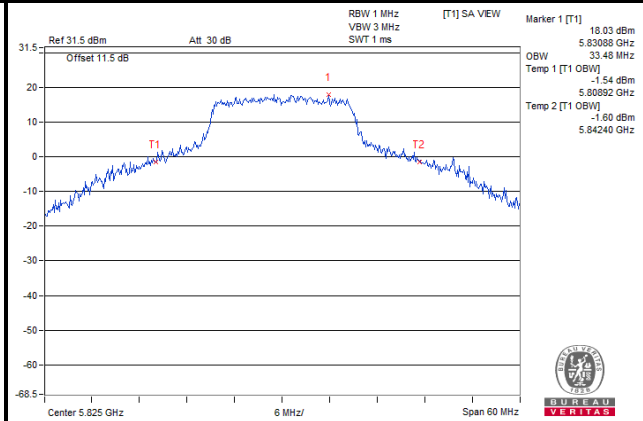

802.11ac (VHT40)

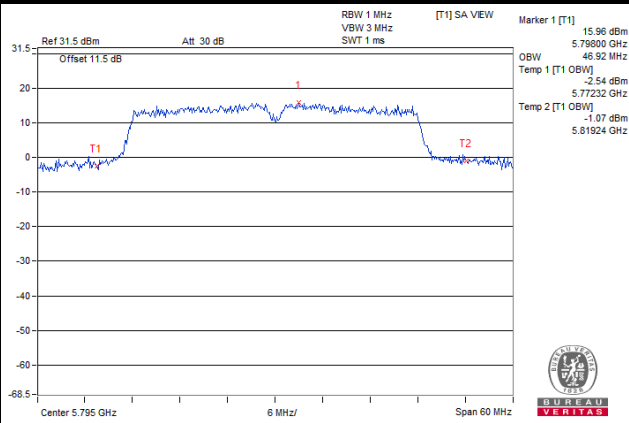

802.11ac (VHT80)

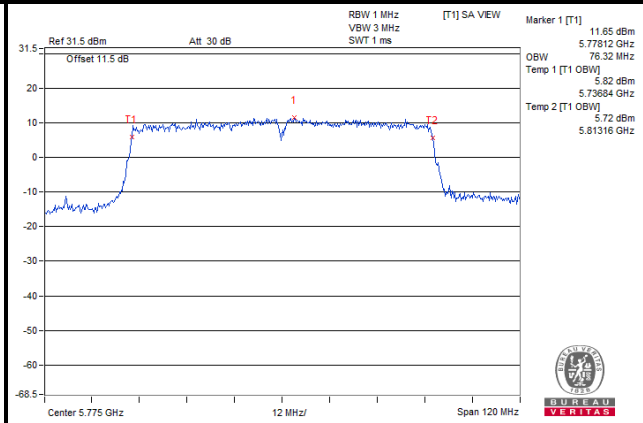

Chain 0

Spectrum Plot for Nearby DFS Band
802.11a

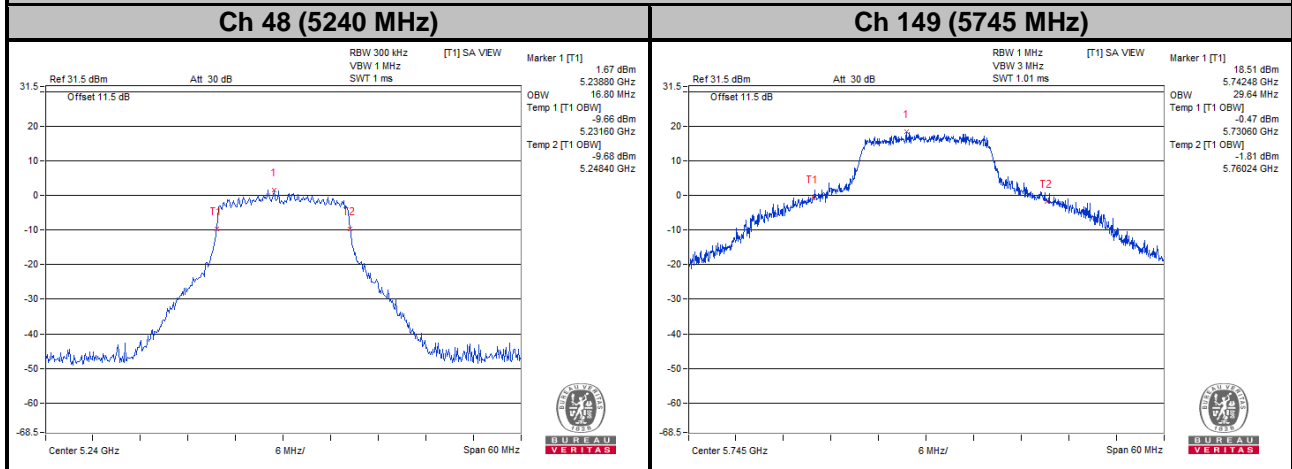

802.11ac (VHT20)

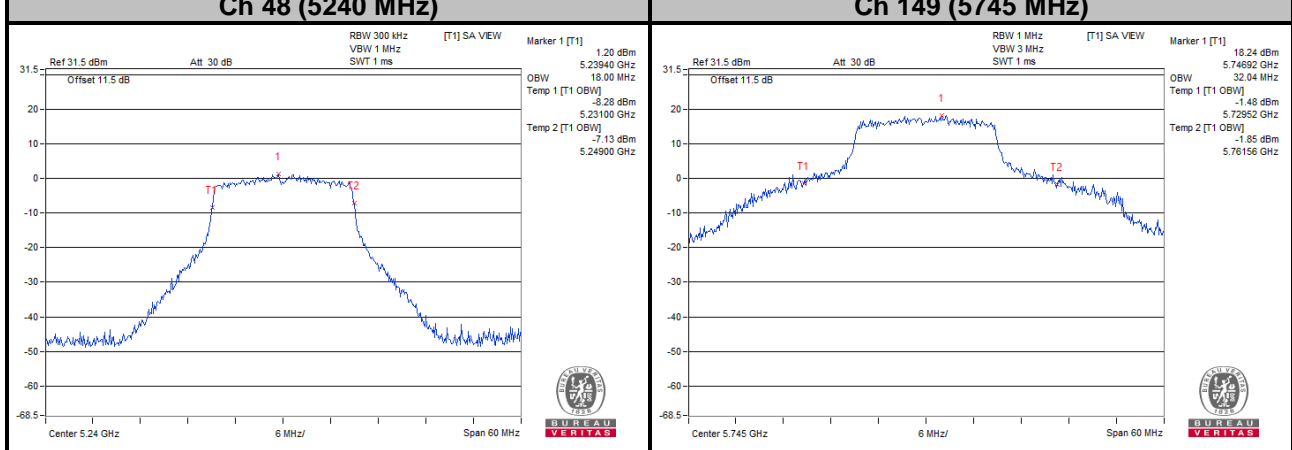

802.11ac (VHT40)

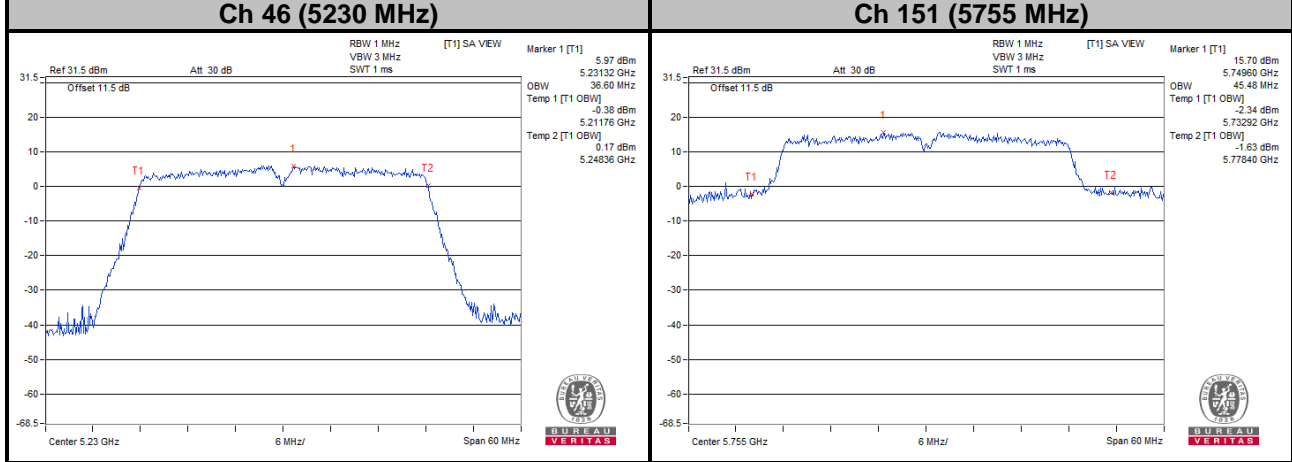

802.11ac (VHT80)

Ch 42 (5210 MHz)

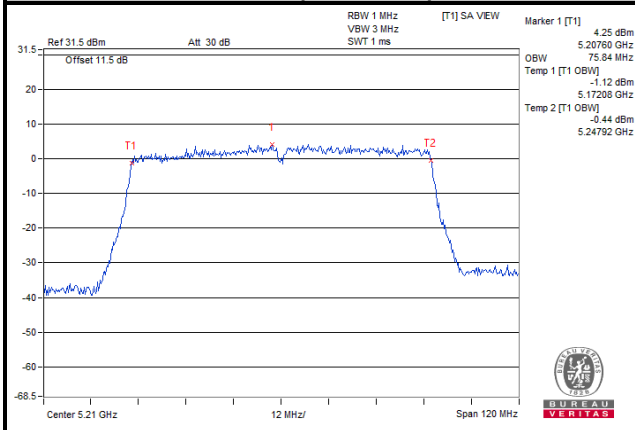

Ch 155 (5775 MHz)

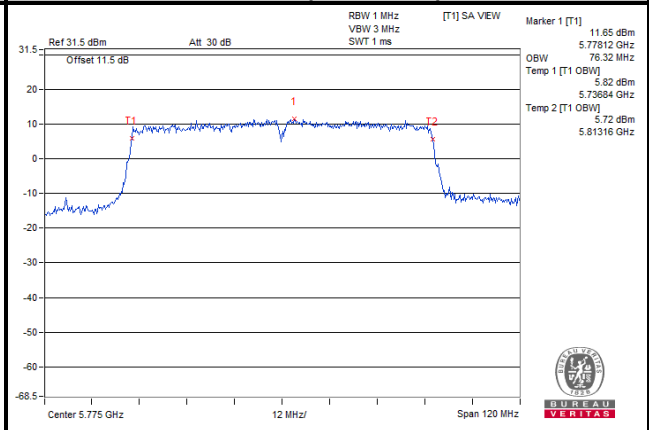

Chain 1

Spectrum Plot for Nearby DFS Band
802.11a

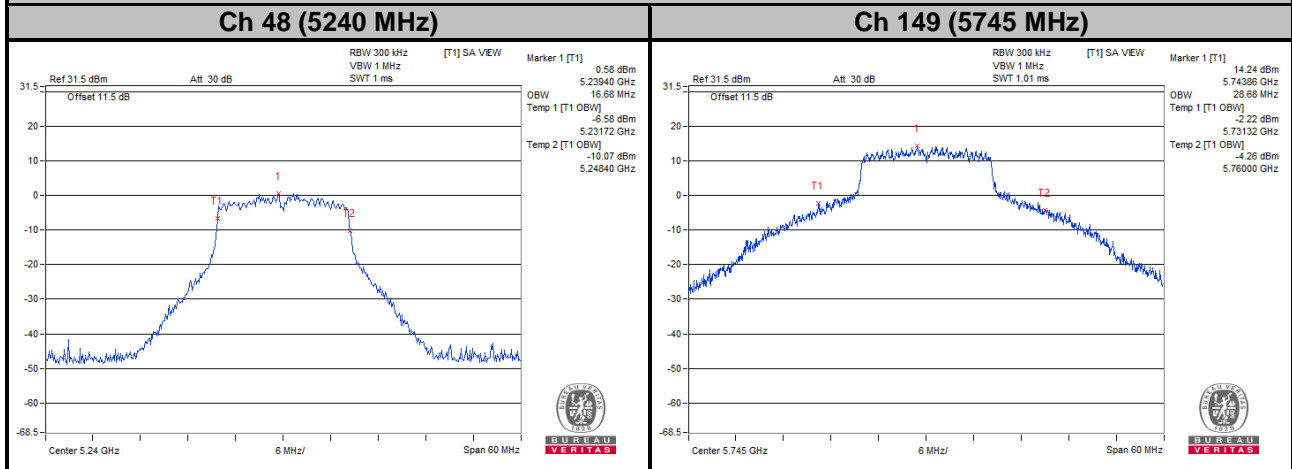

802.11ac (VHT20)

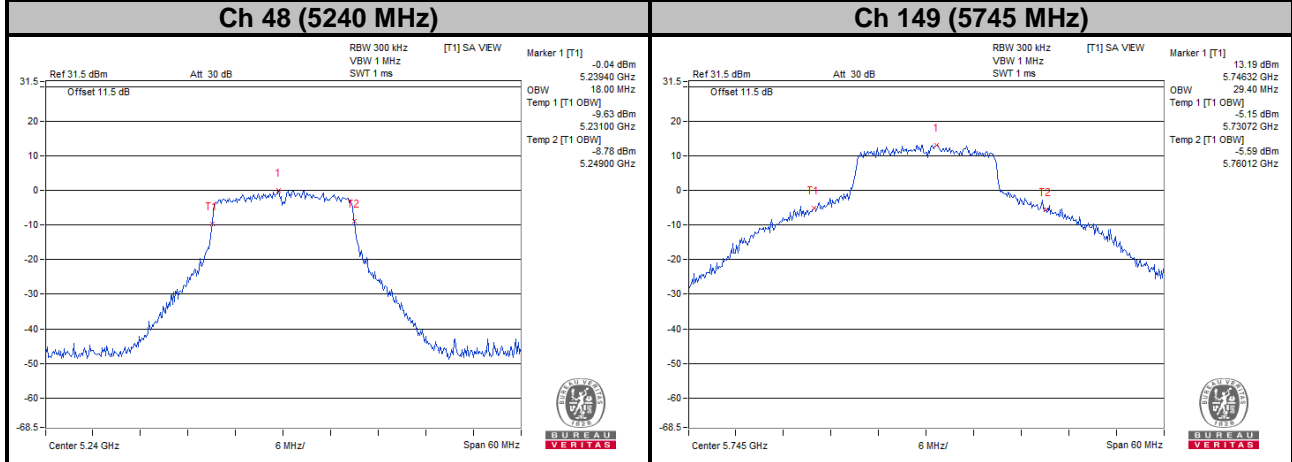

802.11ac (VHT40)

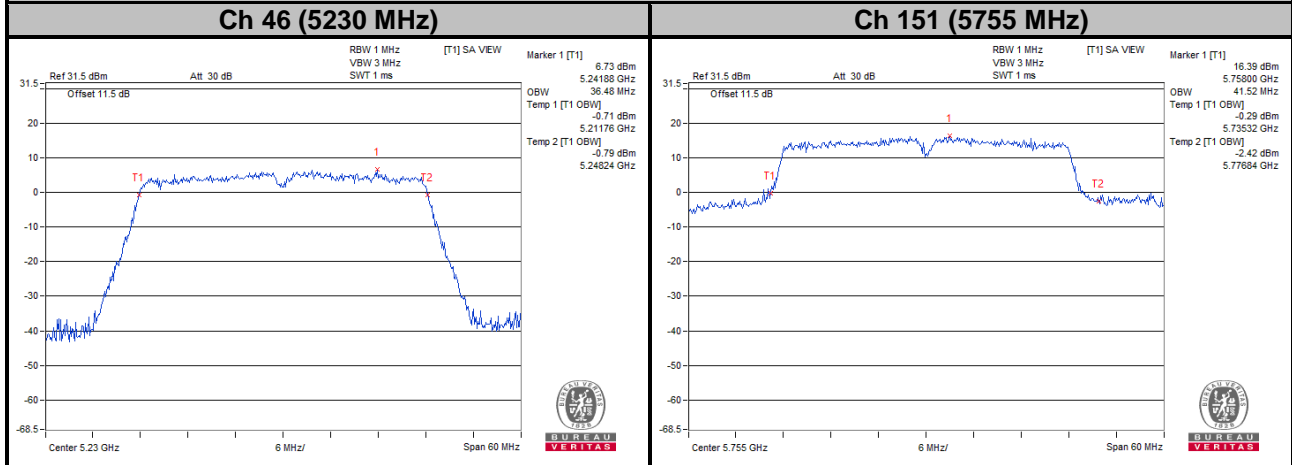

802.11ac (VHT80)

Ch 42 (5210 MHz)

Ch 155 (5775 MHz)

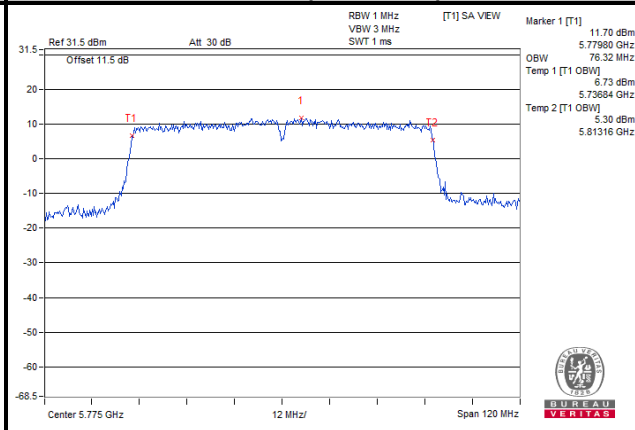
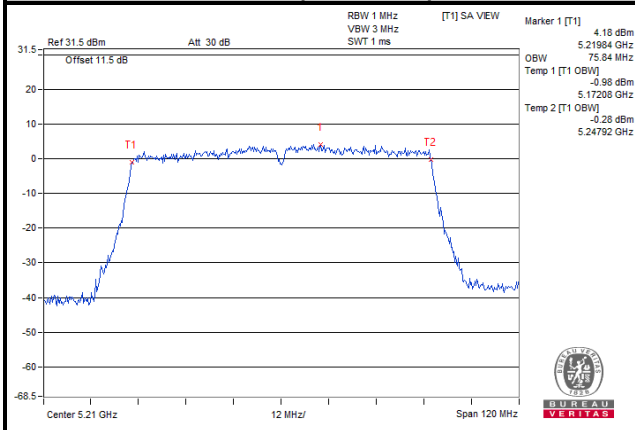

4.5 Peak Power Spectral Density Measurement

4.5.1 Limits of Peak Power Spectral Density Measurement

Operation Band	EUT Category		Limit
U-NII-1		Outdoor Access Point	17 dBm/MHz
		Fixed point-to-point Access Point	
		Indoor Access Point	
	√	Mobile and Portable client device	11 dBm/MHz
U-NII-2A		√	11 dBm/MHz
U-NII-2C		√	11 dBm/MHz
U-NII-3		√	30 dBm/500 kHz

4.5.2 Test Setup

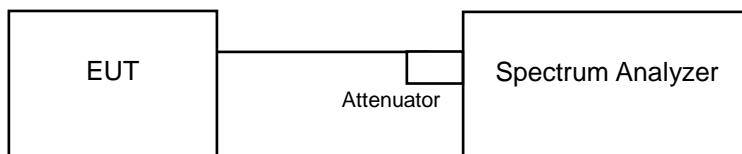

4.5.3 Test Instruments

Refer to section 4.1.2 to get information of above instrument.

4.5.4 Test Procedures

For U-NII-1, U-NII-2A, U-NII-2C band:

Using method SA-2 Duty cycle <98%

1. Set span to encompass the entire emission bandwidth (EBW) of the signal.
2. Set RBW = 1 MHz, Set VBW ≥ 3 RBW, Detector = RMS
3. Sweep time = auto, trigger set to "free run".
4. Trace average at least 100 traces in power averaging mode.
5. Record the max value and add 10 log (1/duty cycle)

※ For U-NII-3: with duty cycle & Duty cycle <98 %

1. Set span to encompass the entire emission bandwidth (EBW) of the signal.
2. Set RBW = 300 kHz, Set VBW \geq 1 RBW, Detector = RMS
3. Use the peak marker function to determine the maximum power level in any 300 kHz band segment within the fundamental EBW.
4. Scale the observed power level to an equivalent value in 500 kHz by adjusting (increasing) the measured power by a bandwidth correction factor (BWCF) where $BWCF = 10\log(500 \text{ kHz} / 300 \text{ kHz})$.
5. Sweep time = auto, trigger set to "free run".
6. Trace average at least 100 traces in power averaging mode.
7. Record the max value and add $10 \log (1/\text{duty cycle})$

4.5.5 Deviation from Test Standard

No deviation.

4.5.6 EUT Operating Conditions

The software provided by client to enable the EUT under transmission condition continuously at lowest, middle and highest channel frequencies individually.

4.5.7 Test Results

For U-NII-1, U-NII-2A, U-NII-2C Band

802.11a

Channel	Frequency (MHz)	PSD (dBm/MHz)		Duty Factor (dB)	Total PSD with Duty Factor (dBm/MHz)	Max. Limit (dBm/MHz)	Pass / Fail
		Chain 0	Chain 1				
36	5180	-2.31	-2.55	0.23	0.81	7.88	Pass
40	5200	-2.39	-2.43	0.23	0.83	7.88	Pass
48	5240	-2.36	-2.51	0.23	0.81	7.88	Pass
52	5260	0.76	0.75	0.23	4.00	7.88	Pass
60	5300	0.89	0.63	0.23	4.00	7.88	Pass
64	5320	0.88	1.04	0.23	4.20	7.88	Pass
100	5500	4.39	4.59	0.23	7.73	7.88	Pass
116	5580	4.76	4.24	0.23	7.75	7.88	Pass
140	5700	4.72	4.46	0.23	7.83	7.88	Pass
144	5720 (U-NII-2C)	4.61	4.50	0.23	7.80	7.88	Pass

Note:

- Method E) 2) a) of power density measurement of KDB 662911 is using for calculating total power density. Total power density is summing entire spectra across corresponding frequency bins on the various outputs by computer.
- For U-NII-1 Band:**
 Directional gain = 6.11 dBi + 10log(2) = 9.12 dBi > 6 dBi , so the power density limit shall be reduced to 11-(9.12-6) = 7.88 dBm.
For U-NII-2A, U-NII-2C Band:
 Directional gain = 6.11 dBi + 10log(2) = 9.12 dBi > 6 dBi , so the power density limit shall be reduced to 11-(9.12-6) = 7.88 dBm.
- Refer to section 3.3 for duty cycle spectrum plot.

802.11ac (VHT20)

Channel	Frequency (MHz)	PSD (dBm/MHz)		Duty Factor (dB)	Total PSD with Duty Factor (dBm/MHz)	Max. Limit (dBm/MHz)	Pass / Fail
		Chain 0	Chain 1				
36	5180	-2.61	-2.42	0.22	0.72	7.88	Pass
40	5200	-2.44	-2.40	0.22	0.81	7.88	Pass
48	5240	-2.01	-2.79	0.22	0.85	7.88	Pass
52	5260	0.74	0.76	0.22	3.98	7.88	Pass
60	5300	0.63	0.66	0.22	3.88	7.88	Pass
64	5320	0.91	1.17	0.22	4.27	7.88	Pass
100	5500	4.59	4.60	0.22	7.83	7.88	Pass
116	5580	4.57	4.09	0.22	7.57	7.88	Pass
140	5700	4.91	4.20	0.22	7.80	7.88	Pass
144	5720 (U-NII-2C)	5.08	4.00	0.22	7.81	7.88	Pass

Note:

- Method E) 2) a) of power density measurement of KDB 662911 is using for calculating total power density. Total power density is summing entire spectra across corresponding frequency bins on the various outputs by computer.
- For U-NII-1 Band:**
 Directional gain = $6.11 \text{ dBi} + 10\log(2) = 9.12 \text{ dBi} > 6 \text{ dBi}$, so the power density limit shall be reduced to $11-(9.12-6) = 7.88 \text{ dBm}$.
For U-NII-2A, U-NII-2C Band:
 Directional gain = $6.11 \text{ dBi} + 10\log(2) = 9.12 \text{ dBi} > 6 \text{ dBi}$, so the power density limit shall be reduced to $11-(9.12-6) = 7.88 \text{ dBm}$.
- Refer to section 3.3 for duty cycle spectrum plot.

802.11ac (VHT40)

Channel	Frequency (MHz)	PSD (dBm/MHz)		Duty Factor (dB)	Total PSD with Duty Factor (dBm/MHz)	Max. Limit (dBm/MHz)	Pass / Fail
		Chain 0	Chain 1				
38	5190	-2.97	-2.53	0.51	0.77	7.88	Pass
46	5230	-2.70	-2.63	0.51	0.85	7.88	Pass
54	5270	-1.98	-2.06	0.51	1.50	7.88	Pass
62	5310	-2.66	-2.39	0.51	1.00	7.88	Pass
102	5510	1.93	1.87	0.51	5.42	7.88	Pass
110	5550	4.40	4.27	0.51	7.85	7.88	Pass
134	5670	3.99	3.78	0.51	7.40	7.88	Pass
142	5710 (U-NII-2C)	4.34	4.18	0.51	7.78	7.88	Pass

Note:

- Method E) 2) a) of power density measurement of KDB 662911 is using for calculating total power density. Total power density is summing entire spectra across corresponding frequency bins on the various outputs by computer.
- For U-NII-1 Band:**
 Directional gain = 6.11 dBi + 10log(2) = 9.12 dBi > 6 dBi , so the power density limit shall be reduced to 11-(9.12-6) = 7.88 dBm.
For U-NII-2A, U-NII-2C Band:
 Directional gain = 6.11 dBi + 10log(2) = 9.12 dBi > 6 dBi , so the power density limit shall be reduced to 11-(9.12-6) = 7.88 dBm.
- Refer to section 3.3 for duty cycle spectrum plot.

802.11ac (VHT80)

Channel	Frequency (MHz)	PSD (dBm/MHz)		Duty Factor (dB)	Total PSD with Duty Factor (dBm/MHz)	Max. Limit (dBm/MHz)	Pass / Fail
		Chain 0	Chain 1				
42	5210	-5.23	-5.23	0.89	-1.33	7.88	Pass
58	5290	-5.33	-4.94	0.89	-1.23	7.88	Pass
106	5530	-3.30	-3.51	0.89	0.49	7.88	Pass
138	5690 (U-NII-2C)	1.22	1.11	0.89	5.06	7.88	Pass

Note:

- Method E) 2) a) of power density measurement of KDB 662911 is using for calculating total power density. Total power density is summing entire spectra across corresponding frequency bins on the various outputs by computer.
- For U-NII-1 Band:**
 Directional gain = 6.11 dBi + 10log(2) = 9.12 dBi > 6 dBi , so the power density limit shall be reduced to 11-(9.12-6) = 7.88 dBm.
For U-NII-2A, U-NII-2C Band:
 Directional gain = 6.11 dBi + 10log(2) = 9.12 dBi > 6 dBi , so the power density limit shall be reduced to 11-(9.12-6) = 7.88 dBm.
- Refer to section 3.3 for duty cycle spectrum plot.

Spectrum Plot of Worst Value

802.11a

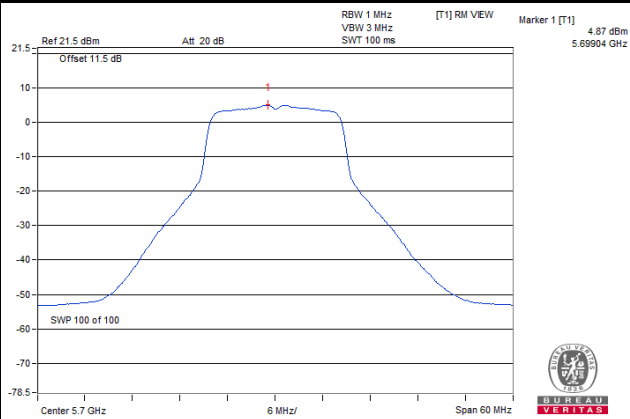

802.11ac (VHT20)

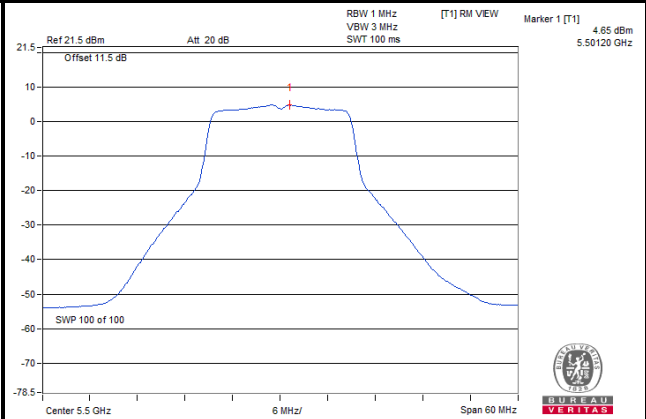

802.11ac (VHT40)

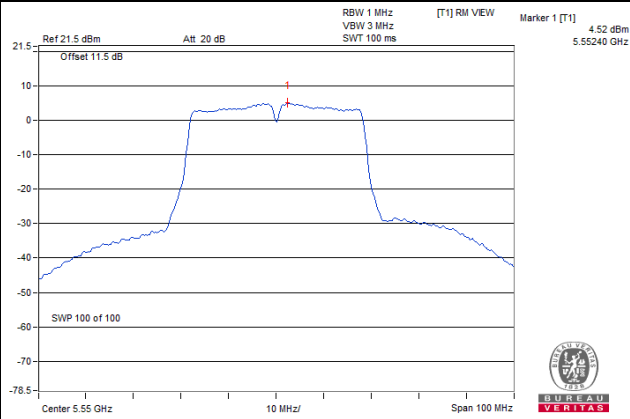

802.11ac (VHT80)

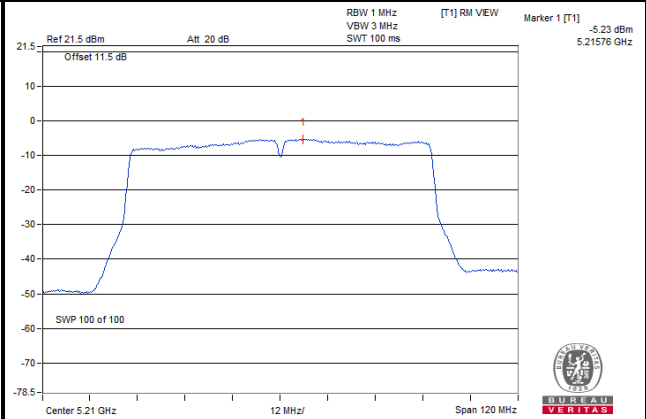

For U-NII-3 Band
802.11a

TX Chain	Channel	Frequency (MHz)	PSD w/o Duty Factor		10 log (N=2) dB	Duty Factor (dB)	Total PSD with Duty Factor (dBm/500 kHz)	Limit (dBm/500 kHz)	Pass / Fail
			(dBm/300 kHz)	(dBm/500 kHz)					
0	144	5720 (U-NII-3)	-1.5	0.72	3.01	0.23	3.96	26.88	Pass
	149	5745	4.57	6.79	3.01	0.23	10.03	26.88	Pass
	157	5785	4.49	6.71	3.01	0.23	9.95	26.88	Pass
	165	5825	4.83	7.05	3.01	0.23	10.29	26.88	Pass
1	144	5720 (U-NII-3)	-2.04	0.18	3.01	0.23	3.42	26.88	Pass
	149	5745	5.52	7.74	3.01	0.23	10.98	26.88	Pass
	157	5785	5.07	7.29	3.01	0.23	10.53	26.88	Pass
	165	5825	5.61	7.83	3.01	0.23	11.07	26.88	Pass

Note:

1. Method E) 2) c) of power density measurement of KDB 662911 is using for calculating total power density.
2. Directional gain = 6.11 dBi + 10log(2) = 9.12 dBi > 6 dBi , so the power density limit shall be reduced to 30-(9.12-6) = 26.88 dBm.
3. Refer to section 3.3 for duty cycle spectrum plot.

802.11ac (VHT20)

TX Chain	Channel	Frequency (MHz)	PSD		10 log (N=2) dB	Duty Factor (dB)	Total PSD with Duty Factor (dBm/500 kHz)	Limit (dBm/500 kHz)	Pass / Fail
			(dBm/300 kHz)	(dBm/500 kHz)					
0	144	5720 (U-NII-3)	-1.59	0.63	3.01	0.22	3.86	26.88	Pass
	149	5745	4.75	6.97	3.01	0.22	10.2	26.88	Pass
	157	5785	4.49	6.71	3.01	0.22	9.94	26.88	Pass
	165	5825	4.59	6.81	3.01	0.22	10.04	26.88	Pass
1	144	5720 (U-NII-3)	-2.55	-0.33	3.01	0.22	2.9	26.88	Pass
	149	5745	5.05	7.27	3.01	0.22	10.5	26.88	Pass
	157	5785	4.88	7.1	3.01	0.22	10.33	26.88	Pass
	165	5825	5.34	7.56	3.01	0.22	10.79	26.88	Pass

Note:

1. Method E) 2) c) of power density measurement of KDB 662911 is using for calculating total power density.
2. Directional gain = 6.11 dBi + 10log(2) = 9.12 dBi > 6 dBi , so the power density limit shall be reduced to 30-(9.12-6) = 26.88 dBm.
3. Refer to section 3.3 for duty cycle spectrum plot.

802.11ac (VHT40)

TX Chain	Channel	Frequency (MHz)	PSD		10 log (N=2) dB	Duty Factor (dB)	Total PSD with Duty Factor (dBm/500 kHz)	Limit (dBm/500 kHz)	Pass / Fail
			(dBm/300 kHz)	(dBm/500 kHz)					
0	142	5710 (U-NII-3)	-2.04	0.18	3.01	0.51	3.7	26.88	Pass
	151	5755	1.68	3.9	3.01	0.51	7.42	26.88	Pass
	159	5795	1.72	3.94	3.01	0.51	7.46	26.88	Pass
1	142	5710 (U-NII-3)	-2.38	-0.16	3.01	0.51	3.36	26.88	Pass
	151	5755	2.11	4.33	3.01	0.51	7.85	26.88	Pass
	159	5795	1.98	4.2	3.01	0.51	7.72	26.88	Pass

Note:

1. Method E) 2) c) of power density measurement of KDB 662911 is using for calculating total power density.
2. Directional gain = 6.11 dBi + 10log(2) = 9.12 dBi > 6 dBi , so the power density limit shall be reduced to 30-(9.12-6) = 26.88 dBm.
3. Refer to section 3.3 for duty cycle spectrum plot.

802.11ac (VHT80)

TX Chain	Channel	Frequency (MHz)	PSD		10 log (N=2) dB	Duty Factor (dB)	Total PSD with Duty Factor (dBm/500 kHz)	Limit (dBm/500 kHz)	Pass / Fail
			(dBm/300 kHz)	(dBm/500 kHz)					
0	138	5690 (U-NII-3)	-5.39	-3.17	3.01	0.89	0.73	26.88	Pass
	155	5775	-2.59	-0.37	3.01	0.89	3.53	26.88	Pass
1	138	5690 (U-NII-3)	-5.14	-2.92	3.01	0.89	0.98	26.88	Pass
	155	5775	-2.57	-0.35	3.01	0.89	3.55	26.88	Pass

Note:

1. Method E) 2) c) of power density measurement of KDB 662911 is using for calculating total power density.
2. Directional gain = 6.11 dBi + 10log(2) = 9.12 dBi > 6 dBi , so the power density limit shall be reduced to 30-(9.12-6) = 26.88 dBm.
3. Refer to section 3.3 for duty cycle spectrum plot.

4.6 Frequency Stability

4.6.1 Limit of Frequency Stability Measurement

The frequency of the carrier signal shall be maintained within band of operation.

4.6.2 Test Setup

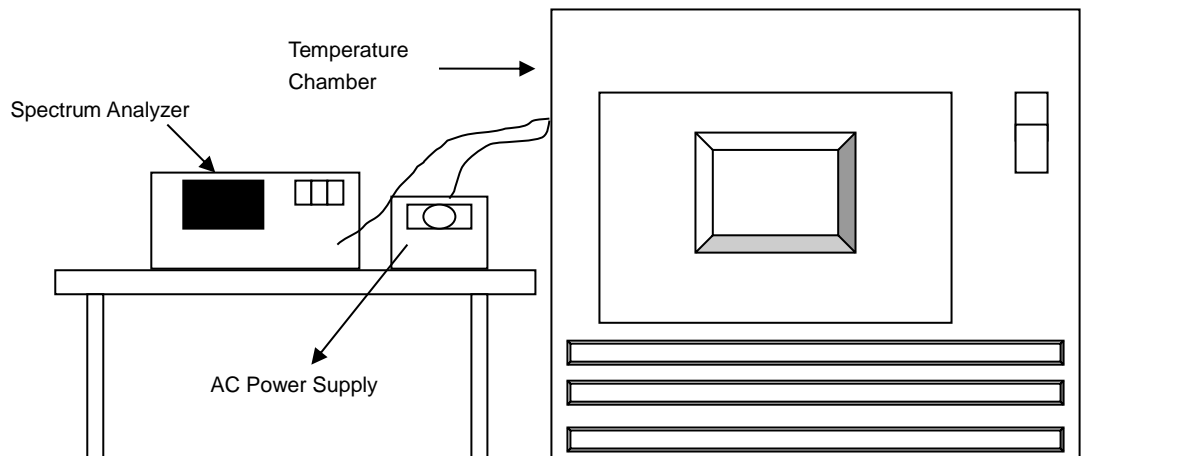

4.6.3 Test Instruments

Refer to section 4.1.2 to get information of above instrument.

4.6.4 Test Procedure

- The EUT was placed inside the environmental test chamber and powered by nominal AC voltage.
- Turn the EUT on and couple its output to a spectrum analyzer.
- Turn the EUT off and set the chamber to the highest temperature specified.
- Allow sufficient time (approximately 30 min) for the temperature of the chamber to stabilize, turn the EUT on and measure the operating frequency after 2, 5, and 10 Minutes.
- Repeat step (d) with the temperature chamber set to the next desired temperature until measurements down to the lowest specified temperature have been completed.
- The test chamber was allowed to stabilize at +20 degree C for a minimum of 30 Minutes. The supply voltage was then adjusted on the EUT from 85% to 115% and the frequency record.

4.6.5 Deviation from Test Standard

No deviation.

4.6.6 EUT Operating Condition

Set the EUT transmit at un-modulation mode to test frequency stability.

4.6.7 Test Results

Frequency Stability Versus Temp.									
Operating Frequency: 5180 MHz									
Temp. (°C)	Power Supply (Vac)	0 Minute		2 Minute		5 Minute		10 Minute	
		Measured Frequency (MHz)	Result	Measured Frequency (MHz)	Result	Measured Frequency (MHz)	Result	Measured Frequency (MHz)	Result
85	120	5180.0057	PASS	5180.001	PASS	5180.0008	PASS	5180.0015	PASS
80	120	5180.0098	PASS	5180.0076	PASS	5180.01	PASS	5180.0101	PASS
70	120	5180.0099	PASS	5180.0086	PASS	5180.0054	PASS	5180.0058	PASS
60	120	5180.0041	PASS	5180.0025	PASS	5180.0038	PASS	5180.0025	PASS
50	120	5179.998	PASS	5179.9971	PASS	5179.9987	PASS	5179.9957	PASS
40	120	5180.0071	PASS	5180.0056	PASS	5180.0078	PASS	5180.0078	PASS
30	120	5179.9819	PASS	5179.9815	PASS	5179.9831	PASS	5179.9783	PASS
20	120	5179.9881	PASS	5179.9847	PASS	5179.9846	PASS	5179.9873	PASS
10	120	5179.9924	PASS	5179.9965	PASS	5179.9933	PASS	5179.9951	PASS
0	120	5179.9842	PASS	5179.9867	PASS	5179.9868	PASS	5179.9845	PASS
-10	120	5180.0213	PASS	5180.0201	PASS	5180.0174	PASS	5180.0195	PASS
-20	120	5179.9865	PASS	5179.9888	PASS	5179.9845	PASS	5179.9863	PASS
-25	120	5179.9977	PASS	5179.9956	PASS	5179.9961	PASS	5179.9946	PASS

Frequency Stability Versus Voltage									
Operating Frequency: 5180 MHz									
Temp. (°C)	Power Supply (Vac)	0 Minute		2 Minute		5 Minute		10 Minute	
		Measured Frequency (MHz)	Result	Measured Frequency (MHz)	Result	Measured Frequency (MHz)	Result	Measured Frequency (MHz)	Result
20	138	5179.9873	PASS	5179.9844	PASS	5179.9844	PASS	5179.9872	PASS
	120	5179.9881	PASS	5179.9847	PASS	5179.9846	PASS	5179.9873	PASS
	102	5179.9878	PASS	5179.9856	PASS	5179.9845	PASS	5179.9881	PASS

4.7 6 dB Bandwidth Measurement

4.7.1 Limits of 6 dB Bandwidth Measurement

The minimum of 6 dB Bandwidth Measurement is 0.5 MHz.

4.7.2 Test Setup



4.7.3 Test Instruments

Refer to section 4.1.2 to get information of above instrument.

4.7.4 Test Procedure

MEASUREMENT PROCEDURE REF

- Set resolution bandwidth (RBW) = 100 kHz
- Set the video bandwidth (VBW) $\geq 3 \times$ RBW, Detector = Peak.
- Trace mode = max hold.
- Sweep = auto couple.
- Measure the maximum width of the emission that is constrained by the frequencies associated with the two amplitude points (upper and lower) that are attenuated by 6 dB relative to the maximum level measured in the fundamental emission

4.7.5 Deviation from Test Standard

No deviation.

4.7.6 EUT Operating Condition

The software provided by client to enable the EUT under transmission condition continuously at lowest, middle and highest channel frequencies individually.

4.7.7 Test Results

802.11a

Channel	Frequency (MHz)	6 dB Bandwidth (MHz)		Minimum Limit (MHz)	Pass / Fail
		Chain 0	Chain 1		
144	5720 (U-NII-3)	3.21	2.96	0.5	Pass
149	5745	16.35	16.34	0.5	Pass
157	5785	16.13	16.36	0.5	Pass
165	5825	16.35	16.37	0.5	Pass

802.11ac (VHT20)

Channel	Frequency (MHz)	6 dB Bandwidth (MHz)		Minimum Limit (MHz)	Pass / Fail
		Chain 0	Chain 1		
144	5720 (U-NII-3)	2.95	2.82	0.5	Pass
149	5745	17.32	17.60	0.5	Pass
157	5785	17.61	17.60	0.5	Pass
165	5825	17.59	17.58	0.5	Pass

802.11ac (VHT40)

Channel	Frequency (MHz)	6 dB Bandwidth (MHz)		Minimum Limit (MHz)	Pass / Fail
		Chain 0	Chain 1		
142	5710 (U-NII-3)	2.82	3.00	0.5	Pass
151	5755	35.95	35.73	0.5	Pass
159	5795	35.75	36.07	0.5	Pass

802.11ac (VHT80)

Channel	Frequency (MHz)	6 dB Bandwidth (MHz)		Minimum Limit (MHz)	Pass / Fail
		Chain 0	Chain 1		
138	5690 (U-NII-3)	2.71	2.70	0.5	Pass
155	5775	75.38	75.39	0.5	Pass

Spectrum Plot of Worst Value

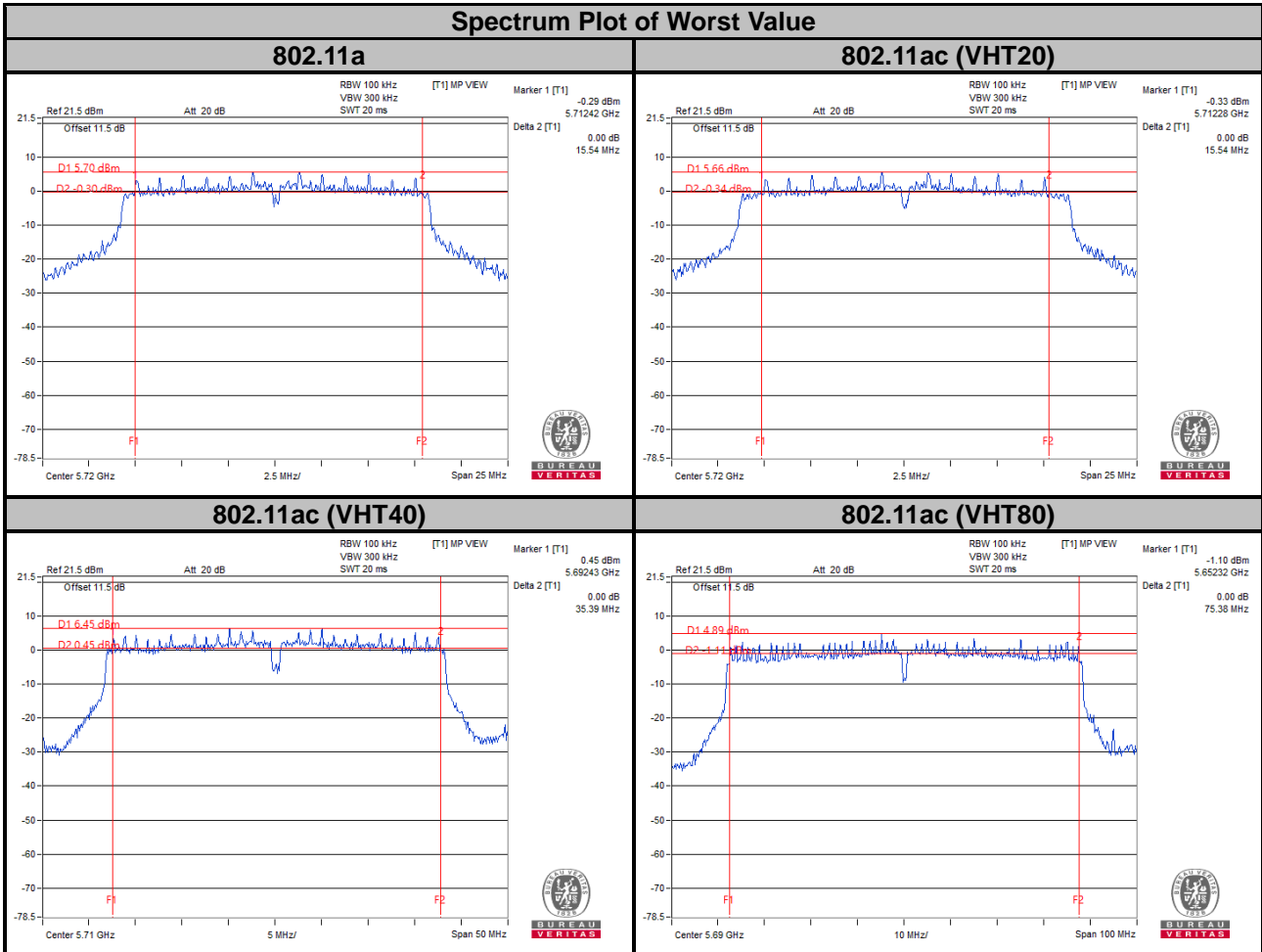

Note:

For Ch144 (UNII-3 Band): The 6 dB bandwidth above 5725 MHz = Marker 1 + Delta 2 – 5725 MHz
 For Ch142 (UNII-3 Band): The 6 dB bandwidth above 5725 MHz = Marker 1 + Delta 2 – 5725 MHz
 For Ch138 (UNII-3 Band): The 6 dB bandwidth above 5725 MHz = Marker 1 + Delta 2 – 5725 MHz

5 Pictures of Test Arrangements

Please refer to the attached file (Test Setup Photo).

Annex A- Radiated Out of Band Emission (OOBE) Measurement (For U-NII-3 band)

802.11a

CH 149 5745 MHz

Horizontal

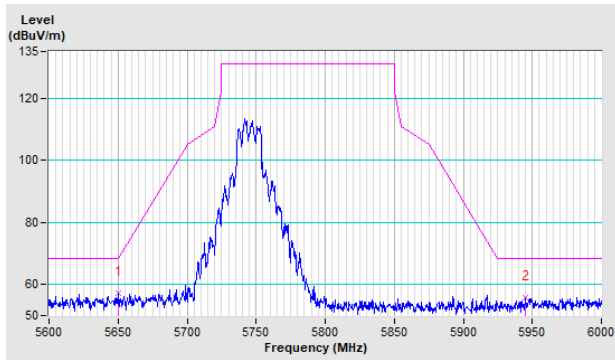

Vertical

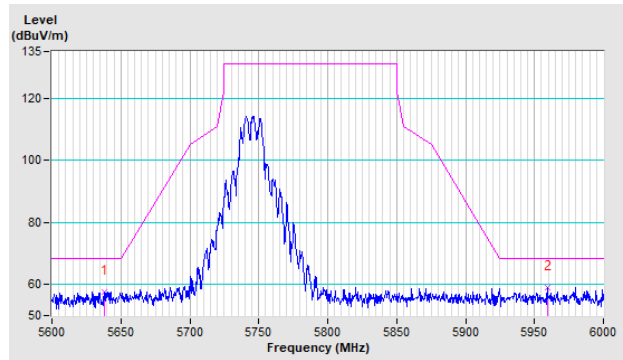

CH 157 5785 MHz

Horizontal

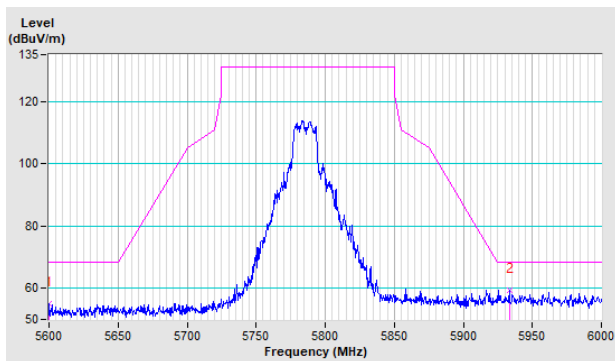

Vertical

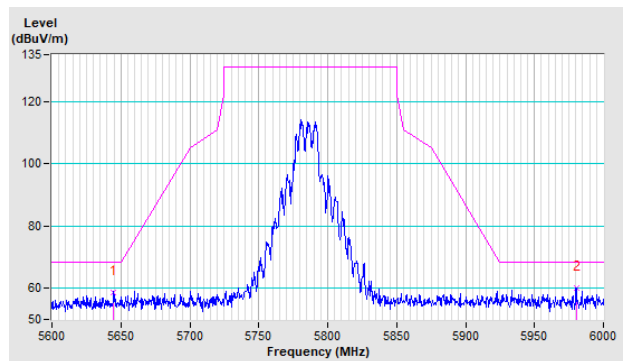

CH 165 5825 MHz

Horizontal

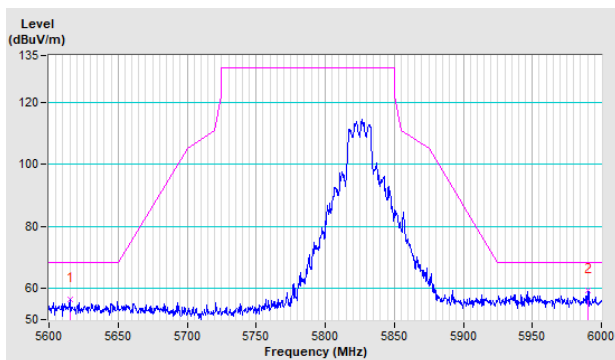

Vertical

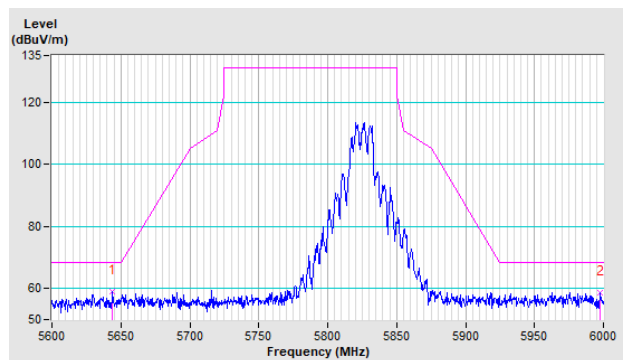

802.11ac (VHT20)

CH 149 5745 MHz

Horizontal

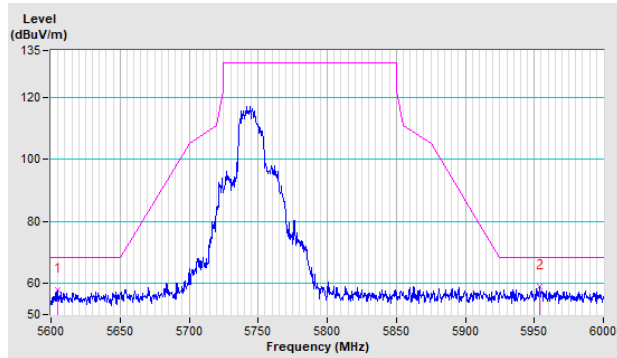

Vertical

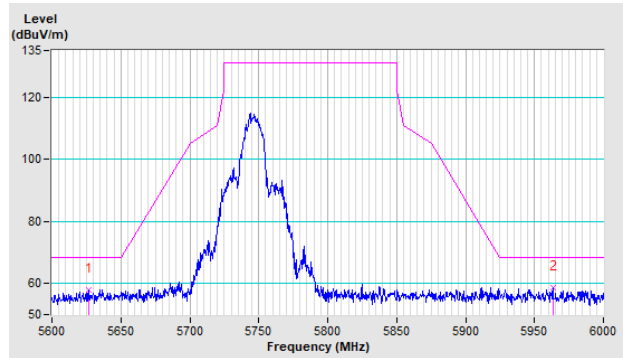

CH 157 5785 MHz

Horizontal

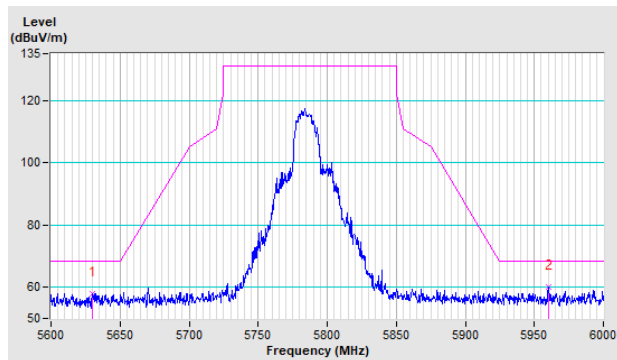

Vertical

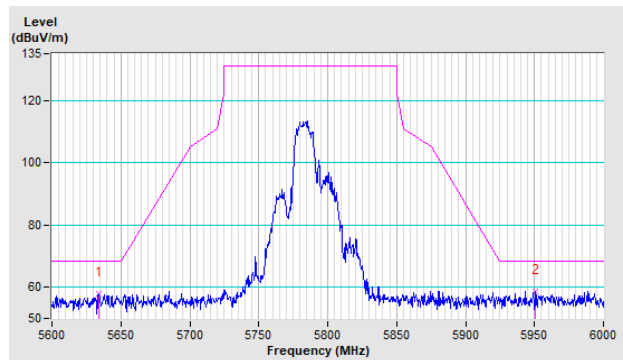

CH 165 5825 MHz

Horizontal

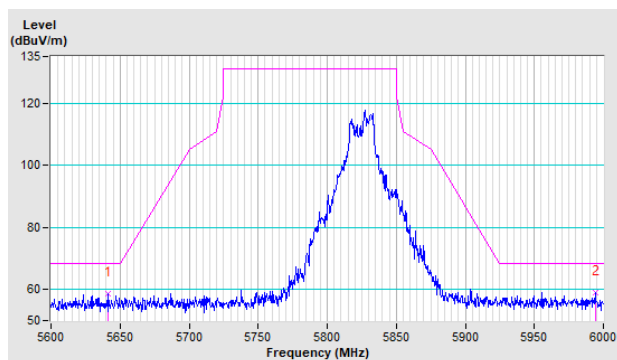

Vertical

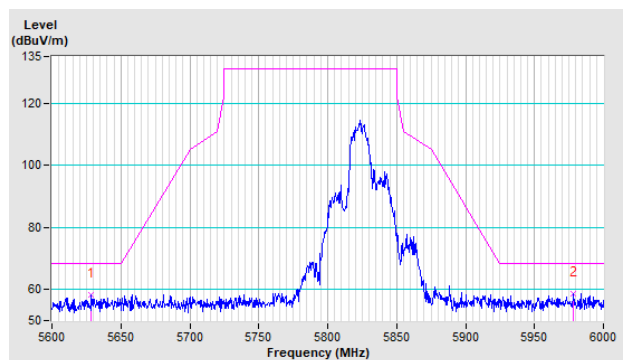

802.11ac (VHT40)

CH 151 5755 MHz

Horizontal

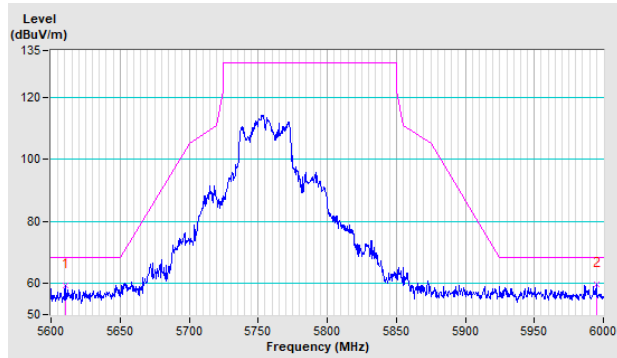

Vertical

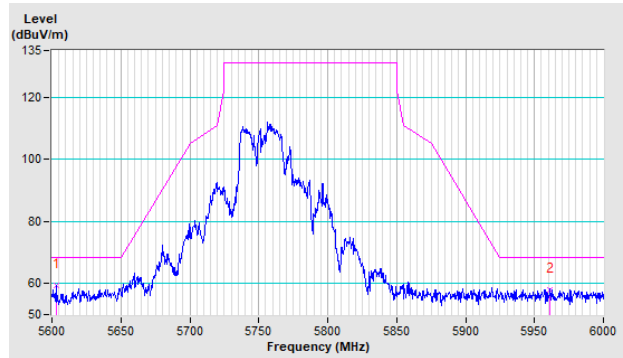

CH 159 5795 MHz

Horizontal

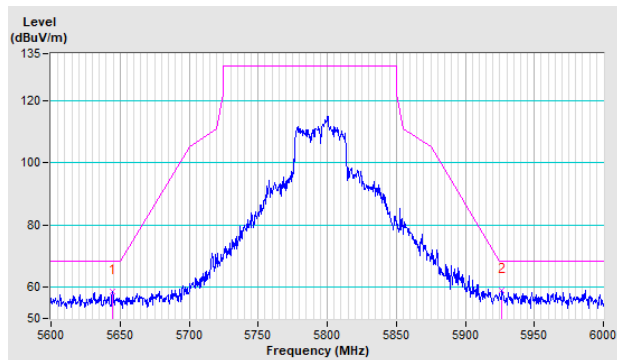

Vertical

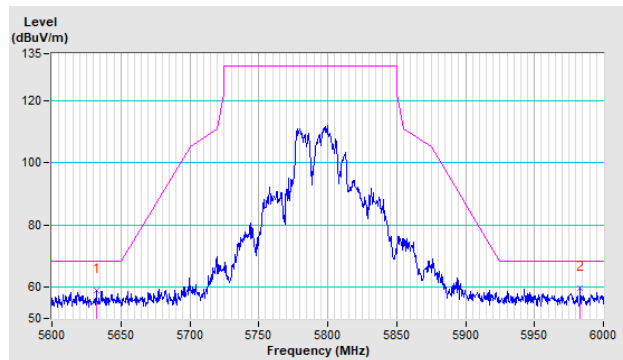

802.11ac (VHT80)

CH 155 5775 MHz

Horizontal

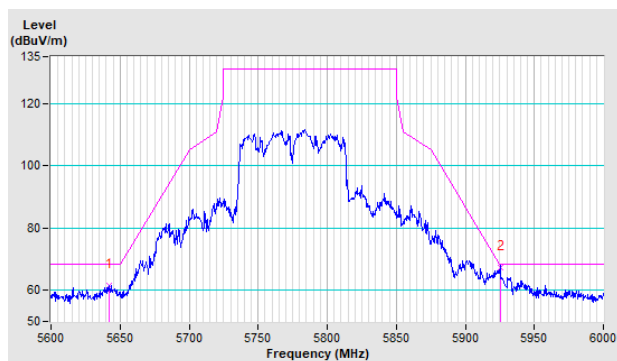

Vertical

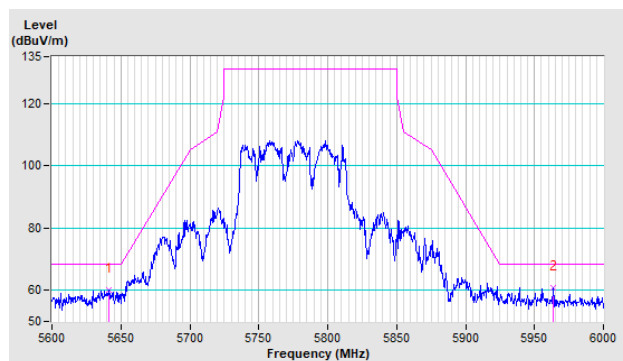

Annex B- Band Edge Measurement

802.11a

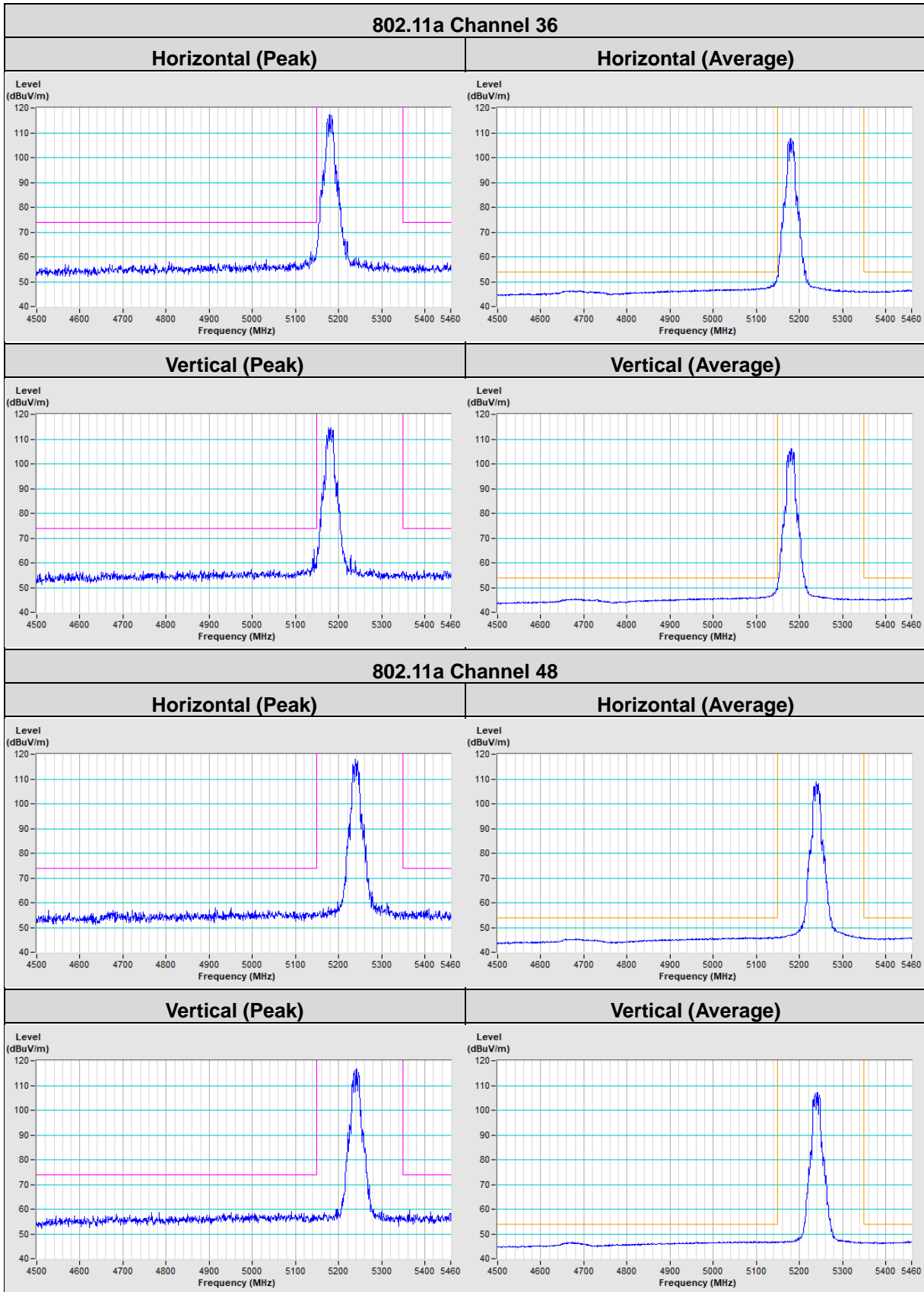

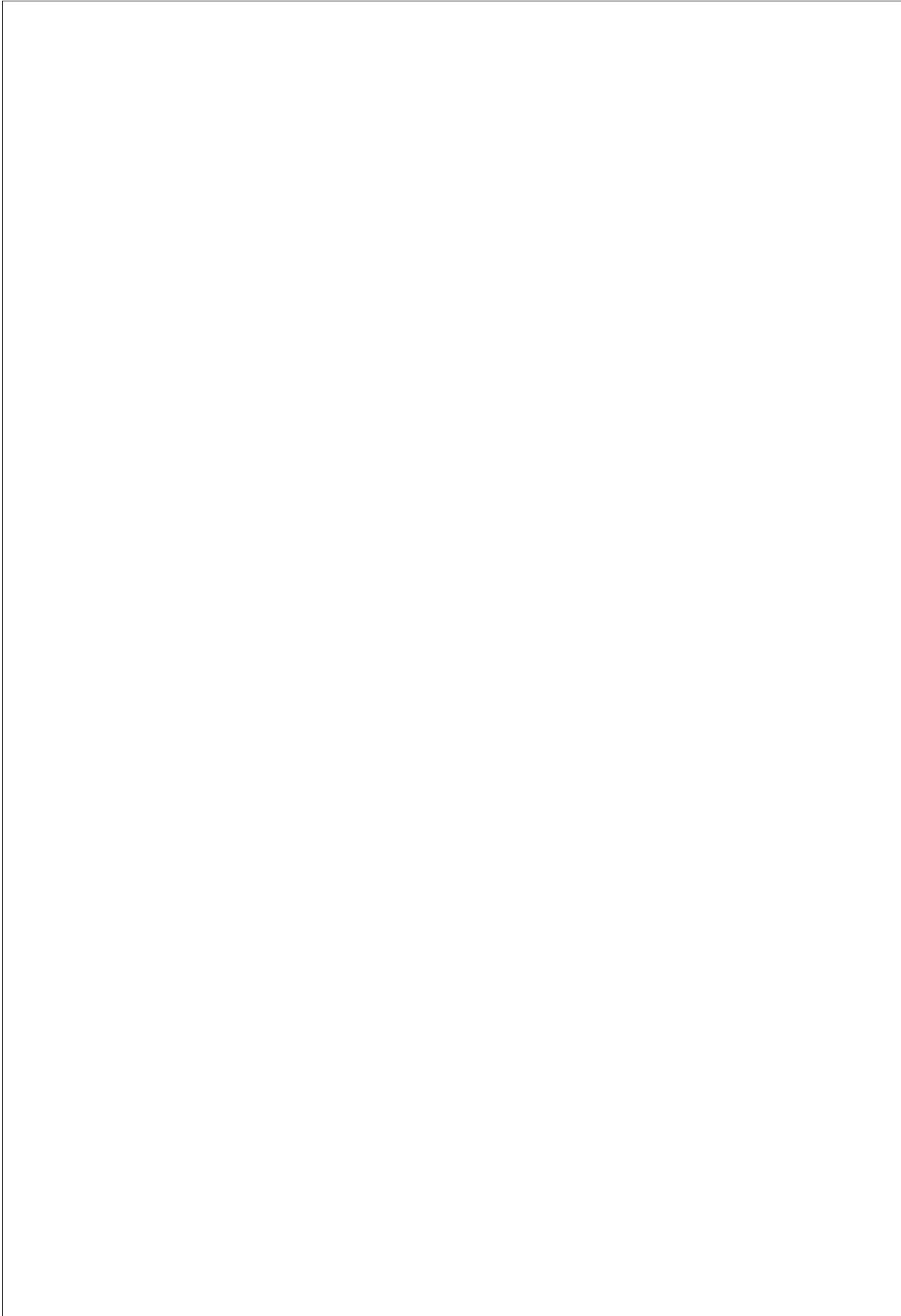

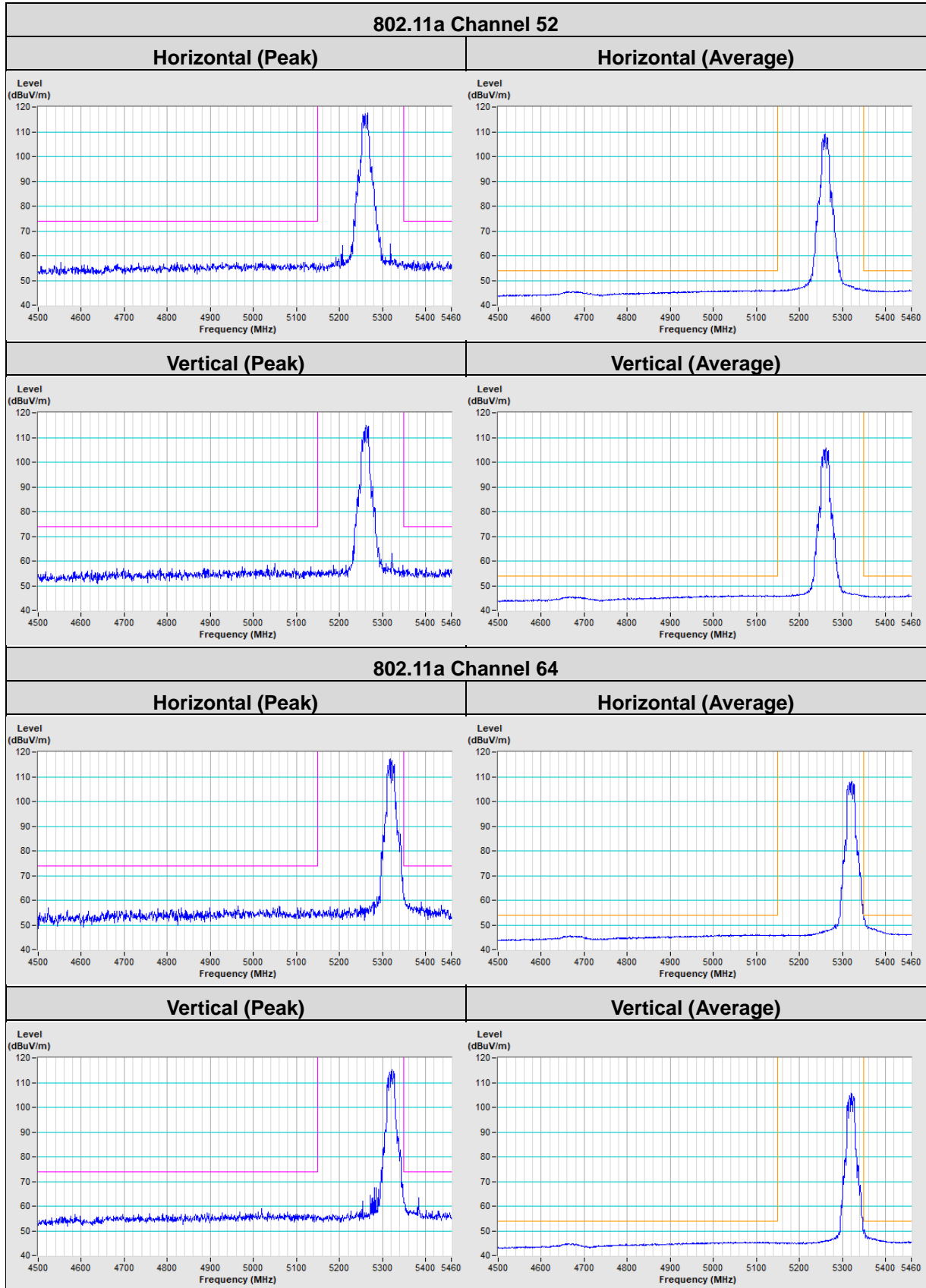

802.11a Channel 100

Horizontal (Peak)	Horizontal (Average)
--------------------------	-----------------------------

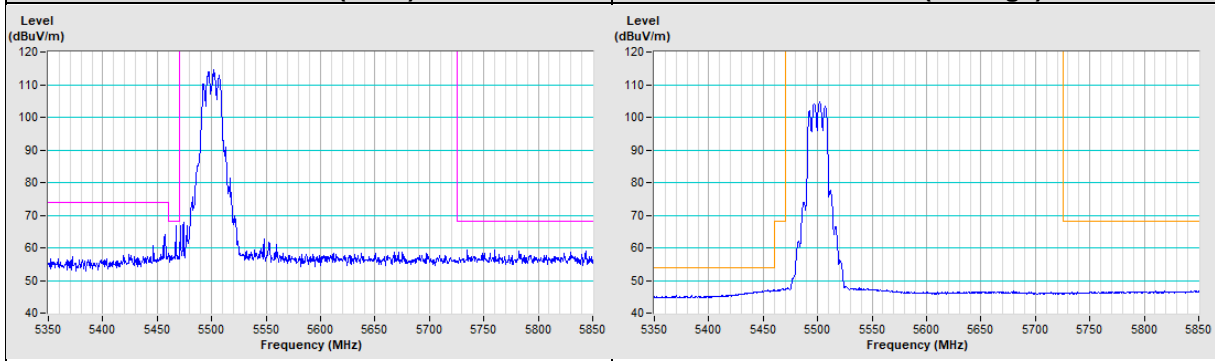

Vertical (Peak)	Vertical (Average)
------------------------	---------------------------

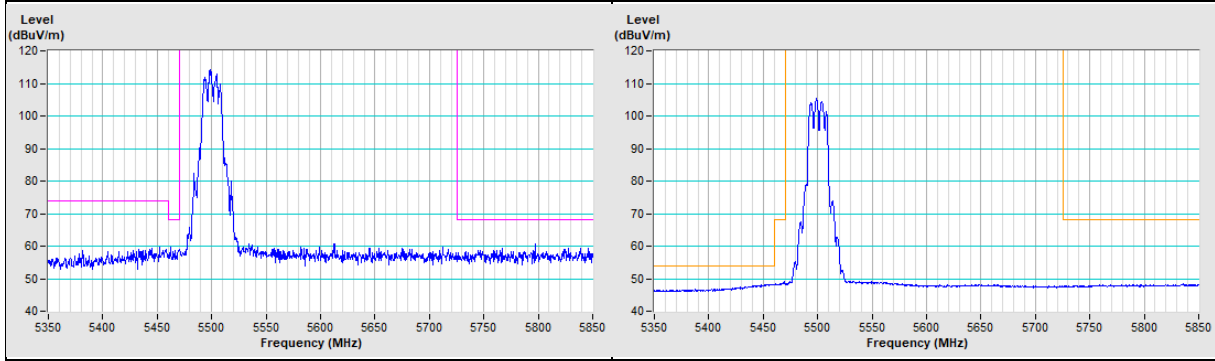

802.11a Channel 140

Horizontal (Peak)	Vertical (Peak)
--------------------------	------------------------

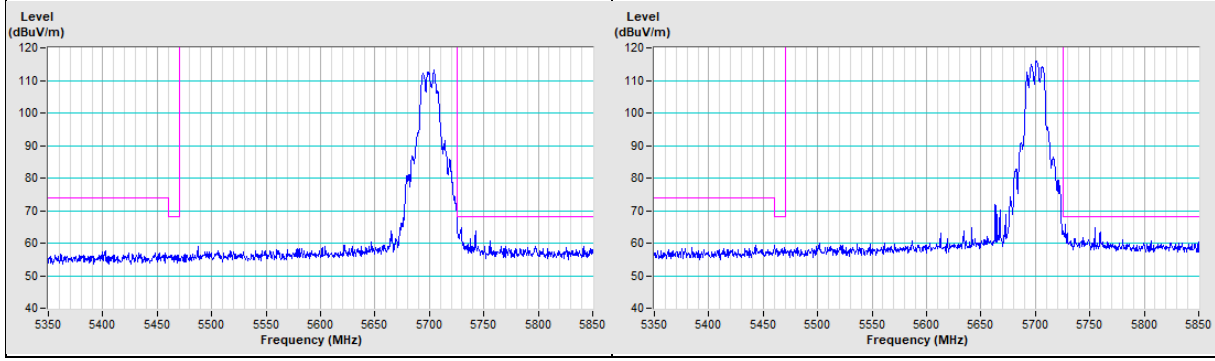

802.11a Channel 144

Horizontal (Peak)

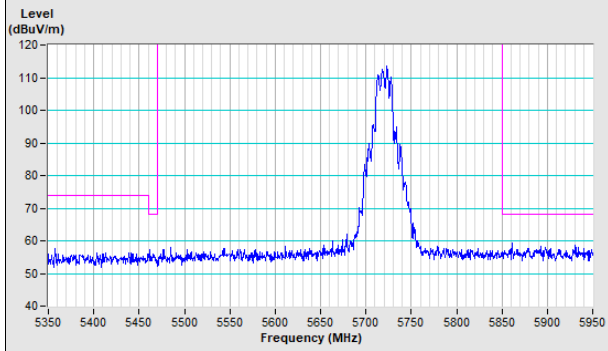

Vertical (Peak)

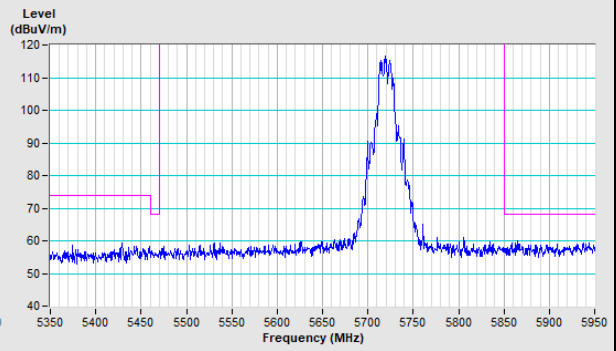

802.11ac (VHT20)

802.11ac (VHT20) Channel 36

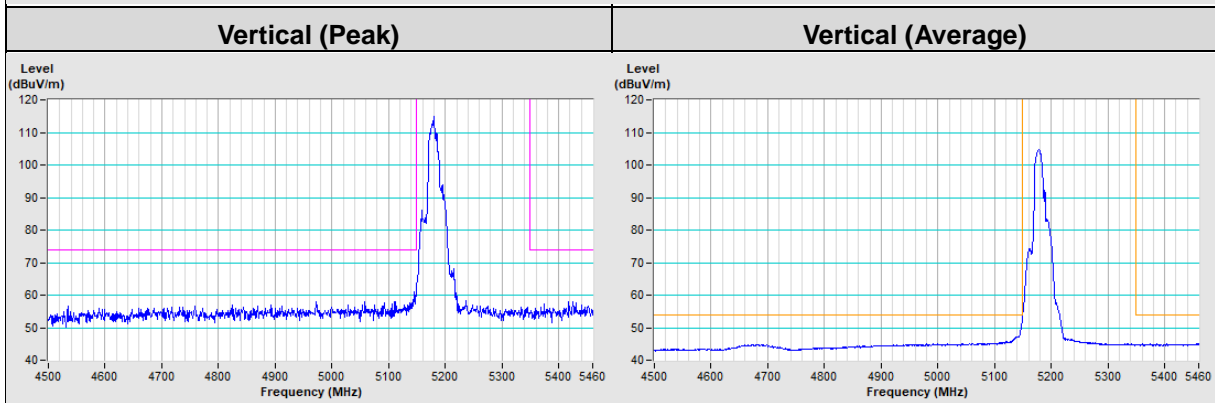
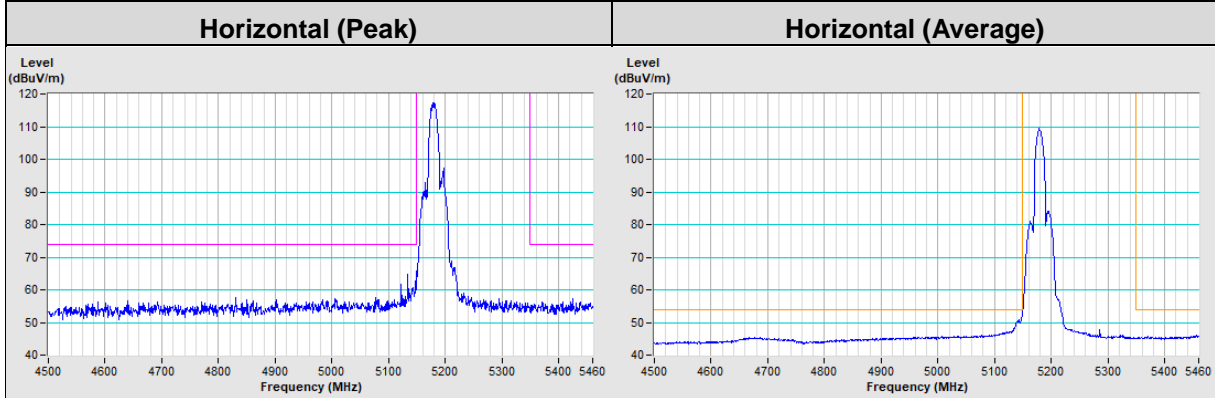

802.11ac (VHT20) Channel 48

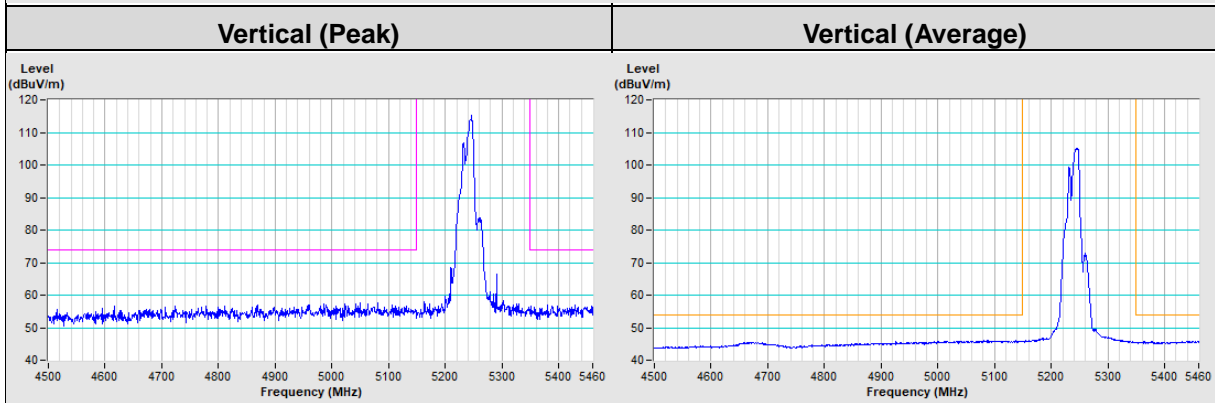
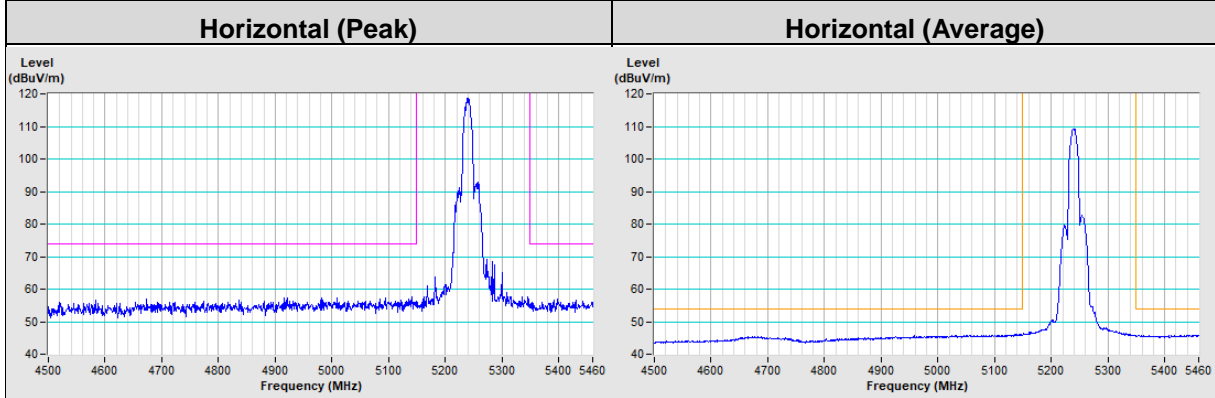

802.11ac (VHT20) Channel 52

Horizontal (Peak)

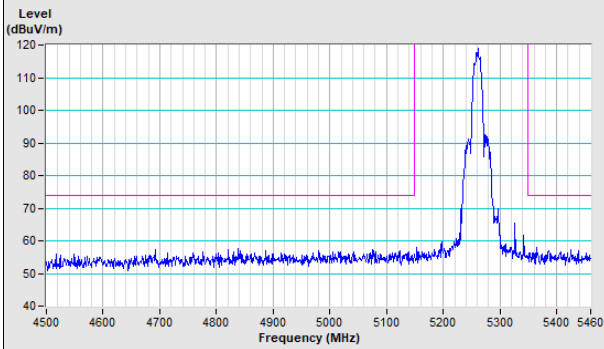

Horizontal (Average)

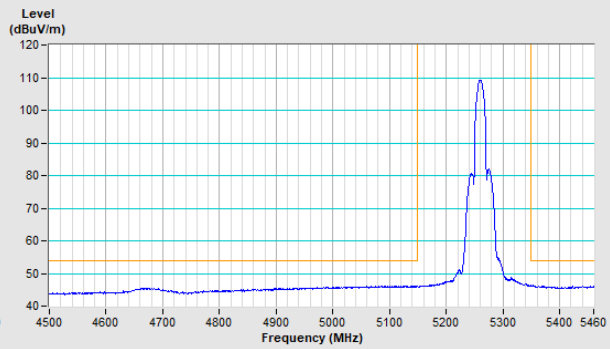

Vertical (Peak)

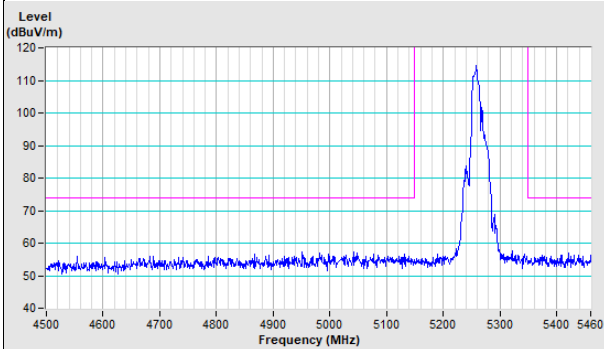

Vertical (Average)

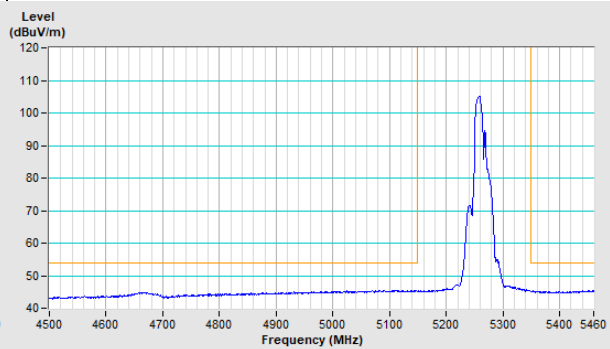

802.11ac (VHT20) Channel 64

Horizontal (Peak)

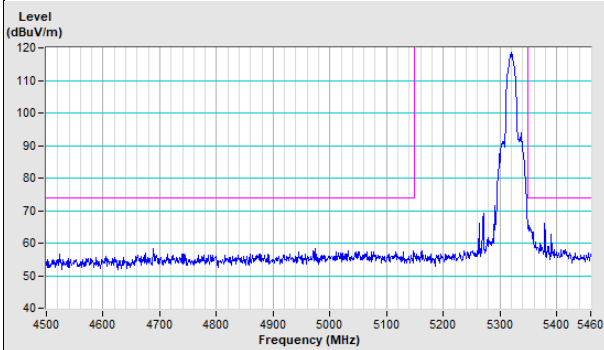

Horizontal (Average)

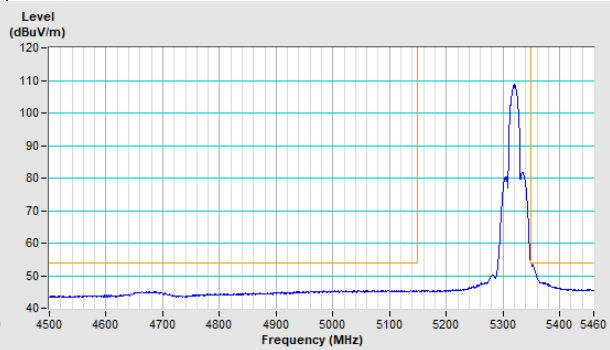

Vertical (Peak)

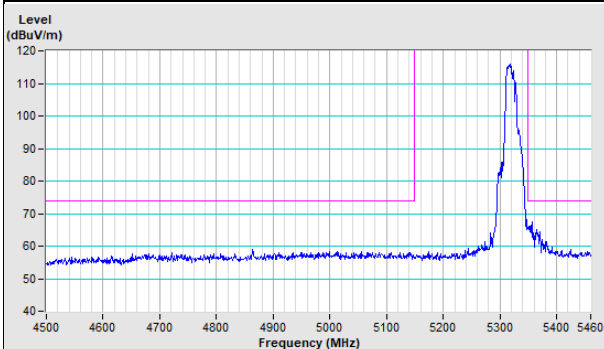

Vertical (Average)

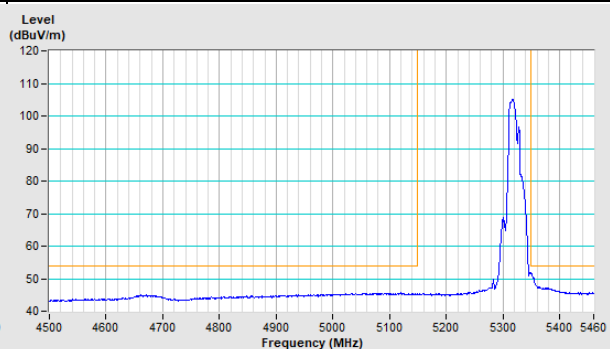

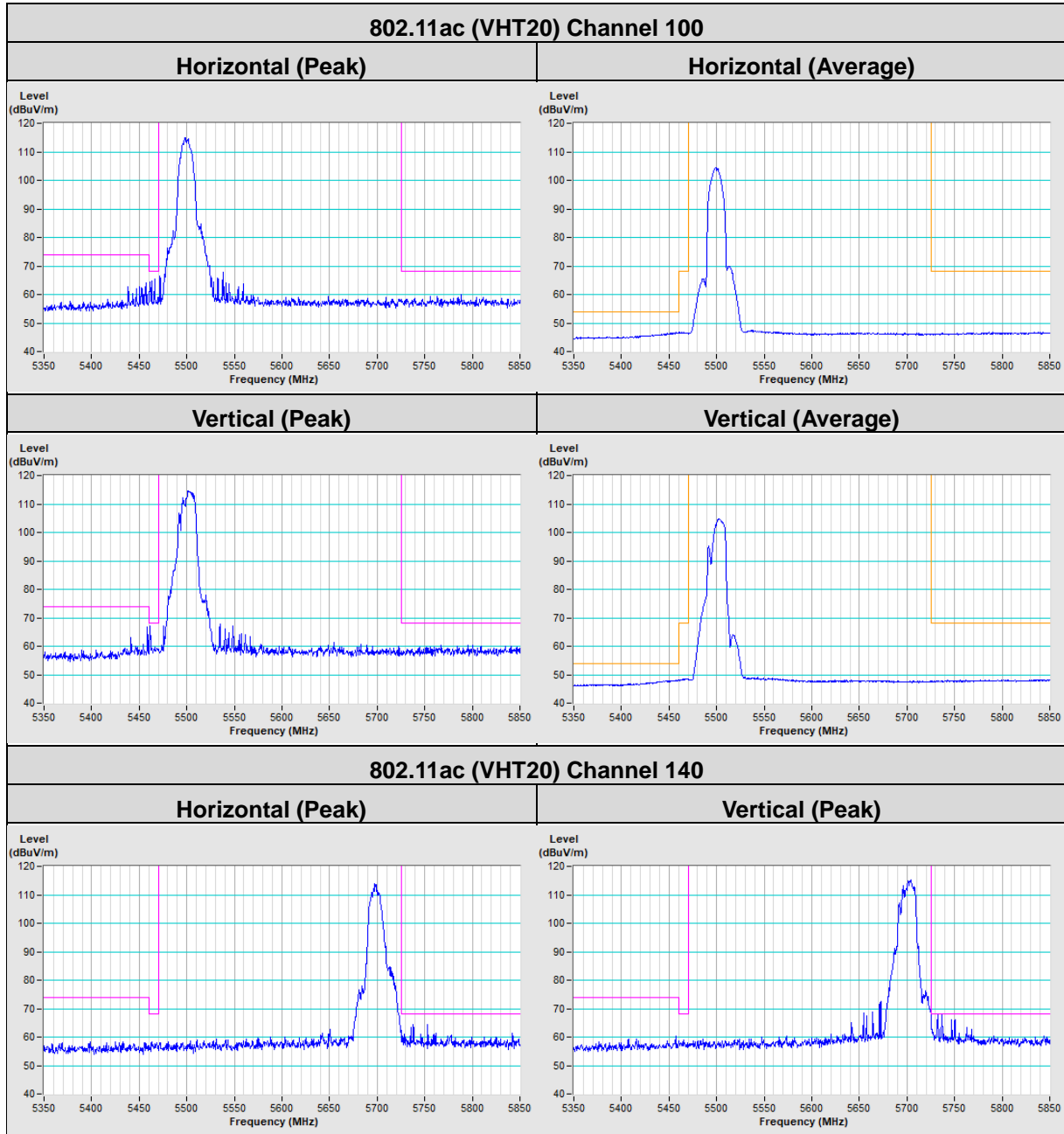

802.11ac (VHT20) Channel 144

Horizontal (Peak)

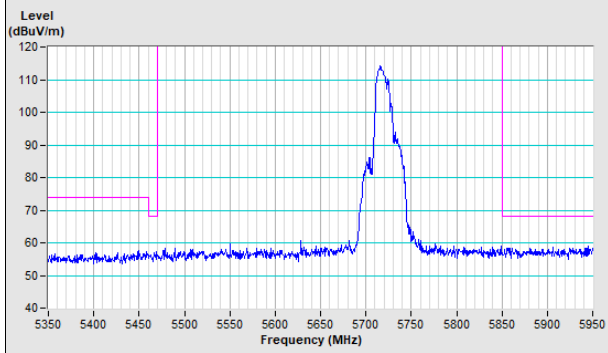

Vertical (Peak)

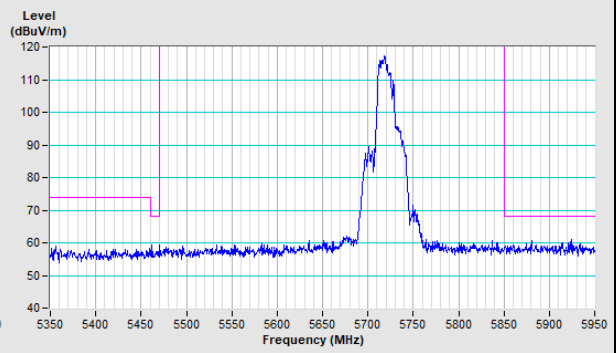

802.11ac (VHT40)

802.11ac (VHT40) Channel 38

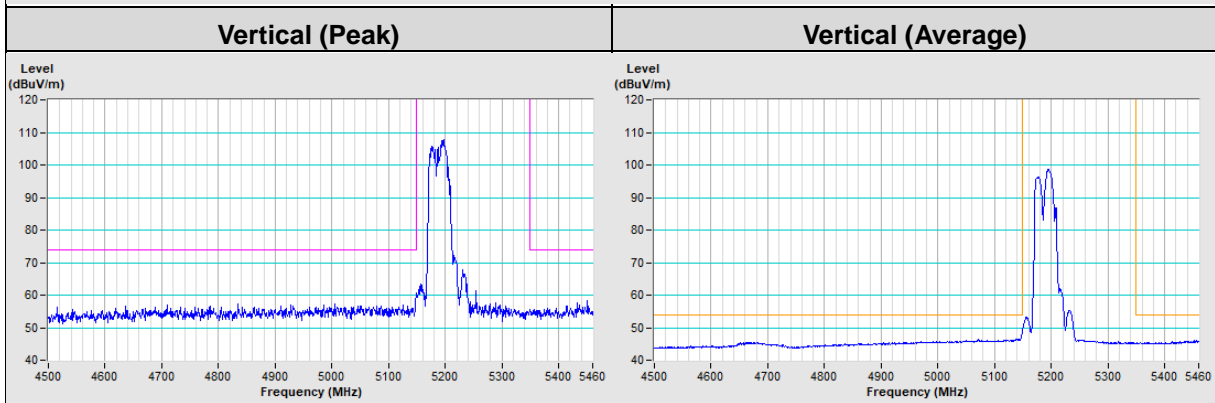
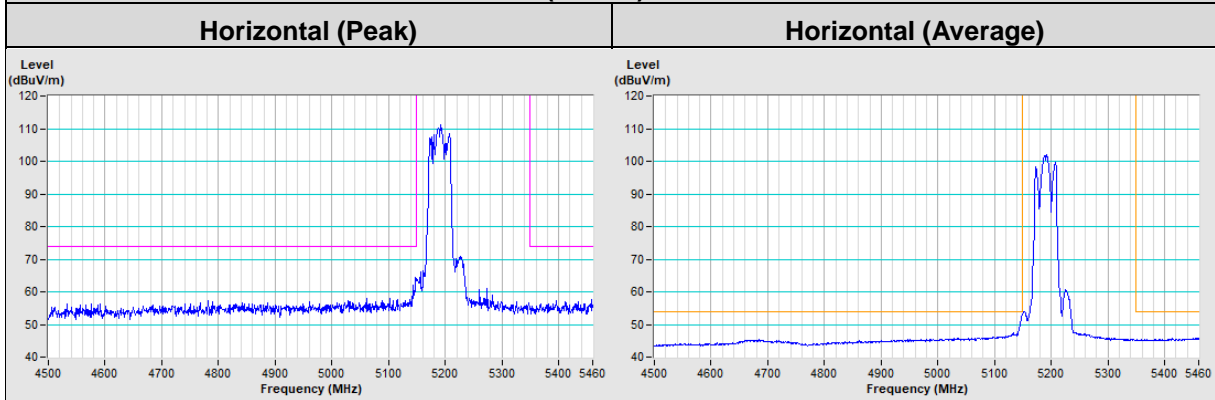

802.11ac (VHT40) Channel 46

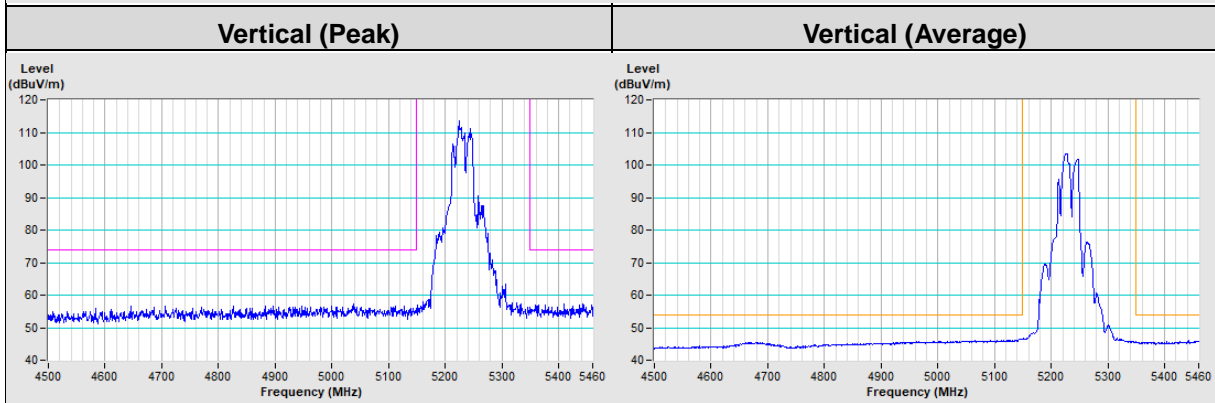
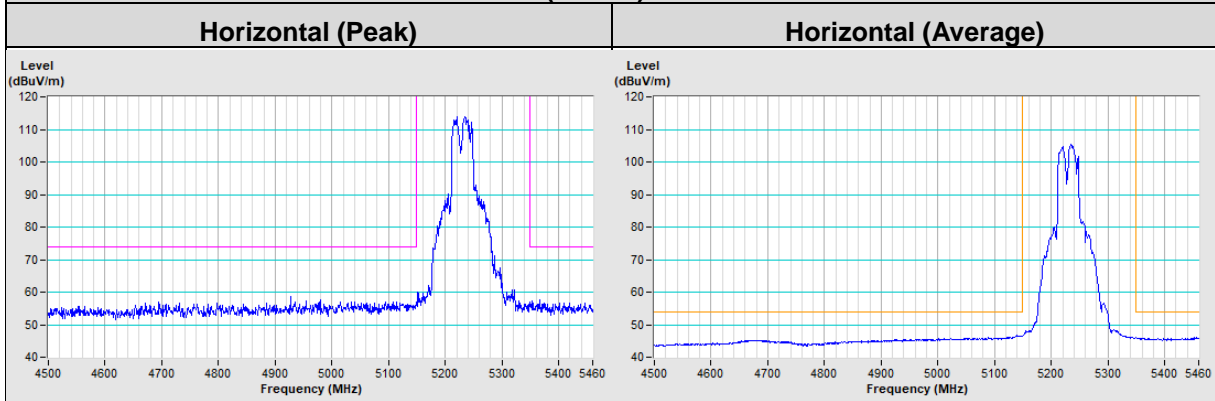

802.11ac (VHT40) Channel 54

Horizontal (Peak)

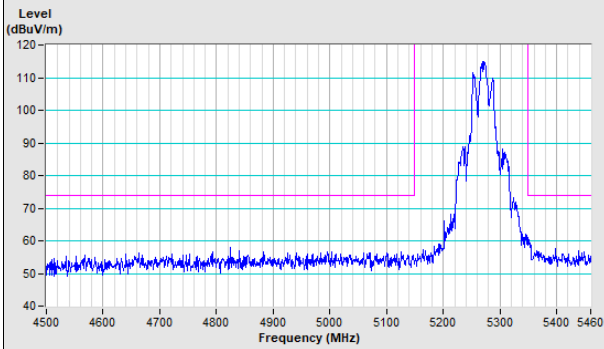

Horizontal (Average)

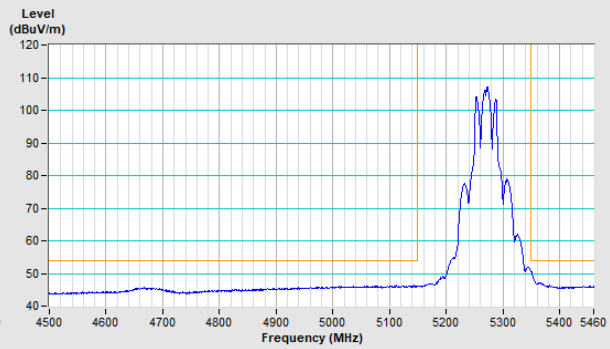

Vertical (Peak)

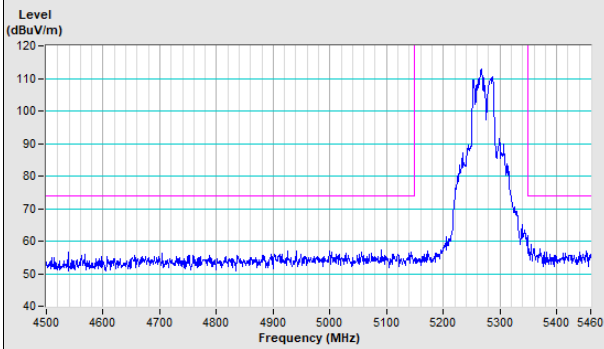

Vertical (Average)

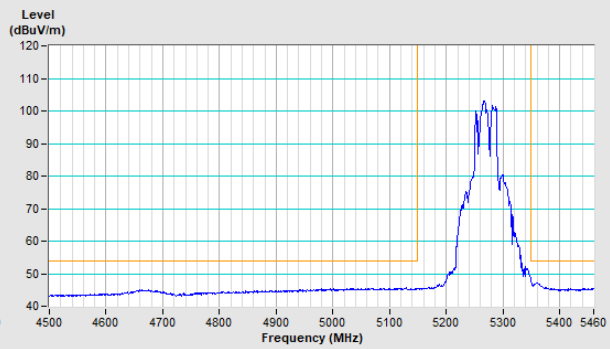

802.11ac (VHT40) Channel 62

Horizontal (Peak)

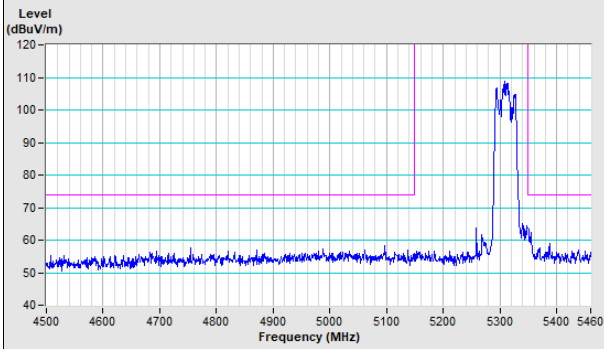

Horizontal (Average)

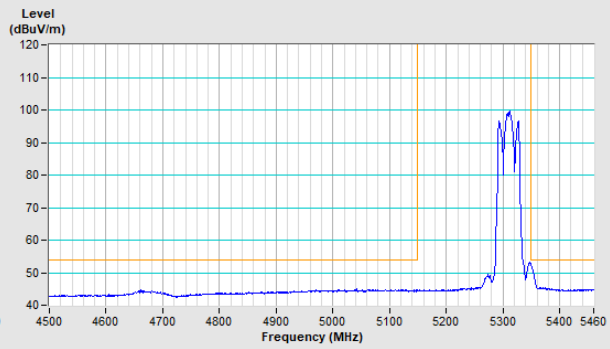

Vertical (Peak)

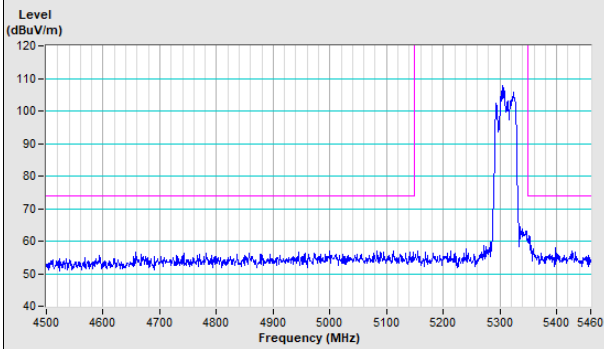

Vertical (Average)

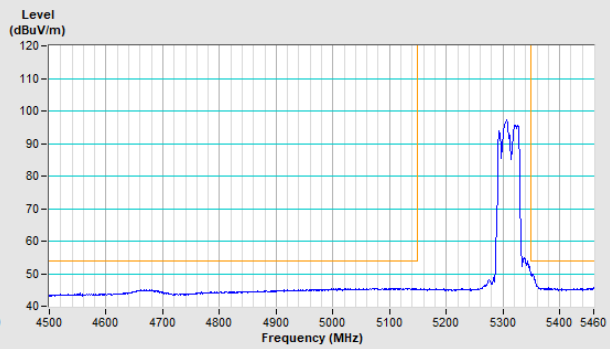

802.11ac (VHT40) Channel 102

Horizontal (Peak)	Horizontal (Average)
--------------------------	-----------------------------

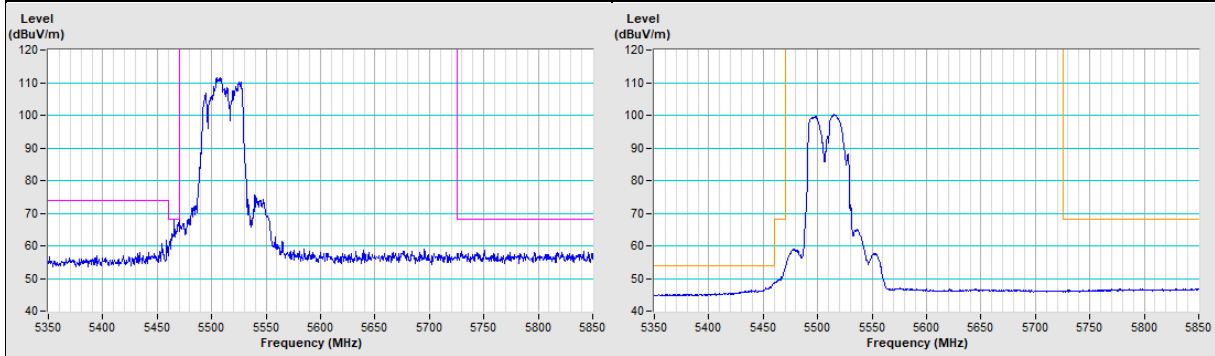

Vertical (Peak)	Vertical (Average)
------------------------	---------------------------

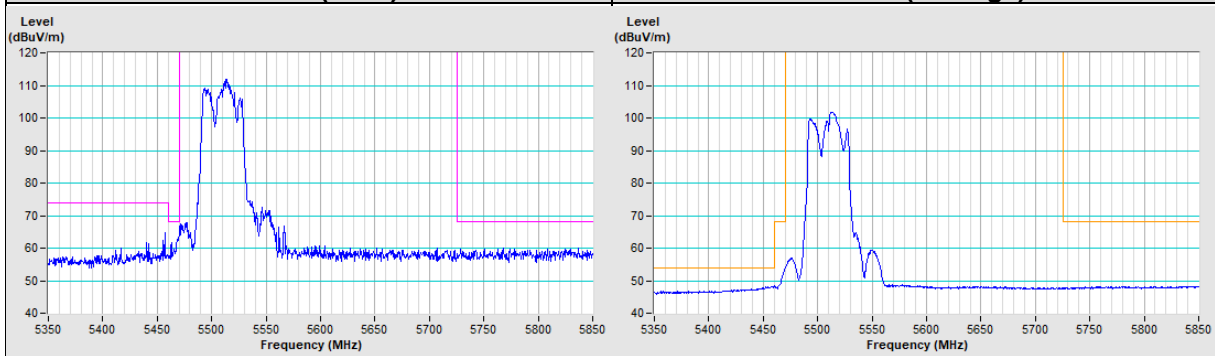

802.11ac (VHT40) Channel 134

Horizontal (Peak)	Vertical (Peak)
--------------------------	------------------------

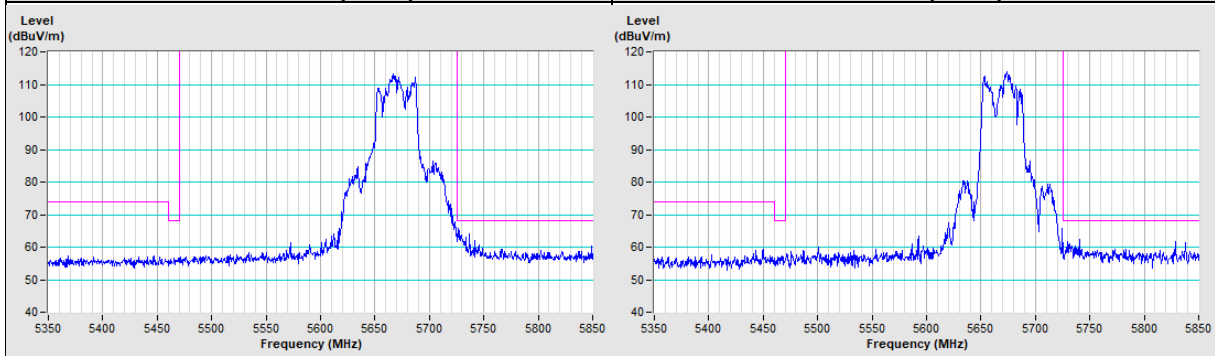

802.11ac (VHT40) Channel 142

Horizontal (Peak)

Vertical (Peak)

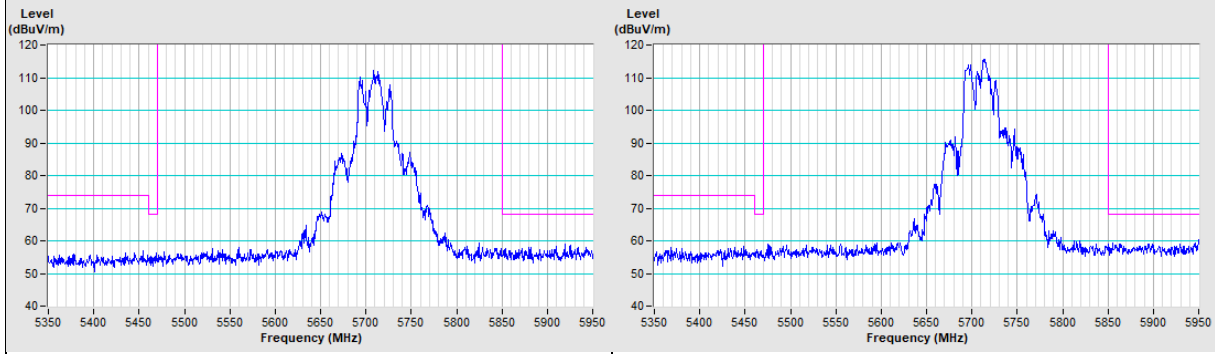

802.11ac (VHT80)

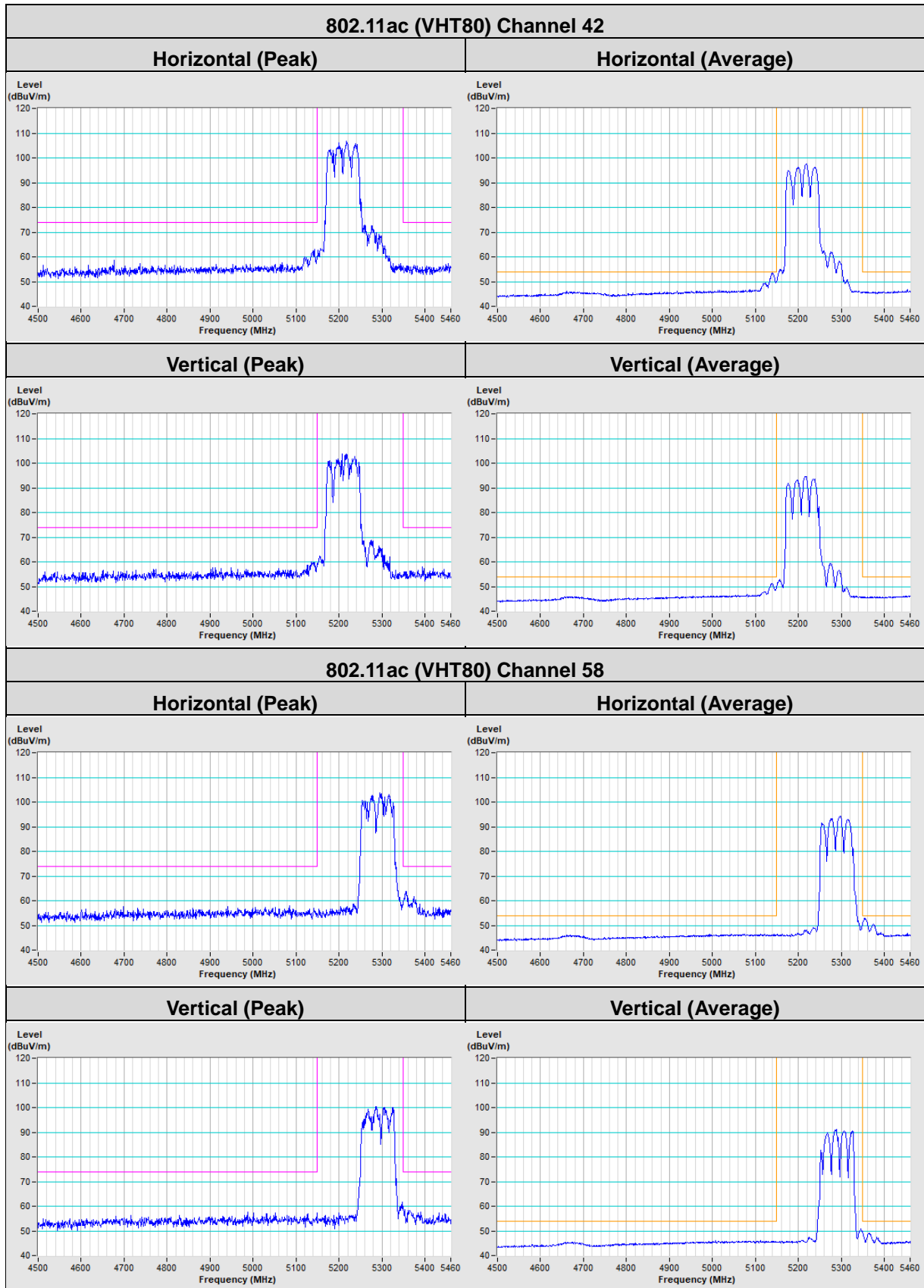

802.11ac (VHT80) Channel 106

Horizontal (Peak)	Horizontal (Average)
--------------------------	-----------------------------

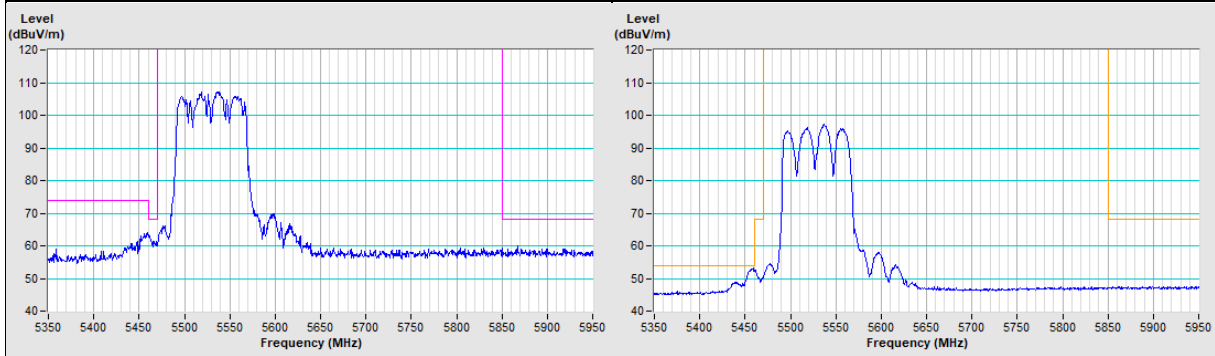

Vertical (Peak)	Vertical (Average)
------------------------	---------------------------

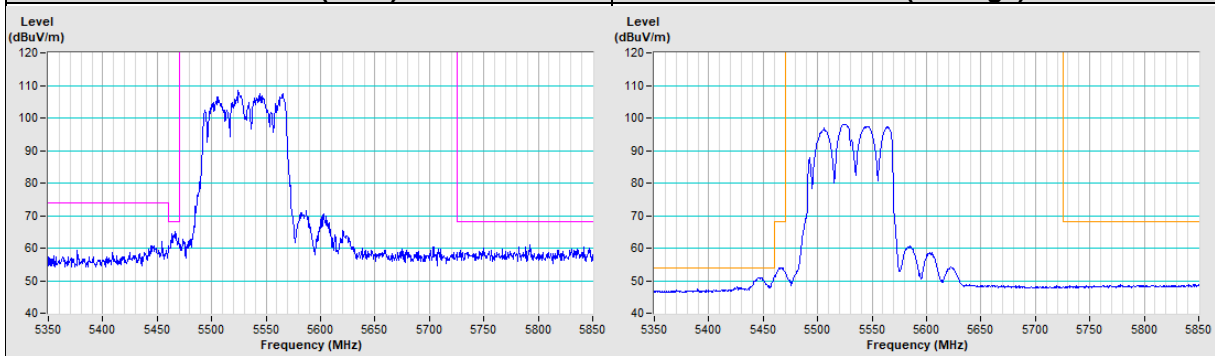

802.11ac (VHT80) Channel 138

Horizontal (Peak)	Vertical (Peak)
--------------------------	------------------------

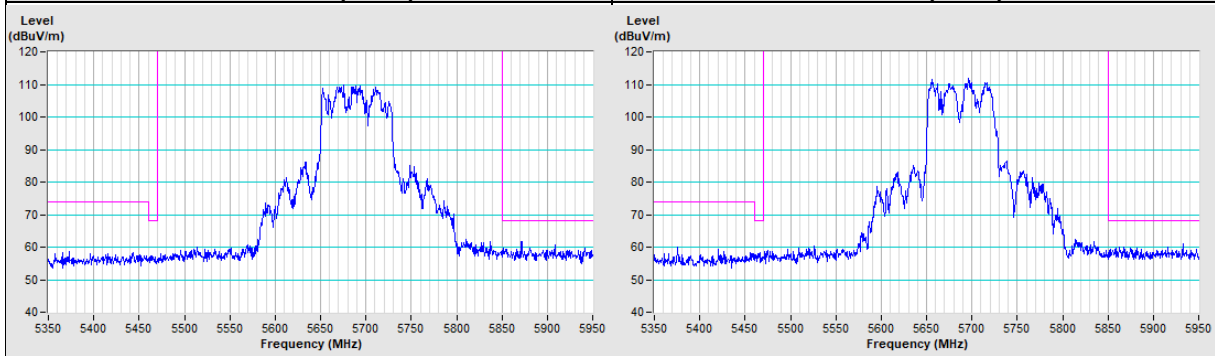

Appendix – Information of the Testing Laboratories

We, Bureau Veritas Consumer Products Services (H.K.) Ltd., Taoyuan Branch, were founded in 1988 to provide our best service in EMC, Radio, Telecom and Safety consultation. Our laboratories are FCC recognized accredited test firms and accredited according to ISO/IEC 17025.

If you have any comments, please feel free to contact us at the following:

Lin Kou EMC/RF Lab

Tel: 886-2-26052180

Fax: 886-2-26051924

Hsin Chu EMC/RF/Telecom Lab

Tel: 886-3-6668565

Fax: 886-3-6668323

Hwa Ya EMC/RF/Safety Lab

Tel: 886-3-3183232

Fax: 886-3-3270892

Email: service.adt@tw.bureauveritas.com

Web Site: www.bureauveritas-adt.com

The address and road map of all our labs can be found in our web site also.

--- END ---