

FCC Test Report

Report No.: RFBHAT-WTW-P21061067

FCC ID: R68OQ610US

Test Model: Open-Q 610 uSOM

Received Date: Jun. 29, 2021

Test Date: Sep. 03 ~ Sep. 15, 2021

Issued Date: Jan. 10, 2022

Applicant: Lantronix, Inc.

Address: 7535 Irvine Center Drive, Suite 100, Irvine, CA 92618 USA

Issued By: Bureau Veritas Consumer Products Services (H.K.) Ltd., Taoyuan Branch
Lin Kou Laboratories

Lab Address: No. 47-2, 14th Ling, Chia Pau Vil., Lin Kou Dist., New Taipei City, Taiwan

Test Location (1): No.19, Hwa Ya 2nd Rd., Wen Hwa Vil., Kwei Shan Dist., Taoyuan City
33383, Taiwan

Test Location (2): No. 70, Wenming Rd., Guishan Dist., Taoyuan City 333, Taiwan

FCC Registration / 788550 / TW0003

Designation Number: 281270 / TW0032



This report is for your exclusive use. Any copying or replication of this report to or for any other person or entity, or use of our name or trademark, is permitted only with our prior written permission. This report sets forth our findings solely with respect to the test samples identified herein. The results set forth in this report are not indicative or representative of the quality or characteristics of the lot from which a test sample was taken or any similar or identical product unless specifically and expressly noted. Our report includes all of the tests requested by you and the results thereof based upon the information that you provided to us. You have 60 days from date of issuance of this report to notify us of any material error or omission caused by our negligence, provided, however, that such notice shall be in writing and shall specifically address the issue you wish to raise. A failure to raise such issue within the prescribed time shall constitute your unqualified acceptance of the completeness of this report, the tests conducted and the correctness of the report contents. Unless specific mention, the uncertainty of measurement has been explicitly taken into account to declare the compliance or non-compliance to the specification.

Table of Contents

Release Control Record	4
1 Certificate of Conformity	5
2 Summary of Test Results	6
2.1 Measurement Uncertainty	6
2.2 Modification Record	7
3 General Information	8
3.1 General Description of EUT	8
3.2 Description of Test Modes	9
3.2.1 Test Mode Applicability and Tested Channel Detail	10
3.3 Duty Cycle of Test Signal	11
3.4 Description of Support Units	12
3.4.1 Configuration of System under Test	12
3.5 General Description of Applied Standards and References	12
4 Test Types and Results	13
4.1 Radiated Emission and Bandedge Measurement	13
4.1.1 Limits of Radiated Emission and Bandedge Measurement	13
4.1.2 Test Instruments	14
4.1.3 Test Procedures	15
4.1.4 Deviation from Test Standard	15
4.1.5 Test Set Up	16
4.1.6 EUT Operating Conditions	17
4.1.7 Test Results	18
4.2 Conducted Emission Measurement	26
4.2.1 Limits of Conducted Emission Measurement	26
4.2.2 Test Instruments	26
4.2.3 Test Procedures	27
4.2.4 Deviation from Test Standard	27
4.2.5 Test Setup	27
4.2.6 EUT Operating Condition	27
4.2.7 Test Results	28
4.3 Number of Hopping Frequency Used	30
4.3.1 Limits of Hopping Frequency Used Measurement	30
4.3.2 Test Setup	30
4.3.3 Test Instruments	30
4.3.4 Test Procedure	30
4.3.5 Deviation from Test Standard	30
4.3.6 Test Results	31
4.4 Dwell Time on Each Channel	32
4.4.1 Limits of Dwell Time on Each Channel Measurement	32
4.4.2 Test Setup	32
4.4.3 Test Instruments	32
4.4.4 Test Procedures	32
4.4.5 Deviation from Test Standard	32
4.4.6 Test Results	33
4.5 Channel Bandwidth	35
4.5.1 Limits of Channel Bandwidth Measurement	35
4.5.2 Test Setup	35
4.5.3 Test Instruments	35
4.5.4 Test Procedure	35
4.5.5 Deviation from Test Standard	35
4.5.6 EUT Operating Condition	35
4.5.7 Test Results	36
4.6 Occupied Bandwidth Measurement	37

4.6.1	Test Setup	37
4.6.2	Test Instruments	37
4.6.3	Test Procedure	37
4.6.4	Deviation from Test Standard	37
4.6.5	EUT Operating Conditions	37
4.6.6	Test Results	38
4.7	Hopping Channel Separation	39
4.7.1	Limits of Hopping Channel Separation Measurement	39
4.7.2	Test Setup	39
4.7.3	Test Instruments	39
4.7.4	Test Procedure	39
4.7.5	Deviation from Test Standard	39
4.7.6	Test Results	40
4.8	Maximum Output Power	41
4.8.1	Limits of Maximum Output Power Measurement	41
4.8.2	Test Setup	41
4.8.3	Test Instruments	41
4.8.4	Test Procedure	41
4.8.5	Deviation from Test Standard	41
4.8.6	EUT Operating Condition	41
4.8.7	Test Results	42
4.9	Conducted Out of Band Emission Measurement	43
4.9.1	Limits Of Conducted Out of Band Emission Measurement	43
4.9.2	Test Instruments	43
4.9.3	Test Procedure	43
4.9.4	Deviation from Test Standard	43
4.9.5	EUT Operating Condition	43
4.9.6	Test Results	43
5	Pictures of Test Arrangements	46
	Annex A- Band Edge Measurement	47
	Appendix – Information of the Testing Laboratories	49



Release Control Record

Issue No.	Description	Date Issued
RFBHAT-WTW-P21061067	Original Release	Jan. 10, 2022

1 Certificate of Conformity

Product: Open-Q 610 uSOM
Brand: Lantronix
Test Model: Open-Q 610 uSOM
Sample Status: Engineering Sample
Applicant: Lantronix, Inc.
Test Date: Sep. 03 ~ Sep. 15, 2021
Standards: 47 CFR FCC Part 15, Subpart C (Section 15.247)
ANSI C63.10:2013

The above equipment has been tested by **Bureau Veritas Consumer Products Services (H.K.) Ltd., Taoyuan Branch**, and found compliance with the requirement of the above standards. The test record, data evaluation & Equipment Under Test (EUT) configurations represented herein are true and accurate accounts of the measurements of the sample's RF characteristics under the conditions specified in this report.

Prepared by :  , Date: Jan. 10, 2022
Lena Wang / Specialist

Approved by :  , Date: Jan. 10, 2022
Jeremy Lin / Project Engineer

2 Summary of Test Results

47 CFR FCC Part 15, Subpart C (Section 15.247)			
FCC Clause	Test Item	Result	Remarks
15.207	AC Power Conducted Emission	Pass	Meet the requirement of limit. Minimum passing margin is -25.40 dB at 0.40179 MHz.
15.247(a)(1)(iii)	Number of Hopping Frequency Used	Pass	Meet the requirement of limit.
15.247(a)(1)(iii)	Dwell Time on Each Channel	Pass	Meet the requirement of limit.
15.247(a)(1)	1. Hopping Channel Separation 2. Spectrum Bandwidth of a Frequency Hopping Sequence Spread Spectrum System	Pass	Meet the requirement of limit.
15.247(a)(1)	Maximum Peak Output Power	Pass	Meet the requirement of limit.
---	Occupied Bandwidth Measurement	Pass	Reference only
15.205 & 209	Radiated Emissions	Pass	Meet the requirement of limit. Minimum passing margin is -9.84 dB at 2390.00 MHz.
15.247(d)	Band Edge Measurement	Pass	Meet the requirement of limit.
15.247(d)	Antenna Port Emission	Pass	Meet the requirement of limit.
15.203	Antenna Requirement	Pass	Antenna connector is U.FL.

Note:

1. If the Frequency Hopping System operating in 2400-2483.5 MHz band and the output power less than 125 mW. The hopping channel carrier frequencies separated by a minimum of 25 kHz or two-thirds of the 20 dB bandwidth of hopping channel whichever is greater.
2. For 2.4G band compliance with rule 15.247(d) of the band-edge items, the test plots were recorded in Annex A. Test Procedures refer to report 4.1.3.
3. Determining compliance based on the results of the compliance measurement, not taking into account measurement instrumentation uncertainty.

2.1 Measurement Uncertainty

Where relevant, the following measurement uncertainty levels have been estimated for tests performed on the EUT as specified in CISPR 16-4-2:

Measurement	Frequency	Expanded Uncertainty (k=2) (±)
Conducted Emissions at mains ports	150 kHz ~ 30 MHz	2.79 dB
Radiated Emissions up to 1 GHz	9 kHz ~ 30 MHz	3.00 dB
	30 MHz ~ 200 MHz	2.91 dB
	200 MHz ~ 1000 MHz	2.93 dB
Radiated Emissions above 1 GHz	1 GHz ~ 18 GHz	1.76 dB
	18 GHz ~ 40 GHz	1.77 dB

2.2 Modification Record

There were no modifications required for compliance.

3 General Information

3.1 General Description of EUT

Product	Open-Q 610 uSOM
Brand	Lantronix
Test Model	Open-Q 610 uSOM
Status of EUT	Engineering Sample
Power Supply Rating	12 Vdc (Adapter)
Modulation Type	GFSK, $\pi/4$ -DQPSK, 8DPSK
Transfer Rate	1/2/3 Mbps
Operating Frequency	2402 ~ 2480 MHz
Number of Channel	79
Output Power	19.543 mW
Antenna Type	Refer to Note as below
Antenna Connector	Refer to Note as below
Accessory Device	N/A
Data Cable Supplied	N/A

Note:

1. The following antennas were provided to the EUT.

Ant. Type	Flexible Dipole Antenna	
Connector Type	U.FL	
Antenna Gain (dBi)		
	2.4~2.5G	4.9~5.8G
	3.32	6.11

2. The above Antenna information is declared by manufacturer and for more detailed features description, please refer to the manufacturer's specifications, the laboratory shall not be held responsible.
3. The above EUT information is declared by manufacturer and for more detailed features description, please refers to the manufacturer's specifications or User's Manual.
4. The BT could transmit simultaneously with WLAN 5GHz at the same time. The emission of the simultaneous operation has been evaluated and no non-compliance was found.

3.2 Description of Test Modes

79 channels are provided to this EUT:

Channel	Freq. (MHz)	Channel	Freq. (MHz)	Channel	Freq. (MHz)	Channel	Freq. (MHz)
0	2402	20	2422	40	2442	60	2462
1	2403	21	2423	41	2443	61	2463
2	2404	22	2424	42	2444	62	2464
3	2405	23	2425	43	2445	63	2465
4	2406	24	2426	44	2446	64	2466
5	2407	25	2427	45	2447	65	2467
6	2408	26	2428	46	2448	66	2468
7	2409	27	2429	47	2449	67	2469
8	2410	28	2430	48	2450	68	2470
9	2411	29	2431	49	2451	69	2471
10	2412	30	2432	50	2452	70	2472
11	2413	31	2433	51	2453	71	2473
12	2414	32	2434	52	2454	72	2474
13	2415	33	2435	53	2455	73	2475
14	2416	34	2436	54	2456	74	2476
15	2417	35	2437	55	2457	75	2477
16	2418	36	2438	56	2458	76	2478
17	2419	37	2439	57	2459	77	2479
18	2420	38	2440	58	2460	78	2480
19	2421	39	2441	59	2461		

3.2.1 Test Mode Applicability and Tested Channel Detail

EUT Configure Mode	Applicable To				Description
	RE \geq 1G	RE $<$ 1G	PLC	APCM	
-	√	√	√	√	-

Where **RE \geq 1G**: Radiated Emission above 1 GHz **RE $<$ 1G**: Radiated Emission below 1 GHz
PLC: Power Line Conducted Emission **APCM**: Antenna Port Conducted Measurement

Note:

1. The EUT had been pre-tested on the positioned of each 3 axis. The worst case was found when positioned on **Z-plane**.
2. "-" means no effect.
3. Radiated emission test (below 1GHz) and power line conducted emission test items chosen the worst fundamental frequency emission level.

Radiated Emission Test (Above 1 GHz):

- Pre-Scan has been conducted to determine the worst-case mode from all possible combinations between available modulations, data rates and antenna ports (if EUT with antenna diversity architecture).
- Following channel(s) was (were) selected for the final test as listed below.

EUT Configure Mode	Available Channel	Tested Channel	Modulation Technology	Modulation Type	Packet Type
-	0 to 78	0, 39, 78	FHSS	GFSK	DH5
-	0 to 78	0, 39, 78	FHSS	8DPSK	3DH5

Radiated Emission Test (Below 1 GHz):

- Pre-Scan has been conducted to determine the worst-case mode from all possible combinations between available modulations, data rates and antenna ports (if EUT with antenna diversity architecture).
- Following channel(s) was (were) selected for the final test as listed below.

EUT Configure Mode	Available Channel	Tested Channel	Modulation Technology	Modulation Type	Packet Type
-	0 to 78	0	FHSS	GFSK	DH5

Power Line Conducted Emission Test:

- Pre-Scan has been conducted to determine the worst-case mode from all possible combinations between available modulations, data rates and antenna ports (if EUT with antenna diversity architecture).
- Following channel(s) was (were) selected for the final test as listed below.

EUT Configure Mode	Available Channel	Tested Channel	Modulation Technology	Modulation Type	Packet Type
-	0 to 78	0	FHSS	GFSK	DH5

Antenna Port Conducted Measurement:

- This item includes all test value of each mode, but only includes spectrum plot of worst value of each mode.
- Pre-Scan has been conducted to determine the worst-case mode from all possible combinations between available modulations, data rates and antenna ports (if EUT with antenna diversity architecture).
- Following channel(s) was (were) selected for the final test as listed below.

EUT Configure Mode	Available Channel	Tested Channel	Modulation Technology	Modulation Type	Packet Type
-	0 to 78	0, 39, 78	FHSS	GFSK	DH5
-	0 to 78	0, 39, 78	FHSS	8DPSK	3DH5

Test Condition:

Applicable To	Environmental Conditions	Input Power	Tested by
RE \geq 1G	25 deg. C, 65 % RH	120 Vac, 60 Hz	Titan Hsu
RE $<$ 1G	25 deg. C, 65 % RH	120 Vac, 60 Hz	Adair Peng
PLC	25 deg. C, 65 % RH	120 Vac, 60 Hz	Rex Wang
APCM	25 deg. C, 65 % RH	120 Vac, 60 Hz	Ivan Tseng

3.3 Duty Cycle of Test Signal

Duty cycle = 2.89/100 = 0.0289, Duty factor = 20 * log(0.0289) = -30.78

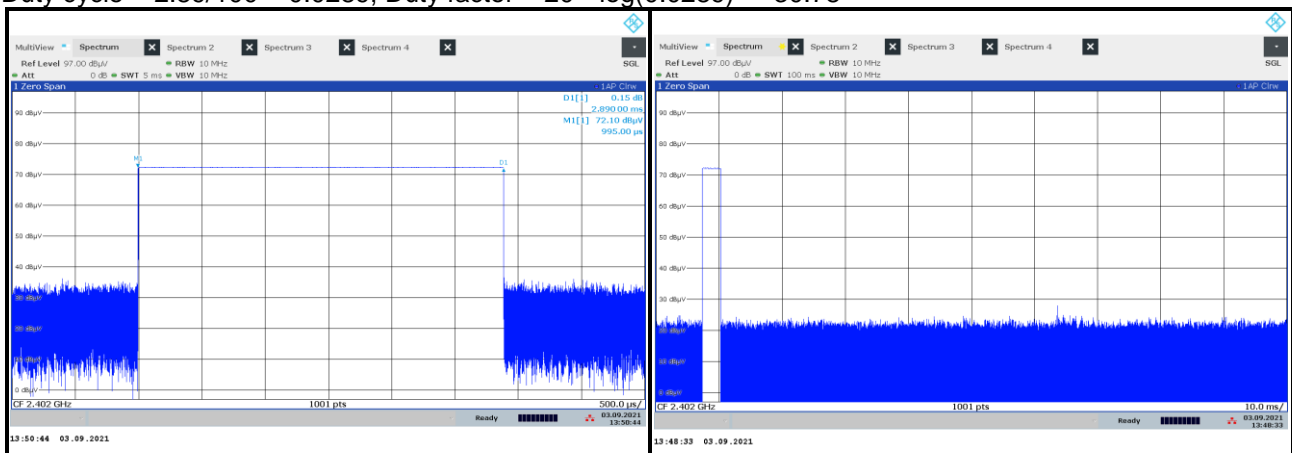

3.4 Description of Support Units

The EUT has been tested as an independent unit together with other necessary accessories or support units. The following support units or accessories were used to form a representative test configuration during the tests.

ID	Product	Brand	Model No.	Serial No.	FCC ID	Remarks
A	Notebook	Lenovo	20J4 MD A003TW	PF-11H9AK	N/A	-
B	Jig	N/A	N/A	N/A	N/A	Provided by client
C	Adapter	YINGHUIYUAN	YHY-12003000	N/A	N/A	Provided by client
D	Antenna	Taoglas	FXP.830.07.0100C	N/A	N/A	Provided by client

Note:

1. All power cords of the above support units are non-shielded (1.8m).
2. Item A acted as a communication partner to transfer data.

ID	Cable Descriptions	Qty.	Length (m)	Shielding (Yes/No)	Cores (Qty.)	Remarks
1.	Type C USB Cable	1	1	Y	0	Provided by client
2.	Adapter Cable	1	1.2	Y	1	Provided by client
3.	Power Cable	1	1.15	N	0	Provided by client

3.4.1 Configuration of System under Test

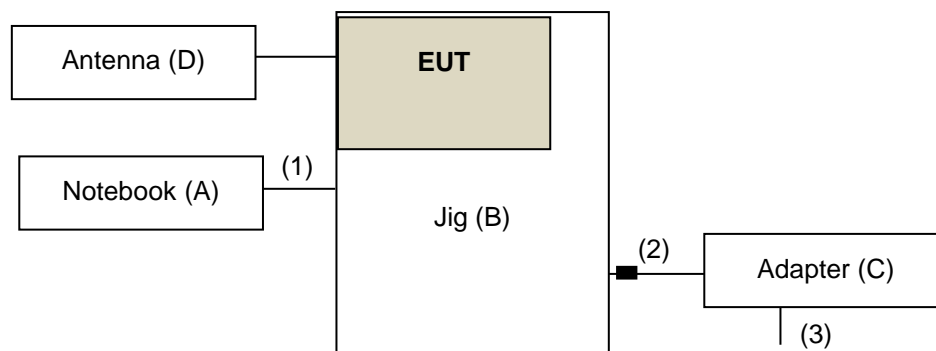

3.5 General Description of Applied Standards and References

The EUT is a RF Product. According to the specifications of the manufacturer, it must comply with the requirements of the following standards and references:

Test Standard:

FCC Part 15, Subpart C (15.247)

ANSI C63.10-2013

All test items have been performed and recorded as per the above standards.

References Test Guidance:

KDB 558074 D01 15.247 Meas Guidance v05r02

All test items have been performed as a reference to the above KDB test guidance.

4 Test Types and Results

4.1 Radiated Emission and Bandedge Measurement

4.1.1 Limits of Radiated Emission and Bandedge Measurement

Radiated emissions which fall in the restricted bands must comply with the radiated emission limits specified as below table. Other emissions shall be at least 20 dB below the highest level of the desired power:

Frequencies (MHz)	Field Strength (microvolts/meter)	Measurement Distance (meters)
0.009 ~ 0.490	2400/F (kHz)	300
0.490 ~ 1.705	24000/F (kHz)	30
1.705 ~ 30.0	30	30
30 ~ 88	100	3
88 ~ 216	150	3
216 ~ 960	200	3
Above 960	500	3

Note:

- a. The lower limit shall apply at the transition frequencies.
- b. Emission level (dBuV/m) = 20 log Emission level (uV/m).
- c. For frequencies above 1000 MHz, the field strength limits are based on average detector, however, the peak field strength of any emission shall not exceed the maximum permitted average limits, specified above by more than 20 dB under any condition of modulation.

4.1.2 Test Instruments

Description & Manufacturer	Model No.	Serial No.	Date of Calibration	Due Date of Calibration
Test Receiver Rohde & Schwarz	N9038A	MY55420137	Apr. 09, 2021	Apr. 08, 2022
Spectrum Analyzer KEYSIGHT	N9020B	MY60110440	Dec. 18, 2020	Dec. 17, 2021
BILOG Antenna SCHWARZBECK	VULB9168	1213	Nov. 04, 2020	Nov. 03, 2021
HORN Antenna SCHWARZBECK	BBHA 9120 D	9120D-563	Nov. 22, 2020	Nov. 21, 2021
HORN Antenna SCHWARZBECK	BBHA 9170	995	Nov. 22, 2020	Nov. 21, 2021
Loop Antenna EMCI	EM-6879	269	Sep. 17, 2020	Sep. 16, 2021
Loop Antenna TESEQ	HLA 6121	45745	Jul. 21, 2021	Jul. 20, 2022
Preamplifier EMCI	EMC330N	980782	Jan. 12, 2021	Jan. 11, 2022
Preamplifier EMCI	EMC118A45SE	980808	Jan. 12, 2021	Jan. 11, 2022
Preamplifier EMCI	EMC184045SE	980788	Jan. 12, 2021	Jan. 11, 2022
RF signal cable EMCI	EMC104-SM-SM- (9000+2000+1000)	201243+ 201231+ 210102	Jan. 12, 2021	Jan. 11, 2022
RF signal cable EMCI	EMCCFD400-NM- NM- (9000+300+500)	201236+ 201235+ 201233	Jan. 12, 2021	Jan. 11, 2022
RF signal cable EMCI	EMC101G-KM-KM- (5000+3000+2000)	201260+201257+2 01254	Jan. 12, 2021	Jan. 11, 2022
Software BV ADT	ADT_Radiated_V7. 6.15.9.5	NA	NA	NA
Antenna Tower Max-Full	MFT-151SS-0.5T	NA	NA	NA
Turn Table Max-Full	MF-7802BS	NA	NA	NA
Turn Table Controller Max-Full	MF-7802BS	MF780208674	NA	NA
USB Wideband Power Sensor KEYSIGHT	U2021XA	MY55050005/MY551 90004/MY55190007/ MY55210005	Jul. 12, 2021	Jul. 11, 2022

Note: 1. The calibration interval of the above test instruments is 12 months and the calibrations are traceable to NML/ROC and NIST/USA.

2. The test was performed in WM Chamber 8.

4.1.3 Test Procedures

For Radiated Emission below 30 MHz

- a. The EUT was placed on the top of a rotating table 0.8 meters above the ground at a 3 meter chamber room. The table was rotated 360 degrees to determine the position of the highest radiation.
- b. The EUT was set 3 meters away from the interference-receiving antenna, which was mounted on the top of a variable-height antenna tower.
- c. Parallel, perpendicular, and ground-parallel orientations of the antenna are set to make the measurement.
- d. For each suspected emission, the EUT was arranged to its worst case and the rotatable table was turned from 0 degrees to 360 degrees to find the maximum reading.
- e. The test-receiver system was set to Quasi-Peak Detect Function and Specified Bandwidth with Maximum Hold Mode.

Note:

1. The resolution bandwidth and video bandwidth of test receiver/spectrum analyzer is 9 kHz at frequency below 30 MHz.

For Radiated Emission above 30 MHz

- a. The EUT was placed on the top of a rotating table 0.8 meters (for 30 MHz ~ 1 GHz) / 1.5 meters (for above 1 GHz) above the ground at 3 meter chamber room for test. The table was rotated 360 degrees to determine the position of the highest radiation.
- b. The EUT was set 3 meters away from the interference-receiving antenna, which was mounted on the top of a variable-height antenna tower.
- c. The height of antenna is varied from one meter to four meters above the ground to determine the maximum value of the field strength. Both horizontal and vertical polarizations of the antenna are set to make the measurement.
- d. For each suspected emission, the EUT was arranged to its worst case and then the antenna was tuned to heights from 1 meter to 4 meters and the rotatable table was turned from 0 degrees to 360 degrees to find the maximum reading.
- e. The test-receiver system was set to quasi-peak detect function and specified bandwidth with maximum hold mode when the test frequency is below 1 GHz.
- f. The test-receiver system was set to peak and average detected function and specified bandwidth with maximum hold mode when the test frequency is above 1 GHz. If the peak reading value also meets average limit, measurement with the average detector is unnecessary.

Note:

1. The resolution bandwidth and video bandwidth of test receiver/spectrum analyzer is 120 kHz for Quasi-peak detection (QP) or Peak detection (PK) at frequency below 1 GHz.
2. The resolution bandwidth of test receiver/spectrum analyzer is 1 MHz and the video bandwidth is 3 MHz for Peak detection (PK) at frequency above 1 GHz.
3. For fundamental and harmonic signal measurement, according to ANSI C63.10 section 7.5, the average value = peak value + duty cycle correction factor. The duty cycle correction factor refer to Chapter 3.3 of this report.
4. All modes of operation were investigated and the worst-case emissions are reported.

4.1.4 Deviation from Test Standard

No deviation.

4.1.5 Test Set Up

<Radiated Emission below 30 MHz>

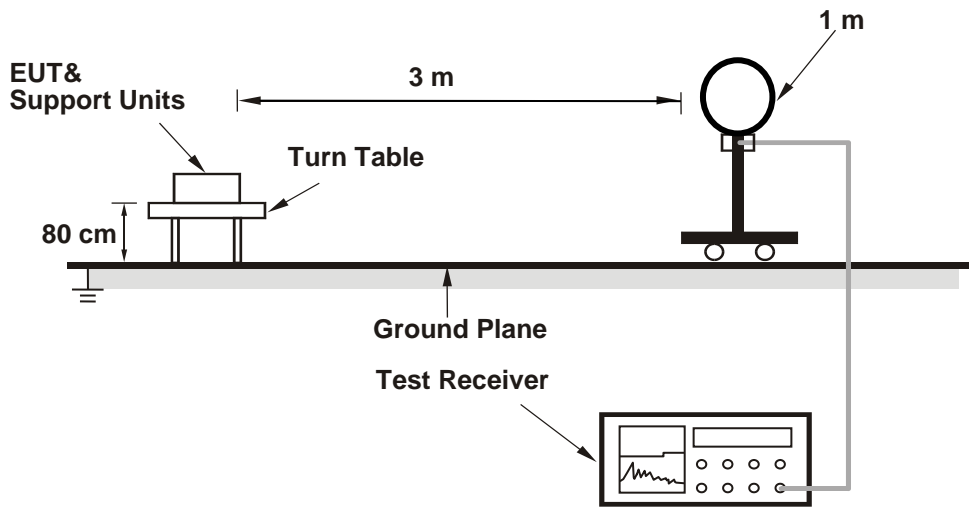

<Radiated Emission 30 MHz to 1 GHz>

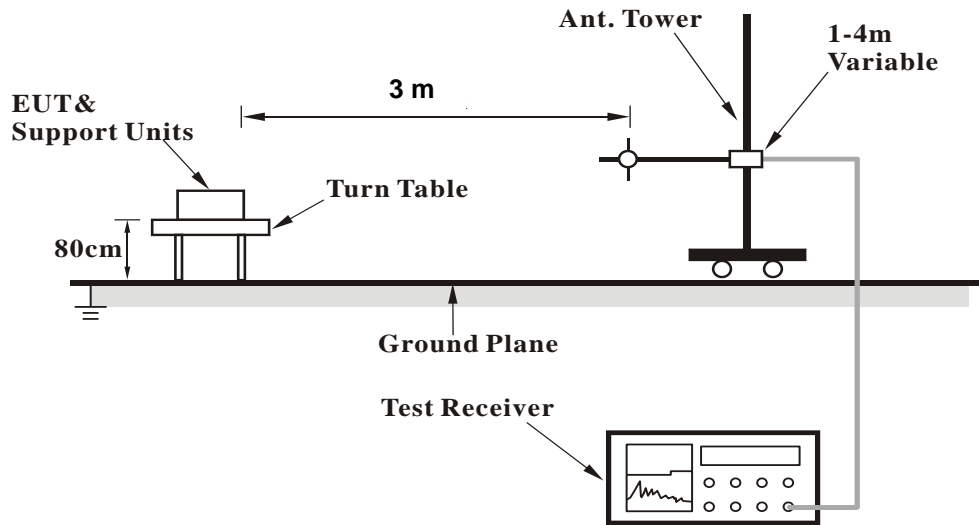

<Radiated Emission above 1 GHz>

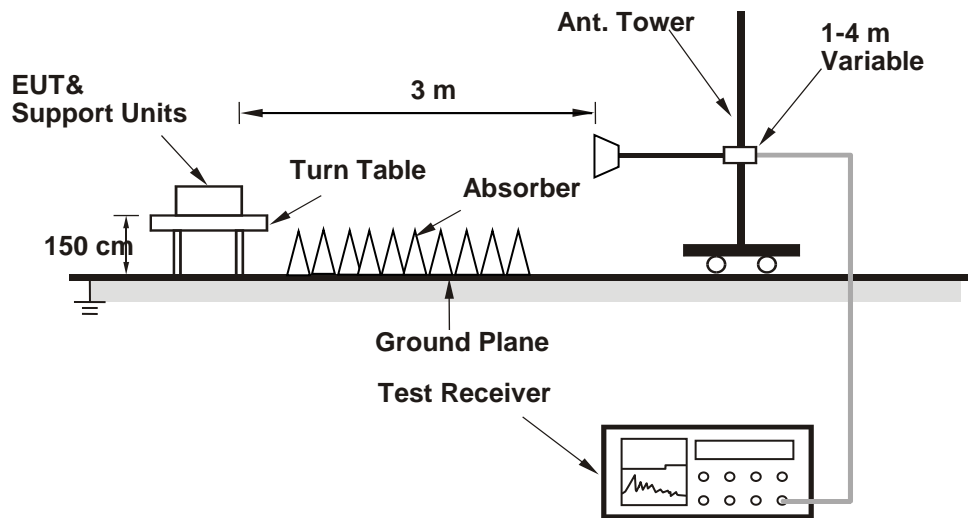

For the actual test configuration, please refer to the attached file (Test Setup Photo).

4.1.6 EUT Operating Conditions

Set the EUT under transmission condition continuously at specific channel frequency.

4.1.7 Test Results

Above 1 GHz Data:
GFSK

RF Mode	TX BT_GFSK	Channel	CH 0 : 2402 MHz
Frequency Range	1GHz ~ 25GHz	Detector Function	Peak (PK) Average (AV)

Antenna Polarity & Test Distance : Horizontal at 3 m								
No	Frequency (MHz)	Emission Level (dBuV/m)	Limit (dBuV/m)	Margin (dB)	Antenna Height (m)	Table Angle (Degree)	Raw Value (dBuV)	Correction Factor (dB/m)
1	2390.00	56.56 PK	74.00	-17.44	1.00 H	296	24.90	31.66
2	2390.00	43.46 AV	54.00	-10.54	1.00 H	296	11.80	31.66
3	*2402.00	103.68 PK			1.00 H	296	72.00	31.68
4	*2402.00	72.90 AV			1.00 H	296	41.22	31.68
5	4804.00	47.86 PK	74.00	-26.14	2.25 H	66	45.50	2.36
6	4804.00	17.08 AV	54.00	-36.92	2.25 H	66	14.72	2.36
Antenna Polarity & Test Distance : Vertical at 3 m								
No	Frequency (MHz)	Emission Level (dBuV/m)	Limit (dBuV/m)	Margin (dB)	Antenna Height (m)	Table Angle (Degree)	Raw Value (dBuV)	Correction Factor (dB/m)
1	2390.00	56.26 PK	74.00	-17.74	1.95 V	203	24.60	31.66
2	2390.00	44.16 AV	54.00	-9.84	1.95 V	203	12.50	31.66
3	*2402.00	107.28 PK			1.95 V	203	75.60	31.68
4	*2402.00	76.50 AV			1.95 V	203	44.82	31.68
5	4804.00	49.66 PK	74.00	-24.34	1.38 V	263	47.30	2.36
6	4804.00	18.88 AV	54.00	-35.12	1.38 V	263	16.52	2.36

Remarks:

- Emission Level(dBuV/m) = Raw Value(dBuV) + Correction Factor(dB/m)
- Correction Factor(dB/m) = Antenna Factor(dB/m) + Cable Factor(dB) – Pre-Amplifier Factor(dB)
- Margin value = Emission Level – Limit value
- The other emission levels were very low against the limit.
- " * ": Fundamental frequency.
- for Fundamental frequency and bandedge & harmonic:
The average value of fundamental frequency is :average = peak value + 20log(Duty cycle)
where the duty factor is calculated from following formula:
 $20\text{Log}(\text{Duty cycle}) = 20 \log (2.89\text{ms} \cdot 1/100) = -30.78\text{dB}$ please refer to the plotted duty (see section 3.3)

RF Mode	TX BT_GFSK	Channel	CH 39 : 2441 MHz
Frequency Range	1GHz ~ 25GHz	Detector Function	Peak (PK) Average (AV)

Antenna Polarity & Test Distance : Horizontal at 3 m

No	Frequency (MHz)	Emission Level (dBuV/m)	Limit (dBuV/m)	Margin (dB)	Antenna Height (m)	Table Angle (Degree)	Raw Value (dBuV)	Correction Factor (dB/m)
1	*2441.00	103.98 PK			1.05 H	293	72.20	31.78
2	*2441.00	73.20 AV			1.05 H	293	41.42	31.78
3	4882.00	48.14 PK	74.00	-25.86	2.28 H	69	45.60	2.54
4	4882.00	17.36 AV	54.00	-36.64	2.28 H	69	14.82	2.54

Antenna Polarity & Test Distance : Vertical at 3 m

No	Frequency (MHz)	Emission Level (dBuV/m)	Limit (dBuV/m)	Margin (dB)	Antenna Height (m)	Table Angle (Degree)	Raw Value (dBuV)	Correction Factor (dB/m)
1	*2441.00	108.38 PK			2.17 V	203	76.60	31.78
2	*2441.00	77.60 AV			2.17 V	203	45.82	31.78
3	4882.00	48.34 PK	74.00	-25.66	1.38 V	266	45.80	2.54
4	4882.00	17.56 AV	54.00	-36.44	1.38 V	266	15.02	2.54

Remarks:

- Emission Level(dBuV/m) = Raw Value(dBuV) + Correction Factor(dB/m)
- Correction Factor(dB/m) = Antenna Factor(dB/m) + Cable Factor(dB) – Pre-Amplifier Factor(dB)
- Margin value = Emission Level – Limit value
- The other emission levels were very low against the limit.
- " * ": Fundamental frequency.
- for Fundamental frequency and bandedge & harmonic:
 The average value of fundamental frequency is :average = peak value + 20log(Duty cycle)
 where the duty factor is calculated from following formula:
 $20\text{Log}(\text{Duty cycle}) = 20 \log (2.89\text{ms}^*1/100) = -30.78\text{dB}$ please refer to the plotted duty (see section 3.3)

RF Mode	TX BT_GFSK	Channel	CH 78 : 2480 MHz
Frequency Range	1GHz ~ 25GHz	Detector Function	Peak (PK) Average (AV)

Antenna Polarity & Test Distance : Horizontal at 3 m

No	Frequency (MHz)	Emission Level (dBuV/m)	Limit (dBuV/m)	Margin (dB)	Antenna Height (m)	Table Angle (Degree)	Raw Value (dBuV)	Correction Factor (dB/m)
1	*2480.00	104.08 PK			1.01 H	285	72.20	31.88
2	*2480.00	73.30 AV			1.01 H	285	41.42	31.88
3	2483.50	50.25 PK	74.00	-23.75	1.01 H	285	54.60	-4.35
4	2483.50	19.47 AV	54.00	-34.53	1.01 H	285	23.82	-4.35
5	4960.00	48.29 PK	74.00	-25.71	2.26 H	63	45.60	2.69
6	4960.00	17.51 AV	54.00	-36.49	2.26 H	63	14.82	2.69

Antenna Polarity & Test Distance : Vertical at 3 m

No	Frequency (MHz)	Emission Level (dBuV/m)	Limit (dBuV/m)	Margin (dB)	Antenna Height (m)	Table Angle (Degree)	Raw Value (dBuV)	Correction Factor (dB/m)
1	*2480.00	108.28 PK			1.88 V	201	76.40	31.88
2	*2480.00	77.50 AV			1.88 V	201	45.62	31.88
3	2483.50	55.35 PK	74.00	-18.65	1.88 V	201	59.70	-4.35
4	2483.50	24.57 AV	54.00	-29.43	1.88 V	201	28.92	-4.35
5	4960.00	49.49 PK	74.00	-24.51	1.42 V	266	46.80	2.69
6	4960.00	18.71 AV	54.00	-35.29	1.42 V	266	16.02	2.69

Remarks:

- Emission Level(dBuV/m) = Raw Value(dBuV) + Correction Factor(dB/m)
- Correction Factor(dB/m) = Antenna Factor(dB/m) + Cable Factor(dB) – Pre-Amplifier Factor(dB)
- Margin value = Emission Level – Limit value
- The other emission levels were very low against the limit.
- " * ": Fundamental frequency.
- for Fundamental frequency and bandedge & harmonic:
The average value of fundamental frequency is :average = peak value + 20log(Duty cycle)
where the duty factor is calculated from following formula:
 $20\text{Log}(\text{Duty cycle}) = 20 \log (2.89\text{ms} \cdot 1/100) = -30.78\text{dB}$ please refer to the plotted duty (see section 3.3)

8DPSK

RF Mode	TX BT_8DPSK	Channel	CH 0 : 2402 MHz
Frequency Range	1GHz ~ 25GHz	Detector Function	Peak (PK) Average (AV)

Antenna Polarity & Test Distance : Horizontal at 3 m								
No	Frequency (MHz)	Emission Level (dBuV/m)	Limit (dBuV/m)	Margin (dB)	Antenna Height (m)	Table Angle (Degree)	Raw Value (dBuV)	Correction Factor (dB/m)
1	2390.00	56.36 PK	74.00	-17.64	1.01 H	297	24.70	31.66
2	2390.00	43.66 AV	54.00	-10.34	1.01 H	297	12.00	31.66
3	*2402.00	104.28 PK			1.01 H	297	72.60	31.68
4	*2402.00	73.50 AV			1.01 H	297	41.82	31.68
5	4804.00	47.96 PK	74.00	-26.04	2.29 H	65	45.60	2.36
6	4804.00	17.18 AV	54.00	-36.82	2.29 H	65	14.82	2.36

Antenna Polarity & Test Distance : Vertical at 3 m								
No	Frequency (MHz)	Emission Level (dBuV/m)	Limit (dBuV/m)	Margin (dB)	Antenna Height (m)	Table Angle (Degree)	Raw Value (dBuV)	Correction Factor (dB/m)
1	2390.00	56.16 PK	74.00	-17.84	1.69 V	202	24.50	31.66
2	2390.00	43.76 AV	54.00	-10.24	1.69 V	202	12.10	31.66
3	*2402.00	108.58 PK			1.69 V	202	76.90	31.68
4	*2402.00	62.46 AV			1.69 V	202	30.78	31.68
5	4804.00	49.96 PK	74.00	-24.04	1.42 V	265	47.60	2.36
6	4804.00	19.18 AV	54.00	-34.82	1.42 V	265	16.82	2.36

Remarks:

- Emission Level(dBuV/m) = Raw Value(dBuV) + Correction Factor(dB/m)
- Correction Factor(dB/m) = Antenna Factor(dB/m) + Cable Factor(dB) – Pre-Amplifier Factor(dB)
- Margin value = Emission Level – Limit value
- The other emission levels were very low against the limit.
- " * ": Fundamental frequency.
- for Fundamental frequency and bandedge & harmonic:
The average value of fundamental frequency is :average = peak value + 20log(Duty cycle)
where the duty factor is calculated from following formula:
 $20\text{Log}(\text{Duty cycle}) = 20 \log (2.89\text{ms} \times 1/100) = -30.78\text{dB}$ please refer to the plotted duty (see section 3.3)

RF Mode	TX BT_8DPSK	Channel	CH 39 : 2441 MHz
Frequency Range	1GHz ~ 25GHz	Detector Function	Peak (PK) Average (AV)

Antenna Polarity & Test Distance : Horizontal at 3 m

No	Frequency (MHz)	Emission Level (dBuV/m)	Limit (dBuV/m)	Margin (dB)	Antenna Height (m)	Table Angle (Degree)	Raw Value (dBuV)	Correction Factor (dB/m)
1	*2441.00	105.28 PK			1.01 H	295	73.50	31.78
2	*2441.00	74.50 AV			1.01 H	295	42.72	31.78
3	4882.00	48.24 PK	74.00	-25.76	2.30 H	66	45.70	2.54
4	4882.00	17.46 AV	54.00	-36.54	2.30 H	66	14.92	2.54

Antenna Polarity & Test Distance : Vertical at 3 m

No	Frequency (MHz)	Emission Level (dBuV/m)	Limit (dBuV/m)	Margin (dB)	Antenna Height (m)	Table Angle (Degree)	Raw Value (dBuV)	Correction Factor (dB/m)
1	*2441.00	109.58 PK			1.74 V	222	77.80	31.78
2	*2441.00	78.80 AV			1.74 V	222	47.02	31.78
3	4882.00	50.34 PK	74.00	-23.66	1.45 V	263	47.80	2.54
4	4882.00	19.56 AV	54.00	-34.44	1.45 V	263	17.02	2.54

Remarks:

- Emission Level(dBuV/m) = Raw Value(dBuV) + Correction Factor(dB/m)
- Correction Factor(dB/m) = Antenna Factor(dB/m) + Cable Factor(dB) – Pre-Amplifier Factor(dB)
- Margin value = Emission Level – Limit value
- The other emission levels were very low against the limit.
- " * ": Fundamental frequency.
- for Fundamental frequency and bandedge & harmonic:
 The average value of fundamental frequency is :average = peak value + 20log(Duty cycle)
 where the duty factor is calculated from following formula:
 $20\text{Log}(\text{Duty cycle}) = 20 \log (2.89\text{ms}^*1/100) = -30.78\text{dB}$ please refer to the plotted duty (see section 3.3)

RF Mode	TX BT_8DPSK	Channel	CH 78 : 2480 MHz
Frequency Range	1GHz ~ 25GHz	Detector Function	Peak (PK) Average (AV)

Antenna Polarity & Test Distance : Horizontal at 3 m

No	Frequency (MHz)	Emission Level (dBuV/m)	Limit (dBuV/m)	Margin (dB)	Antenna Height (m)	Table Angle (Degree)	Raw Value (dBuV)	Correction Factor (dB/m)
1	*2480.00	105.28 PK			1.12 H	293	73.40	31.88
2	*2480.00	74.50 AV			1.12 H	293	42.62	31.88
3	2483.50	54.05 PK	74.00	-19.95	1.12 H	293	58.40	-4.35
4	2483.50	23.27 AV	54.00	-30.73	1.12 H	293	27.62	-4.35
5	4960.00	48.39 PK	74.00	-25.61	2.31 H	69	45.70	2.69
6	4960.00	17.61 AV	54.00	-36.39	2.31 H	69	14.92	2.69

Antenna Polarity & Test Distance : Vertical at 3 m

No	Frequency (MHz)	Emission Level (dBuV/m)	Limit (dBuV/m)	Margin (dB)	Antenna Height (m)	Table Angle (Degree)	Raw Value (dBuV)	Correction Factor (dB/m)
1	*2480.00	109.68 PK			1.81 V	228	77.80	31.88
2	*2480.00	78.90 AV			1.81 V	228	47.02	31.88
3	2483.50	58.45 PK	74.00	-15.55	1.81 V	228	62.80	-4.35
4	2483.50	27.67 AV	54.00	-26.33	1.81 V	228	32.02	-4.35
5	4960.00	49.99 PK	74.00	-24.01	1.45 V	269	47.30	2.69
6	4960.00	19.21 AV	54.00	-34.79	1.45 V	269	16.52	2.69

Remarks:

- Emission Level(dBuV/m) = Raw Value(dBuV) + Correction Factor(dB/m)
- Correction Factor(dB/m) = Antenna Factor(dB/m) + Cable Factor(dB) – Pre-Amplifier Factor(dB)
- Margin value = Emission Level – Limit value
- The other emission levels were very low against the limit.
- " * ": Fundamental frequency.
- for Fundamental frequency and bandedge & harmonic:
The average value of fundamental frequency is :average = peak value + 20log(Duty cycle)
where the duty factor is calculated from following formula:
 $20\text{Log}(\text{Duty cycle}) = 20 \log (2.89\text{ms} \cdot 1/100) = -30.78\text{dB}$ please refer to the plotted duty (see section 3.3)

9 kHz ~ 30 MHz Data:

The amplitude of spurious emissions attenuated more than 20 dB below the permissible value is not required to be report.

30 MHz ~ 1 GHz Worst-Case Data:

RF Mode	TX BT_GFSK	Channel	CH 0 : 2402 MHz
Frequency Range	30MHz ~ 1GHz	Detector Function	Quasi-Peak (QP)

Antenna Polarity & Test Distance : Horizontal at 3 m								
No	Frequency (MHz)	Emission Level (dBuV/m)	Limit (dBuV/m)	Margin (dB)	Antenna Height (m)	Table Angle (Degree)	Raw Value (dBuV)	Correction Factor (dB/m)
1	143.87	20.1 QP	43.5	-23.4	1.50 H	270	38.4	-18.3
2	263.36	27.4 QP	46.0	-18.6	1.00 H	153	46.5	-19.1
3	311.16	24.9 QP	46.0	-21.1	1.00 H	187	42.2	-17.3
4	371.61	25.7 QP	46.0	-20.3	1.00 H	46	41.5	-15.8
5	394.10	26.0 QP	46.0	-20.0	2.00 H	314	41.4	-15.4
6	455.96	23.2 QP	46.0	-22.8	1.00 H	63	36.7	-13.5

Remarks:

1. Emission Level(dBuV/m) = Raw Value(dBuV) + Correction Factor(dB/m)
2. Correction Factor(dB/m) = Antenna Factor(dB/m) + Cable Factor(dB) – Pre-Amplifier Factor(dB)
3. Margin value = Emission Level – Limit value
4. The other emission levels were very low against the limit of frequency range 30MHz~1000MHz.
5. The emission levels were very low against the limit of frequency range 9kHz~30MHz: the amplitude of spurious emissions attenuated more than 20 dB below the permissible value to be report.

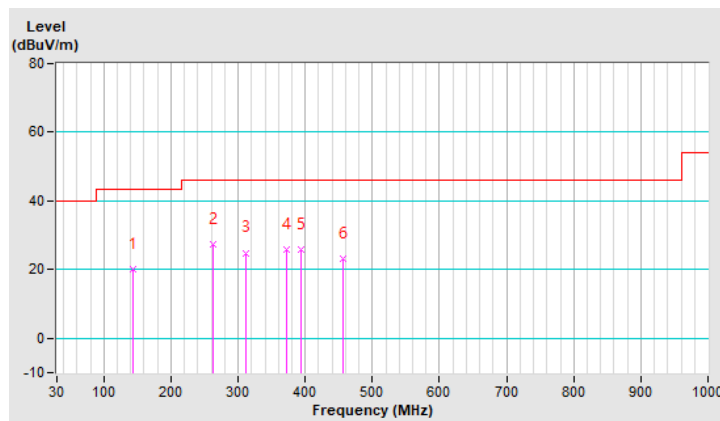

RF Mode	TX BT_GFSK	Channel	CH 0 : 2402 MHz
Frequency Range	30MHz ~ 1GHz	Detector Function	Quasi-Peak (QP)

Antenna Polarity & Test Distance : Vertical at 3 m								
No	Frequency (MHz)	Emission Level (dBuV/m)	Limit (dBuV/m)	Margin (dB)	Antenna Height (m)	Table Angle (Degree)	Raw Value (dBuV)	Correction Factor (dB/m)
1	37.03	23.0 QP	40.0	-17.0	1.00 V	12	41.9	-18.9
2	79.20	23.2 QP	40.0	-16.8	1.00 V	262	46.1	-22.9
3	142.46	22.4 QP	43.5	-21.1	1.49 V	18	40.9	-18.5
4	263.36	22.8 QP	46.0	-23.2	1.00 V	70	41.9	-19.1
5	371.61	26.0 QP	46.0	-20.0	1.00 V	175	41.8	-15.8
6	455.96	24.9 QP	46.0	-21.1	1.00 V	171	38.4	-13.5

Remarks:

1. Emission Level(dBuV/m) = Raw Value(dBuV) + Correction Factor(dB/m)
2. Correction Factor(dB/m) = Antenna Factor(dB/m) + Cable Factor(dB) – Pre-Amplifier Factor(dB)
3. Margin value = Emission Level – Limit value
4. The other emission levels were very low against the limit of frequency range 30MHz~1000MHz.
5. The emission levels were very low against the limit of frequency range 9kHz~30MHz: the amplitude of spurious emissions attenuated more than 20 dB below the permissible value to be report.

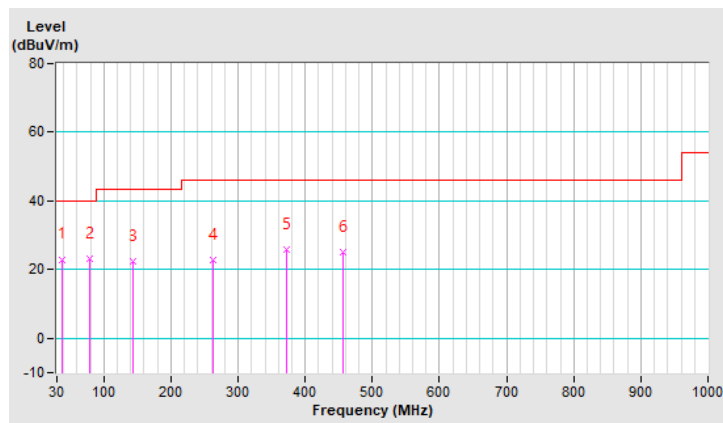

4.2 Conducted Emission Measurement

4.2.1 Limits of Conducted Emission Measurement

Frequency (MHz)	Conducted Limit (dBuV)	
	Quasi-Peak	Average
0.15 - 0.5	66 - 56	56 - 46
0.50 - 5.0	56	46
5.0 - 30.0	60	50

- Note: 1. The lower limit shall apply at the transition frequencies.
 2. The limit decreases in line with the logarithm of the frequency in the range of 0.15 to 0.50 MHz.

4.2.2 Test Instruments

Description & Manufacturer	Model No.	Serial No.	Date of Calibration	Due Date of Calibration
Test Receiver ROHDE & SCHWARZ	ESR3	102783	Dec. 21, 2020	Dec. 20, 2021
RF signal cable (with 10dB PAD) Woken	5D-FB	Cable-cond2-01	Sep. 04, 2021	Sep. 03, 2022
LISN/AMN ROHDE & SCHWARZ (EUT)	ESH2-Z5	100100	Jan. 28, 2021	Jan. 27, 2022
LISN/AMN ROHDE & SCHWARZ (Peripheral)	ENV216	101196	Apr. 26, 2021	Apr. 25, 2022
Software ADT	BV ADT_Cond_ V7.3.7.4	NA	NA	NA

- Note: 1. The calibration interval of the above test instruments is 12 months and the calibrations are traceable to NML/ROC and NIST/USA.
 2. The test was performed in HwaYa Shielded Room 2. (Conduction 2).
 3. The VCCI Site Registration No. is C-12047.

4.2.3 Test Procedures

- The EUT was placed 0.4 meters from the conducting wall of the shielded room with EUT being connected to the power mains through a line impedance stabilization network (LISN). Other support units were connected to the power mains through another LISN. The two LISNs provide 50 ohm/ 50 uH of coupling impedance for the measuring instrument.
- Both lines of the power mains connected to the EUT were checked for maximum conducted interference.
- The frequency range from 150 kHz to 30 MHz was searched. Emission levels under (Limit – 20 dB) was not recorded.

Note: The resolution bandwidth and video bandwidth of test receiver is 9 kHz for quasi-peak detection (QP) and average detection (AV) at frequency 0.15 MHz - 30 MHz.

4.2.4 Deviation from Test Standard

No deviation.

4.2.5 Test Setup

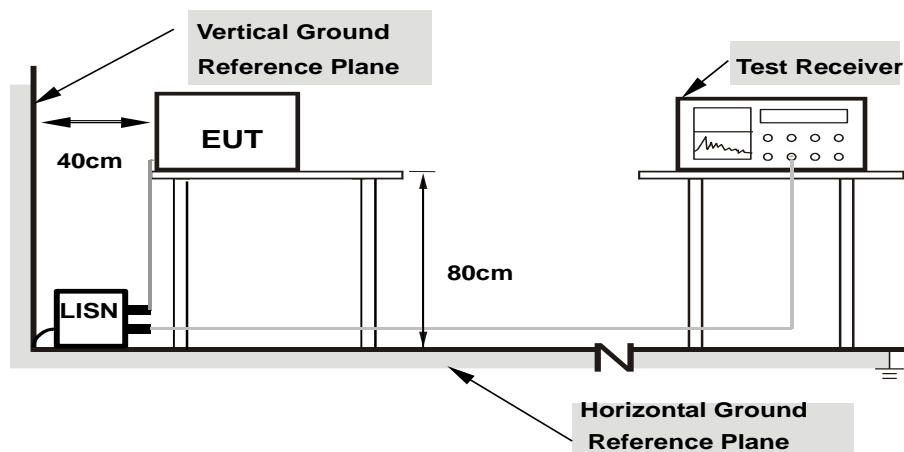

- Note:**
- Support units were connected to second LISN.
 - Both of LISNs (AMN) are 80 cm from EUT and at least 80 from other units and other metal planes

For the actual test configuration, please refer to the attached file (Test Setup Photo).

4.2.6 EUT Operating Condition

Set the EUT under transmission condition continuously at specific channel frequency.

4.2.7 Test Results

Frequency Range	150kHz ~ 30MHz	Detector Function & Resolution Bandwidth	Quasi-Peak (QP) / Average (AV), 9kHz
Input Power	120Vac, 60Hz	Environmental Conditions	25 °C, 75% RH
Tested by	Rex Wang	Test Date	2021/9/11

Phase Of Power : Line (L)										
No	Frequency (MHz)	Correction Factor (dB)	Reading Value (dBuV)		Emission Level (dBuV)		Limit (dBuV)		Margin (dB)	
			Q.P.	AV.	Q.P.	AV.	Q.P.	AV.	Q.P.	AV.
1	0.15400	10.11	19.88	5.19	29.99	15.30	65.78	55.78	-35.79	-40.48
2	0.24200	10.13	10.30	5.01	20.43	15.14	62.03	52.03	-41.60	-36.89
3	0.31000	10.14	15.65	3.72	25.79	13.86	59.97	49.97	-34.18	-36.11
4	1.22600	10.18	6.14	1.22	16.32	11.40	56.00	46.00	-39.68	-34.60
5	9.94200	10.33	6.78	2.19	17.11	12.52	60.00	50.00	-42.89	-37.48
6	18.39000	10.45	11.30	4.34	21.75	14.79	60.00	50.00	-38.25	-35.21

Remarks:

1. Q.P. and AV. are abbreviations of quasi-peak and average individually.
2. The emission levels of other frequencies were very low against the limit.
3. Margin value = Emission level – Limit value
4. Correction factor = Insertion loss + Cable loss
5. Emission Level = Correction Factor + Reading Value

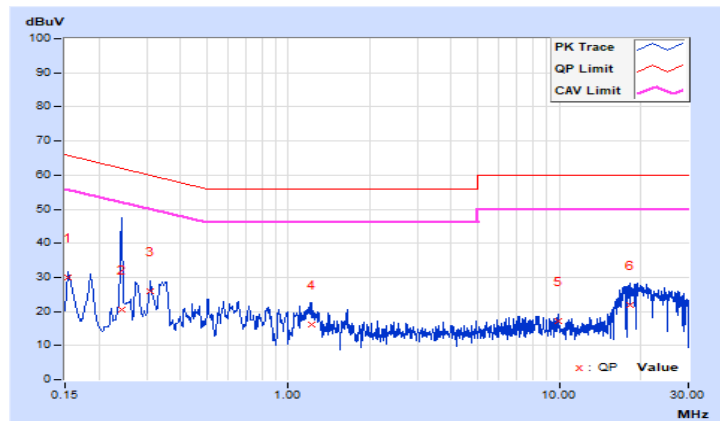

Frequency Range	150kHz ~ 30MHz	Detector Function & Resolution Bandwidth	Quasi-Peak (QP) / Average (AV), 9kHz
Input Power	120Vac, 60Hz	Environmental Conditions	25 °C, 75% RH
Tested by	Rex Wang	Test Date	2021/9/11

Phase Of Power : Neutral (N)										
No	Frequency (MHz)	Correction Factor (dB)	Reading Value (dBuV)		Emission Level (dBuV)		Limit (dBuV)		Margin (dB)	
			Q.P.	AV.	Q.P.	AV.	Q.P.	AV.	Q.P.	AV.
1	0.16600	10.12	21.41	1.28	31.53	11.40	65.16	55.16	-33.63	-43.76
2	0.30200	10.14	15.97	2.05	26.11	12.19	60.19	50.19	-34.08	-38.00
3	0.40179	10.15	22.27	6.70	32.42	16.85	57.82	47.82	-25.40	-30.97
4	1.21000	10.19	7.11	0.55	17.30	10.74	56.00	46.00	-38.70	-35.26
5	8.08200	10.38	5.55	2.18	15.93	12.56	60.00	50.00	-44.07	-37.44
6	21.60600	10.61	9.05	3.29	19.66	13.90	60.00	50.00	-40.34	-36.10

Remarks:

1. Q.P. and AV. are abbreviations of quasi-peak and average individually.
2. The emission levels of other frequencies were very low against the limit.
3. Margin value = Emission level – Limit value
4. Correction factor = Insertion loss + Cable loss
5. Emission Level = Correction Factor + Reading Value

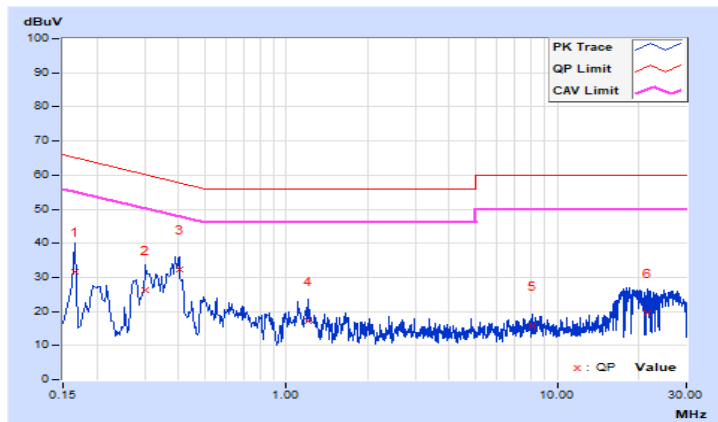

4.3 Number of Hopping Frequency Used

4.3.1 Limits of Hopping Frequency Used Measurement

At least 15 channels frequencies, and should be equally spaced.

4.3.2 Test Setup

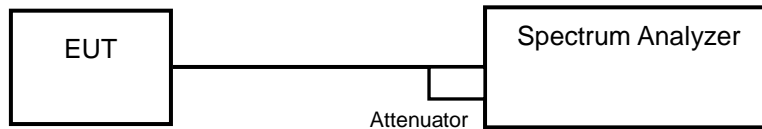

4.3.3 Test Instruments

Refer to section 4.1.2 to get information of above instrument.

4.3.4 Test Procedure

- a. Check the calibration of the measuring instrument (SA) using either an internal calibrator or a known signal from an external generator.
- b. Turn on the EUT and connect its antenna terminal to measurement via a low loss cable. Then set it to any one measured frequency within its operating range and make sure the instrument is operated in its linear range.
- c. Set the SA on MaxHold Mode, and then keep the EUT in hopping mode. Record all the signals from each channel until each one has been recorded.
- d. Set the SA on View mode and then plot the result on SA screen.
- e. Repeat above procedures until all frequencies measured were complete.

4.3.5 Deviation from Test Standard

No deviation.

4.3.6 Test Results

There are 79 hopping frequencies in the hopping mode. Please refer to next page for the test result. On the plots, it shows that the hopping frequencies are equally spaced.

<GFSK>

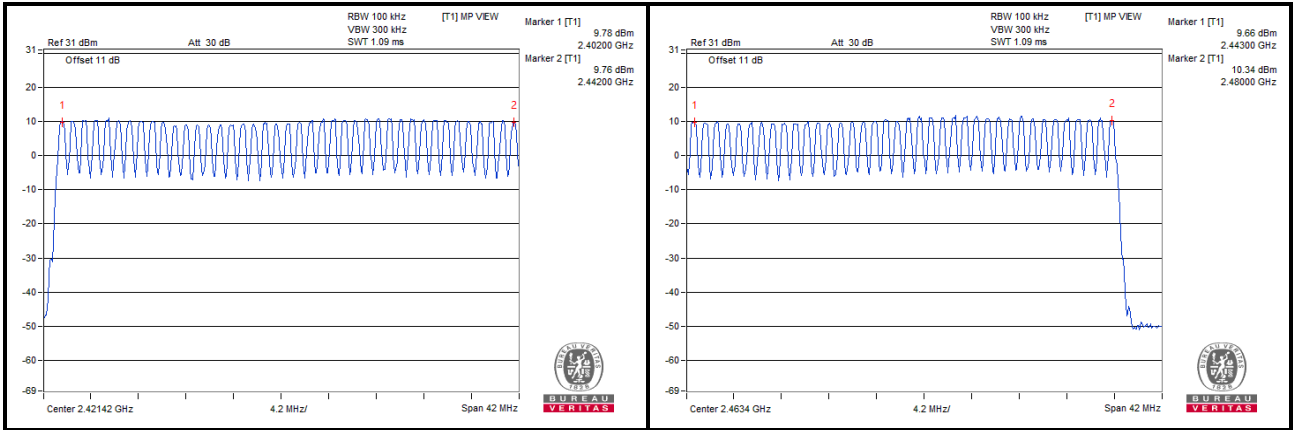

<8DPSK>

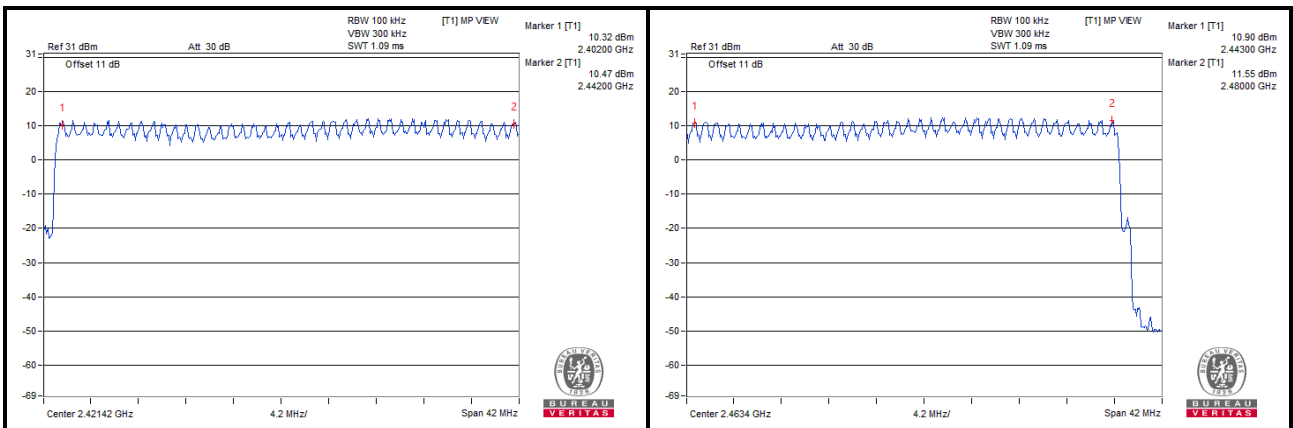

4.4 Dwell Time on Each Channel

4.4.1 Limits of Dwell Time on Each Channel Measurement

The average time of occupancy on any channel shall not be greater than 0.4 seconds within a period of 0.4 seconds multiplied by the number of hopping channels employed.

4.4.2 Test Setup

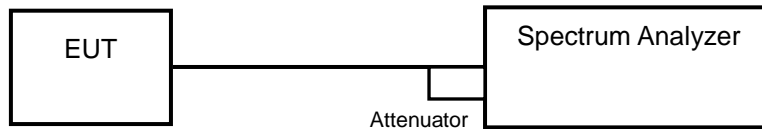

4.4.3 Test Instruments

Refer to section 4.1.2 to get information of above instrument.

4.4.4 Test Procedures

- a. Check the calibration of the measuring instrument (SA) using either an internal calibrator or a known signal from an external generator.
- b. Turn on the EUT and connect its antenna terminal to measurement via a low loss cable. Then set it to any one measured frequency within its operating range and make sure the instrument is operated in its linear range.
- c. Adjust the center frequency of SA on any frequency be measured and set SA to zero span mode. And then, set RBW and VBW of spectrum analyzer to proper value.
- d. Measure the time duration of one transmission on the measured frequency. And then plot the result with time difference of this time duration.
- e. Repeat above procedures until all different time-slot modes have been completed.

4.4.5 Deviation from Test Standard

No deviation.

4.4.6 Test Results

GFSK

Mode	Number of Transmission in a 31.6 (79 Hopping*0.4)	Length of Transmission Time (msec)	Result (msec)	Limit (msec)
DH1	50 (times / 5 sec) * 6.32 = 316 times	0.43	135.88	400
DH3	26 (times / 5 sec) * 6.32 = 165 times	1.7	280.5	400
DH5	17 (times / 5 sec) * 6.32 = 108 times	2.925	315.9	400

Note: Test plots of the transmitting time slot are shown as below.

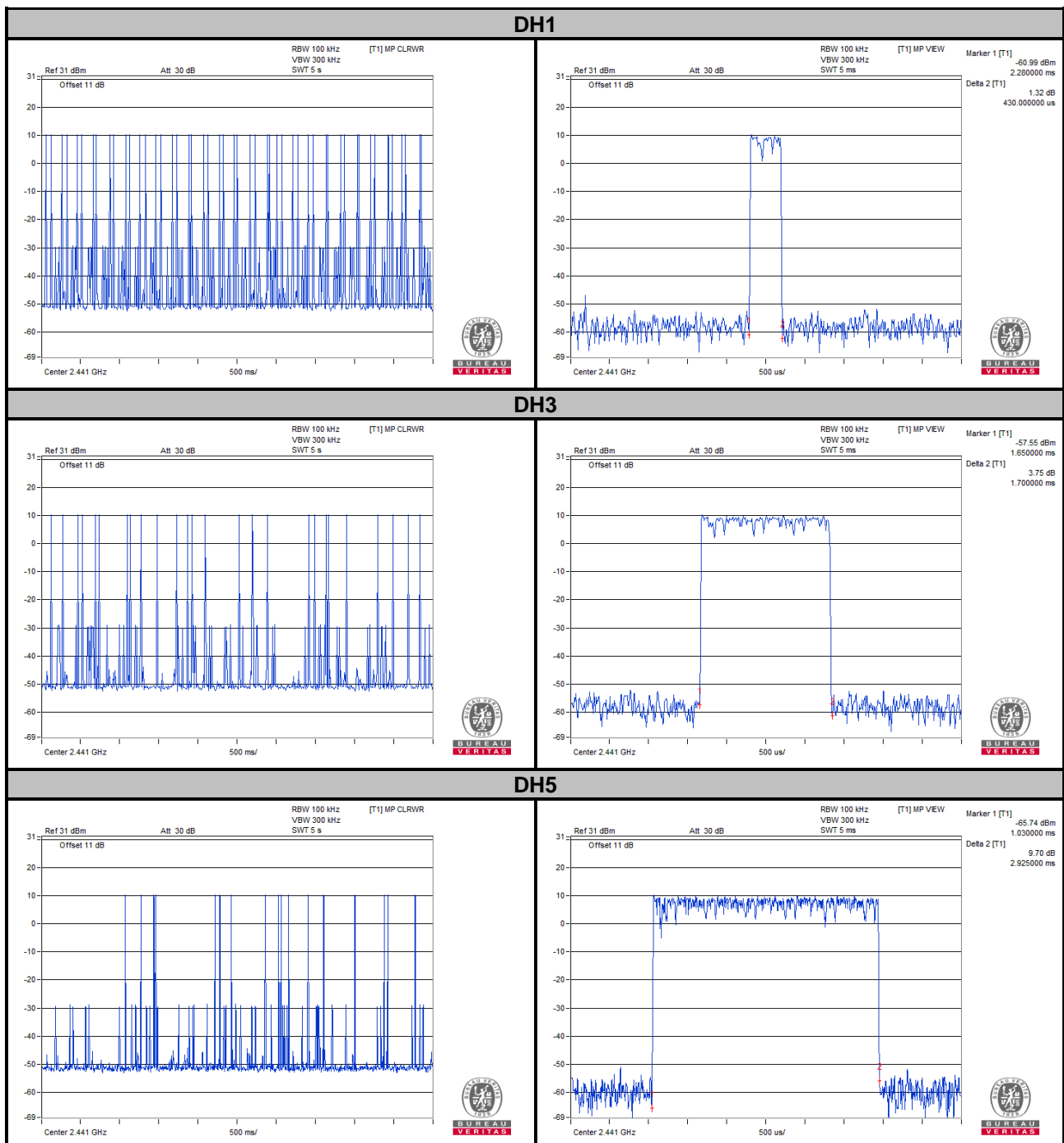

8DPSK

Mode	Number of Transmission in a 31.6 (79 Hopping*0.4)	Length of Transmission Time (msec)	Result (msec)	Limit (msec)
3DH1	50 (times / 5 sec) * 6.32 = 323 times	0.48	155.04	400
3DH3	26 (times / 5 sec) * 6.32 = 165 times	1.74	287.1	400
3DH5	18 (times / 5 sec) * 6.32 = 114 times	2.94	335.16	400

Note: Test plots of the transmitting time slot are shown as below.



4.5 Channel Bandwidth

4.5.1 Limits of Channel Bandwidth Measurement

For frequency hopping system operating in the 2400-2483.5 MHz, if the 20 dB bandwidth of hopping channel is greater than 25 kHz, two-thirds 20 dB bandwidth of hopping channel shall be a minimum limit for the hopping channel separation.

4.5.2 Test Setup



4.5.3 Test Instruments

Refer to section 4.1.2 to get information of above instrument.

4.5.4 Test Procedure

- Check the calibration of the measuring instrument using either an internal calibrator or a known signal from an external generator.
- Turn on the EUT and connect it to measurement instrument. Then set it to any one convenient frequency within its operating range. Set a reference level on the measuring instrument equal to the highest peak value.
- Measure the frequency difference of two frequencies that were attenuated 20 dB from the reference level. Record the frequency difference as the emission bandwidth.
- Repeat above procedures until all frequencies measured were complete.

4.5.5 Deviation from Test Standard

No deviation.

4.5.6 EUT Operating Condition

The software provided by client enabled the EUT to transmit and receive data at lowest, middle and highest channel frequencies individually.

4.5.7 Test Results

Channel	Frequency (MHz)	20 dB Bandwidth (MHz)	
		GFSK	8DPSK
0	2402	0.95	1.30
39	2441	0.95	1.29
78	2480	0.95	1.30

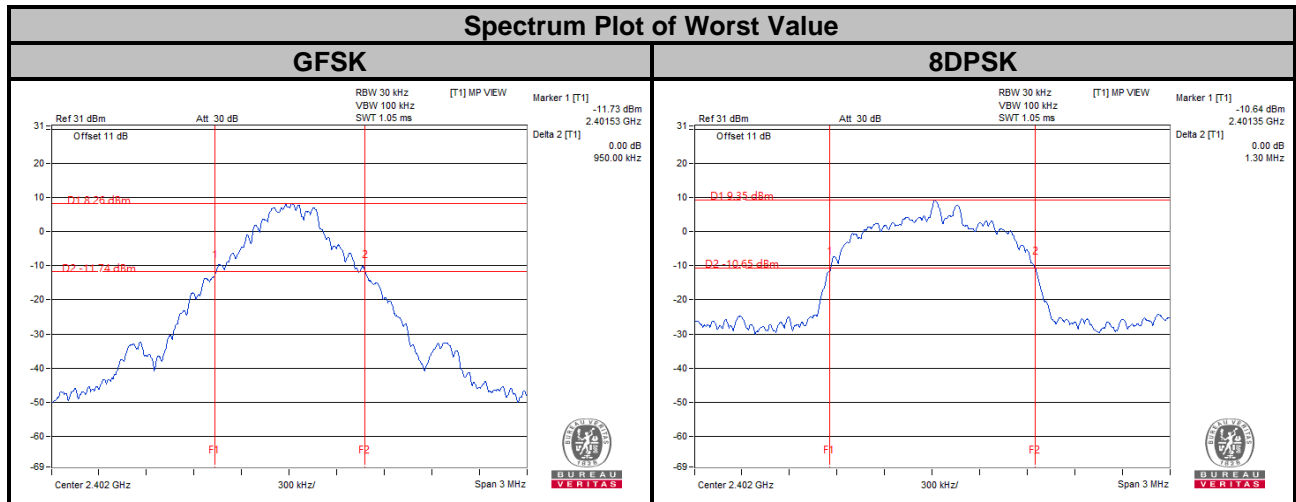

4.6 Occupied Bandwidth Measurement

4.6.1 Test Setup



4.6.2 Test Instruments

Refer to section 4.1.2 to get information of above instrument

4.6.3 Test Procedure

The transmitter output was connected to the spectrum analyzer through an attenuator. The bandwidth of the fundamental frequency was measured by spectrum analyzer with resolution bandwidth in the range of 1 % to 5 % of the anticipated emission bandwidth, and a video bandwidth at least 3x the resolution bandwidth and set the detector to sampling. The width of a frequency band such that, below the lower and above the upper frequency limits, the mean powers emitted are each equal to a specified percentage 0.5 % of the total mean power of a given emission.

4.6.4 Deviation from Test Standard

No deviation.

4.6.5 EUT Operating Conditions

The software provided by client to enable the EUT under transmission condition continuously at lowest, middle and highest channel frequencies individually.

4.6.6 Test Results

Channel	Frequency (MHz)	Occupied Bandwidth (MHz)	
		GFSK	8DPSK
0	2402	0.86	1.20
39	2441	0.85	1.18
78	2480	0.85	1.21

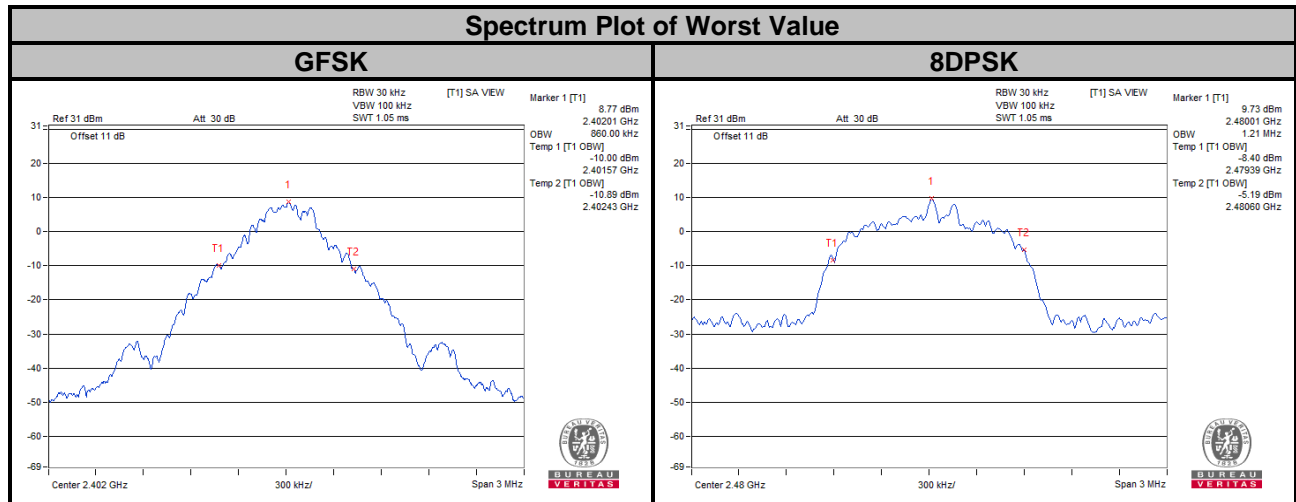

4.7 Hopping Channel Separation

4.7.1 Limits of Hopping Channel Separation Measurement

At least 25 kHz or two-third of 20 dB hopping channel bandwidth (whichever is greater).

4.7.2 Test Setup

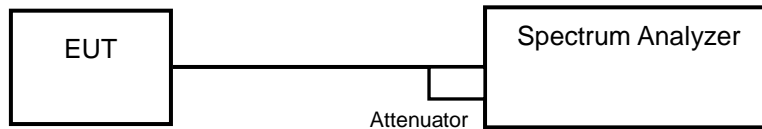

4.7.3 Test Instruments

Refer to section 4.1.2 to get information of above instrument.

4.7.4 Test Procedure

Measurement Procedure REF

- Check the calibration of the measuring instrument using either an internal calibrator or a known signal from an external generator.
- Turn on the EUT and connect it to measurement instrument. Then set it to any one convenient frequency within its operating range.
- By using the MaxHold function record the separation of two adjacent channels.
- Measure the frequency difference of these two adjacent channels by SA MARK function. And then plot the result on SA screen.
- Repeat above procedures until all frequencies measured were complete.

4.7.5 Deviation from Test Standard

No deviation.

4.7.6 Test Results

Channel	Freq. (MHz)	Adjacent Channel Separation (MHz)		20 dB Bandwidth (MHz)		Minimum Limit (MHz)		Pass / Fail
		GFSK	8DPSK	GFSK	8DPSK	GFSK	8DPSK	
0	2402	1.00	1.00	0.95	1.30	0.64	0.87	Pass
39	2441	1.00	1.00	0.95	1.29	0.64	0.86	Pass
78	2480	1.00	1.00	0.95	1.30	0.64	0.87	Pass

Note:

- The minimum limit is two-third 20 dB bandwidth.

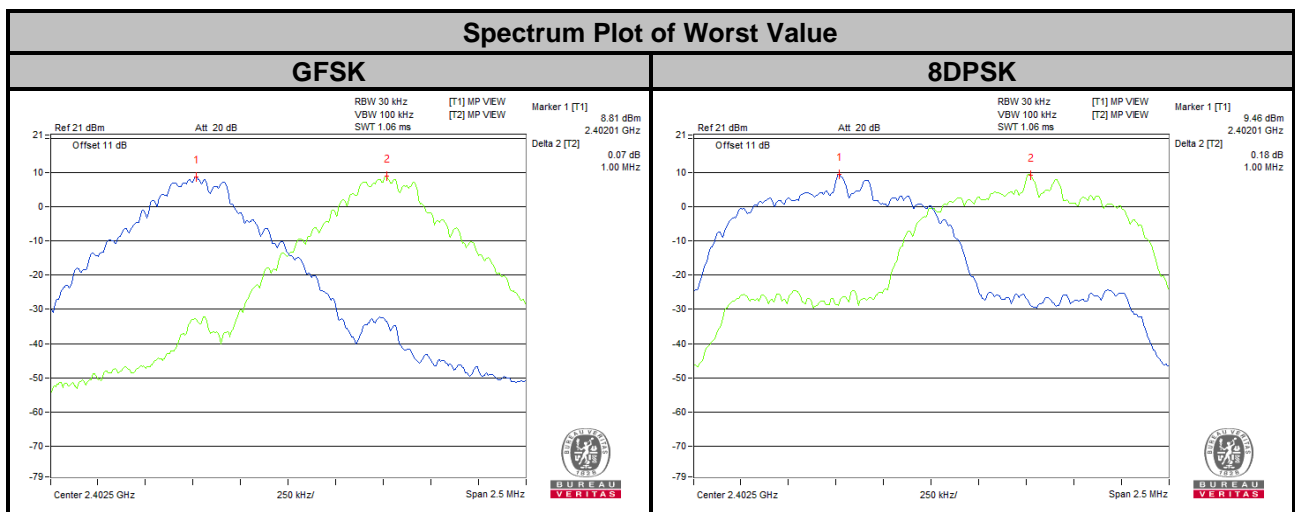

4.8 Maximum Output Power

4.8.1 Limits of Maximum Output Power Measurement

For frequency hopping systems operating in the 2400-2483.5 MHz band employing at least 75 non-overlapping hopping channels: 1 watt.

For all other frequency hopping systems in the 2400-2483.5 MHz band: 0.125 watts.

4.8.2 Test Setup

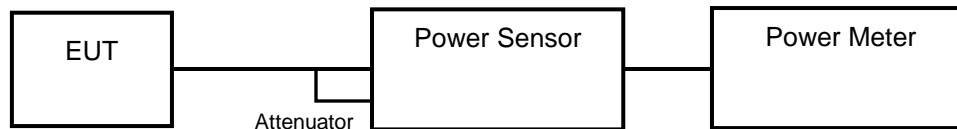

4.8.3 Test Instruments

Refer to section 4.1.2 to get information of above instrument.

4.8.4 Test Procedure

A peak power sensor was used on the output port of the EUT. A power meter was used to read the response of the peak power sensor. Record the power level.

Average power sensor was used to perform output power measurement, trigger and gating function of wide band power meter is enabled to measure max output power of TX on burst. Duty factor is not added to measured value.

4.8.5 Deviation from Test Standard

No deviation.

4.8.6 EUT Operating Condition

The software provided by client enabled the EUT to transmit and receive data at lowest, middle and highest channel frequencies individually.

4.8.7 Test Results

<GFSK>

Channel	Freq. (MHz)	Peak Power		Average Power		Power Limit (mW)	Pass / Fail
		(mW)	(dBm)	(mW)	(dBm)		
0	2402	11.508	10.61	11.22	10.50	125 / 1000 ^{Note}	Pass
39	2441	12.023	10.80	11.668	10.67	125 / 1000 ^{Note}	Pass
78	2480	12.677	11.03	12.331	10.91	125 / 1000 ^{Note}	Pass

Note: RF Output Power limit depends on the operating channel numbers, please refer to section 4.3 of the results.

<8DPSK>

Channel	Freq. (MHz)	Peak Power		Average Power		Power Limit (mW)	Pass / Fail
		(mW)	(dBm)	(mW)	(dBm)		
0	2402	16.52	12.18	11.298	10.53	125 / 1000 ^{Note}	Pass
39	2441	19.543	12.91	12.134	10.84	125 / 1000 ^{Note}	Pass
78	2480	17.742	12.49	12.218	10.87	125 / 1000 ^{Note}	Pass

Note: RF Output Power limit depends on the operating channel numbers, please refer to section 4.3 of the results.

4.9 Conducted Out of Band Emission Measurement

4.9.1 Limits Of Conducted Out of Band Emission Measurement

Below -20 dB of the highest emission level of operating band (in 100 kHz RBW).

4.9.2 Test Instruments

Refer to section 4.1.2 to get information of above instrument.

4.9.3 Test Procedure

The transmitter output was connected to the spectrum analyzer via a low lose cable. Set both RBW and VBW of spectrum analyzer to 100 kHz and 300 kHz with suitable frequency span including 100 MHz bandwidth from band edge. The band edges was measured and recorded.

4.9.4 Deviation from Test Standard

No deviation.

4.9.5 EUT Operating Condition

The software provided by client enabled the EUT to transmit and receive data at lowest, middle and highest channel frequencies individually.

4.9.6 Test Results

The spectrum plots are attached on the following images. D1 line indicates the highest level, D2 line indicates the 20 dB offset below D1. It shows compliance with the requirement.

GFSK

Hopping Disabled_Low Channel

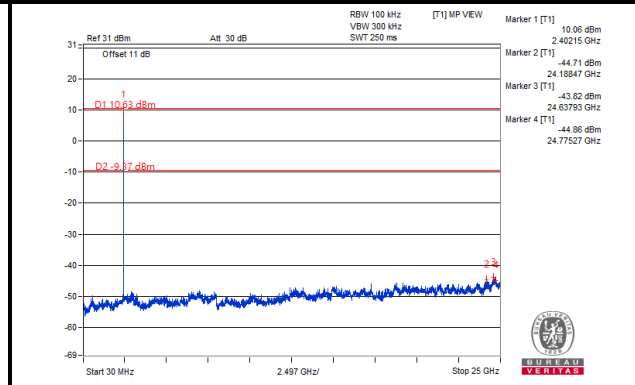
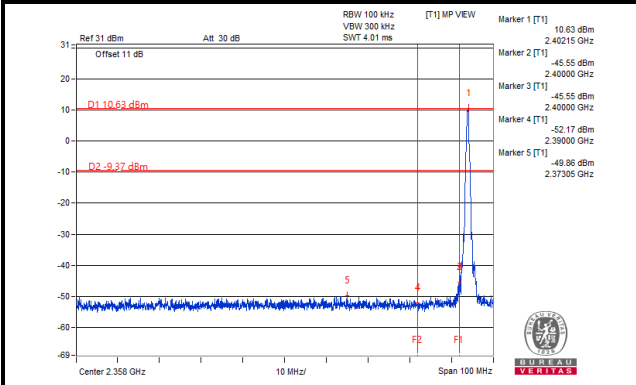

Hopping Disabled_High Channel

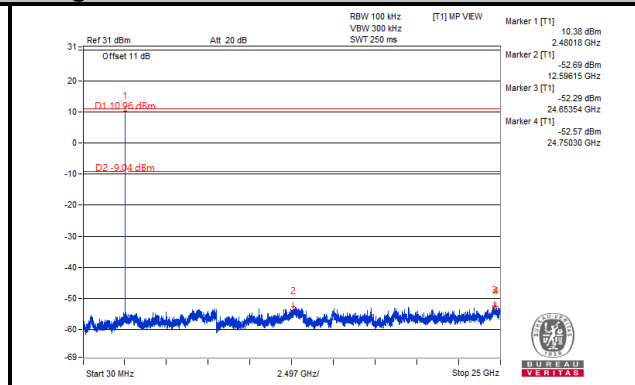
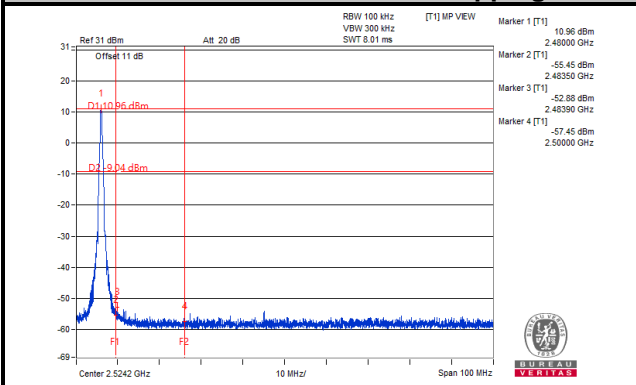

Hopping Enabled_Low Channel

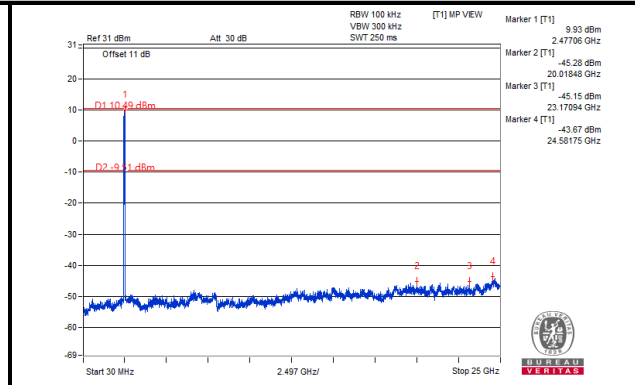
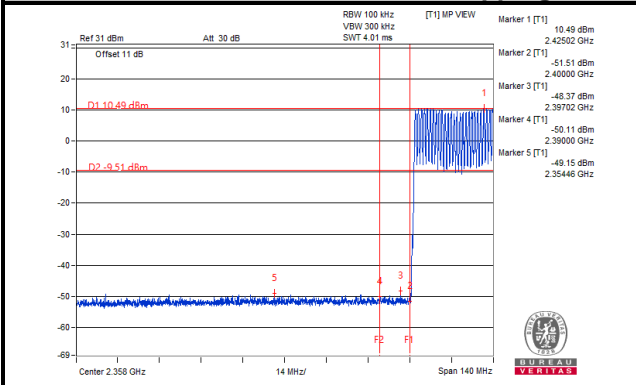

Hopping Enabled_High Channel

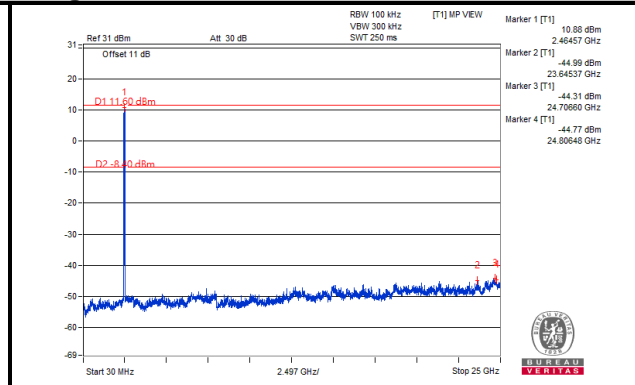
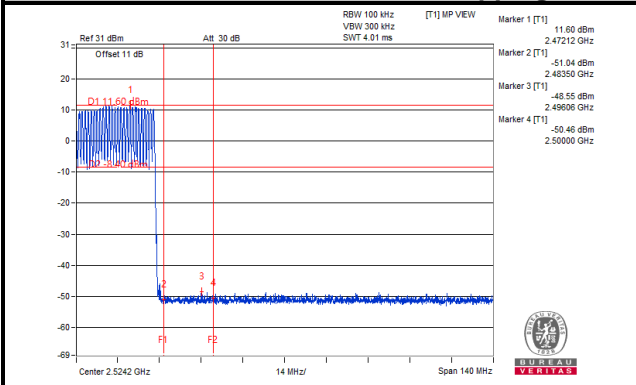

8DPSK

Hopping Disabled_Low Channel

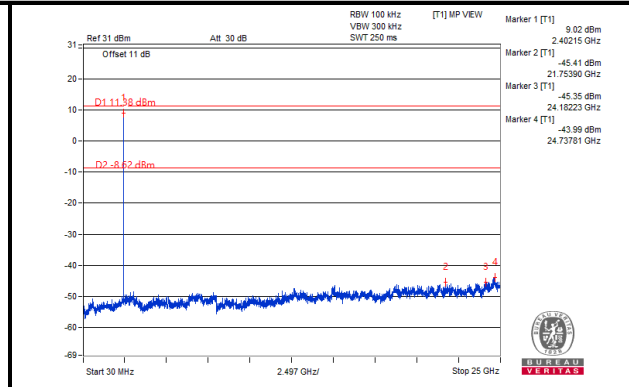
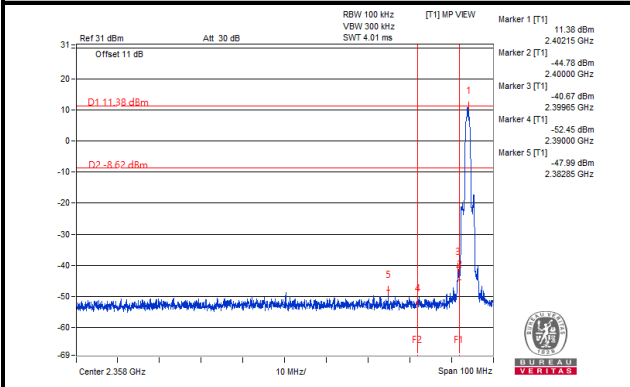

Hopping Disabled_High Channel

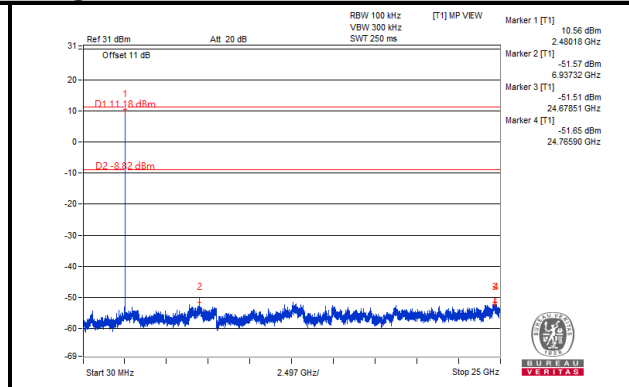
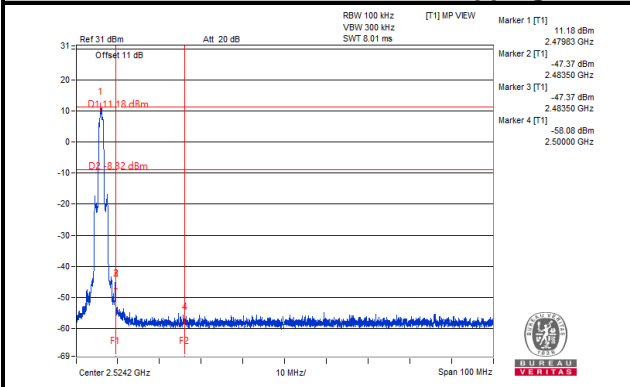

Hopping Enabled_Low Channel

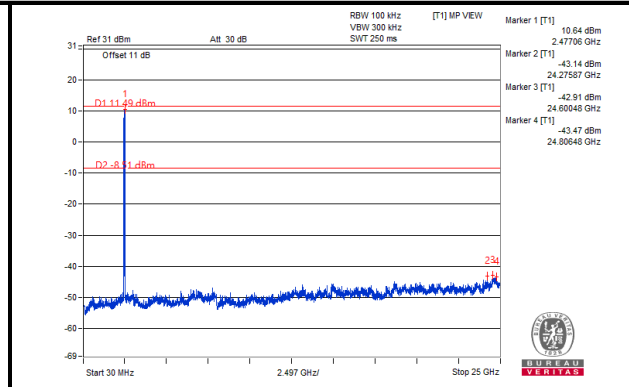
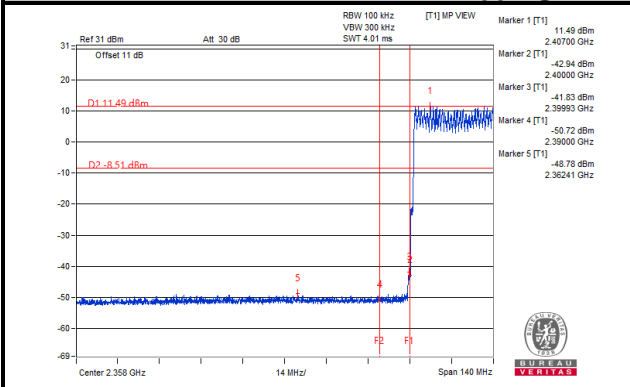

Hopping Enabled_High Channel

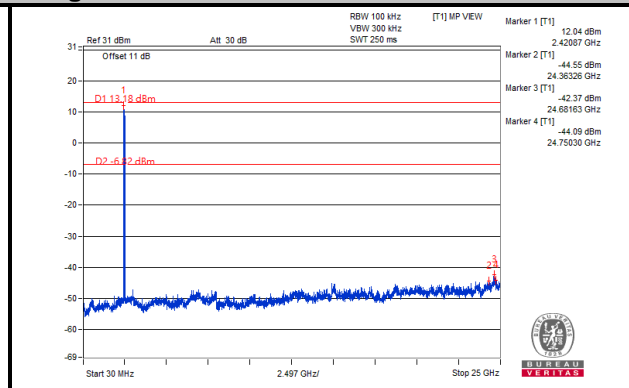
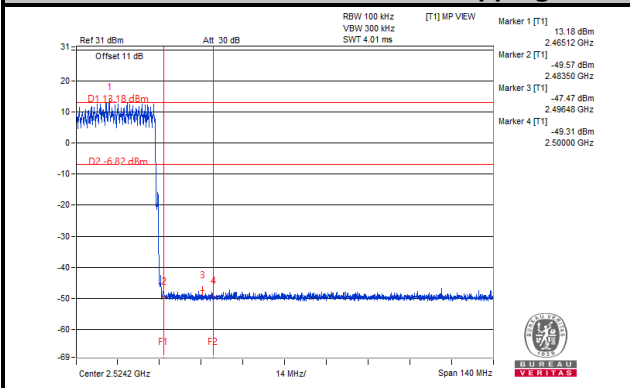

5 Pictures of Test Arrangements

Please refer to the attached file (Test Setup Photo).

Annex A- Band Edge Measurement

GFSK

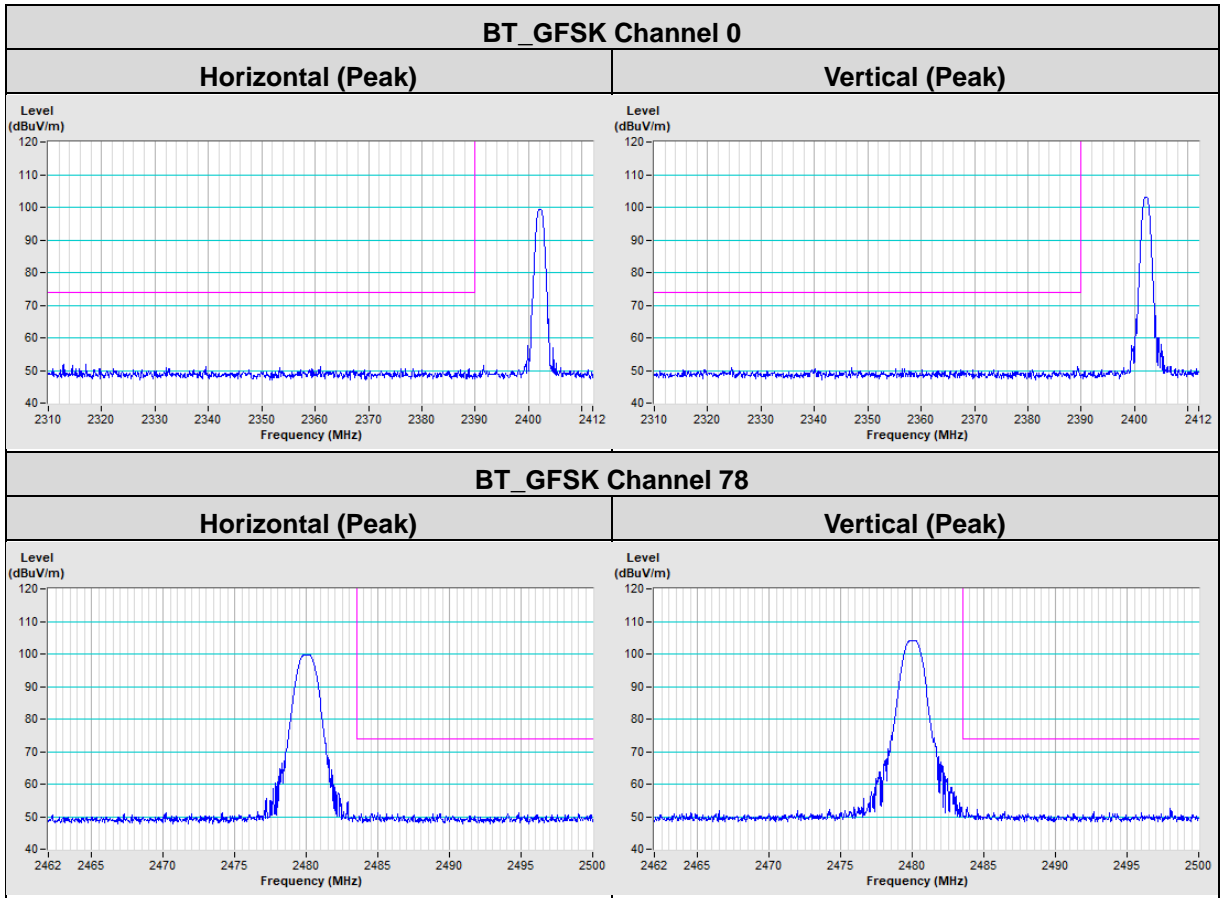

8DPSK

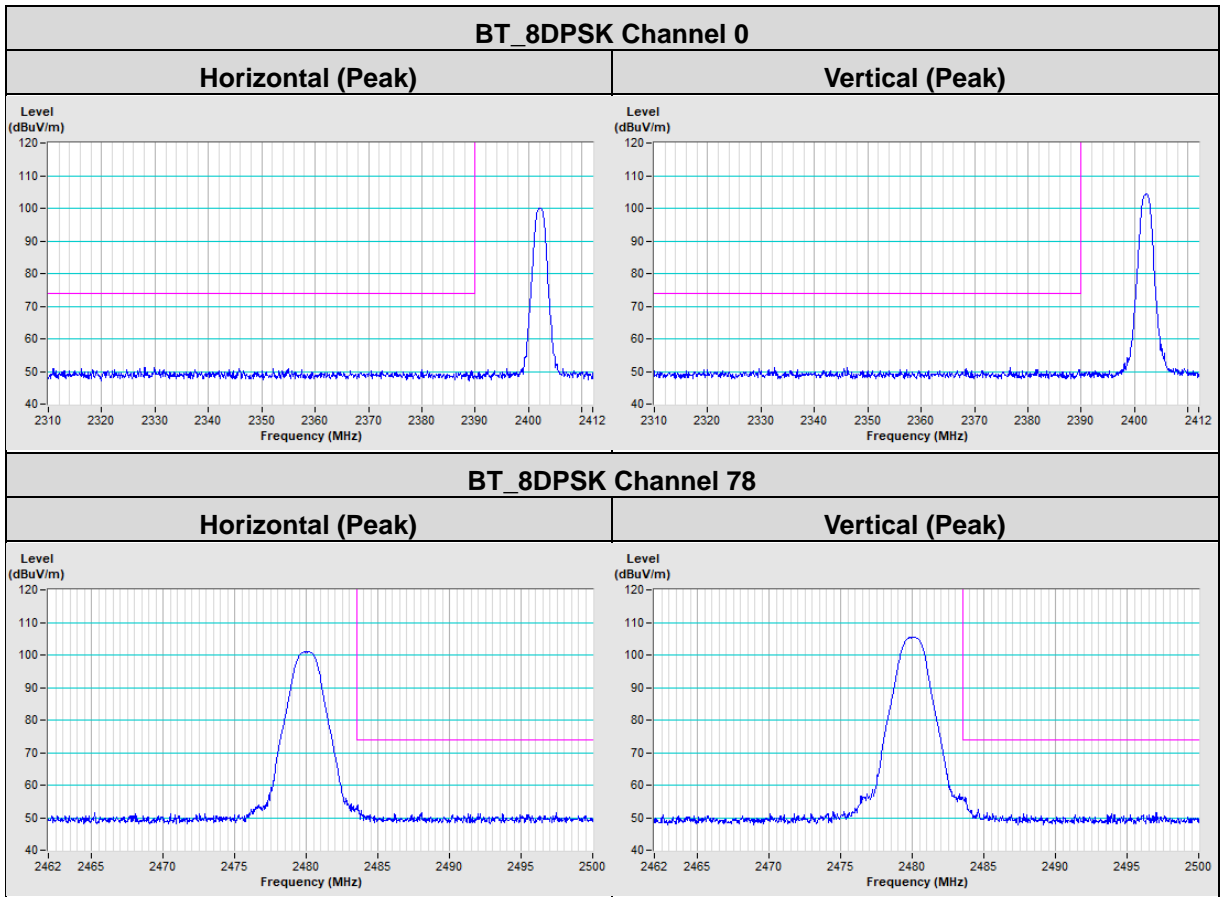

Appendix – Information of the Testing Laboratories

We, Bureau Veritas Consumer Products Services (H.K.) Ltd., Taoyuan Branch, were founded in 1988 to provide our best service in EMC, Radio, Telecom and Safety consultation. Our laboratories are FCC recognized accredited test firms and accredited according to ISO/IEC 17025.

If you have any comments, please feel free to contact us at the following:

Lin Kou EMC/RF Lab

Tel: 886-2-26052180

Fax: 886-2-26051924

Hsin Chu EMC/RF/Telecom Lab

Tel: 886-3-6668565

Fax: 886-3-6668323

Hwa Ya EMC/RF/Safety Lab

Tel: 886-3-3183232

Fax: 886-3-3270892

Email: service.adt@tw.bureauveritas.com

Web Site: www.bureauveritas-adt.com

The address and road map of all our labs can be found in our web site also.

--- END ---