

## FCC Test Report

**Report No.:** RFBHAT-WTW-P21061067-3

**FCC ID:** R68OQ610US

**Test Model:** Open-Q 610 uSOM

**Received Date:** Jun. 29, 2021

**Test Date:** Sep. 03 ~ Oct. 21, 2021

**Issued Date:** Jan. 10, 2022

**Applicant:** Lantronix, Inc.

**Address:** 7535 Irvine Center Drive, Suite 100, Irvine, CA 92618 USA

**Issued By:** Bureau Veritas Consumer Products Services (H.K.) Ltd., Taoyuan Branch  
Lin Kou Laboratories

**Lab Address:** No. 47-2, 14th Ling, Chia Pau Vil., Lin Kou Dist., New Taipei City, Taiwan

**Test Location (1):** No.19, Hwa Ya 2nd Rd., Wen Hwa Vil., Kwei Shan Dist., Taoyuan City  
33383, Taiwan

**Test Location (2):** No. 70, Wenming Rd., Guishan Dist., Taoyuan City 333, Taiwan

**FCC Registration /** 788550 / TW0003

**Designation Number:** 281270 / TW0032



This report is for your exclusive use. Any copying or replication of this report to or for any other person or entity, or use of our name or trademark, is permitted only with our prior written permission. This report sets forth our findings solely with respect to the test samples identified herein. The results set forth in this report are not indicative or representative of the quality or characteristics of the lot from which a test sample was taken or any similar or identical product unless specifically and expressly noted. Our report includes all of the tests requested by you and the results thereof based upon the information that you provided to us. You have 60 days from date of issuance of this report to notify us of any material error or omission caused by our negligence, provided, however, that such notice shall be in writing and shall specifically address the issue you wish to raise. A failure to raise such issue within the prescribed time shall constitute your unqualified acceptance of the completeness of this report, the tests conducted and the correctness of the report contents. Unless specific mention, the uncertainty of measurement has been explicitly taken into account to declare the compliance or non-compliance to the specification.

## Table of Contents

<b>Release Control Record .....</b>	<b>4</b>
<b>1 Certificate of Conformity .....</b>	<b>5</b>
<b>2 Summary of Test Results.....</b>	<b>6</b>
2.1 Measurement Uncertainty.....	6
2.2 Modification Record .....	6
<b>3 General Information .....</b>	<b>7</b>
3.1 General Description of EUT .....	7
3.2 Description of Test Modes.....	9
3.2.1 Test Mode Applicability and Tested Channel Detail.....	11
3.3 Duty Cycle of Test Signal .....	13
3.4 Description of Support Units .....	14
3.4.1 Configuration of System under Test .....	14
3.5 General Description of Applied Standards and References .....	14
<b>4 Test Types and Results .....</b>	<b>15</b>
4.1 Radiated Emission and Bandedge Measurement .....	15
4.1.1 Limits of Radiated Emission and Bandedge Measurement .....	15
4.1.2 Test Instruments .....	17
4.1.3 Test Procedures.....	18
4.1.4 Deviation from Test Standard .....	18
4.1.5 Test Setup.....	19
4.1.6 EUT Operating Conditions.....	20
4.1.7 Test Results .....	21
4.2 Conducted Emission Measurement.....	64
4.2.1 Limits of Conducted Emission Measurement .....	64
4.2.2 Test Instruments .....	64
4.2.3 Test Procedures.....	65
4.2.4 Deviation from Test Standard .....	65
4.2.5 Test Setup.....	65
4.2.6 EUT Operating Conditions.....	65
4.2.7 Test Results .....	66
4.3 Transmit Power Measurement.....	68
4.3.1 Limits of Transmit Power Measurement .....	68
4.3.2 Test Setup.....	68
4.3.3 Test Instruments .....	69
4.3.4 Test Procedure .....	69
4.3.5 Deviation from Test Standard .....	69
4.3.6 EUT Operating Conditions.....	69
4.3.7 Test Results .....	70
4.4 Occupied Bandwidth Measurement.....	79
4.4.1 Test Setup.....	79
4.4.2 Test Instruments .....	79
4.4.3 Test Procedure .....	79
4.4.4 Test Results .....	80
4.5 Peak Power Spectral Density Measurement .....	85
4.5.1 Limits of Peak Power Spectral Density Measurement .....	85
4.5.2 Test Setup.....	85
4.5.3 Test Instruments .....	85
4.5.4 Test Procedures.....	85
4.5.5 Deviation from Test Standard .....	86
4.5.6 EUT Operating Conditions.....	86
4.5.7 Test Results .....	87
4.6 Frequency Stability .....	94
4.6.1 Limit of Frequency Stability Measurement .....	94

4.6.2 Test Setup .....	94
4.6.3 Test Instruments .....	94
4.6.4 Test Procedure .....	94
4.6.5 Deviation from Test Standard .....	94
4.6.6 EUT Operating Condition .....	94
4.6.7 Test Results .....	95
4.7 6 dB Bandwidth Measurement.....	96
4.7.1 Limits of 6 dB Bandwidth Measurement.....	96
4.7.2 Test Setup.....	96
4.7.3 Test Instruments .....	96
4.7.4 Test Procedure .....	96
4.7.5 Deviation from Test Standard .....	96
4.7.6 EUT Operating Condition .....	96
4.7.7 Test Results .....	97
<b>5 Pictures of Test Arrangements.....</b>	<b>99</b>
<b>Annex A- Radiated Out of Band Emission (OOBE) Measurement (For U-NII-3 band) .....</b>	<b>100</b>
<b>Annex B- Band Edge Measurement.....</b>	<b>103</b>
<b>Appendix – Information of the Testing Laboratories .....</b>	<b>117</b>

### Release Control Record

Issue No.	Description	Date Issued
RFBHAT-WTW-P21061067-3	Original Release	Jan. 10, 2022

## 1 Certificate of Conformity

**Product:** Open-Q 610 uSOM  
**Brand:** Lantronix  
**Test Model:** Open-Q 610 uSOM  
**Sample Status:** Engineering Sample  
**Applicant:** Lantronix, Inc.  
**Test Date:** Sep. 03 ~ Oct. 21, 2021  
**Standards:** 47 CFR FCC Part 15, Subpart E (Section 15.407)  
ANSI C63.10:2013

The above equipment has been tested by **Bureau Veritas Consumer Products Services (H.K.) Ltd., Taoyuan Branch**, and found compliance with the requirement of the above standards. The test record, data evaluation & Equipment Under Test (EUT) configurations represented herein are true and accurate accounts of the measurements of the sample's RF characteristics under the conditions specified in this report.

Prepared by :  , Date: Jan. 10, 2022  
Lena Wang / Specialist

Approved by :  , Date: Jan. 10, 2022  
Jeremy Lin / Project Engineer

## 2 Summary of Test Results

47 CFR FCC Part 15, Subpart E (Section 15.407)			
FCC Clause	Test Item	Result	Remarks
15.407(b)(8)	AC Power Conducted Emissions	Pass	Meet the requirement of limit. Minimum passing margin is -25.27 dB at 0.39800 MHz.
15.407(b) (1/2/3/4(i/ii)/8)	Radiated Emissions & Band Edge Measurement	Pass	Meet the requirement of limit. Minimum passing margin is -0.2 dB at 11650.00 MHz.
15.407(a)(1/2/3)	Max Average Transmit Power	Pass	Meet the requirement of limit.
---	Occupied Bandwidth Measurement	-	Reference only
15.407(a)(1/2/3)	Peak Power Spectral Density	Pass	Meet the requirement of limit.
15.407(e)	6 dB Bandwidth	Pass	Meet the requirement of limit. (U-NII-3 Band only)
15.407(g)	Frequency Stability	Pass	Meet the requirement of limit.
15.203	Antenna Requirement	Pass	Antenna connector is U.FL.

Note:

- For U-NII-3 band compliance with rule part 15.407(b)(4)(i), the OOB test plots were recorded in Annex A.
- For U-NII-1, U-NII-2A, U-NII-2C band compliance with rule 15.407(b) of the band-edge items, the test plots were recorded in Annex B. Test Procedures refer to report 4.1.3.
- Determining compliance based on the results of the compliance measurement, not taking into account measurement instrumentation uncertainty.

### 2.1 Measurement Uncertainty

Where relevant, the following measurement uncertainty levels have been estimated for tests performed on the EUT as specified in CISPR 16-4-2:

Measurement	Frequency	Expanded Uncertainty (k=2) ( $\pm$ )
Conducted Emissions at mains ports	150 kHz ~ 30 MHz	2.79 dB
Radiated Emissions up to 1 GHz	9 kHz ~ 30 MHz	3.00 dB
	30 MHz ~ 200 MHz	2.91 dB
	200 MHz ~ 1000 MHz	2.93 dB
Radiated Emissions above 1 GHz	1 GHz ~ 18 GHz	1.76 dB
	18 GHz ~ 40 GHz	1.77 dB

### 2.2 Modification Record

There were no modifications required for compliance.

### 3 General Information

#### 3.1 General Description of EUT

<b>Product</b>	Open-Q 610 uSOM
<b>Brand</b>	Lantronix
<b>Test Model</b>	Open-Q 610 uSOM
<b>Status of EUT</b>	Engineering Sample
<b>Power Supply Rating</b>	12 Vdc (Adapter)
<b>Modulation Type</b>	256QAM, 64QAM, 16QAM, QPSK, BPSK
<b>Modulation Technology</b>	OFDM
<b>Transfer Rate</b>	802.11a: 54.0/ 48.0/ 36.0/ 24.0/ 18.0/ 12.0/ 9.0/ 6.0 Mbps 802.11n: up to 150 Mbps 802.11ac: up to 433.3 Mbps
<b>Operating Frequency</b>	5180 ~ 5240 MHz, 5260 ~ 5320 MHz, 5500 ~ 5720 MHz, 5745 ~ 5825 MHz
<b>Number of Channel</b>	5180 ~ 5240 MHz: 4 for 802.11a, 802.11n (HT20), 802.11ac (VHT20) 2 for 802.11n (HT40), 802.11ac (VHT40) 1 for 802.11ac (VHT80) 5260 ~ 5320 MHz: 4 for 802.11a, 802.11n (HT20), 802.11ac (VHT20) 2 for 802.11n (HT40), 802.11ac (VHT40) 1 for 802.11ac (VHT80) 5500 ~ 5720 MHz: 9 for 802.11a, 802.11n (HT20), 802.11ac (VHT20) 4 for 802.11n (HT40), 802.11ac (VHT40) 2 for 802.11ac (VHT80) 5745 ~ 5825 MHz: 5 for 802.11a, 802.11n (HT20), 802.11ac (VHT20) 2 for 802.11n (HT40), 802.11ac (VHT40) 1 for 802.11ac (VHT80)
<b>Output Power</b>	48.641 mW for 5180 ~ 5240 MHz 48.529 mW for 5260 ~ 5320 MHz 105.925 mW for 5500 ~ 5720 MHz 118.032 mW for 5745 ~ 5825 MHz
<b>Antenna Type</b>	Refer to Note as below
<b>Antenna Connector</b>	Refer to Note as below
<b>Accessory Device</b>	N/A
<b>Data Cable Supplied</b>	N/A

**Note:**

- The EUT incorporates a SISO function. Physically, the EUT provides one completed transmitter and one receiver.

Modulation Mode	Tx Function
802.11a	1TX
802.11n (HT20)	1TX
802.11n (HT40)	1TX
802.11ac (VHT20)	1TX
802.11ac (VHT40)	1TX
802.11ac (VHT80)	1TX

\* The modulation and bandwidth are similar for 802.11n mode for HT20 / HT40 and 802.11ac mode for VHT20 / VHT40, therefore investigated worst case to representative mode in test report. (Final test

mode refer section 3.2.1)

2. The following antennas were provided to the EUT.

<b>Ant. Type</b>	Flexible Dipole Antenna	
<b>Connector Type</b>	U.FL	
<b>Antenna Gain (dBi)</b>		
<b>2.4~2.5G</b>		<b>4.9~5.8G</b>
3.32		6.11

3. The above Antenna information is declared by manufacturer and for more detailed features description, please refer to the manufacturer's specifications, the laboratory shall not be held responsible.
4. The above EUT information is declared by manufacturer and for more detailed features description, please refers to the manufacturer's specifications or user's manual.
5. The BT could transmit simultaneously with WLAN 5GHz at the same time. The emission of the simultaneous operation has been evaluated and no non-compliance was found.



### 3.2 Description of Test Modes

#### For 5180 ~ 5240 MHz

4 channels are provided for 802.11a, 802.11n (HT20), 802.11ac (VHT20):

Channel	Frequency (MHz)	Channel	Frequency (MHz)
36	5180	44	5220
40	5200	48	5240

2 channels are provided for 802.11n (HT40), 802.11ac (VHT40):

Channel	Frequency (MHz)	Channel	Frequency (MHz)
38	5190	46	5230

1 channel is provided for 802.11ac (VHT80):

Channel	Frequency (MHz)
42	5210

#### For 5260 ~ 5320 MHz

4 channels are provided for 802.11a, 802.11n (HT20), 802.11ac (VHT20):

Channel	Frequency (MHz)	Channel	Frequency (MHz)
52	5260	60	5300
56	5280	64	5320

2 channels are provided for 802.11n (HT40), 802.11ac (VHT40):

Channel	Frequency (MHz)	Channel	Frequency (MHz)
54	5270	62	5310

1 channel is provided for 802.11ac (VHT80):

Channel	Frequency (MHz)
58	5290

### For 5500 ~ 5720 MHz

9 channels are provided for 802.11a, 802.11n (HT20), 802.11ac (VHT20):

Channel	Frequency (MHz)	Channel	Frequency (MHz)
100	5500	132	5660
104	5520	136	5680
108	5540	140	5700
112	5560	144	5720
116	5580		

4 channels are provided for 802.11n (HT40), 802.11ac (VHT40):

Channel	Frequency (MHz)	Channel	Frequency (MHz)
102	5510	134	5670
110	5550	142	5710

2 channels are provided for 802.11ac (VHT80):

Channel	Frequency (MHz)	Channel	Frequency (MHz)
106	5530	138	5690

### For 5745 ~ 5825 MHz:

5 channels are provided for 802.11a, 802.11n (HT20), 802.11ac (VHT20):

Channel	Frequency (MHz)	Channel	Frequency (MHz)
149	5745	161	5805
153	5765	165	5825
157	5785		

2 channels are provided for 802.11n (HT40), 802.11ac (VHT40):

Channel	Frequency (MHz)	Channel	Frequency (MHz)
151	5755	159	5795

1 channel is provided for 802.11ac (VHT80):

Channel	Frequency (MHz)
155	5775

### 3.2.1 Test Mode Applicability and Tested Channel Detail

EUT Configure Mode	Applicable To				Description
	RE $\geq$ 1G	RE $<$ 1G	PLC	APCM	
-	√	√	√	√	-

Where **RE $\geq$ 1G**: Radiated Emission above 1 GHz      **RE $<$ 1G**: Radiated Emission below 1 GHz  
**PLC**: Power Line Conducted Emission      **APCM**: Antenna Port Conducted Measurement

**Note:**

1. The EUT had been pre-tested on the positioned of each 3 axis. The worst case was found when positioned on **Z-plane**.
2. "-" means no effect.
3. Radiated emission test (below 1GHz) and power line conducted emission test items chosen the worst fundamental frequency emission level.

#### **Radiated Emission Test (Above 1 GHz):**

- Pre-Scan has been conducted to determine the worst-case mode from all possible combinations between available modulations, data rates and antenna ports (if EUT with antenna diversity architecture).
- Following channel(s) was (were) selected for the final test as listed below.

EUT Configure Mode	Frequency Band (MHz)	Mode	Available Channel	Tested Channel	Modulation Technology	Modulation Type	Data Rate (Mbps)
-	5180-5240	802.11a	36 to 48	36, 40, 48	OFDM	BPSK	6.0
-		802.11ac (VHT20)	36 to 48	36, 40, 48	OFDM	BPSK	7.2
-		802.11ac (VHT40)	38 to 46	38, 46	OFDM	BPSK	15
-		802.11ac (VHT80)	42	42	OFDM	BPSK	29.3
-	5260-5320	802.11a	52 to 64	52, 60, 64	OFDM	BPSK	6.0
-		802.11ac (VHT20)	52 to 64	52, 60, 64	OFDM	BPSK	7.2
-		802.11ac (VHT40)	54 to 62	54, 62	OFDM	BPSK	15
-		802.11ac (VHT80)	58	58	OFDM	BPSK	29.3
-	5500-5720	802.11a	100 to 144	100, 116, 140, 144	OFDM	BPSK	6.0
-		802.11ac (VHT20)	100 to 144	100, 116, 140, 144	OFDM	BPSK	7.2
-		802.11ac (VHT40)	102 to 142	102, 110, 134, 142	OFDM	BPSK	15
-		802.11ac (VHT80)	106 to 138	106, 138	OFDM	BPSK	29.3
-	5745-5825	802.11a	149 to 165	149, 157, 165	OFDM	BPSK	6.0
-		802.11ac (VHT20)	149 to 165	149, 157, 165	OFDM	BPSK	7.2
-		802.11ac (VHT40)	151 to 159	151, 159	OFDM	BPSK	15
-		802.11ac (VHT80)	155	155	OFDM	BPSK	29.3

#### **Radiated Emission Test (Below 1 GHz):**

- Pre-Scan has been conducted to determine the worst-case mode from all possible combinations between available modulations, data rates and antenna ports (if EUT with antenna diversity architecture).
- Following channel(s) was (were) selected for the final test as listed below.

EUT Configure Mode	Frequency Band (MHz)	Mode	Available Channel	Tested Channel	Modulation Technology	Modulation Type	Data Rate (Mbps)
-	5260-5320	802.11ac (VHT20)	52 to 64	64	OFDM	BPSK	7.2

**Power Line Conducted Emission Test:**

- Pre-Scan has been conducted to determine the worst-case mode from all possible combinations between available modulations, data rates and antenna ports (if EUT with antenna diversity architecture).
- Following channel(s) was (were) selected for the final test as listed below.

EUT Configure Mode	Frequency Band (MHz)	Mode	Available Channel	Tested Channel	Modulation Technology	Modulation Type	Data Rate (Mbps)
-	5260-5320	802.11ac (VHT20)	52 to 64	64	OFDM	BPSK	7.2

**Antenna Port Conducted Measurement:**

- This item includes all test value of each mode, but only includes spectrum plot of worst value of each mode.
- Pre-Scan has been conducted to determine the worst-case mode from all possible combinations between available modulations, data rates and antenna ports (if EUT with antenna diversity architecture).
- Following channel(s) was (were) selected for the final test as listed below.

EUT Configure Mode	Frequency Band (MHz)	Mode	Available Channel	Tested Channel	Modulation Technology	Modulation Type	Data Rate (Mbps)
-	5180-5240	802.11a	36 to 48	36, 40, 48	OFDM	BPSK	6.0
-		802.11ac (VHT20)	36 to 48	36, 40, 48	OFDM	BPSK	7.2
-		802.11ac (VHT40)	38 to 46	38, 46	OFDM	BPSK	15
-		802.11ac (VHT80)	42	42	OFDM	BPSK	29.3
-	5260-5320	802.11a	52 to 64	52, 60, 64	OFDM	BPSK	6.0
-		802.11ac (VHT20)	52 to 64	52, 60, 64	OFDM	BPSK	7.2
-		802.11ac (VHT40)	54 to 62	54, 62	OFDM	BPSK	15
-		802.11ac (VHT80)	58	58	OFDM	BPSK	29.3
-	5500-5720	802.11a	100 to 144	100, 116, 140, 144	OFDM	BPSK	6.0
-		802.11ac (VHT20)	100 to 144	100, 116, 140, 144	OFDM	BPSK	7.2
-		802.11ac (VHT40)	102 to 142	102, 110, 134, 142	OFDM	BPSK	15
-		802.11ac (VHT80)	106 to 138	106, 138	OFDM	BPSK	29.3
-	5745-5825	802.11a	149 to 165	149, 157, 165	OFDM	BPSK	6.0
-		802.11ac (VHT20)	149 to 165	149, 157, 165	OFDM	BPSK	7.2
-		802.11ac (VHT40)	151 to 159	151, 159	OFDM	BPSK	15
-		802.11ac (VHT80)	155	155	OFDM	BPSK	29.3

**Test Condition:**

Applicable To	Environmental Conditions	Input Power	Tested by
RE $\geq$ 1G	25 deg. C, 65 % RH	120 Vac, 60 Hz	Titan Hsu, Adair Peng
RE<1G	25 deg. C, 65 % RH	120 Vac, 60 Hz	Adair Peng
PLC	25 deg. C, 65 % RH	120 Vac, 60 Hz	Rex Wang
APCM	25 deg. C, 65 % RH	120 Vac, 60 Hz	Ivan Tseng

### 3.3 Duty Cycle of Test Signal

Duty cycle of test signal is < 98 %, duty factor is required.

**802.11a:** Duty cycle =  $2.021/2.064 = 0.979$ , Duty factor =  $10 * \log(1/0.979) = 0.09$

**802.11ac (VHT20):** Duty cycle =  $1.896/1.938 = 0.978$ , Duty factor =  $10 * \log(1/0.978) = 0.10$

**802.11ac (VHT40):** Duty cycle =  $0.935/0.974 = 0.96$ , Duty factor =  $10 * \log(1/0.96) = 0.18$

**802.11ac (VHT80):** Duty cycle =  $0.456/0.492 = 0.927$ , Duty factor =  $10 * \log(1/0.927) = 0.33$

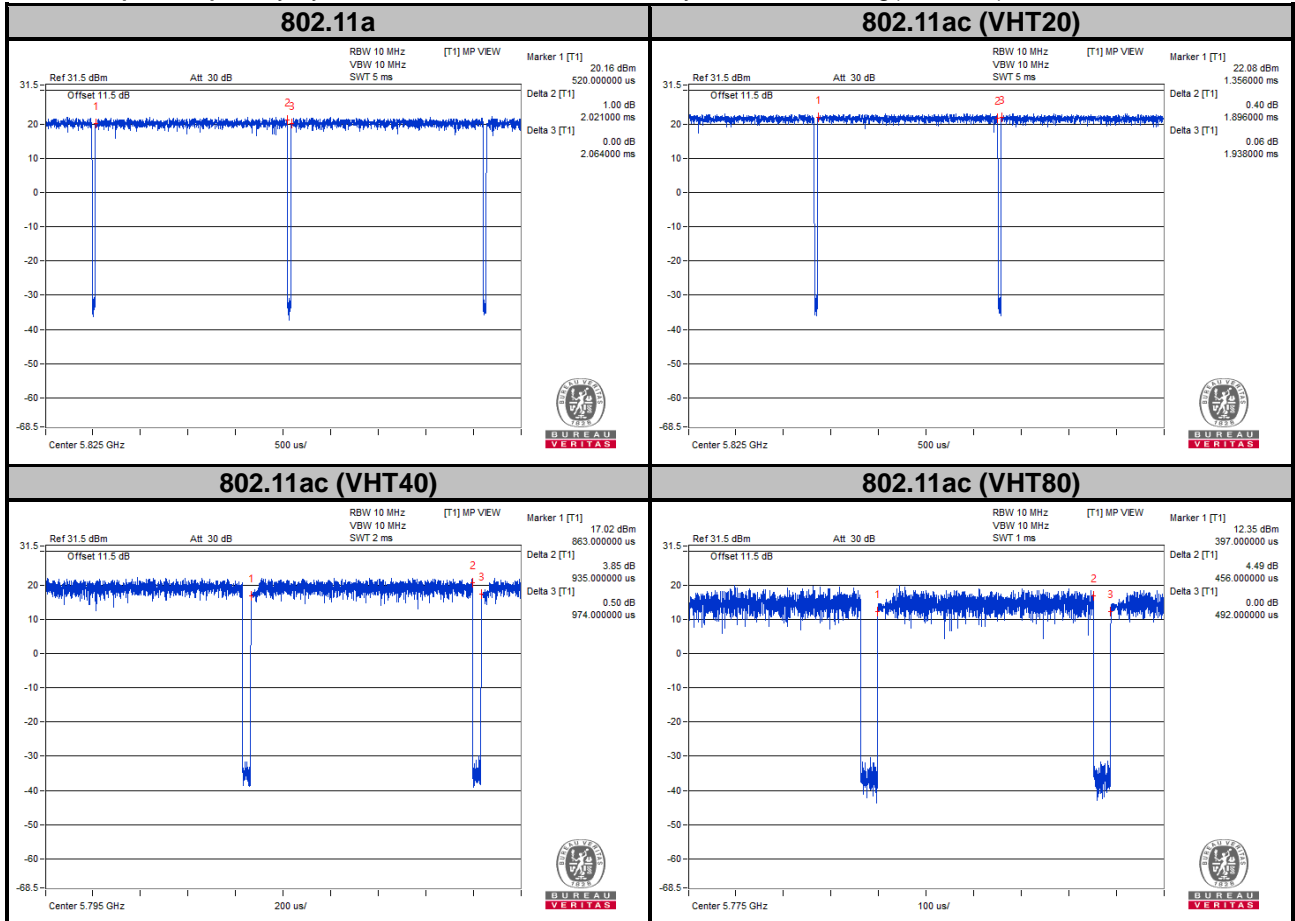

### 3.4 Description of Support Units

The EUT has been tested as an independent unit together with other necessary accessories or support units. The following support units or accessories were used to form a representative test configuration during the tests.

ID	Product	Brand	Model No.	Serial No.	FCC ID	Remarks
A	Notebook	Lenovo	20J4 MD A003TW	PF-11H9AK	N/A	-
B	Jig	N/A	N/A	N/A	N/A	Provided by client
C	Adapter	YINGHUIYUAN	YHY-12003000	N/A	N/A	Provided by client
D	Antenna	Taoglas	FXP.830.07.0100C	N/A	N/A	Provided by client

Note:

1. All power cords of the above support units are non-shielded (1.8m).
2. Item A acted as a communication partner to transfer data.

ID	Cable Descriptions	Qty.	Length (m)	Shielding (Yes/No)	Cores (Qty.)	Remarks
1.	Type C USB Cable	1	1	Y	0	Provided by client
2.	Adapter Cable	1	1.2	Y	1	Provided by client
3.	Power Cable	1	1.15	N	0	Provided by client

#### 3.4.1 Configuration of System under Test

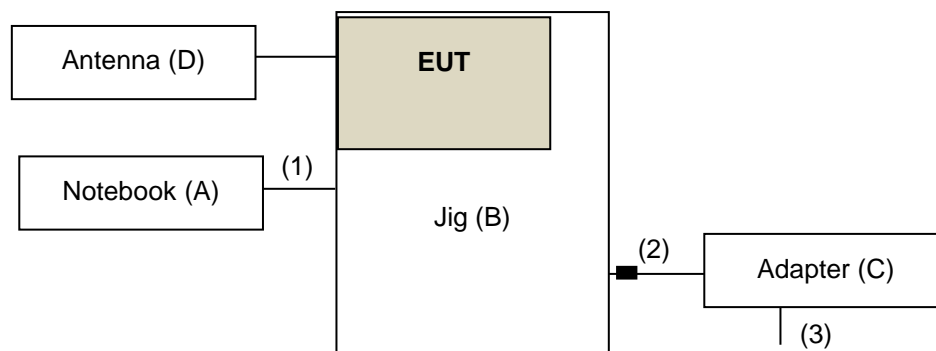

### 3.5 General Description of Applied Standards and References

The EUT is a RF Product. According to the specifications of the manufacturer, it must comply with the requirements of the following standards and references:

#### Test Standard:

#### FCC Part 15, Subpart E (15.407)

ANSI C63.10-2013

All test items have been performed and recorded as per the above standards.

#### References Test Guidance:

#### KDB 789033 D02 General UNII Test Procedures New Rules v02r01

All test items have been performed as a reference to the above KDB test guidance.

## 4 Test Types and Results

### 4.1 Radiated Emission and Bandedge Measurement

#### 4.1.1 Limits of Radiated Emission and Bandedge Measurement

Radiated emissions which fall in the restricted bands must comply with the radiated emission limits specified as below table.

Frequencies (MHz)	Field Strength (microvolts/meter)	Measurement Distance (meters)
0.009 ~ 0.490	2400/F (kHz)	300
0.490 ~ 1.705	24000/F (kHz)	30
1.705 ~ 30.0	30	30
30 ~ 88	100	3
88 ~ 216	150	3
216 ~ 960	200	3
Above 960	500	3

**Note:**

1. The lower limit shall apply at the transition frequencies.
2. Emission level (dBuV/m) = 20 log Emission level (uV/m).
3. For frequencies above 1000 MHz, the field strength limits are based on average detector, however, the peak field strength of any emission shall not exceed the maximum permitted average limits, specified above by more than 20 dB under any condition of modulation.

## Limits of Unwanted Emission Out of the Restricted Bands

Applicable To		Limit	
789033 D02 General UNII Test Procedures New Rules v02r01		Field Strength at 3 m	
		PK: 74 (dBµV/m)	AV: 54 (dBµV/m)
Frequency Band	Applicable To	EIRP Limit	Equivalent Field Strength at 3 m
5150~5250 MHz	15.407(b)(1)	PK: -27 (dBm/MHz)	PK: 68.2 (dBµV/m)
5250~5350 MHz	15.407(b)(2)		
5470~5725 MHz	15.407(b)(3)		
5725~5850 MHz	<input checked="" type="checkbox"/> 15.407(b)(4)(i)	PK:-27 (dBm/MHz) <sup>*1</sup> PK:10 (dBm/MHz) <sup>*2</sup> PK:15.6 (dBm/MHz) <sup>*3</sup> PK:27 (dBm/MHz) <sup>*4</sup>	PK: 68.2 (dBµV/m) <sup>*1</sup> PK:105.2 (dBµV/m) <sup>*2</sup> PK: 110.8 (dBµV/m) <sup>*3</sup> PK:122.2 (dBµV/m) <sup>*4</sup>
	<input type="checkbox"/> 15.407(b)(4)(ii)	Emission limits in section 15.247(d)	
<sup>*1</sup> beyond 75 MHz or more above of the band edge. <sup>*2</sup> below the band edge increasing linearly to 10 dBm/MHz at 25 MHz above. <sup>*3</sup> below the band edge increasing linearly to a level of 15.6 dBm/MHz at 5 MHz above. <sup>*4</sup> from 5 MHz above or below the band edge increasing linearly to a level of 27 dBm/MHz at the band edge.			

**Note:**

The following formula is used to convert the equipment isotropic radiated power (eirp) to field strength:

$$E = \frac{1000000\sqrt{30P}}{3} \mu\text{V/m, where } P \text{ is the eirp (Watts).}$$



#### 4.1.2 Test Instruments

Description & Manufacturer	Model No.	Serial No.	Date of Calibration	Due Date of Calibration
Test Receiver Rohde & Schwarz	N9038A	MY55420137	Apr. 09, 2021	Apr. 08, 2022
Spectrum Analyzer KEYSIGHT	N9020B	MY60110440	Dec. 18, 2020	Dec. 17, 2021
BILOG Antenna SCHWARZBECK	VULB9168	1213	Nov. 04, 2020	Nov. 03, 2021
HORN Antenna SCHWARZBECK	BBHA 9120 D	9120D-563	Nov. 22, 2020	Nov. 21, 2021
HORN Antenna SCHWARZBECK	BBHA 9170	995	Nov. 22, 2020	Nov. 21, 2021
Loop Antenna EMCI	EM-6879	269	Sep. 17, 2020	Sep. 16, 2021
			Sep. 16, 2021	Sep. 15, 2022
Loop Antenna TESEQ	HLA 6121	45745	Jul. 21, 2021	Jul. 20, 2022
Preamplifier EMCI	EMC330N	980782	Jan. 12, 2021	Jan. 11, 2022
Preamplifier EMCI	EMC118A45SE	980808	Jan. 12, 2021	Jan. 11, 2022
Preamplifier EMCI	EMC184045SE	980788	Jan. 12, 2021	Jan. 11, 2022
RF signal cable EMCI	EMC104-SM-SM- (9000+2000+1000)	201243+ 201231+ 210102	Jan. 12, 2021	Jan. 11, 2022
RF signal cable EMCI	EMCCFD400-NM- NM- (9000+300+500)	201236+ 201235+ 201233	Jan. 12, 2021	Jan. 11, 2022
RF signal cable EMCI	EMC101G-KM-KM- (5000+3000+2000)	201260+201257+2 01254	Jan. 12, 2021	Jan. 11, 2022
Software BV ADT	ADT_Radiated_V7. 6.15.9.5	NA	NA	NA
Antenna Tower Max-Full	MFT-151SS-0.5T	NA	NA	NA
Turn Table Max-Full	MF-7802BS	NA	NA	NA
Turn Table Controller Max-Full	MF-7802BS	MF780208674	NA	NA
USB Wideband Power Sensor KEYSIGHT	U2021XA	MY55050005/MY551 90004/MY55190007/ MY55210005	Jul. 12, 2021	Jul. 11, 2022

- Note: 1. The calibration interval of the above test instruments is 12 months and the calibrations are traceable to NML/ROC and NIST/USA.  
2. The test was performed in WM Chamber 8.

#### 4.1.3 Test Procedures

##### **For Radiated Emission below 30 MHz**

- a. The EUT was placed on the top of a rotating table 0.8 meters above the ground at a 3 meter chamber room. The table was rotated 360 degrees to determine the position of the highest radiation.
- b. The EUT was set 3 meters away from the interference-receiving antenna, which was mounted on the top of a variable-height antenna tower.
- c. Parallel, perpendicular, and ground-parallel orientations of the antenna are set to make the measurement.
- d. For each suspected emission, the EUT was arranged to its worst case and the rotatable table was turned from 0 degrees to 360 degrees to find the maximum reading.
- e. The test-receiver system was set to Quasi-Peak Detect Function and Specified Bandwidth with Maximum Hold Mode.

##### **Note:**

1. The resolution bandwidth and video bandwidth of test receiver/spectrum analyzer is 9 kHz at frequency below 30 MHz.

##### **For Radiated Emission above 30 MHz**

- a. The EUT was placed on the top of a rotating table 0.8 meters (for 30 MHz ~ 1 GHz) / 1.5 meters (for above 1 GHz) above the ground at 3 meter chamber room for test. The table was rotated 360 degrees to determine the position of the highest radiation.
- b. The EUT was set 3 meters away from the interference-receiving antenna, which was mounted on the top of a variable-height antenna tower.
- c. The height of antenna is varied from one meter to four meters above the ground to determine the maximum value of the field strength. Both horizontal and vertical polarizations of the antenna are set to make the measurement.
- d. For each suspected emission, the EUT was arranged to its worst case and then the antenna was tuned to heights from 1 meter to 4 meters and the rotatable table was turned from 0 degrees to 360 degrees to find the maximum reading.
- e. The test-receiver system was set to quasi-peak detect function and specified bandwidth with maximum hold mode when the test frequency is below 1 GHz.
- f. The test-receiver system was set to peak and average detected function and specified bandwidth with maximum hold mode when the test frequency is above 1 GHz. If the peak reading value also meets average limit, measurement with the average detector is unnecessary.

##### **Note:**

1. The resolution bandwidth and video bandwidth of test receiver/spectrum analyzer is 120 kHz for Quasi-peak detection (QP) or Peak detection (PK) at frequency below 1 GHz.
2. The resolution bandwidth of test receiver/spectrum analyzer is 1 MHz and the video bandwidth is 3 MHz for Peak detection (PK) at frequency above 1 GHz.
3. The resolution bandwidth of test receiver/spectrum analyzer is 1 MHz and the video bandwidth is  $\geq 1/T$  (Duty cycle < 98 %) or 10 Hz (Duty cycle  $\geq 98$  %) for Average detection (AV) at frequency above 1 GHz.  
(11a: RBW = 1 MHz, VBW = 1 kHz ; 11 ac (VHT20): RBW = 1 MHz, VBW = 1 kHz ;  
11 ac (VHT40): RBW = 1 MHz, VBW = 3 kHz ; 11ac (VHT80): RBW = 1 MHz, VBW = 3 kHz)
4. All modes of operation were investigated and the worst-case emissions are reported.

#### 4.1.4 Deviation from Test Standard

No deviation.

4.1.5 Test Setup

<Radiated Emission below 30 MHz>

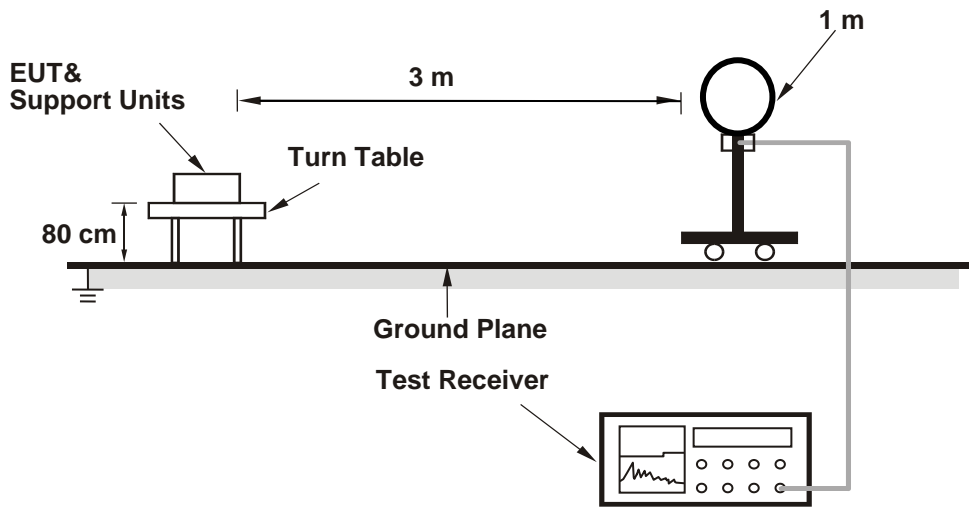

<Radiated Emission 30 MHz to 1 GHz>

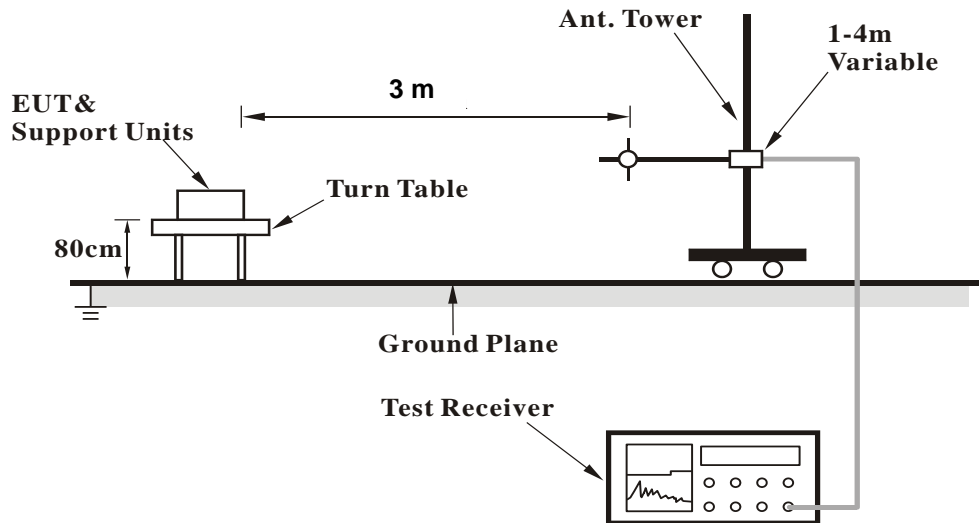

### <Radiated Emission above 1 GHz>

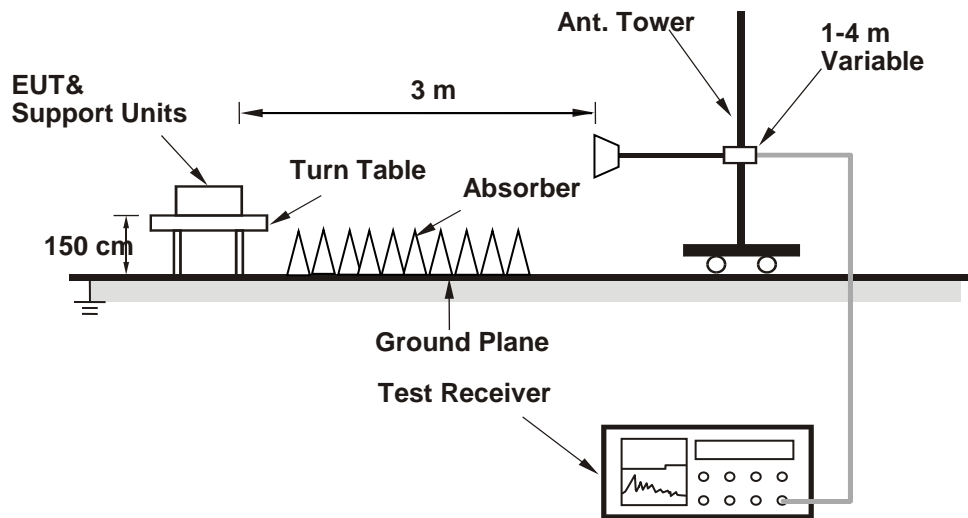

For the actual test configuration, please refer to the attached file (Test Setup Photo).

#### 4.1.6 EUT Operating Conditions

- Placed the EUT on a testing table.
- Use the software to control the EUT under transmission condition continuously at specific channel frequency.

#### 4.1.7 Test Results

#### Above 1 GHz Data :

#### 802.11a

<b>RF Mode</b>	TX 802.11a	<b>Channel</b>	CH 36 : 5180 MHz
<b>Frequency Range</b>	1GHz ~ 40GHz	<b>Detector Function</b>	Peak (PK) Average (AV)

#### Antenna Polarity & Test Distance : Horizontal at 3 m

No	Frequency (MHz)	Emission Level (dBuV/m)	Limit (dBuV/m)	Margin (dB)	Antenna Height (m)	Table Angle (Degree)	Raw Value (dBuV)	Correction Factor (dB/m)
1	5150.00	61.5 PK	74.0	-12.5	2.35 H	311	59.7	1.8
2	5150.00	47.9 AV	54.0	-6.1	2.35 H	311	46.1	1.8
3	*5180.00	106.3 PK			2.35 H	311	66.3	40.0
4	*5180.00	96.9 AV			2.35 H	311	56.9	40.0
5	#10360.00	57.9 PK	68.2	-10.3	2.25 H	160	49.7	8.2

#### Antenna Polarity & Test Distance : Vertical at 3 m

No	Frequency (MHz)	Emission Level (dBuV/m)	Limit (dBuV/m)	Margin (dB)	Antenna Height (m)	Table Angle (Degree)	Raw Value (dBuV)	Correction Factor (dB/m)
1	5150.00	67.2 PK	74.0	-6.8	2.12 V	297	65.4	1.8
2	5150.00	53.4 AV	54.0	-0.6	2.12 V	297	51.6	1.8
3	*5180.00	115.1 PK			2.12 V	297	75.1	40.0
4	*5180.00	105.3 AV			2.12 V	297	65.3	40.0
5	#10360.00	63.3 PK	68.2	-4.9	2.66 V	270	55.1	8.2

#### Remarks:

1. Emission Level(dBuV/m) = Raw Value(dBuV) + Correction Factor(dB/m)
2. Correction Factor(dB/m) = Antenna Factor(dB/m) + Cable Factor(dB) – Pre-Amplifier Factor(dB)
3. Margin value = Emission Level – Limit value
4. The other emission levels were very low against the limit.
5. " \* " : Fundamental frequency.
6. " # " : The radiated frequency is out of the restricted band.

<b>RF Mode</b>	TX 802.11a	<b>Channel</b>	CH 40 : 5200 MHz
<b>Frequency Range</b>	1GHz ~ 40GHz	<b>Detector Function</b>	Peak (PK) Average (AV)

**Antenna Polarity & Test Distance : Horizontal at 3 m**

No	Frequency (MHz)	Emission Level (dBuV/m)	Limit (dBuV/m)	Margin (dB)	Antenna Height (m)	Table Angle (Degree)	Raw Value (dBuV)	Correction Factor (dB/m)
1	5150.00	61.5 PK	74.0	-12.5	2.18 H	309	59.7	1.8
2	5150.00	47.2 AV	54.0	-6.8	2.18 H	309	45.4	1.8
3	*5200.00	108.6 PK			2.18 H	309	68.6	40.0
4	*5200.00	99.0 AV			2.18 H	309	59.0	40.0
5	#10400.00	59.3 PK	68.2	-8.9	2.28 H	155	51.2	8.1

**Antenna Polarity & Test Distance : Vertical at 3 m**

No	Frequency (MHz)	Emission Level (dBuV/m)	Limit (dBuV/m)	Margin (dB)	Antenna Height (m)	Table Angle (Degree)	Raw Value (dBuV)	Correction Factor (dB/m)
1	5150.00	69.4 PK	74.0	-4.6	2.14 V	297	67.6	1.8
2	5150.00	53.5 AV	54.0	-0.5	2.14 V	297	51.7	1.8
3	*5200.00	116.9 PK			2.14 V	297	76.9	40.0
4	*5200.00	106.8 AV			2.14 V	297	66.8	40.0
5	#10400.00	65.3 PK	68.2	-2.9	2.65 V	272	57.2	8.1

**Remarks:**

1. Emission Level(dBuV/m) = Raw Value(dBuV) + Correction Factor(dB/m)
2. Correction Factor(dB/m) = Antenna Factor(dB/m) + Cable Factor(dB) – Pre-Amplifier Factor(dB)
3. Margin value = Emission Level – Limit value
4. The other emission levels were very low against the limit.
5. " \* ": Fundamental frequency.
6. " # ": The radiated frequency is out of the restricted band.

<b>RF Mode</b>	TX 802.11a	<b>Channel</b>	CH 48 : 5240 MHz
<b>Frequency Range</b>	1GHz ~ 40GHz	<b>Detector Function</b>	Peak (PK) Average (AV)

**Antenna Polarity & Test Distance : Horizontal at 3 m**

No	Frequency (MHz)	Emission Level (dBuV/m)	Limit (dBuV/m)	Margin (dB)	Antenna Height (m)	Table Angle (Degree)	Raw Value (dBuV)	Correction Factor (dB/m)
1	5150.00	57.3 PK	74.0	-16.7	2.14 H	310	55.5	1.8
2	5150.00	44.4 AV	54.0	-9.6	2.14 H	310	42.6	1.8
3	*5240.00	109.2 PK			2.14 H	310	69.2	40.0
4	*5240.00	99.8 AV			2.14 H	310	59.8	40.0
5	#10480.00	60.0 PK	68.2	-8.2	2.30 H	159	51.9	8.1

**Antenna Polarity & Test Distance : Vertical at 3 m**

No	Frequency (MHz)	Emission Level (dBuV/m)	Limit (dBuV/m)	Margin (dB)	Antenna Height (m)	Table Angle (Degree)	Raw Value (dBuV)	Correction Factor (dB/m)
1	5150.00	58.2 PK	74.0	-15.8	2.17 V	301	56.4	1.8
2	5150.00	45.2 AV	54.0	-8.8	2.17 V	301	43.4	1.8
3	*5240.00	118.1 PK			2.17 V	301	78.1	40.0
4	*5240.00	108.2 AV			2.17 V	301	68.2	40.0
5	#10480.00	63.7 PK	68.2	-4.5	2.74 V	269	55.6	8.1

**Remarks:**

1. Emission Level(dBuV/m) = Raw Value(dBuV) + Correction Factor(dB/m)
2. Correction Factor(dB/m) = Antenna Factor(dB/m) + Cable Factor(dB) – Pre-Amplifier Factor(dB)
3. Margin value = Emission Level – Limit value
4. The other emission levels were very low against the limit.
5. " \* " : Fundamental frequency.
6. " # " : The radiated frequency is out of the restricted band.

<b>RF Mode</b>	TX 802.11a	<b>Channel</b>	CH 52 : 5260 MHz
<b>Frequency Range</b>	1GHz ~ 40GHz	<b>Detector Function</b>	Peak (PK) Average (AV)

**Antenna Polarity & Test Distance : Horizontal at 3 m**

No	Frequency (MHz)	Emission Level (dBuV/m)	Limit (dBuV/m)	Margin (dB)	Antenna Height (m)	Table Angle (Degree)	Raw Value (dBuV)	Correction Factor (dB/m)
1	5150.00	57.5 PK	74.0	-16.5	1.00 H	313	55.7	1.8
2	5150.00	44.5 AV	54.0	-9.5	1.00 H	313	42.7	1.8
3	*5260.00	111.5 PK			1.00 H	313	71.6	39.9
4	*5260.00	101.9 AV			1.00 H	313	62.0	39.9
5	#10520.00	61.2 PK	68.2	-7.0	2.50 H	201	53.0	8.2

**Antenna Polarity & Test Distance : Vertical at 3 m**

No	Frequency (MHz)	Emission Level (dBuV/m)	Limit (dBuV/m)	Margin (dB)	Antenna Height (m)	Table Angle (Degree)	Raw Value (dBuV)	Correction Factor (dB/m)
1	5150.00	57.2 PK	74.0	-16.8	2.97 V	290	55.4	1.8
2	5150.00	44.6 AV	54.0	-9.4	2.97 V	290	42.8	1.8
3	*5260.00	119.3 PK			2.97 V	290	79.4	39.9
4	*5260.00	109.6 AV			2.97 V	290	69.7	39.9
5	#10520.00	64.0 PK	74.0	-10.0	2.37 V	276	55.8	8.2

**Remarks:**

1. Emission Level(dBuV/m) = Raw Value(dBuV) + Correction Factor(dB/m)
2. Correction Factor(dB/m) = Antenna Factor(dB/m) + Cable Factor(dB) – Pre-Amplifier Factor(dB)
3. Margin value = Emission Level – Limit value
4. The other emission levels were very low against the limit.
5. " \* " : Fundamental frequency.
6. " # " : The radiated frequency is out of the restricted band.



<b>RF Mode</b>	TX 802.11a	<b>Channel</b>	CH 60 : 5300 MHz
<b>Frequency Range</b>	1GHz ~ 40GHz	<b>Detector Function</b>	Peak (PK) Average (AV)

**Antenna Polarity & Test Distance : Horizontal at 3 m**

No	Frequency (MHz)	Emission Level (dBuV/m)	Limit (dBuV/m)	Margin (dB)	Antenna Height (m)	Table Angle (Degree)	Raw Value (dBuV)	Correction Factor (dB/m)
1	*5300.00	112.0 PK			1.04 H	312	72.0	40.0
2	*5300.00	101.1 AV			1.04 H	312	61.1	40.0
3	5350.00	61.6 PK	74.0	-12.4	1.04 H	312	59.8	1.8
4	5350.00	47.5 AV	54.0	-6.5	1.04 H	312	45.7	1.8
5	10600.00	60.3 PK	74.0	-13.7	2.42 H	198	52.2	8.1
6	10600.00	47.4 AV	54.0	-6.6	2.42 H	198	39.3	8.1

**Antenna Polarity & Test Distance : Vertical at 3 m**

No	Frequency (MHz)	Emission Level (dBuV/m)	Limit (dBuV/m)	Margin (dB)	Antenna Height (m)	Table Angle (Degree)	Raw Value (dBuV)	Correction Factor (dB/m)
1	*5300.00	118.6 PK			2.92 V	290	78.6	40.0
2	*5300.00	109.0 AV			2.92 V	290	69.0	40.0
3	5350.00	67.4 PK	74.0	-6.6	2.92 V	290	65.6	1.8
4	5350.00	53.0 AV	54.0	-1.0	2.92 V	290	51.2	1.8
5	10600.00	62.1 PK	74.0	-11.9	2.32 V	277	54.0	8.1
6	10600.00	48.8 AV	54.0	-5.2	2.32 V	277	40.7	8.1

**Remarks:**

1. Emission Level(dBuV/m) = Raw Value(dBuV) + Correction Factor(dB/m)
2. Correction Factor(dB/m) = Antenna Factor(dB/m) + Cable Factor(dB) – Pre-Amplifier Factor(dB)
3. Margin value = Emission Level – Limit value
4. The other emission levels were very low against the limit.
5. " \* ": Fundamental frequency.

<b>RF Mode</b>	TX 802.11a	<b>Channel</b>	CH 64 : 5320 MHz
<b>Frequency Range</b>	1GHz ~ 40GHz	<b>Detector Function</b>	Peak (PK) Average (AV)

**Antenna Polarity & Test Distance : Horizontal at 3 m**

No	Frequency (MHz)	Emission Level (dBuV/m)	Limit (dBuV/m)	Margin (dB)	Antenna Height (m)	Table Angle (Degree)	Raw Value (dBuV)	Correction Factor (dB/m)
1	*5320.00	109.6 PK			1.07 H	311	69.6	40.0
2	*5320.00	100.1 AV			1.07 H	311	60.1	40.0
3	5350.00	60.9 PK	74.0	-13.1	1.07 H	311	59.1	1.8
4	5350.00	47.8 AV	54.0	-6.2	1.07 H	311	46.0	1.8
5	10640.00	58.1 PK	74.0	-15.9	2.38 H	195	50.0	8.1
6	10640.00	44.6 AV	54.0	-9.4	2.38 H	195	36.5	8.1

**Antenna Polarity & Test Distance : Vertical at 3 m**

No	Frequency (MHz)	Emission Level (dBuV/m)	Limit (dBuV/m)	Margin (dB)	Antenna Height (m)	Table Angle (Degree)	Raw Value (dBuV)	Correction Factor (dB/m)
1	*5320.00	116.7 PK			2.86 V	290	76.7	40.0
2	*5320.00	107.1 AV			2.86 V	290	67.1	40.0
3	5350.00	66.8 PK	74.0	-7.2	2.86 V	290	65.0	1.8
4	5350.00	53.1 AV	54.0	-0.9	2.86 V	290	51.3	1.8
5	10640.00	59.7 PK	74.0	-14.3	2.80 V	271	51.6	8.1
6	10640.00	46.1 AV	54.0	-7.9	2.80 V	271	38.0	8.1

**Remarks:**

1. Emission Level(dBuV/m) = Raw Value(dBuV) + Correction Factor(dB/m)
2. Correction Factor(dB/m) = Antenna Factor(dB/m) + Cable Factor(dB) – Pre-Amplifier Factor(dB)
3. Margin value = Emission Level – Limit value
4. The other emission levels were very low against the limit.
5. " \* " : Fundamental frequency.

<b>RF Mode</b>	TX 802.11a	<b>Channel</b>	CH 100 : 5500 MHz
<b>Frequency Range</b>	1GHz ~ 40GHz	<b>Detector Function</b>	Peak (PK) Average (AV)

Antenna Polarity & Test Distance : Horizontal at 3 m								
No	Frequency (MHz)	Emission Level (dBuV/m)	Limit (dBuV/m)	Margin (dB)	Antenna Height (m)	Table Angle (Degree)	Raw Value (dBuV)	Correction Factor (dB/m)
1	5460.00	60.3 PK	74.0	-13.7	3.16 H	207	58.2	2.1
2	5460.00	44.8 AV	54.0	-9.2	3.16 H	207	42.7	2.1
3	#5470.00	62.1 PK	68.2	-6.1	3.16 H	207	60.0	2.1
4	*5500.00	103.9 PK			3.16 H	207	63.6	40.3
5	*5500.00	94.7 AV			3.16 H	207	54.4	40.3
6	11000.00	58.7 PK	74.0	-15.3	2.30 H	200	50.5	8.2
7	11000.00	46.4 AV	54.0	-7.6	2.30 H	200	38.2	8.2
Antenna Polarity & Test Distance : Vertical at 3 m								
No	Frequency (MHz)	Emission Level (dBuV/m)	Limit (dBuV/m)	Margin (dB)	Antenna Height (m)	Table Angle (Degree)	Raw Value (dBuV)	Correction Factor (dB/m)
1	5460.00	66.9 PK	74.0	-7.1	2.34 V	295	64.8	2.1
2	5460.00	47.6 AV	54.0	-6.4	2.34 V	295	45.5	2.1
3	#5470.00	67.6 PK	68.2	-0.6	2.34 V	295	65.5	2.1
4	*5500.00	111.7 PK			2.34 V	295	71.4	40.3
5	*5500.00	101.9 AV			2.34 V	295	61.6	40.3
6	11000.00	65.5 PK	74.0	-8.5	3.10 V	264	57.3	8.2
7	11000.00	52.3 AV	54.0	-1.7	3.10 V	264	44.1	8.2

**Remarks:**

1. Emission Level(dBuV/m) = Raw Value(dBuV) + Correction Factor(dB/m)
2. Correction Factor(dB/m) = Antenna Factor(dB/m) + Cable Factor(dB) – Pre-Amplifier Factor(dB)
3. Margin value = Emission Level – Limit value
4. The other emission levels were very low against the limit.
5. " \* ": Fundamental frequency.
6. " # ": The radiated frequency is out of the restricted band.

<b>RF Mode</b>	TX 802.11a	<b>Channel</b>	CH 116 : 5580 MHz
<b>Frequency Range</b>	1GHz ~ 40GHz	<b>Detector Function</b>	Peak (PK) Average (AV)

Antenna Polarity & Test Distance : Horizontal at 3 m								
No	Frequency (MHz)	Emission Level (dBuV/m)	Limit (dBuV/m)	Margin (dB)	Antenna Height (m)	Table Angle (Degree)	Raw Value (dBuV)	Correction Factor (dB/m)
1	*5580.00	104.5 PK			1.08 H	310	63.8	40.7
2	*5580.00	95.1 AV			1.08 H	310	54.4	40.7
3	11160.00	61.4 PK	74.0	-12.6	2.28 H	206	53.2	8.2
4	11160.00	48.4 AV	54.0	-5.6	2.28 H	206	40.2	8.2
Antenna Polarity & Test Distance : Vertical at 3 m								
No	Frequency (MHz)	Emission Level (dBuV/m)	Limit (dBuV/m)	Margin (dB)	Antenna Height (m)	Table Angle (Degree)	Raw Value (dBuV)	Correction Factor (dB/m)
1	*5580.00	113.8 PK			2.27 V	296	73.1	40.7
2	*5580.00	104.2 AV			2.27 V	296	63.5	40.7
3	11160.00	67.3 PK	74.0	-6.7	2.26 V	258	59.1	8.2
4	11160.00	53.3 AV	54.0	-0.7	2.26 V	258	45.1	8.2

**Remarks:**

1. Emission Level(dBuV/m) = Raw Value(dBuV) + Correction Factor(dB/m)
2. Correction Factor(dB/m) = Antenna Factor(dB/m) + Cable Factor(dB) – Pre-Amplifier Factor(dB)
3. Margin value = Emission Level – Limit value
4. The other emission levels were very low against the limit.
5. " \* ": Fundamental frequency.

<b>RF Mode</b>	TX 802.11a	<b>Channel</b>	CH 140 : 5700 MHz
<b>Frequency Range</b>	1GHz ~ 40GHz	<b>Detector Function</b>	Peak (PK) Average (AV)

**Antenna Polarity & Test Distance : Horizontal at 3 m**

No	Frequency (MHz)	Emission Level (dBuV/m)	Limit (dBuV/m)	Margin (dB)	Antenna Height (m)	Table Angle (Degree)	Raw Value (dBuV)	Correction Factor (dB/m)
1	*5700.00	104.6 PK			1.03 H	310	63.3	41.3
2	*5700.00	95.3 AV			1.03 H	310	54.0	41.3
3	#5725.00	60.4 PK	68.2	-7.8	1.03 H	310	57.1	3.3
4	11400.00	60.0 PK	74.0	-14.0	2.21 H	208	51.2	8.8
5	11400.00	46.6 AV	54.0	-7.4	2.21 H	208	37.8	8.8

**Antenna Polarity & Test Distance : Vertical at 3 m**

No	Frequency (MHz)	Emission Level (dBuV/m)	Limit (dBuV/m)	Margin (dB)	Antenna Height (m)	Table Angle (Degree)	Raw Value (dBuV)	Correction Factor (dB/m)
1	*5700.00	114.3 PK			2.27 V	294	73.0	41.3
2	*5700.00	104.8 AV			2.27 V	294	63.5	41.3
3	#5725.00	67.3 PK	68.2	-0.9	2.27 V	294	64.0	3.3
4	11400.00	65.0 PK	74.0	-9.0	2.30 V	260	56.2	8.8
5	11400.00	50.6 AV	54.0	-3.4	2.30 V	260	41.8	8.8

**Remarks:**

1. Emission Level(dBuV/m) = Raw Value(dBuV) + Correction Factor(dB/m)
2. Correction Factor(dB/m) = Antenna Factor(dB/m) + Cable Factor(dB) – Pre-Amplifier Factor(dB)
3. Margin value = Emission Level – Limit value
4. The other emission levels were very low against the limit.
5. " \* " : Fundamental frequency.
6. " # " : The radiated frequency is out of the restricted band.

<b>RF Mode</b>	TX 802.11a	<b>Channel</b>	CH 144 : 5720 MHz
<b>Frequency Range</b>	1GHz ~ 40GHz	<b>Detector Function</b>	Peak (PK) Average (AV)

**Antenna Polarity & Test Distance : Horizontal at 3 m**

No	Frequency (MHz)	Emission Level (dBuV/m)	Limit (dBuV/m)	Margin (dB)	Antenna Height (m)	Table Angle (Degree)	Raw Value (dBuV)	Correction Factor (dB/m)
1	#5470.00	59.1 PK	68.2	-9.1	1.03 H	308	57.0	2.1
2	*5720.00	104.5 PK			1.03 H	308	63.2	41.3
3	*5720.00	95.1 AV			1.03 H	308	53.8	41.3
4	#5850.00	59.7 PK	68.2	-8.5	1.03 H	308	56.1	3.6
5	11440.00	59.7 PK	74.0	-14.3	2.23 H	206	50.9	8.8
6	11440.00	45.8 AV	54.0	-8.2	2.23 H	206	37.0	8.8

**Antenna Polarity & Test Distance : Vertical at 3 m**

No	Frequency (MHz)	Emission Level (dBuV/m)	Limit (dBuV/m)	Margin (dB)	Antenna Height (m)	Table Angle (Degree)	Raw Value (dBuV)	Correction Factor (dB/m)
1	#5470.00	58.1 PK	68.2	-10.1	2.17 V	288	56.0	2.1
2	*5720.00	116.0 PK			2.17 V	288	74.7	41.3
3	*5720.00	106.7 AV			2.17 V	288	65.4	41.3
4	#5850.00	59.8 PK	68.2	-8.4	2.17 V	288	56.2	3.6
5	11440.00	67.2 PK	74.0	-6.8	2.19 V	254	58.4	8.8
6	11440.00	53.3 AV	54.0	-0.7	2.19 V	254	44.5	8.8

**Remarks:**

1. Emission Level(dBuV/m) = Raw Value(dBuV) + Correction Factor(dB/m)
2. Correction Factor(dB/m) = Antenna Factor(dB/m) + Cable Factor(dB) – Pre-Amplifier Factor(dB)
3. Margin value = Emission Level – Limit value
4. The other emission levels were very low against the limit.
5. " \* " : Fundamental frequency.
6. " # " : The radiated frequency is out of the restricted band.

<b>RF Mode</b>	TX 802.11a	<b>Channel</b>	CH 149 : 5745 MHz
<b>Frequency Range</b>	1GHz ~ 40GHz	<b>Detector Function</b>	Peak (PK) Average (AV)

**Antenna Polarity & Test Distance : Horizontal at 3 m**

No	Frequency (MHz)	Emission Level (dBuV/m)	Limit (dBuV/m)	Margin (dB)	Antenna Height (m)	Table Angle (Degree)	Raw Value (dBuV)	Correction Factor (dB/m)
1	#5641.60	58.1 PK	68.2	-10.1	1.02 H	309	55.2	2.9
2	*5745.00	104.6 PK			1.02 H	309	63.2	41.4
3	*5745.00	95.1 AV			1.02 H	309	53.7	41.4
4	#5958.00	59.4 PK	68.2	-8.8	1.02 H	309	55.7	3.7
5	11490.00	61.1 PK	74.0	-12.9	2.73 H	199	52.4	8.7
6	11490.00	47.4 AV	54.0	-6.6	2.73 H	199	38.7	8.7

**Antenna Polarity & Test Distance : Vertical at 3 m**

No	Frequency (MHz)	Emission Level (dBuV/m)	Limit (dBuV/m)	Margin (dB)	Antenna Height (m)	Table Angle (Degree)	Raw Value (dBuV)	Correction Factor (dB/m)
1	#5603.60	57.9 PK	68.2	-10.3	2.32 V	288	55.2	2.7
2	*5745.00	115.4 PK			2.32 V	288	74.0	41.4
3	*5745.00	105.7 AV			2.32 V	288	64.3	41.4
4	#5925.20	59.0 PK	68.2	-9.2	2.32 V	288	55.3	3.7
5	11490.00	67.1 PK	74.0	-6.9	3.90 V	273	58.4	8.7
6	11490.00	53.0 AV	54.0	-1.0	3.90 V	273	44.3	8.7

**Remarks:**

1. Emission Level(dBuV/m) = Raw Value(dBuV) + Correction Factor(dB/m)
2. Correction Factor(dB/m) = Antenna Factor(dB/m) + Cable Factor(dB) – Pre-Amplifier Factor(dB)
3. Margin value = Emission Level – Limit value
4. The other emission levels were very low against the limit.
5. " \* ": Fundamental frequency.
6. " # ": The radiated frequency is out of the restricted band.

<b>RF Mode</b>	TX 802.11a	<b>Channel</b>	CH 157 : 5785 MHz
<b>Frequency Range</b>	1GHz ~ 40GHz	<b>Detector Function</b>	Peak (PK) Average (AV)

Antenna Polarity & Test Distance : Horizontal at 3 m								
No	Frequency (MHz)	Emission Level (dBuV/m)	Limit (dBuV/m)	Margin (dB)	Antenna Height (m)	Table Angle (Degree)	Raw Value (dBuV)	Correction Factor (dB/m)
1	#5631.20	58.0 PK	68.2	-10.2	1.04 H	308	55.1	2.9
2	*5785.00	105.0 PK			1.04 H	308	63.5	41.5
3	*5785.00	95.3 AV			1.04 H	308	53.8	41.5
4	#5985.60	58.7 PK	68.2	-9.5	1.04 H	308	54.9	3.8
5	11570.00	61.9 PK	74.0	-12.1	2.77 H	202	53.3	8.6
6	11570.00	48.7 AV	54.0	-5.3	2.77 H	202	40.1	8.6
Antenna Polarity & Test Distance : Vertical at 3 m								
No	Frequency (MHz)	Emission Level (dBuV/m)	Limit (dBuV/m)	Margin (dB)	Antenna Height (m)	Table Angle (Degree)	Raw Value (dBuV)	Correction Factor (dB/m)
1	#5631.20	58.2 PK	68.2	-10.0	2.26 V	288	55.3	2.9
2	*5785.00	116.3 PK			2.26 V	288	74.8	41.5
3	*5785.00	106.7 AV			2.26 V	288	65.2	41.5
4	#5934.00	59.2 PK	68.2	-9.0	2.26 V	288	55.5	3.7
5	11570.00	67.8 PK	74.0	-6.2	3.93 V	265	59.2	8.6
6	11570.00	53.7 AV	54.0	-0.3	3.93 V	265	45.1	8.6

**Remarks:**

1. Emission Level(dBuV/m) = Raw Value(dBuV) + Correction Factor(dB/m)
2. Correction Factor(dB/m) = Antenna Factor(dB/m) + Cable Factor(dB) – Pre-Amplifier Factor(dB)
3. Margin value = Emission Level – Limit value
4. The other emission levels were very low against the limit.
5. " \* " : Fundamental frequency.
6. " # " : The radiated frequency is out of the restricted band.



<b>RF Mode</b>	TX 802.11a	<b>Channel</b>	CH 165 : 5825 MHz
<b>Frequency Range</b>	1GHz ~ 40GHz	<b>Detector Function</b>	Peak (PK) Average (AV)

**Antenna Polarity & Test Distance : Horizontal at 3 m**

No	Frequency (MHz)	Emission Level (dBuV/m)	Limit (dBuV/m)	Margin (dB)	Antenna Height (m)	Table Angle (Degree)	Raw Value (dBuV)	Correction Factor (dB/m)
1	#5623.60	58.4 PK	68.2	-9.8	1.08 H	307	55.6	2.8
2	*5825.00	104.7 PK			1.08 H	307	63.1	41.6
3	*5825.00	95.3 AV			1.08 H	307	53.7	41.6
4	#5990.40	58.2 PK	68.2	-10.0	1.08 H	307	54.4	3.8
5	11650.00	62.1 PK	74.0	-11.9	2.71 H	198	53.4	8.7
6	11650.00	48.8 AV	54.0	-5.2	2.71 H	198	40.1	8.7

**Antenna Polarity & Test Distance : Vertical at 3 m**

No	Frequency (MHz)	Emission Level (dBuV/m)	Limit (dBuV/m)	Margin (dB)	Antenna Height (m)	Table Angle (Degree)	Raw Value (dBuV)	Correction Factor (dB/m)
1	#5614.40	58.2 PK	68.2	-10.0	2.26 V	288	55.4	2.8
2	*5825.00	116.0 PK			2.26 V	288	74.4	41.6
3	*5825.00	106.4 AV			2.26 V	288	64.8	41.6
4	#5958.40	58.9 PK	68.2	-9.3	2.26 V	288	55.2	3.7
5	11650.00	68.1 PK	74.0	-5.9	3.76 V	264	59.4	8.7
6	11650.00	53.8 AV	54.0	-0.2	3.76 V	264	45.1	8.7

**Remarks:**

1. Emission Level(dBuV/m) = Raw Value(dBuV) + Correction Factor(dB/m)
2. Correction Factor(dB/m) = Antenna Factor(dB/m) + Cable Factor(dB) – Pre-Amplifier Factor(dB)
3. Margin value = Emission Level – Limit value
4. The other emission levels were very low against the limit.
5. " \* " : Fundamental frequency.
6. " # " : The radiated frequency is out of the restricted band.

**802.11ac (VHT20)**

<b>RF Mode</b>	TX 802.11ac (VHT20)	<b>Channel</b>	CH 36 : 5180 MHz
<b>Frequency Range</b>	1GHz ~ 40GHz	<b>Detector Function</b>	Peak (PK) Average (AV)

**Antenna Polarity & Test Distance : Horizontal at 3 m**

No	Frequency (MHz)	Emission Level (dBuV/m)	Limit (dBuV/m)	Margin (dB)	Antenna Height (m)	Table Angle (Degree)	Raw Value (dBuV)	Correction Factor (dB/m)
1	5150.00	63.3 PK	74.0	-10.7	1.02 H	310	61.5	1.8
2	5150.00	49.2 AV	54.0	-4.8	1.02 H	310	47.4	1.8
3	*5180.00	107.9 PK			1.02 H	310	67.9	40.0
4	*5180.00	98.0 AV			1.02 H	310	58.0	40.0
5	#10360.00	57.9 PK	68.2	-10.3	2.64 H	199	49.7	8.2

**Antenna Polarity & Test Distance : Vertical at 3 m**

No	Frequency (MHz)	Emission Level (dBuV/m)	Limit (dBuV/m)	Margin (dB)	Antenna Height (m)	Table Angle (Degree)	Raw Value (dBuV)	Correction Factor (dB/m)
1	5150.00	68.5 PK	74.0	-5.5	2.13 V	290	66.7	1.8
2	5150.00	53.4 AV	54.0	-0.6	2.13 V	290	51.6	1.8
3	*5180.00	114.4 PK			2.13 V	290	74.4	40.0
4	*5180.00	104.5 AV			2.13 V	290	64.5	40.0
5	#10360.00	63.1 PK	68.2	-5.1	2.70 V	267	54.9	8.2

**Remarks:**

1. Emission Level(dBuV/m) = Raw Value(dBuV) + Correction Factor(dB/m)
2. Correction Factor(dB/m) = Antenna Factor(dB/m) + Cable Factor(dB) – Pre-Amplifier Factor(dB)
3. Margin value = Emission Level – Limit value
4. The other emission levels were very low against the limit.
5. " \* ": Fundamental frequency.
6. " # ": The radiated frequency is out of the restricted band.

<b>RF Mode</b>	TX 802.11ac (VHT20)	<b>Channel</b>	CH 40 : 5200 MHz
<b>Frequency Range</b>	1GHz ~ 40GHz	<b>Detector Function</b>	Peak (PK) Average (AV)

**Antenna Polarity & Test Distance : Horizontal at 3 m**

No	Frequency (MHz)	Emission Level (dBuV/m)	Limit (dBuV/m)	Margin (dB)	Antenna Height (m)	Table Angle (Degree)	Raw Value (dBuV)	Correction Factor (dB/m)
1	5150.00	64.0 PK	74.0	-10.0	1.10 H	309	62.2	1.8
2	5150.00	48.6 AV	54.0	-5.4	1.10 H	309	46.8	1.8
3	*5200.00	110.3 PK			1.10 H	309	70.3	40.0
4	*5200.00	99.9 AV			1.10 H	309	59.9	40.0
5	#10400.00	55.9 PK	68.2	-12.3	2.72 H	193	47.8	8.1

**Antenna Polarity & Test Distance : Vertical at 3 m**

No	Frequency (MHz)	Emission Level (dBuV/m)	Limit (dBuV/m)	Margin (dB)	Antenna Height (m)	Table Angle (Degree)	Raw Value (dBuV)	Correction Factor (dB/m)
1	5150.00	69.4 PK	74.0	-4.6	3.07 V	291	67.6	1.8
2	5150.00	53.5 AV	54.0	-0.5	3.07 V	291	51.7	1.8
3	*5200.00	117.0 PK			3.07 V	291	77.0	40.0
4	*5200.00	106.7 AV			3.07 V	291	66.7	40.0
5	#10400.00	60.9 PK	68.2	-7.3	3.02 V	263	52.8	8.1

**Remarks:**

1. Emission Level(dBuV/m) = Raw Value(dBuV) + Correction Factor(dB/m)
2. Correction Factor(dB/m) = Antenna Factor(dB/m) + Cable Factor(dB) – Pre-Amplifier Factor(dB)
3. Margin value = Emission Level – Limit value
4. The other emission levels were very low against the limit.
5. " \* " : Fundamental frequency.
6. " # " : The radiated frequency is out of the restricted band.

<b>RF Mode</b>	TX 802.11ac (VHT20)	<b>Channel</b>	CH 48 : 5240 MHz
<b>Frequency Range</b>	1GHz ~ 40GHz	<b>Detector Function</b>	Peak (PK) Average (AV)

**Antenna Polarity & Test Distance : Horizontal at 3 m**

No	Frequency (MHz)	Emission Level (dBuV/m)	Limit (dBuV/m)	Margin (dB)	Antenna Height (m)	Table Angle (Degree)	Raw Value (dBuV)	Correction Factor (dB/m)
1	5150.00	57.5 PK	74.0	-16.5	1.00 H	315	55.7	1.8
2	5150.00	44.4 AV	54.0	-9.6	1.00 H	315	42.6	1.8
3	*5240.00	107.2 PK			1.00 H	315	67.2	40.0
4	*5240.00	97.1 AV			1.00 H	315	57.1	40.0
5	#10480.00	55.3 PK	68.2	-12.9	2.59 H	201	47.2	8.1

**Antenna Polarity & Test Distance : Vertical at 3 m**

No	Frequency (MHz)	Emission Level (dBuV/m)	Limit (dBuV/m)	Margin (dB)	Antenna Height (m)	Table Angle (Degree)	Raw Value (dBuV)	Correction Factor (dB/m)
1	5150.00	59.1 PK	74.0	-14.9	3.18 V	289	57.3	1.8
2	5150.00	45.7 AV	54.0	-8.3	3.18 V	289	43.9	1.8
3	*5240.00	118.6 PK			3.18 V	289	78.6	40.0
4	*5240.00	107.7 AV			3.18 V	289	67.7	40.0
5	#10480.00	61.8 PK	68.2	-6.4	2.37 V	276	53.7	8.1

**Remarks:**

1. Emission Level(dBuV/m) = Raw Value(dBuV) + Correction Factor(dB/m)
2. Correction Factor(dB/m) = Antenna Factor(dB/m) + Cable Factor(dB) – Pre-Amplifier Factor(dB)
3. Margin value = Emission Level – Limit value
4. The other emission levels were very low against the limit.
5. " \* " : Fundamental frequency.
6. " # " : The radiated frequency is out of the restricted band.

<b>RF Mode</b>	TX 802.11ac (VHT20)	<b>Channel</b>	CH 52 : 5260 MHz
<b>Frequency Range</b>	1GHz ~ 40GHz	<b>Detector Function</b>	Peak (PK) Average (AV)

**Antenna Polarity & Test Distance : Horizontal at 3 m**

No	Frequency (MHz)	Emission Level (dBuV/m)	Limit (dBuV/m)	Margin (dB)	Antenna Height (m)	Table Angle (Degree)	Raw Value (dBuV)	Correction Factor (dB/m)
1	5150.00	57.5 PK	74.0	-16.5	1.00 H	312	55.7	1.8
2	5150.00	44.6 AV	54.0	-9.4	1.00 H	312	42.8	1.8
3	*5260.00	112.6 PK			1.00 H	312	72.7	39.9
4	*5260.00	101.6 AV			1.00 H	312	61.7	39.9
5	#10520.00	61.3 PK	68.2	-6.9	2.55 H	203	53.1	8.2

**Antenna Polarity & Test Distance : Vertical at 3 m**

No	Frequency (MHz)	Emission Level (dBuV/m)	Limit (dBuV/m)	Margin (dB)	Antenna Height (m)	Table Angle (Degree)	Raw Value (dBuV)	Correction Factor (dB/m)
1	5150.00	58.1 PK	74.0	-15.9	2.97 V	290	56.3	1.8
2	5150.00	44.8 AV	54.0	-9.2	2.97 V	290	43.0	1.8
3	*5260.00	119.8 PK			2.97 V	290	79.9	39.9
4	*5260.00	109.4 AV			2.97 V	290	69.5	39.9
5	#10520.00	64.3 PK	68.2	-3.9	2.35 V	280	56.1	8.2

**Remarks:**

1. Emission Level(dBuV/m) = Raw Value(dBuV) + Correction Factor(dB/m)
2. Correction Factor(dB/m) = Antenna Factor(dB/m) + Cable Factor(dB) – Pre-Amplifier Factor(dB)
3. Margin value = Emission Level – Limit value
4. The other emission levels were very low against the limit.
5. " \* " : Fundamental frequency.
6. " # " : The radiated frequency is out of the restricted band.

<b>RF Mode</b>	TX 802.11ac (VHT20)	<b>Channel</b>	CH 60 : 5300 MHz
<b>Frequency Range</b>	1GHz ~ 40GHz	<b>Detector Function</b>	Peak (PK) Average (AV)

**Antenna Polarity & Test Distance : Horizontal at 3 m**

No	Frequency (MHz)	Emission Level (dBuV/m)	Limit (dBuV/m)	Margin (dB)	Antenna Height (m)	Table Angle (Degree)	Raw Value (dBuV)	Correction Factor (dB/m)
1	*5300.00	111.2 PK			1.06 H	313	71.2	40.0
2	*5300.00	101.2 AV			1.06 H	313	61.2	40.0
3	5350.00	61.2 PK	74.0	-12.8	1.06 H	313	59.4	1.8
4	5350.00	47.5 AV	54.0	-6.5	1.06 H	313	45.7	1.8
5	10600.00	60.5 PK	74.0	-13.5	2.45 H	200	52.4	8.1
6	10600.00	47.6 AV	54.0	-6.4	2.45 H	200	39.5	8.1

**Antenna Polarity & Test Distance : Vertical at 3 m**

No	Frequency (MHz)	Emission Level (dBuV/m)	Limit (dBuV/m)	Margin (dB)	Antenna Height (m)	Table Angle (Degree)	Raw Value (dBuV)	Correction Factor (dB/m)
1	*5300.00	118.0 PK			2.92 V	289	78.0	40.0
2	*5300.00	107.9 AV			2.92 V	289	67.9	40.0
3	5350.00	67.2 PK	74.0	-6.8	2.92 V	289	65.4	1.8
4	5350.00	53.3 AV	54.0	-0.7	2.92 V	289	51.5	1.8
5	10600.00	62.3 PK	74.0	-11.7	2.35 V	280	54.2	8.1
6	10600.00	49.1 AV	54.0	-4.9	2.35 V	280	41.0	8.1

**Remarks:**

1. Emission Level(dBuV/m) = Raw Value(dBuV) + Correction Factor(dB/m)
2. Correction Factor(dB/m) = Antenna Factor(dB/m) + Cable Factor(dB) – Pre-Amplifier Factor(dB)
3. Margin value = Emission Level – Limit value
4. The other emission levels were very low against the limit.
5. " \* ": Fundamental frequency.

<b>RF Mode</b>	TX 802.11ac (VHT20)	<b>Channel</b>	CH 64 : 5320 MHz
<b>Frequency Range</b>	1GHz ~ 40GHz	<b>Detector Function</b>	Peak (PK) Average (AV)

**Antenna Polarity & Test Distance : Horizontal at 3 m**

No	Frequency (MHz)	Emission Level (dBuV/m)	Limit (dBuV/m)	Margin (dB)	Antenna Height (m)	Table Angle (Degree)	Raw Value (dBuV)	Correction Factor (dB/m)
1	*5320.00	109.5 PK			1.05 H	312	69.5	40.0
2	*5320.00	99.6 AV			1.05 H	312	59.6	40.0
3	5350.00	61.0 PK	74.0	-13.0	1.05 H	312	59.2	1.8
4	5350.00	47.7 AV	54.0	-6.3	1.05 H	312	45.9	1.8
5	10640.00	58.4 PK	74.0	-15.6	2.35 H	199	50.3	8.1
6	10640.00	44.8 AV	54.0	-9.2	2.35 H	199	36.7	8.1

**Antenna Polarity & Test Distance : Vertical at 3 m**

No	Frequency (MHz)	Emission Level (dBuV/m)	Limit (dBuV/m)	Margin (dB)	Antenna Height (m)	Table Angle (Degree)	Raw Value (dBuV)	Correction Factor (dB/m)
1	*5320.00	116.2 PK			2.90 V	289	76.2	40.0
2	*5320.00	106.5 AV			2.90 V	289	66.5	40.0
3	5350.00	66.9 PK	74.0	-7.1	2.90 V	289	65.1	1.8
4	5350.00	53.1 AV	54.0	-0.9	2.90 V	289	51.3	1.8
5	10640.00	60.1 PK	74.0	-13.9	2.82 V	273	52.0	8.1
6	10640.00	46.5 AV	54.0	-7.5	2.82 V	273	38.4	8.1

**Remarks:**

1. Emission Level(dBuV/m) = Raw Value(dBuV) + Correction Factor(dB/m)
2. Correction Factor(dB/m) = Antenna Factor(dB/m) + Cable Factor(dB) – Pre-Amplifier Factor(dB)
3. Margin value = Emission Level – Limit value
4. The other emission levels were very low against the limit.
5. " \* ": Fundamental frequency.

<b>RF Mode</b>	TX 802.11ac (VHT20)	<b>Channel</b>	CH 100 : 5500 MHz
<b>Frequency Range</b>	1GHz ~ 40GHz	<b>Detector Function</b>	Peak (PK) Average (AV)

Antenna Polarity & Test Distance : Horizontal at 3 m								
No	Frequency (MHz)	Emission Level (dBuV/m)	Limit (dBuV/m)	Margin (dB)	Antenna Height (m)	Table Angle (Degree)	Raw Value (dBuV)	Correction Factor (dB/m)
1	5460.00	60.4 PK	74.0	-13.6	3.22 H	209	58.3	2.1
2	5460.00	44.8 AV	54.0	-9.2	3.22 H	209	42.7	2.1
3	#5470.00	61.7 PK	68.2	-6.5	3.22 H	209	59.6	2.1
4	*5500.00	104.8 PK			3.22 H	209	64.5	40.3
5	*5500.00	94.6 AV			3.22 H	209	54.3	40.3
6	11000.00	58.6 PK	74.0	-15.4	2.28 H	202	50.4	8.2
7	11000.00	46.3 AV	54.0	-7.7	2.28 H	202	38.1	8.2
Antenna Polarity & Test Distance : Vertical at 3 m								
No	Frequency (MHz)	Emission Level (dBuV/m)	Limit (dBuV/m)	Margin (dB)	Antenna Height (m)	Table Angle (Degree)	Raw Value (dBuV)	Correction Factor (dB/m)
1	5460.00	66.1 PK	74.0	-7.9	2.36 V	295	64.0	2.1
2	5460.00	47.3 AV	54.0	-6.7	2.36 V	295	45.2	2.1
3	#5470.00	67.7 PK	68.2	-0.5	2.36 V	295	65.6	2.1
4	*5500.00	111.3 PK			2.36 V	295	71.0	40.3
5	*5500.00	101.5 AV			2.36 V	295	61.2	40.3
6	11000.00	67.3 PK	74.0	-6.7	3.05 V	262	59.1	8.2
7	11000.00	52.4 AV	54.0	-1.6	3.05 V	262	44.2	8.2

**Remarks:**

1. Emission Level(dBuV/m) = Raw Value(dBuV) + Correction Factor(dB/m)
2. Correction Factor(dB/m) = Antenna Factor(dB/m) + Cable Factor(dB) – Pre-Amplifier Factor(dB)
3. Margin value = Emission Level – Limit value
4. The other emission levels were very low against the limit.
5. " \* ": Fundamental frequency.
6. " # ": The radiated frequency is out of the restricted band.



<b>RF Mode</b>	TX 802.11ac (VHT20)	<b>Channel</b>	CH 116 : 5580 MHz
<b>Frequency Range</b>	1GHz ~ 40GHz	<b>Detector Function</b>	Peak (PK) Average (AV)

**Antenna Polarity & Test Distance : Horizontal at 3 m**

No	Frequency (MHz)	Emission Level (dBuV/m)	Limit (dBuV/m)	Margin (dB)	Antenna Height (m)	Table Angle (Degree)	Raw Value (dBuV)	Correction Factor (dB/m)
1	*5580.00	104.8 PK			1.06 H	310	64.1	40.7
2	*5580.00	94.9 AV			1.06 H	310	54.2	40.7
3	11160.00	62.8 PK	74.0	-11.2	2.24 H	208	54.6	8.2
4	11160.00	47.4 AV	54.0	-6.6	2.24 H	208	39.2	8.2

**Antenna Polarity & Test Distance : Vertical at 3 m**

No	Frequency (MHz)	Emission Level (dBuV/m)	Limit (dBuV/m)	Margin (dB)	Antenna Height (m)	Table Angle (Degree)	Raw Value (dBuV)	Correction Factor (dB/m)
1	*5580.00	114.1 PK			2.25 V	295	73.4	40.7
2	*5580.00	104.1 AV			2.25 V	295	63.4	40.7
3	11160.00	69.9 PK	74.0	-4.1	2.26 V	258	61.7	8.2
4	11160.00	53.4 AV	54.0	-0.6	2.26 V	258	45.2	8.2

**Remarks:**

1. Emission Level(dBuV/m) = Raw Value(dBuV) + Correction Factor(dB/m)
2. Correction Factor(dB/m) = Antenna Factor(dB/m) + Cable Factor(dB) – Pre-Amplifier Factor(dB)
3. Margin value = Emission Level – Limit value
4. The other emission levels were very low against the limit.
5. " \* ": Fundamental frequency.

<b>RF Mode</b>	TX 802.11ac (VHT20)	<b>Channel</b>	CH 140 : 5700 MHz
<b>Frequency Range</b>	1GHz ~ 40GHz	<b>Detector Function</b>	Peak (PK) Average (AV)

**Antenna Polarity & Test Distance : Horizontal at 3 m**

No	Frequency (MHz)	Emission Level (dBuV/m)	Limit (dBuV/m)	Margin (dB)	Antenna Height (m)	Table Angle (Degree)	Raw Value (dBuV)	Correction Factor (dB/m)
1	*5700.00	103.1 PK			1.05 H	309	61.8	41.3
2	*5700.00	93.3 AV			1.05 H	309	52.0	41.3
3	#5725.00	59.5 PK	68.2	-8.7	1.05 H	309	56.2	3.3
4	11400.00	56.0 PK	74.0	-18.0	2.26 H	206	47.2	8.8
5	11400.00	41.2 AV	54.0	-12.8	2.26 H	206	32.4	8.8

**Antenna Polarity & Test Distance : Vertical at 3 m**

No	Frequency (MHz)	Emission Level (dBuV/m)	Limit (dBuV/m)	Margin (dB)	Antenna Height (m)	Table Angle (Degree)	Raw Value (dBuV)	Correction Factor (dB/m)
1	*5700.00	113.0 PK			2.28 V	289	71.7	41.3
2	*5700.00	103.1 AV			2.28 V	289	61.8	41.3
3	#5725.00	67.8 PK	68.2	-0.4	2.28 V	289	64.5	3.3
4	11400.00	61.9 PK	74.0	-12.1	2.28 V	259	53.1	8.8
5	11400.00	44.8 AV	54.0	-9.2	2.28 V	259	36.0	8.8

**Remarks:**

1. Emission Level(dBuV/m) = Raw Value(dBuV) + Correction Factor(dB/m)
2. Correction Factor(dB/m) = Antenna Factor(dB/m) + Cable Factor(dB) – Pre-Amplifier Factor(dB)
3. Margin value = Emission Level – Limit value
4. The other emission levels were very low against the limit.
5. " \* " : Fundamental frequency.
6. " # " : The radiated frequency is out of the restricted band.

<b>RF Mode</b>	TX 802.11ac (VHT20)	<b>Channel</b>	CH 144 : 5720 MHz
<b>Frequency Range</b>	1GHz ~ 40GHz	<b>Detector Function</b>	Peak (PK) Average (AV)

Antenna Polarity & Test Distance : Horizontal at 3 m								
No	Frequency (MHz)	Emission Level (dBuV/m)	Limit (dBuV/m)	Margin (dB)	Antenna Height (m)	Table Angle (Degree)	Raw Value (dBuV)	Correction Factor (dB/m)
1	#5470.00	57.8 PK	68.2	-10.4	1.13 H	309	55.7	2.1
2	*5720.00	105.6 PK			1.13 H	309	64.3	41.3
3	*5720.00	95.5 AV			1.13 H	309	54.2	41.3
4	#5850.00	59.5 PK	68.2	-8.7	1.13 H	309	55.9	3.6
5	11440.00	62.8 PK	74.0	-11.2	2.22 H	209	54.0	8.8
6	11440.00	47.5 AV	54.0	-6.5	2.22 H	209	38.7	8.8
Antenna Polarity & Test Distance : Vertical at 3 m								
No	Frequency (MHz)	Emission Level (dBuV/m)	Limit (dBuV/m)	Margin (dB)	Antenna Height (m)	Table Angle (Degree)	Raw Value (dBuV)	Correction Factor (dB/m)
1	#5470.00	57.9 PK	68.2	-10.3	2.15 V	289	55.8	2.1
2	*5720.00	116.6 PK			2.15 V	289	75.3	41.3
3	*5720.00	106.2 AV			2.15 V	289	64.9	41.3
4	#5850.00	59.6 PK	68.2	-8.6	2.15 V	289	56.0	3.6
5	11440.00	67.4 PK	74.0	-6.6	2.21 V	256	58.6	8.8
6	11440.00	53.4 AV	54.0	-0.6	2.21 V	256	44.6	8.8

**Remarks:**

1. Emission Level(dBuV/m) = Raw Value(dBuV) + Correction Factor(dB/m)
2. Correction Factor(dB/m) = Antenna Factor(dB/m) + Cable Factor(dB) – Pre-Amplifier Factor(dB)
3. Margin value = Emission Level – Limit value
4. The other emission levels were very low against the limit.
5. " \* " : Fundamental frequency.
6. " # " : The radiated frequency is out of the restricted band.

<b>RF Mode</b>	TX 802.11ac (VHT20)	<b>Channel</b>	CH 149 : 5745 MHz
<b>Frequency Range</b>	1GHz ~ 40GHz	<b>Detector Function</b>	Peak (PK) Average (AV)

**Antenna Polarity & Test Distance : Horizontal at 3 m**

No	Frequency (MHz)	Emission Level (dBuV/m)	Limit (dBuV/m)	Margin (dB)	Antenna Height (m)	Table Angle (Degree)	Raw Value (dBuV)	Correction Factor (dB/m)
1	#5637.20	58.2 PK	68.2	-10.0	1.02 H	308	55.3	2.9
2	*5745.00	105.4 PK			1.02 H	308	64.0	41.4
3	*5745.00	95.5 AV			1.02 H	308	54.1	41.4
4	#5999.60	58.7 PK	68.2	-9.5	1.02 H	308	54.9	3.8
5	11490.00	62.9 PK	74.0	-11.1	2.76 H	198	54.2	8.7
6	11490.00	48.9 AV	54.0	-5.1	2.76 H	198	40.2	8.7

**Antenna Polarity & Test Distance : Vertical at 3 m**

No	Frequency (MHz)	Emission Level (dBuV/m)	Limit (dBuV/m)	Margin (dB)	Antenna Height (m)	Table Angle (Degree)	Raw Value (dBuV)	Correction Factor (dB/m)
1	#5649.20	58.0 PK	68.2	-10.2	2.35 V	287	55.0	3.0
2	*5745.00	116.1 PK			2.35 V	287	74.7	41.4
3	*5745.00	105.9 AV			2.35 V	287	64.5	41.4
4	#5992.40	58.5 PK	68.2	-9.7	2.35 V	287	54.7	3.8
5	11490.00	68.9 PK	74.0	-5.1	3.90 V	273	60.2	8.7
6	<b>11490.00</b>	<b>53.8 AV</b>	<b>54.0</b>	<b>-0.2</b>	<b>3.90 V</b>	<b>273</b>	<b>45.1</b>	<b>8.7</b>

**Remarks:**

1. Emission Level(dBuV/m) = Raw Value(dBuV) + Correction Factor(dB/m)
2. Correction Factor(dB/m) = Antenna Factor(dB/m) + Cable Factor(dB) – Pre-Amplifier Factor(dB)
3. Margin value = Emission Level – Limit value
4. The other emission levels were very low against the limit.
5. " \* ": Fundamental frequency.
6. " # ": The radiated frequency is out of the restricted band.

<b>RF Mode</b>	TX 802.11ac (VHT20)	<b>Channel</b>	CH 157 : 5785 MHz
<b>Frequency Range</b>	1GHz ~ 40GHz	<b>Detector Function</b>	Peak (PK) Average (AV)

Antenna Polarity & Test Distance : Horizontal at 3 m								
No	Frequency (MHz)	Emission Level (dBuV/m)	Limit (dBuV/m)	Margin (dB)	Antenna Height (m)	Table Angle (Degree)	Raw Value (dBuV)	Correction Factor (dB/m)
1	#5648.40	57.6 PK	68.2	-10.6	1.07 H	308	54.6	3.0
2	*5785.00	105.5 PK			1.07 H	308	64.0	41.5
3	*5785.00	95.5 AV			1.07 H	308	54.0	41.5
4	#5962.40	58.5 PK	68.2	-9.7	1.07 H	308	54.8	3.7
5	11570.00	62.0 PK	74.0	-12.0	2.79 H	201	53.4	8.6
6	11570.00	48.2 AV	54.0	-5.8	2.79 H	201	39.6	8.6
Antenna Polarity & Test Distance : Vertical at 3 m								
No	Frequency (MHz)	Emission Level (dBuV/m)	Limit (dBuV/m)	Margin (dB)	Antenna Height (m)	Table Angle (Degree)	Raw Value (dBuV)	Correction Factor (dB/m)
1	#5631.60	57.6 PK	68.2	-10.6	2.29 V	287	54.7	2.9
2	*5785.00	117.4 PK			2.29 V	287	75.9	41.5
3	*5785.00	107.2 AV			2.29 V	287	65.7	41.5
4	#5939.60	59.0 PK	68.2	-9.2	2.29 V	287	55.3	3.7
5	11570.00	68.0 PK	74.0	-6.0	3.83 V	262	59.4	8.6
6	11570.00	53.2 AV	54.0	-0.8	3.83 V	262	44.6	8.6

**Remarks:**

1. Emission Level(dBuV/m) = Raw Value(dBuV) + Correction Factor(dB/m)
2. Correction Factor(dB/m) = Antenna Factor(dB/m) + Cable Factor(dB) – Pre-Amplifier Factor(dB)
3. Margin value = Emission Level – Limit value
4. The other emission levels were very low against the limit.
5. " \* " : Fundamental frequency.
6. " # " : The radiated frequency is out of the restricted band.

<b>RF Mode</b>	TX 802.11ac (VHT20)	<b>Channel</b>	CH 165 : 5825 MHz
<b>Frequency Range</b>	1GHz ~ 40GHz	<b>Detector Function</b>	Peak (PK) Average (AV)

Antenna Polarity & Test Distance : Horizontal at 3 m								
No	Frequency (MHz)	Emission Level (dBuV/m)	Limit (dBuV/m)	Margin (dB)	Antenna Height (m)	Table Angle (Degree)	Raw Value (dBuV)	Correction Factor (dB/m)
1	#5648.00	57.9 PK	68.2	-10.3	1.00 H	307	54.9	3.0
2	*5825.00	106.3 PK			1.00 H	307	64.7	41.6
3	*5825.00	96.2 AV			1.00 H	307	54.6	41.6
4	#5992.40	58.7 PK	68.2	-9.5	1.00 H	307	54.9	3.8
5	11650.00	62.8 PK	74.0	-11.2	2.78 H	203	54.1	8.7
6	11650.00	48.4 AV	54.0	-5.6	2.78 H	203	39.7	8.7
Antenna Polarity & Test Distance : Vertical at 3 m								
No	Frequency (MHz)	Emission Level (dBuV/m)	Limit (dBuV/m)	Margin (dB)	Antenna Height (m)	Table Angle (Degree)	Raw Value (dBuV)	Correction Factor (dB/m)
1	#5630.80	58.4 PK	68.2	-9.8	2.33 V	287	55.5	2.9
2	*5825.00	117.6 PK			2.33 V	287	76.0	41.6
3	*5825.00	107.4 AV			2.33 V	287	65.8	41.6
4	#5967.60	59.1 PK	68.2	-9.1	2.33 V	287	55.4	3.7
5	11650.00	69.0 PK	74.0	-5.0	3.88 V	261	60.3	8.7
6	11650.00	53.3 AV	54.0	-0.7	3.88 V	261	44.6	8.7

**Remarks:**

1. Emission Level(dBuV/m) = Raw Value(dBuV) + Correction Factor(dB/m)
2. Correction Factor(dB/m) = Antenna Factor(dB/m) + Cable Factor(dB) – Pre-Amplifier Factor(dB)
3. Margin value = Emission Level – Limit value
4. The other emission levels were very low against the limit.
5. " \* " : Fundamental frequency.
6. " # " : The radiated frequency is out of the restricted band.

**802.11ac (VHT40)**

<b>RF Mode</b>	TX 802.11ac (VHT40)	<b>Channel</b>	CH 38 : 5190 MHz
<b>Frequency Range</b>	1GHz ~ 40GHz	<b>Detector Function</b>	Peak (PK) Average (AV)

**Antenna Polarity & Test Distance : Horizontal at 3 m**

No	Frequency (MHz)	Emission Level (dBuV/m)	Limit (dBuV/m)	Margin (dB)	Antenna Height (m)	Table Angle (Degree)	Raw Value (dBuV)	Correction Factor (dB/m)
1	5150.00	60.2 PK	74.0	-13.8	2.47 H	334	58.4	1.8
2	5150.00	46.7 AV	54.0	-7.3	2.47 H	334	44.9	1.8
3	*5190.00	101.1 PK			2.47 H	334	61.1	40.0
4	*5190.00	91.5 AV			2.47 H	334	51.5	40.0
5	#10380.00	55.7 PK	68.2	-12.5	2.35 H	142	47.6	8.1

**Antenna Polarity & Test Distance : Vertical at 3 m**

No	Frequency (MHz)	Emission Level (dBuV/m)	Limit (dBuV/m)	Margin (dB)	Antenna Height (m)	Table Angle (Degree)	Raw Value (dBuV)	Correction Factor (dB/m)
1	5150.00	66.5 PK	74.0	-7.5	1.23 V	265	64.7	1.8
2	5150.00	53.4 AV	54.0	-0.6	1.23 V	265	51.6	1.8
3	*5190.00	109.4 PK			1.23 V	265	69.4	40.0
4	*5190.00	99.5 AV			1.23 V	265	59.5	40.0
5	#10380.00	57.2 PK	68.2	-11.0	2.86 V	266	49.1	8.1

**Remarks:**

1. Emission Level(dBuV/m) = Raw Value(dBuV) + Correction Factor(dB/m)
2. Correction Factor(dB/m) = Antenna Factor(dB/m) + Cable Factor(dB) – Pre-Amplifier Factor(dB)
3. Margin value = Emission Level – Limit value
4. The other emission levels were very low against the limit.
5. " \* ": Fundamental frequency.
6. " # ": The radiated frequency is out of the restricted band.

<b>RF Mode</b>	TX 802.11ac (VHT40)	<b>Channel</b>	CH 46 : 5230 MHz
<b>Frequency Range</b>	1GHz ~ 40GHz	<b>Detector Function</b>	Peak (PK) Average (AV)

**Antenna Polarity & Test Distance : Horizontal at 3 m**

No	Frequency (MHz)	Emission Level (dBuV/m)	Limit (dBuV/m)	Margin (dB)	Antenna Height (m)	Table Angle (Degree)	Raw Value (dBuV)	Correction Factor (dB/m)
1	5150.00	60.7 PK	74.0	-13.3	1.14 H	309	58.9	1.8
2	5150.00	47.8 AV	54.0	-6.2	1.14 H	309	46.0	1.8
3	*5230.00	106.0 PK			1.14 H	309	66.0	40.0
4	*5230.00	96.3 AV			1.14 H	309	56.3	40.0
5	#10460.00	55.3 PK	68.2	-12.9	2.69 H	197	47.3	8.0

**Antenna Polarity & Test Distance : Vertical at 3 m**

No	Frequency (MHz)	Emission Level (dBuV/m)	Limit (dBuV/m)	Margin (dB)	Antenna Height (m)	Table Angle (Degree)	Raw Value (dBuV)	Correction Factor (dB/m)
1	5150.00	66.9 PK	74.0	-7.1	3.18 V	290	65.1	1.8
2	5150.00	53.1 AV	54.0	-0.9	3.18 V	290	51.3	1.8
3	*5230.00	113.3 PK			3.18 V	290	73.3	40.0
4	*5230.00	103.3 AV			3.18 V	290	63.3	40.0
5	#10460.00	60.4 PK	68.2	-7.8	2.33 V	280	52.4	8.0

**Remarks:**

1. Emission Level(dBuV/m) = Raw Value(dBuV) + Correction Factor(dB/m)
2. Correction Factor(dB/m) = Antenna Factor(dB/m) + Cable Factor(dB) – Pre-Amplifier Factor(dB)
3. Margin value = Emission Level – Limit value
4. The other emission levels were very low against the limit.
5. " \* " : Fundamental frequency.
6. " # " : The radiated frequency is out of the restricted band.



<b>RF Mode</b>	TX 802.11ac (VHT40)	<b>Channel</b>	CH 54 : 5270 MHz
<b>Frequency Range</b>	1GHz ~ 40GHz	<b>Detector Function</b>	Peak (PK) Average (AV)

**Antenna Polarity & Test Distance : Horizontal at 3 m**

No	Frequency (MHz)	Emission Level (dBuV/m)	Limit (dBuV/m)	Margin (dB)	Antenna Height (m)	Table Angle (Degree)	Raw Value (dBuV)	Correction Factor (dB/m)
1	*5270.00	106.3 PK			1.10 H	313	66.3	40.0
2	*5270.00	96.6 AV			1.10 H	313	56.6	40.0
3	5350.00	61.1 PK	74.0	-12.9	1.10 H	313	59.3	1.8
4	5350.00	47.8 AV	54.0	-6.2	1.10 H	313	46.0	1.8
5	#10540.00	54.7 PK	68.2	-13.5	2.55 H	203	46.5	8.2

**Antenna Polarity & Test Distance : Vertical at 3 m**

No	Frequency (MHz)	Emission Level (dBuV/m)	Limit (dBuV/m)	Margin (dB)	Antenna Height (m)	Table Angle (Degree)	Raw Value (dBuV)	Correction Factor (dB/m)
1	*5270.00	114.1 PK			2.97 V	291	74.1	40.0
2	*5270.00	104.3 AV			2.97 V	291	64.3	40.0
3	5350.00	65.7 PK	74.0	-8.3	2.97 V	291	63.9	1.8
4	5350.00	53.3 AV	54.0	-0.7	2.97 V	291	51.5	1.8
5	#10540.00	57.1 PK	68.2	-11.1	2.39 V	281	48.9	8.2

**Remarks:**

1. Emission Level(dBuV/m) = Raw Value(dBuV) + Correction Factor(dB/m)
2. Correction Factor(dB/m) = Antenna Factor(dB/m) + Cable Factor(dB) – Pre-Amplifier Factor(dB)
3. Margin value = Emission Level – Limit value
4. The other emission levels were very low against the limit.
5. " \* " : Fundamental frequency.
6. " # " : The radiated frequency is out of the restricted band.

<b>RF Mode</b>	TX 802.11ac (VHT40)	<b>Channel</b>	CH 62 : 5310 MHz
<b>Frequency Range</b>	1GHz ~ 40GHz	<b>Detector Function</b>	Peak (PK) Average (AV)

**Antenna Polarity & Test Distance : Horizontal at 3 m**

No	Frequency (MHz)	Emission Level (dBuV/m)	Limit (dBuV/m)	Margin (dB)	Antenna Height (m)	Table Angle (Degree)	Raw Value (dBuV)	Correction Factor (dB/m)
1	*5310.00	103.4 PK			1.06 H	312	63.4	40.0
2	*5310.00	94.0 AV			1.06 H	312	54.0	40.0
3	5350.00	60.4 PK	74.0	-13.6	1.06 H	312	58.6	1.8
4	5350.00	47.6 AV	54.0	-6.4	1.06 H	312	45.8	1.8
5	10640.00	54.6 PK	74.0	-19.4	2.49 H	198	46.5	8.1
6	10640.00	42.3 AV	54.0	-11.7	2.49 H	198	34.2	8.1

**Antenna Polarity & Test Distance : Vertical at 3 m**

No	Frequency (MHz)	Emission Level (dBuV/m)	Limit (dBuV/m)	Margin (dB)	Antenna Height (m)	Table Angle (Degree)	Raw Value (dBuV)	Correction Factor (dB/m)
1	*5310.00	110.7 PK			3.08 V	289	70.7	40.0
2	*5310.00	101.0 AV			3.08 V	289	61.0	40.0
3	5350.00	67.3 PK	74.0	-6.7	3.08 V	289	65.5	1.8
4	5350.00	53.5 AV	54.0	-0.5	3.08 V	289	51.7	1.8
5	10620.00	57.6 PK	74.0	-16.4	2.42 V	283	49.5	8.1
6	10620.00	44.6 AV	54.0	-9.4	2.42 V	283	36.5	8.1

**Remarks:**

1. Emission Level(dBuV/m) = Raw Value(dBuV) + Correction Factor(dB/m)
2. Correction Factor(dB/m) = Antenna Factor(dB/m) + Cable Factor(dB) – Pre-Amplifier Factor(dB)
3. Margin value = Emission Level – Limit value
4. The other emission levels were very low against the limit.
5. " \* ": Fundamental frequency.

<b>RF Mode</b>	TX 802.11ac (VHT40)	<b>Channel</b>	CH 102 : 5510 MHz
<b>Frequency Range</b>	1GHz ~ 40GHz	<b>Detector Function</b>	Peak (PK) Average (AV)

**Antenna Polarity & Test Distance : Horizontal at 3 m**

No	Frequency (MHz)	Emission Level (dBuV/m)	Limit (dBuV/m)	Margin (dB)	Antenna Height (m)	Table Angle (Degree)	Raw Value (dBuV)	Correction Factor (dB/m)
1	5460.00	60.3 PK	74.0	-13.7	3.21 H	208	58.2	2.1
2	5460.00	46.0 AV	54.0	-8.0	3.21 H	208	43.9	2.1
3	#5470.00	61.6 PK	68.2	-6.6	3.21 H	208	59.5	2.1
4	*5510.00	100.8 PK			3.21 H	208	60.4	40.4
5	*5510.00	90.8 AV			3.21 H	208	50.4	40.4
6	11020.00	57.0 PK	74.0	-17.0	2.27 H	206	48.8	8.2
7	11020.00	44.4 AV	54.0	-9.6	2.27 H	206	36.2	8.2

**Antenna Polarity & Test Distance : Vertical at 3 m**

No	Frequency (MHz)	Emission Level (dBuV/m)	Limit (dBuV/m)	Margin (dB)	Antenna Height (m)	Table Angle (Degree)	Raw Value (dBuV)	Correction Factor (dB/m)
1	5460.00	65.6 PK	74.0	-8.4	2.59 V	292	63.5	2.1
2	5460.00	49.4 AV	54.0	-4.6	2.59 V	292	47.3	2.1
3	#5470.00	67.4 PK	68.2	-0.8	2.59 V	292	65.3	2.1
4	*5510.00	107.4 PK			2.59 V	292	67.0	40.4
5	*5510.00	97.9 AV			2.59 V	292	57.5	40.4
6	11020.00	61.7 PK	74.0	-12.3	3.06 V	263	53.5	8.2
7	11020.00	49.9 AV	54.0	-4.1	3.06 V	263	41.7	8.2

**Remarks:**

1. Emission Level(dBuV/m) = Raw Value(dBuV) + Correction Factor(dB/m)
2. Correction Factor(dB/m) = Antenna Factor(dB/m) + Cable Factor(dB) – Pre-Amplifier Factor(dB)
3. Margin value = Emission Level – Limit value
4. The other emission levels were very low against the limit.
5. " \* ": Fundamental frequency.
6. " # ": The radiated frequency is out of the restricted band.

<b>RF Mode</b>	TX 802.11ac (VHT40)	<b>Channel</b>	CH 110 : 5550 MHz
<b>Frequency Range</b>	1GHz ~ 40GHz	<b>Detector Function</b>	Peak (PK) Average (AV)

**Antenna Polarity & Test Distance : Horizontal at 3 m**

No	Frequency (MHz)	Emission Level (dBuV/m)	Limit (dBuV/m)	Margin (dB)	Antenna Height (m)	Table Angle (Degree)	Raw Value (dBuV)	Correction Factor (dB/m)
1	5460.00	58.7 PK	74.0	-15.3	1.02 H	310	56.6	2.1
2	5460.00	45.9 AV	54.0	-8.1	1.02 H	310	43.8	2.1
3	#5470.00	61.2 PK	68.2	-7.0	1.02 H	310	59.1	2.1
4	*5550.00	103.2 PK			1.02 H	310	62.6	40.6
5	*5550.00	93.4 AV			1.02 H	310	52.8	40.6
6	11100.00	60.0 PK	74.0	-14.0	2.15 H	207	51.8	8.2
7	11100.00	47.0 AV	54.0	-7.0	2.15 H	207	38.8	8.2

**Antenna Polarity & Test Distance : Vertical at 3 m**

No	Frequency (MHz)	Emission Level (dBuV/m)	Limit (dBuV/m)	Margin (dB)	Antenna Height (m)	Table Angle (Degree)	Raw Value (dBuV)	Correction Factor (dB/m)
1	5460.00	63.2 PK	74.0	-10.8	2.27 V	298	61.1	2.1
2	5460.00	50.3 AV	54.0	-3.7	2.27 V	298	48.2	2.1
3	#5470.00	67.6 PK	68.2	-0.6	2.27 V	298	65.5	2.1
4	*5550.00	112.0 PK			2.98 V	227	71.4	40.6
5	*5550.00	102.0 AV			2.98 V	227	61.4	40.6
6	11100.00	65.7 PK	74.0	-8.3	2.25 V	254	57.5	8.2
7	11100.00	52.7 AV	54.0	-1.3	2.25 V	254	44.5	8.2

**Remarks:**

1. Emission Level(dBuV/m) = Raw Value(dBuV) + Correction Factor(dB/m)
2. Correction Factor(dB/m) = Antenna Factor(dB/m) + Cable Factor(dB) – Pre-Amplifier Factor(dB)
3. Margin value = Emission Level – Limit value
4. The other emission levels were very low against the limit.
5. " \* ": Fundamental frequency.
6. " # ": The radiated frequency is out of the restricted band.

<b>RF Mode</b>	TX 802.11ac (VHT40)	<b>Channel</b>	CH 134 : 5670 MHz
<b>Frequency Range</b>	1GHz ~ 40GHz	<b>Detector Function</b>	Peak (PK) Average (AV)

**Antenna Polarity & Test Distance : Horizontal at 3 m**

No	Frequency (MHz)	Emission Level (dBuV/m)	Limit (dBuV/m)	Margin (dB)	Antenna Height (m)	Table Angle (Degree)	Raw Value (dBuV)	Correction Factor (dB/m)
1	*5670.00	101.1 PK			1.04 H	308	60.0	41.1
2	*5670.00	91.6 AV			1.04 H	308	50.5	41.1
3	#5725.00	57.9 PK	68.2	-10.3	1.04 H	308	54.6	3.3
4	11340.00	58.5 PK	74.0	-15.5	2.08 H	205	49.9	8.6
5	11340.00	46.1 AV	54.0	-7.9	2.08 H	205	37.5	8.6

**Antenna Polarity & Test Distance : Vertical at 3 m**

No	Frequency (MHz)	Emission Level (dBuV/m)	Limit (dBuV/m)	Margin (dB)	Antenna Height (m)	Table Angle (Degree)	Raw Value (dBuV)	Correction Factor (dB/m)
1	*5670.00	110.9 PK			2.19 V	294	69.8	41.1
2	*5670.00	100.8 AV			2.19 V	294	59.7	41.1
3	#5725.00	67.3 PK	68.2	-0.9	2.19 V	294	64.0	3.3
4	11340.00	62.6 PK	74.0	-11.4	2.26 V	253	54.0	8.6
5	11340.00	50.6 AV	54.0	-3.4	2.26 V	253	42.0	8.6

**Remarks:**

1. Emission Level(dBuV/m) = Raw Value(dBuV) + Correction Factor(dB/m)
2. Correction Factor(dB/m) = Antenna Factor(dB/m) + Cable Factor(dB) – Pre-Amplifier Factor(dB)
3. Margin value = Emission Level – Limit value
4. The other emission levels were very low against the limit.
5. " \* " : Fundamental frequency.
6. " # " : The radiated frequency is out of the restricted band.

<b>RF Mode</b>	TX 802.11ac (VHT40)	<b>Channel</b>	CH 142 : 5710 MHz
<b>Frequency Range</b>	1GHz ~ 40GHz	<b>Detector Function</b>	Peak (PK) Average (AV)

Antenna Polarity & Test Distance : Horizontal at 3 m								
No	Frequency (MHz)	Emission Level (dBuV/m)	Limit (dBuV/m)	Margin (dB)	Antenna Height (m)	Table Angle (Degree)	Raw Value (dBuV)	Correction Factor (dB/m)
1	#5470.00	58.2 PK	68.2	-10.0	1.00 H	310	56.1	2.1
2	*5710.00	100.3 PK			1.00 H	310	59.0	41.3
3	*5710.00	90.4 AV			1.00 H	310	49.1	41.3
4	#5850.00	59.0 PK	68.2	-9.2	1.00 H	310	55.4	3.6
5	11420.00	56.7 PK	74.0	-17.3	2.33 H	207	47.9	8.8
6	11420.00	42.9 AV	54.0	-11.1	2.33 H	207	34.1	8.8
Antenna Polarity & Test Distance : Vertical at 3 m								
No	Frequency (MHz)	Emission Level (dBuV/m)	Limit (dBuV/m)	Margin (dB)	Antenna Height (m)	Table Angle (Degree)	Raw Value (dBuV)	Correction Factor (dB/m)
1	#5470.00	58.8 PK	68.2	-9.4	2.28 V	294	56.7	2.1
2	*5710.00	111.1 PK			2.28 V	294	69.8	41.3
3	*5710.00	101.2 AV			2.28 V	294	59.9	41.3
4	#5850.00	59.5 PK	68.2	-8.7	2.28 V	294	55.9	3.6
5	11420.00	62.0 PK	74.0	-12.0	2.23 V	254	53.2	8.8
6	11420.00	49.8 AV	54.0	-4.2	2.23 V	254	41.0	8.8

**Remarks:**

1. Emission Level(dBuV/m) = Raw Value(dBuV) + Correction Factor(dB/m)
2. Correction Factor(dB/m) = Antenna Factor(dB/m) + Cable Factor(dB) – Pre-Amplifier Factor(dB)
3. Margin value = Emission Level – Limit value
4. The other emission levels were very low against the limit.
5. " \* " : Fundamental frequency.
6. " # " : The radiated frequency is out of the restricted band.

<b>RF Mode</b>	TX 802.11ac (VHT40)	<b>Channel</b>	CH 151 : 5755 MHz
<b>Frequency Range</b>	1GHz ~ 40GHz	<b>Detector Function</b>	Peak (PK) Average (AV)

Antenna Polarity & Test Distance : Horizontal at 3 m								
No	Frequency (MHz)	Emission Level (dBuV/m)	Limit (dBuV/m)	Margin (dB)	Antenna Height (m)	Table Angle (Degree)	Raw Value (dBuV)	Correction Factor (dB/m)
1	#5648.00	59.3 PK	68.2	-8.9	1.00 H	309	56.3	3.0
2	#5650.00	60.9 PK	68.2	-7.3	1.00 H	309	57.8	3.1
3	*5755.00	104.6 PK			1.00 H	309	63.2	41.4
4	*5755.00	94.4 AV			1.00 H	309	53.0	41.4
5	#5965.20	59.1 PK	68.2	-9.1	1.00 H	309	55.4	3.7
6	11510.00	59.9 PK	74.0	-14.1	2.76 H	199	51.2	8.7
7	11510.00	48.5 AV	54.0	-5.5	2.76 H	199	39.8	8.7

Antenna Polarity & Test Distance : Vertical at 3 m								
No	Frequency (MHz)	Emission Level (dBuV/m)	Limit (dBuV/m)	Margin (dB)	Antenna Height (m)	Table Angle (Degree)	Raw Value (dBuV)	Correction Factor (dB/m)
1	#5649.20	65.4 PK	68.2	-2.8	2.36 V	287	62.4	3.0
2	#5650.00	68.0 PK	68.2	-0.2	2.36 V	287	64.9	3.1
3	*5755.00	115.0 PK			2.36 V	287	73.6	41.4
4	*5755.00	104.7 AV			2.36 V	287	63.3	41.4
5	#5930.00	61.4 PK	68.2	-6.8	2.36 V	287	57.7	3.7
6	11510.00	65.8 PK	74.0	-8.2	3.89 V	283	57.1	8.7
7	11510.00	53.4 AV	54.0	-0.6	3.89 V	283	44.7	8.7

**Remarks:**

1. Emission Level(dBuV/m) = Raw Value(dBuV) + Correction Factor(dB/m)
2. Correction Factor(dB/m) = Antenna Factor(dB/m) + Cable Factor(dB) – Pre-Amplifier Factor(dB)
3. Margin value = Emission Level – Limit value
4. The other emission levels were very low against the limit.
5. " \* ": Fundamental frequency.
6. " # ": The radiated frequency is out of the restricted band.

<b>RF Mode</b>	TX 802.11ac (VHT40)	<b>Channel</b>	CH 159 : 5795 MHz
<b>Frequency Range</b>	1GHz ~ 40GHz	<b>Detector Function</b>	Peak (PK) Average (AV)

**Antenna Polarity & Test Distance : Horizontal at 3 m**

No	Frequency (MHz)	Emission Level (dBuV/m)	Limit (dBuV/m)	Margin (dB)	Antenna Height (m)	Table Angle (Degree)	Raw Value (dBuV)	Correction Factor (dB/m)
1	#5642.80	58.4 PK	68.2	-9.8	1.02 H	307	55.5	2.9
2	*5795.00	104.0 PK			1.02 H	307	62.4	41.6
3	*5795.00	93.8 AV			1.02 H	307	52.2	41.6
4	#5925.00	60.0 PK	68.2	-8.2	1.02 H	307	56.2	3.8
5	#5927.20	59.0 PK	68.2	-9.2	1.02 H	307	55.3	3.7
6	11590.00	60.3 PK	74.0	-13.7	2.80 H	204	51.7	8.6
7	11590.00	48.6 AV	54.0	-5.4	2.80 H	204	40.0	8.6

**Antenna Polarity & Test Distance : Vertical at 3 m**

No	Frequency (MHz)	Emission Level (dBuV/m)	Limit (dBuV/m)	Margin (dB)	Antenna Height (m)	Table Angle (Degree)	Raw Value (dBuV)	Correction Factor (dB/m)
1	#5632.00	59.8 PK	68.2	-8.4	2.52 V	285	56.9	2.9
2	*5795.00	114.1 PK			2.52 V	285	72.5	41.6
3	*5795.00	103.9 AV			2.52 V	285	62.3	41.6
4	#5925.00	65.6 PK	68.2	-2.6	2.52 V	285	61.8	3.8
5	#5927.60	65.1 PK	68.2	-3.1	2.52 V	285	61.4	3.7
6	11590.00	66.3 PK	74.0	-7.7	3.83 V	285	57.7	8.6
7	11590.00	53.5 AV	54.0	-0.5	3.83 V	285	44.9	8.6

**Remarks:**

1. Emission Level(dBuV/m) = Raw Value(dBuV) + Correction Factor(dB/m)
2. Correction Factor(dB/m) = Antenna Factor(dB/m) + Cable Factor(dB) – Pre-Amplifier Factor(dB)
3. Margin value = Emission Level – Limit value
4. The other emission levels were very low against the limit.
5. " \* ": Fundamental frequency.
6. " # ": The radiated frequency is out of the restricted band.



### 802.11ac (VHT80)

<b>RF Mode</b>	TX 802.11ac (VHT80)	<b>Channel</b>	CH 42 : 5210 MHz
<b>Frequency Range</b>	1GHz ~ 40GHz	<b>Detector Function</b>	Peak (PK) Average (AV)

Antenna Polarity & Test Distance : Horizontal at 3 m								
No	Frequency (MHz)	Emission Level (dBuV/m)	Limit (dBuV/m)	Margin (dB)	Antenna Height (m)	Table Angle (Degree)	Raw Value (dBuV)	Correction Factor (dB/m)
1	5150.00	61.2 PK	74.0	-12.8	2.71 H	333	59.4	1.8
2	5150.00	46.1 AV	54.0	-7.9	2.71 H	333	44.3	1.8
3	*5210.00	98.1 PK			2.71 H	333	58.1	40.0
4	*5210.00	87.7 AV			2.71 H	333	47.7	40.0
5	5350.00	57.3 PK	74.0	-16.7	2.71 H	333	55.5	1.8
6	5350.00	44.1 AV	54.0	-9.9	2.71 H	333	42.3	1.8
7	#10420.00	55.5 PK	68.2	-12.7	2.22 H	137	47.4	8.1
Antenna Polarity & Test Distance : Vertical at 3 m								
No	Frequency (MHz)	Emission Level (dBuV/m)	Limit (dBuV/m)	Margin (dB)	Antenna Height (m)	Table Angle (Degree)	Raw Value (dBuV)	Correction Factor (dB/m)
1	5150.00	69.8 PK	74.0	-4.2	1.21 V	263	68.0	1.8
2	5150.00	53.4 AV	54.0	-0.6	1.21 V	263	51.6	1.8
3	*5210.00	105.3 PK			1.21 V	263	65.3	40.0
4	*5210.00	95.3 AV			1.21 V	263	55.3	40.0
5	5350.00	57.8 PK	74.0	-16.2	1.21 V	263	56.0	1.8
6	5350.00	45.3 AV	54.0	-8.7	1.21 V	263	43.5	1.8
7	#10420.00	56.9 PK	68.2	-11.3	2.81 V	266	48.8	8.1

#### Remarks:

1. Emission Level(dBuV/m) = Raw Value(dBuV) + Correction Factor(dB/m)
2. Correction Factor(dB/m) = Antenna Factor(dB/m) + Cable Factor(dB) – Pre-Amplifier Factor(dB)
3. Margin value = Emission Level – Limit value
4. The other emission levels were very low against the limit.
5. " \* ": Fundamental frequency.
6. " # ": The radiated frequency is out of the restricted band.

<b>RF Mode</b>	TX 802.11ac (VHT80)	<b>Channel</b>	CH 58 : 5290 MHz
<b>Frequency Range</b>	1GHz ~ 40GHz	<b>Detector Function</b>	Peak (PK) Average (AV)

Antenna Polarity & Test Distance : Horizontal at 3 m								
No	Frequency (MHz)	Emission Level (dBuV/m)	Limit (dBuV/m)	Margin (dB)	Antenna Height (m)	Table Angle (Degree)	Raw Value (dBuV)	Correction Factor (dB/m)
1	5150.00	57.7 PK	74.0	-16.3	1.07 H	312	55.9	1.8
2	5150.00	45.3 AV	54.0	-8.7	1.07 H	312	43.5	1.8
3	*5290.00	99.7 PK			1.07 H	312	59.7	40.0
4	*5290.00	90.0 AV			1.07 H	312	50.0	40.0
5	5350.00	66.1 PK	74.0	-7.9	1.07 H	312	64.3	1.8
6	5350.00	48.4 AV	54.0	-5.6	1.07 H	312	46.6	1.8
7	#10580.00	54.3 PK	68.2	-13.9	2.45 H	195	46.2	8.1

Antenna Polarity & Test Distance : Vertical at 3 m								
No	Frequency (MHz)	Emission Level (dBuV/m)	Limit (dBuV/m)	Margin (dB)	Antenna Height (m)	Table Angle (Degree)	Raw Value (dBuV)	Correction Factor (dB/m)
1	5150.00	57.9 PK	74.0	-16.1	2.96 V	289	56.1	1.8
2	5150.00	45.6 AV	54.0	-8.4	2.96 V	289	43.8	1.8
3	*5290.00	106.5 PK			2.96 V	289	66.5	40.0
4	*5290.00	97.0 AV			2.96 V	289	57.0	40.0
5	5350.00	65.4 PK	74.0	-8.6	2.96 V	289	63.6	1.8
6	5350.00	53.5 AV	54.0	-0.5	2.96 V	289	51.7	1.8
7	#10580.00	54.6 PK	68.2	-13.6	2.39 V	285	46.5	8.1

**Remarks:**

1. Emission Level(dBuV/m) = Raw Value(dBuV) + Correction Factor(dB/m)
2. Correction Factor(dB/m) = Antenna Factor(dB/m) + Cable Factor(dB) – Pre-Amplifier Factor(dB)
3. Margin value = Emission Level – Limit value
4. The other emission levels were very low against the limit.
5. " \* ": Fundamental frequency.
6. " # ": The radiated frequency is out of the restricted band.

<b>RF Mode</b>	TX 802.11ac (VHT80)	<b>Channel</b>	CH 106 : 5530 MHz
<b>Frequency Range</b>	1GHz ~ 40GHz	<b>Detector Function</b>	Peak (PK) Average (AV)

Antenna Polarity & Test Distance : Horizontal at 3 m								
No	Frequency (MHz)	Emission Level (dBuV/m)	Limit (dBuV/m)	Margin (dB)	Antenna Height (m)	Table Angle (Degree)	Raw Value (dBuV)	Correction Factor (dB/m)
1	5460.00	60.6 PK	74.0	-13.4	1.05 H	310	58.5	2.1
2	5460.00	47.7 AV	54.0	-6.3	1.05 H	310	45.6	2.1
3	#5470.00	61.7 PK	68.2	-6.5	1.05 H	310	59.6	2.1
4	*5530.00	96.1 PK			1.05 H	310	55.5	40.6
5	*5530.00	86.5 AV			1.05 H	310	45.9	40.6
6	#5725.00	58.7 PK	68.2	-9.5	1.05 H	310	55.4	3.3
7	11060.00	54.3 PK	74.0	-19.7	2.24 H	203	46.1	8.2
8	11060.00	41.5 AV	54.0	-12.5	2.24 H	203	33.3	8.2
Antenna Polarity & Test Distance : Vertical at 3 m								
No	Frequency (MHz)	Emission Level (dBuV/m)	Limit (dBuV/m)	Margin (dB)	Antenna Height (m)	Table Angle (Degree)	Raw Value (dBuV)	Correction Factor (dB/m)
1	5460.00	65.1 PK	74.0	-8.9	2.21 V	298	63.0	2.1
2	5460.00	53.1 AV	54.0	-0.9	2.21 V	298	51.0	2.1
3	#5470.00	66.8 PK	68.2	-1.4	2.21 V	298	64.7	2.1
4	*5530.00	104.2 PK			2.21 V	298	63.6	40.6
5	*5530.00	94.0 AV			2.21 V	298	53.4	40.6
6	#5725.00	58.3 PK	68.2	-9.9	2.21 V	298	55.0	3.3
7	11060.00	57.1 PK	74.0	-16.9	2.22 V	258	48.9	8.2
8	11060.00	44.8 AV	54.0	-9.2	2.22 V	258	36.6	8.2

**Remarks:**

1. Emission Level(dBuV/m) = Raw Value(dBuV) + Correction Factor(dB/m)
2. Correction Factor(dB/m) = Antenna Factor(dB/m) + Cable Factor(dB) – Pre-Amplifier Factor(dB)
3. Margin value = Emission Level – Limit value
4. The other emission levels were very low against the limit.
5. " \* ": Fundamental frequency.
6. " # ": The radiated frequency is out of the restricted band.

<b>RF Mode</b>	TX 802.11ac (VHT80)	<b>Channel</b>	CH 138 : 5690 MHz
<b>Frequency Range</b>	1GHz ~ 40GHz	<b>Detector Function</b>	Peak (PK) Average (AV)

**Antenna Polarity & Test Distance : Horizontal at 3 m**

No	Frequency (MHz)	Emission Level (dBuV/m)	Limit (dBuV/m)	Margin (dB)	Antenna Height (m)	Table Angle (Degree)	Raw Value (dBuV)	Correction Factor (dB/m)
1	#5470.00	59.1 PK	68.2	-9.1	1.03 H	308	57.0	2.1
2	*5690.00	101.1 PK			1.03 H	308	59.9	41.2
3	*5690.00	91.2 AV			1.03 H	308	50.0	41.2
4	#5850.00	60.4 PK	68.2	-7.8	1.03 H	308	56.8	3.6
5	11380.00	58.9 PK	74.0	-15.1	2.20 H	210	50.1	8.8
6	11380.00	46.8 AV	54.0	-7.2	2.20 H	210	38.0	8.8

**Antenna Polarity & Test Distance : Vertical at 3 m**

No	Frequency (MHz)	Emission Level (dBuV/m)	Limit (dBuV/m)	Margin (dB)	Antenna Height (m)	Table Angle (Degree)	Raw Value (dBuV)	Correction Factor (dB/m)
1	#5470.00	64.4 PK	68.2	-3.8	2.19 V	296	62.3	2.1
2	*5690.00	111.3 PK			2.19 V	296	70.1	41.2
3	*5690.00	101.0 AV			2.19 V	296	59.8	41.2
4	#5850.00	67.7 PK	68.2	-0.5	2.19 V	296	64.1	3.6
5	11380.00	62.8 PK	74.0	-11.2	2.20 V	252	54.0	8.8
6	11380.00	51.4 AV	54.0	-2.6	2.20 V	252	42.6	8.8

**Remarks:**

1. Emission Level(dBuV/m) = Raw Value(dBuV) + Correction Factor(dB/m)
2. Correction Factor(dB/m) = Antenna Factor(dB/m) + Cable Factor(dB) – Pre-Amplifier Factor(dB)
3. Margin value = Emission Level – Limit value
4. The other emission levels were very low against the limit.
5. " \* ": Fundamental frequency.
6. " # ": The radiated frequency is out of the restricted band.

<b>RF Mode</b>	TX 802.11ac (VHT80)	<b>Channel</b>	CH 155 : 5775 MHz
<b>Frequency Range</b>	1GHz ~ 40GHz	<b>Detector Function</b>	Peak (PK) Average (AV)

Antenna Polarity & Test Distance : Horizontal at 3 m								
No	Frequency (MHz)	Emission Level (dBuV/m)	Limit (dBuV/m)	Margin (dB)	Antenna Height (m)	Table Angle (Degree)	Raw Value (dBuV)	Correction Factor (dB/m)
1	#5638.40	58.8 PK	68.2	-9.4	1.07 H	307	55.9	2.9
2	#5650.00	60.0 PK	68.2	-8.2	1.07 H	307	56.9	3.1
3	*5775.00	99.4 PK			1.07 H	307	57.9	41.5
4	*5775.00	89.7 AV			1.07 H	307	48.2	41.5
5	#5925.00	59.6 PK	68.2	-8.6	1.07 H	307	55.8	3.8
6	#5936.80	59.6 PK	68.2	-8.6	1.07 H	307	55.9	3.7
7	11550.00	57.5 PK	74.0	-16.5	2.26 H	208	48.8	8.7
8	11550.00	44.9 AV	54.0	-9.1	2.26 H	208	36.2	8.7

Antenna Polarity & Test Distance : Vertical at 3 m								
No	Frequency (MHz)	Emission Level (dBuV/m)	Limit (dBuV/m)	Margin (dB)	Antenna Height (m)	Table Angle (Degree)	Raw Value (dBuV)	Correction Factor (dB/m)
1	#5648.40	65.7 PK	68.2	-2.5	2.25 V	288	62.7	3.0
2	#5650.00	66.4 PK	68.2	-1.8	2.25 V	288	63.3	3.1
3	*5775.00	110.7 PK			2.25 V	288	69.2	41.5
4	*5775.00	100.9 AV			2.25 V	288	59.4	41.5
5	#5925.00	67.4 PK	68.2	-0.8	2.25 V	288	63.6	3.8
6	#5931.60	66.6 PK	68.2	-1.6	2.25 V	288	62.9	3.7
7	11550.00	60.3 PK	74.0	-13.7	2.79 V	254	51.6	8.7
8	11550.00	48.0 AV	54.0	-6.0	2.79 V	254	39.3	8.7

**Remarks:**

1. Emission Level(dBuV/m) = Raw Value(dBuV) + Correction Factor(dB/m)
2. Correction Factor(dB/m) = Antenna Factor(dB/m) + Cable Factor(dB) – Pre-Amplifier Factor(dB)
3. Margin value = Emission Level – Limit value
4. The other emission levels were very low against the limit.
5. " \* ": Fundamental frequency.
6. " # ": The radiated frequency is out of the restricted band.

**9 kHz ~ 30 MHz Data:**

The amplitude of spurious emissions attenuated more than 20 dB below the permissible value is not required to be report.

**30 MHz ~ 1 GHz Worst-Case Data:**

**802.11ac (VHT20)**

<b>RF Mode</b>	TX 802.11ac (VHT20)	<b>Channel</b>	CH 64 : 5320 MHz
<b>Frequency Range</b>	30MHz ~ 1GHz	<b>Detector Function</b>	Quasi-Peak (QP)

Antenna Polarity & Test Distance : Horizontal at 3 m								
No	Frequency (MHz)	Emission Level (dBuV/m)	Limit (dBuV/m)	Margin (dB)	Antenna Height (m)	Table Angle (Degree)	Raw Value (dBuV)	Correction Factor (dB/m)
1	124.19	20.6 QP	43.5	-22.9	1.99 H	146	40.7	-20.1
2	167.77	22.5 QP	43.5	-21.0	1.49 H	52	40.9	-18.4
3	263.36	27.7 QP	46.0	-18.3	1.00 H	173	46.8	-19.1
4	311.16	25.0 QP	46.0	-21.0	1.00 H	189	42.3	-17.3
5	398.32	24.7 QP	46.0	-21.3	1.00 H	2	40.0	-15.3
6	526.25	23.4 QP	46.0	-22.6	1.99 H	86	35.7	-12.3

**Remarks:**

1. Emission Level(dBuV/m) = Raw Value(dBuV) + Correction Factor(dB/m)
2. Correction Factor(dB/m) = Antenna Factor(dB/m) + Cable Factor(dB) – Pre-Amplifier Factor(dB)
3. Margin value = Emission Level – Limit value
4. The other emission levels were very low against the limit of frequency range 30MHz~1000MHz.
5. The emission levels were very low against the limit of frequency range 9kHz~30MHz: the amplitude of spurious emissions attenuated more than 20 dB below the permissible value to be report.

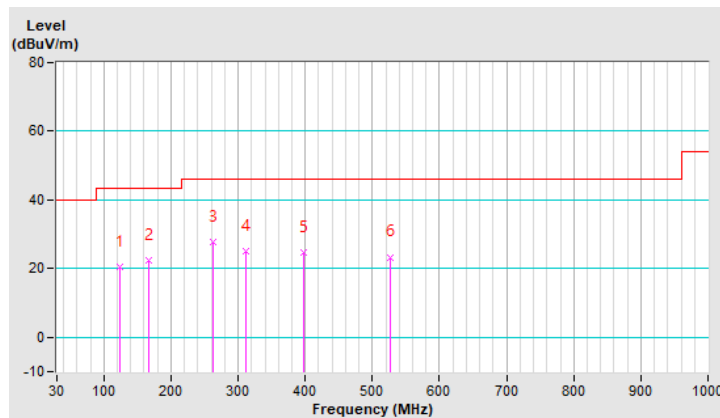

<b>RF Mode</b>	TX 802.11ac (VHT20)	<b>Channel</b>	CH 64 : 5320 MHz
<b>Frequency Range</b>	30MHz ~ 1GHz	<b>Detector Function</b>	Quasi-Peak (QP)

Antenna Polarity & Test Distance : Vertical at 3 m								
No	Frequency (MHz)	Emission Level (dBuV/m)	Limit (dBuV/m)	Margin (dB)	Antenna Height (m)	Table Angle (Degree)	Raw Value (dBuV)	Correction Factor (dB/m)
1	48.28	21.2 QP	40.0	-18.8	1.01 V	232	39.3	-18.1
2	79.20	22.7 QP	40.0	-17.3	1.51 V	247	45.6	-22.9
3	142.46	22.2 QP	43.5	-21.3	1.01 V	359	40.7	-18.5
4	263.36	22.7 QP	46.0	-23.3	2.00 V	144	41.8	-19.1
5	371.61	29.5 QP	46.0	-16.5	1.01 V	228	45.3	-15.8
6	455.96	22.8 QP	46.0	-23.2	1.01 V	175	36.3	-13.5

**Remarks:**

1. Emission Level(dBuV/m) = Raw Value(dBuV) + Correction Factor(dB/m)
2. Correction Factor(dB/m) = Antenna Factor(dB/m) + Cable Factor(dB) – Pre-Amplifier Factor(dB)
3. Margin value = Emission Level – Limit value
4. The other emission levels were very low against the limit of frequency range 30MHz~1000MHz.
5. The emission levels were very low against the limit of frequency range 9kHz~30MHz: the amplitude of spurious emissions attenuated more than 20 dB below the permissible value to be report.

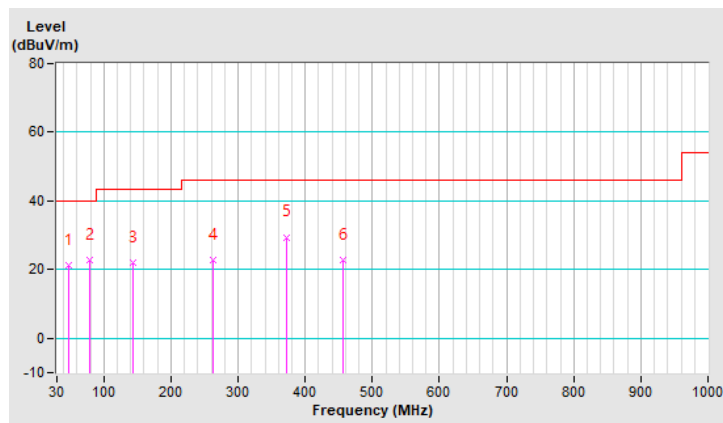

## 4.2 Conducted Emission Measurement

### 4.2.1 Limits of Conducted Emission Measurement

Frequency (MHz)	Conducted Limit (dBuV)	
	Quasi-Peak	Average
0.15 - 0.5	66 - 56	56 - 46
0.50 - 5.0	56	46
5.0 - 30.0	60	50

- Note: 1. The lower limit shall apply at the transition frequencies.  
 2. The limit decreases in line with the logarithm of the frequency in the range of 0.15 to 0.50 MHz.

### 4.2.2 Test Instruments

Description & Manufacturer	Model No.	Serial No.	Date of Calibration	Due Date of Calibration
Test Receiver ROHDE & SCHWARZ	ESR3	102783	Dec. 21, 2020	Dec. 20, 2021
RF signal cable (with 10dB PAD) Woken	5D-FB	Cable-cond2-01	Sep. 04, 2021	Sep. 03, 2022
LISN/AMN ROHDE & SCHWARZ (EUT)	ESH2-Z5	100100	Jan. 28, 2021	Jan. 27, 2022
LISN/AMN ROHDE & SCHWARZ (Peripheral)	ENV216	101196	Apr. 26, 2021	Apr. 25, 2022
Software ADT	BV ADT_Cond_ V7.3.7.4	NA	NA	NA

- Note: 1. The calibration interval of the above test instruments is 12 months and the calibrations are traceable to NML/ROC and NIST/USA.  
 2. The test was performed in HwaYa Shielded Room 2. (Conduction 2).  
 3. The VCCI Site Registration No. is C-12047.



#### 4.2.3 Test Procedures

- a. The EUT was placed 0.4 meters from the conducting wall of the shielded room with EUT being connected to the power mains through a line impedance stabilization network (LISN). Other support units were connected to the power mains through another LISN. The two LISNs provide 50 ohm/ 50uH of coupling impedance for the measuring instrument.
- b. Both lines of the power mains connected to the EUT were checked for maximum conducted interference.
- c. The frequency range from 150 kHz to 30 MHz was searched. Emission levels under (Limit -20 dB) was not recorded.

**Note:** All modes of operation were investigated and the worst-case emissions are reported.

#### 4.2.4 Deviation from Test Standard

No deviation.

#### 4.2.5 Test Setup

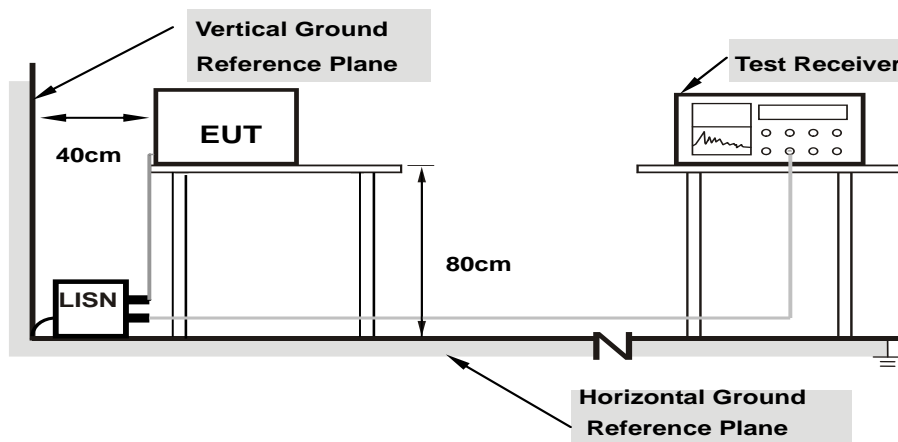

- Note:**
1. Support units were connected to second LISN.
  2. Both of LISNs (AMN) are 80 cm from EUT and at least 80 cm from other units and other metal planes

For the actual test configuration, please refer to the attached file (Test Setup Photo).

#### 4.2.6 EUT Operating Conditions

- a. Placed the EUT on a testing table.
- b. Use the software to control the EUT under transmission condition continuously at specific channel frequency.

#### 4.2.7 Test Results

<b>Frequency Range</b>	150kHz ~ 30MHz	<b>Detector Function &amp; Resolution Bandwidth</b>	Quasi-Peak (QP) / Average (AV), 9kHz
<b>Input Power</b>	120Vac, 60Hz	<b>Environmental Conditions</b>	25 °C, 75% RH
<b>Tested by</b>	Rex Wang	<b>Test Date</b>	2021/9/11

Phase Of Power : Line (L)										
No	Frequency (MHz)	Correction Factor (dB)	Reading Value (dBuV)		Emission Level (dBuV)		Limit (dBuV)		Margin (dB)	
			Q.P.	AV.	Q.P.	AV.	Q.P.	AV.	Q.P.	AV.
1	0.26200	10.13	12.42	3.19	22.55	13.32	61.37	51.37	-38.82	-38.05
2	0.39342	10.14	19.66	3.54	29.80	13.68	57.99	47.99	-28.19	-34.31
3	0.62200	10.15	8.92	1.91	19.07	12.06	56.00	46.00	-36.93	-33.94
4	1.19400	10.18	7.15	0.04	17.33	10.22	56.00	46.00	-38.67	-35.78
5	4.08600	10.24	7.36	1.27	17.60	11.51	56.00	46.00	-38.40	-34.49
6	19.20200	10.47	11.94	3.74	22.41	14.21	60.00	50.00	-37.59	-35.79

**Remarks:**

1. Q.P. and AV. are abbreviations of quasi-peak and average individually.
2. The emission levels of other frequencies were very low against the limit.
3. Margin value = Emission level – Limit value
4. Correction factor = Insertion loss + Cable loss
5. Emission Level = Correction Factor + Reading Value

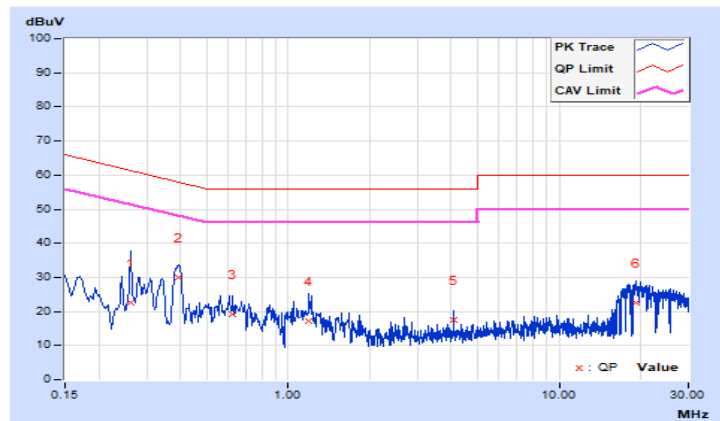

<b>Frequency Range</b>	150kHz ~ 30MHz	<b>Detector Function &amp; Resolution Bandwidth</b>	Quasi-Peak (QP) / Average (AV), 9kHz
<b>Input Power</b>	120Vac, 60Hz	<b>Environmental Conditions</b>	25 °C, 75% RH
<b>Tested by</b>	Rex Wang	<b>Test Date</b>	2021/9/11

Phase Of Power : Neutral (N)										
No	Frequency (MHz)	Correction Factor (dB)	Reading Value (dBuV)		Emission Level (dBuV)		Limit (dBuV)		Margin (dB)	
			Q.P.	AV.	Q.P.	AV.	Q.P.	AV.	Q.P.	AV.
1	0.15400	10.12	22.04	6.28	32.16	16.40	65.78	55.78	-33.62	-39.38
2	0.20200	10.13	20.42	8.72	30.55	18.85	63.53	53.53	-32.98	-34.68
<b>3</b>	<b>0.39800</b>	<b>10.15</b>	<b>22.48</b>	<b>7.32</b>	<b>32.63</b>	<b>17.47</b>	<b>57.90</b>	<b>47.90</b>	<b>-25.27</b>	<b>-30.43</b>
4	1.18600	10.19	7.65	0.05	17.84	10.24	56.00	46.00	-38.16	-35.76
5	7.77800	10.37	6.97	3.52	17.34	13.89	60.00	50.00	-42.66	-36.11
6	18.21800	10.63	9.80	4.39	20.43	15.02	60.00	50.00	-39.57	-34.98

**Remarks:**

1. Q.P. and AV. are abbreviations of quasi-peak and average individually.
2. The emission levels of other frequencies were very low against the limit.
3. Margin value = Emission level – Limit value
4. Correction factor = Insertion loss + Cable loss
5. Emission Level = Correction Factor + Reading Value

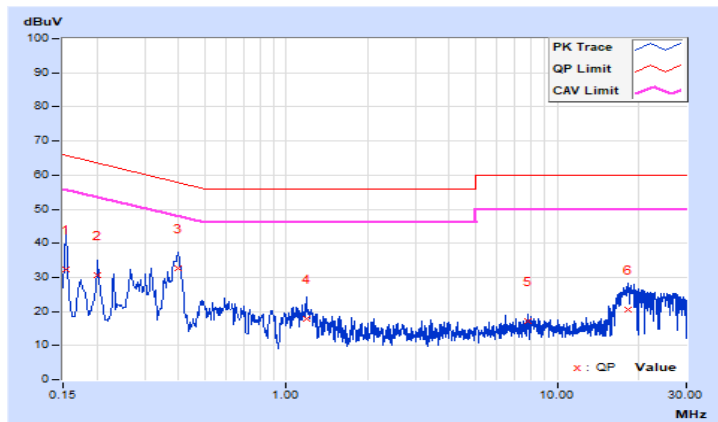

### 4.3 Transmit Power Measurement

#### 4.3.1 Limits of Transmit Power Measurement

Operation Band	EUT Category		Limit
U-NII-1		Outdoor Access Point	1 Watt (30 dBm) (Max. e.i.r.p $\leq$ 125 mW (21 dBm) at any elevation angle above 30 degrees as measured from the horizon)
		Fixed point-to-point Access Point	1 Watt (30 dBm)
		Indoor Access Point	1 Watt (30 dBm)
	√	Mobile and Portable client device	250 mW (24 dBm)
U-NII-2A		√	250 mW (24 dBm) or 11 dBm + 10 log B*
U-NII-2C		√	250 mW (24 dBm) or 11 dBm + 10 log B*
U-NII-3		√	1 Watt (30 dBm)

\*B is the 26 dB emission bandwidth in megahertz

Per KDB 662911 Method of conducted output power measurement on IEEE 802.11 devices,

Array Gain = 0 dB (i.e., no array gain) for  $N_{ANT} \leq 4$ ;

Array Gain = 0 dB (i.e., no array gain) for channel widths  $\geq 40$  MHz for any  $N_{ANT}$ ;

Array Gain =  $5 \log(N_{ANT}/N_{SS})$  dB or 3 dB, whichever is less for 20 MHz channel widths with  $N_{ANT} \geq 5$ .

For power measurements on all other devices: Array Gain =  $10 \log(N_{ANT}/N_{SS})$  dB.

#### 4.3.2 Test Setup

##### <Power Output Measurement>

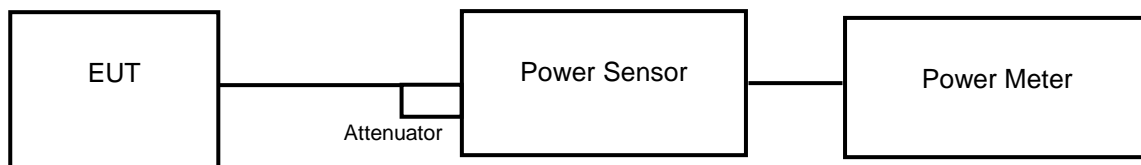

or

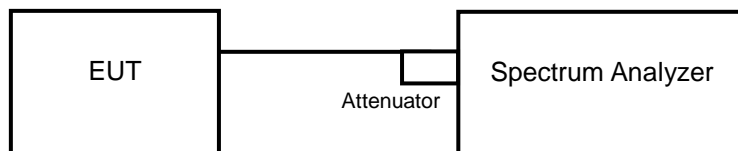

##### <26 dB Bandwidth>

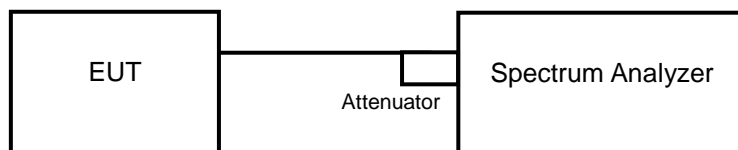

#### 4.3.3 Test Instruments

Refer to section 4.1.2 to get information of above instrument.

#### 4.3.4 Test Procedure

##### **Average Power Measurement**

Method PM is used to perform output power measurement, trigger and gating function of wide band power meter is enabled to measure max output power of TX on burst. Duty factor is not added to measured value.

##### **For channel straddling 5725 MHz**

Follow FCC KDB 789033 UNII test procedure:

Method SA-1

- a. Set span to encompass the entire emission bandwidth (EBW) of the signal.
- b. Set RBW = 1 MHz.
- c. Set VBW  $\geq 3 \times$  RBW.
- d. Number of points in sweep  $\geq 2$  Span / RBW.
- e. Sweep time = auto.
- f. Set trigger to free run (duty cycle  $\geq 98$  percent)
- g. Detector = RMS.
- h. Trace average at least 100 traces in power averaging mode.
- i. Compute power by integrating the spectrum across the 26 dB EBW of the signal.

##### **26 dB Bandwidth**

- a. Set RBW = approximately 1 % of the emission bandwidth.
- b. Set the VBW  $\geq 3 \times$  RBW.
- c. Detector = Peak.
- d. Trace mode = max hold.
- e. Measure the maximum width of the emission that is 26 dB down from the peak of the emission. Compare this with the RBW setting of the analyzer. Readjust RBW and repeat measurement as needed until the RBW/EBW ratio is approximately 1 %.

#### 4.3.5 Deviation from Test Standard

No deviation.

#### 4.3.6 EUT Operating Conditions

The software provided by client to enable the EUT under transmission condition continuously at lowest, middle and highest channel frequencies individually.

4.3.7 Test Results

**Power Output:**

**802.11a**

Channel	Frequency (MHz)	Maximum Conducted Power (mW)	Maximum Conducted Power (dBm)	Power Limit (dBm)	Pass / Fail
36	5180	41.115	16.14	23.89	Pass
40	5200	40.926	16.12	23.89	Pass
48	5240	40.179	16.04	23.89	Pass
52	5260	39.628	15.98	23.89	Pass
60	5300	39.174	15.93	23.89	Pass
64	5320	41.21	16.15	23.89	Pass
100	5500	37.239	15.71	23.89	Pass
116	5580	65.464	18.16	23.89	Pass
140	5700	81.47	19.11	23.89	Pass
144	5720 (U-NII-2C)	84.723	19.28	23.89	Pass
144	5720 (U-NII-3)	17.100	12.33	29.89	Pass
149	5745	93.972	19.73	29.89	Pass
157	5785	76.208	18.82	29.89	Pass
165	5825	68.077	18.33	29.89	Pass

**Note:**

1.5180~5720MHz (U-NII-2C): Max. Gain = 6.11dBi > 6dBi, so the power limit shall be reduced to 24-(6.11-6) = 23.89dBm.

2.5720 MHz (U-NII-3) ~5825 MHz: Max. Gain = 6.11dBi > 6dBi, so the power limit shall be reduced to 30-(6.11-6) = 29.89dBm.

**For U-NII-2A, U-NII-2C Band:**

1. 11 dBm + 10log (23.46) = 24.70 dBm > 24 dBm.
2. 11 dBm + 10log (24.64) = 24.91 dBm > 24 dBm.
3. 11 dBm + 10log (25.72) = 25.10 dBm > 24 dBm.
4. 11 dBm + 10log (24.19) = 24.83 dBm > 24 dBm.
5. 11 dBm + 10log (26.17) = 25.17 dBm > 24 dBm.
6. 11 dBm + 10log (28.34) = 25.52 dBm > 24 dBm.
7. 11 dBm + 10log (21.45) = 24.31 dBm > 24 dBm.

**802.11ac (VHT20)**

Channel	Frequency (MHz)	Maximum Conducted Power (mW)	Maximum Conducted Power (dBm)	Power Limit (dBm)	Pass / Fail
36	5180	43.251	16.36	23.89	Pass
40	5200	43.451	16.38	23.89	Pass
48	5240	42.56	16.29	23.89	Pass
52	5260	41.495	16.18	23.89	Pass
60	5300	43.551	16.39	23.89	Pass
64	5320	42.855	16.32	23.89	Pass
100	5500	39.264	15.94	23.89	Pass
116	5580	69.024	18.39	23.89	Pass
140	5700	59.02	17.71	23.89	Pass
144	5720 (U-NII-2C)	81.096	19.09	23.89	Pass
144	5720 (U-NII-3)	18.836	12.75	29.89	Pass
149	5745	88.105	19.45	29.89	Pass
157	5785	101.391	20.06	29.89	Pass
165	5825	95.06	19.78	29.89	Pass

**Note:**

1.5180~5720MHz (U-NII-2C): Max. Gain = 6.11dBi > 6dBi, so the power limit shall be reduced to  $24 - (6.11 - 6) = 23.89\text{dBm}$ .

2.5720 MHz (U-NII-3) ~5825 MHz: Max. Gain = 6.11dBi > 6dBi, so the power limit shall be reduced to  $30 - (6.11 - 6) = 29.89\text{dBm}$ .

**For U-NII-2A, U-NII-2C Band:**

1.  $11\text{ dBm} + 10\log(25.79) = 25.11\text{ dBm} > 24\text{ dBm}$ .
2.  $11\text{ dBm} + 10\log(26.34) = 25.20\text{ dBm} > 24\text{ dBm}$ .
3.  $11\text{ dBm} + 10\log(26.58) = 25.24\text{ dBm} > 24\text{ dBm}$ .
4.  $11\text{ dBm} + 10\log(26.32) = 25.20\text{ dBm} > 24\text{ dBm}$ .
5.  $11\text{ dBm} + 10\log(27.37) = 25.37\text{ dBm} > 24\text{ dBm}$ .
6.  $11\text{ dBm} + 10\log(26.96) = 25.30\text{ dBm} > 24\text{ dBm}$ .
7.  $11\text{ dBm} + 10\log(23.03) = 24.62\text{ dBm} > 24\text{ dBm}$ .

### 802.11ac (VHT40)

Channel	Frequency (MHz)	Maximum Conducted Power (mW)	Maximum Conducted Power (dBm)	Power Limit (dBm)	Pass / Fail
38	5190	35.318	15.48	23.89	Pass
46	5230	48.641	16.87	23.89	Pass
54	5270	46.559	16.68	23.89	Pass
62	5310	48.529	16.86	23.89	Pass
102	5510	31.769	15.02	23.89	Pass
110	5550	72.111	18.58	23.89	Pass
134	5670	74.645	18.73	23.89	Pass
142	5710 (U-NII-2C)	94.406	19.75	23.89	Pass
142	5710 (U-NII-3)	7.047	8.48	29.89	Pass
151	5755	118.032	20.72	29.89	Pass
159	5795	100.231	20.01	29.89	Pass

**Note:**

1.5190~5710MHz (U-NII-2C): Max. Gain = 6.11dBi > 6dBi, so the power limit shall be reduced to  $24 - (6.11 - 6) = 23.89$ dBm.

2.5710 MHz (U-NII-3) ~5795 MHz: Max. Gain = 6.11dBi > 6dBi, so the power limit shall be reduced to  $30 - (6.11 - 6) = 29.89$ dBm.

**For U-NII-2A, U-NII-2C Band:**

- $11 \text{ dBm} + 10\log(42.53) = 27.28 \text{ dBm} > 24 \text{ dBm}$ .
- $11 \text{ dBm} + 10\log(42.66) = 27.30 \text{ dBm} > 24 \text{ dBm}$ .
- $11 \text{ dBm} + 10\log(42.53) = 27.28 \text{ dBm} > 24 \text{ dBm}$ .
- $11 \text{ dBm} + 10\log(42.38) = 27.27 \text{ dBm} > 24 \text{ dBm}$ .
- $11 \text{ dBm} + 10\log(42.90) = 27.32 \text{ dBm} > 24 \text{ dBm}$ .
- $11 \text{ dBm} + 10\log(52.63) = 28.21 \text{ dBm} > 24 \text{ dBm}$ .

### 802.11ac (VHT80)

Channel	Frequency (MHz)	Maximum Conducted Power (mW)	Maximum Conducted Power (dBm)	Power Limit (dBm)	Pass / Fail
42	5210	26.853	14.29	23.89	Pass
58	5290	31.046	14.92	23.89	Pass
106	5530	20.184	13.05	23.89	Pass
138	5690 (U-NII-2C)	105.925	20.25	23.89	Pass
138	5690 (U-NII-3)	3.221	5.08	29.89	Pass
155	5775	77.804	18.91	29.89	Pass

**Note:**

1.5210~5690MHz (U-NII-2C): Max. Gain = 6.11dBi > 6dBi, so the power limit shall be reduced to  $24 - (6.11 - 6) = 23.89$ dBm.

2.5690 MHz (U-NII-3) ~5775 MHz: Max. Gain = 6.11dBi > 6dBi, so the power limit shall be reduced to  $30 - (6.11 - 6) = 29.89$ dBm.

**For U-NII-2A, U-NII-2C Band:**

- $11 \text{ dBm} + 10\log(84.79) = 30.28 \text{ dBm} > 24 \text{ dBm}$ .
- $11 \text{ dBm} + 10\log(83.97) = 30.24 \text{ dBm} > 24 \text{ dBm}$ .
- $11 \text{ dBm} + 10\log(127.25) = 32.04 \text{ dBm} > 24 \text{ dBm}$ .



### Straddle channel power plots:

#### 802.11a

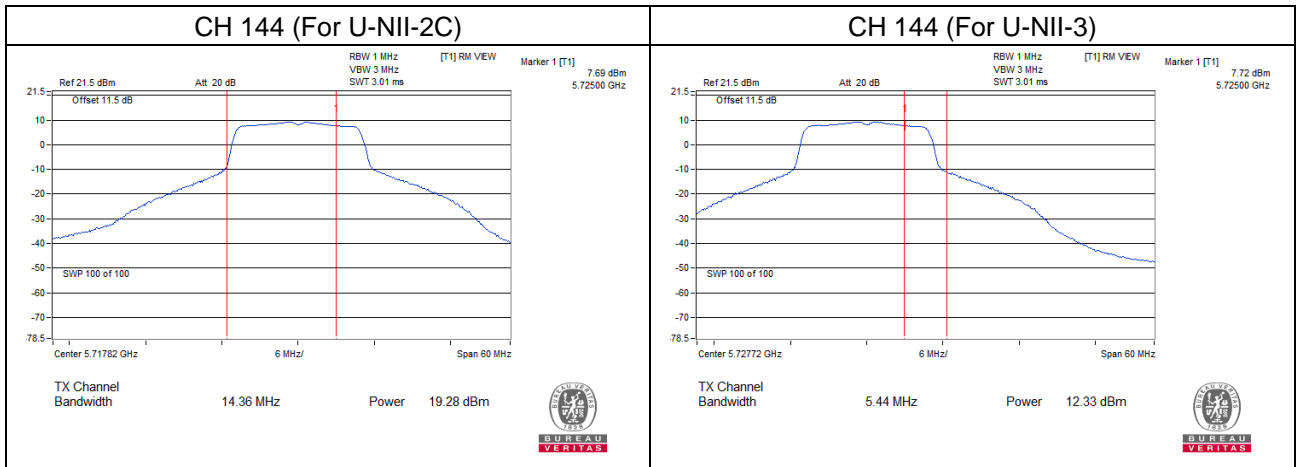

#### 802.11ac (VHT20)

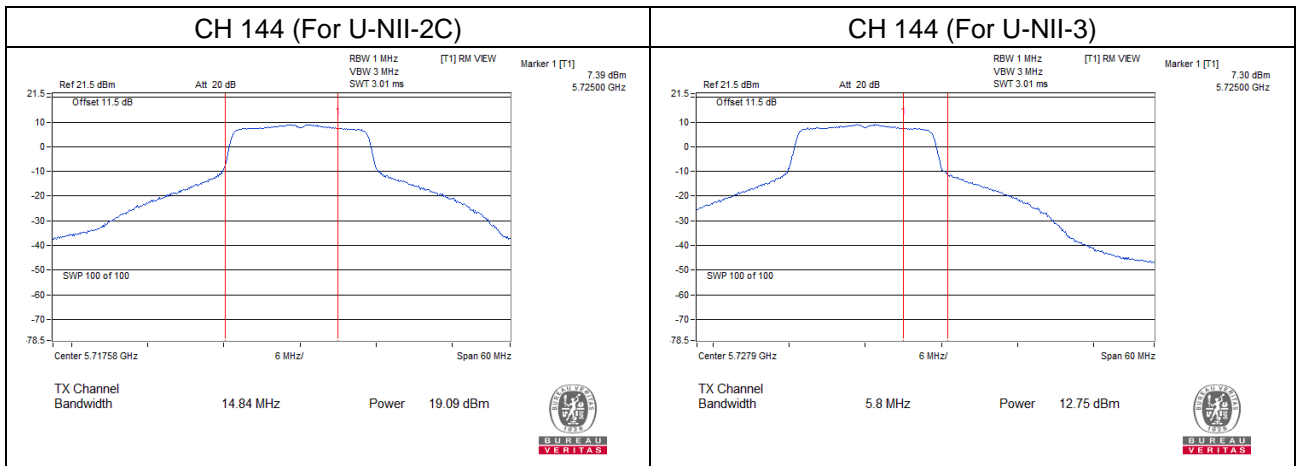

#### 802.11ac (VHT40)

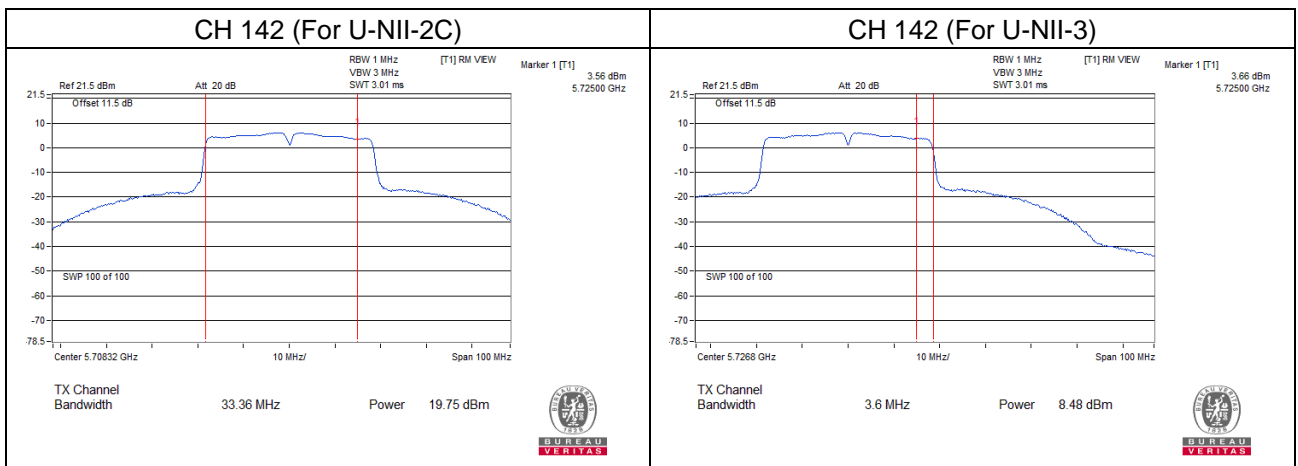

802.11ac (VHT80)

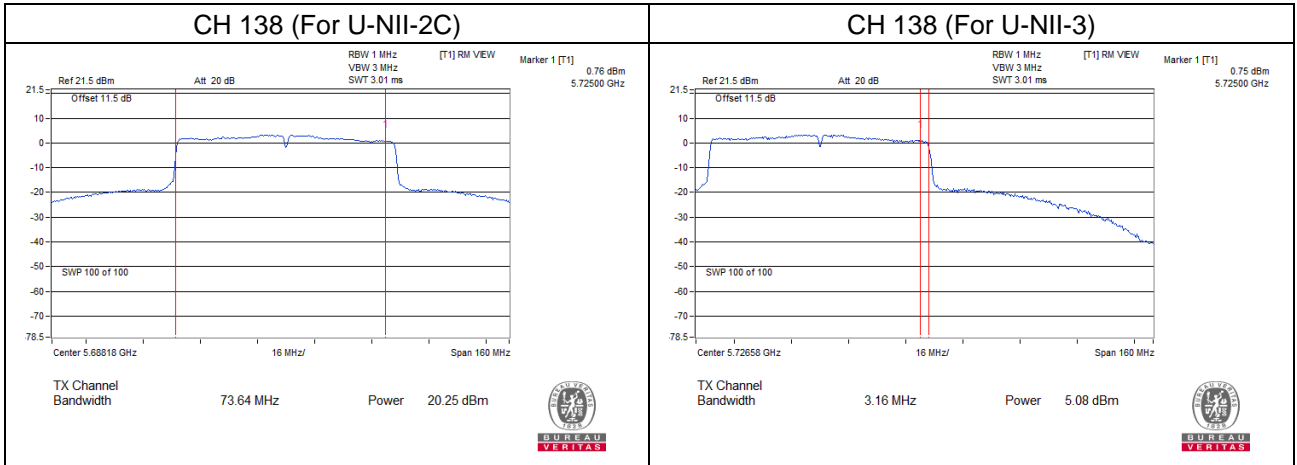

**26 dB Bandwidth:**
**802.11a**

Channel	Frequency (MHz)	26 dBc Bandwidth (MHz)
36	5180	25.16
40	5200	24.32
48	5240	24.65
52	5260	23.46
60	5300	24.64
64	5320	25.72
100	5500	24.19
116	5580	26.17
140	5700	28.34
144	5720 (U-NII-2C)	21.45
144	5720 (U-NII-3)	13.19

**802.11 ac (VHT20)**

Channel	Frequency (MHz)	26 dBc Bandwidth (MHz)
36	5180	25.33
40	5200	25.29
48	5240	25.48
52	5260	25.79
60	5300	26.34
64	5320	26.58
100	5500	26.32
116	5580	27.37
140	5700	26.96
144	5720 (U-NII-2C)	23.03
144	5720 (U-NII-3)	13.86

### 802.11 ac (VHT40)

Channel	Frequency (MHz)	26 dBc Bandwidth (MHz)
38	5190	42.67
46	5230	42.42
54	5270	42.53
62	5310	42.66
102	5510	42.53
110	5550	42.38
134	5670	42.90
142	5710 (U-NII-2C)	52.63
142	5710 (U-NII-3)	23.61

### 802.11ac (VHT80)

Channel	Frequency (MHz)	26 dBc Bandwidth (MHz)
42	5210	84.73
58	5290	84.79
106	5530	83.97
138	5690 (U-NII-2C)	127.25
138	5690 (U-NII-3)	53.18

### Spectrum Plot of Worst Value

#### 802.11a

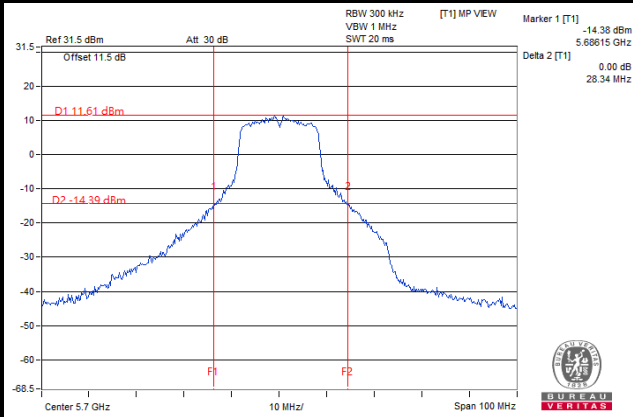

#### 802.11 ac (VHT20)

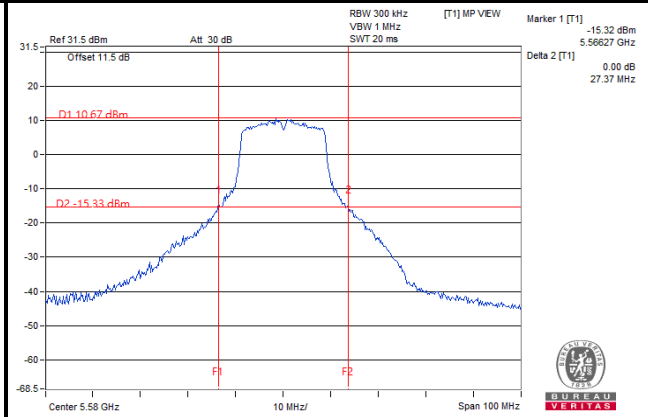

#### 802.11 ac (VHT40)

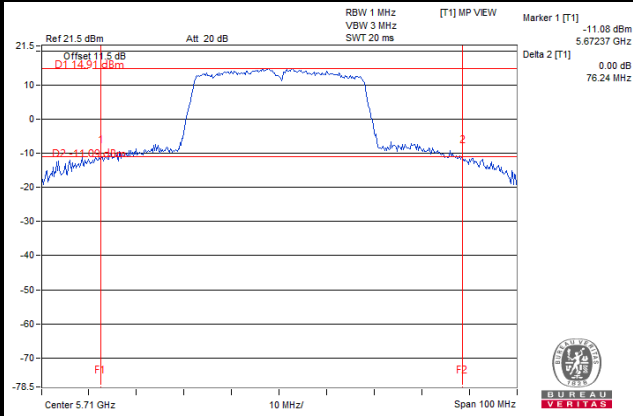

#### 802.11ac (VHT80)

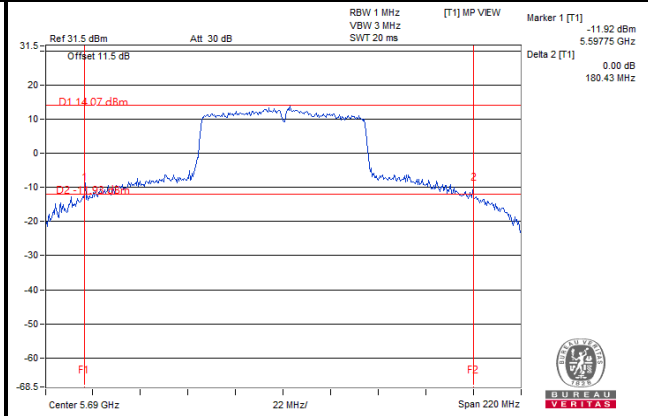

## EUT MAXIMUM CONDUCTED POWER

### 802.11a

Frequency Band (MHz)	Max. Power	
	Output Power (mW)	Output Power (dBm)
5250~5350	41.21	16.15
5470~5725	84.723	19.28

### 802.11ac (VHT20)

Frequency Band (MHz)	Max. Power	
	Output Power (mW)	Output Power (dBm)
5250~5350	43.551	16.39
5470~5725	81.096	19.09

### 802.11ac (VHT40)

Frequency Band (MHz)	Max. Power	
	Output Power (mW)	Output Power (dBm)
5250~5350	48.529	16.86
5470~5725	94.406	19.75

### 802.11ac (VHT80)

Frequency Band (MHz)	Max. Power	
	Output Power (mW)	Output Power (dBm)
5250~5350	31.046	14.92
5470~5725	105.925	20.25

## 4.4 Occupied Bandwidth Measurement

### 4.4.1 Test Setup

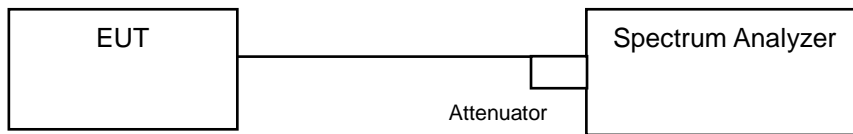

### 4.4.2 Test Instruments

Refer to section 4.1.2 to get information of above instrument.

### 4.4.3 Test Procedure

The transmitter output was connected to the spectrum analyzer through an attenuator. The bandwidth of the fundamental frequency was measured by spectrum analyzer with resolution bandwidth in the range of 1 % to 5 % of the anticipated emission bandwidth, and a video bandwidth at least 3x the resolution bandwidth and set the detector to SAMPLE. The width of a frequency band such that, below the lower and above the upper frequency limits, the mean powers emitted are each equal to a specified percentage 0.5 % of the total mean power of a given emission.

#### 4.4.4 Test Results

##### 802.11a

Channel	Channel Frequency (MHz)	Occupied Bandwidth (MHz)
36	5180	16.92
40	5200	16.80
48	5240	16.92
52	5260	16.92
60	5300	16.92
64	5320	16.92
100	5500	16.92
116	5580	16.92
140	5700	17.28
144	5720 (U-NII-2C)	14.72
144	5720 (U-NII-3)	5.80
149	5745	18.96
157	5785	17.76
165	5825	17.04

##### 802.11ac (VHT20)

Channel	Channel Frequency (MHz)	Occupied Bandwidth (MHz)
36	5180	18.00
40	5200	18.12
48	5240	18.00
52	5260	17.88
60	5300	18.12
64	5320	18.12
100	5500	18.00
116	5580	18.12
140	5700	18.00
144	5720 (U-NII-2C)	14.96
144	5720 (U-NII-3)	5.92
149	5745	19.32
157	5785	22.92
165	5825	21.72



### 802.11ac (VHT40)

Channel	Channel Frequency (MHz)	Occupied Bandwidth (MHz)
38	5190	36.60
46	5230	36.60
54	5270	36.48
62	5310	36.60
102	5510	36.60
110	5550	36.60
134	5670	36.72
142	5710 (U-NII-2C)	33.60
142	5710 (U-NII-3)	3.36
151	5755	38.40
159	5795	37.80

### 802.11ac (VHT80)

Channel	Channel Frequency (MHz)	Occupied Bandwidth (MHz)
42	5210	75.84
58	5290	75.84
106	5530	75.84
138	5690 (U-NII-2C)	73.64
138	5690 (U-NII-3)	3.40
155	5775	76.56

### Spectrum Plot of Worst Value

#### 802.11a

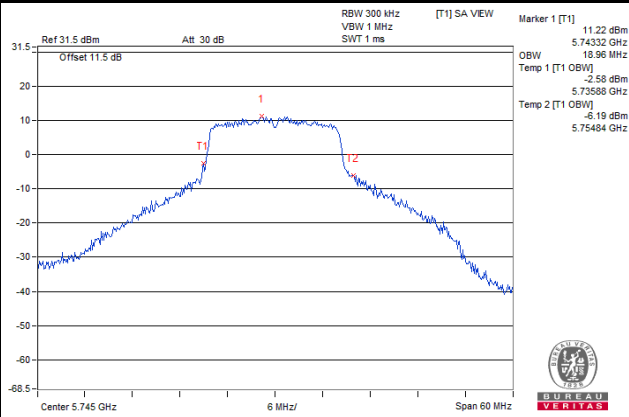

#### 802.11ac (VHT20)

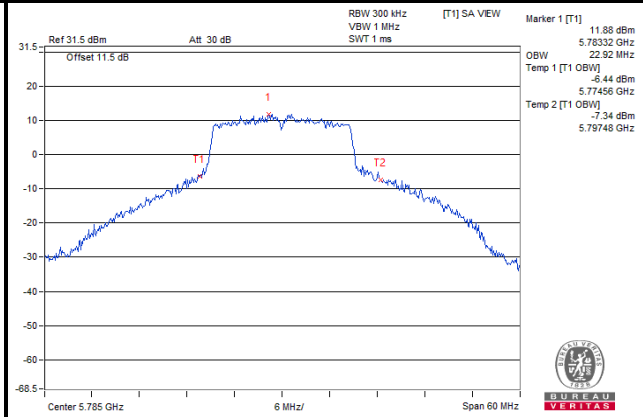

#### 802.11ac (VHT40)

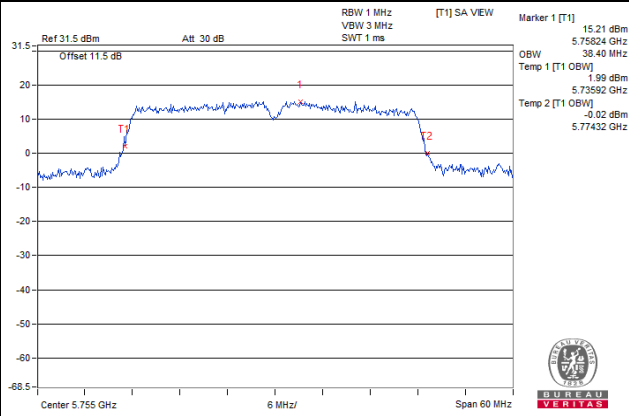

#### 802.11ac (VHT80)

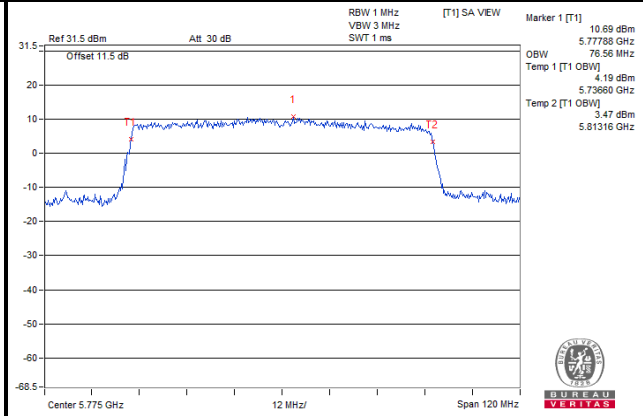

## Spectrum Plot for Nearby DFS Band 802.11a

### Ch 48 (5240 MHz)

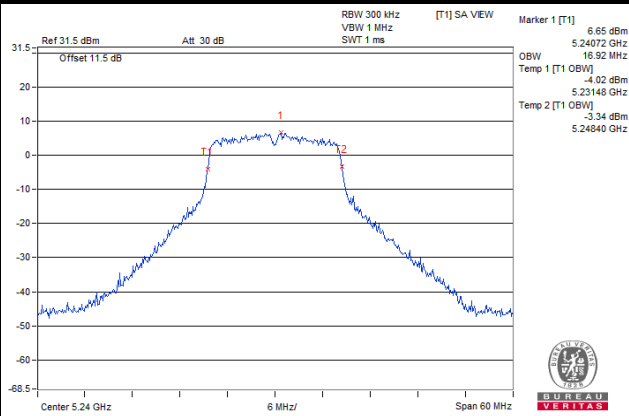

### Ch 149 (5745 MHz)

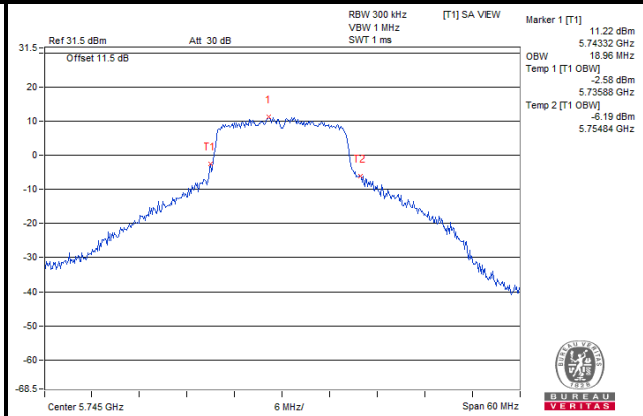

## 802.11ac (VHT20)

### Ch 48 (5240 MHz)

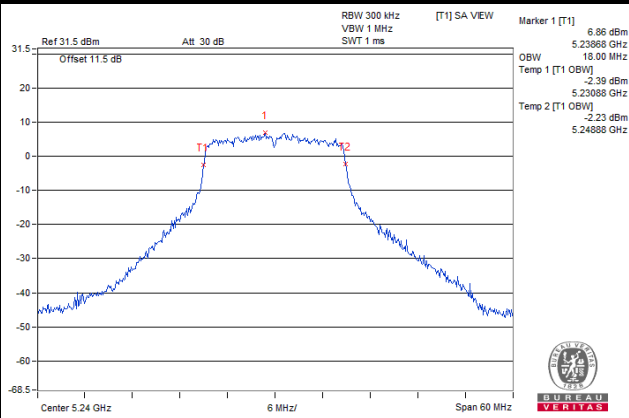

### Ch 149 (5745 MHz)

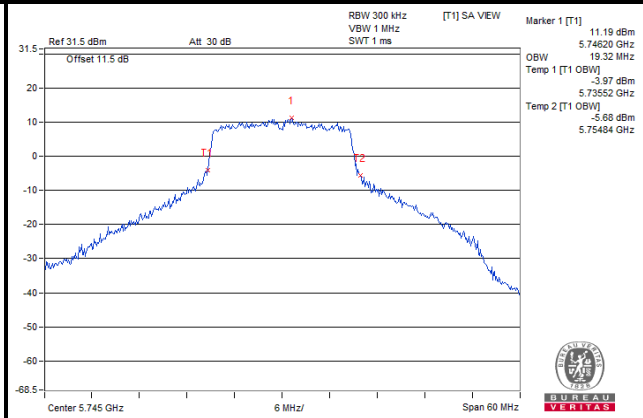

## 802.11ac (VHT40)

### Ch 46 (5230 MHz)

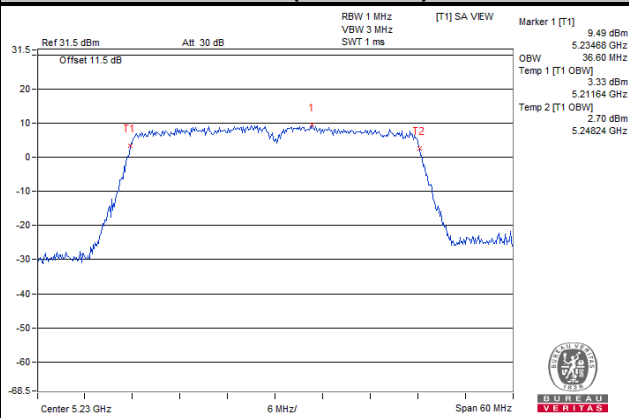

### Ch 151 (5755 MHz)

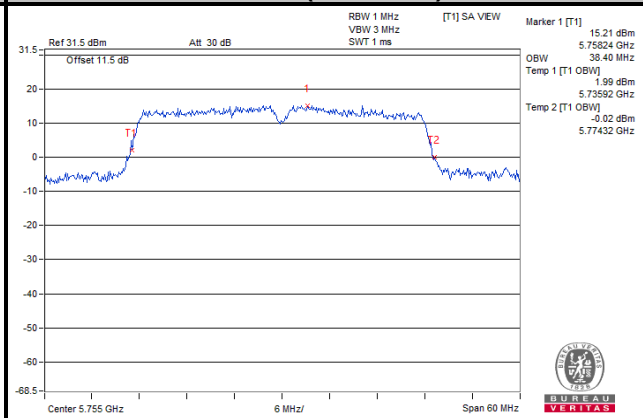

### 802.11ac (VHT80)

#### Ch 42 (5210 MHz)

#### Ch 155 (5775 MHz)

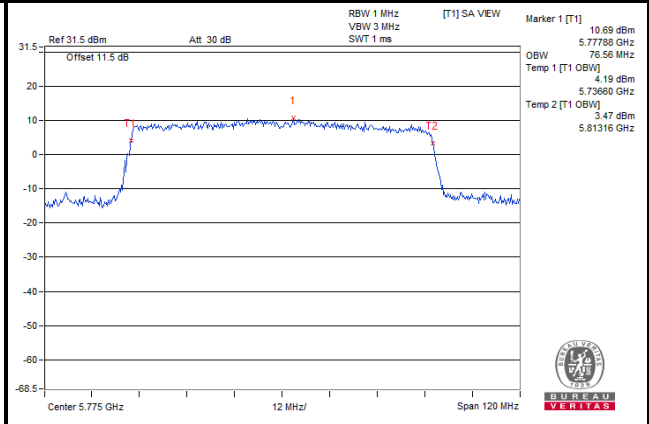
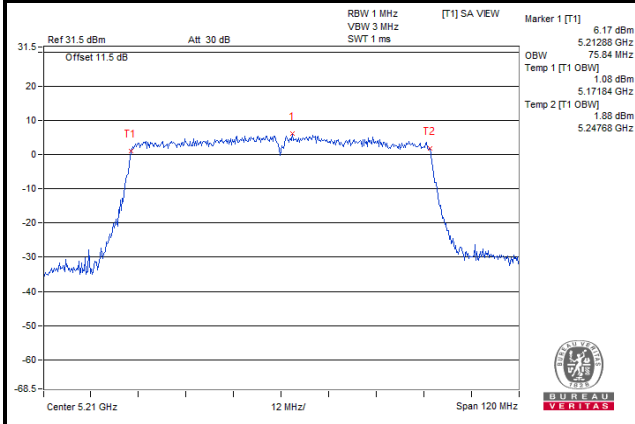

## 4.5 Peak Power Spectral Density Measurement

### 4.5.1 Limits of Peak Power Spectral Density Measurement

Operation Band	EUT Category		Limit
U-NII-1		Outdoor Access Point	17 dBm/MHz
		Fixed point-to-point Access Point	
		Indoor Access Point	
	√	Mobile and Portable client device	11 dBm/MHz
U-NII-2A		√	11 dBm/MHz
U-NII-2C		√	11 dBm/MHz
U-NII-3		√	30 dBm/500 kHz

### 4.5.2 Test Setup

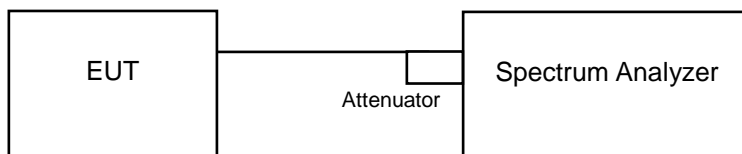

### 4.5.3 Test Instruments

Refer to section 4.1.2 to get information of above instrument.

### 4.5.4 Test Procedures

**For U-NII-1, U-NII-2A, U-NII-2C band:**

Using method SA-2 Duty cycle <98%

1. Set span to encompass the entire emission bandwidth (EBW) of the signal.
2. Set RBW = 1 MHz, Set VBW ≥ 3 RBW, Detector = RMS
3. Sweep time = auto, trigger set to "free run".
4. Trace average at least 100 traces in power averaging mode.
5. Record the max value and add 10 log (1/duty cycle)

※ For U-NII-3: with Duty cycle <98 %

1. Set span to encompass the entire emission bandwidth (EBW) of the signal.
2. Set RBW = 300 kHz, Set VBW  $\geq$  1 RBW, Detector = RMS
3. Use the peak marker function to determine the maximum power level in any 300 kHz band segment within the fundamental EBW.
4. Scale the observed power level to an equivalent value in 500 kHz by adjusting (increasing) the measured power by a bandwidth correction factor (BWCF) where  $BWCF = 10\log(500 \text{ kHz} / 300 \text{ kHz})$ .
5. Sweep time = auto, trigger set to "free run".
6. Trace average at least 100 traces in power averaging mode.
7. Record the max value and add  $10 \log (1/\text{duty cycle})$

#### 4.5.5 Deviation from Test Standard

No deviation.

#### 4.5.6 EUT Operating Conditions

The software provided by client to enable the EUT under transmission condition continuously at lowest, middle and highest channel frequencies individually.

#### 4.5.7 Test Results

#### For U-NII-1, U-NII-2A, U-NII-2C Band

#### 802.11a

Channel	Frequency (MHz)	PSD w/o Duty Factor (dBm/MHz)	Duty Factor (dB)	PSD with Duty Factor (dBm/MHz)	Maximum Limit (dBm/MHz)	Pass / Fail
36	5180	3.23	0.09	3.32	10.89	Pass
40	5200	3.22	0.09	3.31	10.89	Pass
48	5240	3.08	0.09	3.17	10.89	Pass
52	5260	2.98	0.09	3.07	10.89	Pass
60	5300	2.89	0.09	2.98	10.89	Pass
64	5320	3.08	0.09	3.17	10.89	Pass
100	5500	2.75	0.09	2.84	10.89	Pass
116	5580	5.05	0.09	5.14	10.89	Pass
140	5700	6.10	0.09	6.19	10.89	Pass
144	5720 (U-NII-2C)	7.19	0.09	7.28	10.89	Pass

#### Note:

- Method E) 2) a) of power density measurement of KDB 662911 is using for calculating total power density. Total power density is summing entire spectra across corresponding frequency bins on the various outputs by computer.
- Directional gain = 6.11 dBi > 6 dBi , so the power density limit shall be reduced to  $11 - (6.11 - 6) = 10.89$  dBm.
- Refer to section 3.3 for duty cycle spectrum plot.

### 802.11ac (VHT20)

Channel	Frequency (MHz)	PSD w/o Duty Factor (dBm/MHz)	Duty Factor (dB)	PSD with Duty Factor (dBm/MHz)	Maximum Limit (dBm/MHz)	Pass / Fail
36	5180	3.14	0.10	3.23	10.89	Pass
40	5200	3.18	0.10	3.28	10.89	Pass
48	5240	3.16	0.10	3.26	10.89	Pass
52	5260	3.09	0.10	3.18	10.89	Pass
60	5300	3.27	0.10	3.36	10.89	Pass
64	5320	3.30	0.10	3.39	10.89	Pass
100	5500	2.93	0.10	3.03	10.89	Pass
116	5580	5.30	0.10	5.40	10.89	Pass
140	5700	4.75	0.10	4.85	10.89	Pass
144	5720 (U-NII-2C)	7.26	0.10	7.36	10.89	Pass

**Note:**

- Method E) 2) a) of power density measurement of KDB 662911 is using for calculating total power density. Total power density is summing entire spectra across corresponding frequency bins on the various outputs by computer.
- Directional gain = 6.11 dBi > 6 dBi , so the power density limit shall be reduced to  $11 - (6.11 - 6) = 10.89$  dBm.
- Refer to section 3.3 for duty cycle spectrum plot.

### 802.11ac (VHT40)

Channel	Frequency (MHz)	PSD w/o Duty Factor (dBm/MHz)	Duty Factor (dB)	PSD with Duty Factor (dBm/MHz)	Maximum Limit (dBm/MHz)	Pass / Fail
38	5190	-0.24	0.18	-0.06	10.89	Pass
46	5230	1.02	0.18	1.20	10.89	Pass
54	5270	0.81	0.18	0.99	10.89	Pass
62	5310	1.13	0.18	1.31	10.89	Pass
102	5510	-1.07	0.18	-0.89	10.89	Pass
110	5550	2.37	0.18	2.55	10.89	Pass
134	5670	2.65	0.18	2.83	10.89	Pass
142	5710 (U-NII-2C)	4.04	0.18	4.22	10.89	Pass

**Note:**

- Method E) 2) a) of power density measurement of KDB 662911 is using for calculating total power density. Total power density is summing entire spectra across corresponding frequency bins on the various outputs by computer.
- Directional gain = 6.11 dBi > 6 dBi , so the power density limit shall be reduced to  $11 - (6.11 - 6) = 10.89$  dBm.
- Refer to section 3.3 for duty cycle spectrum plot.



### 802.11ac (VHT80)

Channel	Frequency (MHz)	PSD w/o Duty Factor (dBm/MHz)	Duty Factor (dB)	PSD with Duty Factor (dBm/MHz)	Maximum Limit (dBm/MHz)	Pass / Fail
42	5210	-4.64	0.33	-4.31	10.89	Pass
58	5290	-3.99	0.33	-3.66	10.89	Pass
106	5530	-6.06	0.33	-5.73	10.89	Pass
138	5690 (U-NII-2C)	1.99	0.33	2.32	10.89	Pass

**Note:**

- Method E) 2) a) of power density measurement of KDB 662911 is using for calculating total power density. Total power density is summing entire spectra across corresponding frequency bins on the various outputs by computer.
- Directional gain = 6.11 dBi > 6 dBi , so the power density limit shall be reduced to  $11 - (6.11 - 6) = 10.89$  dBm.
- Refer to section 3.3 for duty cycle spectrum plot.

### Spectrum Plot of Worst Value

#### 802.11a

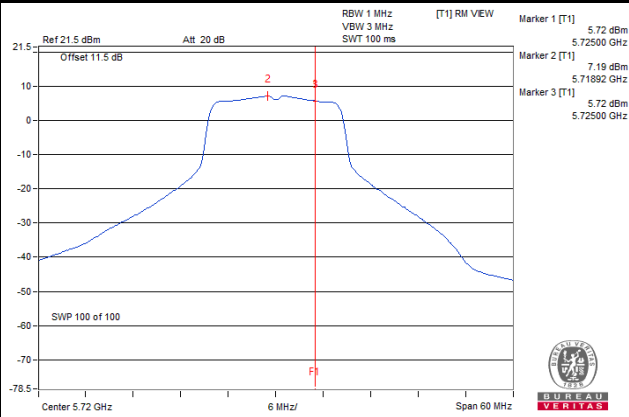

#### 802.11ac (VHT20)

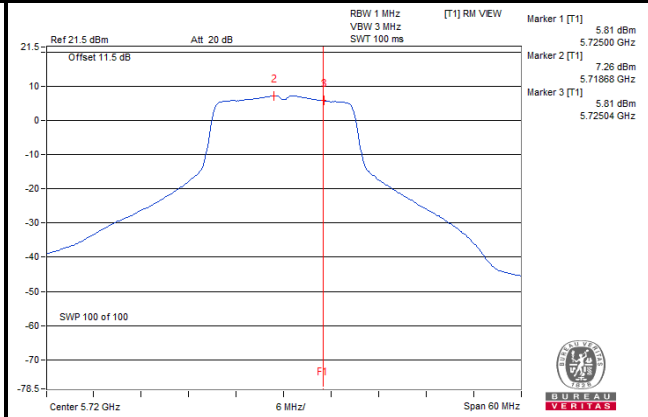

#### 802.11ac (VHT40)

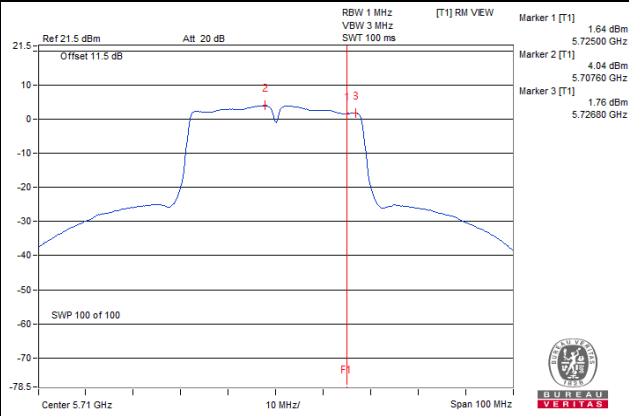

#### 802.11ac (VHT80)

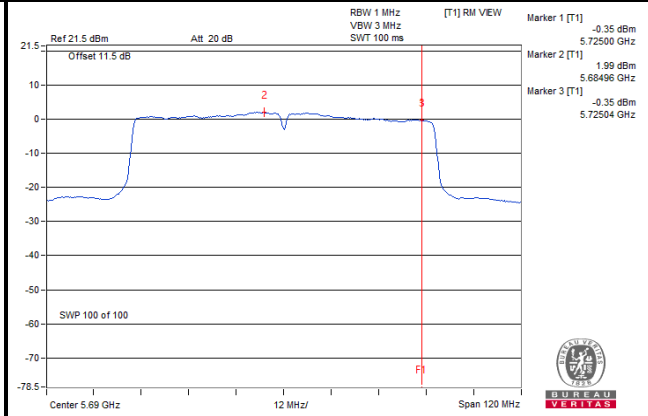

**For U-NII-3 Band**

**802.11a**

Channel	Frequency (MHz)	PSD w/o Duty Factor		Duty Factor (dB)	PSD with Duty Factor (dBm/500 kHz)	Limit (dBm/500 kHz)	Pass / Fail
		(dBm/300 kHz)	(dBm/500 kHz)				
144	5720 (U-NII-3)	0.44	2.66	0.09	2.75	29.89	Pass
149	5745	3.4	5.62	0.09	5.71	29.89	Pass
157	5785	2.55	4.77	0.09	4.86	29.89	Pass
165	5825	2.04	4.26	0.09	4.35	29.89	Pass

**Note:**

1. Method E) 2) c) of power density measurement of KDB 662911 is using for calculating total power density.
2. Directional gain = 6.11 dBi > 6 dBi, so the power density limit shall be reduced to  $30 - (6.11 - 6) = 29.89$  dBm.
3. Refer to section 3.3 for duty cycle spectrum plot.

**802.11ac (VHT20)**

Channel	Frequency (MHz)	PSD w/o Duty Factor		Duty Factor (dB)	PSD with Duty Factor (dBm/500 kHz)	Limit (dBm/500 kHz)	Pass / Fail
		(dBm/300 kHz)	(dBm/500 kHz)				
144	5720 (U-NII-3)	0.59	2.81	0.1	2.91	29.89	Pass
149	5745	3.04	5.26	0.1	5.36	29.89	Pass
157	5785	3.72	5.94	0.1	6.04	29.89	Pass
165	5825	3.63	5.85	0.1	5.95	29.89	Pass

**Note:**

1. Method E) 2) c) of power density measurement of KDB 662911 is using for calculating total power density.
2. Directional gain = 6.11 dBi > 6 dBi, so the power density limit shall be reduced to  $30 - (6.11 - 6) = 29.89$  dBm.
3. Refer to section 3.3 for duty cycle spectrum plot.

### 802.11ac (VHT40)

Channel	Frequency (MHz)	PSD w/o Duty Factor		Duty Factor (dB)	PSD with Duty Factor (dBm/500 kHz)	Limit (dBm/500 kHz)	Pass / Fail
		(dBm/300 kHz)	(dBm/500 kHz)				
142	5710 (U-NII-3)	-3.29	-1.07	0.18	-0.89	29.89	Pass
151	5755	1.47	3.69	0.18	3.87	29.89	Pass
159	5795	1.01	3.23	0.18	3.41	29.89	Pass

**Note:**

1. Method E) 2) c) of power density measurement of KDB 662911 is using for calculating total power density.
2. Directional gain = 6.11 dBi > 6 dBi, so the power density limit shall be reduced to  $30 - (6.11 - 6) = 29.89$  dBm.
3. Refer to section 3.3 for duty cycle spectrum plot.

### 802.11ac (VHT80)

Channel	Frequency (MHz)	PSD w/o Duty Factor		Duty Factor (dB)	PSD with Duty Factor (dBm/500 kHz)	Limit (dBm/500 kHz)	Pass / Fail
		(dBm/300 kHz)	(dBm/500 kHz)				
138	5690 (U-NII-3)	-5.23	-3.01	0.33	-2.68	29.89	Pass
155	5775	-0.68	1.54	0.33	1.87	29.89	Pass

**Note:**

1. Method E) 2) c) of power density measurement of KDB 662911 is using for calculating total power density.
2. Directional gain = 6.11 dBi > 6 dBi, so the power density limit shall be reduced to  $30 - (6.11 - 6) = 29.89$  dBm.
3. Refer to section 3.3 for duty cycle spectrum plot.

### Spectrum Plot of Worst Value

#### 802.11a

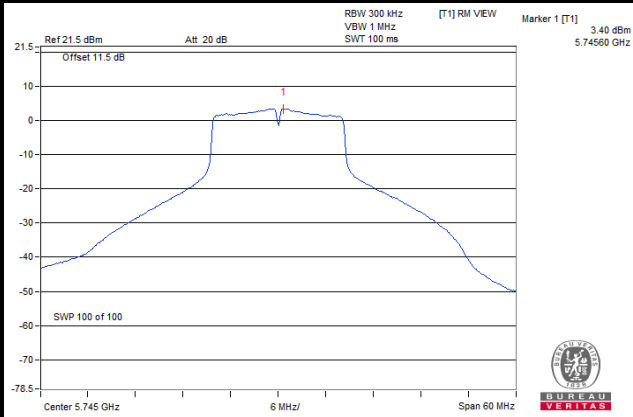

#### 802.11ac (VHT20)

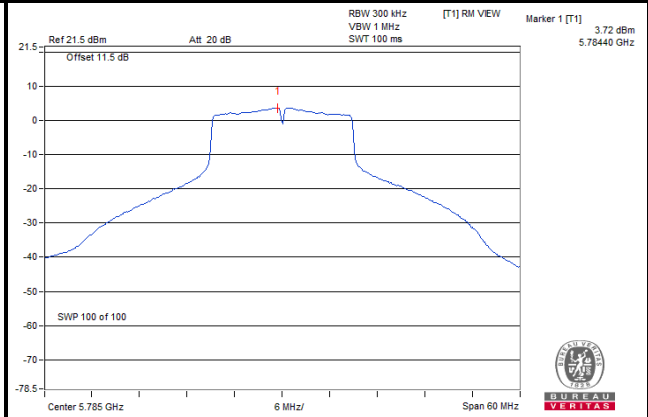

#### 802.11ac (VHT40)

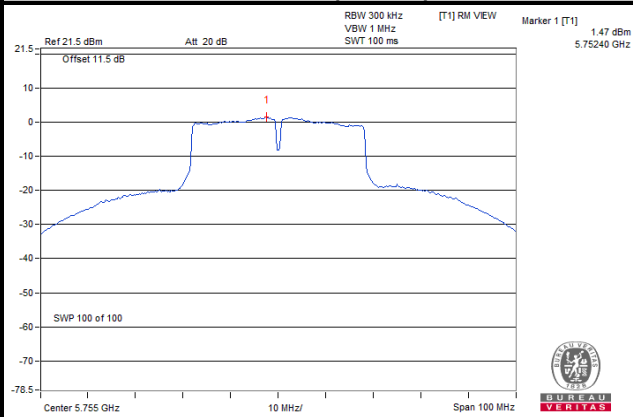

#### 802.11ac (VHT80)

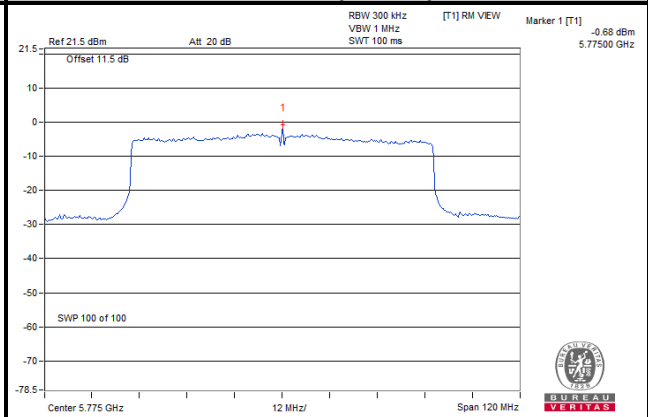

## 4.6 Frequency Stability

### 4.6.1 Limit of Frequency Stability Measurement

The frequency of the carrier signal shall be maintained within band of operation.

### 4.6.2 Test Setup

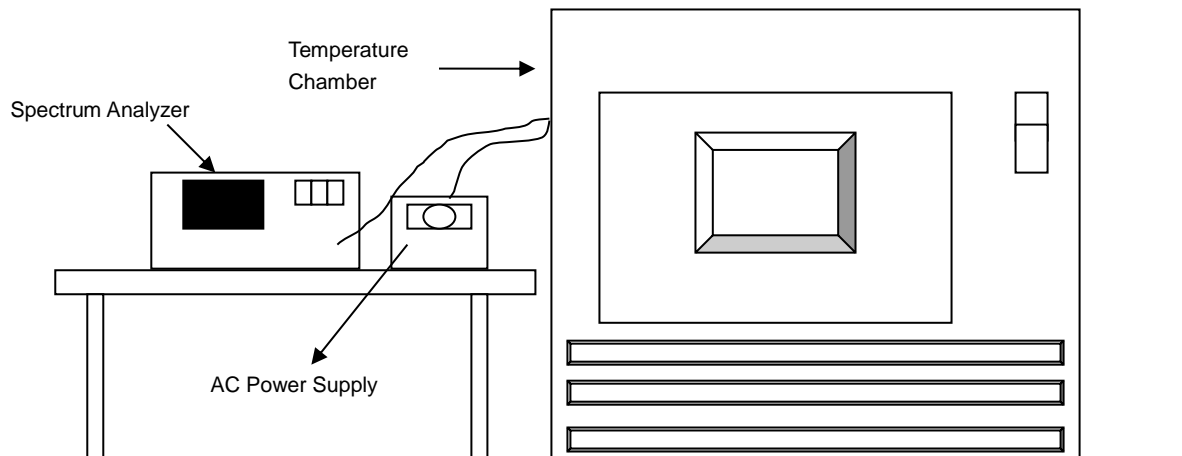

### 4.6.3 Test Instruments

Refer to section 4.1.2 to get information of above instrument.

### 4.6.4 Test Procedure

- The EUT was placed inside the environmental test chamber and powered by nominal AC voltage.
- Turn the EUT on and couple its output to a spectrum analyzer.
- Turn the EUT off and set the chamber to the highest temperature specified.
- Allow sufficient time (approximately 30 min) for the temperature of the chamber to stabilize, turn the EUT on and measure the operating frequency after 2, 5, and 10 Minutes.
- Repeat step (d) with the temperature chamber set to the next desired temperature until measurements down to the lowest specified temperature have been completed.
- The test chamber was allowed to stabilize at +20 degree C for a minimum of 30 Minutes. The supply voltage was then adjusted on the EUT from 85% to 115% and the frequency record.

### 4.6.5 Deviation from Test Standard

No deviation.

### 4.6.6 EUT Operating Condition

Set the EUT transmit at un-modulation mode to test frequency stability.

#### 4.6.7 Test Results

Frequency Stability Versus Temp.									
Operating Frequency: 5180 MHz									
Temp. (°C)	Power Supply (Vdc)	0 Minute		2 Minute		5 Minute		10 Minute	
		Measured Frequency (MHz)	Result	Measured Frequency (MHz)	Result	Measured Frequency (MHz)	Result	Measured Frequency (MHz)	Result
85	12	5179.9775	PASS	5179.9776	PASS	5179.9787	PASS	5179.9798	PASS
80	12	5179.9878	PASS	5179.9844	PASS	5179.9842	PASS	5179.9848	PASS
70	12	5179.9759	PASS	5179.9755	PASS	5179.9779	PASS	5179.9787	PASS
60	12	5180.0258	PASS	5180.0269	PASS	5180.0268	PASS	5180.0247	PASS
50	12	5180.0069	PASS	5180.0075	PASS	5180.0101	PASS	5180.0084	PASS
40	12	5179.9766	PASS	5179.9757	PASS	5179.9752	PASS	5179.9756	PASS
30	12	5179.9875	PASS	5179.9883	PASS	5179.9891	PASS	5179.9884	PASS
20	12	5180.0117	PASS	5180.015	PASS	5180.0118	PASS	5180.0138	PASS
10	12	5179.9975	PASS	5180.0024	PASS	5180.0021	PASS	5179.9991	PASS
0	12	5179.9848	PASS	5179.9829	PASS	5179.9849	PASS	5179.9848	PASS
-10	12	5179.9811	PASS	5179.9823	PASS	5179.9857	PASS	5179.9815	PASS
-20	12	5179.9992	PASS	5180.0011	PASS	5179.9998	PASS	5180.0032	PASS
-25	12	5180.0214	PASS	5180.0234	PASS	5180.0223	PASS	5180.0247	PASS

Frequency Stability Versus Voltage									
Operating Frequency: 5180 MHz									
Temp. (°C)	Power Supply (Vdc)	0 Minute		2 Minute		5 Minute		10 Minute	
		Measured Frequency (MHz)	Result	Measured Frequency (MHz)	Result	Measured Frequency (MHz)	Result	Measured Frequency (MHz)	Result
20	13.8	5180.0126	PASS	5180.016	PASS	5180.0123	PASS	5180.0129	PASS
	12	5180.0117	PASS	5180.015	PASS	5180.0118	PASS	5180.0138	PASS
	10.2	5180.0124	PASS	5180.016	PASS	5180.0111	PASS	5180.0139	PASS

## 4.7 6 dB Bandwidth Measurement

### 4.7.1 Limits of 6 dB Bandwidth Measurement

The minimum of 6 dB Bandwidth Measurement is 0.5 MHz.

### 4.7.2 Test Setup

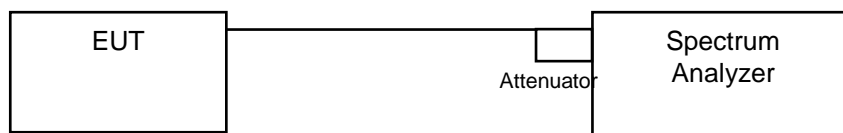

### 4.7.3 Test Instruments

Refer to section 4.1.2 to get information of above instrument.

### 4.7.4 Test Procedure

#### MEASUREMENT PROCEDURE REF

- Set resolution bandwidth (RBW) = 100 kHz
- Set the video bandwidth (VBW)  $\geq 3 \times$  RBW, Detector = Peak.
- Trace mode = max hold.
- Sweep = auto couple.
- Measure the maximum width of the emission that is constrained by the frequencies associated with the two amplitude points (upper and lower) that are attenuated by 6 dB relative to the maximum level measured in the fundamental emission

### 4.7.5 Deviation from Test Standard

No deviation.

### 4.7.6 EUT Operating Condition

The software provided by client to enable the EUT under transmission condition continuously at lowest, middle and highest channel frequencies individually.



#### 4.7.7 Test Results

##### 802.11a

Channel	Frequency (MHz)	6 dB Bandwidth (MHz)	Minimum Limit (MHz)	Pass / Fail
144	5720 (U-NII-3)	2.59	0.5	Pass
149	5745	15.68	0.5	Pass
157	5785	15.57	0.5	Pass
165	5825	16.07	0.5	Pass

##### 802.11ac (VHT20)

Channel	Frequency (MHz)	6 dB Bandwidth (MHz)	Minimum Limit (MHz)	Pass / Fail
144	5720 (U-NII-3)	3.15	0.5	Pass
149	5745	16.19	0.5	Pass
157	5785	16.34	0.5	Pass
165	5825	16.07	0.5	Pass

##### 802.11ac (VHT40)

Channel	Frequency (MHz)	6 dB Bandwidth (MHz)	Minimum Limit (MHz)	Pass / Fail
142	5710 (U-NII-3)	2.67	0.5	Pass
151	5755	35.90	0.5	Pass
159	5795	35.89	0.5	Pass

##### 802.11ac (VHT80)

Channel	Frequency (MHz)	6 dB Bandwidth (MHz)	Minimum Limit (MHz)	Pass / Fail
138	5690 (U-NII-3)	2.64	0.5	Pass
155	5775	75.43	0.5	Pass

### Spectrum Plot of Worst Value

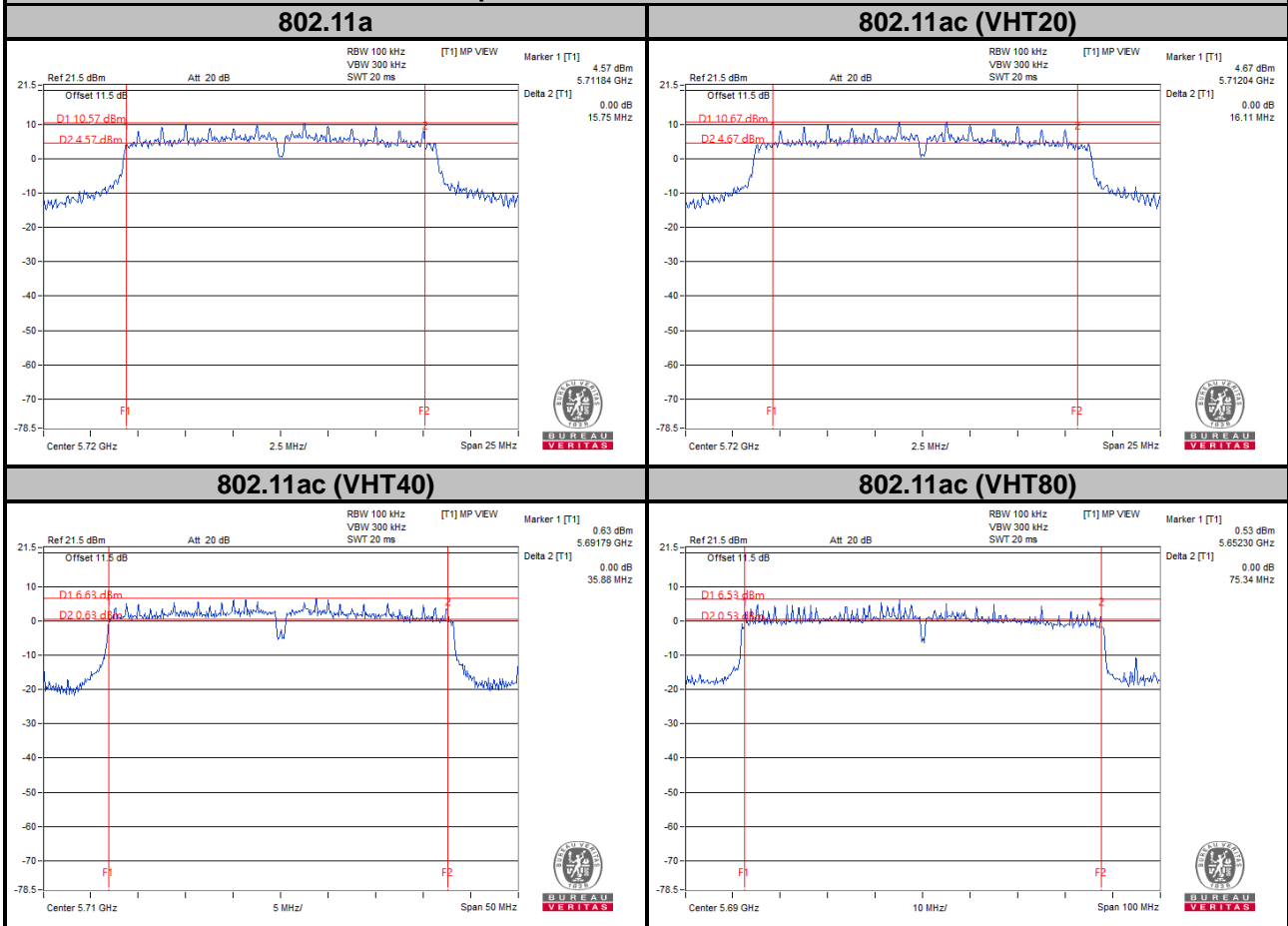

**Note:**

For Ch144 (UNII-3 Band): The 6 dB bandwidth above 5725 MHz = Marker 1 + Delta 2 – 5725 MHz  
 For Ch142 (UNII-3 Band): The 6 dB bandwidth above 5725 MHz = Marker 1 + Delta 2 – 5725 MHz  
 For Ch138 (UNII-3 Band): The 6 dB bandwidth above 5725 MHz = Marker 1 + Delta 2 – 5725 MHz

## 5 Pictures of Test Arrangements

Please refer to the attached file (Test Setup Photo).

# Annex A- Radiated Out of Band Emission (OOBE) Measurement (For U-NII-3 band)

## 802.11a

### CH 149 5745 MHz

#### Horizontal

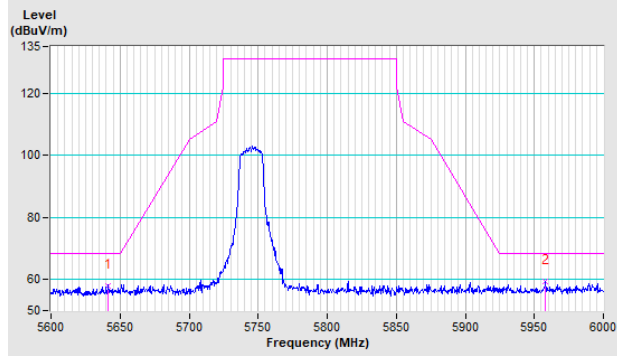

#### Vertical

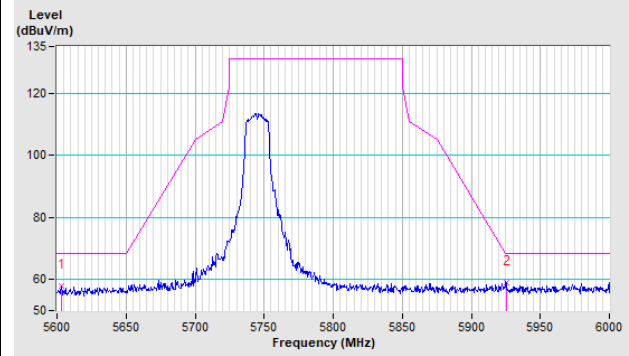

### CH 157 5785 MHz

#### Horizontal

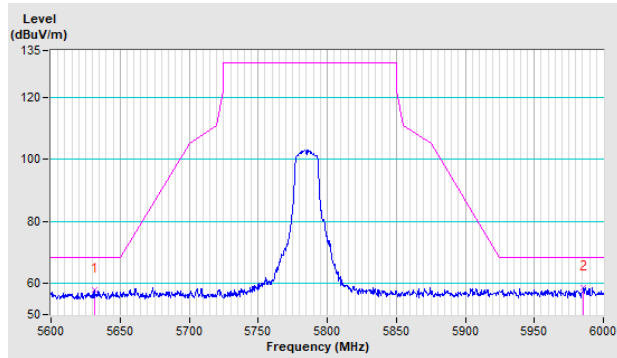

#### Vertical

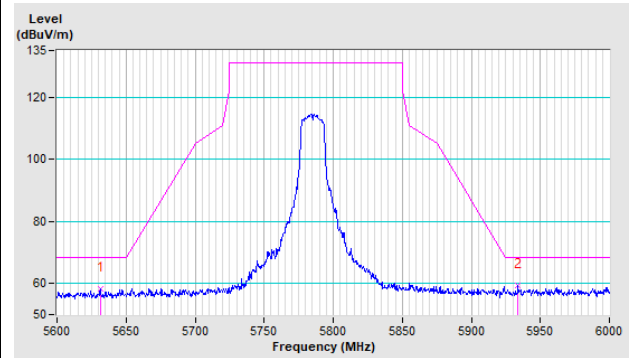

### CH 165 5825 MHz

#### Horizontal

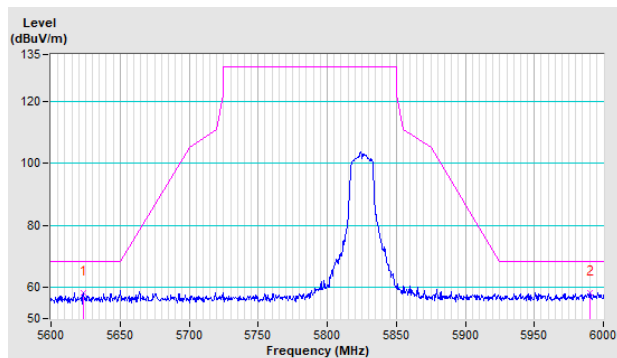

#### Vertical

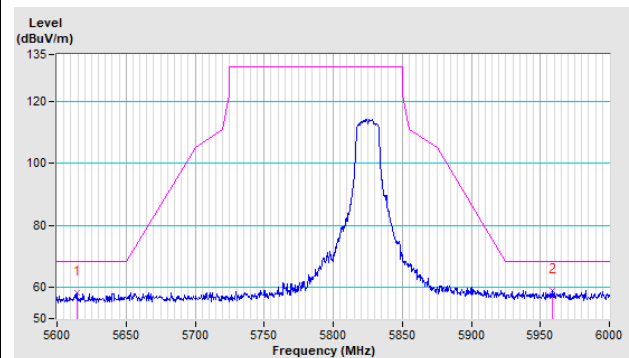

802.11ac (VHT20)

CH 149 5745 MHz

Horizontal

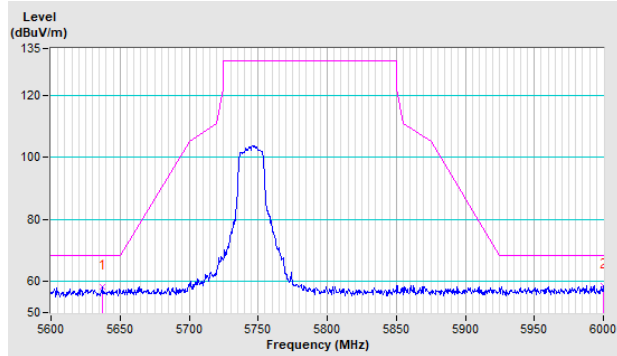

Vertical

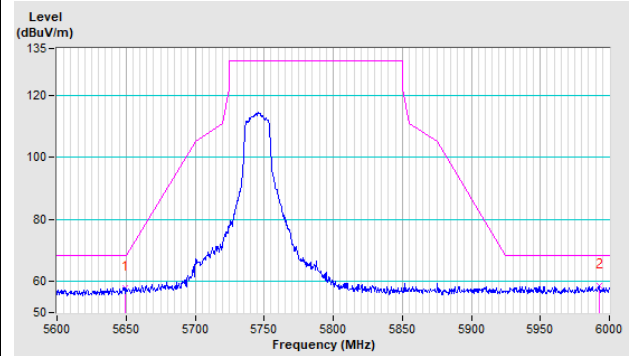

CH 157 5785 MHz

Horizontal

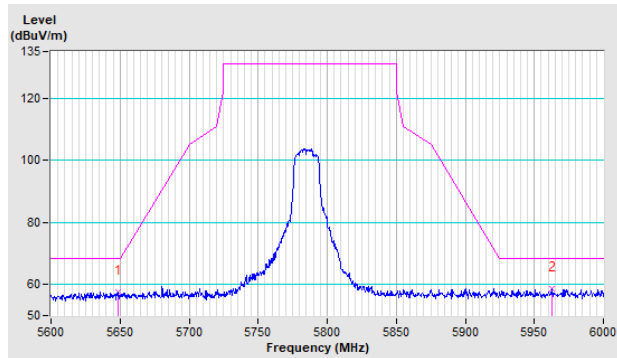

Vertical

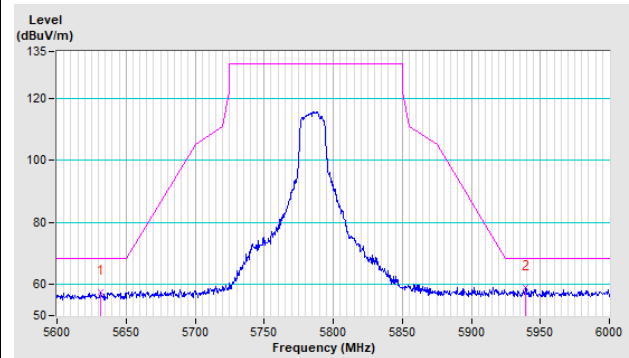

CH 165 5825 MHz

Horizontal

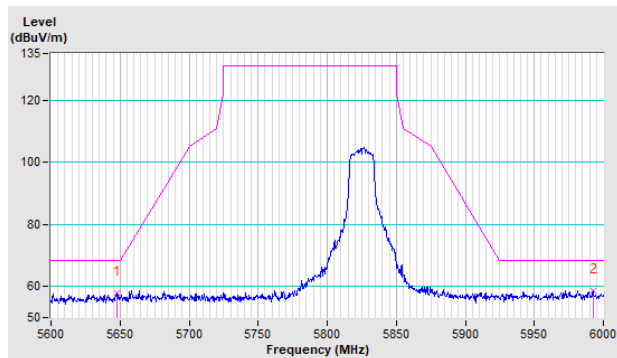

Vertical

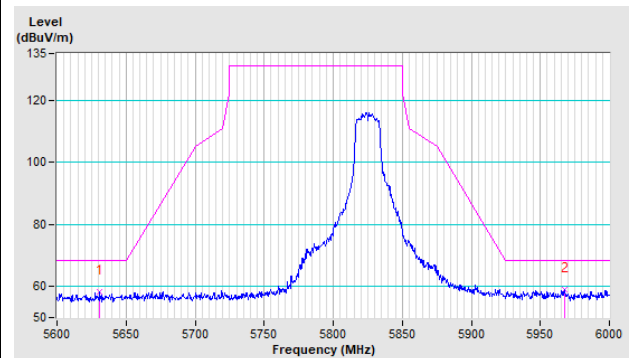

### 802.11ac (VHT40)

**CH 151 5755 MHz**

**Horizontal**

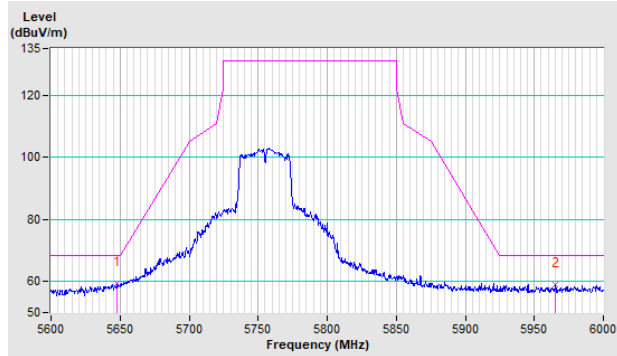

**Vertical**

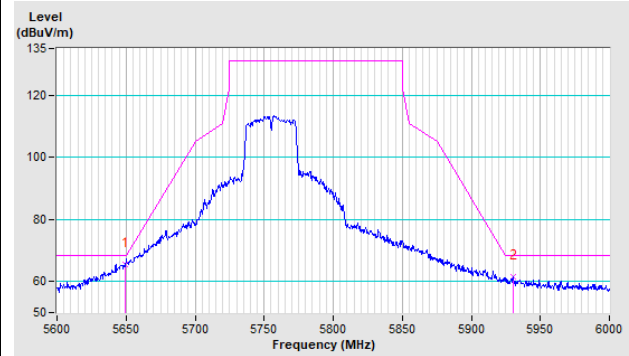

**CH 159 5795 MHz**

**Horizontal**

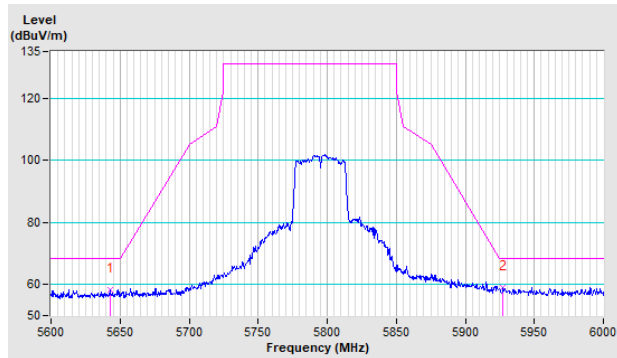

**Vertical**

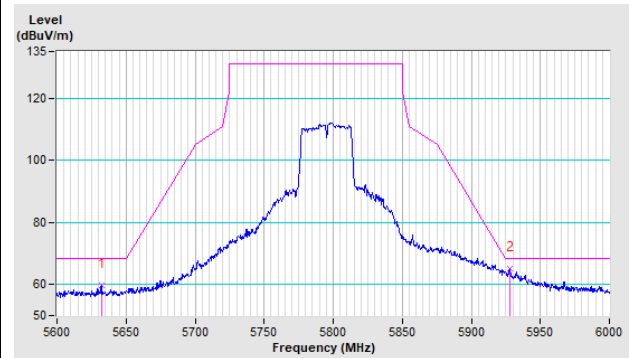

### 802.11ac (VHT80)

**CH 155 5775 MHz**

**Horizontal**

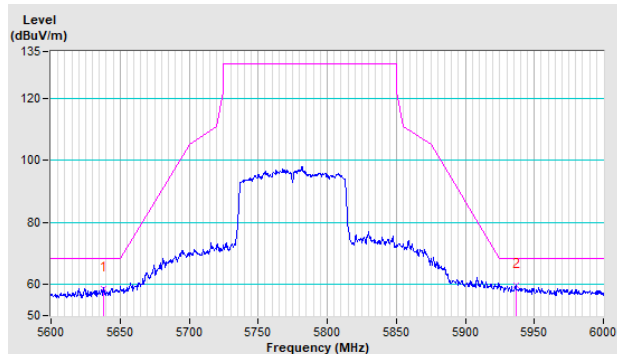

**Vertical**

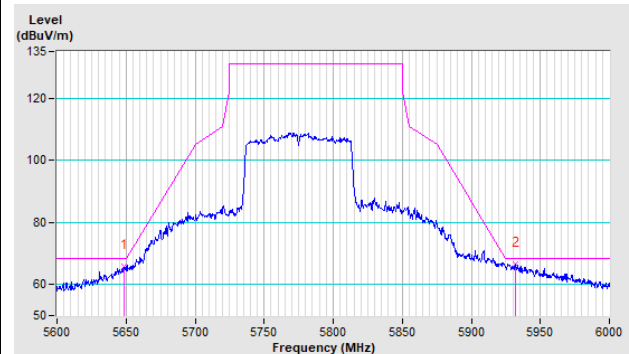

# Annex B- Band Edge Measurement

## 802.11a

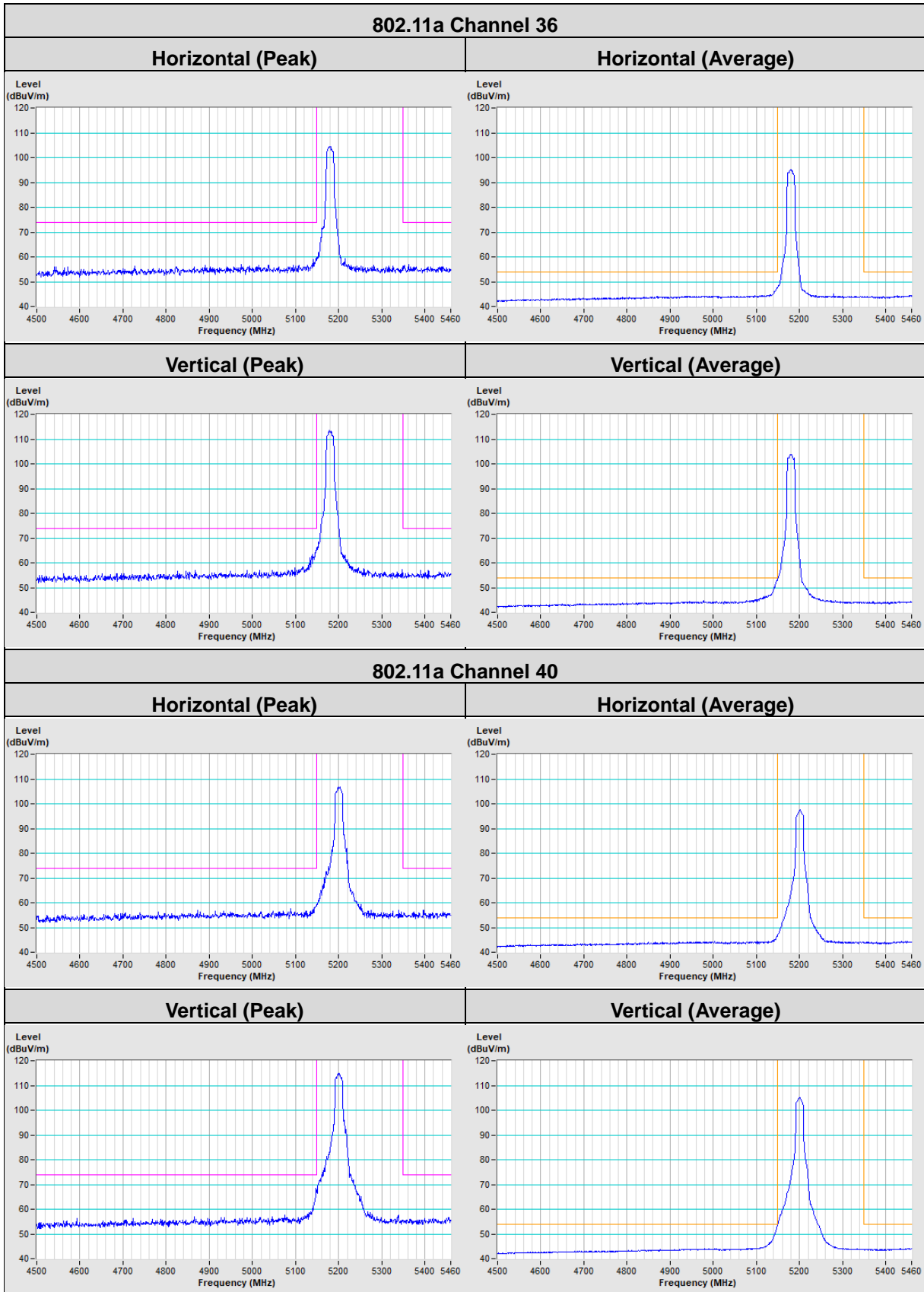

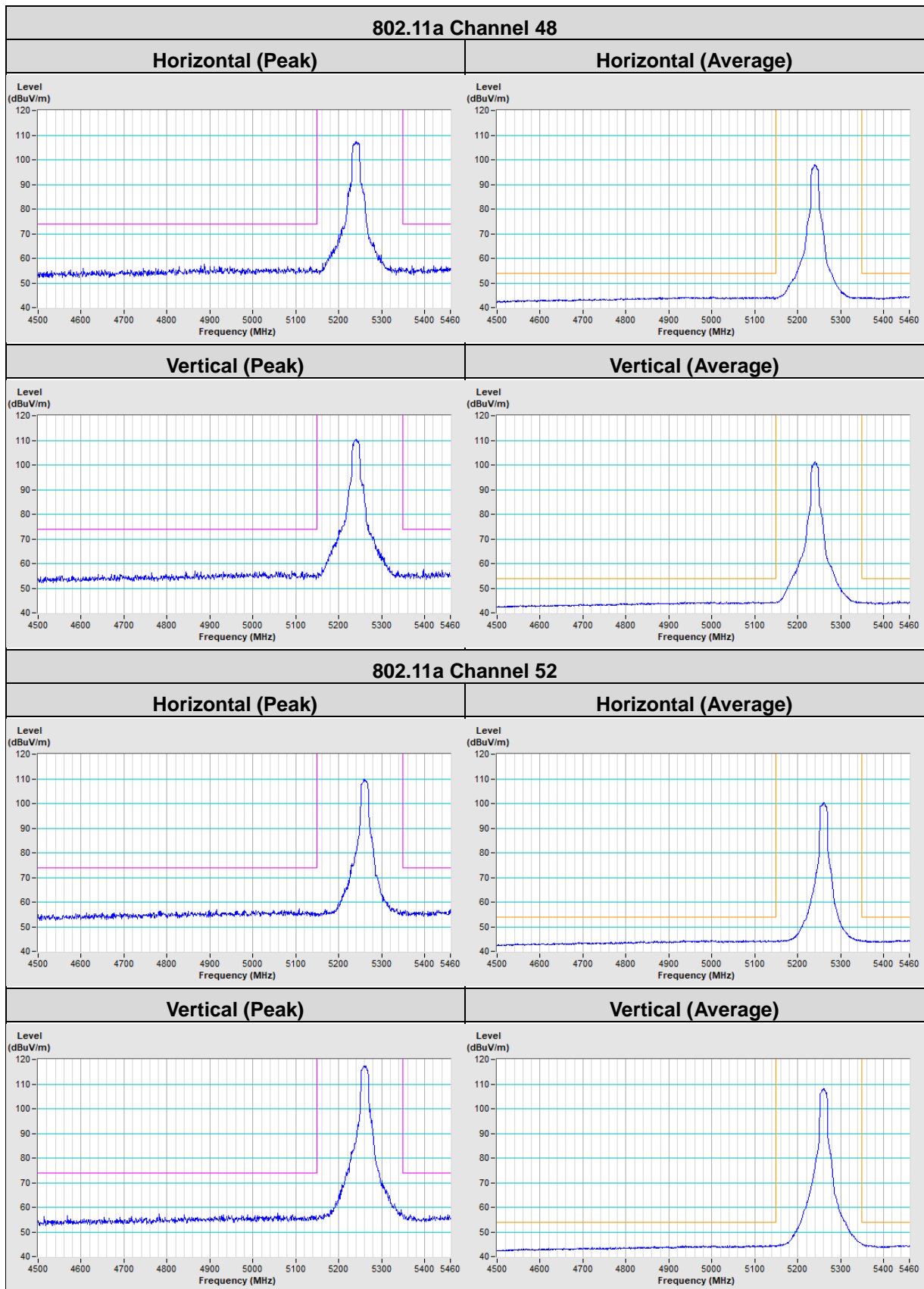



**802.11a Channel 60**

<b>Horizontal (Peak)</b>	<b>Horizontal (Average)</b>
--------------------------	-----------------------------

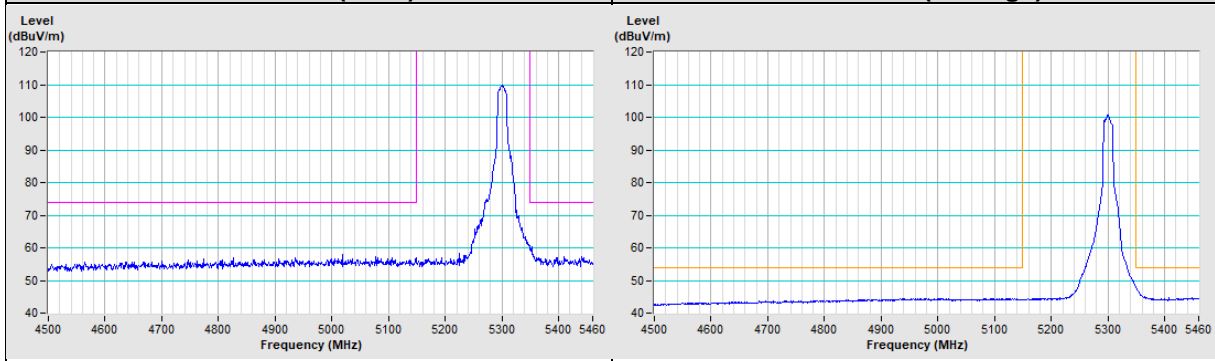

<b>Vertical (Peak)</b>	<b>Vertical (Average)</b>
------------------------	---------------------------

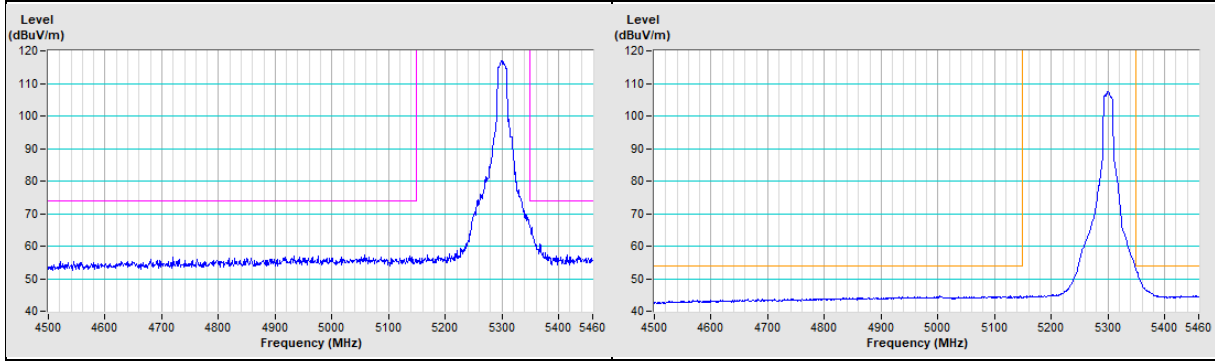

**802.11a Channel 64**

<b>Horizontal (Peak)</b>	<b>Horizontal (Average)</b>
--------------------------	-----------------------------

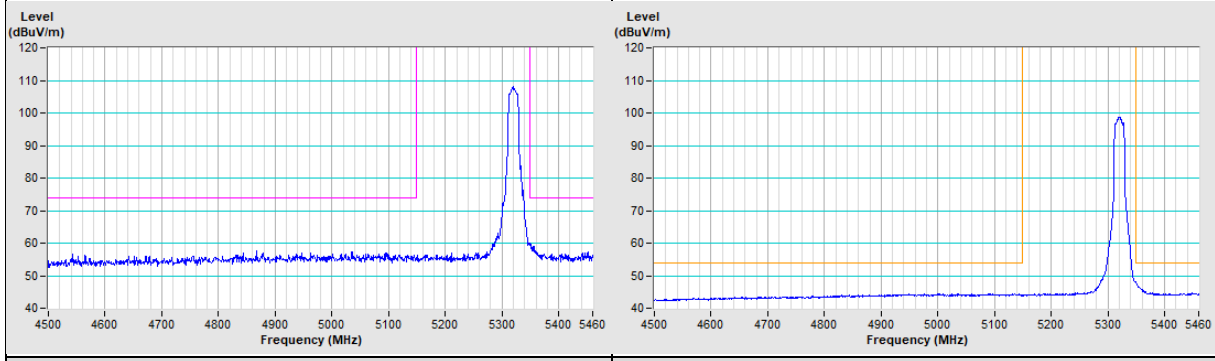

<b>Vertical (Peak)</b>	<b>Vertical (Average)</b>
------------------------	---------------------------

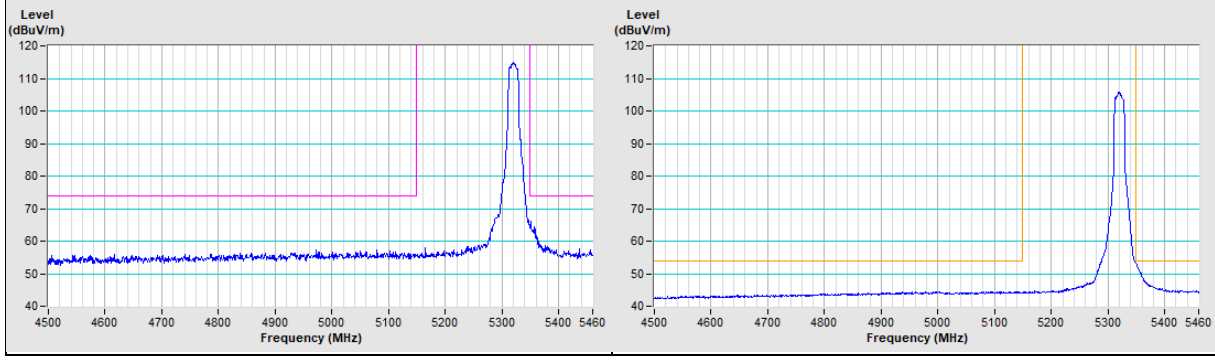

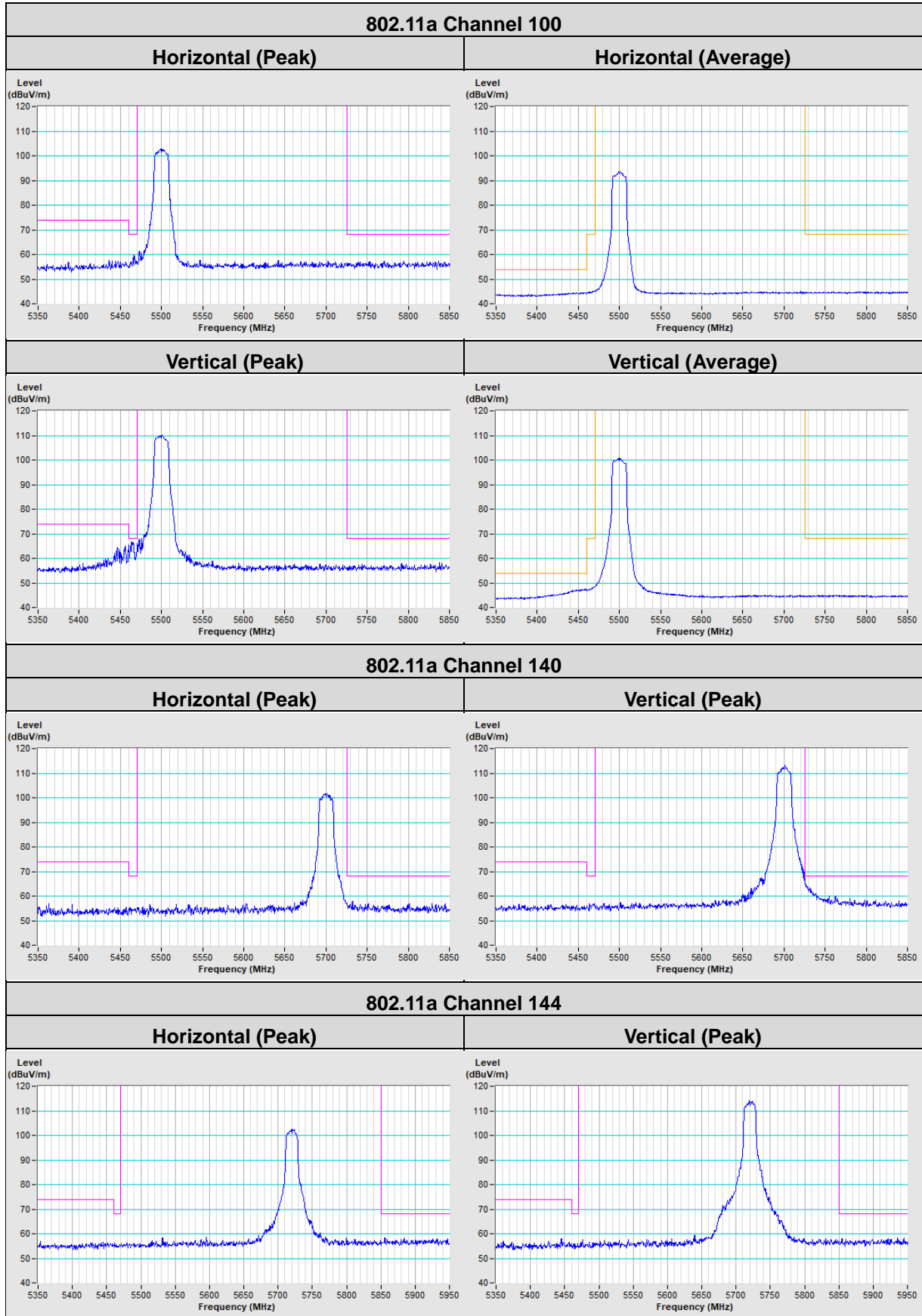

802.11ac (VHT20)

802.11ac (VHT20) Channel 36

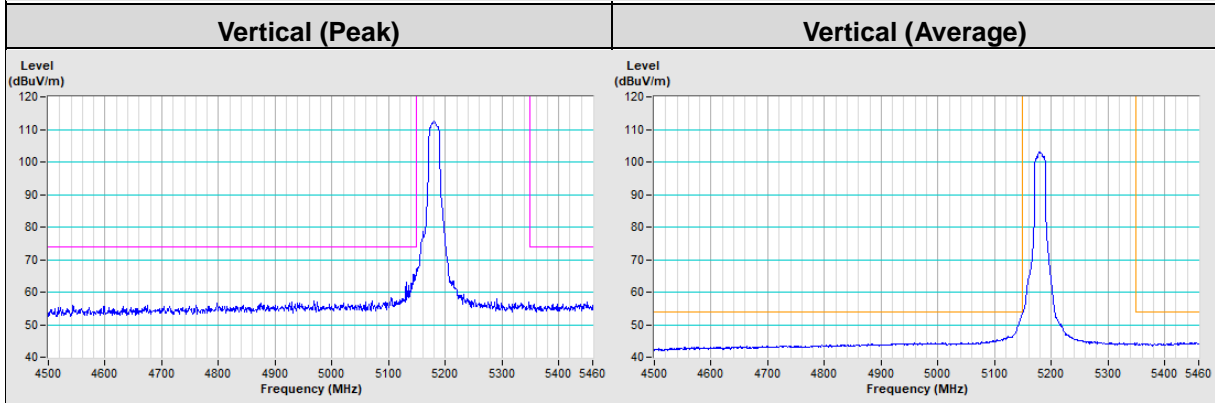
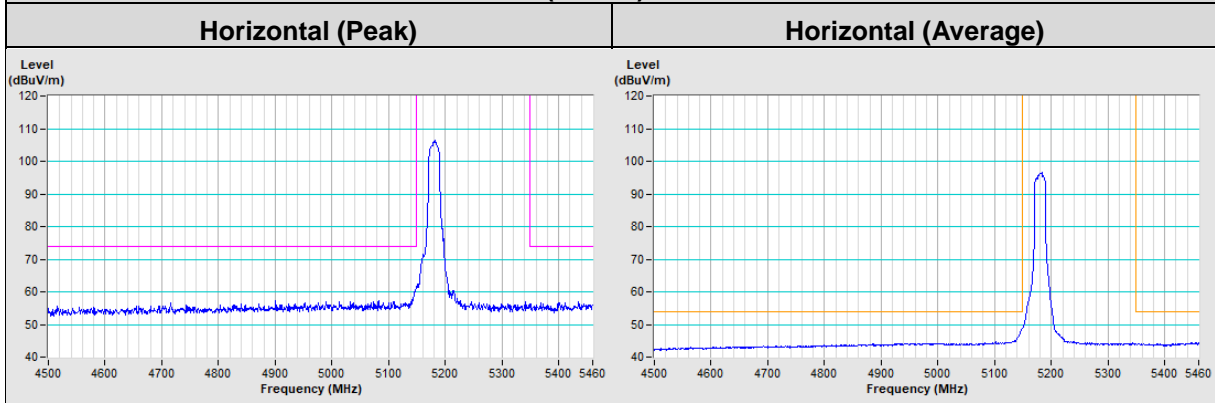

802.11ac (VHT20) Channel 40

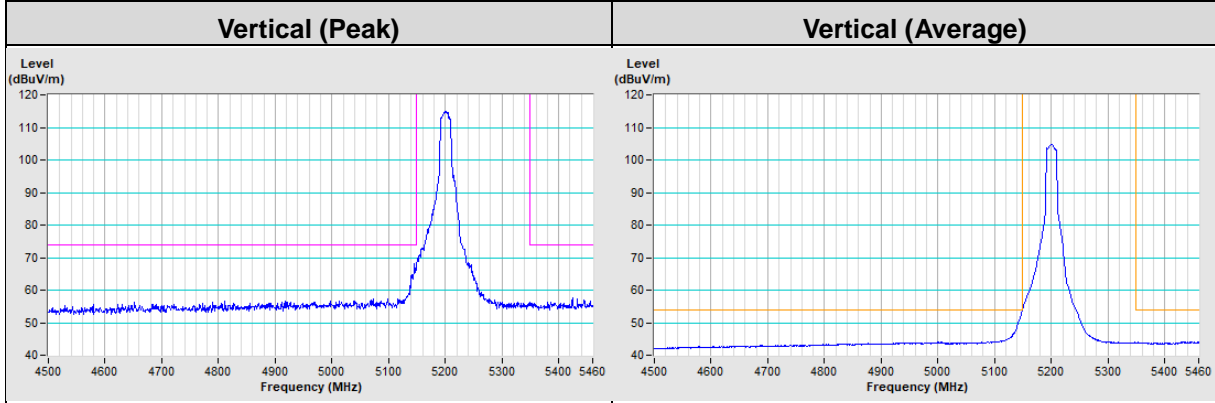
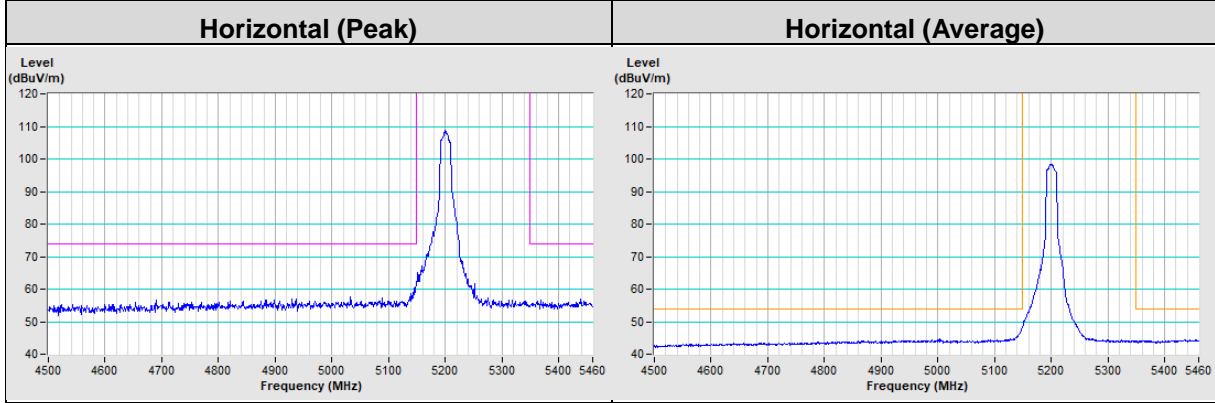

### 802.11ac (VHT20) Channel 48

**Horizontal (Peak)**

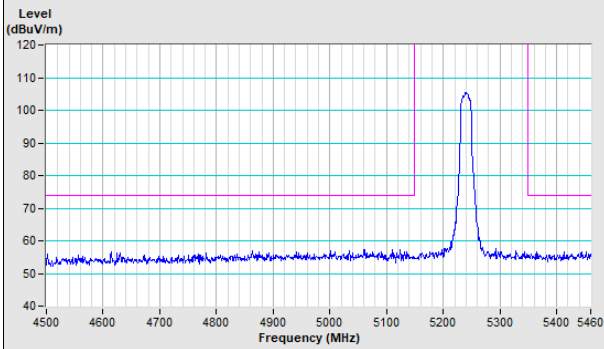

**Horizontal (Average)**

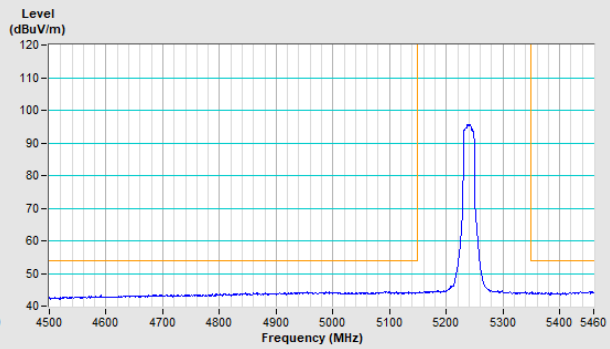

**Vertical (Peak)**

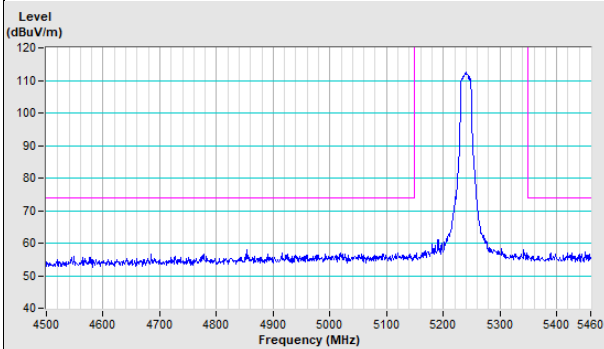

**Vertical (Average)**

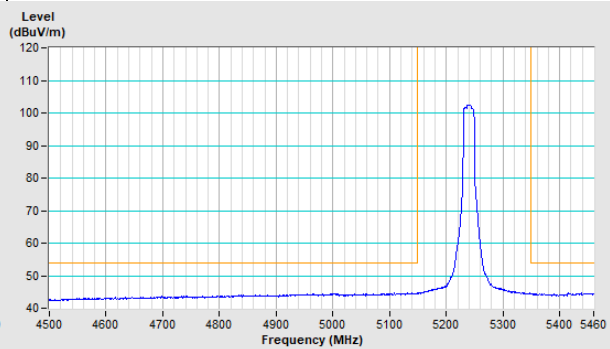

### 802.11ac (VHT20) Channel 52

**Horizontal (Peak)**

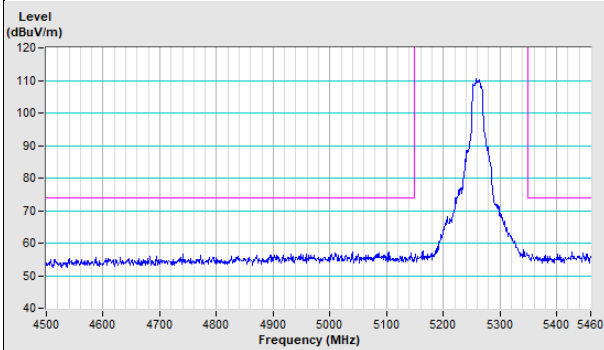

**Horizontal (Average)**

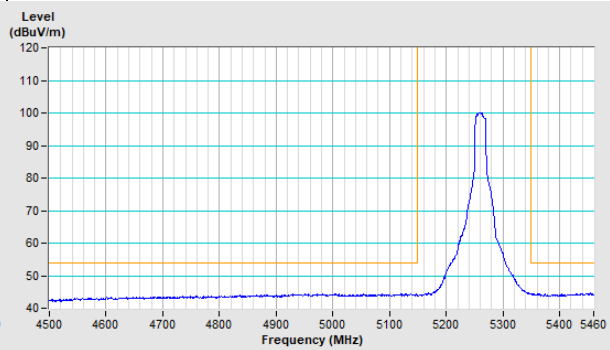

**Vertical (Peak)**

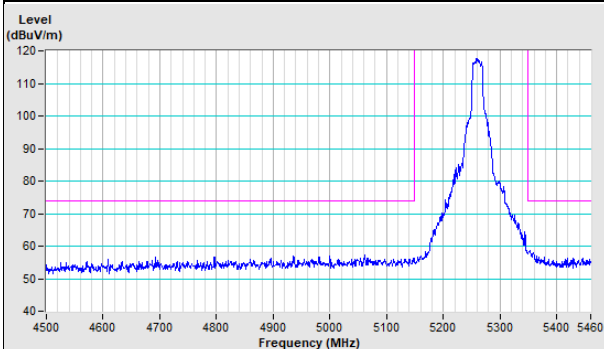

**Vertical (Average)**

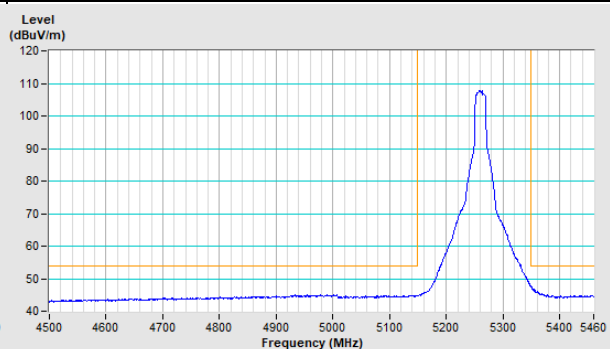

### 802.11ac (VHT20) Channel 60

**Horizontal (Peak)**

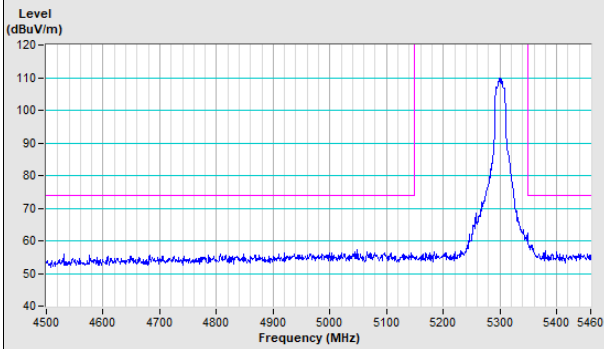

**Horizontal (Average)**

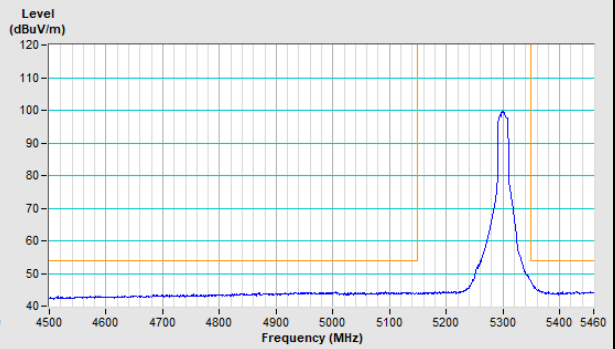

**Vertical (Peak)**

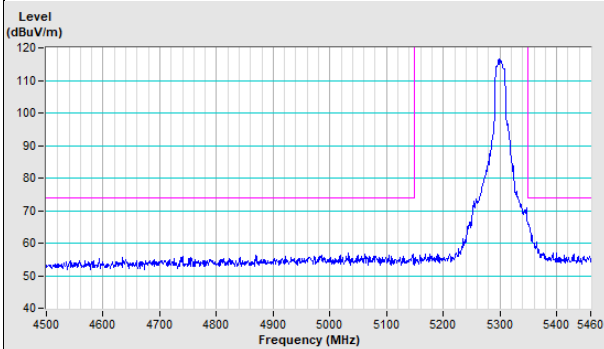

**Vertical (Average)**

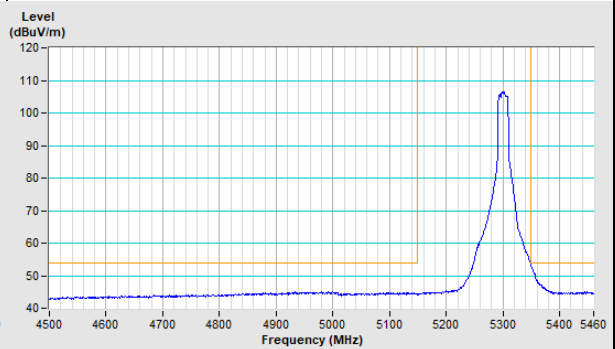

### 802.11ac (VHT20) Channel 64

**Horizontal (Peak)**

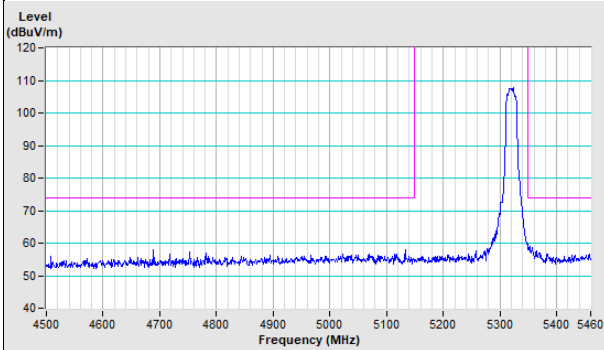

**Horizontal (Average)**

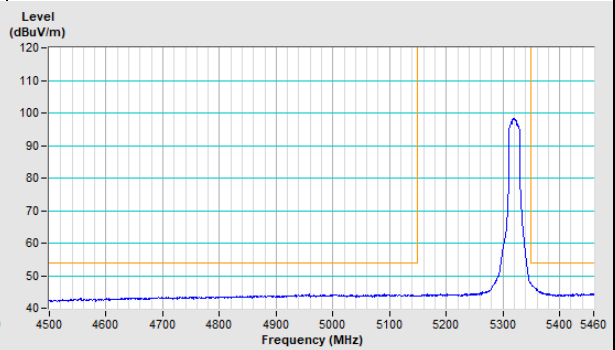

**Vertical (Peak)**

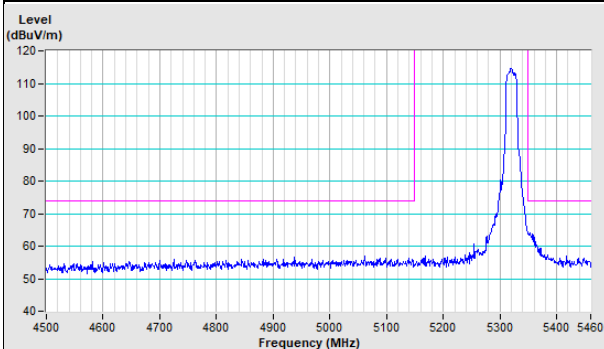

**Vertical (Average)**

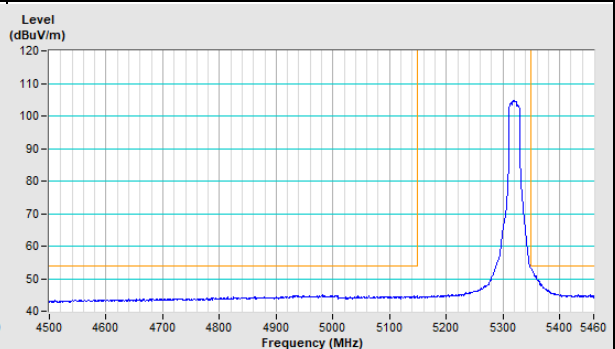

### 802.11ac (VHT20) Channel 100

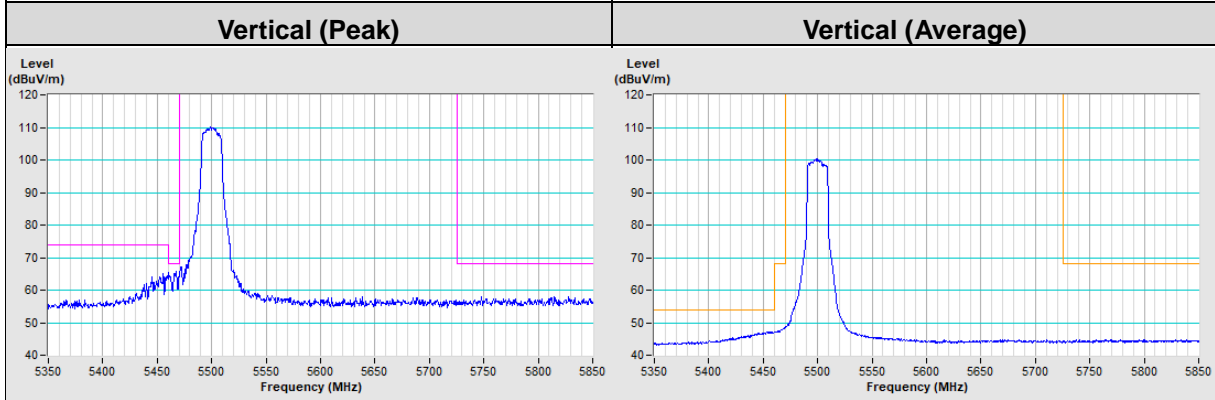
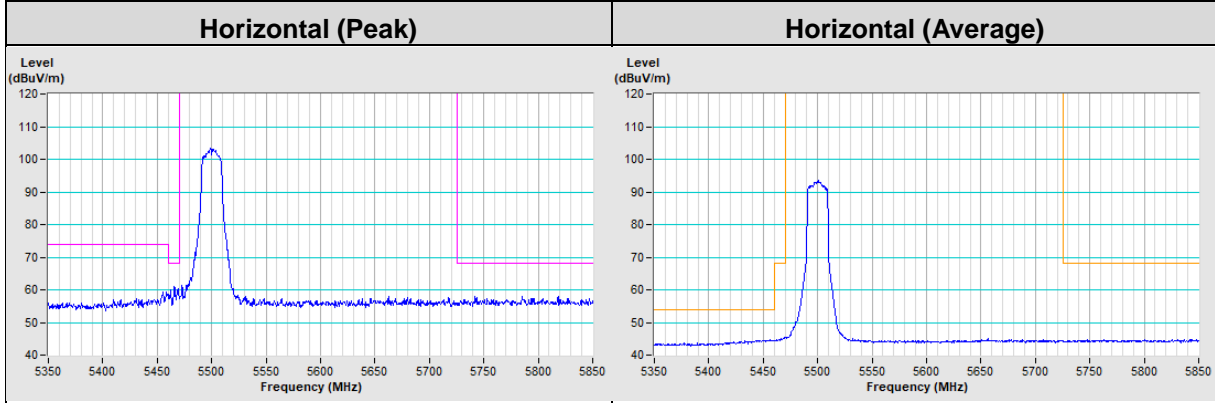

### 802.11ac (VHT20) Channel 140

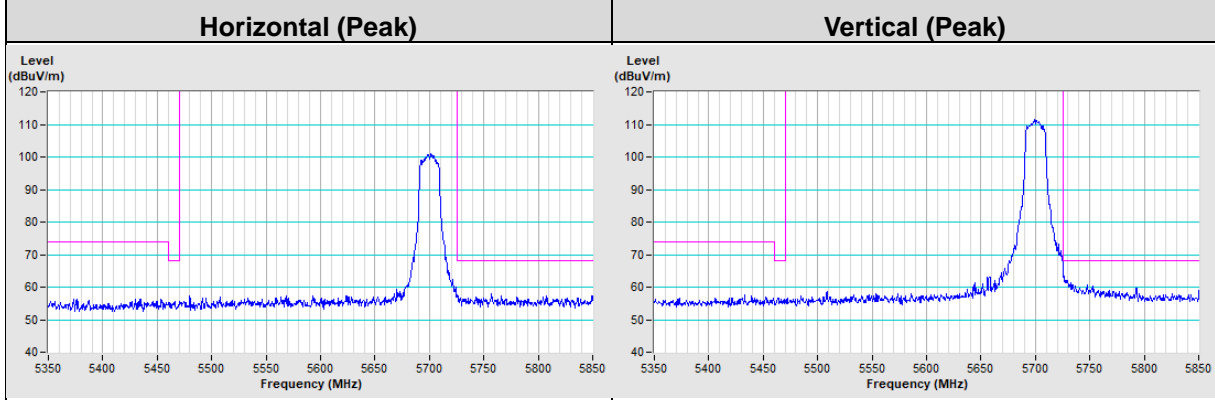

### 802.11ac (VHT20) Channel 144

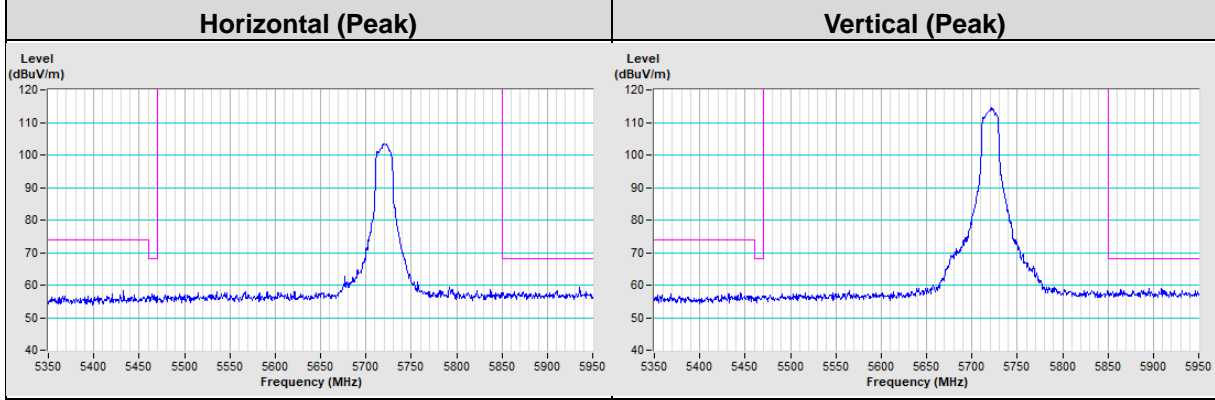

802.11ac (VHT40)

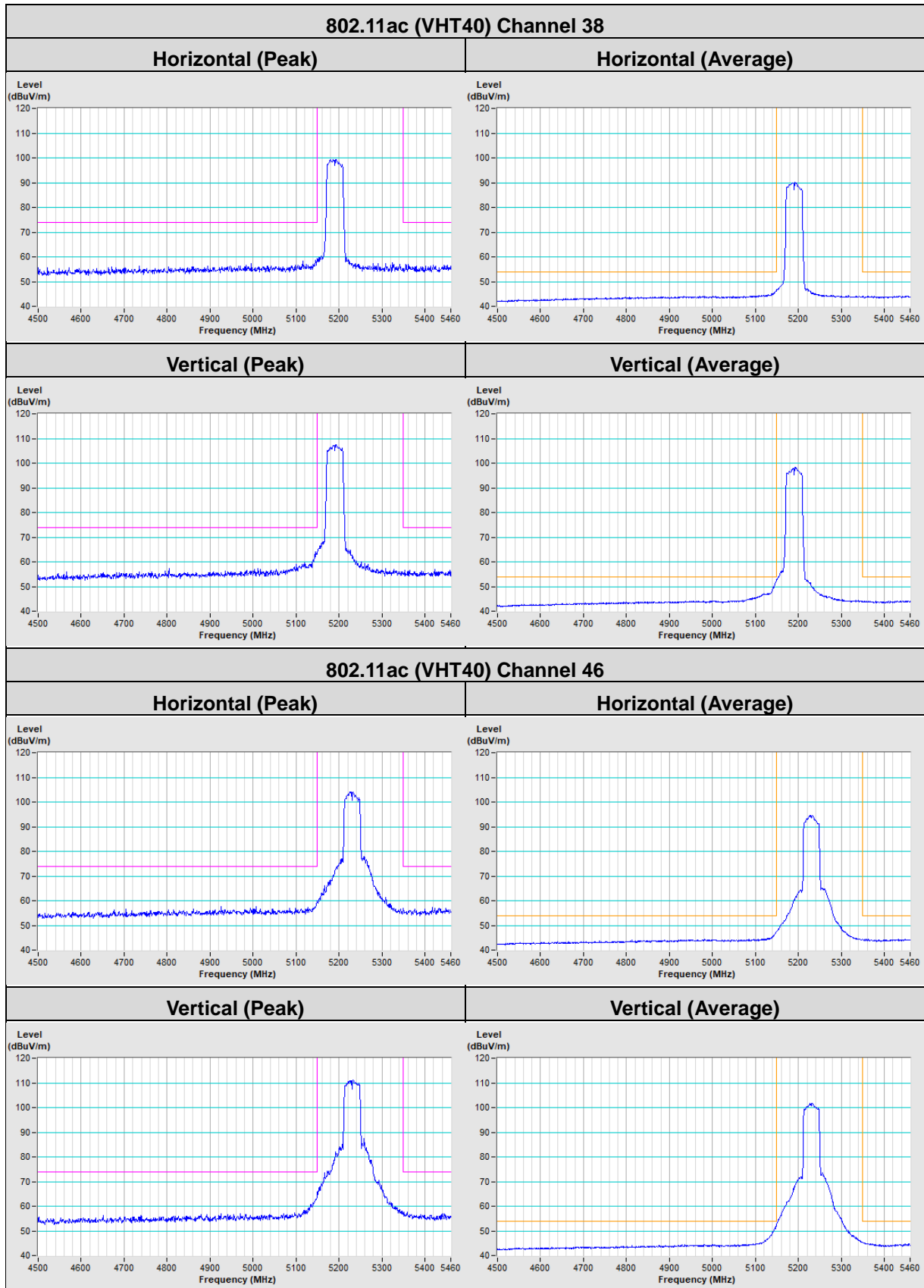

### 802.11ac (VHT40) Channel 54

**Horizontal (Peak)**

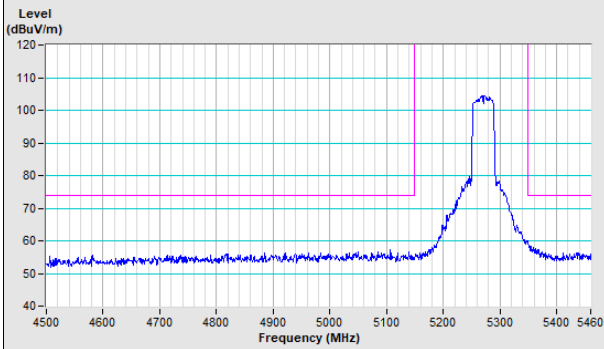

**Horizontal (Average)**

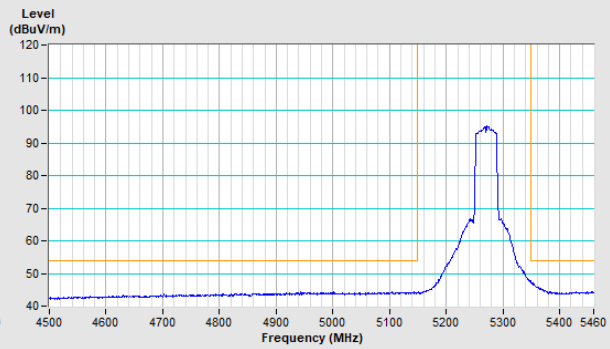

**Vertical (Peak)**

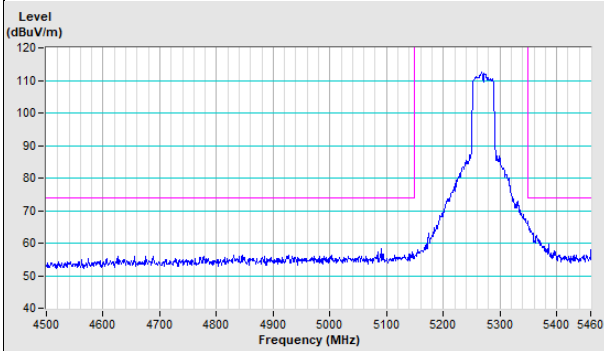

**Vertical (Average)**

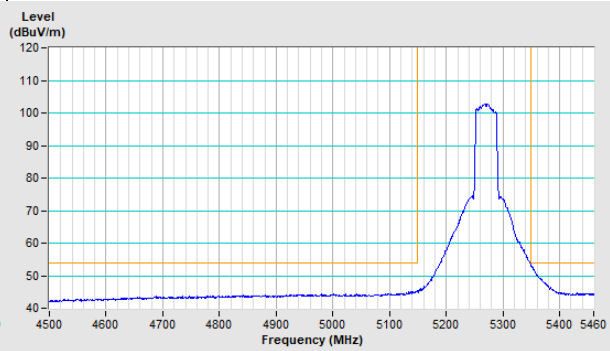

### 802.11ac (VHT40) Channel 62

**Horizontal (Peak)**

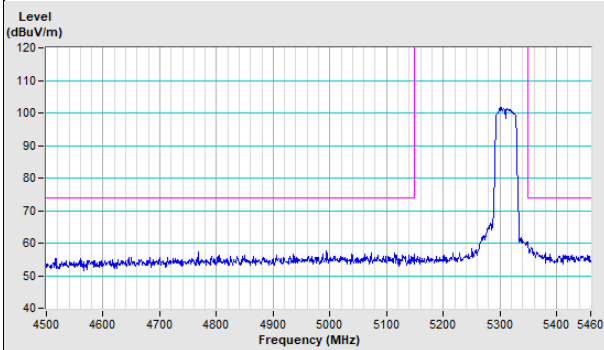

**Horizontal (Average)**

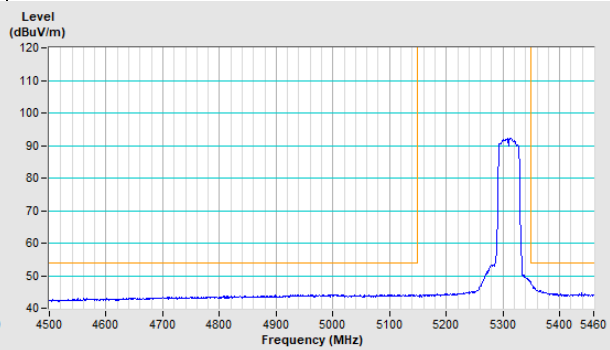

**Vertical (Peak)**

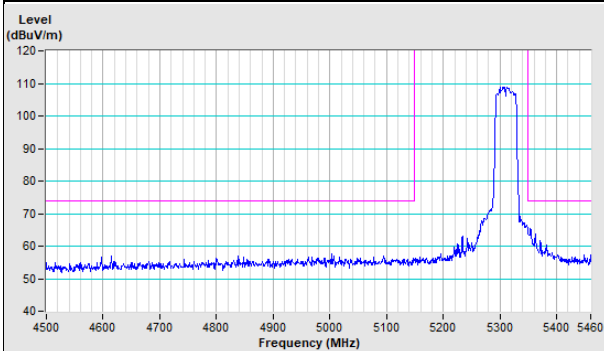

**Vertical (Average)**

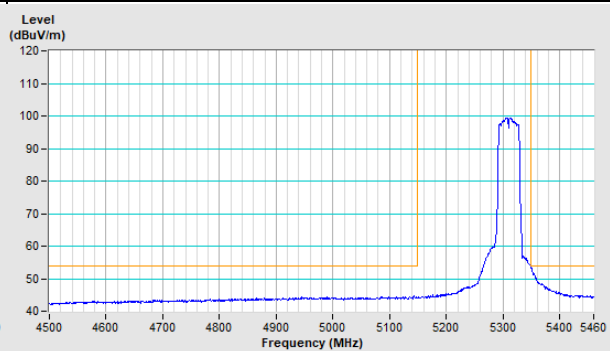



### 802.11ac (VHT40) Channel 102

<b>Horizontal (Peak)</b>	<b>Horizontal (Average)</b>
--------------------------	-----------------------------

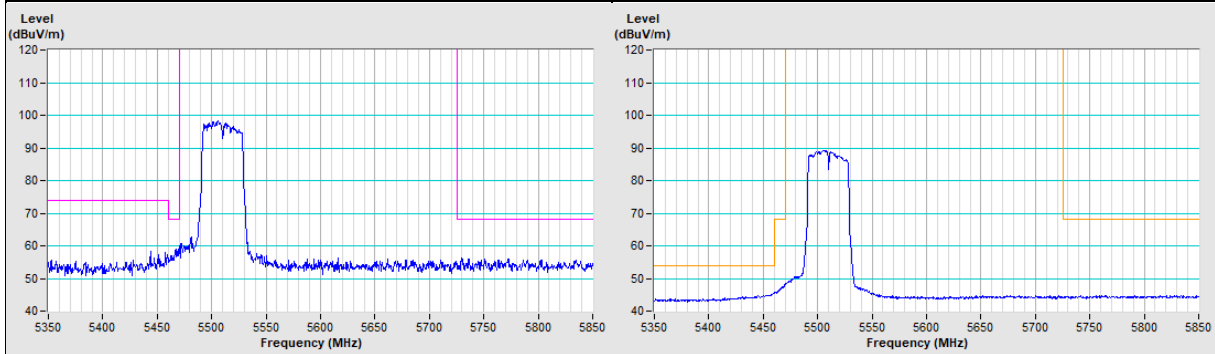

<b>Vertical (Peak)</b>	<b>Vertical (Average)</b>
------------------------	---------------------------

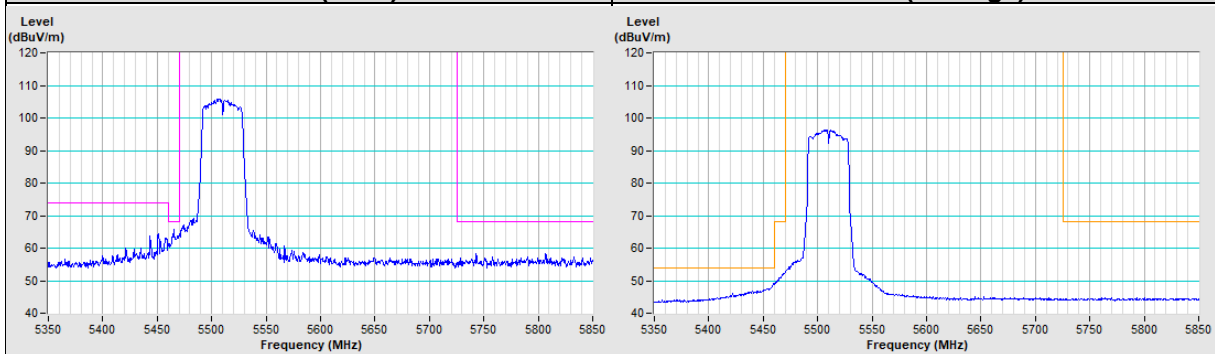

### 802.11ac (VHT40) Channel 110

<b>Horizontal (Peak)</b>	<b>Horizontal (Average)</b>
--------------------------	-----------------------------

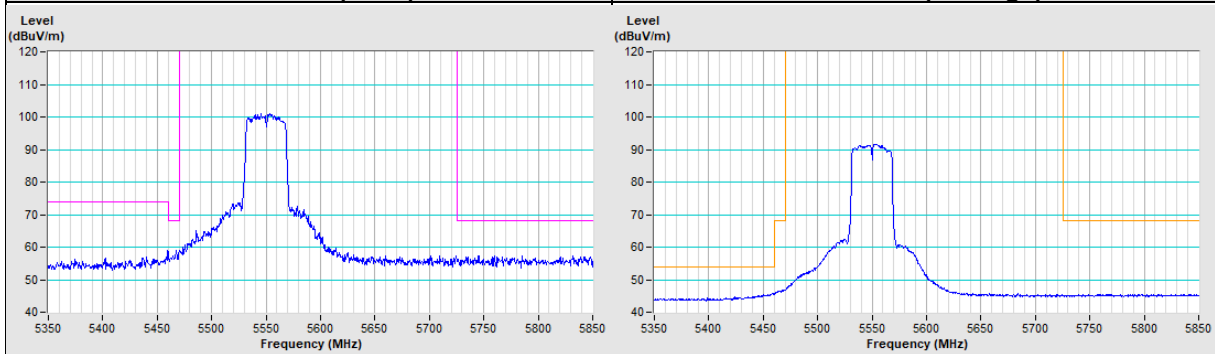

<b>Vertical (Peak)</b>	<b>Vertical (Average)</b>
------------------------	---------------------------

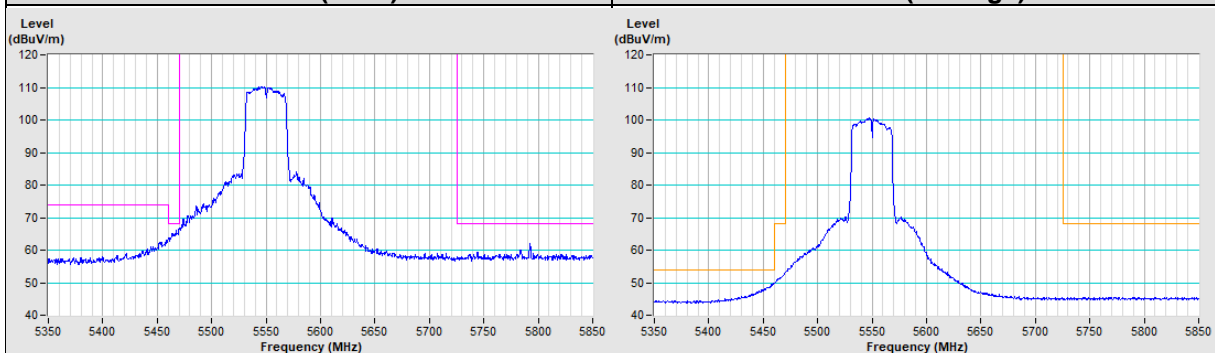

**802.11ac (VHT40) Channel 134**

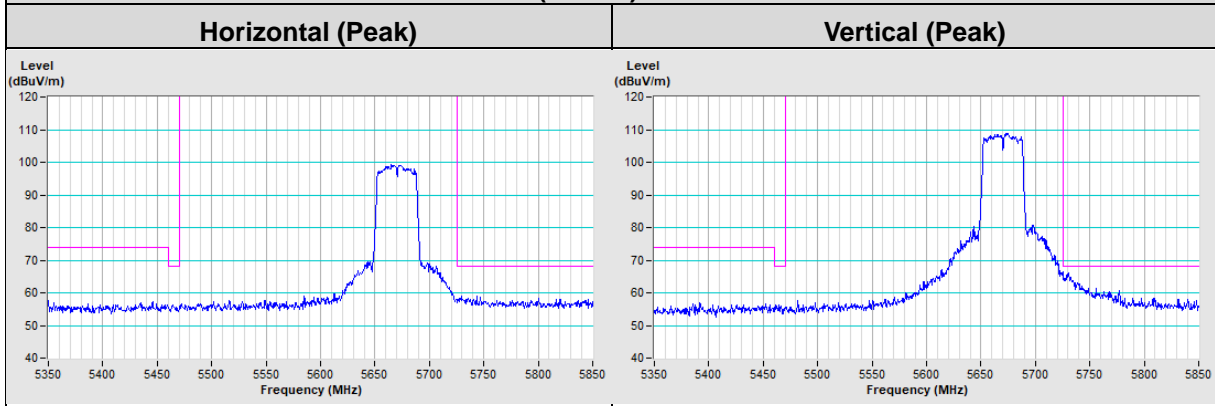

**802.11ac (VHT40) Channel 142**

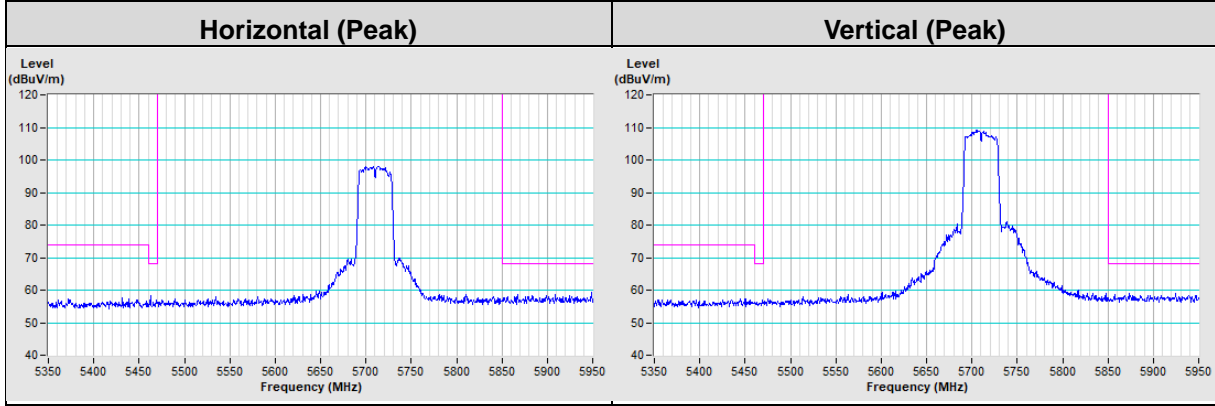

802.11ac (VHT80)

802.11ac (VHT80) Channel 42

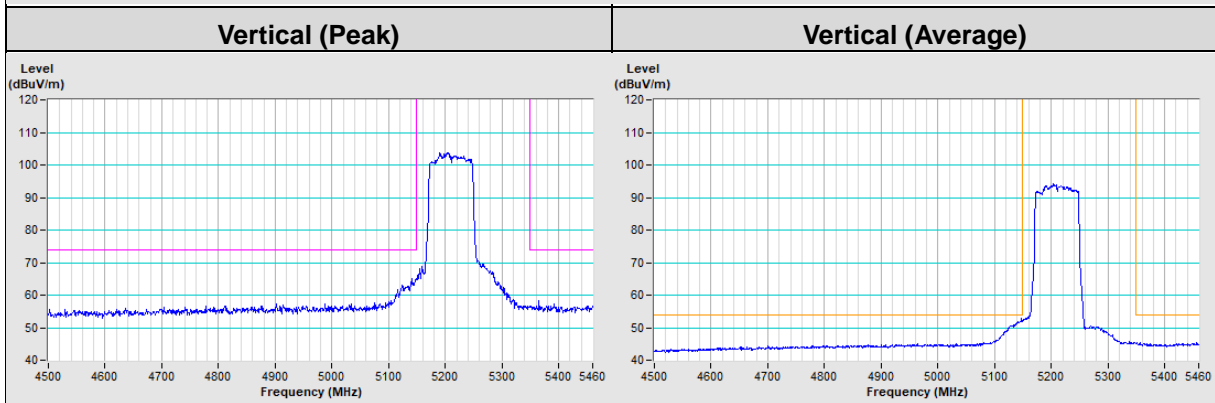
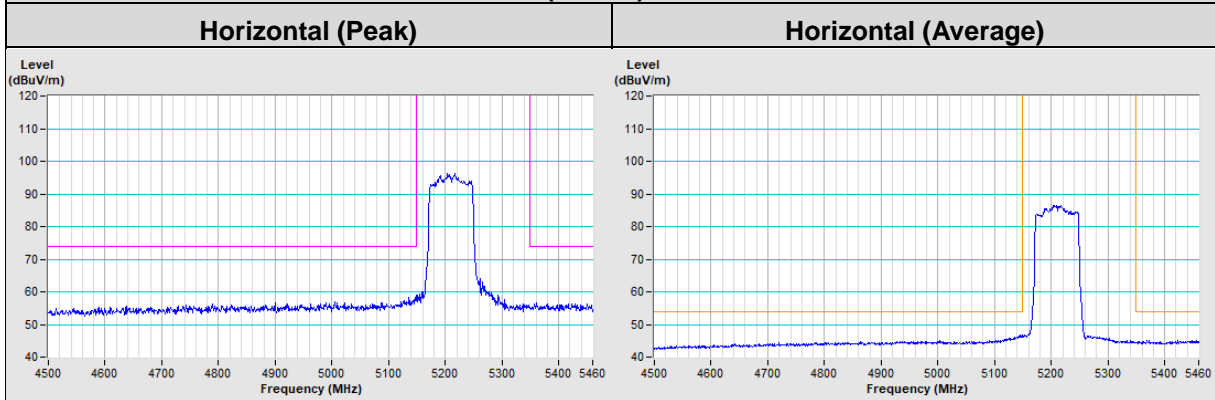

802.11ac (VHT80) Channel 58

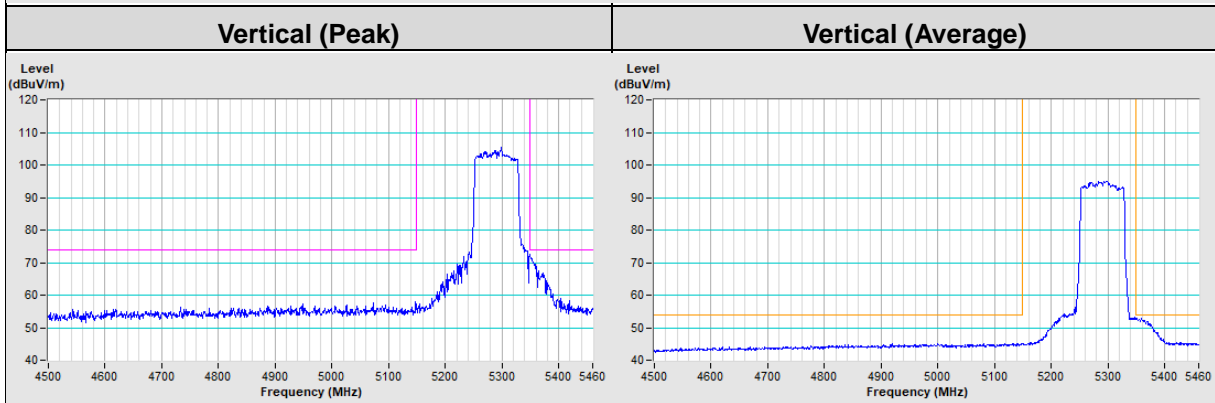
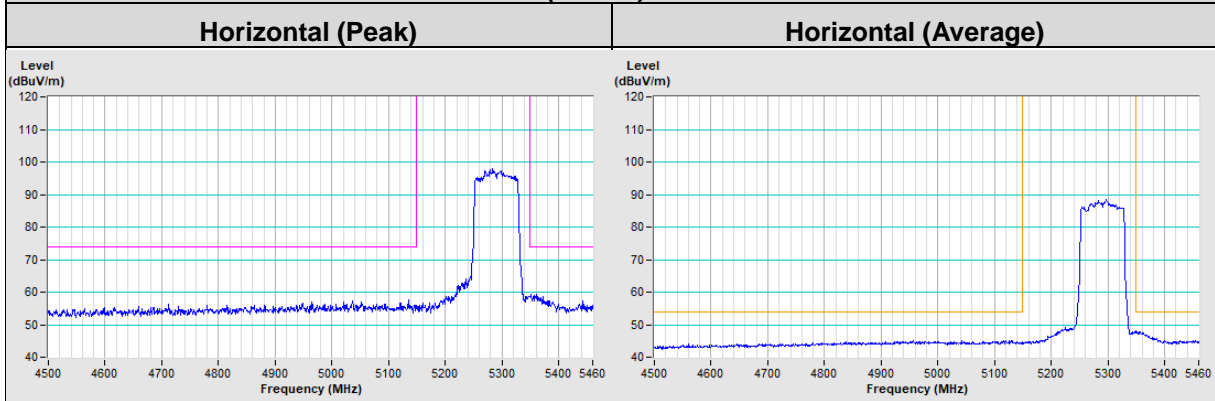

**802.11ac (VHT80) Channel 106**

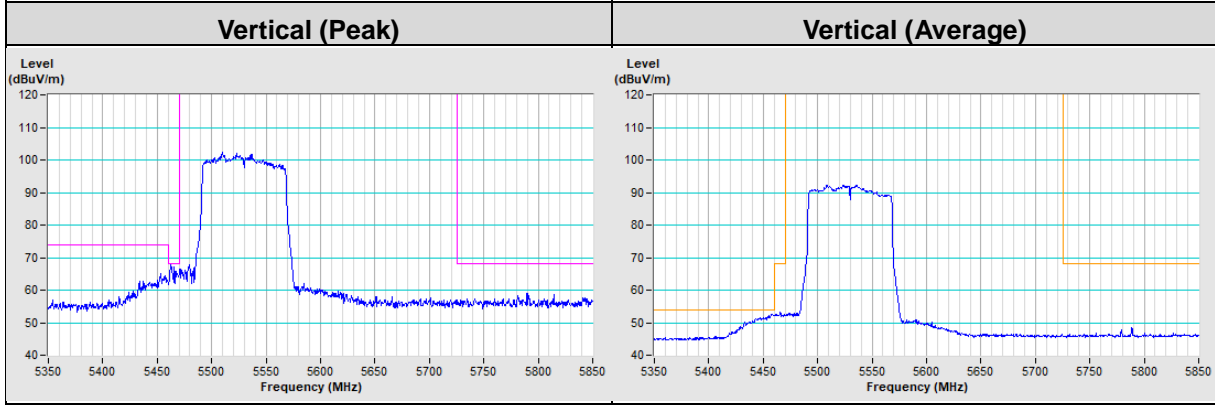
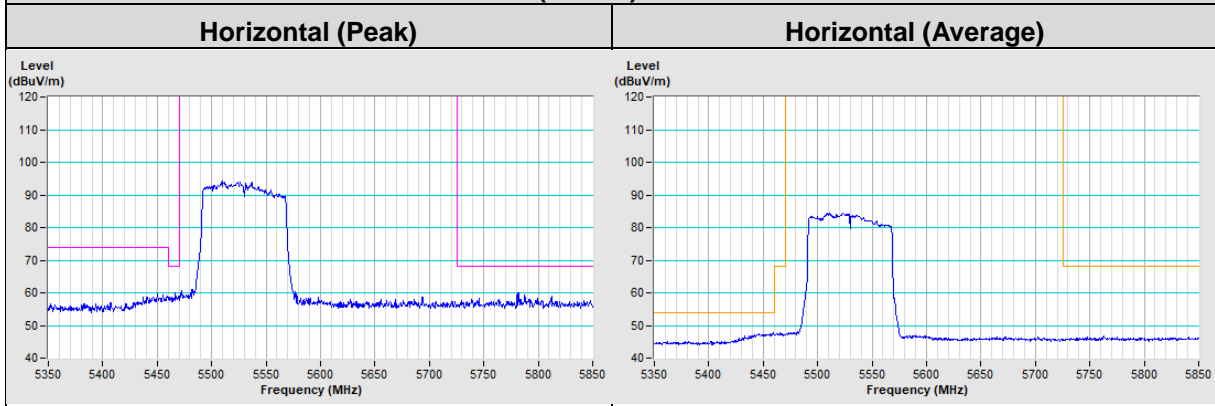

**802.11ac (VHT80) Channel 138**

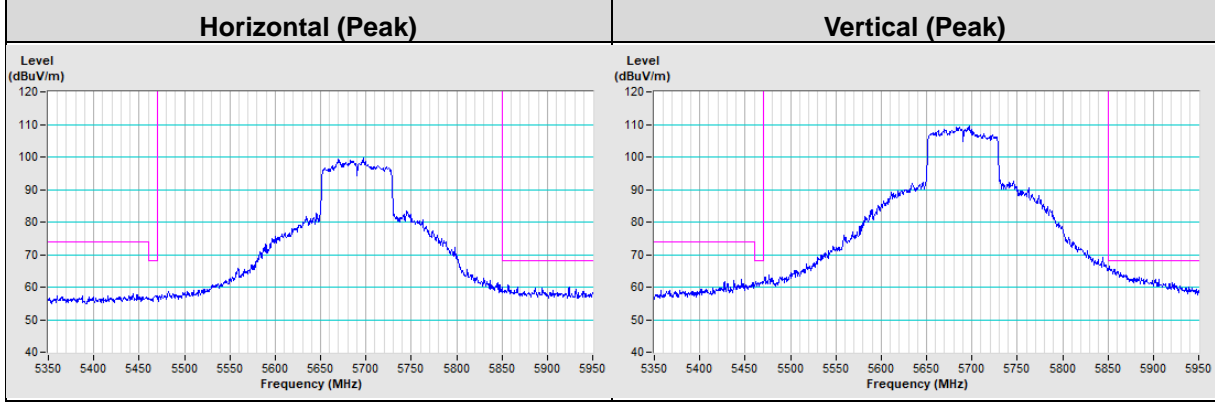

## Appendix – Information of the Testing Laboratories

We, Bureau Veritas Consumer Products Services (H.K.) Ltd., Taoyuan Branch, were founded in 1988 to provide our best service in EMC, Radio, Telecom and Safety consultation. Our laboratories are FCC recognized accredited test firms and accredited according to ISO/IEC 17025.

If you have any comments, please feel free to contact us at the following:

**Lin Kou EMC/RF Lab**

Tel: 886-2-26052180

Fax: 886-2-26051924

**Hsin Chu EMC/RF/Telecom Lab**

Tel: 886-3-6668565

Fax: 886-3-6668323

**Hwa Ya EMC/RF/Safety Lab**

Tel: 886-3-3183232

Fax: 886-3-3270892

**Email:** [service.adt@tw.bureauveritas.com](mailto:service.adt@tw.bureauveritas.com)

**Web Site:** [www.bureauveritas-adt.com](http://www.bureauveritas-adt.com)

The address and road map of all our labs can be found in our web site also.

--- END ---