

## FCC Test Report

**Report No.:** RFBHAT-WTW-P21061067-2

**FCC ID:** R68OQ610US

**Test Model:** Open-Q 610 uSOM

**Received Date:** Jun. 29, 2021

**Test Date:** Sep. 03 ~ Oct. 21, 2021

**Issued Date:** Jan. 10, 2022

**Applicant:** Lantronix, Inc.

**Address:** 7535 Irvine Center Drive, Suite 100, Irvine, CA 92618 USA

**Issued By:** Bureau Veritas Consumer Products Services (H.K.) Ltd., Taoyuan Branch  
Lin Kou Laboratories

**Lab Address:** No. 47-2, 14th Ling, Chia Pau Vil., Lin Kou Dist., New Taipei City, Taiwan

**Test Location (1):** No.19, Hwa Ya 2nd Rd., Wen Hwa Vil., Kwei Shan Dist., Taoyuan City  
33383, Taiwan

**Test Location (2):** No. 70, Wenming Rd., Guishan Dist., Taoyuan City 333, Taiwan

**FCC Registration /** 788550 / TW0003

**Designation Number:** 281270 / TW0032



This report is for your exclusive use. Any copying or replication of this report to or for any other person or entity, or use of our name or trademark, is permitted only with our prior written permission. This report sets forth our findings solely with respect to the test samples identified herein. The results set forth in this report are not indicative or representative of the quality or characteristics of the lot from which a test sample was taken or any similar or identical product unless specifically and expressly noted. Our report includes all of the tests requested by you and the results thereof based upon the information that you provided to us. You have 60 days from date of issuance of this report to notify us of any material error or omission caused by our negligence, provided, however, that such notice shall be in writing and shall specifically address the issue you wish to raise. A failure to raise such issue within the prescribed time shall constitute your unqualified acceptance of the completeness of this report, the tests conducted and the correctness of the report contents. Unless specific mention, the uncertainty of measurement has been explicitly taken into account to declare the compliance or non-compliance to the specification.

## Table of Contents

|   |           |
|---|-----------|
| <b>Release Control Record</b> .....                               | <b>4</b>  |
| <b>1 Certificate of Conformity</b> .....                          | <b>5</b>  |
| <b>2 Summary of Test Results</b> .....                            | <b>6</b>  |
| 2.1 Measurement Uncertainty.....                                  | 6         |
| 2.2 Modification Record .....                                     | 6         |
| <b>3 General Information</b> .....                                | <b>7</b>  |
| 3.1 General Description of EUT .....                              | 7         |
| 3.2 Description of Test Modes.....                                | 8         |
| 3.2.1 Test Mode Applicability and Tested Channel Detail.....      | 9         |
| 3.3 Duty Cycle of Test Signal .....                               | 11        |
| 3.4 Description of Support Units .....                            | 12        |
| 3.4.1 Configuration of System under Test .....                    | 12        |
| 3.5 General Description of Applied Standards and References ..... | 12        |
| <b>4 Test Types and Results</b> .....                             | <b>13</b> |
| 4.1 Radiated Emission and Bandedge Measurement .....              | 13        |
| 4.1.1 Limits of Radiated Emission and Bandedge Measurement .....  | 13        |
| 4.1.2 Test Instruments .....                                      | 14        |
| 4.1.3 Test Procedures.....  | 15        |
| 4.1.4 Deviation from Test Standard .....                          | 16        |
| 4.1.5 Test Set Up .....   | 16        |
| 4.1.6 EUT Operating Conditions.....                               | 17        |
| 4.1.7 Test Results .....  | 18        |
| 4.2 Conducted Emission Measurement.....                           | 32        |
| 4.2.1 Limits of Conducted Emission Measurement .....              | 32        |
| 4.2.2 Test Instruments .....                                      | 32        |
| 4.2.3 Test Procedures.....  | 33        |
| 4.2.4 Deviation from Test Standard .....                          | 33        |
| 4.2.5 Test Setup.....   | 33        |
| 4.2.6 EUT Operating Conditions.....                               | 33        |
| 4.2.7 Test Results .....  | 34        |
| 4.3 6 dB Bandwidth Measurement.....                               | 36        |
| 4.3.1 Limits of 6 dB Bandwidth Measurement.....                   | 36        |
| 4.3.2 Test Setup.....   | 36        |
| 4.3.3 Test Instruments .....                                      | 36        |
| 4.3.4 Test Procedure .....  | 36        |
| 4.3.5 Deviation from Test Standard .....                          | 36        |
| 4.3.6 EUT Operating Conditions.....                               | 36        |
| 4.3.7 Test Results .....  | 37        |
| 4.4 Occupied Bandwidth Measurement.....                           | 39        |
| 4.4.1 Test Setup.....   | 39        |
| 4.4.2 Test Instruments .....                                      | 39        |
| 4.4.3 Test Procedure .....  | 39        |
| 4.4.4 Deviation from Test Standard .....                          | 39        |
| 4.4.5 EUT Operating Conditions.....                               | 39        |
| 4.4.6 Test Results .....  | 40        |
| 4.5 Conducted Output Power Measurement .....                      | 42        |
| 4.5.1 Limits of Conducted Output Power Measurement.....           | 42        |
| 4.5.2 Test Setup.....   | 42        |
| 4.5.3 Test Instruments .....                                      | 42        |
| 4.5.4 Test Procedures.....  | 42        |
| 4.5.5 Deviation from Test Standard .....                          | 42        |
| 4.5.6 EUT Operating Conditions.....                               | 42        |
| 4.5.7 Test Results .....  | 43        |

|          |   |           |
|----------|---|-----------|
| 4.6      | Power Spectral Density Measurement .....                        | 44        |
| 4.6.1    | Limits of Power Spectral Density Measurement.....               | 44        |
| 4.6.2    | Test Setup.....   | 44        |
| 4.6.3    | Test Instruments .....  | 44        |
| 4.6.4    | Test Procedure .....  | 44        |
| 4.6.5    | Deviation from Test Standard .....                              | 45        |
| 4.6.6    | EUT Operating Condition .....                                   | 45        |
| 4.6.7    | Test Results .....  | 46        |
| 4.7      | Conducted Out of Band Emission Measurement .....                | 48        |
| 4.7.1    | Limits of Conducted Out of Band Emission Measurement.....       | 48        |
| 4.7.2    | Test Setup.....   | 48        |
| 4.7.3    | Test Instruments .....  | 48        |
| 4.7.4    | Test Procedure .....  | 48        |
| 4.7.5    | Deviation from Test Standard .....                              | 48        |
| 4.7.6    | EUT Operating Condition .....                                   | 48        |
| 4.7.7    | Test Results .....  | 49        |
| <b>5</b> | <b>Pictures of Test Arrangements.....</b>                       | <b>53</b> |
|          | <b>Annex A- Band Edge Measurement .....</b>                     | <b>54</b> |
|          | <b>Appendix – Information of the Testing Laboratories .....</b> | <b>61</b> |

### Release Control Record

| Issue No.              | Description      | Date Issued   |
|------------------------|------------------|---------------|
| RFBHAT-WTW-P21061067-2 | Original Release | Jan. 10, 2022 |

## 1 Certificate of Conformity

**Product:** Open-Q 610 uSOM  
**Brand:** Lantronix  
**Test Model:** Open-Q 610 uSOM  
**Sample Status:** Engineering Sample  
**Applicant:** Lantronix, Inc.  
**Test Date:** Sep. 03 ~ Oct. 21, 2021  
**Standards:** 47 CFR FCC Part 15, Subpart C (Section 15.247)  
ANSI C63.10:2013

The above equipment has been tested by **Bureau Veritas Consumer Products Services (H.K.) Ltd., Taoyuan Branch**, and found compliance with the requirement of the above standards. The test record, data evaluation & Equipment Under Test (EUT) configurations represented herein are true and accurate accounts of the measurements of the sample's RF characteristics under the conditions specified in this report.

Prepared by :  , Date: Jan. 10, 2022  
Lena Wang / Specialist

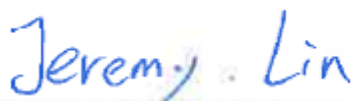
Approved by :  , Date: Jan. 10, 2022  
Jeremy Lin / Project Engineer

## 2 Summary of Test Results

| 47 CFR FCC Part 15, Subpart C (Section 15.247) |  |        |   |
|--|--|--------|---|
| FCC Clause                                     | Test Item                                    | Result | Remarks   |
| 15.207   | AC Power Conducted Emission                  | Pass   | Meet the requirement of limit.<br>Minimum passing margin is -25.48 dB at 0.40179 MHz. |
| 15.205 /<br>15.209 /<br>15.247(d)              | Radiated Emissions and Band Edge Measurement | Pass   | Meet the requirement of limit.<br>Minimum passing margin is -0.3 dB at 2483.50 MHz    |
| 15.247(d)                                      | Antenna Port Emission                        | Pass   | Meet the requirement of limit.  |
| 15.247(a)(2)                                   | 6 dB Bandwidth                               | Pass   | Meet the requirement of limit.  |
| ---  | Occupied Bandwidth Measurement               | Pass   | Reference only  |
| 15.247(b)                                      | Conducted power                              | Pass   | Meet the requirement of limit.  |
| 15.247(e)                                      | Power Spectral Density                       | Pass   | Meet the requirement of limit.  |
| 15.203   | Antenna Requirement                          | Pass   | Antenna connector is U.FL.  |

Note:

- For 2.4G band compliance with rule 15.247(d) of the band-edge items, the test plots were recorded in Annex A. Test Procedures refer to report 4.1.3.
- Determining compliance based on the results of the compliance measurement, not taking into account measurement instrumentation uncertainty.

### 2.1 Measurement Uncertainty

Where relevant, the following measurement uncertainty levels have been estimated for tests performed on the EUT as specified in CISPR 16-4-2:

| Measurement                        | Frequency          | Expanded Uncertainty (k=2) (±) |
|------------------------------------|--------------------|--------------------------------|
| Conducted Emissions at mains ports | 150 kHz ~ 30 MHz   | 2.79 dB                        |
| Radiated Emissions up to 1 GHz     | 9 kHz ~ 30 MHz     | 3.00 dB                        |
|                                    | 30 MHz ~ 200 MHz   | 2.91 dB                        |
|                                    | 200 MHz ~ 1000 MHz | 2.93 dB                        |
| Radiated Emissions above 1 GHz     | 1 GHz ~ 18 GHz     | 1.76 dB                        |
|                                    | 18 GHz ~ 40 GHz    | 1.77 dB                        |

### 2.2 Modification Record

There were no modifications required for compliance.

### 3 General Information

#### 3.1 General Description of EUT

|                              |  |
|------------------------------|--|
| <b>Product</b>               | Open-Q 610 uSOM  |
| <b>Brand</b>                 | Lantronix  |
| <b>Test Model</b>            | Open-Q 610 uSOM  |
| <b>Status of EUT</b>         | Engineering Sample   |
| <b>Power Supply Rating</b>   | 12 Vdc (Adapter)   |
| <b>Modulation Type</b>       | CCK, DQPSK, DBPSK for DSSS<br>256QAM, 64QAM, 16QAM, QPSK, BPSK for OFDM  |
| <b>Modulation Technology</b> | DSSS, OFDM   |
| <b>Transfer Rate</b>         | 802.11b: 11.0 / 5.5 / 2.0 / 1.0 Mbps<br>802.11g: 54.0 / 48.0 / 36.0 / 24.0 / 18.0 / 12.0 / 9.0 / 6.0 Mbps<br>802.11n: up to 150 Mbps<br>802.11ac: up to 200 Mbps |
| <b>Operating Frequency</b>   | 2412 ~ 2462 MHz  |
| <b>Number of Channel</b>     | 11 for 802.11b, 802.11g, 802.11n (HT20), 802.11n (VHT20)<br>7 for 802.11n (HT40), 802.11n (VHT40)  |
| <b>Output Power</b>          | 190.985 mW   |
| <b>Antenna Type</b>          | Refer to Note as below   |
| <b>Antenna Connector</b>     | Refer to Note as below   |
| <b>Accessory Device</b>      | N/A  |
| <b>Data Cable Supplied</b>   | N/A  |

Note:

1. The EUT incorporates a SISO function. Physically, the EUT provides one completed transmitter and one receiver.

| Modulation Mode | Tx Function |
|-----------------|-------------|
| 802.11b         | 1TX         |
| 802.11g         | 1TX         |
| 802.11n (HT20)  | 1TX         |
| 802.11n (HT40)  | 1TX         |
| 802.11n (VHT20) | 1TX         |
| 802.11n (VHT40) | 1TX         |

\* The modulation and bandwidth are similar for 802.11n mode for HT20 / HT40 and 802.11n mode for VHT20 / VHT40, therefore investigated worst case to representative mode in test report. (Final test mode refer section 3.2.1)

2. The following antennas were provided to the EUT.

|                           |                         |                 |
|---------------------------|-------------------------|-----------------|
| <b>Ant. Type</b>          | Flexible Dipole Antenna |                 |
| <b>Connector Type</b>     | U.FL                    |                 |
| <b>Antenna Gain (dBi)</b> |                         |                 |
|                           | <b>2.4~2.5G</b>         | <b>4.9~5.8G</b> |
|                           | 3.32                    | 6.11            |

3. The above Antenna information is declared by manufacturer and for more detailed features description, please refer to the manufacturer's specifications, the laboratory shall not be held responsible.
4. The above EUT information is declared by manufacturer and for more detailed features description, please refers to the manufacturer's specifications or user's manual.

5. The BT could transmit simultaneously with WLAN 5GHz at the same time. The emission of the simultaneous operation has been evaluated and no non-compliance was found.

### 3.2 Description of Test Modes

11 channels are provided for 802.11b, 802.11g and 802.11n (HT20), 802.11n (VHT20):

| Channel | Frequency (MHz) | Channel | Frequency (MHz) |
|---------|-----------------|---------|-----------------|
| 1       | 2412            | 7       | 2442            |
| 2       | 2417            | 8       | 2447            |
| 3       | 2422            | 9       | 2452            |
| 4       | 2427            | 10      | 2457            |
| 5       | 2432            | 11      | 2462            |
| 6       | 2437            |         |                 |

7 channels are provided for 802.11n (HT40), 802.11n (VHT40):

| Channel | Frequency (MHz) | Channel | Frequency (MHz) |
|---------|-----------------|---------|-----------------|
| 3       | 2422            | 7       | 2442            |
| 4       | 2427            | 8       | 2447            |
| 5       | 2432            | 9       | 2452            |
| 6       | 2437            |         |                 |



### 3.2.1 Test Mode Applicability and Tested Channel Detail

| EUT Configure Mode | Applicable To |       |     |      | Description |
|--------------------|---------------|-------|-----|------|-------------|
|                    | RE≥1G         | RE<1G | PLC | APCM |             |
| -                  | √             | √     | √   | √    | -           |

Where **RE≥1G**: Radiated Emission above 1 GHz      **RE<1G**: Radiated Emission below 1 GHz  
**PLC**: Power Line Conducted Emission      **APCM**: Antenna Port Conducted Measurement

**NOTE:** The EUT had been pre-tested on the positioned of each 3 axis. The worst case was found when positioned on **Z-plane**.

**NOTE:** "-" means no effect.

**NOTE:** Radiated emission test (below 1GHz) and power line conducted emission test items chosen the worst fundamental frequency emission level.

#### **Radiated Emission Test (Above 1 GHz):**

- Pre-Scan has been conducted to determine the worst-case mode from all possible combinations between available modulations, data rates and antenna ports (if EUT with antenna diversity architecture).
- Following channel(s) was (were) selected for the final test as listed below.

| EUT Configure Mode | Mode            | Available Channel | Tested Channel | Modulation Technology | Modulation Type | Data Rate (Mbps) |
|--------------------|-----------------|-------------------|----------------|-----------------------|-----------------|------------------|
| -                  | 802.11b         | 1 to 11           | 1, 6, 11       | DSSS                  | DBPSK           | 1.0              |
| -                  | 802.11g         | 1 to 11           | 1, 6, 11       | OFDM                  | BPSK            | 6.0              |
| -                  | 802.11n (VHT20) | 1 to 11           | 1, 6, 11       | OFDM                  | BPSK            | MCS0             |
| -                  | 802.11n (VHT40) | 3 to 9            | 3, 6, 9        | OFDM                  | BPSK            | MCS0             |

#### **Radiated Emission Test (Below 1 GHz):**

- Pre-Scan has been conducted to determine the worst-case mode from all possible combinations between available modulations, data rates and antenna ports (if EUT with antenna diversity architecture).
- Following channel(s) was (were) selected for the final test as listed below.

| EUT Configure Mode | Mode    | Available Channel | Tested Channel | Modulation Technology | Modulation Type | Data Rate (Mbps) |
|--------------------|---------|-------------------|----------------|-----------------------|-----------------|------------------|
| -                  | 802.11g | 1 to 11           | 6              | OFDM                  | BPSK            | 6.0              |

#### **Power Line Conducted Emission Test:**

- Pre-Scan has been conducted to determine the worst-case mode from all possible combinations between available modulations, data rates and antenna ports (if EUT with antenna diversity architecture).
- Following channel(s) was (were) selected for the final test as listed below.

| EUT Configure Mode | Mode    | Available Channel | Tested Channel | Modulation Technology | Modulation Type | Data Rate (Mbps) |
|--------------------|---------|-------------------|----------------|-----------------------|-----------------|------------------|
| -                  | 802.11g | 1 to 11           | 6              | OFDM                  | BPSK            | 6.0              |

**Bandedge Measurement:**

- Pre-Scan has been conducted to determine the worst-case mode from all possible combinations between available modulations, data rates and antenna ports (if EUT with antenna diversity architecture).
- Following channel(s) was (were) selected for the final test as listed below.

| EUT Configure Mode | Mode            | Available Channel | Tested Channel | Modulation Technology | Modulation Type | Data Rate (Mbps) |
|--------------------|-----------------|-------------------|----------------|-----------------------|-----------------|------------------|
| -                  | 802.11b         | 1 to 11           | 1, 11          | DSSS                  | DBPSK           | 1.0              |
| -                  | 802.11g         | 1 to 11           | 1, 11          | OFDM                  | BPSK            | 6.0              |
| -                  | 802.11n (VHT20) | 1 to 11           | 1, 11          | OFDM                  | BPSK            | MCS0             |
| -                  | 802.11n (VHT40) | 3 to 9            | 3, 9           | OFDM                  | BPSK            | MCS0             |

**Antenna Port Conducted Measurement:**

- This item includes all test value of each mode, but only includes spectrum plot of worst value of each mode.
- Pre-Scan has been conducted to determine the worst-case mode from all possible combinations between available modulations, data rates and antenna ports (if EUT with antenna diversity architecture).
- Following channel(s) was (were) selected for the final test as listed below.

| EUT Configure Mode | Mode            | Available Channel | Tested Channel | Modulation Technology | Modulation Type | Data Rate (Mbps) |
|--------------------|-----------------|-------------------|----------------|-----------------------|-----------------|------------------|
| -                  | 802.11b         | 1 to 11           | 1, 6, 11       | DSSS                  | DBPSK           | 1.0              |
| -                  | 802.11g         | 1 to 11           | 1, 6, 11       | OFDM                  | BPSK            | 6.0              |
| -                  | 802.11n (HT20)  | 1 to 11           | 1, 6, 11       | OFDM                  | BPSK            | 6.5              |
| -                  | 802.11n (HT40)  | 3 to 9            | 3, 6, 9        | OFDM                  | BPSK            | 13.5             |
| -                  | 802.11n (VHT20) | 1 to 11           | 1, 6, 11       | OFDM                  | BPSK            | MCS0             |
| -                  | 802.11n (VHT40) | 3 to 9            | 3, 6, 9        | OFDM                  | BPSK            | MCS0             |

**Test Condition:**

| Applicable To | Environmental Conditions | Input Power    | Tested by  |
|---------------|--------------------------|----------------|------------|
| RE≥1G         | 25 deg. C, 65 % RH       | 120 Vac, 60 Hz | Titan Hsu  |
| RE<1G         | 25 deg. C, 65 % RH       | 120 Vac, 60 Hz | Adair Peng |
| PLC           | 25 deg. C, 65 % RH       | 120 Vac, 60 Hz | Rex Wang   |
| APCM          | 25 deg. C, 65 % RH       | 120 Vac, 60 Hz | Ivan Tseng |

### 3.3 Duty Cycle of Test Signal

**802.11b:** Duty cycle =  $12.175/12.312 = 0.989$ , Duty cycle of test signal is  $\geq 98\%$ , duty factor is not required.

**802.11g:** Duty cycle =  $2.025/2.065 = 0.981$ , Duty cycle of test signal is  $\geq 98\%$ , duty factor is not required.

Duty cycle of test signal is  $< 98\%$ , duty factor shall be considered.

**802.11n (VHT20):** Duty cycle =  $1.896/1.938 = 0.978$ , Duty factor =  $10 * \log(1/0.978) = 0.10$

**802.11n (VHT40):** Duty cycle =  $0.936/0.987 = 0.948$ , Duty factor =  $10 * \log(1/0.948) = 0.23$

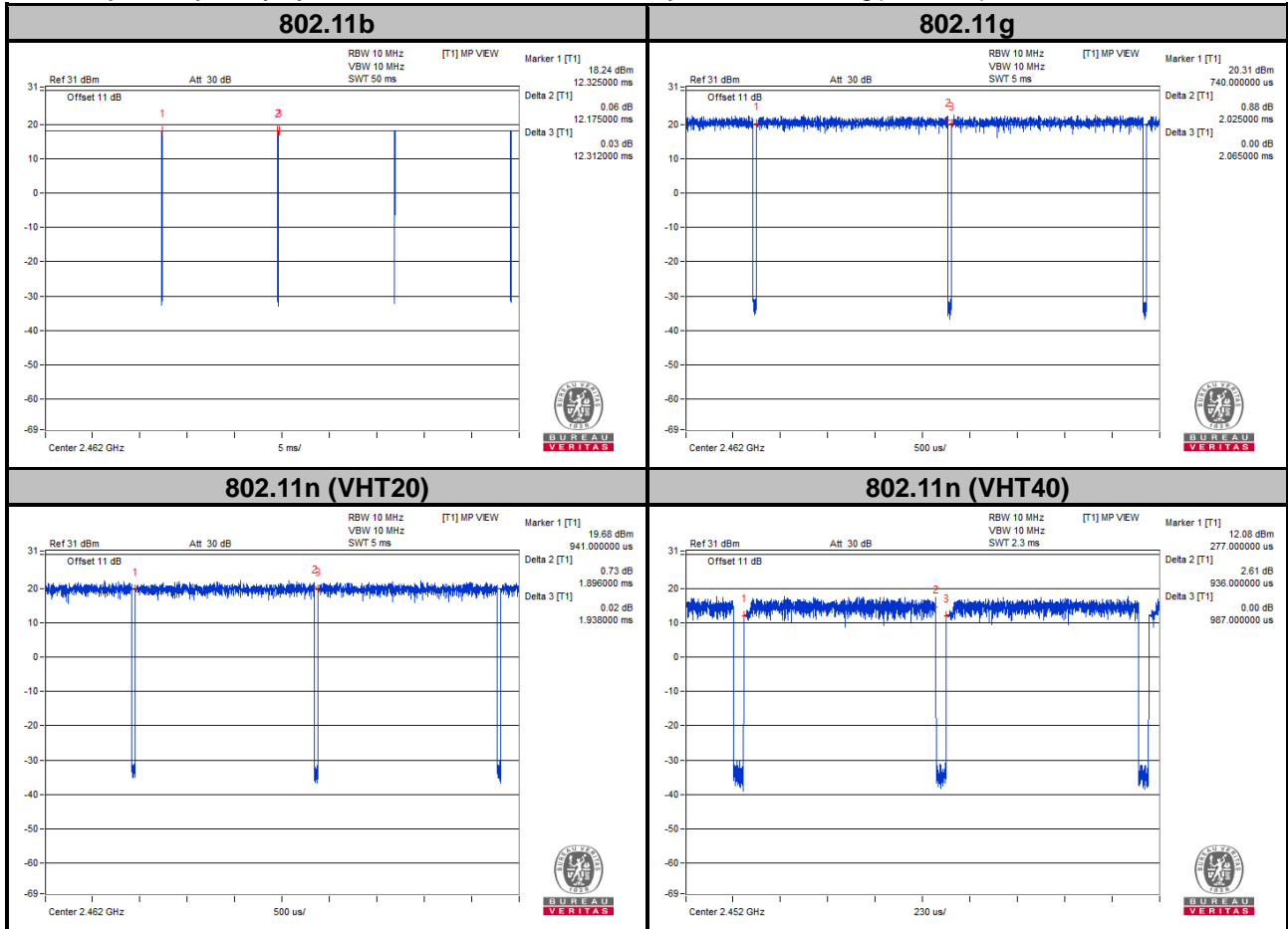

### 3.4 Description of Support Units

The EUT has been tested as an independent unit together with other necessary accessories or support units. The following support units or accessories were used to form a representative test configuration during the tests.

| ID | Product  | Brand       | Model No.        | Serial No. | FCC ID | Remarks            |
|----|----------|-------------|------------------|------------|--------|--------------------|
| A  | Notebook | Lenovo      | 20J4 MD A003TW   | PF-11H9AK  | N/A    | -                  |
| B  | Jig      | N/A         | N/A              | N/A        | N/A    | Provided by client |
| C  | Adapter  | YINGHUIYUAN | YHY-12003000     | N/A        | N/A    | Provided by client |
| D  | Antenna  | Taoglas     | FXP.830.07.0100C | N/A        | N/A    | Provided by client |

Note:

1. All power cords of the above support units are non-shielded (1.8m).
2. Item A acted as a communication partner to transfer data.

| ID | Cable Descriptions | Qty. | Length (m) | Shielding (Yes/No) | Cores (Qty.) | Remarks            |
|----|--------------------|------|------------|--------------------|--------------|--------------------|
| 1. | Type C USB Cable   | 1    | 1          | Y                  | 0            | Provided by client |
| 2. | Adapter Cable      | 1    | 1.2        | Y                  | 1            | Provided by client |
| 3. | Power Cable        | 1    | 1.15       | N                  | 0            | Provided by client |

#### 3.4.1 Configuration of System under Test

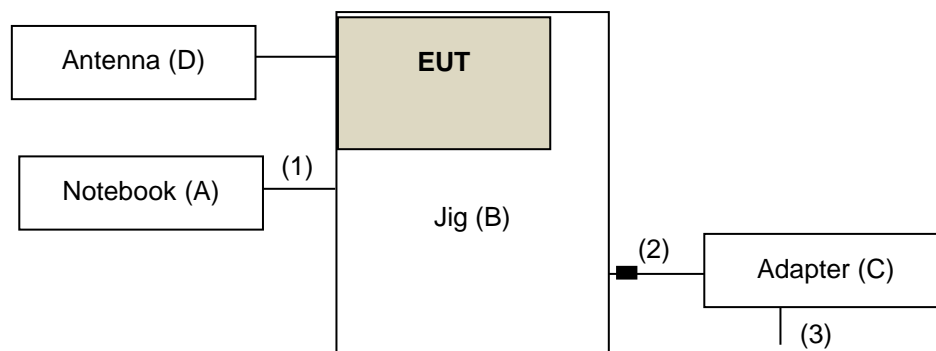

### 3.5 General Description of Applied Standards and References

The EUT is a RF Product. According to the specifications of the manufacturer, it must comply with the requirements of the following standards and references:

#### Test Standard:

#### FCC Part 15, Subpart C (15.247)

ANSI C63.10-2013

All test items have been performed and recorded as per the above standards.

#### References Test Guidance:

#### KDB 558074 D01 Meas Guidance v05r02

All test items have been performed as a reference to the above KDB test guidance.

## 4 Test Types and Results

### 4.1 Radiated Emission and Bandedge Measurement

#### 4.1.1 Limits of Radiated Emission and Bandedge Measurement

Radiated emissions which fall in the restricted bands must comply with the radiated emission limits specified as below table. Other emissions shall be at least 20 dB below the highest level of the desired power:

| Frequencies (MHz) | Field Strength (microvolts/meter) | Measurement Distance (meters) |
|-------------------|-----------------------------------|-------------------------------|
| 0.009 ~ 0.490     | 2400/F (kHz)                      | 300                           |
| 0.490 ~ 1.705     | 24000/F (kHz)                     | 30                            |
| 1.705 ~ 30.0      | 30                                | 30                            |
| 30 ~ 88           | 100                               | 3                             |
| 88 ~ 216          | 150                               | 3                             |
| 216 ~ 960         | 200                               | 3                             |
| Above 960         | 500                               | 3                             |

**NOTE:**

1. The lower limit shall apply at the transition frequencies.
2. Emission level (dBuV/m) = 20 log Emission level (uV/m).
3. For frequencies above 1000 MHz, the field strength limits are based on average detector, however, the peak field strength of any emission shall not exceed the maximum permitted average limits, specified above by more than 20 dB under any condition of modulation.

#### 4.1.2 Test Instruments

| Description & Manufacturer               | Model No.                              | Serial No.  | Date of Calibration | Due Date of Calibration |
|--|--|---|---------------------|-------------------------|
| Test Receiver<br>Rohde & Schwarz         | N9038A                                 | MY55420137  | Apr. 09, 2021       | Apr. 08, 2022           |
| Spectrum Analyzer<br>KEYSIGHT            | N9020B                                 | MY60110440  | Dec. 18, 2020       | Dec. 17, 2021           |
| BILOG Antenna<br>SCHWARZBECK             | VULB9168                               | 1213  | Nov. 04, 2020       | Nov. 03, 2021           |
| HORN Antenna<br>SCHWARZBECK              | BBHA 9120 D                            | 9120D-563   | Nov. 22, 2020       | Nov. 21, 2021           |
| HORN Antenna<br>SCHWARZBECK              | BBHA 9170                              | 995   | Nov. 22, 2020       | Nov. 21, 2021           |
| Loop Antenna<br>EMCI                     | EM-6879                                | 269   | Sep. 17, 2020       | Sep. 16, 2021           |
|  |  |   | Sep. 16, 2021       | Sep. 15, 2022           |
| Loop Antenna<br>TESEQ                    | HLA 6121                               | 45745   | Jul. 21, 2021       | Jul. 20, 2022           |
| Preamplifier<br>EMCI                     | EMC330N                                | 980782  | Jan. 12, 2021       | Jan. 11, 2022           |
| Preamplifier<br>EMCI                     | EMC118A45SE                            | 980808  | Jan. 12, 2021       | Jan. 11, 2022           |
| Preamplifier<br>EMCI                     | EMC184045SE                            | 980788  | Jan. 12, 2021       | Jan. 11, 2022           |
| RF signal cable<br>EMCI                  | EMC104-SM-SM-<br>(9000+2000+1000)      | 201243+ 201231+<br>210102                           | Jan. 12, 2021       | Jan. 11, 2022           |
| RF signal cable<br>EMCI                  | EMCCFD400-NM-<br>NM-<br>(9000+300+500) | 201236+ 201235+<br>201233                           | Jan. 12, 2021       | Jan. 11, 2022           |
| RF signal cable<br>EMCI                  | EMC101G-KM-KM-<br>(5000+3000+2000)     | 201260+201257+2<br>01254                            | Jan. 12, 2021       | Jan. 11, 2022           |
| Software<br>BV ADT                       | ADT_Radiated_V7.<br>6.15.9.5           | NA  | NA                  | NA                      |
| Antenna Tower<br>Max-Full                | MFT-151SS-0.5T                         | NA  | NA                  | NA                      |
| Turn Table<br>Max-Full                   | MF-7802BS                              | NA  | NA                  | NA                      |
| Turn Table Controller<br>Max-Full        | MF-7802BS                              | MF780208674   | NA                  | NA                      |
| USB Wideband Power<br>Sensor<br>KEYSIGHT | U2021XA                                | MY55050005/MY551<br>90004/MY55190007/<br>MY55210005 | Jul. 12, 2021       | Jul. 11, 2022           |

- Note: 1. The calibration interval of the above test instruments is 12 months and the calibrations are traceable to NML/ROC and NIST/USA.
2. The test was performed in WM Chamber 8.

#### 4.1.3 Test Procedures

##### **For Radiated Emission below 30 MHz**

- a. The EUT was placed on the top of a rotating table 0.8 meters above the ground at a 3 meter chamber room. The table was rotated 360 degrees to determine the position of the highest radiation.
- b. The EUT was set 3 meters away from the interference-receiving antenna, which was mounted on the top of a variable-height antenna tower.
- c. Parallel, perpendicular, and ground-parallel orientations of the antenna are set to make the measurement.
- d. For each suspected emission, the EUT was arranged to its worst case and the rotatable table was turned from 0 degrees to 360 degrees to find the maximum reading.
- e. The test-receiver system was set to Quasi-Peak Detect Function and Specified Bandwidth with Maximum Hold Mode.

##### **Note:**

1. The resolution bandwidth and video bandwidth of test receiver/spectrum analyzer is 9 kHz at frequency below 30 MHz.

##### **For Radiated Emission above 30 MHz**

- a. The EUT was placed on the top of a rotating table 0.8 meters (for 30 MHz ~ 1 GHz) / 1.5 meters (for above 1 GHz) above the ground at 3 meter chamber room for test. The table was rotated 360 degrees to determine the position of the highest radiation.
- b. The EUT was set 3 meters away from the interference-receiving antenna, which was mounted on the top of a variable-height antenna tower.
- c. The height of antenna is varied from one meter to four meters above the ground to determine the maximum value of the field strength. Both horizontal and vertical polarizations of the antenna are set to make the measurement.
- d. For each suspected emission, the EUT was arranged to its worst case and then the antenna was tuned to heights from 1 meter to 4 meters and the rotatable table was turned from 0 degrees to 360 degrees to find the maximum reading.
- e. The test-receiver system was set to quasi-peak detect function and specified bandwidth with maximum hold mode when the test frequency is below 1 GHz.
- f. The test-receiver system was set to peak and average detected function and specified bandwidth with maximum hold mode when the test frequency is above 1 GHz. If the peak reading value also meets average limit, measurement with the average detector is unnecessary.

##### **Note:**

1. The resolution bandwidth and video bandwidth of test receiver/spectrum analyzer is 120 kHz for Quasi-peak detection (QP) or Peak detection (PK) at frequency below 1 GHz.
2. The resolution bandwidth of test receiver/spectrum analyzer is 1 MHz and the video bandwidth is 3 MHz for Peak detection (PK) at frequency above 1 GHz.
3. The resolution bandwidth of test receiver/spectrum analyzer is 1 MHz and the video bandwidth is  $\geq 1/T$  (Duty cycle < 98 %) or 10 Hz (Duty cycle  $\geq 98$  %) for Average detection (AV) at frequency above 1 GHz.  
(11b: RBW = 1 MHz, VBW = 10 Hz ; 11g: RBW = 1 MHz, VBW = 10 Hz ;  
11n (VHT20): RBW = 1 MHz, VBW = 1 kHz ; 11n (VHT40): RBW = 1 MHz, VBW = 3 kHz)
4. All modes of operation were investigated and the worst-case emissions are reported.

4.1.4 Deviation from Test Standard

No deviation.

4.1.5 Test Set Up

<Radiated Emission below 30 MHz>

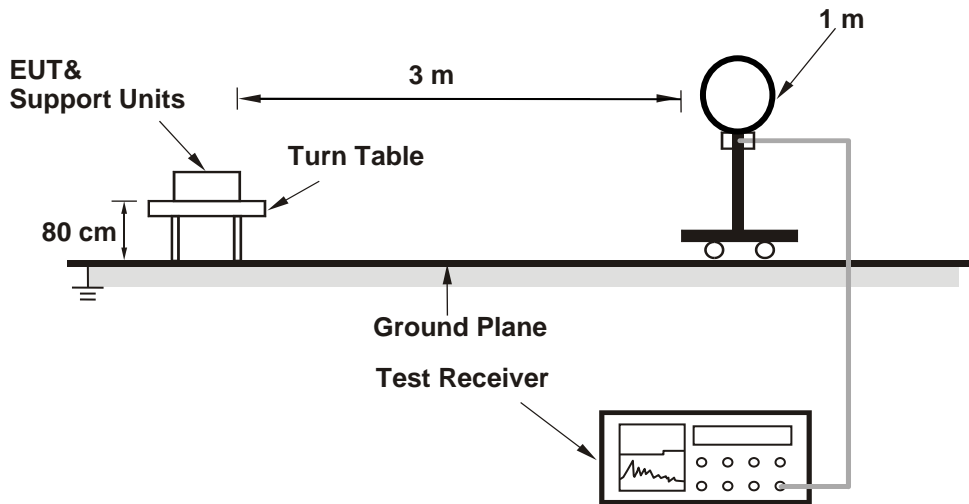

<Radiated Emission 30 MHz to 1 GHz>

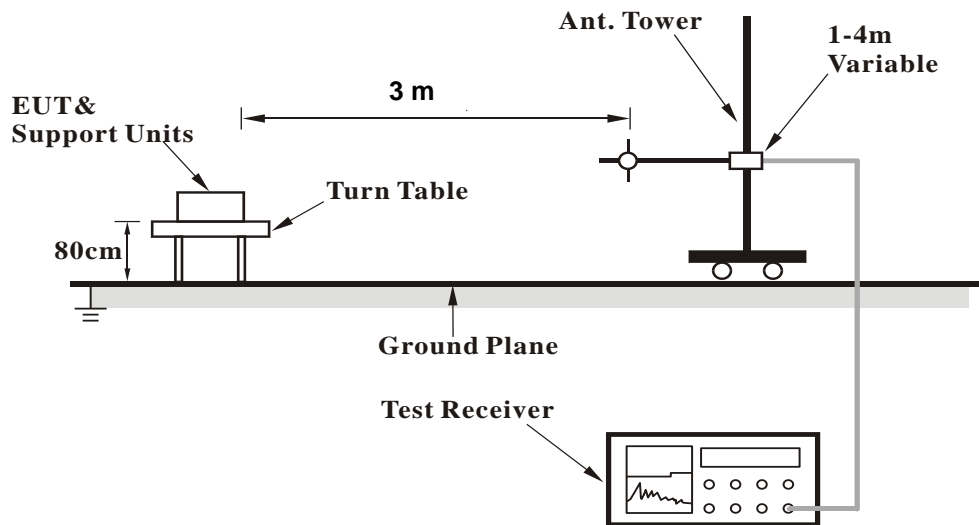



**<Radiated Emission above 1 GHz>**

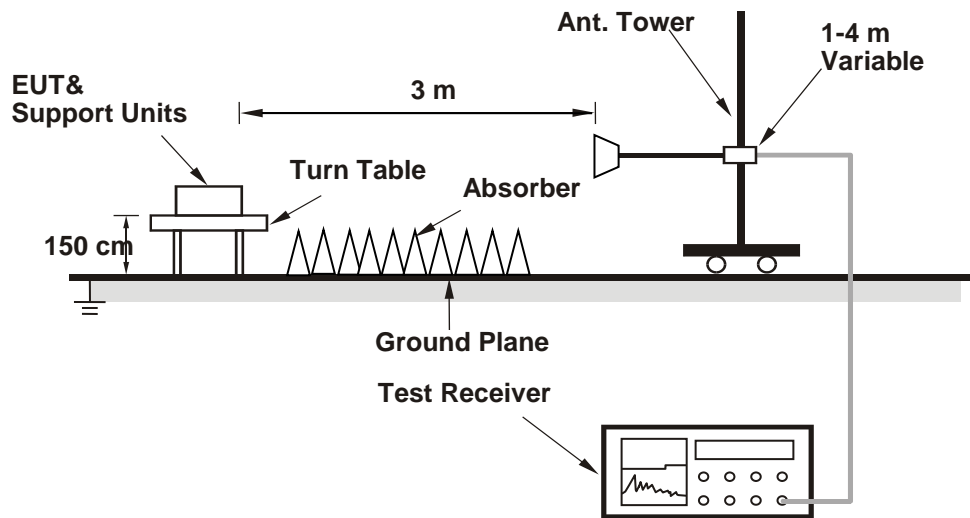

For the actual test configuration, please refer to the attached file (Test Setup Photo).

**4.1.6 EUT Operating Conditions**

- a. Placed the EUT on a testing table.
- b. Use the software to control the EUT under transmission condition continuously at specific channel frequency.

4.1.7 Test Results

Above 1 GHz Data :

802.11b

|                        |              |                          |                           |
|------------------------|--------------|--------------------------|---------------------------|
| <b>RF Mode</b>         | TX 802.11b   | <b>Channel</b>           | CH 1 : 2412 MHz           |
| <b>Frequency Range</b> | 1GHz ~ 25GHz | <b>Detector Function</b> | Peak (PK)<br>Average (AV) |

| Antenna Polarity & Test Distance : Horizontal at 3 m |                 |                         |                |             |                    |                      |                  |                          |
|--|-----------------|-------------------------|----------------|-------------|--------------------|----------------------|------------------|--------------------------|
| No   | Frequency (MHz) | Emission Level (dBuV/m) | Limit (dBuV/m) | Margin (dB) | Antenna Height (m) | Table Angle (Degree) | Raw Value (dBuV) | Correction Factor (dB/m) |
| 1  | 2390.00         | 55.8 PK                 | 74.0           | -18.2       | 1.12 H             | 294                  | 24.1             | 31.7                     |
| 2  | 2390.00         | 43.4 AV                 | 54.0           | -10.6       | 1.12 H             | 294                  | 11.7             | 31.7                     |
| 3  | *2412.00        | 100.3 PK                |                |             | 1.12 H             | 294                  | 68.6             | 31.7                     |
| 4  | *2412.00        | 97.6 AV                 |                |             | 1.12 H             | 294                  | 65.9             | 31.7                     |
| 5  | 4824.00         | 49.2 PK                 | 74.0           | -24.8       | 3.83 H             | 59                   | 46.8             | 2.4                      |
| 6  | 4824.00         | 42.2 AV                 | 54.0           | -11.8       | 3.83 H             | 59                   | 39.8             | 2.4                      |
| Antenna Polarity & Test Distance : Vertical at 3 m   |                 |                         |                |             |                    |                      |                  |                          |
| No   | Frequency (MHz) | Emission Level (dBuV/m) | Limit (dBuV/m) | Margin (dB) | Antenna Height (m) | Table Angle (Degree) | Raw Value (dBuV) | Correction Factor (dB/m) |
| 1  | 2390.00         | 56.4 PK                 | 74.0           | -17.6       | 2.74 V             | 250                  | 24.7             | 31.7                     |
| 2  | 2390.00         | 43.3 AV                 | 54.0           | -10.7       | 2.74 V             | 250                  | 11.6             | 31.7                     |
| 3  | *2412.00        | 104.4 PK                |                |             | 2.74 V             | 250                  | 72.7             | 31.7                     |
| 4  | *2412.00        | 101.8 AV                |                |             | 2.74 V             | 250                  | 70.1             | 31.7                     |
| 5  | 4824.00         | 57.0 PK                 | 74.0           | -17.0       | 1.25 V             | 265                  | 54.6             | 2.4                      |
| 6  | 4824.00         | 53.2 AV                 | 54.0           | -0.8        | 1.25 V             | 265                  | 50.8             | 2.4                      |

Remarks:

1. Emission Level(dBuV/m) = Raw Value(dBuV) + Correction Factor(dB/m)
2. Correction Factor(dB/m) = Antenna Factor(dB/m) + Cable Factor(dB) – Pre-Amplifier Factor(dB)
3. Margin value = Emission Level – Limit value
4. The other emission levels were very low against the limit.
5. " \* ": Fundamental frequency.

|                        |              |                          |                           |
|------------------------|--------------|--------------------------|---------------------------|
| <b>RF Mode</b>         | TX 802.11b   | <b>Channel</b>           | CH 6 : 2437 MHz           |
| <b>Frequency Range</b> | 1GHz ~ 25GHz | <b>Detector Function</b> | Peak (PK)<br>Average (AV) |

**Antenna Polarity & Test Distance : Horizontal at 3 m**

| No | Frequency (MHz) | Emission Level (dBuV/m) | Limit (dBuV/m) | Margin (dB) | Antenna Height (m) | Table Angle (Degree) | Raw Value (dBuV) | Correction Factor (dB/m) |
|----|-----------------|-------------------------|----------------|-------------|--------------------|----------------------|------------------|--------------------------|
| 1  | *2437.00        | 103.9 PK                |                |             | 1.25 H             | 293                  | 72.1             | 31.8                     |
| 2  | *2437.00        | 101.1 AV                |                |             | 1.25 H             | 293                  | 69.3             | 31.8                     |
| 3  | 4874.00         | 49.1 PK                 | 74.0           | -24.9       | 2.83 H             | 56                   | 46.6             | 2.5                      |
| 4  | 4874.00         | 42.9 AV                 | 54.0           | -11.1       | 2.83 H             | 56                   | 40.4             | 2.5                      |

**Antenna Polarity & Test Distance : Vertical at 3 m**

| No | Frequency (MHz) | Emission Level (dBuV/m) | Limit (dBuV/m) | Margin (dB) | Antenna Height (m) | Table Angle (Degree) | Raw Value (dBuV) | Correction Factor (dB/m) |
|----|-----------------|-------------------------|----------------|-------------|--------------------|----------------------|------------------|--------------------------|
| 1  | *2437.00        | 108.0 PK                |                |             | 2.23 V             | 262                  | 76.2             | 31.8                     |
| 2  | *2437.00        | 105.0 AV                |                |             | 2.23 V             | 262                  | 73.2             | 31.8                     |
| 3  | 4874.00         | 53.7 PK                 | 74.0           | -20.3       | 1.32 V             | 263                  | 51.2             | 2.5                      |
| 4  | 4874.00         | 53.0 AV                 | 54.0           | -1.0        | 1.32 V             | 263                  | 50.5             | 2.5                      |

**Remarks:**

1. Emission Level(dBuV/m) = Raw Value(dBuV) + Correction Factor(dB/m)
2. Correction Factor(dB/m) = Antenna Factor(dB/m) + Cable Factor(dB) – Pre-Amplifier Factor(dB)
3. Margin value = Emission Level – Limit value
4. The other emission levels were very low against the limit.
5. " \* ": Fundamental frequency.

|                        |              |                          |                           |
|------------------------|--------------|--------------------------|---------------------------|
| <b>RF Mode</b>         | TX 802.11b   | <b>Channel</b>           | CH 11 : 2462 MHz          |
| <b>Frequency Range</b> | 1GHz ~ 25GHz | <b>Detector Function</b> | Peak (PK)<br>Average (AV) |

**Antenna Polarity & Test Distance : Horizontal at 3 m**

| No | Frequency (MHz) | Emission Level (dBuV/m) | Limit (dBuV/m) | Margin (dB) | Antenna Height (m) | Table Angle (Degree) | Raw Value (dBuV) | Correction Factor (dB/m) |
|----|-----------------|-------------------------|----------------|-------------|--------------------|----------------------|------------------|--------------------------|
| 1  | *2462.00        | 102.0 PK                |                |             | 1.09 H             | 294                  | 70.2             | 31.8                     |
| 2  | *2462.00        | 99.3 AV                 |                |             | 1.09 H             | 294                  | 67.5             | 31.8                     |
| 3  | 2483.50         | 56.3 PK                 | 74.0           | -17.7       | 1.09 H             | 294                  | 24.4             | 31.9                     |
| 4  | 2483.50         | 45.3 AV                 | 54.0           | -8.7        | 1.09 H             | 294                  | 13.4             | 31.9                     |
| 5  | 4924.00         | 49.7 PK                 | 74.0           | -24.3       | 2.27 H             | 306                  | 47.1             | 2.6                      |
| 6  | 4924.00         | 42.8 AV                 | 54.0           | -11.2       | 2.27 H             | 306                  | 40.2             | 2.6                      |

**Antenna Polarity & Test Distance : Vertical at 3 m**

| No | Frequency (MHz) | Emission Level (dBuV/m) | Limit (dBuV/m) | Margin (dB) | Antenna Height (m) | Table Angle (Degree) | Raw Value (dBuV) | Correction Factor (dB/m) |
|----|-----------------|-------------------------|----------------|-------------|--------------------|----------------------|------------------|--------------------------|
| 1  | *2462.00        | 106.6 PK                |                |             | 2.53 V             | 231                  | 74.8             | 31.8                     |
| 2  | *2462.00        | 103.6 AV                |                |             | 2.53 V             | 231                  | 71.8             | 31.8                     |
| 3  | 2483.50         | 58.2 PK                 | 74.0           | -15.8       | 2.53 V             | 231                  | 26.3             | 31.9                     |
| 4  | 2483.50         | 45.7 AV                 | 54.0           | -8.3        | 2.53 V             | 231                  | 13.8             | 31.9                     |
| 5  | 4924.00         | 56.2 PK                 | 74.0           | -17.8       | 1.28 V             | 268                  | 53.6             | 2.6                      |
| 6  | 4924.00         | 53.5 AV                 | 54.0           | -0.5        | 1.28 V             | 268                  | 50.9             | 2.6                      |

**Remarks:**

1. Emission Level(dBuV/m) = Raw Value(dBuV) + Correction Factor(dB/m)
2. Correction Factor(dB/m) = Antenna Factor(dB/m) + Cable Factor(dB) – Pre-Amplifier Factor(dB)
3. Margin value = Emission Level – Limit value
4. The other emission levels were very low against the limit.
5. " \* ": Fundamental frequency.

802.11g

|                        |              |                          |                           |
|------------------------|--------------|--------------------------|---------------------------|
| <b>RF Mode</b>         | TX 802.11g   | <b>Channel</b>           | CH 1 : 2412 MHz           |
| <b>Frequency Range</b> | 1GHz ~ 25GHz | <b>Detector Function</b> | Peak (PK)<br>Average (AV) |

| Antenna Polarity & Test Distance : Horizontal at 3 m |                 |                         |                |             |                    |                      |                  |                          |
|--|-----------------|-------------------------|----------------|-------------|--------------------|----------------------|------------------|--------------------------|
| No   | Frequency (MHz) | Emission Level (dBuV/m) | Limit (dBuV/m) | Margin (dB) | Antenna Height (m) | Table Angle (Degree) | Raw Value (dBuV) | Correction Factor (dB/m) |
| 1  | 2390.00         | 64.4 PK                 | 74.0           | -9.6        | 1.12 H             | 293                  | 32.7             | 31.7                     |
| 2  | 2390.00         | 50.0 AV                 | 54.0           | -4.0        | 1.12 H             | 293                  | 18.3             | 31.7                     |
| 3  | *2412.00        | 108.7 PK                |                |             | 1.12 H             | 293                  | 77.0             | 31.7                     |
| 4  | *2412.00        | 98.9 AV                 |                |             | 1.12 H             | 293                  | 67.2             | 31.7                     |
| 5  | 4824.00         | 51.5 PK                 | 74.0           | -22.5       | 3.87 H             | 46                   | 49.1             | 2.4                      |
| 6  | 4824.00         | 38.7 AV                 | 54.0           | -15.3       | 3.87 H             | 46                   | 36.3             | 2.4                      |

| Antenna Polarity & Test Distance : Vertical at 3 m |                 |                         |                |             |                    |                      |                  |                          |
|--|-----------------|-------------------------|----------------|-------------|--------------------|----------------------|------------------|--------------------------|
| No   | Frequency (MHz) | Emission Level (dBuV/m) | Limit (dBuV/m) | Margin (dB) | Antenna Height (m) | Table Angle (Degree) | Raw Value (dBuV) | Correction Factor (dB/m) |
| 1  | 2390.00         | 67.2 PK                 | 74.0           | -6.8        | 1.26 V             | 294                  | 35.5             | 31.7                     |
| 2  | 2390.00         | 53.1 AV                 | 54.0           | -0.9        | 1.26 V             | 294                  | 21.4             | 31.7                     |
| 3  | *2412.00        | 113.7 PK                |                |             | 1.26 V             | 294                  | 82.0             | 31.7                     |
| 4  | *2412.00        | 104.0 AV                |                |             | 1.26 V             | 294                  | 72.3             | 31.7                     |
| 5  | 4824.00         | 61.1 PK                 | 74.0           | -12.9       | 1.09 V             | 305                  | 58.7             | 2.4                      |
| 6  | 4824.00         | 47.4 AV                 | 54.0           | -6.6        | 1.09 V             | 305                  | 45.0             | 2.4                      |

**Remarks:**

1. Emission Level(dBuV/m) = Raw Value(dBuV) + Correction Factor(dB/m)
2. Correction Factor(dB/m) = Antenna Factor(dB/m) + Cable Factor(dB) – Pre-Amplifier Factor(dB)
3. Margin value = Emission Level – Limit value
4. The other emission levels were very low against the limit.
5. " \* ": Fundamental frequency.

|                        |              |                          |                           |
|------------------------|--------------|--------------------------|---------------------------|
| <b>RF Mode</b>         | TX 802.11g   | <b>Channel</b>           | CH 6 : 2437 MHz           |
| <b>Frequency Range</b> | 1GHz ~ 25GHz | <b>Detector Function</b> | Peak (PK)<br>Average (AV) |

**Antenna Polarity & Test Distance : Horizontal at 3 m**

| No | Frequency (MHz) | Emission Level (dBuV/m) | Limit (dBuV/m) | Margin (dB) | Antenna Height (m) | Table Angle (Degree) | Raw Value (dBuV) | Correction Factor (dB/m) |
|----|-----------------|-------------------------|----------------|-------------|--------------------|----------------------|------------------|--------------------------|
| 1  | *2437.00        | 111.4 PK                |                |             | 1.11 H             | 293                  | 79.6             | 31.8                     |
| 2  | *2437.00        | 102.0 AV                |                |             | 1.11 H             | 293                  | 70.2             | 31.8                     |
| 3  | 2483.50         | 63.1 PK                 | 74.0           | -10.9       | 1.11 H             | 293                  | 31.2             | 31.9                     |
| 4  | 2483.50         | 50.2 AV                 | 54.0           | -3.8        | 1.11 H             | 293                  | 18.3             | 31.9                     |
| 5  | 4874.00         | 49.2 PK                 | 74.0           | -24.8       | 3.56 H             | 49                   | 46.7             | 2.5                      |
| 6  | 4874.00         | 36.8 AV                 | 54.0           | -17.2       | 3.56 H             | 49                   | 34.3             | 2.5                      |

**Antenna Polarity & Test Distance : Vertical at 3 m**

| No | Frequency (MHz) | Emission Level (dBuV/m) | Limit (dBuV/m) | Margin (dB) | Antenna Height (m) | Table Angle (Degree) | Raw Value (dBuV) | Correction Factor (dB/m) |
|----|-----------------|-------------------------|----------------|-------------|--------------------|----------------------|------------------|--------------------------|
| 1  | *2437.00        | 116.9 PK                |                |             | 1.40 V             | 294                  | 85.1             | 31.8                     |
| 2  | *2437.00        | 107.0 AV                |                |             | 1.40 V             | 294                  | 75.2             | 31.8                     |
| 3  | 2483.50         | 67.5 PK                 | 74.0           | -6.5        | 1.40 V             | 294                  | 35.6             | 31.9                     |
| 4  | 2483.50         | 53.3 AV                 | 54.0           | -0.7        | 1.40 V             | 294                  | 21.4             | 31.9                     |
| 5  | 4874.00         | 56.9 PK                 | 74.0           | -17.1       | 1.03 V             | 302                  | 54.4             | 2.5                      |
| 6  | 4874.00         | 44.6 AV                 | 54.0           | -9.4        | 1.03 V             | 302                  | 42.1             | 2.5                      |

**Remarks:**

1. Emission Level(dBuV/m) = Raw Value(dBuV) + Correction Factor(dB/m)
2. Correction Factor(dB/m) = Antenna Factor(dB/m) + Cable Factor(dB) – Pre-Amplifier Factor(dB)
3. Margin value = Emission Level – Limit value
4. The other emission levels were very low against the limit.
5. " \* ": Fundamental frequency.

|                        |              |                          |                           |
|------------------------|--------------|--------------------------|---------------------------|
| <b>RF Mode</b>         | TX 802.11g   | <b>Channel</b>           | CH 11 : 2462 MHz          |
| <b>Frequency Range</b> | 1GHz ~ 25GHz | <b>Detector Function</b> | Peak (PK)<br>Average (AV) |

**Antenna Polarity & Test Distance : Horizontal at 3 m**

| No | Frequency (MHz) | Emission Level (dBuV/m) | Limit (dBuV/m) | Margin (dB) | Antenna Height (m) | Table Angle (Degree) | Raw Value (dBuV) | Correction Factor (dB/m) |
|----|-----------------|-------------------------|----------------|-------------|--------------------|----------------------|------------------|--------------------------|
| 1  | *2462.00        | 106.5 PK                |                |             | 1.10 H             | 295                  | 74.7             | 31.8                     |
| 2  | *2462.00        | 96.7 AV                 |                |             | 1.10 H             | 295                  | 64.9             | 31.8                     |
| 3  | 2483.50         | 62.8 PK                 | 74.0           | -11.2       | 1.10 H             | 295                  | 30.9             | 31.9                     |
| 4  | 2483.50         | 50.3 AV                 | 54.0           | -3.7        | 1.10 H             | 295                  | 18.4             | 31.9                     |
| 5  | 4924.00         | 49.8 PK                 | 74.0           | -24.2       | 3.82 H             | 48                   | 47.2             | 2.6                      |
| 6  | 4924.00         | 36.3 AV                 | 54.0           | -17.7       | 3.82 H             | 48                   | 33.7             | 2.6                      |

**Antenna Polarity & Test Distance : Vertical at 3 m**

| No | Frequency (MHz) | Emission Level (dBuV/m) | Limit (dBuV/m) | Margin (dB) | Antenna Height (m) | Table Angle (Degree) | Raw Value (dBuV) | Correction Factor (dB/m) |
|----|-----------------|-------------------------|----------------|-------------|--------------------|----------------------|------------------|--------------------------|
| 1  | *2462.00        | 111.7 PK                |                |             | 1.55 V             | 293                  | 79.9             | 31.8                     |
| 2  | *2462.00        | 102.1 AV                |                |             | 1.55 V             | 293                  | 70.3             | 31.8                     |
| 3  | 2483.50         | 67.1 PK                 | 74.0           | -6.9        | 1.55 V             | 293                  | 35.2             | 31.9                     |
| 4  | 2483.50         | 53.1 AV                 | 54.0           | -0.9        | 1.55 V             | 293                  | 21.2             | 31.9                     |
| 5  | 4924.00         | 56.7 PK                 | 74.0           | -17.3       | 1.00 V             | 302                  | 54.1             | 2.6                      |
| 6  | 4924.00         | 43.5 AV                 | 54.0           | -10.5       | 1.00 V             | 302                  | 40.9             | 2.6                      |

**Remarks:**

1. Emission Level(dBuV/m) = Raw Value(dBuV) + Correction Factor(dB/m)
2. Correction Factor(dB/m) = Antenna Factor(dB/m) + Cable Factor(dB) – Pre-Amplifier Factor(dB)
3. Margin value = Emission Level – Limit value
4. The other emission levels were very low against the limit.
5. " \* ": Fundamental frequency.

### 802.11n (VHT20)

|                        |                    |                          |                           |
|------------------------|--------------------|--------------------------|---------------------------|
| <b>RF Mode</b>         | TX 802.11n (VHT20) | <b>Channel</b>           | CH 1 : 2412 MHz           |
| <b>Frequency Range</b> | 1GHz ~ 25GHz       | <b>Detector Function</b> | Peak (PK)<br>Average (AV) |

#### Antenna Polarity & Test Distance : Horizontal at 3 m

| No | Frequency (MHz) | Emission Level (dBuV/m) | Limit (dBuV/m) | Margin (dB) | Antenna Height (m) | Table Angle (Degree) | Raw Value (dBuV) | Correction Factor (dB/m) |
|----|-----------------|-------------------------|----------------|-------------|--------------------|----------------------|------------------|--------------------------|
| 1  | 2390.00         | 64.3 PK                 | 74.0           | -9.7        | 1.12 H             | 296                  | 32.6             | 31.7                     |
| 2  | 2390.00         | 50.2 AV                 | 54.0           | -3.8        | 1.12 H             | 296                  | 18.5             | 31.7                     |
| 3  | *2412.00        | 108.1 PK                |                |             | 1.12 H             | 296                  | 76.4             | 31.7                     |
| 4  | *2412.00        | 98.1 AV                 |                |             | 1.12 H             | 296                  | 66.4             | 31.7                     |
| 5  | 4824.00         | 50.9 PK                 | 74.0           | -23.1       | 3.85 H             | 48                   | 48.5             | 2.4                      |
| 6  | 4824.00         | 38.0 AV                 | 54.0           | -16.0       | 3.85 H             | 48                   | 35.6             | 2.4                      |

#### Antenna Polarity & Test Distance : Vertical at 3 m

| No | Frequency (MHz) | Emission Level (dBuV/m) | Limit (dBuV/m) | Margin (dB) | Antenna Height (m) | Table Angle (Degree) | Raw Value (dBuV) | Correction Factor (dB/m) |
|----|-----------------|-------------------------|----------------|-------------|--------------------|----------------------|------------------|--------------------------|
| 1  | 2390.00         | 67.0 PK                 | 74.0           | -7.0        | 1.28 V             | 295                  | 35.3             | 31.7                     |
| 2  | 2390.00         | 53.3 AV                 | 54.0           | -0.7        | 1.28 V             | 295                  | 21.6             | 31.7                     |
| 3  | *2412.00        | 112.9 PK                |                |             | 1.28 V             | 295                  | 81.2             | 31.7                     |
| 4  | *2412.00        | 102.9 AV                |                |             | 1.28 V             | 295                  | 71.2             | 31.7                     |
| 5  | 4824.00         | 60.2 PK                 | 74.0           | -13.8       | 1.12 V             | 306                  | 57.8             | 2.4                      |
| 6  | 4824.00         | 46.9 AV                 | 54.0           | -7.1        | 1.12 V             | 306                  | 44.5             | 2.4                      |

#### Remarks:

1. Emission Level(dBuV/m) = Raw Value(dBuV) + Correction Factor(dB/m)
2. Correction Factor(dB/m) = Antenna Factor(dB/m) + Cable Factor(dB) – Pre-Amplifier Factor(dB)
3. Margin value = Emission Level – Limit value
4. The other emission levels were very low against the limit.
5. " \* ": Fundamental frequency.



|                        |                    |                          |                           |
|------------------------|--------------------|--------------------------|---------------------------|
| <b>RF Mode</b>         | TX 802.11n (VHT20) | <b>Channel</b>           | CH 6 : 2437 MHz           |
| <b>Frequency Range</b> | 1GHz ~ 25GHz       | <b>Detector Function</b> | Peak (PK)<br>Average (AV) |

**Antenna Polarity & Test Distance : Horizontal at 3 m**

| No | Frequency (MHz) | Emission Level (dBuV/m) | Limit (dBuV/m) | Margin (dB) | Antenna Height (m) | Table Angle (Degree) | Raw Value (dBuV) | Correction Factor (dB/m) |
|----|-----------------|-------------------------|----------------|-------------|--------------------|----------------------|------------------|--------------------------|
| 1  | *2437.00        | 111.2 PK                |                |             | 1.11 H             | 295                  | 79.4             | 31.8                     |
| 2  | *2437.00        | 101.2 AV                |                |             | 1.11 H             | 295                  | 69.4             | 31.8                     |
| 3  | 2483.50         | 63.1 PK                 | 74.0           | -10.9       | 1.11 H             | 295                  | 31.2             | 31.9                     |
| 4  | 2483.50         | 49.3 AV                 | 54.0           | -4.7        | 1.11 H             | 295                  | 17.4             | 31.9                     |
| 5  | 4874.00         | 48.8 PK                 | 74.0           | -25.2       | 3.52 H             | 50                   | 46.3             | 2.5                      |
| 6  | 4874.00         | 36.3 AV                 | 54.0           | -17.7       | 3.52 H             | 50                   | 33.8             | 2.5                      |

**Antenna Polarity & Test Distance : Vertical at 3 m**

| No | Frequency (MHz) | Emission Level (dBuV/m) | Limit (dBuV/m) | Margin (dB) | Antenna Height (m) | Table Angle (Degree) | Raw Value (dBuV) | Correction Factor (dB/m) |
|----|-----------------|-------------------------|----------------|-------------|--------------------|----------------------|------------------|--------------------------|
| 1  | *2437.00        | 116.1 PK                |                |             | 1.41 V             | 295                  | 84.3             | 31.8                     |
| 2  | *2437.00        | 106.1 AV                |                |             | 1.41 V             | 295                  | 74.3             | 31.8                     |
| 3  | 2483.50         | 69.3 PK                 | 74.0           | -4.7        | 1.41 V             | 295                  | 37.4             | 31.9                     |
| 4  | 2483.50         | 53.3 AV                 | 54.0           | -0.7        | 1.41 V             | 295                  | 21.4             | 31.9                     |
| 5  | 4874.00         | 56.5 PK                 | 74.0           | -17.5       | 1.05 V             | 305                  | 54.0             | 2.5                      |
| 6  | 4874.00         | 44.3 AV                 | 54.0           | -9.7        | 1.05 V             | 305                  | 41.8             | 2.5                      |

**Remarks:**

1. Emission Level(dBuV/m) = Raw Value(dBuV) + Correction Factor(dB/m)
2. Correction Factor(dB/m) = Antenna Factor(dB/m) + Cable Factor(dB) – Pre-Amplifier Factor(dB)
3. Margin value = Emission Level – Limit value
4. The other emission levels were very low against the limit.
5. " \* " : Fundamental frequency.

|                        |                    |                          |                           |
|------------------------|--------------------|--------------------------|---------------------------|
| <b>RF Mode</b>         | TX 802.11n (VHT20) | <b>Channel</b>           | CH 11 : 2462 MHz          |
| <b>Frequency Range</b> | 1GHz ~ 25GHz       | <b>Detector Function</b> | Peak (PK)<br>Average (AV) |

**Antenna Polarity & Test Distance : Horizontal at 3 m**

| No | Frequency (MHz) | Emission Level (dBuV/m) | Limit (dBuV/m) | Margin (dB) | Antenna Height (m) | Table Angle (Degree) | Raw Value (dBuV) | Correction Factor (dB/m) |
|----|-----------------|-------------------------|----------------|-------------|--------------------|----------------------|------------------|--------------------------|
| 1  | *2462.00        | 105.3 PK                |                |             | 1.07 H             | 293                  | 73.5             | 31.8                     |
| 2  | *2462.00        | 95.8 AV                 |                |             | 1.07 H             | 293                  | 64.0             | 31.8                     |
| 3  | 2483.50         | 62.7 PK                 | 74.0           | -11.3       | 1.07 H             | 293                  | 30.8             | 31.9                     |
| 4  | 2483.50         | 50.7 AV                 | 54.0           | -3.3        | 1.07 H             | 293                  | 18.8             | 31.9                     |
| 5  | 4924.00         | 49.4 PK                 | 74.0           | -24.6       | 3.85 H             | 50                   | 46.8             | 2.6                      |
| 6  | 4924.00         | 35.9 AV                 | 54.0           | -18.1       | 3.85 H             | 50                   | 33.3             | 2.6                      |

**Antenna Polarity & Test Distance : Vertical at 3 m**

| No | Frequency (MHz) | Emission Level (dBuV/m) | Limit (dBuV/m) | Margin (dB) | Antenna Height (m) | Table Angle (Degree) | Raw Value (dBuV) | Correction Factor (dB/m) |
|----|-----------------|-------------------------|----------------|-------------|--------------------|----------------------|------------------|--------------------------|
| 1  | *2462.00        | 111.0 PK                |                |             | 1.52 V             | 293                  | 79.2             | 31.8                     |
| 2  | *2462.00        | 101.3 AV                |                |             | 1.52 V             | 293                  | 69.5             | 31.8                     |
| 3  | 2483.50         | 66.1 PK                 | 74.0           | -7.9        | 1.52 V             | 293                  | 34.2             | 31.9                     |
| 4  | 2483.50         | 53.4 AV                 | 54.0           | -0.6        | 1.52 V             | 293                  | 21.5             | 31.9                     |
| 5  | 4924.00         | 56.2 PK                 | 74.0           | -17.8       | 1.03 V             | 301                  | 53.6             | 2.6                      |
| 6  | 4924.00         | 42.8 AV                 | 54.0           | -11.2       | 1.03 V             | 301                  | 40.2             | 2.6                      |

**Remarks:**

1. Emission Level(dBuV/m) = Raw Value(dBuV) + Correction Factor(dB/m)
2. Correction Factor(dB/m) = Antenna Factor(dB/m) + Cable Factor(dB) – Pre-Amplifier Factor(dB)
3. Margin value = Emission Level – Limit value
4. The other emission levels were very low against the limit.
5. " \* ": Fundamental frequency.

### 802.11n (VHT40)

|                        |                    |                          |                           |
|------------------------|--------------------|--------------------------|---------------------------|
| <b>RF Mode</b>         | TX 802.11n (VHT40) | <b>Channel</b>           | CH 3 : 2422 MHz           |
| <b>Frequency Range</b> | 1GHz ~ 25GHz       | <b>Detector Function</b> | Peak (PK)<br>Average (AV) |

#### Antenna Polarity & Test Distance : Horizontal at 3 m

| No | Frequency (MHz) | Emission Level (dBuV/m) | Limit (dBuV/m) | Margin (dB) | Antenna Height (m) | Table Angle (Degree) | Raw Value (dBuV) | Correction Factor (dB/m) |
|----|-----------------|-------------------------|----------------|-------------|--------------------|----------------------|------------------|--------------------------|
| 1  | 2390.00         | 61.4 PK                 | 74.0           | -12.6       | 1.13 H             | 294                  | 29.7             | 31.7                     |
| 2  | 2390.00         | 49.3 AV                 | 54.0           | -4.7        | 1.13 H             | 294                  | 17.6             | 31.7                     |
| 3  | *2422.00        | 105.0 PK                |                |             | 1.13 H             | 294                  | 73.3             | 31.7                     |
| 4  | *2422.00        | 94.5 AV                 |                |             | 1.13 H             | 294                  | 62.8             | 31.7                     |
| 5  | 4844.00         | 47.1 PK                 | 74.0           | -26.9       | 3.83 H             | 50                   | 44.6             | 2.5                      |
| 6  | 4844.00         | 36.0 AV                 | 54.0           | -18.0       | 3.83 H             | 50                   | 33.5             | 2.5                      |

#### Antenna Polarity & Test Distance : Vertical at 3 m

| No | Frequency (MHz) | Emission Level (dBuV/m) | Limit (dBuV/m) | Margin (dB) | Antenna Height (m) | Table Angle (Degree) | Raw Value (dBuV) | Correction Factor (dB/m) |
|----|-----------------|-------------------------|----------------|-------------|--------------------|----------------------|------------------|--------------------------|
| 1  | 2390.00         | 64.6 PK                 | 74.0           | -9.4        | 1.44 V             | 292                  | 32.9             | 31.7                     |
| 2  | 2390.00         | 52.4 AV                 | 54.0           | -1.6        | 1.44 V             | 292                  | 20.7             | 31.7                     |
| 3  | *2422.00        | 110.4 PK                |                |             | 1.44 V             | 292                  | 78.7             | 31.7                     |
| 4  | *2422.00        | 99.3 AV                 |                |             | 1.44 V             | 292                  | 67.6             | 31.7                     |
| 5  | 4844.00         | 51.0 PK                 | 74.0           | -23.0       | 1.15 V             | 307                  | 48.5             | 2.5                      |
| 6  | 4844.00         | 40.0 AV                 | 54.0           | -14.0       | 1.15 V             | 307                  | 37.5             | 2.5                      |

#### Remarks:

1. Emission Level(dBuV/m) = Raw Value(dBuV) + Correction Factor(dB/m)
2. Correction Factor(dB/m) = Antenna Factor(dB/m) + Cable Factor(dB) – Pre-Amplifier Factor(dB)
3. Margin value = Emission Level – Limit value
4. The other emission levels were very low against the limit.
5. " \* " : Fundamental frequency.

|                        |                    |                          |                           |
|------------------------|--------------------|--------------------------|---------------------------|
| <b>RF Mode</b>         | TX 802.11n (VHT40) | <b>Channel</b>           | CH 6 : 2437 MHz           |
| <b>Frequency Range</b> | 1GHz ~ 25GHz       | <b>Detector Function</b> | Peak (PK)<br>Average (AV) |

**Antenna Polarity & Test Distance : Horizontal at 3 m**

| No | Frequency (MHz) | Emission Level (dBuV/m) | Limit (dBuV/m) | Margin (dB) | Antenna Height (m) | Table Angle (Degree) | Raw Value (dBuV) | Correction Factor (dB/m) |
|----|-----------------|-------------------------|----------------|-------------|--------------------|----------------------|------------------|--------------------------|
| 1  | *2437.00        | 104.1 PK                |                |             | 1.09 H             | 296                  | 72.3             | 31.8                     |
| 2  | *2437.00        | 94.5 AV                 |                |             | 1.09 H             | 296                  | 62.7             | 31.8                     |
| 3  | 2483.50         | 61.2 PK                 | 74.0           | -12.8       | 1.09 H             | 296                  | 29.3             | 31.9                     |
| 4  | 2483.50         | 49.6 AV                 | 54.0           | -4.4        | 1.09 H             | 296                  | 17.7             | 31.9                     |
| 5  | 4874.00         | 48.0 PK                 | 74.0           | -26.0       | 3.49 H             | 53                   | 45.5             | 2.5                      |
| 6  | 4874.00         | 35.8 AV                 | 54.0           | -18.2       | 3.49 H             | 53                   | 33.3             | 2.5                      |

**Antenna Polarity & Test Distance : Vertical at 3 m**

| No       | Frequency (MHz) | Emission Level (dBuV/m) | Limit (dBuV/m) | Margin (dB) | Antenna Height (m) | Table Angle (Degree) | Raw Value (dBuV) | Correction Factor (dB/m) |
|----------|-----------------|-------------------------|----------------|-------------|--------------------|----------------------|------------------|--------------------------|
| 1        | *2437.00        | 109.3 PK                |                |             | 1.43 V             | 294                  | 77.5             | 31.8                     |
| 2        | *2437.00        | 99.5 AV                 |                |             | 1.43 V             | 294                  | 67.7             | 31.8                     |
| 3        | 2483.50         | 65.6 PK                 | 74.0           | -8.4        | 1.43 V             | 294                  | 33.7             | 31.9                     |
| <b>4</b> | <b>2483.50</b>  | <b>53.7 AV</b>          | <b>54.0</b>    | <b>-0.3</b> | <b>1.43 V</b>      | <b>294</b>           | <b>21.8</b>      | <b>31.9</b>              |
| 5        | 4874.00         | 49.3 PK                 | 74.0           | -24.7       | 1.08 V             | 307                  | 46.8             | 2.5                      |
| 6        | 4874.00         | 36.8 AV                 | 54.0           | -17.2       | 1.08 V             | 307                  | 34.3             | 2.5                      |

**Remarks:**

1. Emission Level(dBuV/m) = Raw Value(dBuV) + Correction Factor(dB/m)
2. Correction Factor(dB/m) = Antenna Factor(dB/m) + Cable Factor(dB) – Pre-Amplifier Factor(dB)
3. Margin value = Emission Level – Limit value
4. The other emission levels were very low against the limit.
5. " \* ": Fundamental frequency.

|                        |                    |                          |                           |
|------------------------|--------------------|--------------------------|---------------------------|
| <b>RF Mode</b>         | TX 802.11n (VHT40) | <b>Channel</b>           | CH 9 : 2452 MHz           |
| <b>Frequency Range</b> | 1GHz ~ 25GHz       | <b>Detector Function</b> | Peak (PK)<br>Average (AV) |

| Antenna Polarity & Test Distance : Horizontal at 3 m |                 |                         |                |             |                    |                      |                  |                          |
|--|-----------------|-------------------------|----------------|-------------|--------------------|----------------------|------------------|--------------------------|
| No   | Frequency (MHz) | Emission Level (dBuV/m) | Limit (dBuV/m) | Margin (dB) | Antenna Height (m) | Table Angle (Degree) | Raw Value (dBuV) | Correction Factor (dB/m) |
| 1  | *2452.00        | 101.3 PK                |                |             | 1.13 H             | 293                  | 69.5             | 31.8                     |
| 2  | *2452.00        | 91.6 AV                 |                |             | 1.13 H             | 293                  | 59.8             | 31.8                     |
| 3  | 2483.50         | 61.8 PK                 | 74.0           | -12.2       | 1.13 H             | 293                  | 29.9             | 31.9                     |
| 4  | 2483.50         | 49.7 AV                 | 54.0           | -4.3        | 1.13 H             | 293                  | 17.8             | 31.9                     |
| 5  | 4904.00         | 49.1 PK                 | 74.0           | -24.9       | 3.88 H             | 51                   | 46.5             | 2.6                      |
| 6  | 4904.00         | 35.7 AV                 | 54.0           | -18.3       | 3.88 H             | 51                   | 33.1             | 2.6                      |
| Antenna Polarity & Test Distance : Vertical at 3 m   |                 |                         |                |             |                    |                      |                  |                          |
| No   | Frequency (MHz) | Emission Level (dBuV/m) | Limit (dBuV/m) | Margin (dB) | Antenna Height (m) | Table Angle (Degree) | Raw Value (dBuV) | Correction Factor (dB/m) |
| 1  | *2452.00        | 106.7 PK                |                |             | 1.41 V             | 292                  | 74.9             | 31.8                     |
| 2  | *2452.00        | 96.4 AV                 |                |             | 1.41 V             | 292                  | 64.6             | 31.8                     |
| 3  | 2483.50         | 66.0 PK                 | 74.0           | -8.0        | 1.41 V             | 292                  | 34.1             | 31.9                     |
| 4  | 2483.50         | 53.5 AV                 | 54.0           | -0.5        | 1.41 V             | 292                  | 21.6             | 31.9                     |
| 5  | 4904.00         | 50.1 PK                 | 74.0           | -23.9       | 1.05 V             | 302                  | 47.5             | 2.6                      |
| 6  | 4904.00         | 36.1 AV                 | 54.0           | -17.9       | 1.05 V             | 302                  | 33.5             | 2.6                      |

**Remarks:**

1. Emission Level(dBuV/m) = Raw Value(dBuV) + Correction Factor(dB/m)
2. Correction Factor(dB/m) = Antenna Factor(dB/m) + Cable Factor(dB) – Pre-Amplifier Factor(dB)
3. Margin value = Emission Level – Limit value
4. The other emission levels were very low against the limit.
5. " \* ": Fundamental frequency.

**9 kHz ~ 30 MHz Data:**

The amplitude of spurious emissions attenuated more than 20 dB below the permissible value is not required to be report.

**30 MHz ~ 1 GHz Worst-Case Data:**

**802.11g**

|                        |              |                          |                 |
|------------------------|--------------|--------------------------|-----------------|
| <b>RF Mode</b>         | TX 802.11g   | <b>Channel</b>           | CH 6 : 2437 MHz |
| <b>Frequency Range</b> | 30MHz ~ 1GHz | <b>Detector Function</b> | Quasi-Peak (QP) |

| Antenna Polarity & Test Distance : Horizontal at 3 m |                 |                         |                |             |                    |                      |                  |                          |
|--|-----------------|-------------------------|----------------|-------------|--------------------|----------------------|------------------|--------------------------|
| No   | Frequency (MHz) | Emission Level (dBuV/m) | Limit (dBuV/m) | Margin (dB) | Antenna Height (m) | Table Angle (Degree) | Raw Value (dBuV) | Correction Factor (dB/m) |
| 1  | 122.78          | 21.9 QP                 | 43.5           | -21.6       | 1.51 H             | 166                  | 42.1             | -20.2                    |
| 2  | 143.87          | 22.5 QP                 | 43.5           | -21.0       | 2.00 H             | 119                  | 40.8             | -18.3                    |
| 3  | 263.36          | 27.9 QP                 | 46.0           | -18.1       | 1.01 H             | 146                  | 47.0             | -19.1                    |
| 4  | 371.61          | 25.6 QP                 | 46.0           | -20.4       | 1.01 H             | 186                  | 41.4             | -15.8                    |
| 5  | 455.96          | 23.0 QP                 | 46.0           | -23.0       | 2.00 H             | 87                   | 36.5             | -13.5                    |
| 6  | 600.75          | 23.0 QP                 | 46.0           | -23.0       | 2.00 H             | 320                  | 33.3             | -10.3                    |

**Remarks:**

1. Emission Level(dBuV/m) = Raw Value(dBuV) + Correction Factor(dB/m)
2. Correction Factor(dB/m) = Antenna Factor(dB/m) + Cable Factor(dB) – Pre-Amplifier Factor(dB)
3. Margin value = Emission Level – Limit value
4. The other emission levels were very low against the limit of frequency range 30MHz~1000MHz.
5. The emission levels were very low against the limit of frequency range 9kHz~30MHz: the amplitude of spurious emissions attenuated more than 20 dB below the permissible value to be report.

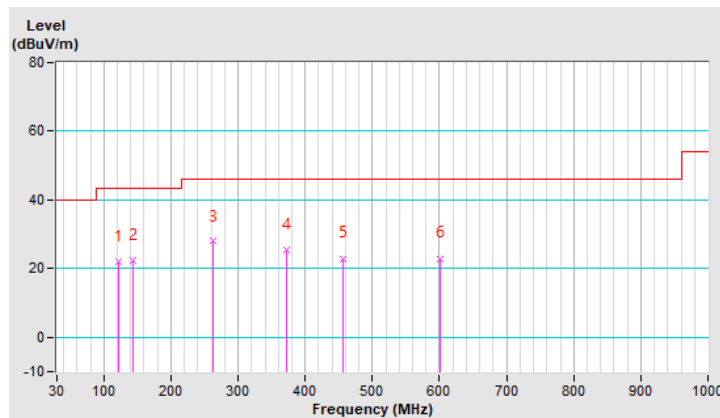

|                        |              |                          |                 |
|------------------------|--------------|--------------------------|-----------------|
| <b>RF Mode</b>         | TX 802.11g   | <b>Channel</b>           | CH 6 : 2437 MHz |
| <b>Frequency Range</b> | 30MHz ~ 1GHz | <b>Detector Function</b> | Quasi-Peak (QP) |

| Antenna Polarity & Test Distance : Vertical at 3 m |                 |                         |                |             |                    |                      |                  |                          |
|--|-----------------|-------------------------|----------------|-------------|--------------------|----------------------|------------------|--------------------------|
| No   | Frequency (MHz) | Emission Level (dBuV/m) | Limit (dBuV/m) | Margin (dB) | Antenna Height (m) | Table Angle (Degree) | Raw Value (dBuV) | Correction Factor (dB/m) |
| 1  | 37.03           | 23.1 QP                 | 40.0           | -16.9       | 1.00 V             | 176                  | 42.0             | -18.9                    |
| 2  | 48.28           | 20.8 QP                 | 40.0           | -19.2       | 1.00 V             | 300                  | 38.9             | -18.1                    |
| 3  | 142.46          | 21.9 QP                 | 43.5           | -21.6       | 1.00 V             | 161                  | 40.4             | -18.5                    |
| 4  | 263.36          | 22.5 QP                 | 46.0           | -23.5       | 1.99 V             | 137                  | 41.6             | -19.1                    |
| 5  | 371.61          | 25.7 QP                 | 46.0           | -20.3       | 1.00 V             | 51                   | 41.5             | -15.8                    |
| 6  | 448.93          | 28.3 QP                 | 46.0           | -17.7       | 1.00 V             | 103                  | 41.8             | -13.5                    |

**Remarks:**

1. Emission Level(dBuV/m) = Raw Value(dBuV) + Correction Factor(dB/m)
2. Correction Factor(dB/m) = Antenna Factor(dB/m) + Cable Factor(dB) – Pre-Amplifier Factor(dB)
3. Margin value = Emission Level – Limit value
4. The other emission levels were very low against the limit of frequency range 30MHz~1000MHz.
5. The emission levels were very low against the limit of frequency range 9kHz~30MHz: the amplitude of spurious emissions attenuated more than 20 dB below the permissible value to be report.

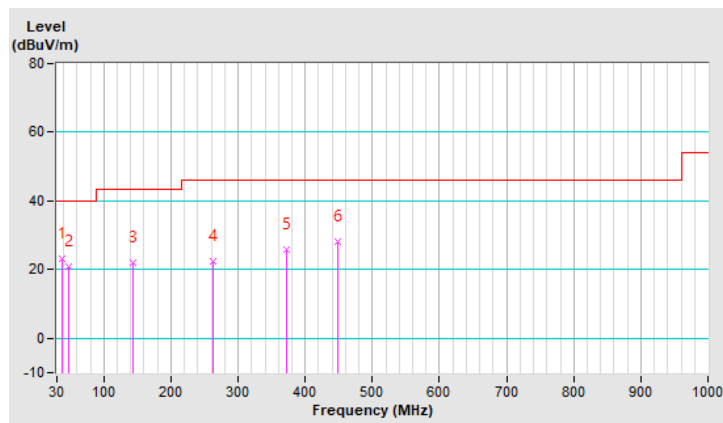

## 4.2 Conducted Emission Measurement

### 4.2.1 Limits of Conducted Emission Measurement

| Frequency (MHz) | Conducted Limit (dBuV) |         |
|-----------------|------------------------|---------|
|                 | Quasi-Peak             | Average |
| 0.15 - 0.5      | 66 - 56                | 56 - 46 |
| 0.50 - 5.0      | 56                     | 46      |
| 5.0 - 30.0      | 60                     | 50      |

- Note: 1. The lower limit shall apply at the transition frequencies.  
 2. The limit decreases in line with the logarithm of the frequency in the range of 0.15 to 0.50 MHz.

### 4.2.2 Test Instruments

| Description & Manufacturer                  | Model No.                | Serial No.     | Date of Calibration | Due Date of Calibration |
|---|--------------------------|----------------|---------------------|-------------------------|
| Test Receiver<br>ROHDE & SCHWARZ            | ESR3                     | 102783         | Dec. 21, 2020       | Dec. 20, 2021           |
| RF signal cable (with<br>10dB PAD)<br>Woken | 5D-FB                    | Cable-cond2-01 | Sep. 04, 2021       | Sep. 03, 2022           |
| LISN/AMN<br>ROHDE & SCHWARZ<br>(EUT)        | ESH2-Z5                  | 100100         | Jan. 28, 2021       | Jan. 27, 2022           |
| LISN/AMN<br>ROHDE & SCHWARZ<br>(Peripheral) | ENV216                   | 101196         | Apr. 26, 2021       | Apr. 25, 2022           |
| Software<br>ADT                             | BV ADT_Cond_<br>V7.3.7.4 | NA             | NA                  | NA                      |

- Note: 1. The calibration interval of the above test instruments is 12 months and the calibrations are traceable to NML/ROC and NIST/USA.  
 2. The test was performed in HwaYa Shielded Room 2. (Conduction 2).  
 3. The VCCI Site Registration No. is C-12047.



#### 4.2.3 Test Procedures

- a. The EUT was placed 0.4 meters from the conducting wall of the shielded room with EUT being connected to the power mains through a line impedance stabilization network (LISN). Other support units were connected to the power mains through another LISN. The two LISNs provide 50 ohm/50 uH of coupling impedance for the measuring instrument.
- b. Both lines of the power mains connected to the EUT were checked for maximum conducted interference.
- c. The frequency range from 150 kHz to 30 MHz was searched. Emission levels under (Limit – 20 dB) was not recorded.

**Note:** The resolution bandwidth and video bandwidth of test receiver is 9 kHz for quasi-peak detection (QP) and average detection (AV) at frequency 0.15 MHz – 30 MHz.

#### 4.2.4 Deviation from Test Standard

No deviation.

#### 4.2.5 Test Setup

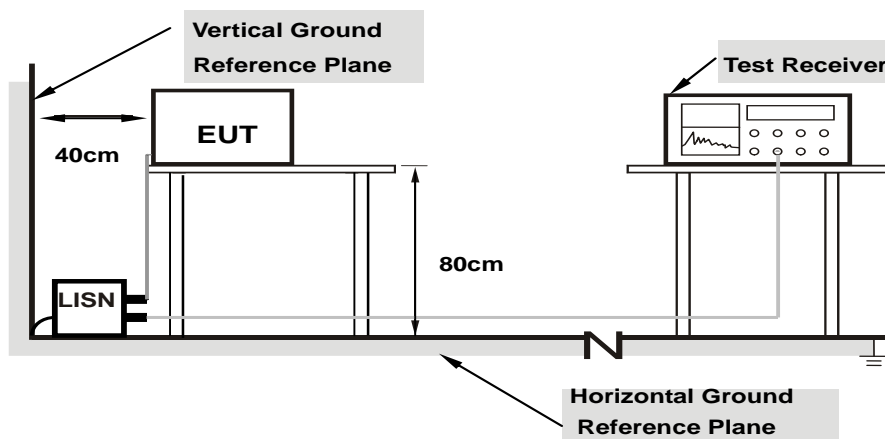

**Note:** 1.Support units were connected to second LISN.

For the actual test configuration, please refer to the attached file (Test Setup Photo).

#### 4.2.6 EUT Operating Conditions

- a. Placed the EUT on a testing table.
- b. Use the software to control the EUT under transmission condition continuously at specific channel frequency.

4.2.7 Test Results

|                        |                |   |                                      |
|------------------------|----------------|---|--------------------------------------|
| <b>Frequency Range</b> | 150kHz ~ 30MHz | <b>Detector Function &amp; Resolution Bandwidth</b> | Quasi-Peak (QP) / Average (AV), 9kHz |
| <b>Input Power</b>     | 120Vac, 60Hz   | <b>Environmental Conditions</b>                     | 25 °C, 75% RH                        |
| <b>Tested by</b>       | Rex Wang       | <b>Test Date</b>                                    | 2021/9/11                            |

| Phase Of Power : Line (L) |                 |                        |                      |      |                       |       |              |       |             |        |
|---------------------------|-----------------|------------------------|----------------------|------|-----------------------|-------|--------------|-------|-------------|--------|
| No                        | Frequency (MHz) | Correction Factor (dB) | Reading Value (dBuV) |      | Emission Level (dBuV) |       | Limit (dBuV) |       | Margin (dB) |        |
|                           |                 |                        | Q.P.                 | AV.  | Q.P.                  | AV.   | Q.P.         | AV.   | Q.P.        | AV.    |
| 1                         | 0.17000         | 10.12                  | 18.98                | 2.22 | 29.10                 | 12.34 | 64.96        | 54.96 | -35.86      | -42.62 |
| 2                         | 0.39400         | 10.14                  | 19.73                | 3.59 | 29.87                 | 13.73 | 57.98        | 47.98 | -28.11      | -34.25 |
| 3                         | 0.63800         | 10.15                  | 7.93                 | 1.27 | 18.08                 | 11.42 | 56.00        | 46.00 | -37.92      | -34.58 |
| 4                         | 6.79800         | 10.28                  | 6.32                 | 1.38 | 16.60                 | 11.66 | 60.00        | 50.00 | -43.40      | -38.34 |
| 5                         | 17.74200        | 10.44                  | 11.77                | 4.05 | 22.21                 | 14.49 | 60.00        | 50.00 | -37.79      | -35.51 |
| 6                         | 25.57400        | 10.26                  | 8.64                 | 4.97 | 18.90                 | 15.23 | 60.00        | 50.00 | -41.10      | -34.77 |

Remarks:

1. Q.P. and AV. are abbreviations of quasi-peak and average individually.
2. The emission levels of other frequencies were very low against the limit.
3. Margin value = Emission level – Limit value
4. Correction factor = Insertion loss + Cable loss
5. Emission Level = Correction Factor + Reading Value

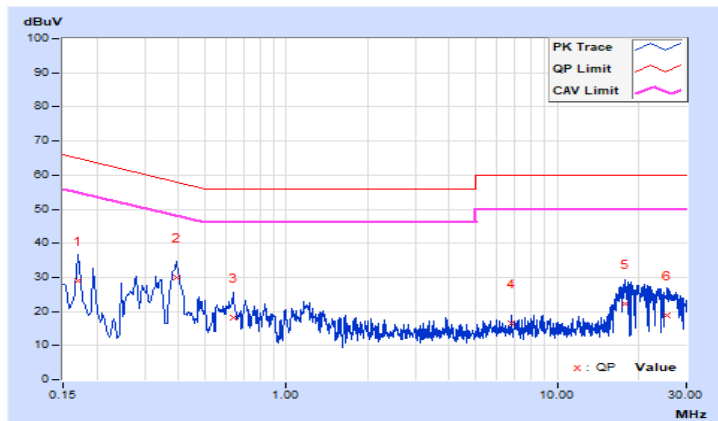

|                        |                |   |                                      |
|------------------------|----------------|---|--------------------------------------|
| <b>Frequency Range</b> | 150kHz ~ 30MHz | <b>Detector Function &amp; Resolution Bandwidth</b> | Quasi-Peak (QP) / Average (AV), 9kHz |
| <b>Input Power</b>     | 120Vac, 60Hz   | <b>Environmental Conditions</b>                     | 25 °C, 75% RH                        |
| <b>Tested by</b>       | Rex Wang       | <b>Test Date</b>                                    | 2021/9/11                            |

| Phase Of Power : Neutral (N) |                 |                        |                      |             |                       |              |              |              |               |               |
|------------------------------|-----------------|------------------------|----------------------|-------------|-----------------------|--------------|--------------|--------------|---------------|---------------|
| No                           | Frequency (MHz) | Correction Factor (dB) | Reading Value (dBuV) |             | Emission Level (dBuV) |              | Limit (dBuV) |              | Margin (dB)   |               |
|                              |                 |                        | Q.P.                 | AV.         | Q.P.                  | AV.          | Q.P.         | AV.          | Q.P.          | AV.           |
| 1                            | 0.15400         | 10.12                  | 19.68                | 6.23        | 29.80                 | 16.35        | 65.78        | 55.78        | -35.98        | -39.43        |
| 2                            | 0.29800         | 10.14                  | 16.04                | 5.31        | 26.18                 | 15.45        | 60.30        | 50.30        | -34.12        | -34.85        |
| <b>3</b>                     | <b>0.40179</b>  | <b>10.15</b>           | <b>22.19</b>         | <b>7.23</b> | <b>32.34</b>          | <b>17.38</b> | <b>57.82</b> | <b>47.82</b> | <b>-25.48</b> | <b>-30.44</b> |
| 4                            | 1.21000         | 10.19                  | 8.36                 | 0.85        | 18.55                 | 11.04        | 56.00        | 46.00        | -37.45        | -34.96        |
| 5                            | 3.31800         | 10.26                  | 7.66                 | 2.34        | 17.92                 | 12.60        | 56.00        | 46.00        | -38.08        | -33.40        |
| 6                            | 18.29400        | 10.63                  | 10.49                | 4.92        | 21.12                 | 15.55        | 60.00        | 50.00        | -38.88        | -34.45        |

**Remarks:**

1. Q.P. and AV. are abbreviations of quasi-peak and average individually.
2. The emission levels of other frequencies were very low against the limit.
3. Margin value = Emission level – Limit value
4. Correction factor = Insertion loss + Cable loss
5. Emission Level = Correction Factor + Reading Value

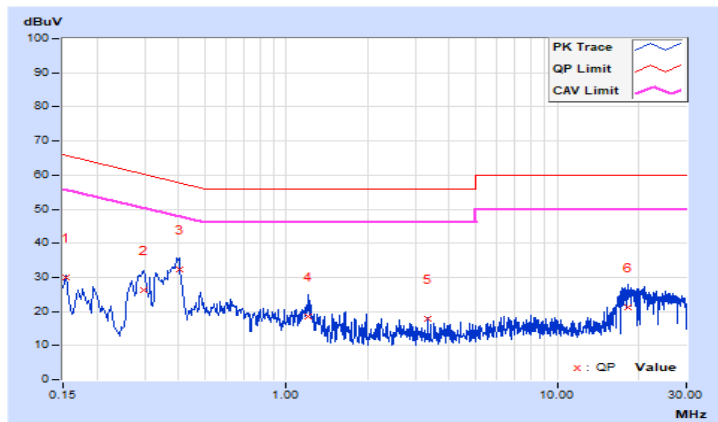

### 4.3 6 dB Bandwidth Measurement

#### 4.3.1 Limits of 6 dB Bandwidth Measurement

The minimum of 6 dB Bandwidth Measurement is 0.5 MHz.

#### 4.3.2 Test Setup

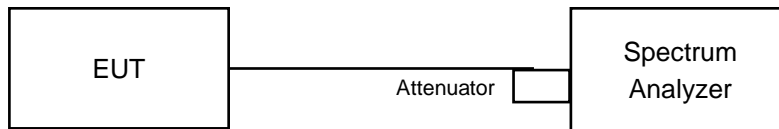

#### 4.3.3 Test Instruments

Refer to section 4.1.2 to get information of above instrument.

#### 4.3.4 Test Procedure

- Set resolution bandwidth (RBW) = 100 kHz
- Set the video bandwidth (VBW)  $\geq 3 \times$  RBW, Detector = Peak.
- Trace mode = max hold.
- Sweep = auto couple.
- Measure the maximum width of the emission that is constrained by the frequencies associated with the two amplitude points (upper and lower) that are attenuated by 6 dB relative to the maximum level measured in the fundamental emission

#### 4.3.5 Deviation from Test Standard

No deviation.

#### 4.3.6 EUT Operating Conditions

The software provided by client to enable the EUT under transmission condition continuously at lowest, middle and highest channel frequencies individually.

#### 4.3.7 Test Results

##### 802.11b

| Channel | Frequency (MHz) | 6 dB Bandwidth (MHz) | Minimum Limit (MHz) | Pass / Fail |
|---------|-----------------|----------------------|---------------------|-------------|
| 1       | 2412            | 9.05                 | 0.5                 | Pass        |
| 6       | 2437            | 8.60                 | 0.5                 | Pass        |
| 11      | 2462            | 8.57                 | 0.5                 | Pass        |

##### 802.11g

| Channel | Frequency (MHz) | 6 dB Bandwidth (MHz) | Minimum Limit (MHz) | Pass / Fail |
|---------|-----------------|----------------------|---------------------|-------------|
| 1       | 2412            | 16.33                | 0.5                 | Pass        |
| 6       | 2437            | 16.10                | 0.5                 | Pass        |
| 11      | 2462            | 15.20                | 0.5                 | Pass        |

##### 802.11n (VHT20)

| Channel | Frequency (MHz) | 6 dB Bandwidth (MHz) | Minimum Limit (MHz) | Pass / Fail |
|---------|-----------------|----------------------|---------------------|-------------|
| 1       | 2412            | 17.56                | 0.5                 | Pass        |
| 6       | 2437            | 16.34                | 0.5                 | Pass        |
| 11      | 2462            | 15.20                | 0.5                 | Pass        |

##### 802.11n (VHT40)

| Channel | Frequency (MHz) | 6 dB Bandwidth (MHz) | Minimum Limit (MHz) | Pass / Fail |
|---------|-----------------|----------------------|---------------------|-------------|
| 3       | 2422            | 35.45                | 0.5                 | Pass        |
| 6       | 2437            | 35.25                | 0.5                 | Pass        |
| 9       | 2452            | 36.44                | 0.5                 | Pass        |

### Spectrum Plot of Worst Value

#### 802.11b

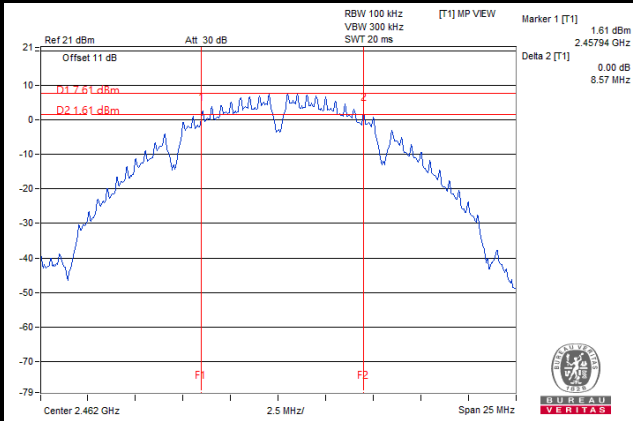

#### 802.11g

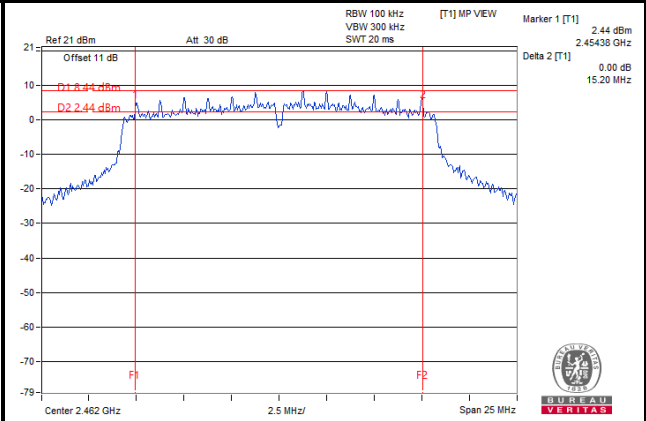

#### 802.11n (VHT20)

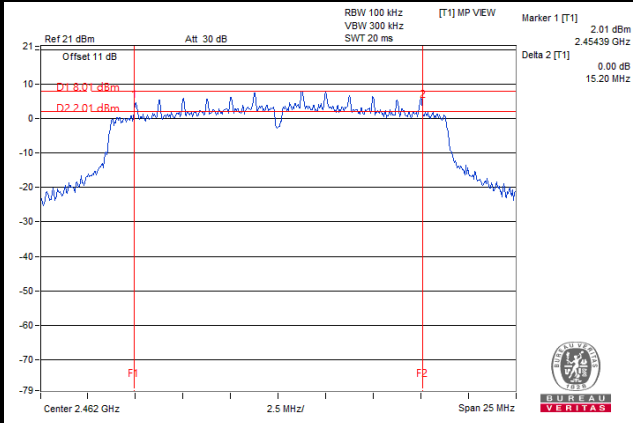

#### 802.11n (VHT40)

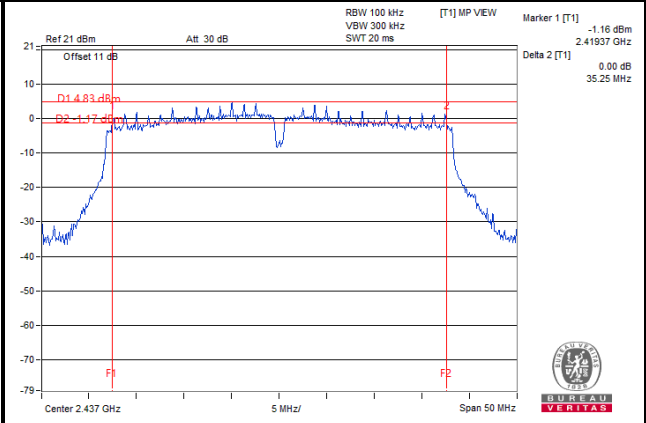

## 4.4 Occupied Bandwidth Measurement

### 4.4.1 Test Setup

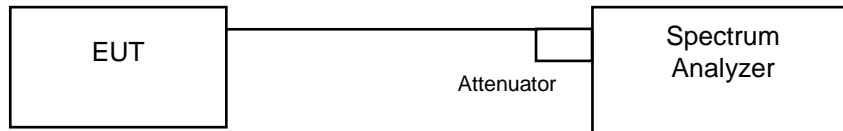

### 4.4.2 Test Instruments

Refer to section 4.1.2 to get information of above instrument.

### 4.4.3 Test Procedure

The transmitter output was connected to the spectrum analyzer through an attenuator. The bandwidth of the fundamental frequency was measured by spectrum analyzer with resolution bandwidth in the range of 1 % to 5 % of the anticipated emission bandwidth, and a video bandwidth at least 3x the resolution bandwidth and set the detector to sampling. The width of a frequency band such that, below the lower and above the upper frequency limits, the mean powers emitted are each equal to a specified percentage 0.5 % of the total mean power of a given emission.

### 4.4.4 Deviation from Test Standard

No deviation.

### 4.4.5 EUT Operating Conditions

The software provided by client to enable the EUT under transmission condition continuously at lowest, middle and highest channel frequencies individually.

#### 4.4.6 Test Results

##### 802.11b

| Channel | Frequency (MHz) | Occupied Bandwidth (MHz) | Pass / Fail |
|---------|-----------------|--------------------------|-------------|
| 1       | 2412            | 13.98                    | Pass        |
| 6       | 2437            | 13.56                    | Pass        |
| 11      | 2462            | 13.44                    | Pass        |

##### 802.11g

| Channel | Frequency (MHz) | Occupied Bandwidth (MHz) | Pass / Fail |
|---------|-----------------|--------------------------|-------------|
| 1       | 2412            | 17.76                    | Pass        |
| 6       | 2437            | 22.32                    | Pass        |
| 11      | 2462            | 16.68                    | Pass        |

##### 802.11n (VHT20)

| Channel | Frequency (MHz) | Occupied Bandwidth (MHz) | Pass / Fail |
|---------|-----------------|--------------------------|-------------|
| 1       | 2412            | 18.36                    | Pass        |
| 6       | 2437            | 21.24                    | Pass        |
| 11      | 2462            | 17.76                    | Pass        |

##### 802.11n (VHT40)

| Channel | Frequency (MHz) | Occupied Bandwidth (MHz) | Pass / Fail |
|---------|-----------------|--------------------------|-------------|
| 3       | 2422            | 36.48                    | Pass        |
| 6       | 2437            | 36.24                    | Pass        |
| 9       | 2452            | 36.84                    | Pass        |



### Spectrum Plot of Worst Value

#### 802.11b

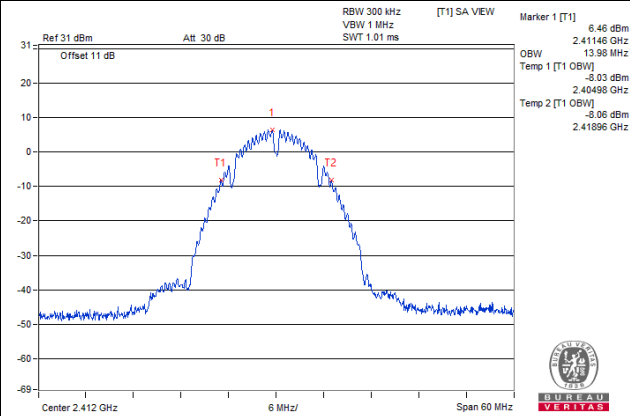

#### 802.11g

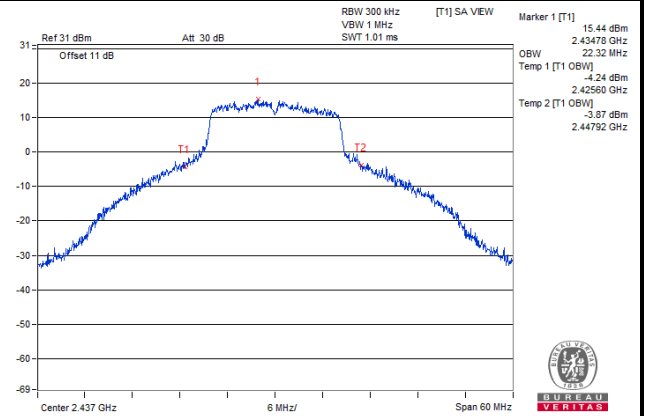

#### 802.11n (VHT20)

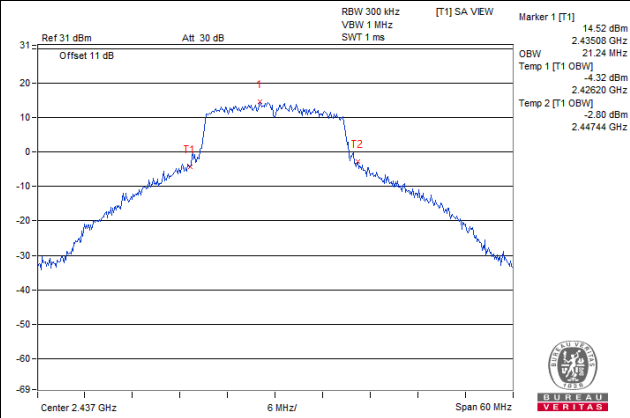

#### 802.11n (VHT40)

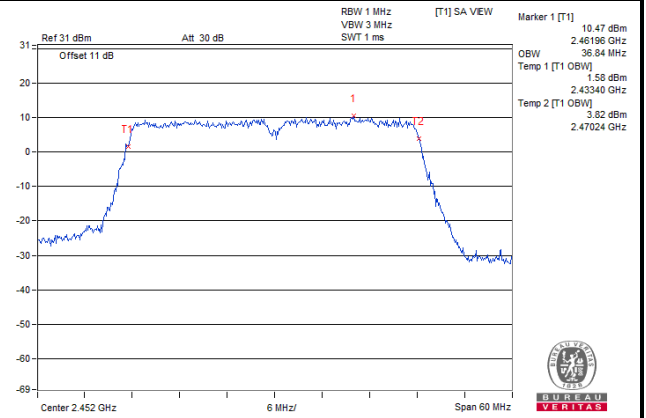

## 4.5 Conducted Output Power Measurement

### 4.5.1 Limits of Conducted Output Power Measurement

For systems using digital modulation in the 2400–2483.5 MHz bands: 1 Watt (30 dBm)

### 4.5.2 Test Setup

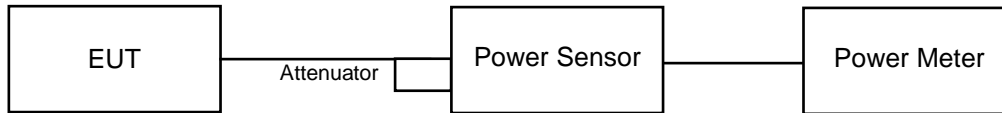

### 4.5.3 Test Instruments

Refer to section 4.1.2 to get information of above instrument.

### 4.5.4 Test Procedures

Average power sensor was used to perform output power measurement, trigger and gating function of wide band power meter is enabled to measure max output power of TX on burst. Duty factor is not added to measured value.

### 4.5.5 Deviation from Test Standard

No deviation.

### 4.5.6 EUT Operating Conditions

The software provided by client to enable the EUT under transmission condition continuously at lowest, middle and highest channel frequencies individually.

#### 4.5.7 Test Results

##### 802.11b

| Channel | Frequency (MHz) | Average Power (mW) | Average Power (dBm) | Limit (dBm) | Pass / Fail |
|---------|-----------------|--------------------|---------------------|-------------|-------------|
| 1       | 2412            | 29.376             | 14.68               | 30          | Pass        |
| 6       | 2437            | 48.753             | 16.88               | 30          | Pass        |
| 11      | 2462            | 41.495             | 16.18               | 30          | Pass        |

##### 802.11g

| Channel | Frequency (MHz) | Average Power (mW) | Average Power (dBm) | Limit (dBm) | Pass / Fail |
|---------|-----------------|--------------------|---------------------|-------------|-------------|
| 1       | 2412            | 104.472            | 20.19               | 30          | Pass        |
| 6       | 2437            | 190.985            | 22.81               | 30          | Pass        |
| 11      | 2462            | 65.313             | 18.15               | 30          | Pass        |

##### 802.11n (VHT20)

| Channel | Frequency (MHz) | Average Power (mW) | Average Power (dBm) | Limit (dBm) | Pass / Fail |
|---------|-----------------|--------------------|---------------------|-------------|-------------|
| 1       | 2412            | 93.756             | 19.72               | 30          | Pass        |
| 6       | 2437            | 172.982            | 22.38               | 30          | Pass        |
| 11      | 2462            | 54.075             | 17.33               | 30          | Pass        |

##### 802.11n (VHT40)

| Channel | Frequency (MHz) | Average Power (mW) | Average Power (dBm) | Limit (dBm) | Pass / Fail |
|---------|-----------------|--------------------|---------------------|-------------|-------------|
| 3       | 2422            | 77.983             | 18.92               | 30          | Pass        |
| 6       | 2437            | 59.02              | 17.71               | 30          | Pass        |
| 9       | 2452            | 41.879             | 16.22               | 30          | Pass        |

## 4.6 Power Spectral Density Measurement

### 4.6.1 Limits of Power Spectral Density Measurement

The Maximum of Power Spectral Density Measurement is 8 dBm in any 3 kHz band during any time interval of continuous transmission.

### 4.6.2 Test Setup

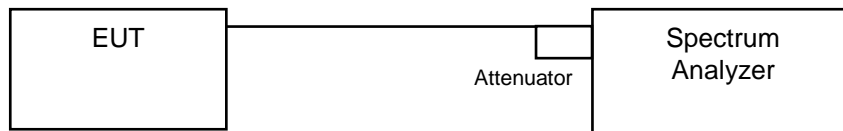

### 4.6.3 Test Instruments

Refer to section 4.1.2 to get information of above instrument.

### 4.6.4 Test Procedure

- a. Set analyzer center frequency to DTS channel center frequency.
- b. Set the span to 1.5 times the DTS bandwidth.
- c. Set the RBW to:  $3 \text{ kHz} \leq \text{RBW} \leq 100 \text{ kHz}$ .
- d. Set the VBW  $\geq 3 \times \text{RBW}$ .
- e. Detector = peak.
- f. Sweep time = auto couple.
- g. Trace mode = max hold.
- h. Allow trace to fully stabilize.
- i. Use the peak marker function to determine the maximum amplitude level within the RBW.

For Average Power (Duty cycle  $\geq 98\%$ )

- a. Set instrument center frequency to DTS channel center frequency.
- b. Set span to at least 1.5 times the OBW.
- c. Set RBW to:  $3 \text{ kHz} \leq \text{RBW} \leq 100 \text{ kHz}$ .
- d. Set VBW  $\geq 3 \times \text{RBW}$ .
- e. Detector = power averaging (RMS) or sample detector (when RMS not available).
- f. Ensure that the number of measurement points in the sweep  $\geq 2 \times \text{span}/\text{RBW}$ .
- g. Sweep time = auto couple.
- h. Employ trace averaging (RMS) mode over a minimum of 100 traces.
- i. Use the peak marker function to determine the maximum amplitude level.

For Average Power (Duty cycle < 98%)

- a. Measure the duty cycle (x).
- b. Set instrument center frequency to DTS channel center frequency.
- c. Set span to at least 1.5 times the OBW.
- d. Set RBW to:  $3 \text{ kHz} \leq \text{RBW} \leq 100 \text{ kHz}$ .
- e. Set VBW  $\geq 3 \times \text{RBW}$ .
- f. Detector = power averaging (RMS) or sample detector (when RMS not available).
- g. Ensure that the number of measurement points in the sweep  $\geq 2 \times \text{span}/\text{RBW}$ .
- h. Sweep time = auto couple.
- i. Do not use sweep triggering. Allow sweep to “free run”.
- j. Employ trace averaging (RMS) mode over a minimum of 100 traces.
- k. Use the peak marker function to determine the maximum amplitude level.
- l. Add  $10 \log (1/x)$ , where x is the duty cycle measured in step (a, to the measured PSD to compute the average PSD during the actual transmission time.

#### 4.6.5 Deviation from Test Standard

No deviation.

#### 4.6.6 EUT Operating Condition

The software provided by client to enable the EUT under transmission condition continuously at lowest, middle and highest channel frequencies individually.

#### 4.6.7 Test Results

##### 802.11b

| Channel | Frequency (MHz) | PSD (dBm/3 kHz) | Limit (dBm/3 kHz) | Pass / Fail |
|---------|-----------------|-----------------|-------------------|-------------|
| 1       | 2412            | -18.95          | 8                 | Pass        |
| 6       | 2437            | -16.67          | 8                 | Pass        |
| 11      | 2462            | -17.56          | 8                 | Pass        |

##### 802.11g

| Channel | Frequency (MHz) | PSD (dBm/3 kHz) | Limit (dBm/3 kHz) | Pass / Fail |
|---------|-----------------|-----------------|-------------------|-------------|
| 1       | 2412            | -16.19          | 8                 | Pass        |
| 6       | 2437            | -13.02          | 8                 | Pass        |
| 11      | 2462            | -17.35          | 8                 | Pass        |

##### 802.11n (VHT20)

| Channel | Frequency (MHz) | PSD (dBm/3 kHz) | Duty Factor (dB) | Total PSD (dBm/3 kHz) | Limit (dBm/3 kHz) | Pass / Fail |
|---------|-----------------|-----------------|------------------|-----------------------|-------------------|-------------|
| 1       | 2412            | -16.87          | 0.10             | -16.78                | 8                 | Pass        |
| 6       | 2437            | -13.70          | 0.10             | -13.61                | 8                 | Pass        |
| 11      | 2462            | -18.68          | 0.10             | -18.59                | 8                 | Pass        |

##### 802.11n (VHT40)

| Channel | Frequency (MHz) | PSD (dBm/3 kHz) | Duty Factor (dB) | Total PSD (dBm/3 kHz) | Limit (dBm/3 kHz) | Pass / Fail |
|---------|-----------------|-----------------|------------------|-----------------------|-------------------|-------------|
| 3       | 2422            | -21.09          | 0.23             | -20.86                | 8                 | Pass        |
| 6       | 2437            | -21.68          | 0.23             | -21.45                | 8                 | Pass        |
| 9       | 2452            | -24.05          | 0.23             | -23.82                | 8                 | Pass        |

### Spectrum Plot of Worst Value

#### 802.11b

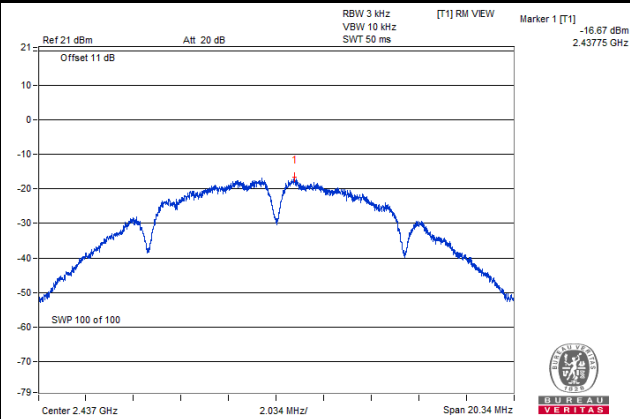

#### 802.11g

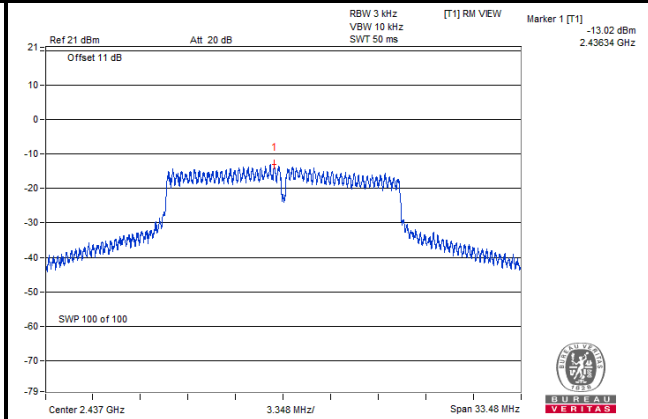

#### 802.11n (VHT20)

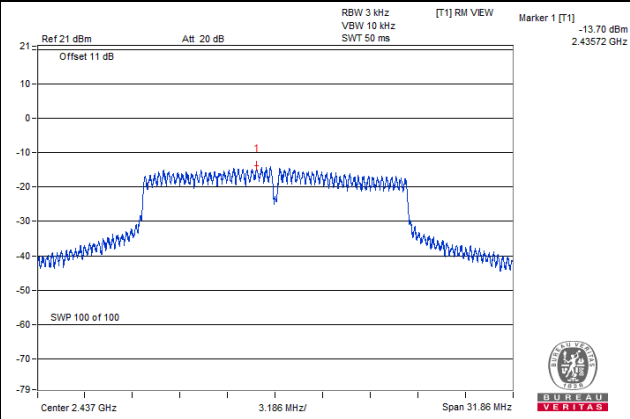

#### 802.11n (VHT40)

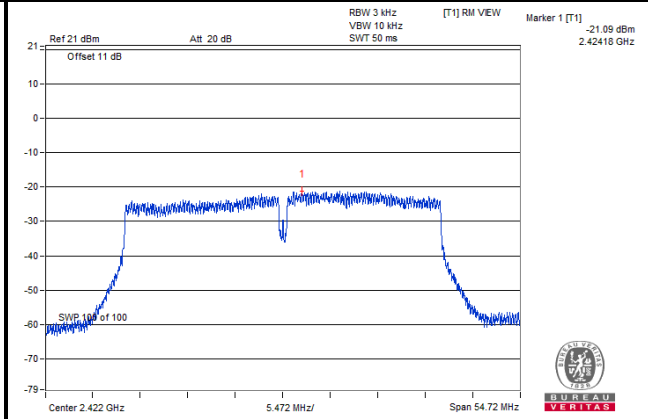

## 4.7 Conducted Out of Band Emission Measurement

### 4.7.1 Limits of Conducted Out of Band Emission Measurement

Below -30 dB of the highest emission level of operating band (in 100 kHz Resolution Bandwidth).

### 4.7.2 Test Setup

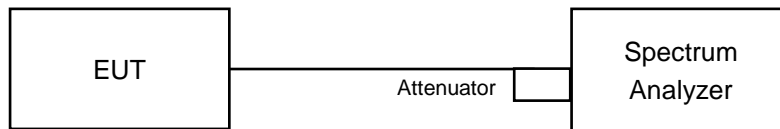

### 4.7.3 Test Instruments

Refer to section 4.1.2 to get information of above instrument.

### 4.7.4 Test Procedure

#### MEASUREMENT PROCEDURE REF

1. Set the RBW = 100 kHz.
2. Set the VBW  $\geq$  300 kHz.
3. Detector = peak.
4. Sweep time = auto couple.
5. Trace mode = max hold.
6. Allow trace to fully stabilize.
7. Use the peak marker function to determine the maximum power level in any 100 kHz band segment within the fundamental EBW.

#### MEASUREMENT PROCEDURE OOB

1. Set RBW = 100 kHz.
2. Set VBW  $\geq$  300 kHz.
3. Detector = peak.
4. Sweep = auto couple.
5. Trace Mode = max hold.
6. Allow trace to fully stabilize.
7. Use the peak marker function to determine the maximum amplitude level.

### 4.7.5 Deviation from Test Standard

No deviation.

### 4.7.6 EUT Operating Condition

The software provided by client to enable the EUT under transmission condition continuously at lowest, middle and highest channel frequencies individually.



### 4.7.7 Test Results

The spectrum plots are attached on the following images. D1 line indicates the highest level, and D2 line indicates the 30 dB offset below D1. It shows compliance with the requirement.

#### 802.11b

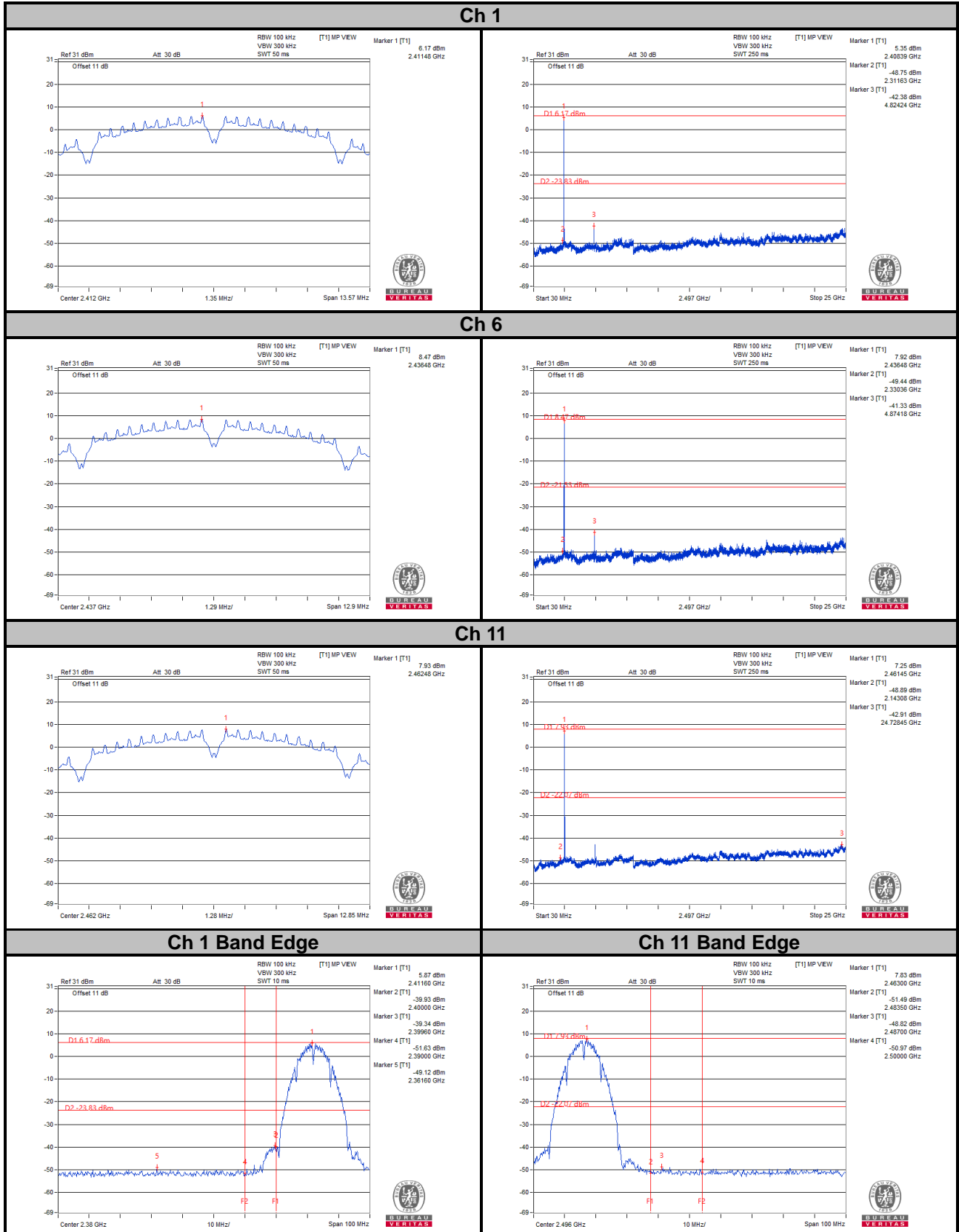

802.11g

Ch 1

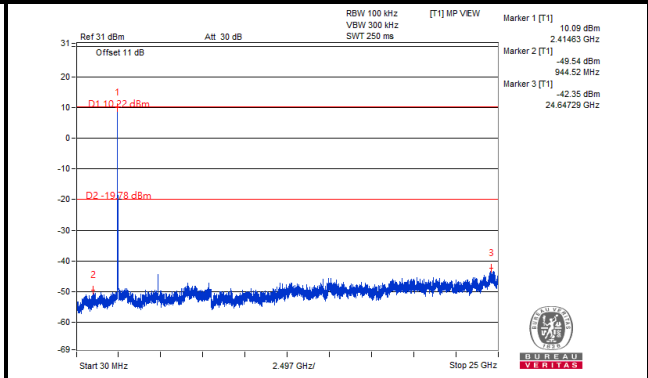
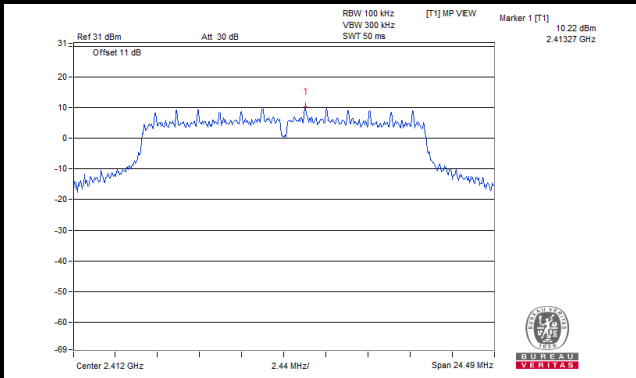

Ch 6

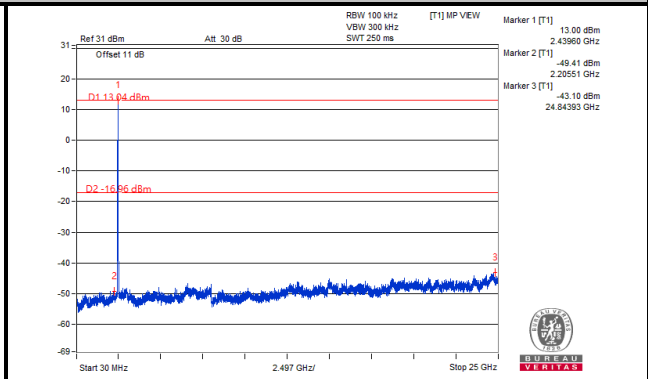
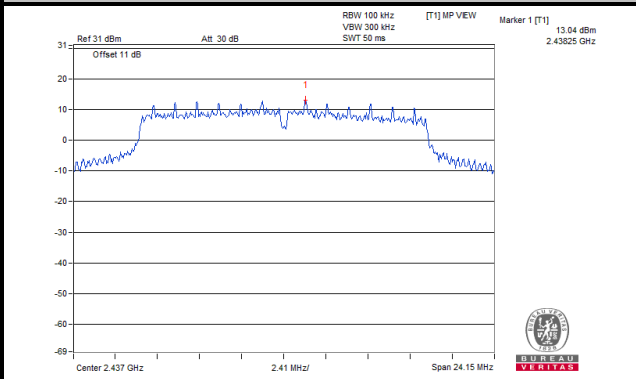

Ch 11

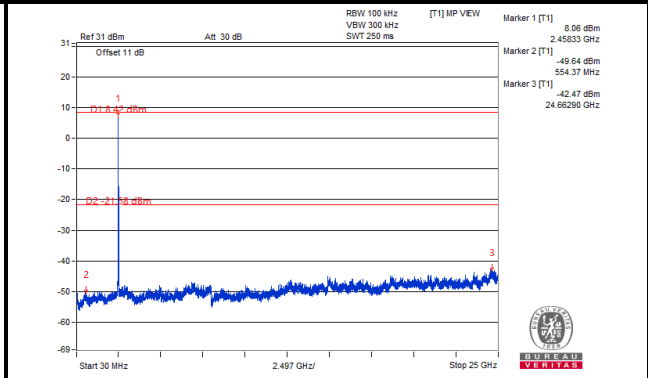
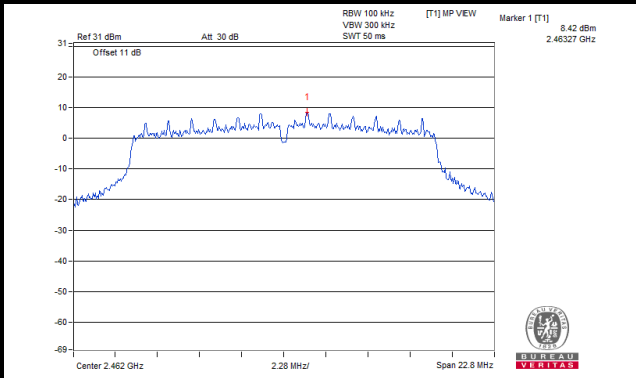

Ch 1 Band Edge

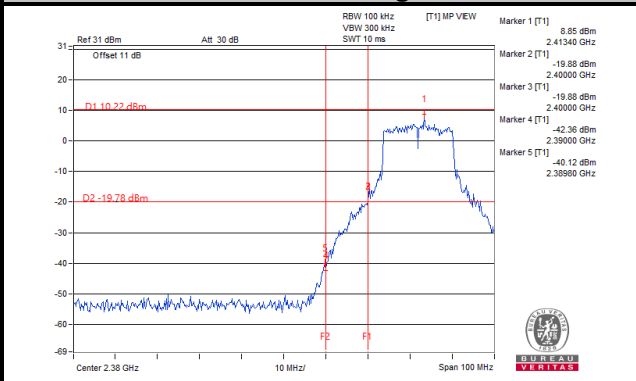

Ch 11 Band Edge

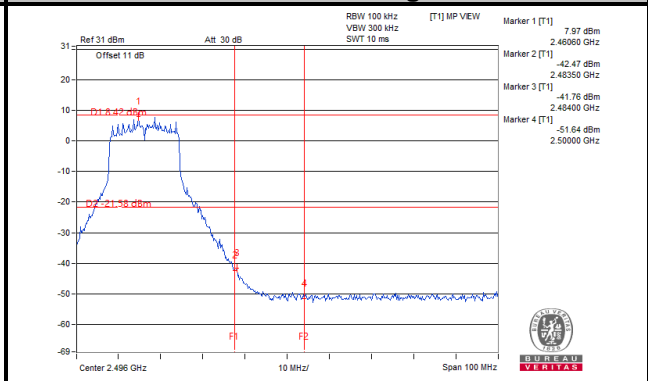

# 802.11n (VHT20)

## Ch 1

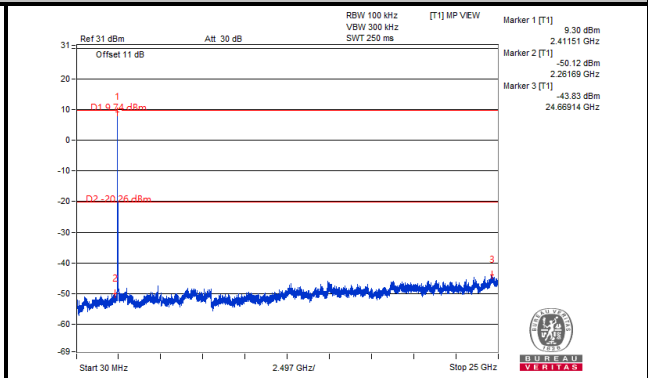
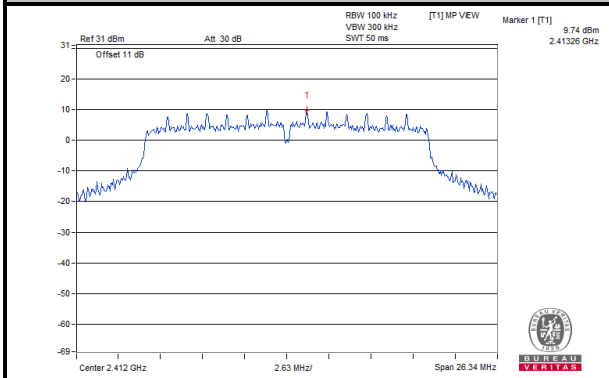

## Ch 6

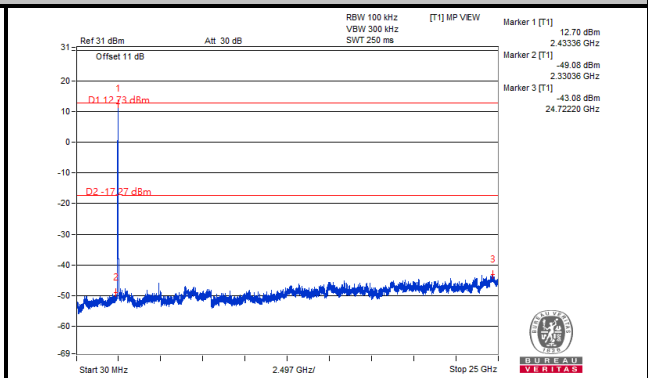
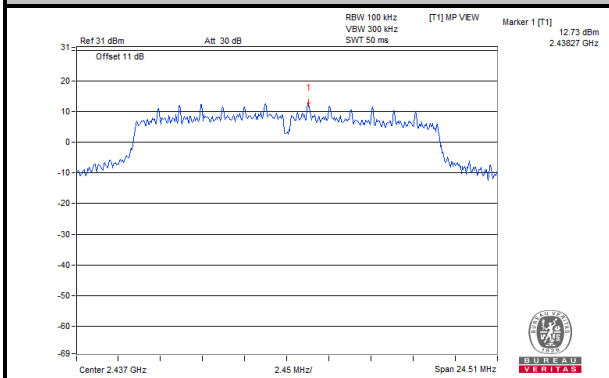

## Ch 11

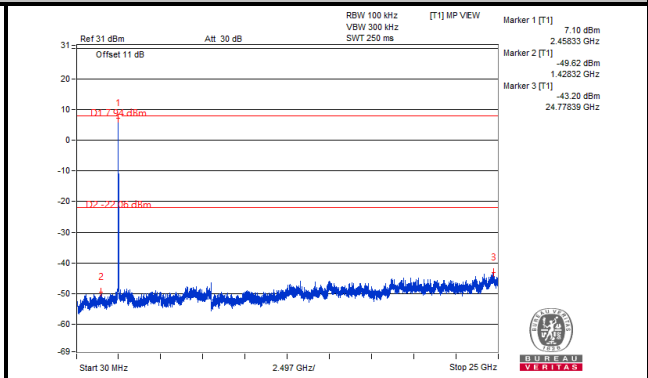
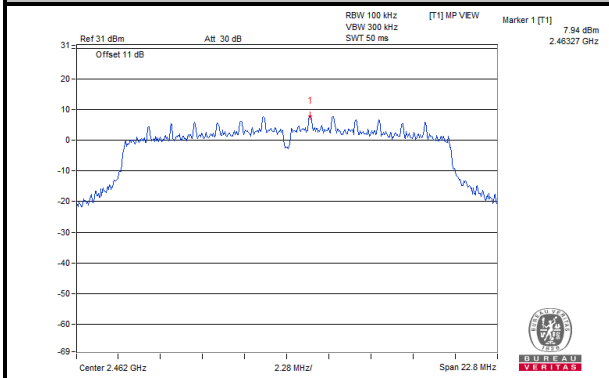

## Ch 1 Band Edge

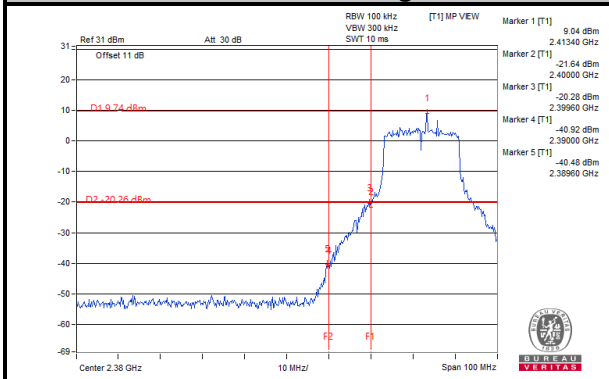

## Ch 11 Band Edge

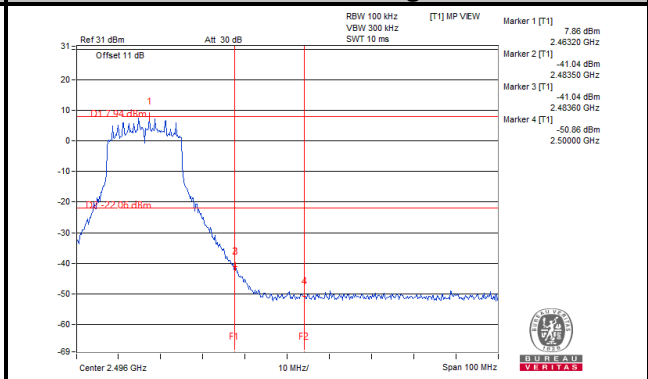

# 802.11n (VHT40)

## Ch 3

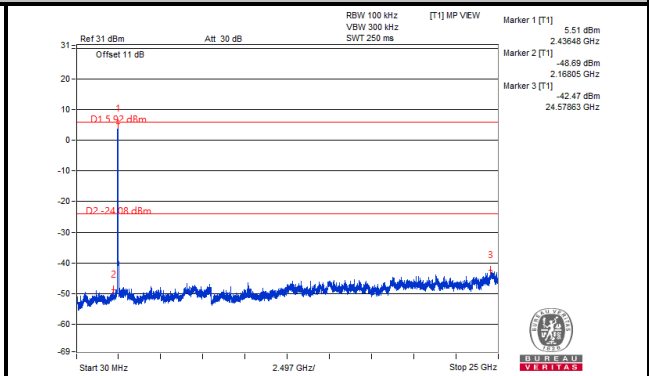
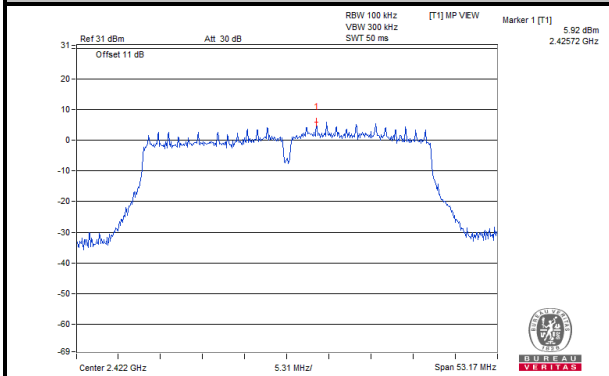

## Ch 6

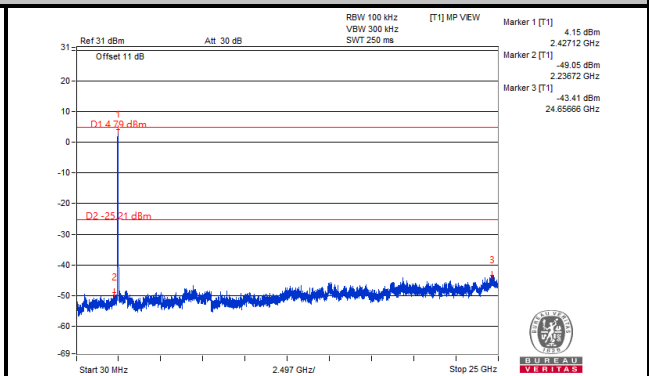
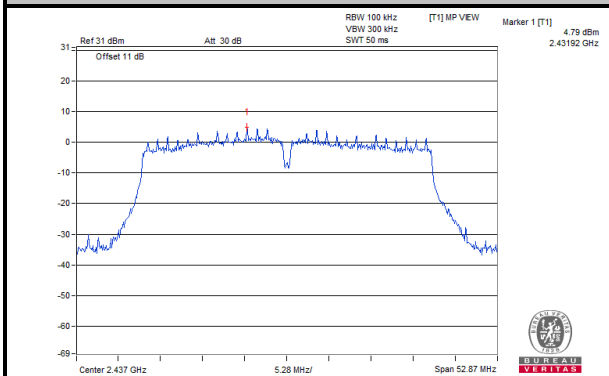

## Ch 9

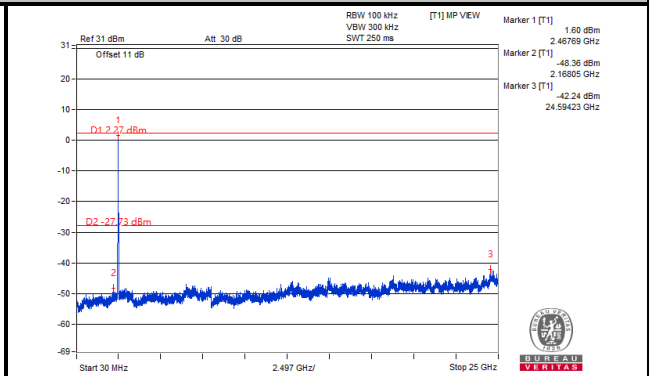
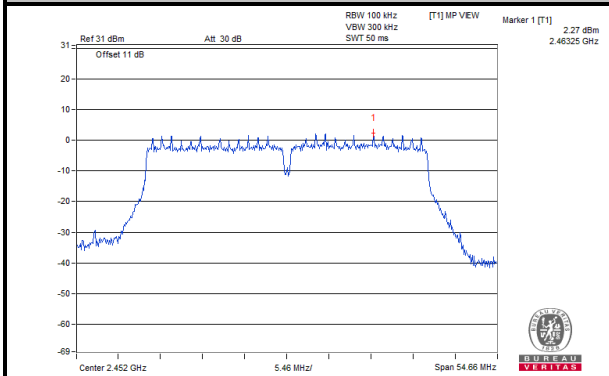

## Ch 3 Band Edge

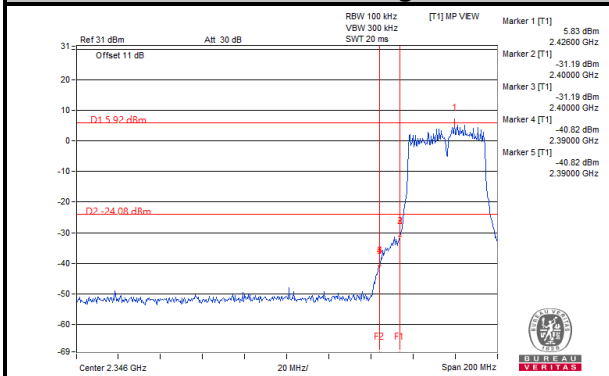

## Ch 9 Band Edge

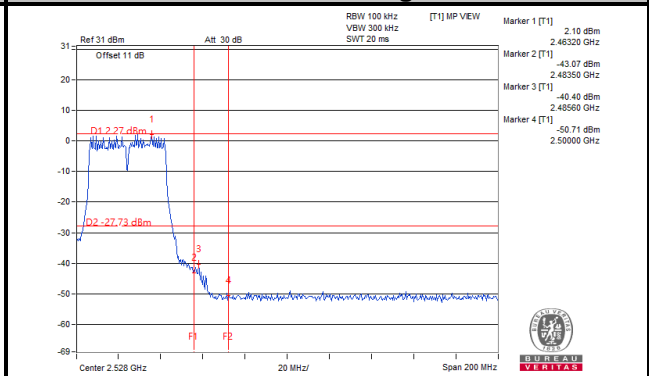

## 5 Pictures of Test Arrangements

Please refer to the attached file (Test Setup Photo).

# Annex A- Band Edge Measurement

## 802.11b

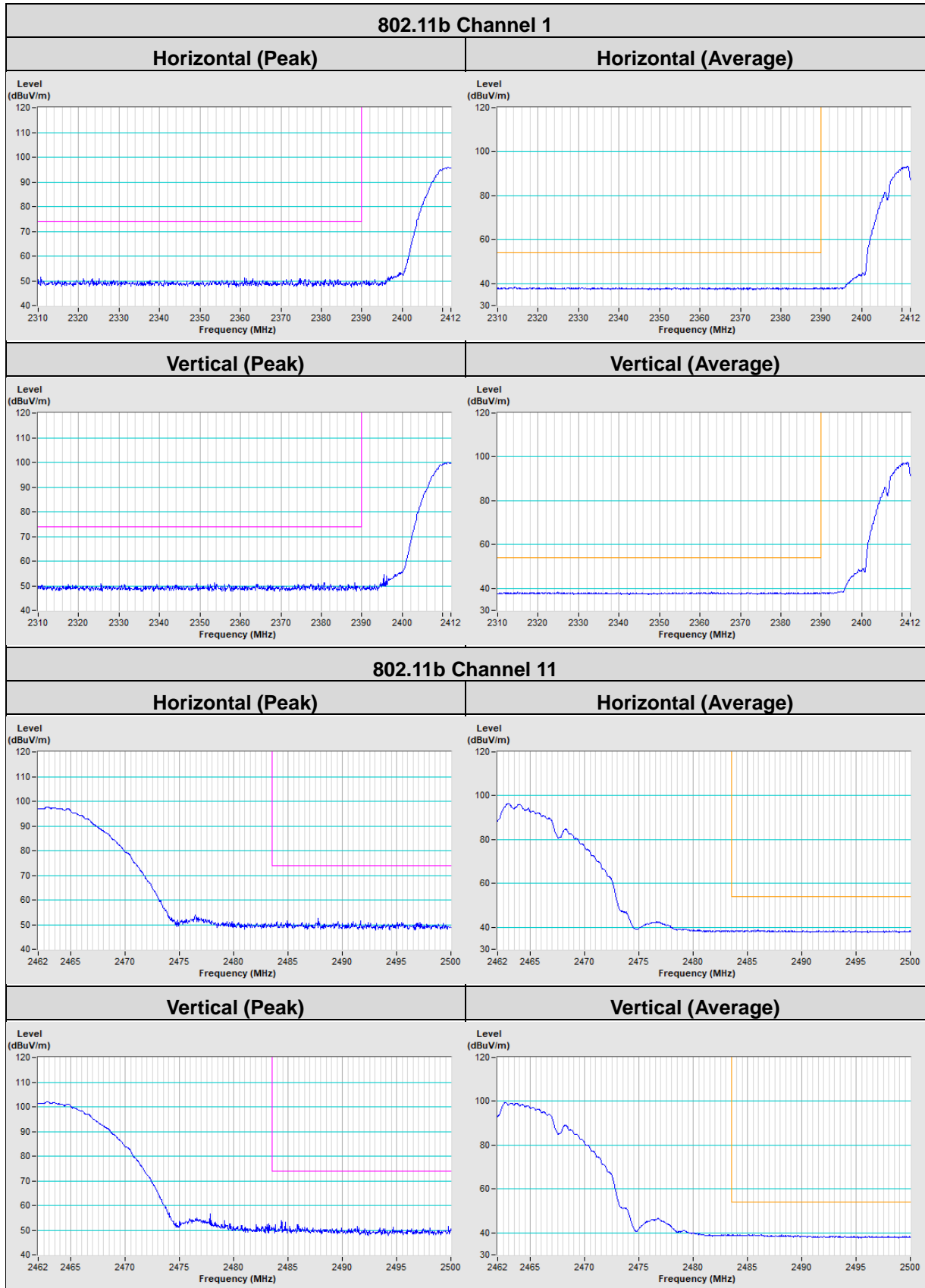

802.11g

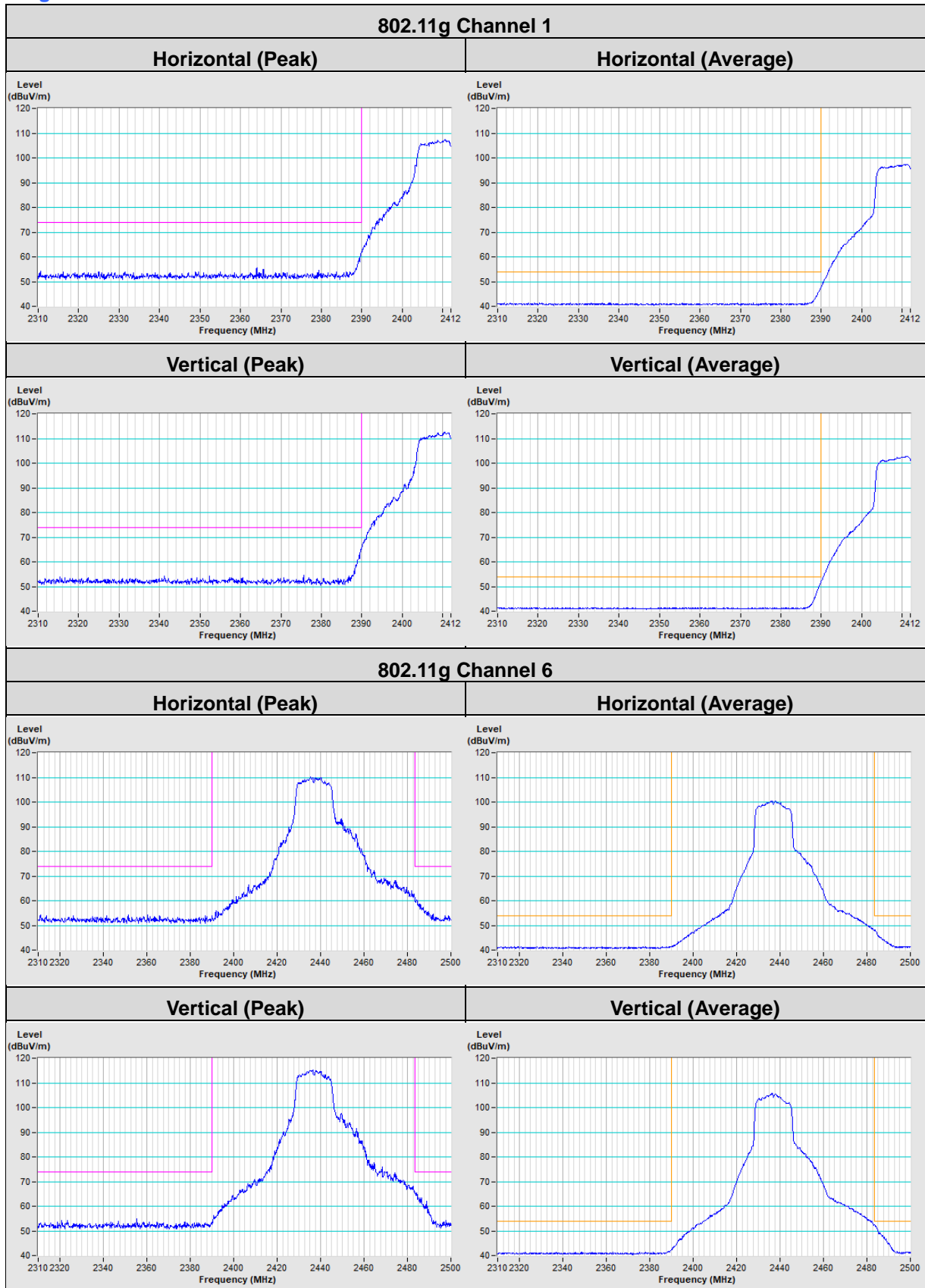

### 802.11g Channel 11

#### Horizontal (Peak)

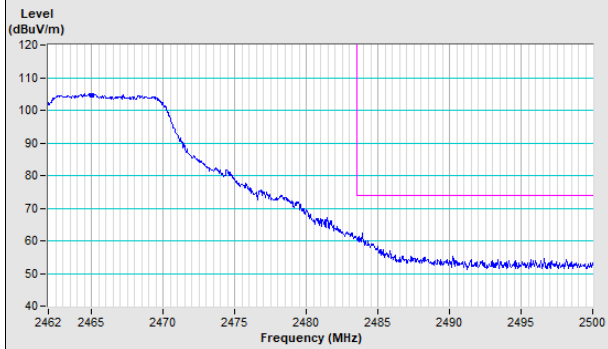

#### Horizontal (Average)

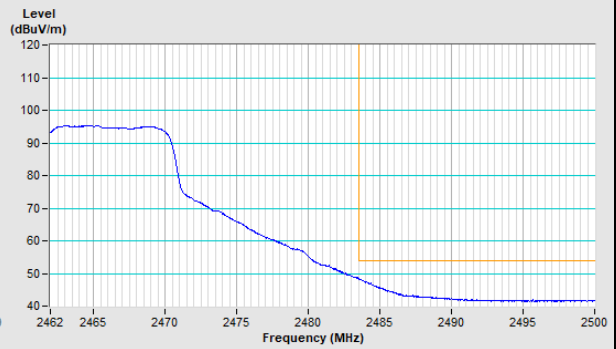

#### Vertical (Peak)

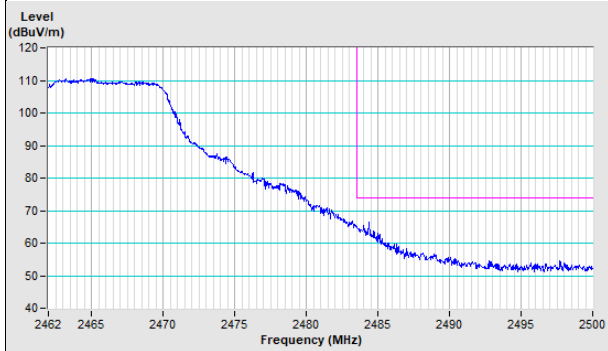

#### Vertical (Average)

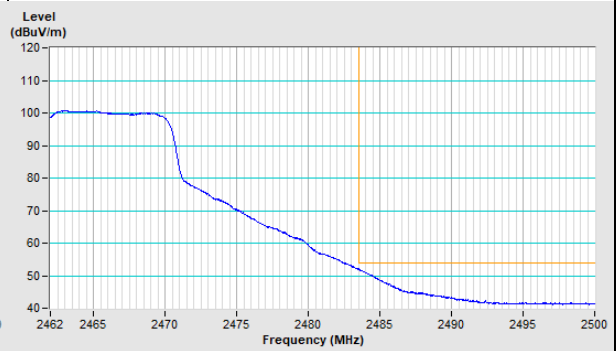



### 802.11n (VHT20)

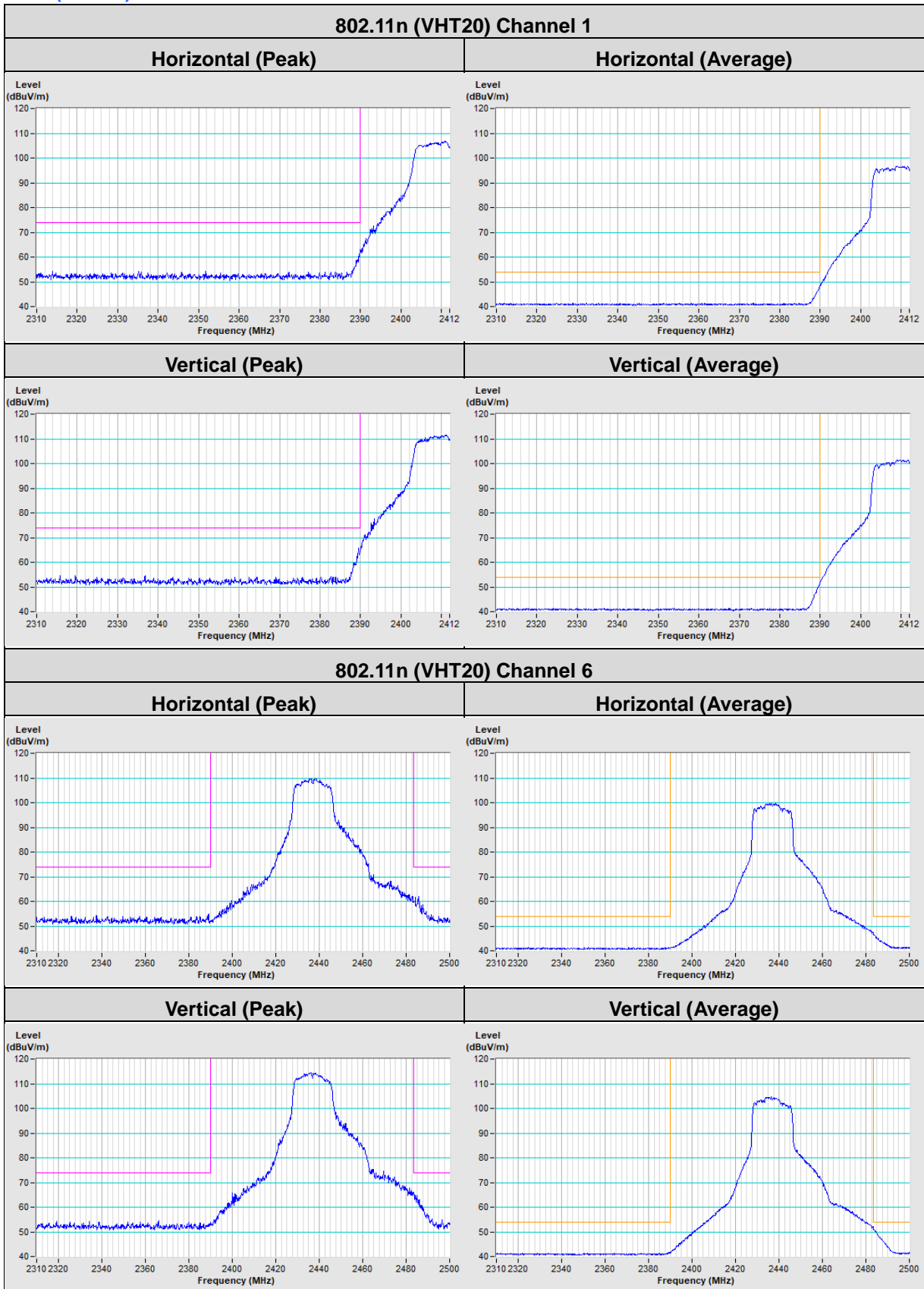

### 802.11n (VHT20) Channel 11

**Horizontal (Peak)**

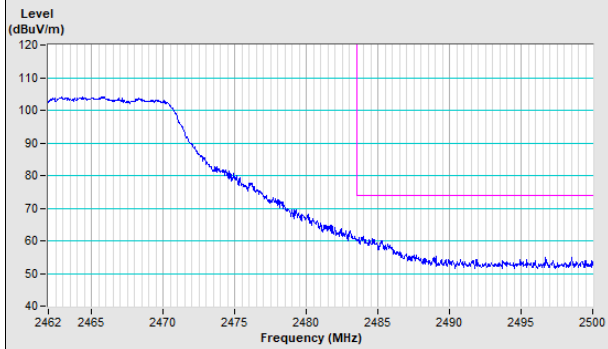

**Horizontal (Average)**

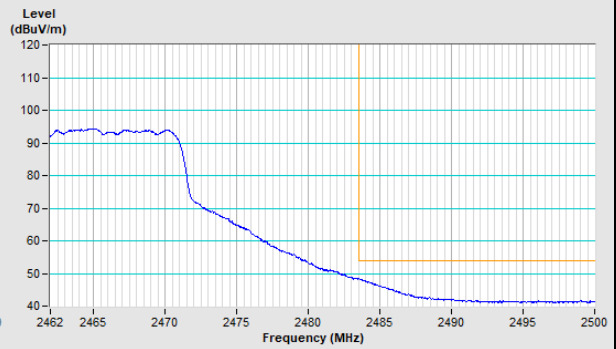

**Vertical (Peak)**

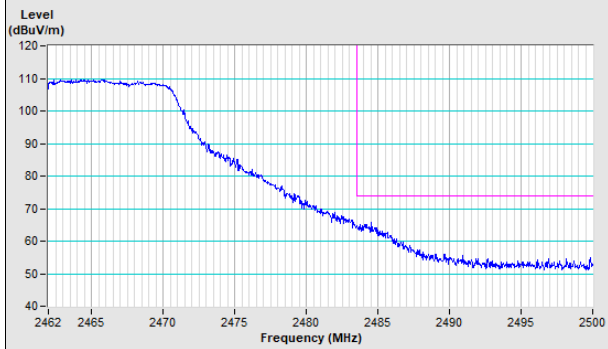

**Vertical (Average)**

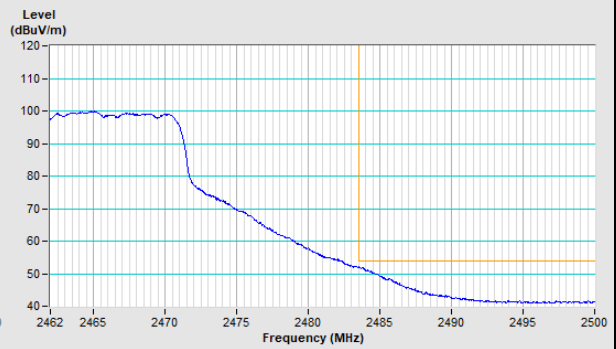

### 802.11n (VHT40)

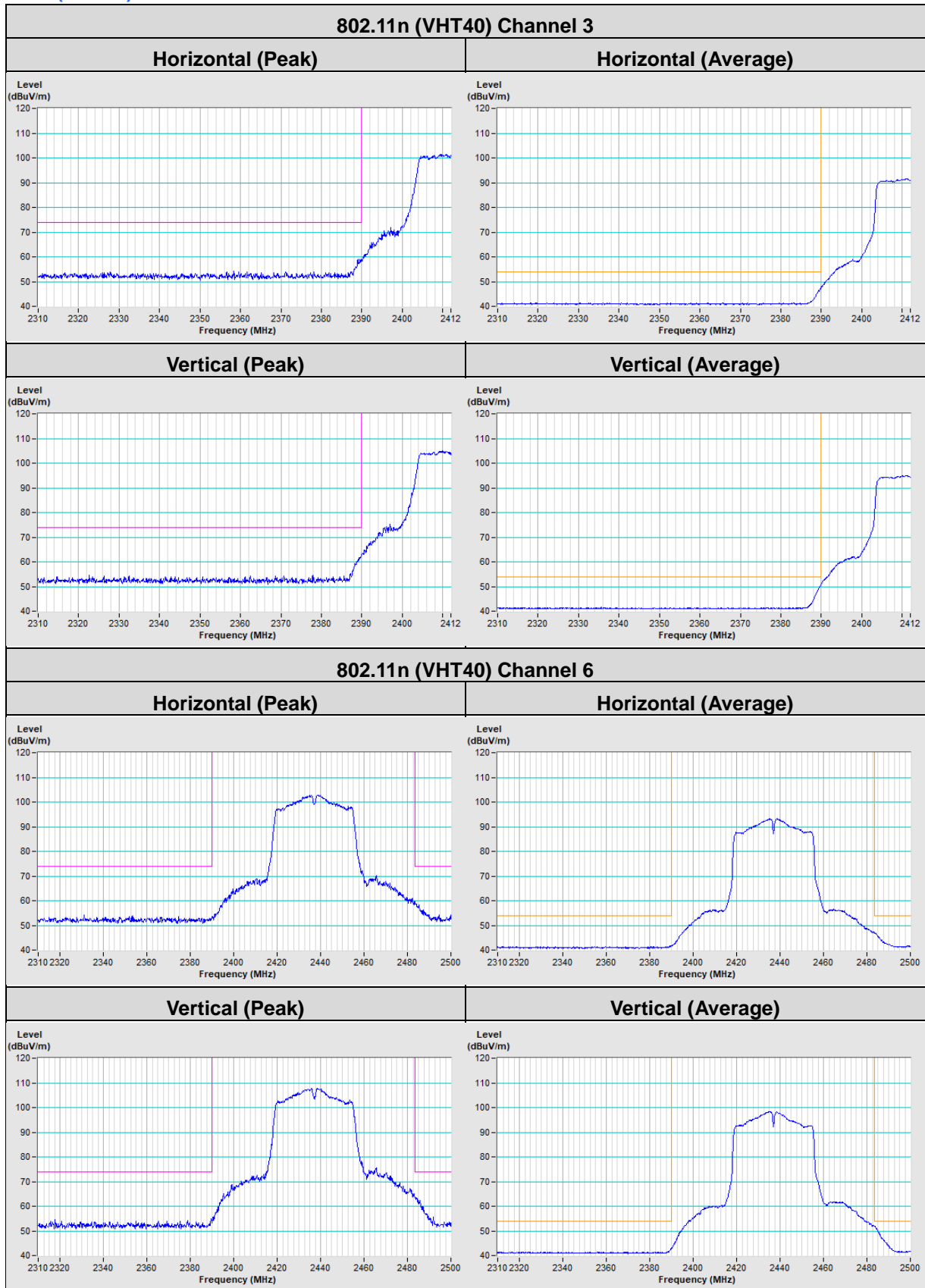

### 802.11n (VHT40) Channel 9

**Horizontal (Peak)**

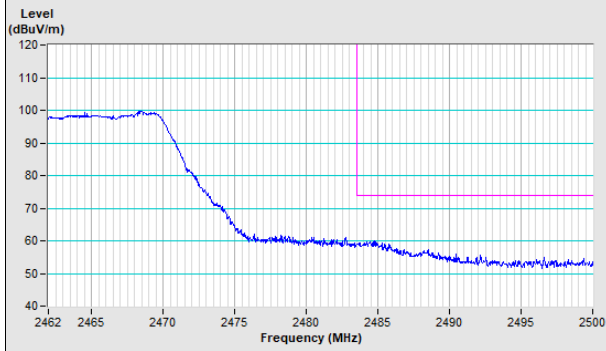

**Horizontal (Average)**

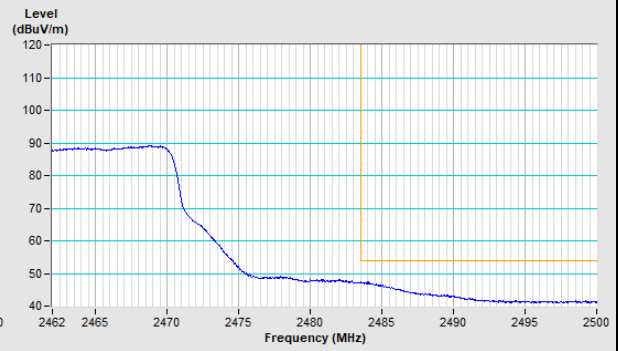

**Vertical (Peak)**

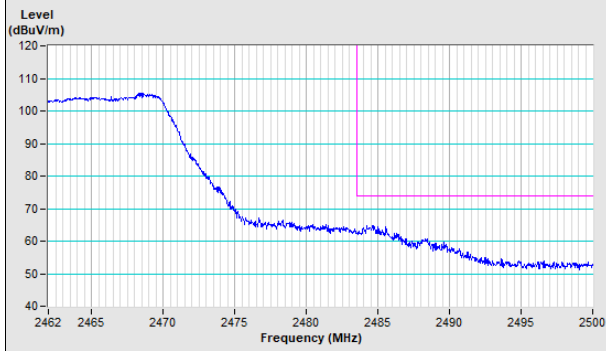

**Vertical (Average)**

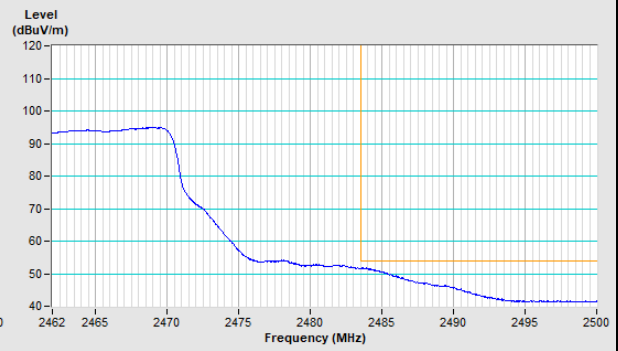

## Appendix – Information of the Testing Laboratories

We, Bureau Veritas Consumer Products Services (H.K.) Ltd., Taoyuan Branch, were founded in 1988 to provide our best service in EMC, Radio, Telecom and Safety consultation. Our laboratories are FCC recognized accredited test firms and accredited according to ISO/IEC 17025.

If you have any comments, please feel free to contact us at the following:

**Lin Kou EMC/RF Lab**

Tel: 886-2-26052180

Fax: 886-2-26051924

**Hsin Chu EMC/RF/Telecom Lab**

Tel: 886-3-6668565

Fax: 886-3-6668323

**Hwa Ya EMC/RF/Safety Lab**

Tel: 886-3-3183232

Fax: 886-3-3270892

**Email:** [service.adt@tw.bureauveritas.com](mailto:service.adt@tw.bureauveritas.com)

**Web Site:** [www.bureauveritas-adt.com](http://www.bureauveritas-adt.com)

The address and road map of all our labs can be found in our web site also.

--- END ---