

## RF Test Report

Applicant : Lantronix, Inc.

Product Name : Wireless Module

Trade Name : LANTRONIX

Model Number : Open-Q 4200 SIP

Applicable Standard : FCC 47 CFR PART 15 SUBPART C  
ANSI C63.10:2013

Received Date : Mar. 29, 2023

Test Period : Aug. 01 ~ Aug. 23, 2023

Issued Date : Nov. 15, 2023

### Issued by

Eurofins E&E Wireless Taiwan Co., Ltd.  
No. 140-1, Changan Street, Bade District,  
Taoyuan City 334025, Taiwan (R.O.C.)  
Tel : +886-3-2710188 / Fax : +886-3-2710190



Taiwan Accreditation Foundation accreditation number: 1330  
Frequency Range: 9 kHz to 325 GHz  
Test Firm Registration Number: 226252 (Bade test site)  
Test Firm Registration Number: 191812 (Wugu test site)

#### Note:

1. The test results are valid only for samples provided by customers and under the test conditions described in this report.
2. This report shall not be reproduced except in full, without the written approval of Eurofins E&E Wireless Taiwan Co., Ltd.
3. The relevant information is provided by customers in this test report. According to the correctness, appropriateness or completeness of the information provided by the customer, if there is any doubt or error in the information which affects the validity of the test results, the laboratory does not take the responsibility.

**Revision History**

Version	Issued Date	Revisions	Revised By
00	Nov. 15, 2023	Initial Issue	Abby Huang

## Verification of Compliance

Applicant : Lantronix, Inc.

Product Name : Wireless Module

Trade Name : LANTRONIX

Model Number : Open-Q 4200 SIP

FCC ID : R68OQ4200S

Applicable Standard : FCC 47 CFR PART 15 SUBPART C  
ANSI C63.10:2013

Test Result : Complied

Performing Lab. : Eurofins E&E Wireless Taiwan Co., Ltd.  
No. 140-1, Changan Street, Bade District,  
Taoyuan City 334025, Taiwan (R.O.C.)  
Tel : +886-3-2710188 / Fax : +886-3-2710190  
Taiwan Accreditation Foundation accreditation number: 1330



Eurofins E&E Wireless Taiwan Co., Ltd. tested the above equipment in accordance with the requirements set forth in the above standards. All indications of Pass/Fail in this report are opinions expressed by Eurofins E&E Wireless Taiwan Co., Ltd. based on interpretations and/or observations of test results. The test results show that the equipment tested is capable of demonstrating compliance with the requirements as documented in this report.

Approved By : \_\_\_\_\_

## TABLE OF CONTENTS

<b>1</b>	<b>General Information</b> .....	<b>5</b>
	1.1. Summary of Test Result.....	5
	1.2. Testing Location.....	6
	1.3. Measurement Uncertainty.....	6
	1.4. Test Site Environment.....	6
<b>2</b>	<b>EUT Description</b> .....	<b>7</b>
<b>3</b>	<b>Test Methodology</b> .....	<b>9</b>
	3.1. Mode of Operation .....	9
	3.2. EUT Test Step.....	9
	3.3. Configuration of Test System Details .....	10
	3.4. Test Instruments .....	11
<b>4</b>	<b>Measurement Procedure</b> .....	<b>14</b>
	4.1. Maximum Conducted Output Power Measurement .....	14
	4.2. AC Power Line Conducted Emission Measurement .....	15
	4.3. Radiated Emission Measurement.....	17
	4.4. 20 dB RF Bandwidth Measurement.....	21
	4.5. Carrier Frequency Separation Measurement.....	22
	4.6. Number of Hopping Measurement.....	23
	4.7. Time of Occupancy (Dwell Time) Measurement .....	24
	4.8. Out of Band Conducted Emissions Measurement .....	25
	4.9. Antenna Measurement .....	25
	4.10. Other requirements.....	26
<b>5</b>	<b>Test Results</b> .....	<b>27</b>
	5.1. Conducted Emission.....	27
	5.2. Conducted Test Results.....	29
	5.3. Radiated Emission Measurement.....	30

**Appendix A. Test Data**

**Appendix B. Test Plots**

**Appendix C. Test Setup Photographs**

# 1 General Information

## 1.1. Summary of Test Result

Standard	Item	Result	Remark
15.207	AC Power Conducted Emission	PASS	-----
15.203	Antenna Requirement	PASS	-----
15.247(b)(1)	Max. Output Power	PASS	-----
15.247(d)	Transmitter Radiated Emissions	PASS	-----
15.247(a)(1)	20 dB RF Bandwidth	PASS	-----
15.247(a)(1)	Carrier Frequency Separation	PASS	-----
15.247(a)(1)(iii)	Number of Hopping	PASS	-----
15.247(a)(1)(iii)	Time of Occupancy (Dwell Time)	PASS	-----
15.247(d)	Out of Band Conducted Spurious Emission	PASS	-----

Decision Rule

- Uncertainty is not included.
- Uncertainty is included.

Standard	Description
CFR47, Part 15, Subpart C	Intentional Radiators
ANSI C63. 10: 2013	American National Standard of Procedures for Compliance Testing of Unlicensed Wireless Devices
DA 00-705	Filing and Measurement Guidelines for Frequency Hopping Spread Spectrum Systems

### 1.2. Testing Location

Lab Name: Eurofins E&E Wireless Taiwan Co., Ltd.

Site Address:  No. 140-1, Changan Street, Bade District, Taoyuan City 334025, Taiwan (R.O.C.)

Site Address:  No. 2, Wuquan 5th Rd. Wugu Dist., New Taipei City, Taiwan (R.O.C.)

### 1.3. Measurement Uncertainty

Test Item	Frequency	Uncertainty			
		BD	WG		
Conducted Emission	150 kHz ~ 30 MHz	2.7 dB	2.6 dB		
Conducted Output Power		1.1 dB	1.1 dB		
RF Bandwidth		4.5 %	4.5 %		
Power Spectral Density		1.1 dB	1.1 dB		
Test Item	Frequency	Uncertainty			
		96601-BD	96603-BD	96602-WG	96603-WG
Radiated Emission	9 kHz ~ 30 MHz	1.9 dB	1.9 dB	1.6 dB	1.6 dB
	30 MHz ~ 1000 MHz	4.9 dB	4.9 dB	4.8 dB	4.8 dB
	1000 MHz ~ 18000 MHz	4.9 dB	5.0 dB	5.0 dB	5.2 dB
	18000 MHz ~ 26500 MHz	4.3 dB	4.4 dB	4.4 dB	4.5 dB
	26500 MHz ~ 40000 MHz	4.5 dB	4.5 dB	4.6 dB	4.5 dB

### 1.4. Test Site Environment

Items	Required (IEC 60068-1)	Interval(*)
Temperature (°C)	15-35	20-30
Humidity (%RH)	25-75	45-75

(\*)The measurement ambient temperature is within this range.

## 2 EUT Description

The product specifications of the EUT presented in the report are declared by the manufacturer who shall take full responsibility for the authenticity(except Max. RF Output Power).

Applicant	Lantronix, Inc. 48 Discovery, Suite 250, Irvine, CA 92618 USA		
Product Name	Wireless Module		
Trade Name	LANTRONIX		
Model Number	Open-Q 4200 SIP		
FCC ID	R68OQ4200S		
Frequency Range	2402 ~ 2480 MHz		
Modulation Type	GFSK for 1 Mbps		
	$\pi/4$ -DQPSK for 2 Mbps		
	8DPSK for 3 Mbps		
Operate Temp. Range	-25 ~ +85 °C		
EUT Power Rating	3.8 Vdc		
Antenna information	Type		Max. Gain (dBi)
	Dipole Antenna		3.32
Max. RF Output Power	GFSK for 1 Mbps	0.01683	W
	$\pi/4$ -DQPSK for 2 Mbps	0.01493	W
	8DPSK for 3 Mbps	0.01589	W

CH	Freq. (MHz)	CH	Freq. (MHz)	CH	Freq. (MHz)	CH	Freq. (MHz)
0	2402	20	2422	40	2442	60	2462
1	2403	21	2423	41	2443	61	2463
2	2404	22	2424	42	2444	62	2464
3	2405	23	2425	43	2445	63	2465
4	2406	24	2426	44	2446	64	2466
5	2407	25	2427	45	2447	65	2467
6	2408	26	2428	46	2448	66	2468
7	2409	27	2429	47	2449	67	2469
8	2410	28	2430	48	2450	68	2470
19	2411	29	2431	49	2451	69	2471
10	2412	30	2432	50	2452	70	2472
11	2413	31	2433	51	2453	71	2473
12	2414	32	2434	52	2454	72	2474
13	2415	33	2435	53	2455	73	2475
14	2416	34	2436	54	2456	74	2476
15	2417	35	2437	55	2457	75	2477
16	2418	36	2438	56	2458	76	2478
17	2419	37	2439	57	2459	77	2479
18	2420	38	2440	58	2460	78	2480
19	2421	39	2441	59	2461	---	---



### 3 Test Methodology

#### 3.1. Mode of Operation

Decision of Test Eurofins has verified the construction and function in typical operation. All the test modes were carried out with the EUT in normal operation, which was shown in this test report and defined as:

Pre-Test Mode
Transmit Mode
BT_GFSK
BT_π/4-DQPSK
BT_8DPSK

After verification, all tests were carried out with the worst case test modes.

By preliminary testing and verifying three axis (X, Y and Z) position of EUT transmitted status, it was found that “Z axis” position was the worst, then the final test was executed the worst condition and test data were recorded in this report.

Final-Test Mode
Transmit Mode
BT_GFSK
BT_8DPSK

Description of Test Modes

Preliminary tests were performed in different modulation to find the worst case. The modulation has shown the worst-case in section 4.5. Investigation has been done on all the possible configurations for searching the worst cases.

#### 3.2. EUT Test Step

1	Setup the EUT shown on “Configuration of Test System Details.”
2	Turn on the power of all equipment.
3	Turn on TX function
4	EUT run test program.

### 3.3. Configuration of Test System Details

#### Radiated Emission

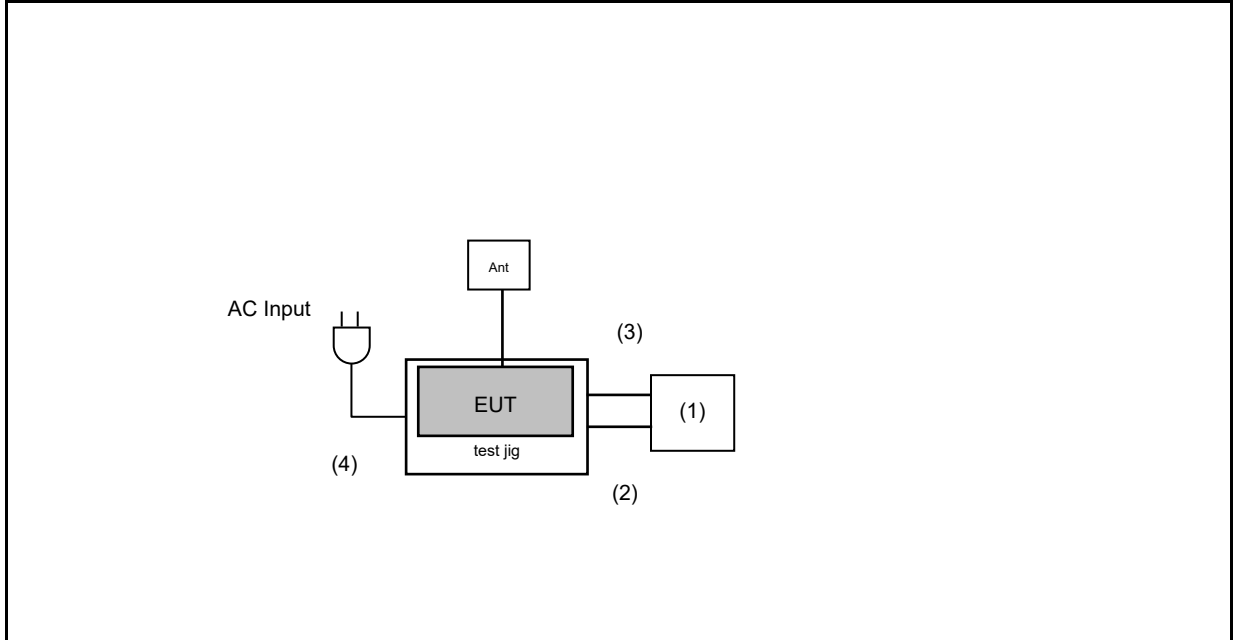

	Product	Manufacturer	Model Number	Serial Number	Power Cord
(1)	Notebook	DELL	P137G	---	---
(2)	Type C to USB A	Chang Xin	MPA-EZTC010	---	---
(3)	Type A to micro cable	Xiang Chang	UCA85	---	---
(4)	Adapter	Chenzhou Frecom Electronics Co., Ltd.	F30L7-120250SPAU	---	---

### 3.4. Test Instruments

For Conducted

Test Period: Aug. 01 2023

Testing Engineer: Sandy Yang

Test Site		RF03-WG				
Use	Equipment	Manufacturer	Model Number	Serial Number	Cal. Date	Cal. Period
<input checked="" type="checkbox"/>	Power Sensor	Anritsu	MA24408A	11998	Feb. 07, 2023	1 year
<input checked="" type="checkbox"/>	Spectrum Analyzer (10 Hz~26.5 GHz)	Keysight	N9010B	MY63460164	Mar. 07, 2023	1 year

Note: N.C.R. = No Calibration Request.

For Radiated Emissions

Test Period: Aug. 15 ~ Aug. 22, 2023

Testing Engineer: Jason Yeh

Radiation test sites		Semi Anechoic Room 96603-WG				
Use	Equipment	Manufacturer	Model Number	Serial Number	Cal. Date	Cal. Period
<input checked="" type="checkbox"/>	LOOP Antenna (9 kHz~30 MHz)	Schwarzbeck Mess-Elektronik	FMZB 1513-60	00031	Feb. 21, 2023	1 year
<input checked="" type="checkbox"/>	Trilog Broadband Antenna (30 MHz~1 GHz)	Schwarzbeck Mess-Elektronik	VULB9168	1276	Feb. 09, 2023	1 year
<input checked="" type="checkbox"/>	Broadband Horn Antenna (1 GHz~18 GHz)	RF SPIN	DRH18-E	210307A18ES	Dec. 22, 2022	1 year
<input checked="" type="checkbox"/>	Broadband Horn Antenna (15 GHz~40 GHz)	Schwarzbeck Mess-Elektronik	BBHA9170	1133	Feb. 13, 2023	1 year
<input checked="" type="checkbox"/>	Spectrum Analyzer (2 Hz~50 GHz)	KEYSIGHT	N9030B	MY57153537	Apr. 18, 2023	1 year
<input checked="" type="checkbox"/>	Pre-Amplifier	EMCI	EMC001330	980859	Nov. 01, 2022	1 year
<input checked="" type="checkbox"/>	Pre-Amplifier	EMCI	EMC118A45SE	980818	Dec. 15, 2022	1 year
<input checked="" type="checkbox"/>	Pre-Amplifier	EMCI	EMC184045SE	980861	Dec. 15, 2022	1 year
<input checked="" type="checkbox"/>	Coaxial Cable (10 kHz~3000 MHz)	EMCI	EMCCFD400-NM-NM-2000	211009	Dec. 28, 2022	1 year
<input checked="" type="checkbox"/>	Coaxial Cable (10 kHz~3000 MHz)	EMCI	EMCCFD400-NM-NM-2000	211010	Dec. 28, 2022	1 year
<input checked="" type="checkbox"/>	Coaxial Cable (10 kHz~3000 MHz)	EMCI	EMCCFD400-NM-NM-6000	211018	Dec. 28, 2022	1 year
<input checked="" type="checkbox"/>	Coaxial Cable (1 GHz~18 GHz)	EMCI	EMC104-SM-SM-1000	211029	Dec. 28, 2022	1 year
<input checked="" type="checkbox"/>	Coaxial Cable (1 GHz~18 GHz)	EMCI	EMC104-SM-SM-2000	211033	Dec. 28, 2022	1 year
<input checked="" type="checkbox"/>	Coaxial Cable (1 GHz~18 GHz)	EMCI	EMC104-SM-SM-8000	211038	Dec. 28, 2022	1 year
<input checked="" type="checkbox"/>	Coaxial Cable (18GHz~40GHz)	EMCI	EMC101G-KM-KM-600	211211	Jan. 17, 2023	1 year
<input checked="" type="checkbox"/>	Coaxial Cable (18GHz~40GHz)	EMCI	EMC101G-KM-KM-2000	211210	Jan. 17, 2023	1 year
<input checked="" type="checkbox"/>	Coaxial Cable (18GHz~40GHz)	EMCI	EMC101G-KM-KM-6000	211209	Jan. 17, 2023	1 year
<input checked="" type="checkbox"/>	Highpass Filter	Warison	WFIL-H3000-20000F	WR4BBFWC2B1	Dec. 02, 2022	1 year
<input checked="" type="checkbox"/>	Highpass Filter	Warison	WFIL-H8000-26000F	001	Dec. 02, 2022	1 year
<input checked="" type="checkbox"/>	Software	R_RAM	V1.3	N/A	N.C.R.	---

Note: N.C.R. = No Calibration Request.

For Conduction Emissions

Test Period: Aug. 23, 2023

Testing Engineer: Jason Yeh,

Radiation test sites		Conducted Emission Measurement Conduction01-WG				
Use	Equipment	Manufacturer	Model Number	Serial Number	Cal. Date	Cal. Period
<input checked="" type="checkbox"/>	Test Receiver	R&S	ESR3	102919	Dec 30, 2022	1 year
<input checked="" type="checkbox"/>	LISN	R&S	ENV216	101041	Apr 12, 2023	1 year
<input checked="" type="checkbox"/>	Current Probe	R&S	EZ-17	101687	Jun 15, 2023	1 year
<input checked="" type="checkbox"/>	Cable	EMCI	EMCCFD300-BM-NM-4000	220402	Jun 08, 2023	1 year
<input checked="" type="checkbox"/>	Software	ELEKTRA	94.50.4	N.A.	N.C.R.	N.C.R.

Note: N.C.R. = No Calibration Request.

## 4 Measurement Procedure

### 4.1. Maximum Conducted Output Power Measurement

■ **Limit**

For frequency hopping systems operating in the 2400–2483.5 MHz band employing at least 75 non-overlapping hopping channels < 0.125 watt.

■ **Test Setup**

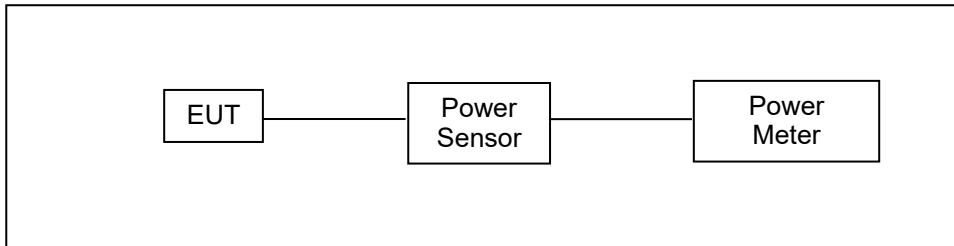

■ **Test Procedure**

Testing must be done according to this procedure, FCC Public Notice DA 00-705 - Filing and Measurement Guidelines for Frequency Hopping Spread Spectrum Systems. This is the only method recognized by the FCC. The tests below are run with the EUT's transmitter set at high power in TX mode. The EUT is needed to force selection of output power level and channel number. While testing, EUT was set to transmit continuously. Remove the Subjective device's antenna and connect the RF output port to power sensor. The maximum peak output power shall not exceed 1 watt.

Use a direct connection between the antenna port of transmitter and the power sensor, for prevent the power sensor input attenuation 40-50 dB. Set the RBW Bandwidth of the emission or use a channel power meter mode.

For antennas with gains of 6 dBi or less, maximum allowed transmitter output is 1 watt (+30 dBm). For antennas with gains greater than 6 dBi, transmitter output level must be decreased by an amount equal to (GAIN - 6)/3 dBm. The antenna port of the EUT was connected to the input of a power sensor. Power was read directly and cable loss correction was added to the reading to obtain power at the EUT antenna terminals.

## 4.2. AC Power Line Conducted Emission Measurement

### ■ Limit

Frequency (MHz)	Quasi-peak	Average
0.15 - 0.5	66 to 56	56 to 46
0.50 - 5.0	56	46
5.0 - 30.0	60	50

### ■ Test Setup

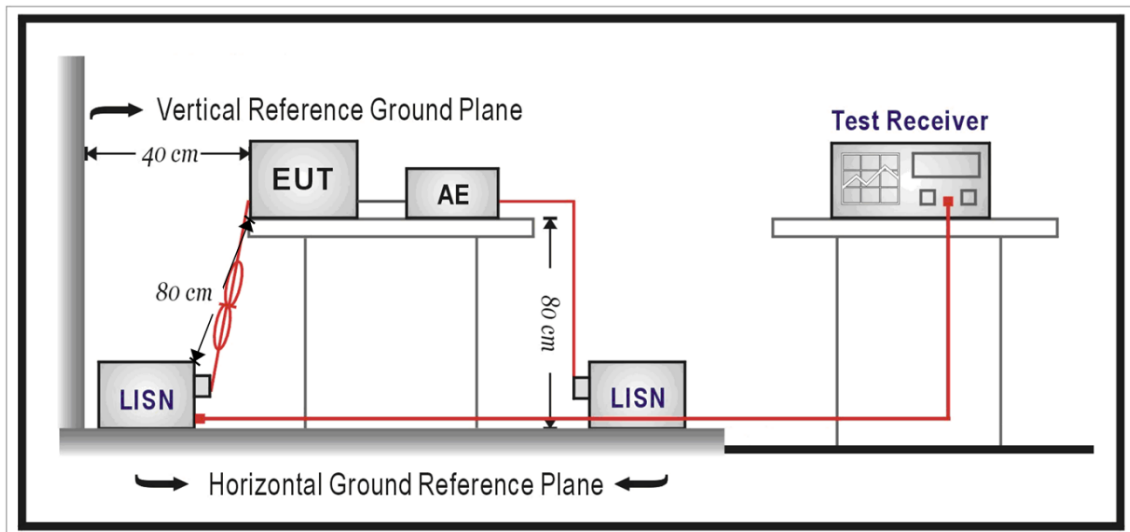

### ■ Test Procedure

The EUT and simulators are connected to the main power through a line impedance stabilization network (L.I.S.N.). This provides a  $50 \Omega // 50 \mu\text{H}$  coupling impedance for the measuring equipment. The peripheral devices are also connected to the main power through a LISN that provides a  $50 \Omega // 50 \mu\text{H}$  coupling impedance with 50 ohm termination.

Tabletop device shall be placed on a non-conducting platform, of nominal size 1 m by 1.5 m, raised 80 cm above the reference ground plane. The wall of screened room shall be located 40 cm to the rear of the EUT. Other surfaces of tabletop or floor standing EUT shall be at least 80 cm from any other ground conducting surface including one or more LISNs. For floor-standing device shall be placed under the EUT with a 12 mm insulating material.

Conducted emissions were investigated over the frequency range from 0.15 MHz to 30 MHz using a resolution bandwidth of 9 kHz. The equipment under test (EUT) shall be meet the limits in section 4.1, as applicable, including the average limit and the quasi-peak limit when using respectively, an average detector and quasi-peak detector measured in accordance with the methods described of related standard. When all of peak value were complied with quasi-peak and average limit from 150 kHz to 30 MHz then quasi-peak and average measurement was unnecessary.

The AMN shall be placed 0.8 m from the boundary of the unit under test and bonded to a ground reference plane for AMNs mounted on top of the ground reference plane. This distance is between the closest points of the AMN and the EUT. All other units of the EUT and associated equipment shall be at least 0.8 m from the AMN. If the mains power cable is longer than 1 m then the cable shall be folded back and forth at the centre of the lead to form a bundle no longer than 0.4 m. All of interconnecting cables that hang closer than 40 cm to the ground plane shall be folded back and forth in the center forming a bundle 30 cm to 40 cm long. All of EUT and AE shall be separate place more than 0.1 m. All  $50 \Omega$  ports of the LISN shall be resistively terminated into  $50 \Omega$  loads when not connected to the measuring instrument.

If the reading of the measuring receiver shows fluctuations close to the limit, the reading shall be observed for at least 15 s at each measurement frequency; the higher reading shall be recorded with the exception of any brief isolated high reading which shall be ignored.



### 4.3. Radiated Emission Measurement

■ **Limit**

According to §15.209(a), except as provided elsewhere in this subpart, the emissions from an intentional radiator shall not exceed the field strength levels specified in the following table:

Frequency (MHz)	Field Strength ( $\mu\text{V}/\text{m}$ at meter)	Measurement Distance (meters)
0.009 – 0.490	2400 / F (kHz)	300
0.490 – 1.705	24000 / F (kHz)	30
1.705 – 30.0	30	30
30 - 88	100**	3
88-216	150**	3
216-960	200**	3
Above 960	500	3

\*\* Except as provided in paragraph (g), fundamental emissions from intentional radiators operating under this Section shall not be located in the frequency bands 54-72 MHz, 76-88 MHz, 174-216 MHz or 470-806 MHz. However, operation within these frequency bands is permitted under other sections of this Part, e.g., Sections 15.231 and 15.241.

■ **Setup**

9 kHz ~ 30 MHz

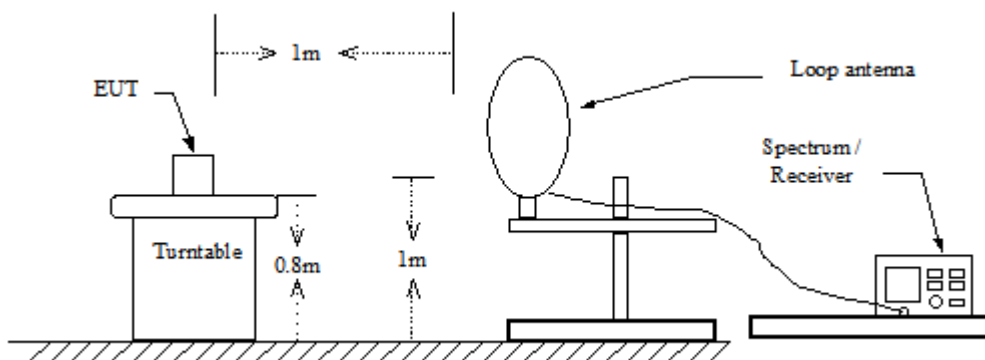

Below 1 GHz

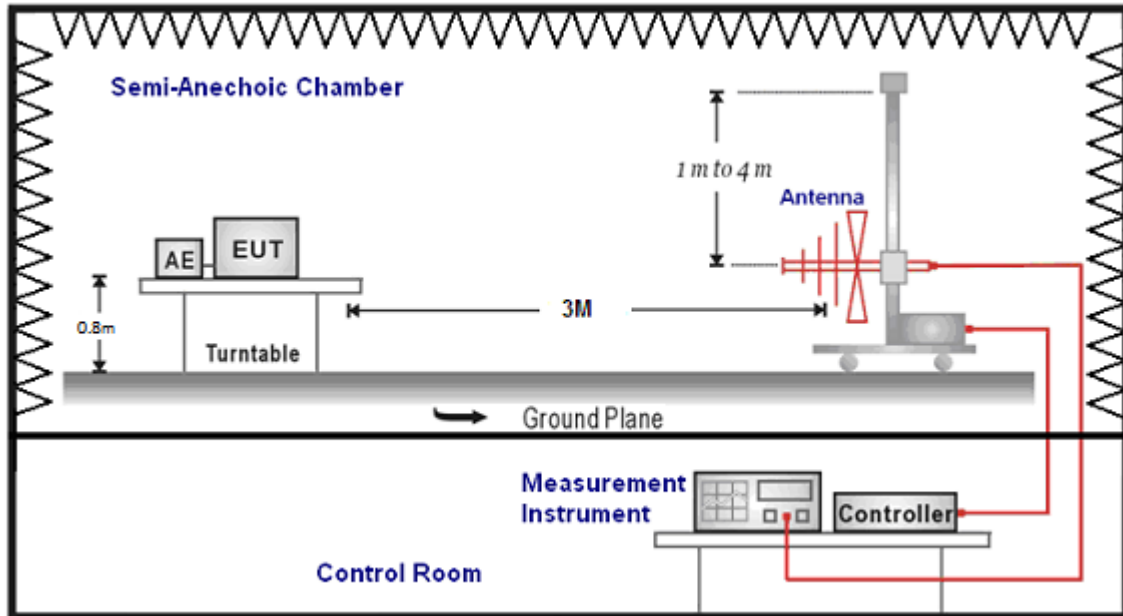

Above 1 GHz

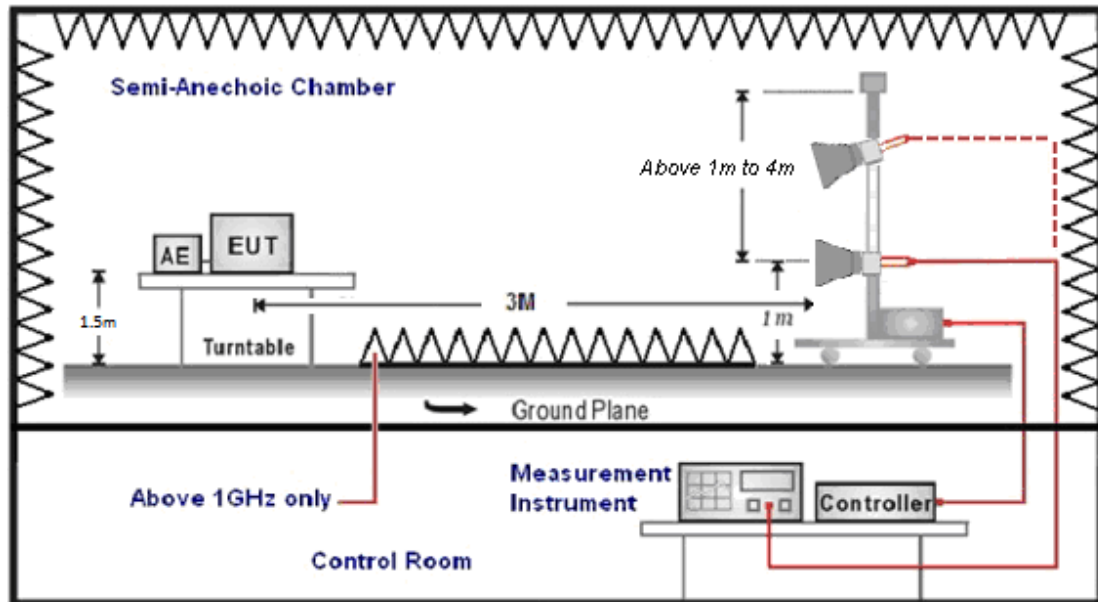

### ■ Test Procedure

Final radiation measurements were made on a three-meter, Semi Anechoic Chamber. The EUT system was placed on a nonconductive turntable which is 0.8 or 1.5 meters height, top surface 1.0 x 1.5 meter. The spectrum was examined from 250 MHz to 2.5 GHz in order to cover the whole spectrum below 10th harmonic which could generate from the EUT. During the test, EUT was set to transmit continuously & Measurements spectrum range from 9 kHz to 26.5 GHz is investigated.

For measurements below 30 MHz the resolution bandwidth is set to 10 kHz for peak detection measurements or 9 kHz for quasi-peak detection measurements. The video bandwidth is 3 times of the resolution bandwidth.

For measurements below 1 GHz the resolution bandwidth is set to 100 kHz for peak detection measurements or 120 kHz for quasi-peak detection measurements. Peak detection is used unless otherwise noted as quasi-peak.

For measurements above 1 GHz the resolution bandwidth is set to 1 MHz, and then the video bandwidth is set to 3 MHz for peak measurements and 10 Hz for average measurements when Duty cycle >98 % / 1/T for average measurements when Duty cycle <98 %. A nonconductive material surrounded the EUT to supporting the EUT for standing on three orthogonal planes. At each condition, the EUT was rotated 360 degrees, and the antenna was raised and lowered from one to four meters to find the maximum emission levels. Measurements were taken using both horizontal and vertical antenna polarization.

SCHWARZBECK MESS-ELEKTRONIK Biconilog Antenna at 3 Meter and the SCHWARZBECK Double Ridged Guide Antenna was used in frequencies 1 – 26.5 GHz at a distance of 1 meter. All test results were extrapolated to equivalent signal at 3 meters utilizing an inverse linear distance extrapolation Factor (20 dB/decade).

For testing above 1 GHz, the emission level of the EUT in peak mode was 20 dB lower than average limit (that means the emission level in peak mode also complies with the limit in average mode), then testing will be stopped and peak values of EUT will be reported, otherwise, the emissions will be measured in average mode again and reported.

Appropriate preamplifiers were used for improving sensitivity and precautions were taken to avoid overloading or desensitizing the spectrum analyzer. No post – detector video filters were used in the test.

The spectrum analyzer's 6 dB bandwidth was set to 1 MHz, and the analyzer was operated in the peak detection mode, for frequencies both below and up 1 GHz. The average levels were obtained by subtracting the duty cycle correction factor from the peak readings.

The following procedures were used to convert the emission levels measured in decibels referenced to 1 microvolt (dBuV) into field intensity in micro volts pre meter (uV/m).

The actual field intensity in decibels referenced to 1 microvolt in to field intensity in micro volts per meter (dBuV/m).

The actual field intensity in referenced to 1 microvolt per meter (dBuV/m) is determined by algebraically adding the measured reading in dBuV, the antenna factor (dB), and cable loss (dB) and Subtracting the gain of preamplifier (dB) is auto calculate in spectrum analyzer.

$$(1) \text{ Amplitude (dBuV/m) = FI (dBuV) +AF (dBuV) +CL (dBuV)-Gain (dB)}$$

FI= Reading of the field intensity.

AF= Antenna factor.

CL= Cable loss.

P.S Amplitude is auto calculate in spectrum analyzer.

$$(2) \text{ Actual Amplitude (dBuV/m) = Amplitude (dBuV)-Dis(dB)}$$

The FCC specified emission limits were calculated according the EUT operating frequency and by following linear interpolation equations:

(a) For fundamental frequency : Transmitter Output < +30 dBm

(b) For spurious frequency : Spurious emission limits = fundamental emission limit /10

Data of measurement within this frequency range without mark in the table above means the reading of emissions are attenuated more than 20 dB below the permissible limits or the field strength is too small to be measured.

#### 4.4. 20 dB RF Bandwidth Measurement

■ **Limit**

N/A

■ **Test Setup**

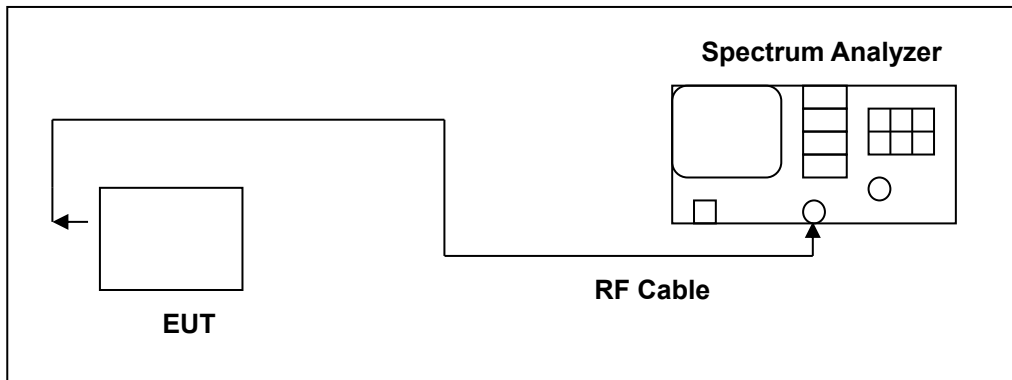

■ **Test Procedure**

Testing must be done according to this procedure, FCC Public Notice DA 00-705 - Filing and Measurement Guidelines for Frequency Hopping Spread Spectrum Systems. This is the only method recognized by the FCC. The RF output port of the Equipment-Under-Test is directly coupled to the input of the EMC analyzer through a specialized RF connector and a 10 dB passive attenuator. A fully charged battery was used for the supply voltage. The Bluetooth frequency hopping function of the EUT was enabled. The spectrum analyzer used the following settings:

1. Span = approx. 2 to 3 times the 20 dB bandwidth, centered on a hopping frequency
2. RBW  $\geq$  1 % of the 20 dB span
3. VBW  $\geq$  RBW
4. Sweep = auto
5. Detector function = peak
6. Trace = max hold

The trace was allowed to stabilize. The EUT was transmitting at its maximum data rate. The marker-to-peak function was used to set the marker to the peak of the emission. The marker-delta function was used to measure 20 dB down one side of the emission. The marker-delta function and marker was moved to the other side of the emission until it was even with the reference marker. The marker-delta reading at this point was the 20 dB bandwidth of the emission.

## 4.5. Carrier Frequency Separation Measurement

### ■ Limit

Title 47 of the CFR, Part 15 Subpart (c) 15.247(a)(1) requires the measurement of the bandwidth of the transmission between the -20 dB points on the transmitted spectrum. The results of this test determine the limits for channel spacing. The channel spacing shall be a minimum of 25 kHz or the 20 dB bandwidth, whichever is greater. Alternatively, frequency hopping systems operating in the 2400-2483.5 MHz band may have hopping channel carrier frequencies that are separated by 25 kHz or two-thirds of the 20 dB bandwidth of the hopping channel.

### ■ Test Setup

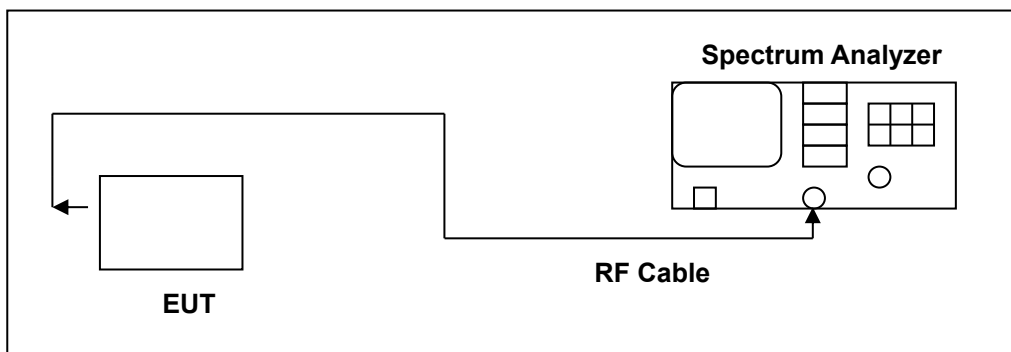

### ■ Test Procedure

Testing must be done according to this procedure, FCC Public Notice DA 00-705 - Filing and Measurement Guidelines for Frequency Hopping Spread Spectrum Systems. This is the only method recognized by the FCC. The RF output port of the Equipment-Under-Test is directly coupled to the input of the EMC analyzer through a specialized RF connector and a 10 dB passive attenuator. A fully charged battery was used for the supply voltage. The Bluetooth frequency hopping function of the EUT was enabled. The following spectrum analyzer settings were used:

1. Span = wide enough to capture the peaks of two adjacent channels
2. Resolution (or IF) Bandwidth (RBW) = Start with the RBW set to approximately 30% of the channel spacing;  
adjust as necessary to best identify the center of each individual channel.
3. Video (or Average) Bandwidth (VBW)  $\geq$  RBW
4. Sweep = auto
5. Detector function = peak
6. Trace = max hold

The trace was allowed to stabilize. The marker-delta function was used to determine the separation between the peaks of the adjacent channels.

## 4.6. Number of Hopping Measurement

### ■ Limit

Frequency hopping systems in the 2400–2483.5 MHz band shall use at least 15 channels.

### ■ Test Setup

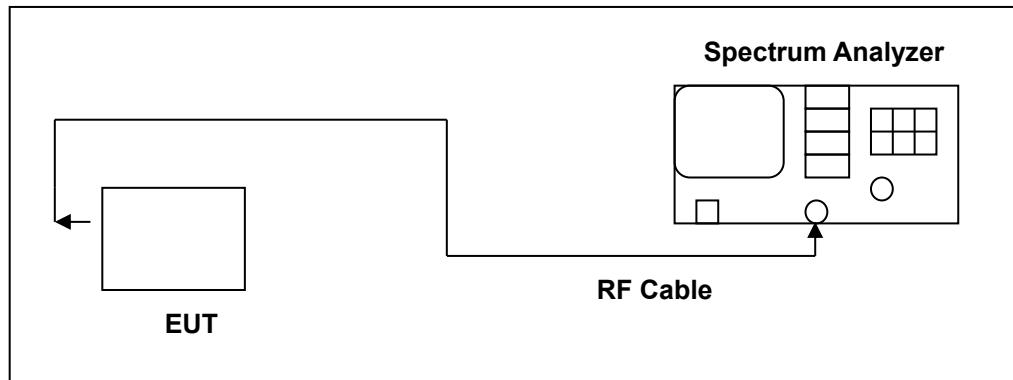

### ■ Test Procedure

Testing must be done according to this procedure, FCC Public Notice DA 00-705 - Filing and Measurement Guidelines for Frequency Hopping Spread Spectrum Systems. This is the only method recognized by the FCC. The RF output port of the Equipment-Under-Test is directly coupled to the input of the EMC analyzer through a specialized RF connector and a 10 dB passive attenuator. A fully charged battery was used for the supply voltage. The Bluetooth frequency hopping function of the EUT was enabled. The spectrum analyzer used the following settings:

1. Span = the frequency band of operation
2. RBW = To identify clearly the individual channels, set the RBW to less than 30% of the channel spacing or the 20 dBbandwidth, whichever is smaller.
3. VBW  $\geq$  RBW
4. Sweep = auto
5. Detector function = peak
6. Trace = max hold

The trace was allowed to stabilize.

## 4.7. Time of Occupancy (Dwell Time) Measurement

### ■ Limit

The average time of occupancy on any channel shall not be greater than 0.4 seconds within a period of 0.4 seconds multiplied by the number of hopping channels employed.

### ■ Test Setup

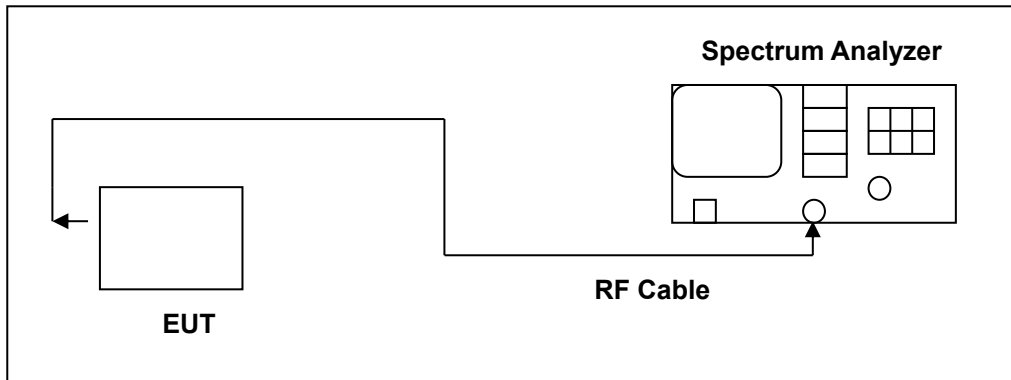

### ■ Test Procedure

Testing must be done according to this procedure, FCC Public Notice DA 00-705 - Filing and Measurement Guidelines for Frequency Hopping Spread Spectrum Systems. This is the only method recognized by the FCC. The RF output port of the Equipment-Under-Test is directly coupled to the input of the spectrum through a specialized RF connector and a 10 dB passive attenuator. A fully charged battery was used for the supply voltage. The Bluetooth hopping function of the EUT was enabled. The following spectrum analyzer settings were used:

1. Span = zero span, centered on a hopping channel
2. RBW = 1 MHz
3. VBW  $\geq$  RBW
4. Sweep = as necessary to capture the entire dwell time per hopping channel
5. Detector function = peak
6. Trace = max hold

The marker-delta function was used to determine the dwell time.



## 4.8. Out of Band Conducted Emissions Measurement

### ■ Limit

In any 100 kHz bandwidth outside the frequency band in which the spread spectrum or digitally modulated intentional radiator is operating, the radio frequency power that is produced by the intentional radiator shall be at least 20 dB below that in the 100 kHz bandwidth within the band that contains the highest level of the desired power

### ■ Test Setup

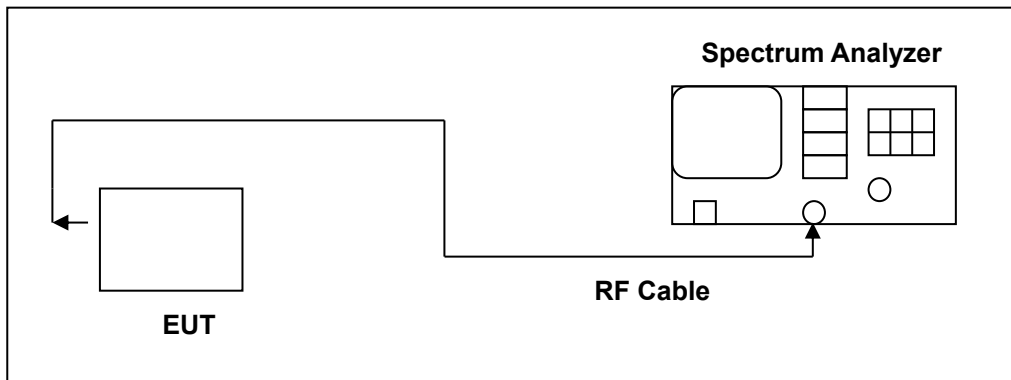

### ■ Test Procedure

Testing must be done according to this procedure, FCC Public Notice DA 00-705 - Filing and Measurement Guidelines for Frequency Hopping Spread Spectrum Systems. This is the only method recognized by the FCC. In any 100 kHz bandwidth outside the EUT pass band, the RF power produced by the modulation products of the spreading sequence, the information sequence, and the carrier frequency shall be at least 20 dB below that of the maximum in-band 100 kHz emission, antenna output of the EUT was coupled directly to spectrum analyzer; if an external attenuator and/or cable was used, these losses are compensated for with the analyzer OFFSET function. All other types of emissions from the EUT shall meet the general limits for radiated frequencies outside the pass band. The test was performed at 3 channels (Channel 0, 39, 78)

## 4.9. Antenna Measurement

### ■ Limit

For intentional device, according to 15.203, an intentional radiator shall be designed to ensure that no antenna other than that furnished by the responsible party shall be used with the device.

And According to 15.247 (b)(4), if transmitting antennas of directional gain greater than 6 dBi are used, the power shall be reduced by the amount in dB that the directional gain of the antenna exceeds 6 dBi.

### ■ Antenna Connector Construction

See section 2 – antenna information.

#### 4.10. Other requirements

■ **System Receiver Input Bandwidth**

Each channel bandwidth is 1MHz.

The system receivers have input bandwidths that match the hopping channel bandwidths of their corresponding transmitters and shift frequencies in synchronization with the transmitted signals.

■ **Equipment Description**

The system shall hop to channel frequencies that are selected at the system hopping rate from a pseudo randomly ordered list of hopping frequencies. The system receivers shall have input bandwidths that match the hopping channel bandwidths of their corresponding transmitters and shall shift frequencies in synchronization with the transmitted signals.

## 5 Test Results

### 5.1. Conducted Emission

Standard:	FCC Part 15.247	Line:	L1
Test item:	Conducted Emission	Power:	AC 120 V/60 Hz
Mode:	Transmit Mode		
Description:			

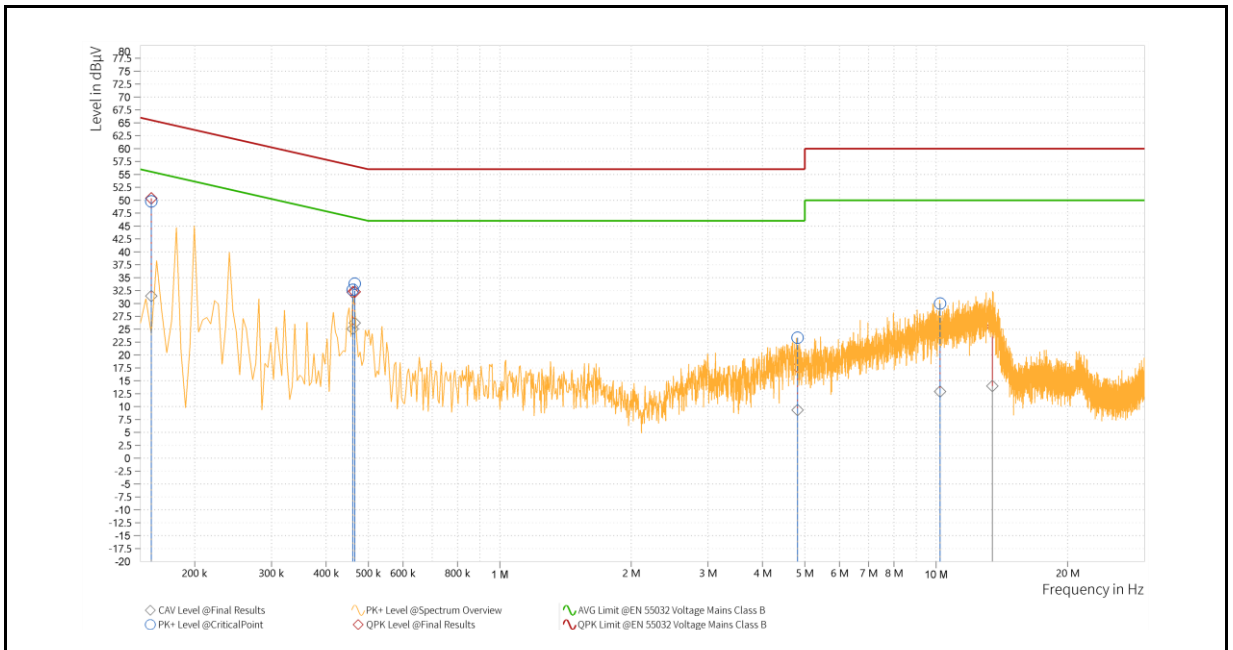

Rg	Frequency [MHz]	QP Result [dBµV]	QP Limit [dBµV]	QP Margin [dB]	AV Result [dBµV]	AV Limit [dBµV]	AV Margin [dB]	Correction factor [dB]	Line
1	0.159	50.38	65.52	15.13	31.43	55.52	24.09	9.64	L1
1	0.461	32.16	56.68	24.52	25.05	46.68	21.63	9.65	L1
1	0.465	32.24	56.60	24.37	26.21	46.60	20.39	9.65	L1
1	4.812	17.66	56.00	38.34	9.34	46.00	36.66	9.80	L1
1	10.208	24.10	60.00	35.90	12.93	50.00	37.07	9.92	L1
1	13.448	25.53	60.00	34.47	13.98	50.00	36.02	9.99	L1

Note: 1. Result (dBuV) = Correction factor (dB) + Reading(dBuV).  
2. Correction factor (dB) = Cable loss (dB) + L.I.S.N. factor (dB).

Standard:	FCC Part 15.247	Line:	N
Test item:	Conducted Emission	Power:	AC 120 V/60 Hz
Mode:	Transmit Mode		
Description:			

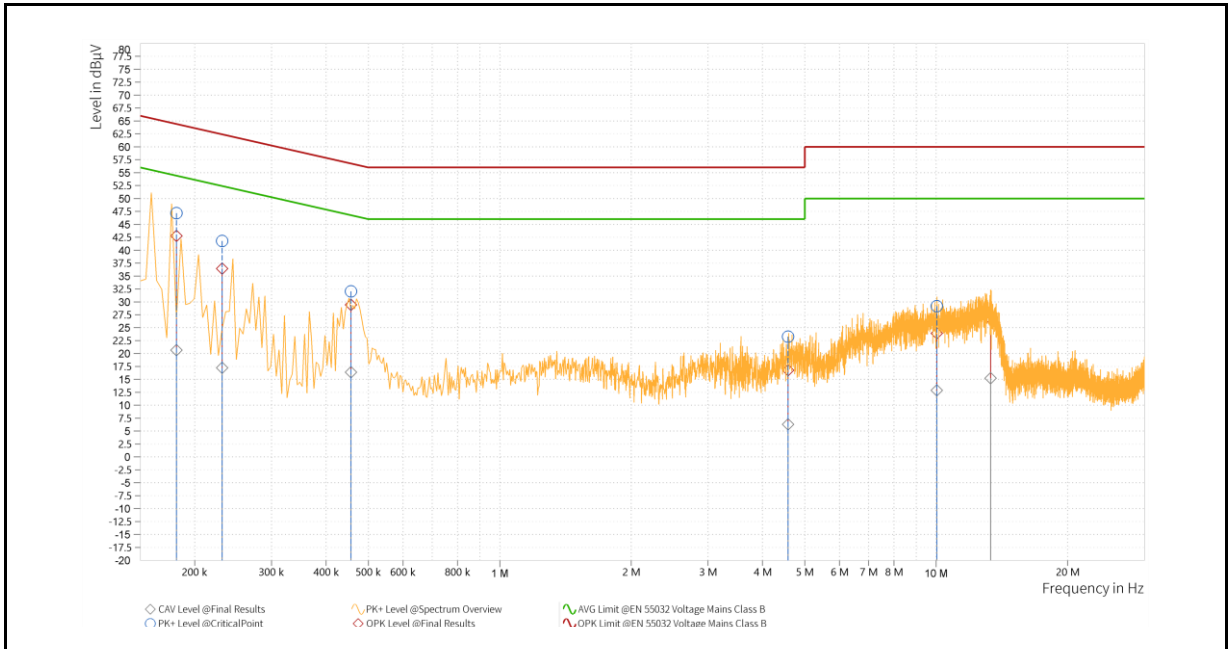

Rg	Frequency [MHz]	QP Result [dBµV]	QP Limit [dBµV]	QP Margin [dB]	AV Result [dBµV]	AV Limit [dBµV]	AV Margin [dB]	Correction factor [dB]	Line
1	0.182	42.77	64.42	21.65	20.65	54.42	33.77	9.64	N
1	0.231	36.42	62.41	26.00	17.22	52.41	35.19	9.64	N
1	0.456	29.41	56.77	27.36	16.39	46.77	30.37	9.65	N
1	4.578	16.79	56.00	39.21	6.29	46.00	39.71	9.81	N
1	10.037	23.91	60.00	36.09	12.86	50.00	37.14	9.94	N
1	13.326	26.70	60.00	33.30	15.24	50.00	34.76	10.06	N

Note: 1. Result (dBuV) = Correction factor (dB) + Reading(dBuV).  
2. Correction factor (dB) = Cable loss (dB) + L.I.S.N. factor (dB).

## 5.2. Conducted Test Results

### **Maximum Conducted Output Power Measurement**

Reference Appendix A

### **20 dB RF Bandwidth Measurement**

Reference Appendix A / Appendix B

### **Carrier Frequency Separation Measurement**

Reference Appendix A / Appendix B

### **Number of Hopping Measurement**

Reference Appendix A / Appendix B

### **Out of Band Conducted Emissions Measurement**

Reference Appendix B

### **Time of Occupancy (Dwell Time) Measurement**

Reference Appendix A / Appendix B

### 5.3. Radiated Emission Measurement

Below 1 GHz

Test Site:	96603-WG	Standard:	Part 15.247
Test Mode:	Transmit mode		
Polarization:	Horizontal		
ReMark:	BT		

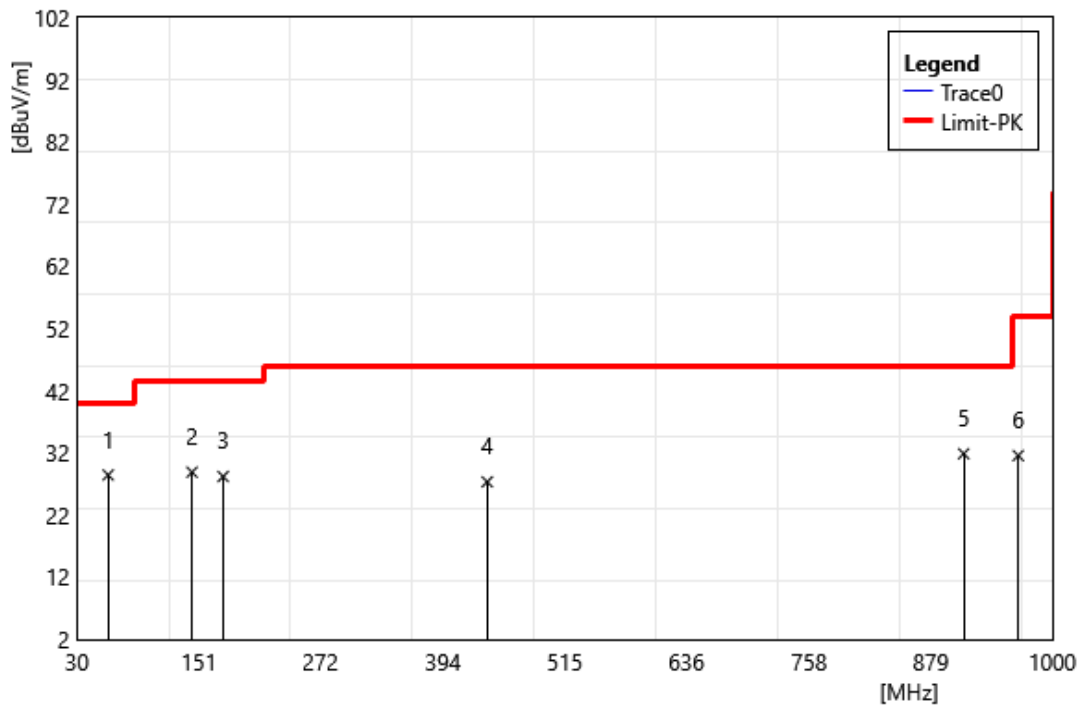

ID	Frequency MHz	Reading dBuV	Correct Factor dB/m	Result dBuV/m	Limit dBuV/m	Margin dB	ReMark
1	61.01	41.39	-12.94	28.45	40.00	-11.55	PEAK
2	144.35	40.83	-11.93	28.90	43.50	-14.60	PEAK
3	175.35	40.83	-12.64	28.19	43.50	-15.31	PEAK
4	437.96	35.22	-7.88	27.34	46.00	-18.66	PEAK
5	911.82	32.48	-0.61	31.87	46.00	-14.13	PEAK
6	966.08	31.81	-0.24	31.57	54.00	-22.43	PEAK

Test Site:	96603-WG	Standard:	Part 15.247
Test Mode:	Transmit mode		
Polarization:	Vertical		
ReMark:	BT		

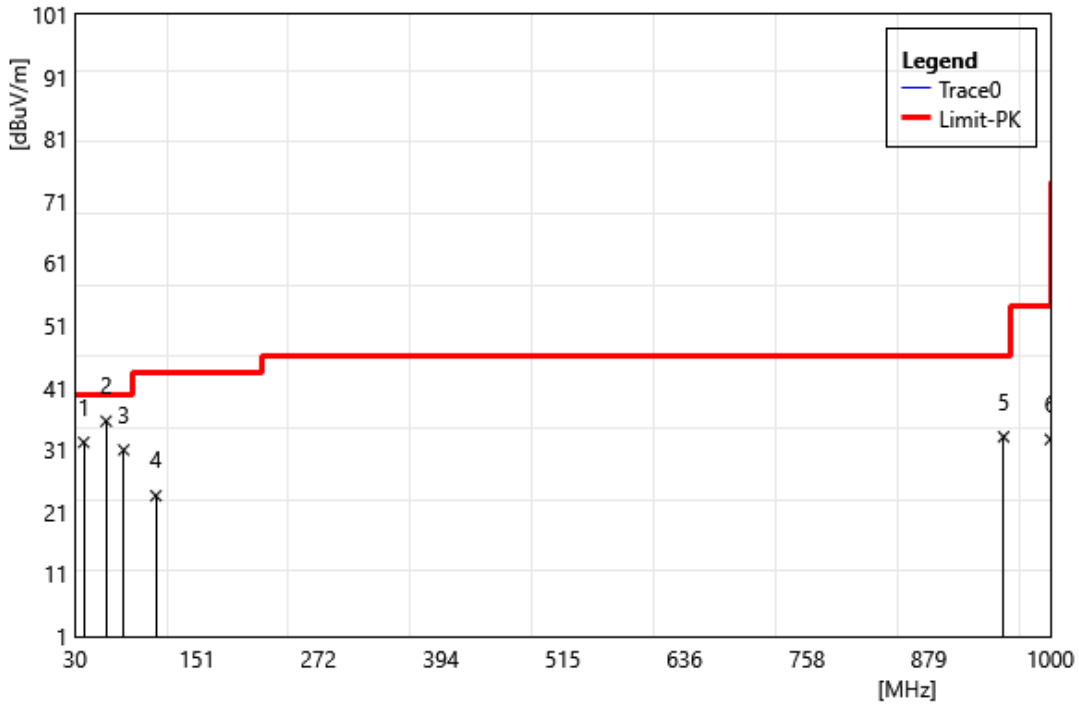

ID	Frequency MHz	Reading dBuV	Correct Factor dB/m	Result dBuV/m	Limit dBuV/m	Margin dB	ReMark
1	38.72	44.58	-12.37	32.21	40.00	-7.79	PEAK
2	61.01	48.57	-12.94	35.63	40.00	-4.37	PEAK
3	78.45	47.43	-16.44	30.99	40.00	-9.01	PEAK
4	110.43	38.72	-15.09	23.63	43.50	-19.87	PEAK
5	953.49	33.01	0.09	33.10	46.00	-12.90	PEAK
6	1000.00	32.84	-0.16	32.68	74.00	-41.32	PEAK

Harmonic

Above 1 GHz

Test Site:	96603-WG	Standard:	Part 15.247
Test Mode:	BT GFSK 2402 MHz		
Polarization:	Horizontal		
ReMark:			

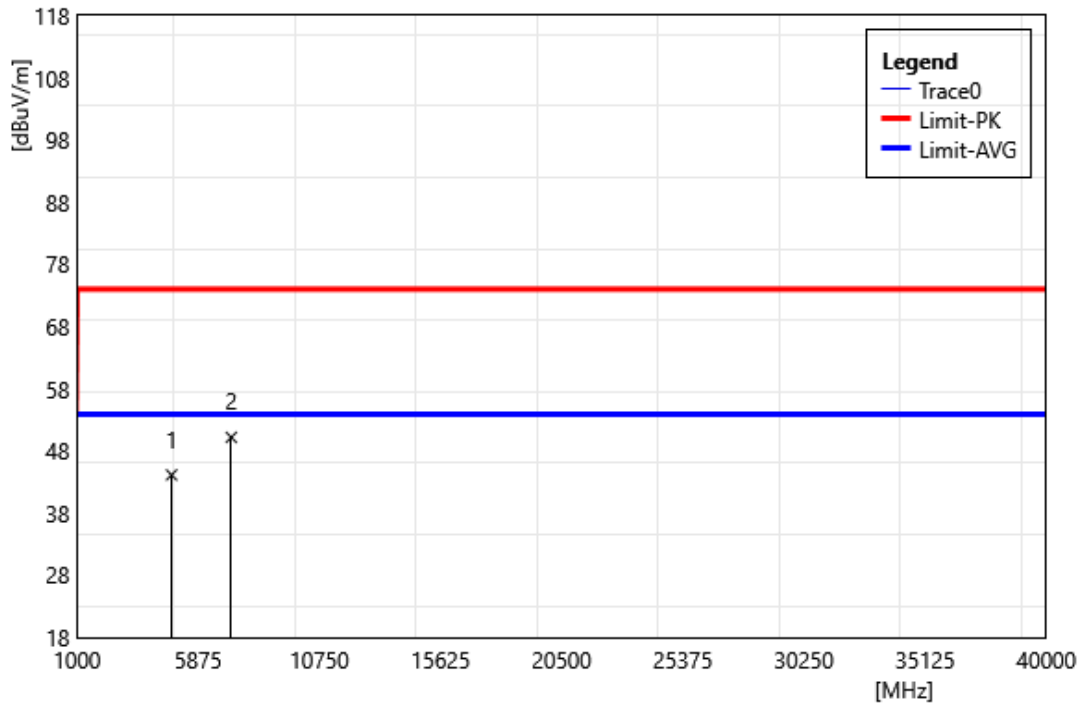

ID	Frequency MHz	Reading dBuV	Correct Factor dB/m	Result dBuV/m	Limit dBuV/m	Margin dB	ReMark
1	4804.00	42.90	1.23	44.13	74.00	-29.87	PEAK
2	7206.00	43.69	6.48	50.17	74.00	-23.83	PEAK



Test Site:	96603-WG	Standard:	Part 15.247
Test Mode:	BT GFSK 2402 MHz		
Polarization:	Vertical		
ReMark:			

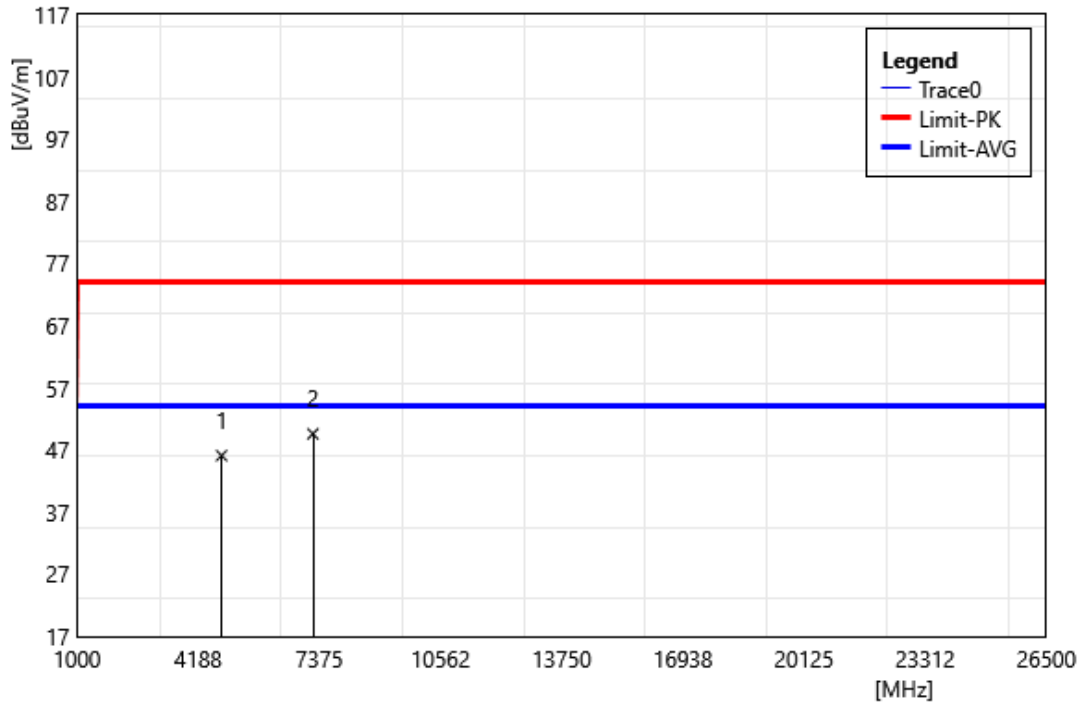

ID	Frequency MHz	Reading dBuV	Correct Factor dB/m	Result dBuV/m	Limit dBuV/m	Margin dB	ReMark
1	4804.00	44.85	1.23	46.08	74.00	-27.92	PEAK
2	7206.00	43.09	6.48	49.57	74.00	-24.43	PEAK

Test Site:	96603-WG	Standard:	Part 15.247
Test Mode:	BT GFSK 2441 MHz		
Polarization:	Horizontal		
ReMark:			

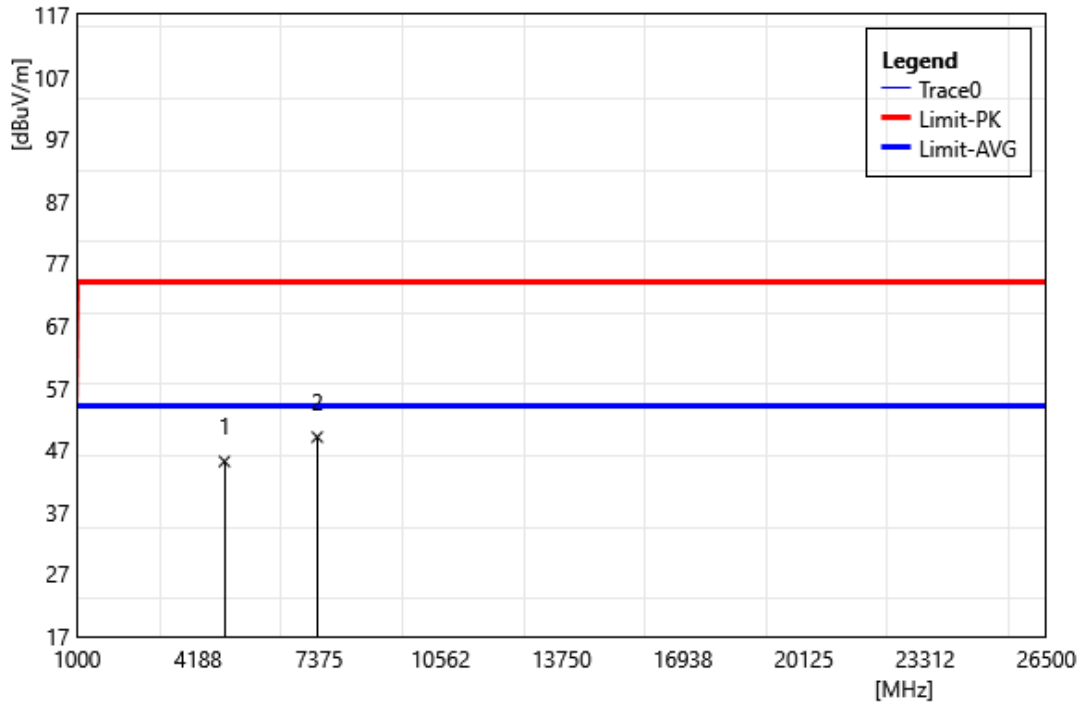

ID	Frequency MHz	Reading dBuV	Correct Factor dB/m	Result dBuV/m	Limit dBuV/m	Margin dB	ReMark
1	4882.00	43.64	1.49	45.13	74.00	-28.87	PEAK
2	7323.00	42.80	6.26	49.06	74.00	-24.94	PEAK

Test Site:	96603-WG	Standard:	Part 15.247
Test Mode:	BT GFSK 2441 MHz		
Polarization:	Vertical		
ReMark:			

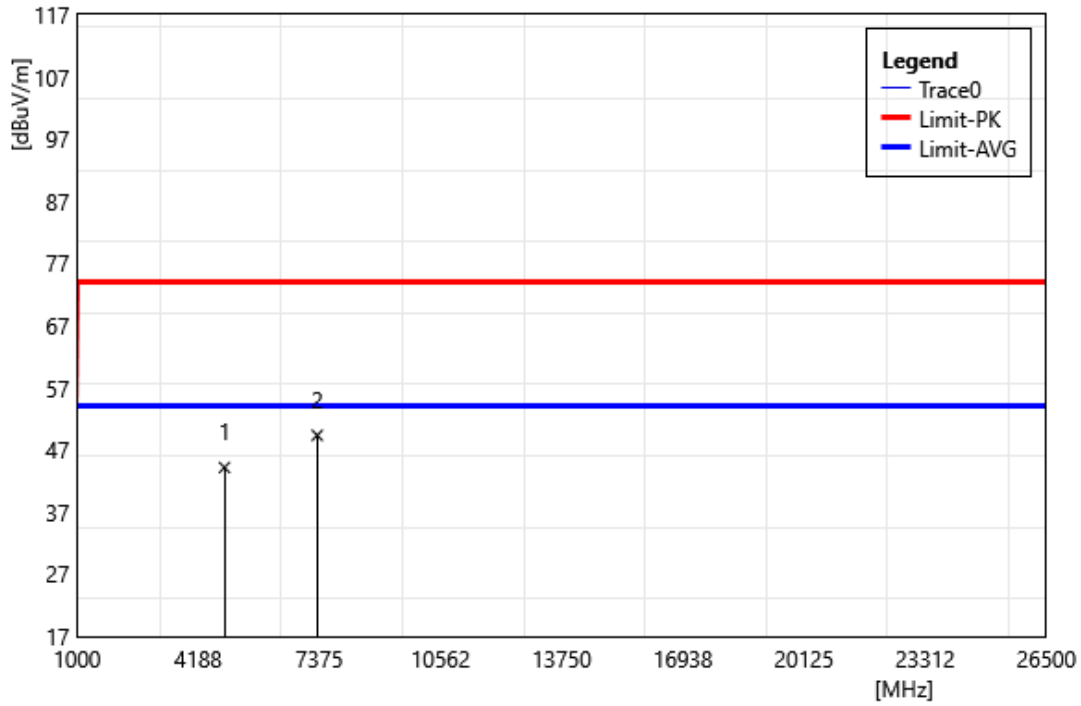

ID	Frequency MHz	Reading dBuV	Correct Factor dB/m	Result dBuV/m	Limit dBuV/m	Margin dB	ReMark
1	4882.00	42.68	1.49	44.17	74.00	-29.83	PEAK
2	7323.00	43.08	6.26	49.34	74.00	-24.66	PEAK

Test Site:	96603-WG	Standard:	Part 15.247
Test Mode:	BT GFSK 2480 MHz		
Polarization:	Horizontal		
ReMark:			

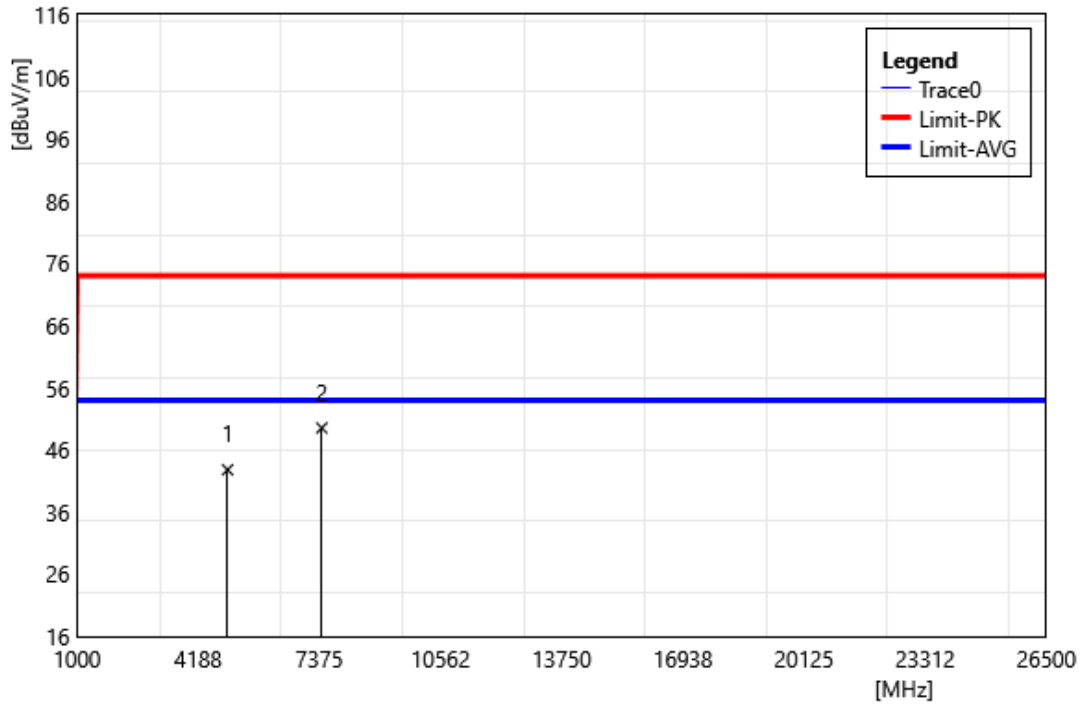

ID	Frequency MHz	Reading dBuV	Correct Factor dB/m	Result dBuV/m	Limit dBuV/m	Margin dB	ReMark
1	4960.00	41.45	1.35	42.80	74.00	-31.20	PEAK
2	7440.00	42.84	6.68	49.52	74.00	-24.48	PEAK

Test Site:	96603-WG	Standard:	Part 15.247
Test Mode:	BT GFSK 2480 MHz		
Polarization:	Vertical		
ReMark:			

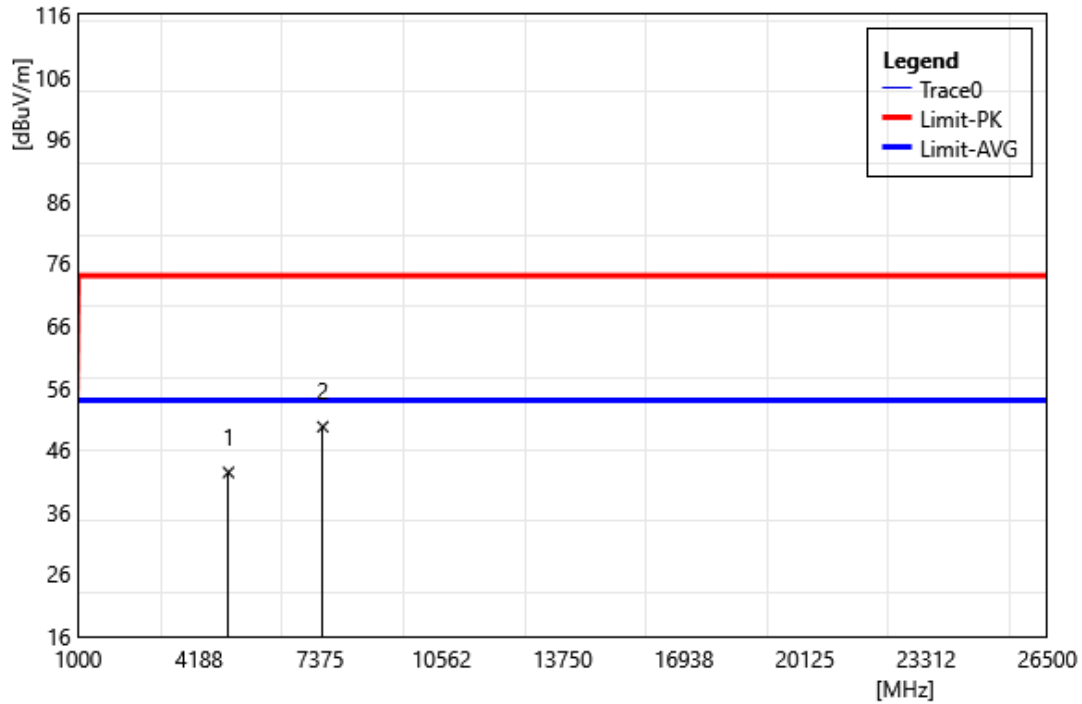

ID	Frequency MHz	Reading dBuV	Correct Factor dB/m	Result dBuV/m	Limit dBuV/m	Margin dB	ReMark
1	4960.00	41.02	1.35	42.38	74.00	-31.63	PEAK
2	7440.00	43.03	6.68	49.71	74.00	-24.29	PEAK

Test Site:	96603-WG	Standard:	Part 15.247
Test Mode:	BT 8DPSK 2402 MHz		
Polarization:	Horizontal		
ReMark:			

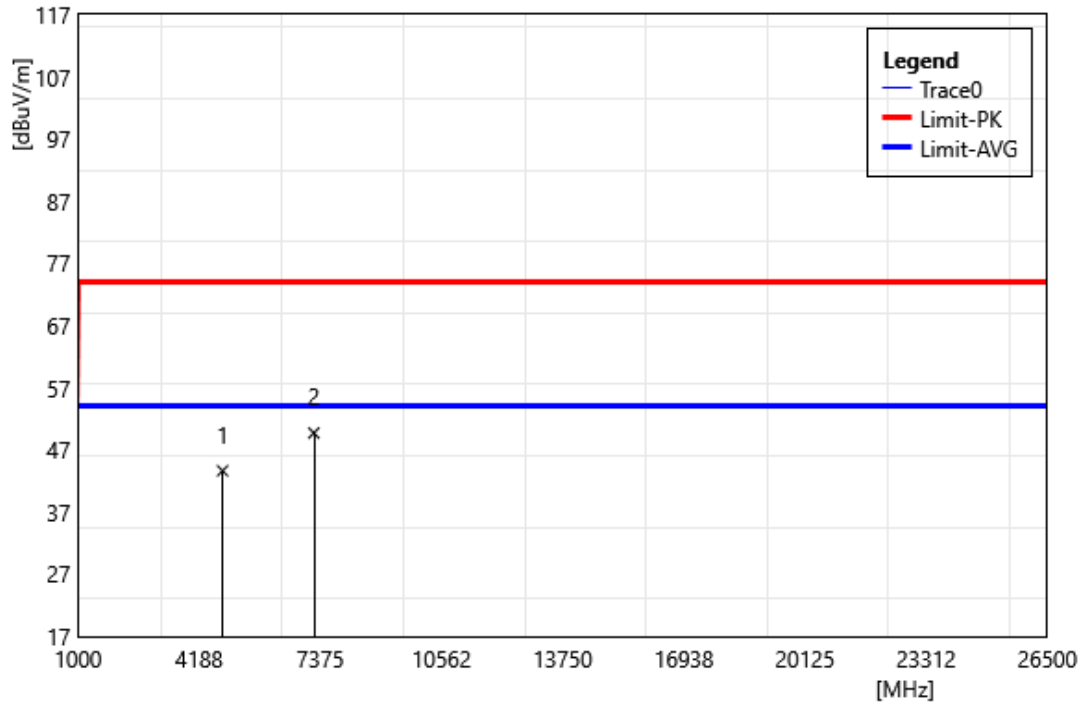

ID	Frequency MHz	Reading dBuV	Correct Factor dB/m	Result dBuV/m	Limit dBuV/m	Margin dB	ReMark
1	4804.00	42.42	1.23	43.65	74.00	-30.35	PEAK
2	7206.00	43.23	6.48	49.71	74.00	-24.29	PEAK

Test Site:	96603-WG	Standard:	Part 15.247
Test Mode:	BT 8DPSK 2402 MHz		
Polarization:	Vertical		
ReMark:			

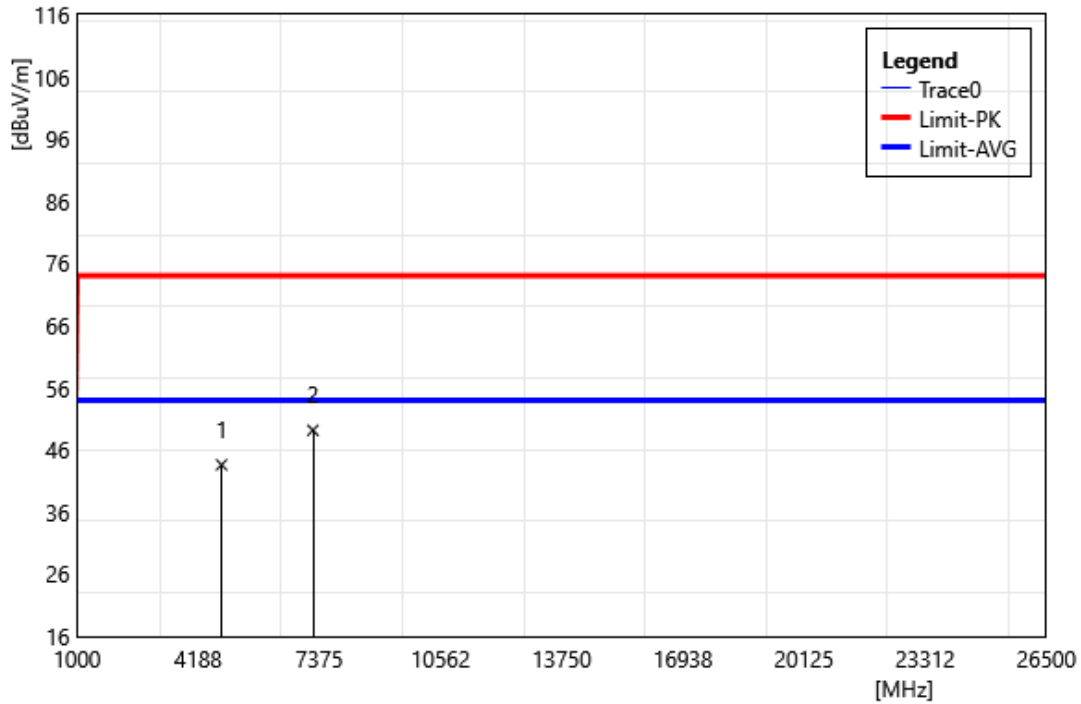

ID	Frequency MHz	Reading dBuV	Correct Factor dB/m	Result dBuV/m	Limit dBuV/m	Margin dB	ReMark
1	4804.00	42.36	1.23	43.59	74.00	-30.41	PEAK
2	7206.00	42.67	6.48	49.15	74.00	-24.85	PEAK

Test Site:	96603-WG	Standard:	Part 15.247
Test Mode:	BT 8DPSK 2441 MHz		
Polarization:	Horizontal		
ReMark:			

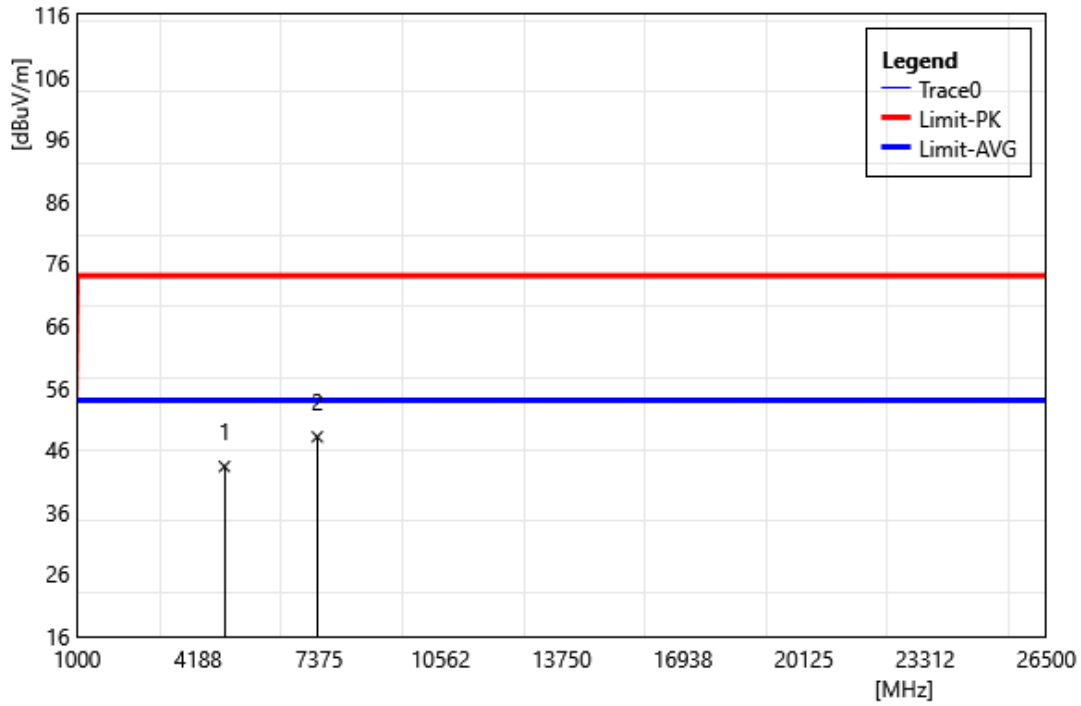

ID	Frequency MHz	Reading dBuV	Correct Factor dB/m	Result dBuV/m	Limit dBuV/m	Margin dB	ReMark
1	4882.00	41.85	1.49	43.34	74.00	-30.66	PEAK
2	7323.00	41.84	6.26	48.10	74.00	-25.90	PEAK



Test Site:	96603-WG	Standard:	Part 15.247
Test Mode:	BT 8DPSK 2441 MHz		
Polarization:	Vertical		
ReMark:			

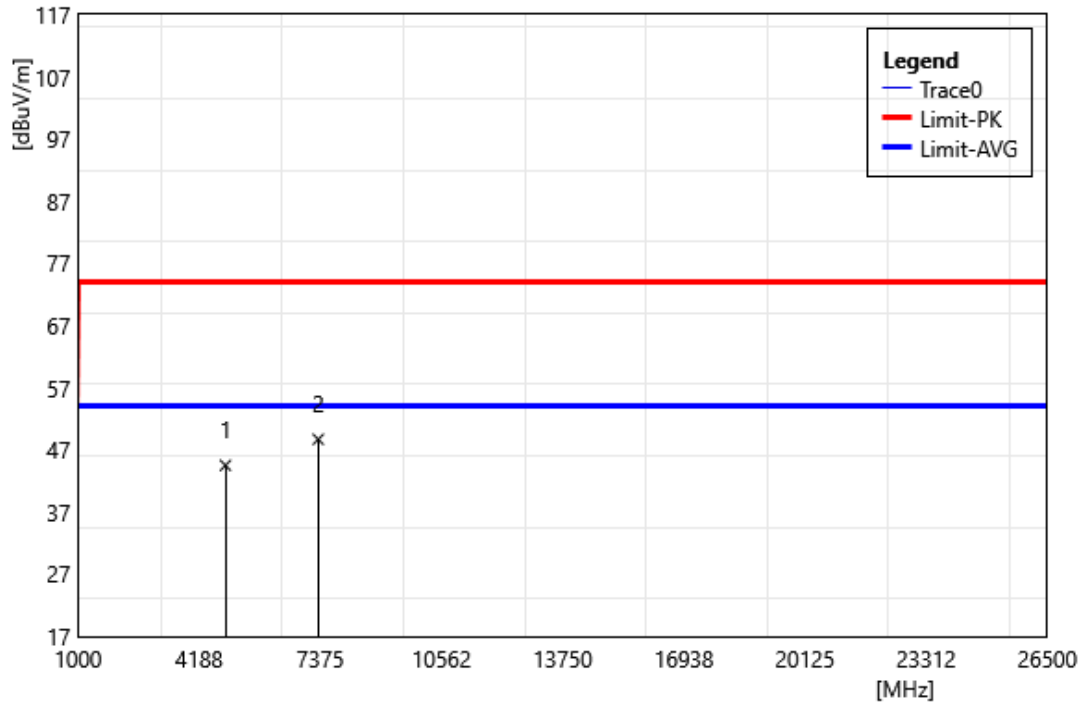

ID	Frequency MHz	Reading dBuV	Correct Factor dB/m	Result dBuV/m	Limit dBuV/m	Margin dB	ReMark
1	4882.00	43.03	1.49	44.52	74.00	-29.48	PEAK
2	7323.00	42.45	6.26	48.71	74.00	-25.29	PEAK

Test Site:	96603-WG	Standard:	Part 15.247
Test Mode:	BT 8DPSK 2480 MHz		
Polarization:	Horizontal		
ReMark:			

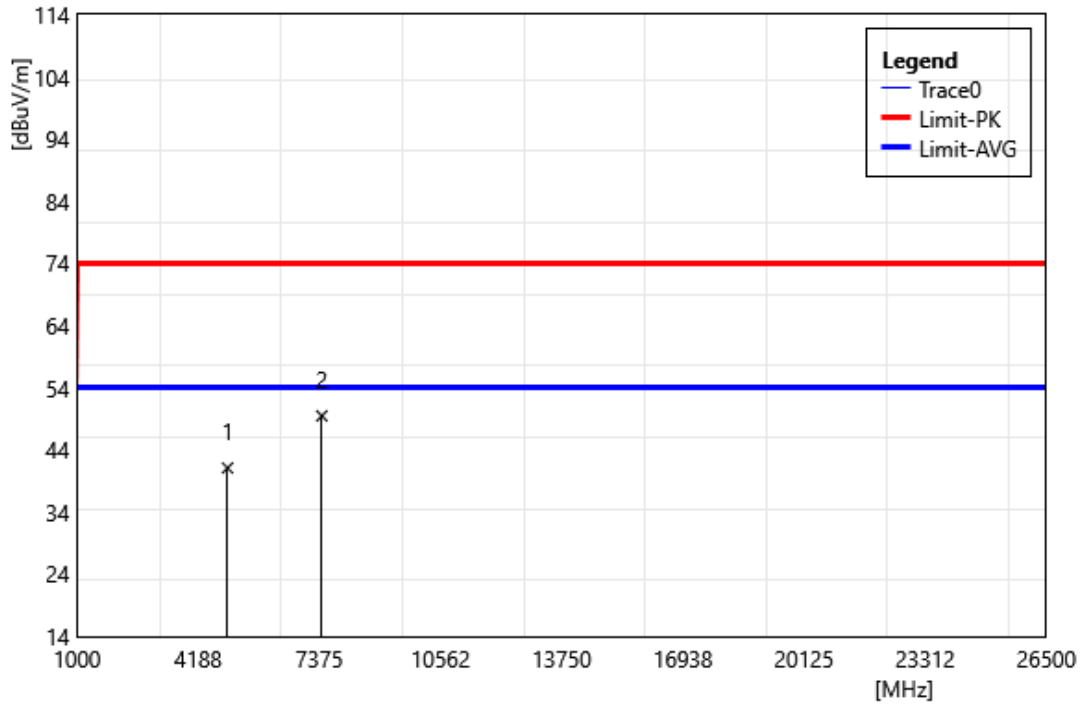

ID	Frequency MHz	Reading dBuV	Correct Factor dB/m	Result dBuV/m	Limit dBuV/m	Margin dB	ReMark
1	4960.00	39.74	1.35	41.09	74.00	-32.91	PEAK
2	7440.00	42.79	6.68	49.47	74.00	-24.53	PEAK

Test Site:	96603-WG	Standard:	Part 15.247
Test Mode:	BT 8DPSK 2480 MHz		
Polarization:	Vertical		
ReMark:			

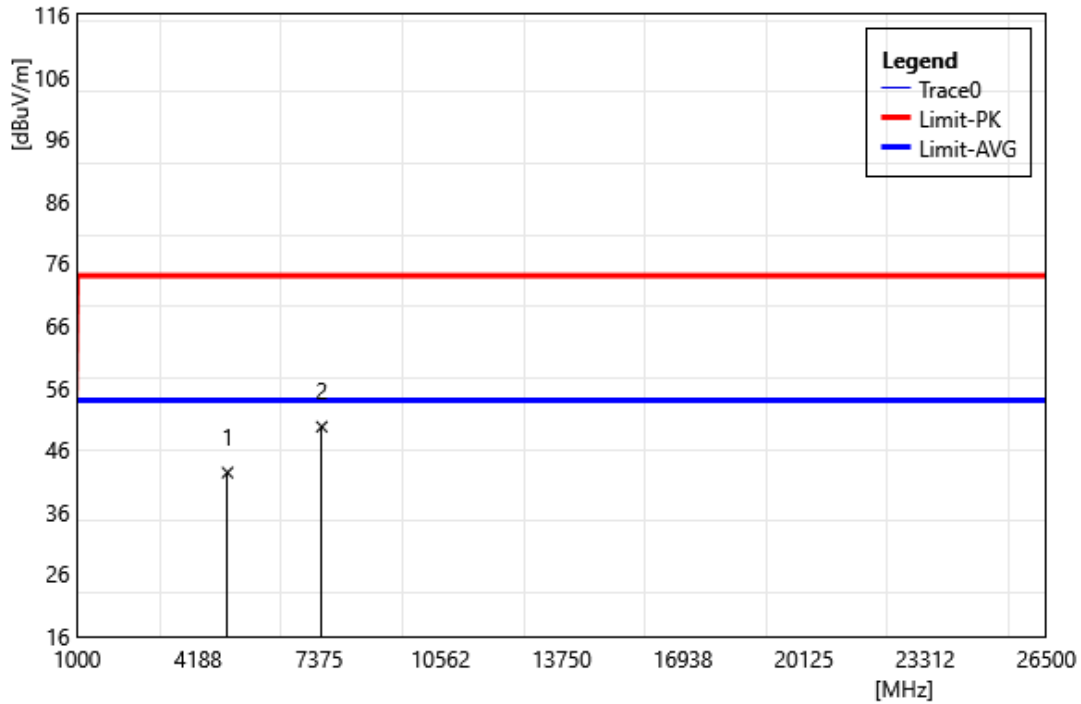

ID	Frequency MHz	Reading dBuV	Correct Factor dB/m	Result dBuV/m	Limit dBuV/m	Margin dB	ReMark
1	4960.00	41.00	1.35	42.35	74.00	-31.65	PEAK
2	7440.00	43.02	6.68	49.70	74.00	-24.30	PEAK

Band Edge

Test Site:	96603-WG	Standard:	Part 15.247
Test Mode:	BT GFSK 2402 MHz		
Polarization:	Horizontal		
ReMark:			

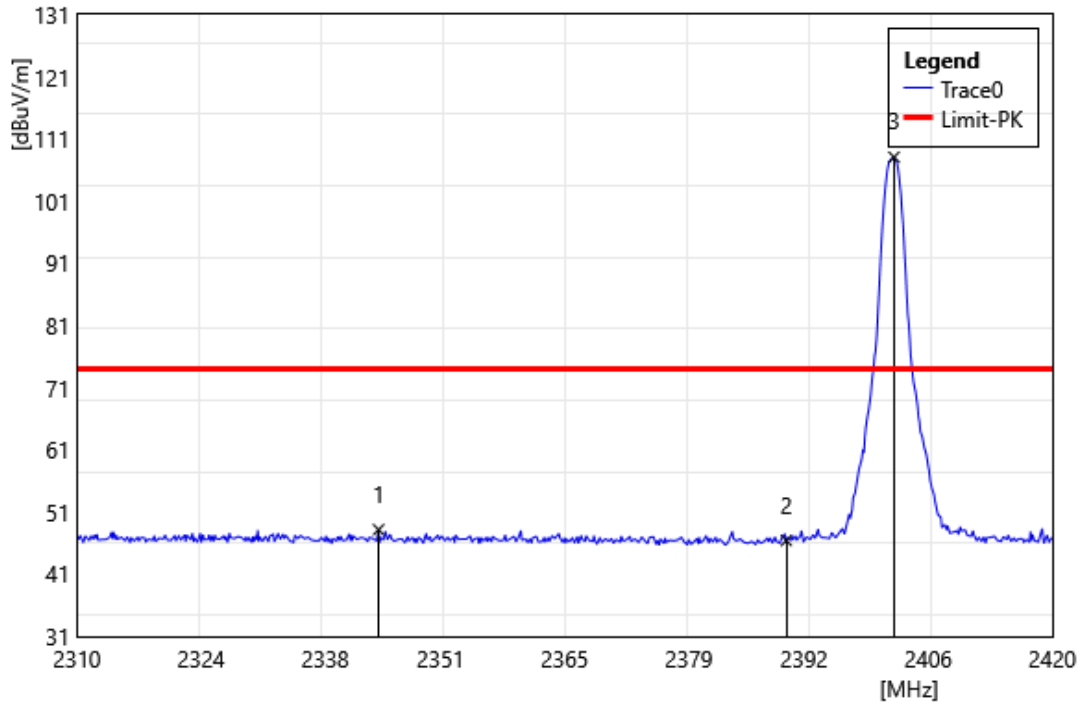

ID	Frequency MHz	Reading dBuV	Correct Factor dB/m	Result dBuV/m	Limit dBuV/m	Margin dB	ReMark
1	2344.01	52.87	-4.69	48.18	74.00	-25.82	PEAK
2	2390.00	51.43	-5.00	46.43	74.00	-27.57	PEAK
3	2402.15	113.16	-5.09	108.07	74.00	34.07	PEAK

Test Site:	96603-WG	Standard:	Part 15.247
Test Mode:	BT GFSK 2402 MHz		
Polarization:	Vertical		
ReMark:			

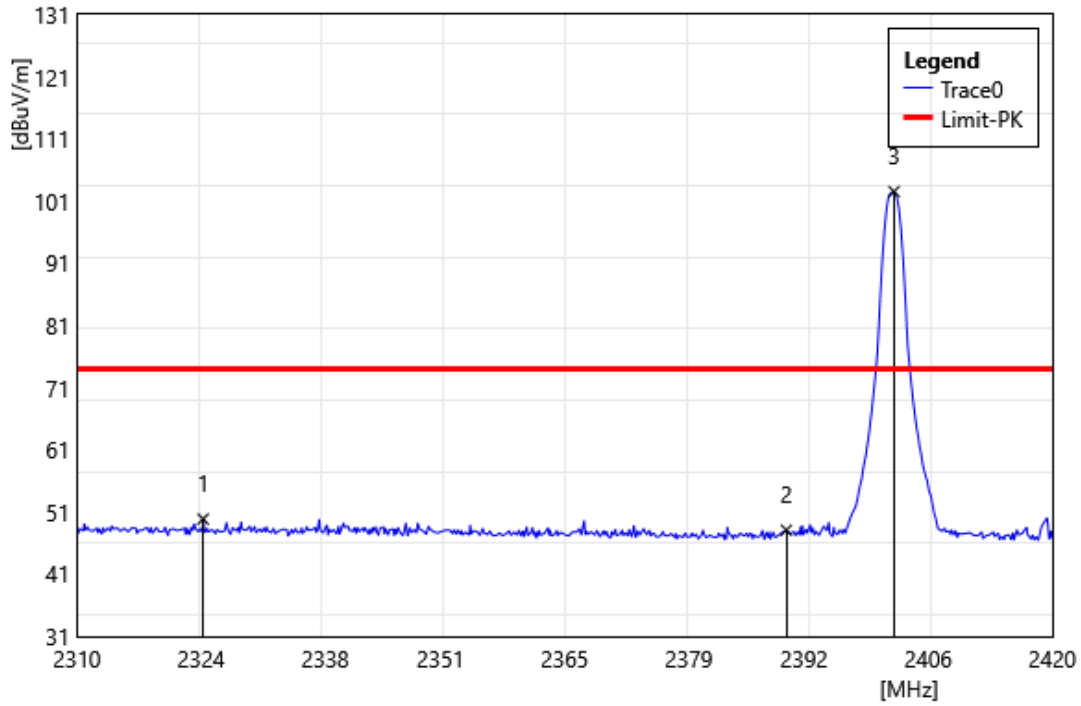

ID	Frequency MHz	Reading dBuV	Correct Factor dB/m	Result dBuV/m	Limit dBuV/m	Margin dB	ReMark
1	2324.23	54.61	-4.73	49.88	74.00	-24.12	PEAK
2	2390.00	53.08	-5.00	48.08	74.00	-25.92	PEAK
3	2402.15	107.63	-5.09	102.54	74.00	28.54	PEAK

Test Site:	96603-WG	Standard:	Part 15.247
Test Mode:	BT GFSK 2480 MHz		
Polarization:	Horizontal		
ReMark:			

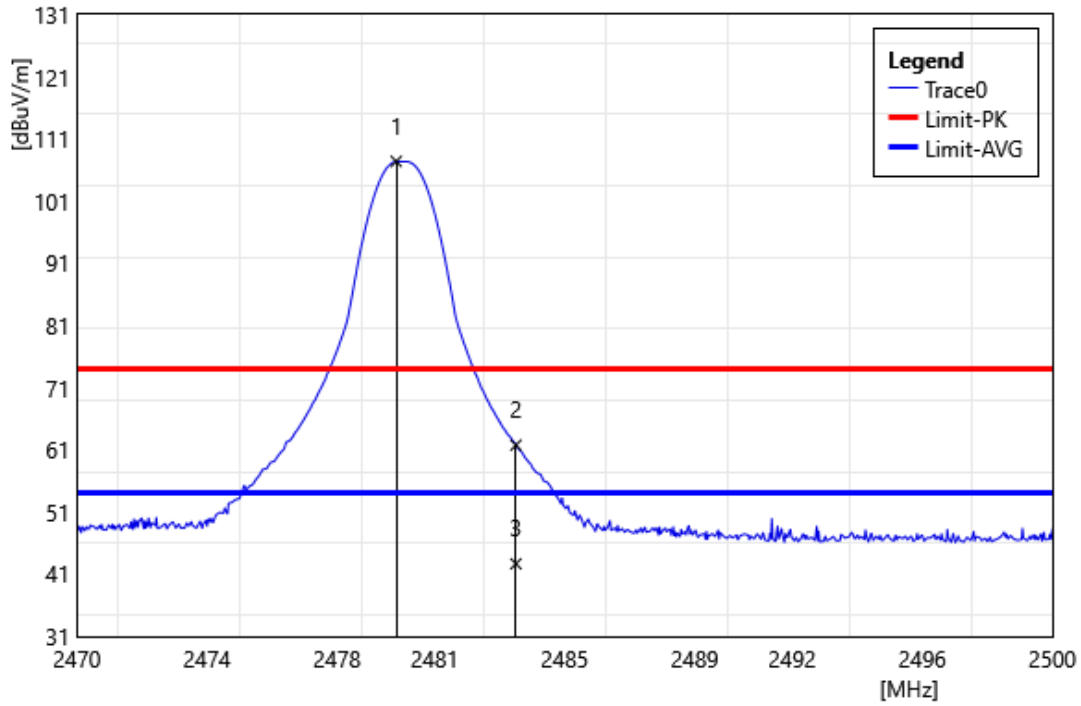

ID	Frequency MHz	Reading dBuV	Correct Factor dB/m	Result dBuV/m	Limit dBuV/m	Margin dB	ReMark
1	2479.82	112.45	-5.05	107.40	74.00	33.40	PEAK
2	2483.50	66.80	-5.03	61.77	74.00	-12.23	PEAK
3	2483.50	47.71	-5.03	42.68	54.00	-11.32	AVG

Test Site:	96603-WG	Standard:	Part 15.247
Test Mode:	BT GFSK 2480 MHz		
Polarization:	Vertical		
ReMark:			

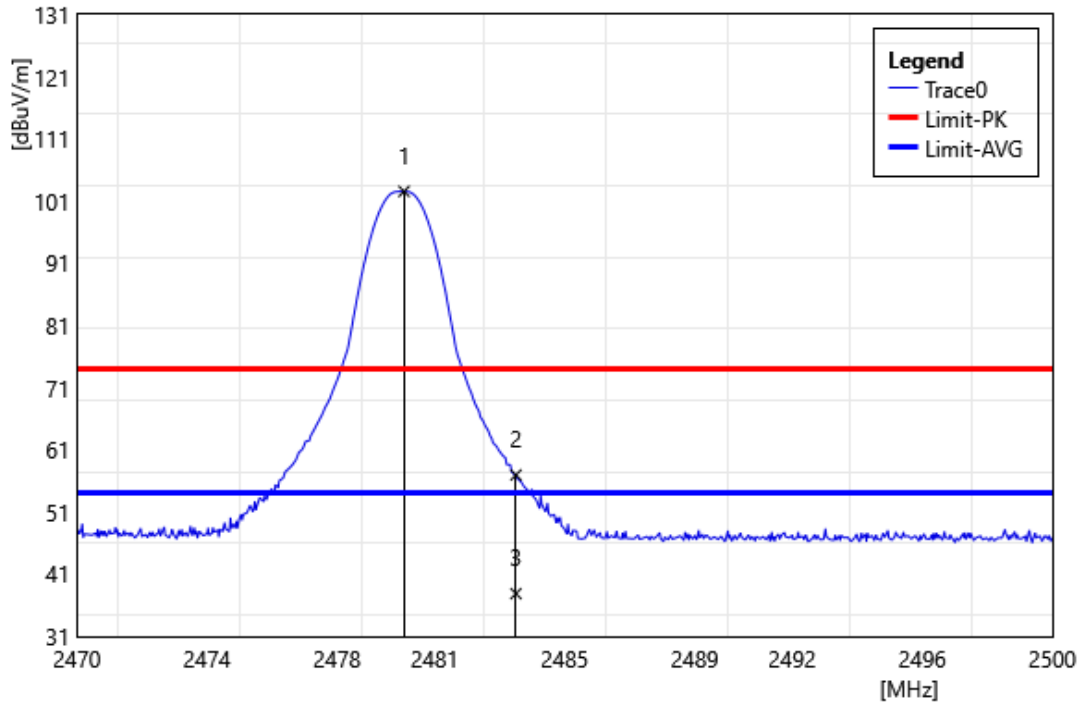

ID	Frequency MHz	Reading dBuV	Correct Factor dB/m	Result dBuV/m	Limit dBuV/m	Margin dB	ReMark
1	2480.06	107.62	-5.05	102.57	74.00	28.57	PEAK
2	2483.50	62.00	-5.03	56.97	74.00	-17.03	PEAK
3	2483.50	42.90	-5.03	37.87	54.00	-16.13	AVG

Test Site:	96603-WG	Standard:	Part 15.247
Test Mode:	BT 8DPSK 2402 MHz		
Polarization:	Horizontal		
ReMark:			

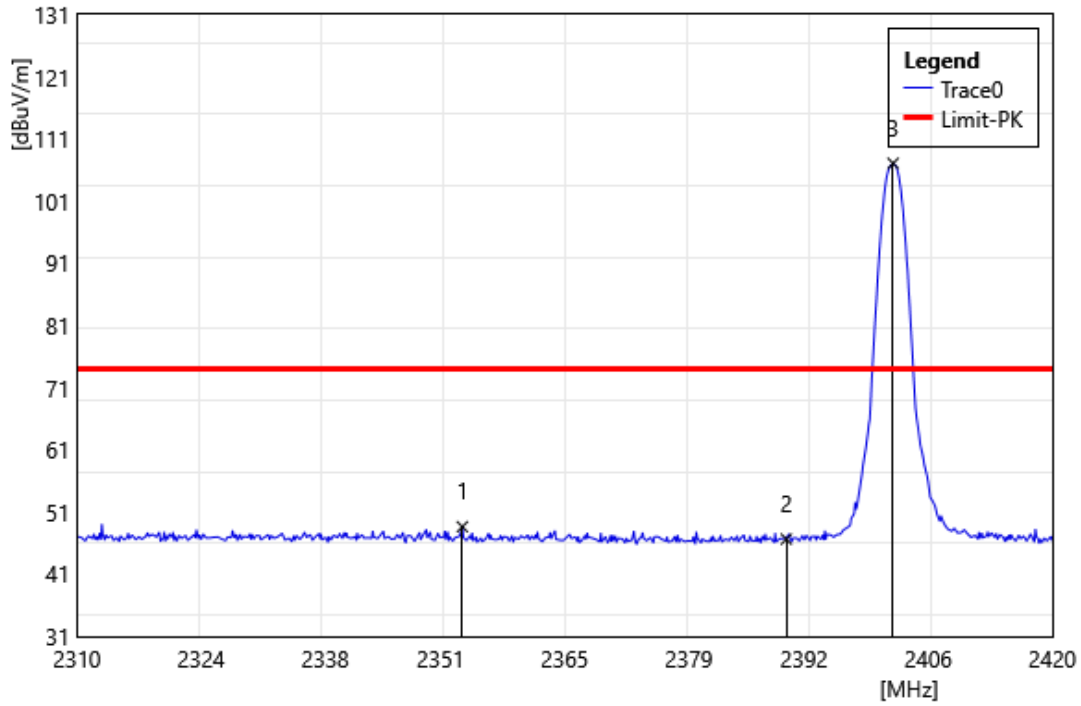

ID	Frequency MHz	Reading dBuV	Correct Factor dB/m	Result dBuV/m	Limit dBuV/m	Margin dB	ReMark
1	2353.46	53.35	-4.71	48.64	74.00	-25.36	PEAK
2	2390.00	51.66	-5.00	46.66	74.00	-27.34	PEAK
3	2402.04	112.18	-5.09	107.09	74.00	33.09	PEAK



Test Site:	96603-WG	Standard:	Part 15.247
Test Mode:	BT 8DPSK 2402 MHz		
Polarization:	Vertical		
ReMark:			

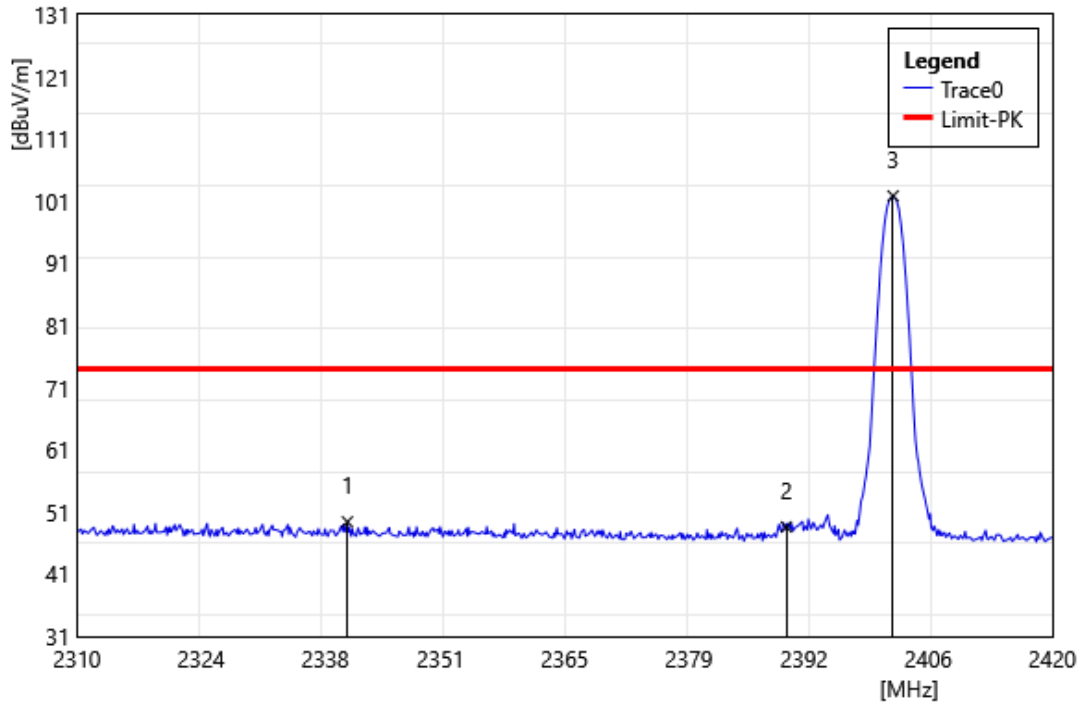

ID	Frequency MHz	Reading dBuV	Correct Factor dB/m	Result dBuV/m	Limit dBuV/m	Margin dB	ReMark
1	2340.49	54.13	-4.70	49.43	74.00	-24.57	PEAK
2	2390.00	53.62	-5.00	48.62	74.00	-25.38	PEAK
3	2402.04	106.94	-5.09	101.85	74.00	27.85	PEAK

Test Site:	96603-WG	Standard:	Part 15.247
Test Mode:	BT 8DPSK 2480 MHz		
Polarization:	Horizontal		
ReMark:			

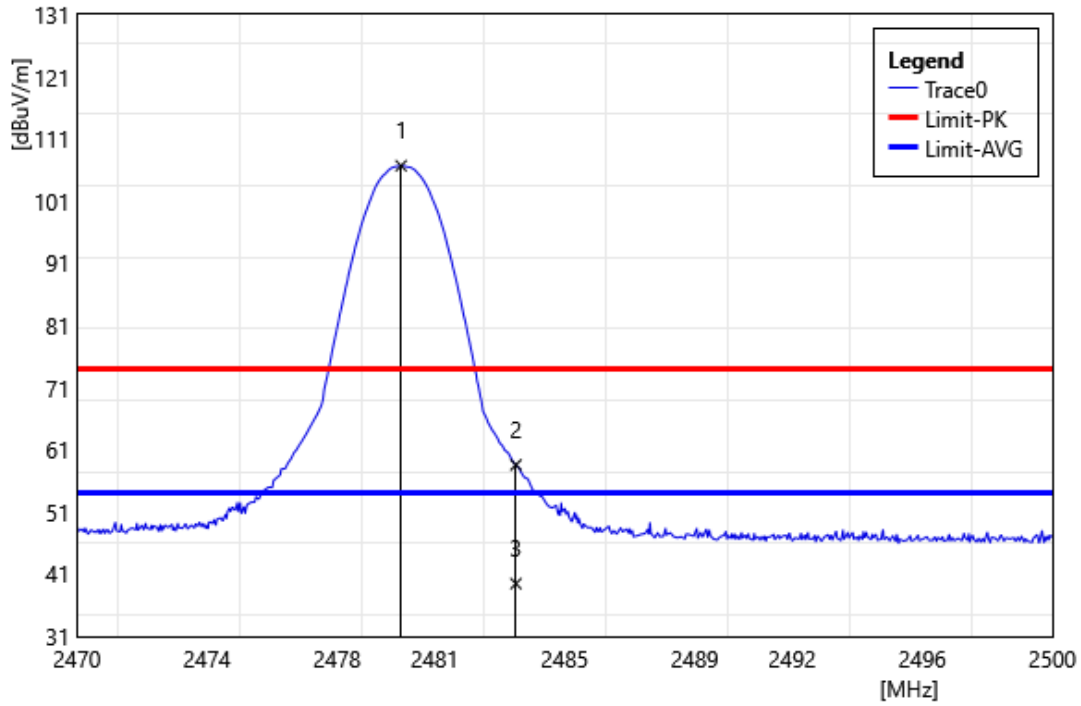

ID	Frequency MHz	Reading dBuV	Correct Factor dB/m	Result dBuV/m	Limit dBuV/m	Margin dB	ReMark
1	2479.97	111.75	-5.05	106.70	74.00	32.70	PEAK
2	2483.50	63.61	-5.03	58.58	74.00	-15.42	PEAK
3	2483.50	44.52	-5.03	39.49	54.00	-14.51	AVG

Test Site:	96603-WG	Standard:	Part 15.247
Test Mode:	BT 8DPSK 2480 MHz		
Polarization:	Vertical		
ReMark:			

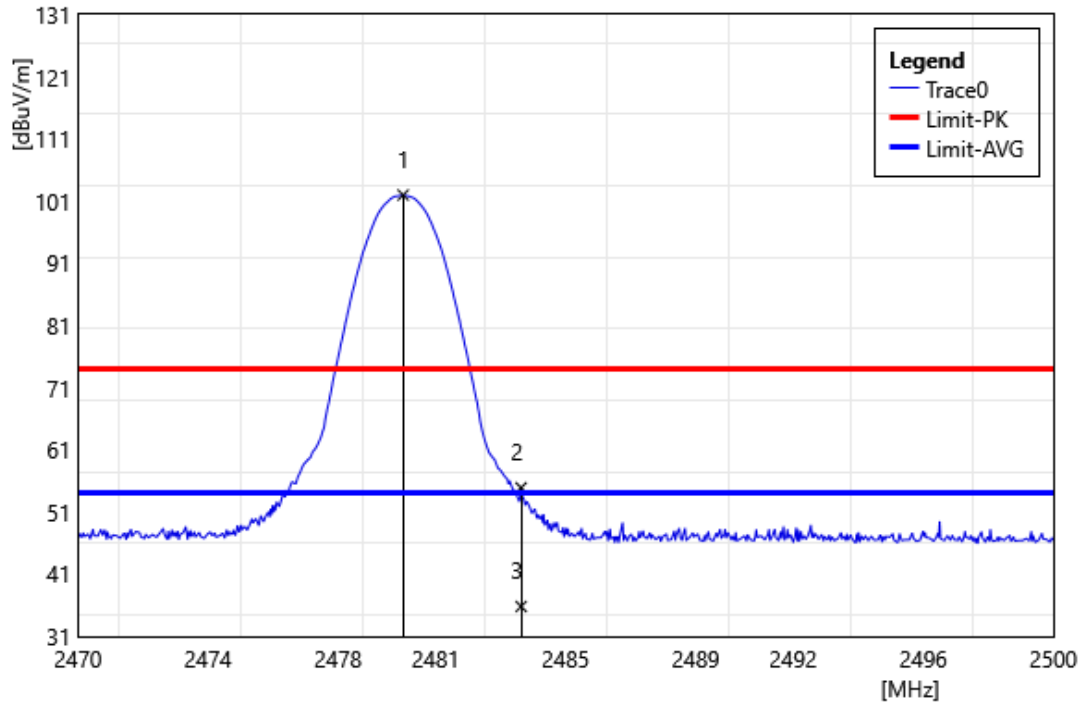

ID	Frequency MHz	Reading dBuV	Correct Factor dB/m	Result dBuV/m	Limit dBuV/m	Margin dB	ReMark
1	2480.00	107.05	-5.05	102.00	74.00	28.00	PEAK
2	2483.50	59.93	-5.03	54.90	74.00	-19.10	PEAK
3	2483.50	40.84	-5.03	35.81	54.00	-18.19	AVG

Test Site:	96603-WG	Standard:	Part 15.247
Test Mode:	BT GFSK Hopping CH Low		
Polarization:	Horizontal		
ReMark:			

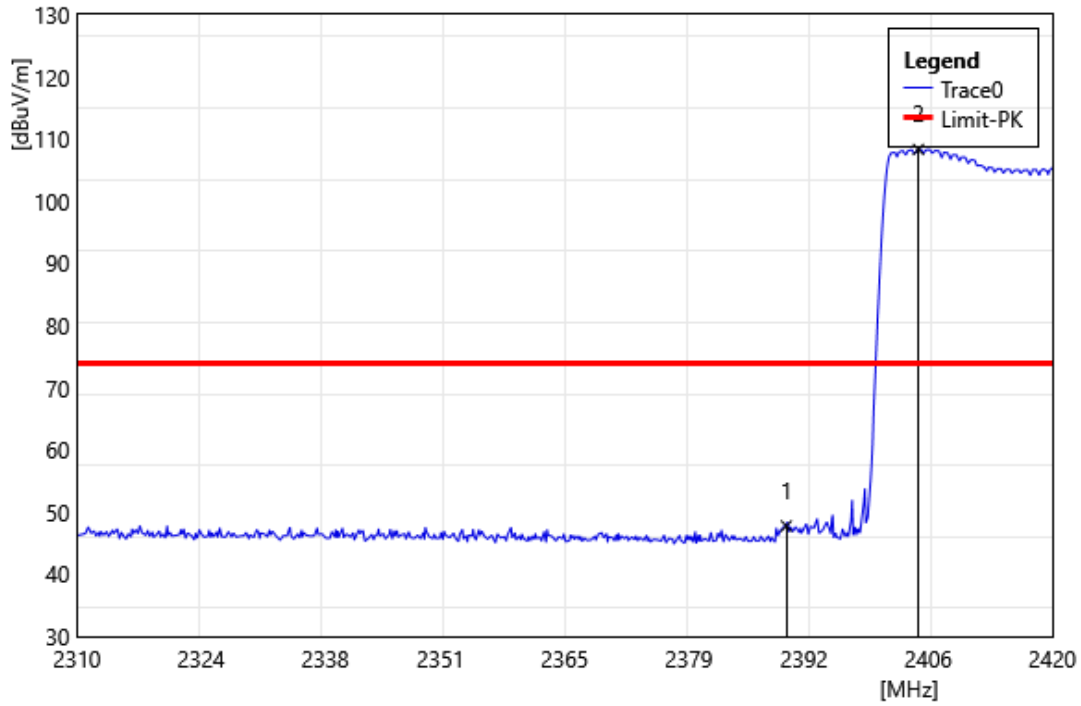

ID	Frequency MHz	Reading dBuV	Correct Factor dB/m	Result dBuV/m	Limit dBuV/m	Margin dB	ReMark
1	2390.00	52.76	-5.00	47.76	74.00	-26.24	PEAK
2	2404.89	113.42	-5.10	108.32	74.00	34.32	PEAK

Test Site:	96603-WG	Standard:	Part 15.247
Test Mode:	BT GFSK Hopping CH Low		
Polarization:	Vertical		
ReMark:			

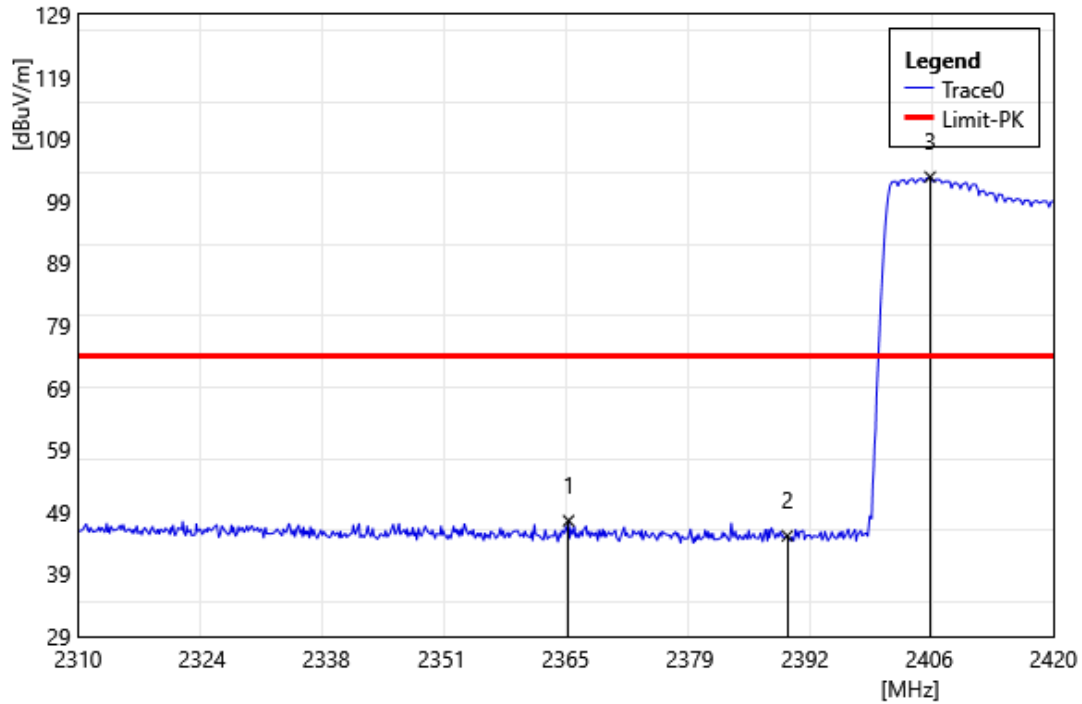

ID	Frequency MHz	Reading dBuV	Correct Factor dB/m	Result dBuV/m	Limit dBuV/m	Margin dB	ReMark
1	2365.33	52.40	-4.80	47.60	74.00	-26.40	PEAK
2	2390.00	50.17	-5.00	45.17	74.00	-28.83	PEAK
3	2406.10	107.98	-5.09	102.89	74.00	28.89	PEAK

Test Site:	96603-WG	Standard:	Part 15.247
Test Mode:	BT GFSK Hopping CH High		
Polarization:	Horizontal		
ReMark:			

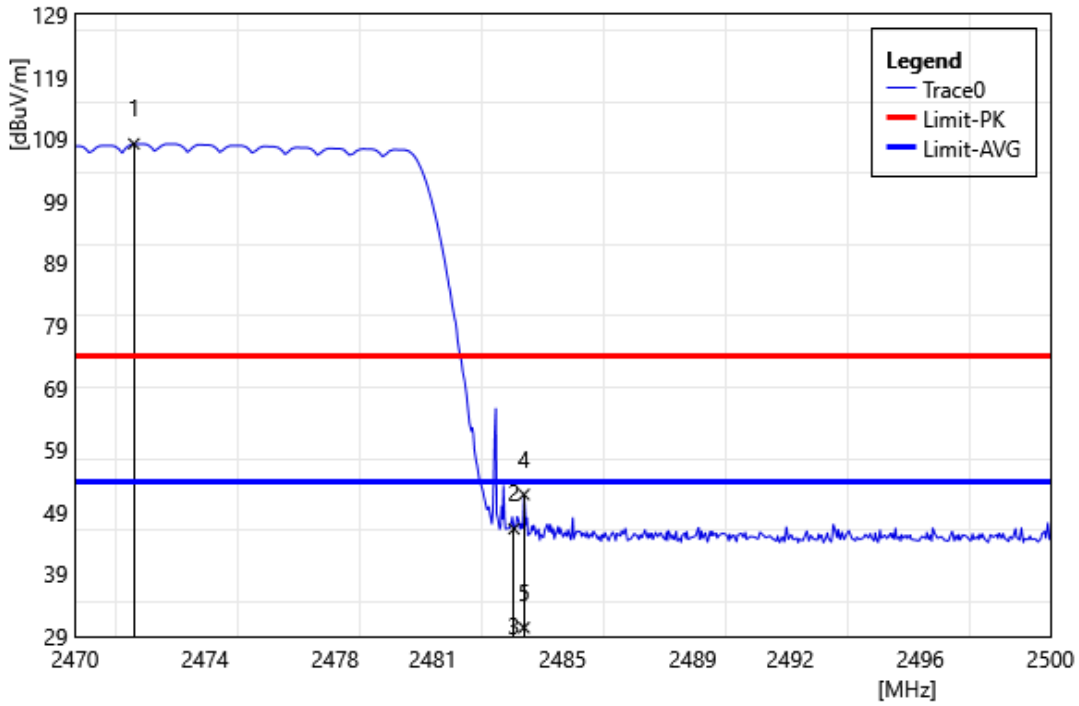

ID	Frequency MHz	Reading dBuV	Correct Factor dB/m	Result dBuV/m	Limit dBuV/m	Margin dB	ReMark
1	2471.81	113.30	-5.08	108.22	74.00	34.22	PEAK
2	2483.50	51.33	-5.03	46.30	74.00	-27.70	PEAK
3	2483.50	29.92	-5.03	24.89	54.00	-29.11	AVG
4	2483.81	56.85	-5.02	51.83	74.00	-22.17	PEAK
5	2483.81	35.44	-5.02	30.42	54.00	-23.58	AVG

Test Site:	96603-WG	Standard:	Part 15.247
Test Mode:	BT GFSK Hopping CH High		
Polarization:	Vertical		
ReMark:			

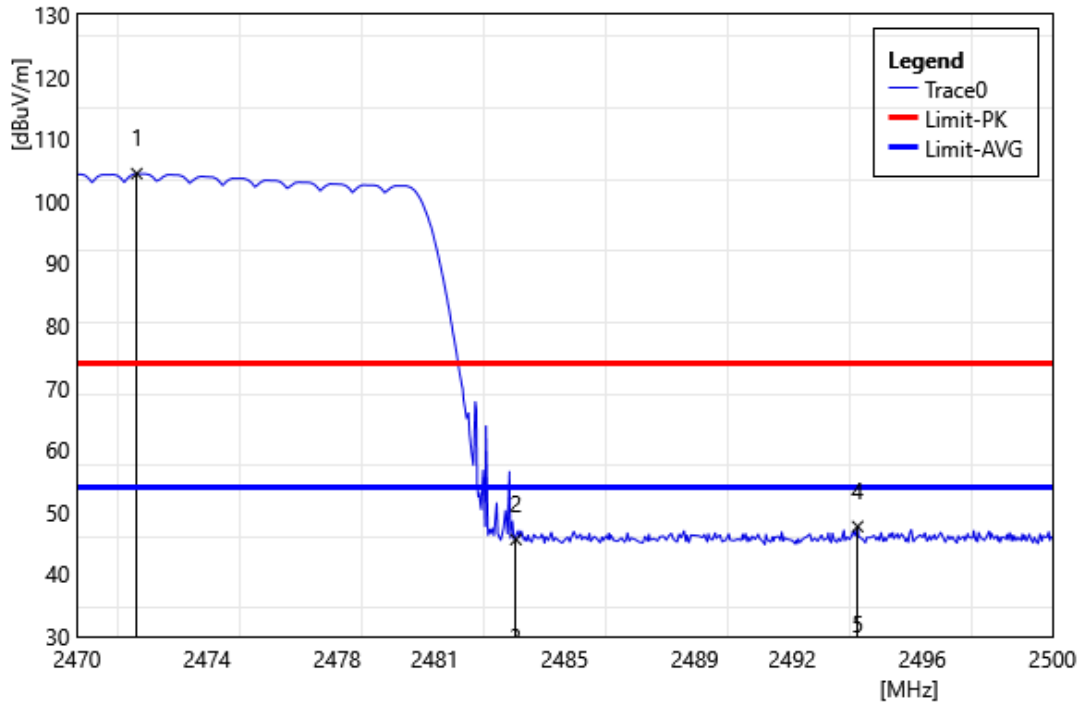

ID	Frequency MHz	Reading dBuV	Correct Factor dB/m	Result dBuV/m	Limit dBuV/m	Margin dB	ReMark
1	2471.84	109.51	-5.08	104.43	74.00	30.43	PEAK
2	2483.50	50.61	-5.03	45.58	74.00	-28.42	PEAK
3	2483.50	29.20	-5.03	24.17	54.00	-29.83	AVG
4	2494.01	52.66	-4.99	47.67	74.00	-26.33	PEAK
5	2494.01	31.25	-4.99	26.26	54.00	-27.74	AVG

Test Site:	96603-WG	Standard:	Part 15.247
Test Mode:	BT 8DPSK Hopping CH Low		
Polarization:	Horizontal		
ReMark:			

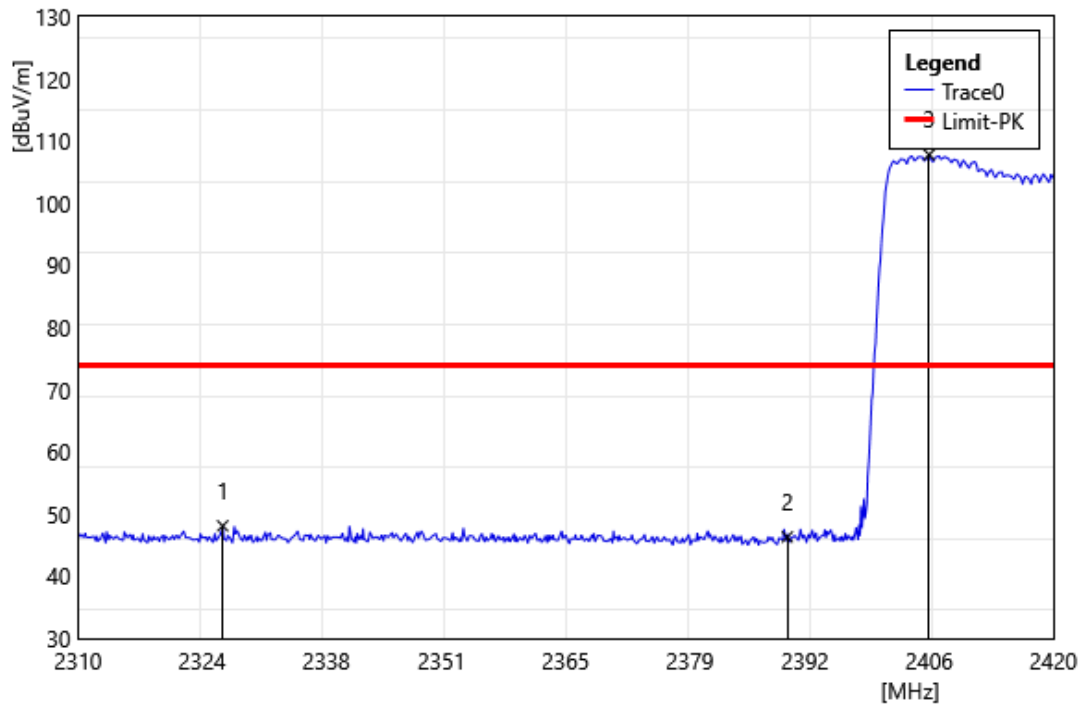

ID	Frequency MHz	Reading dBuV	Correct Factor dB/m	Result dBuV/m	Limit dBuV/m	Margin dB	ReMark
1	2326.32	52.84	-4.73	48.11	74.00	-25.89	PEAK
2	2390.00	51.33	-5.00	46.33	74.00	-27.67	PEAK
3	2405.99	112.88	-5.09	107.79	74.00	33.79	PEAK



Test Site:	96603-WG	Standard:	Part 15.247
Test Mode:	BT 8DPSK Hopping CH Low		
Polarization:	Vertical		
ReMark:			

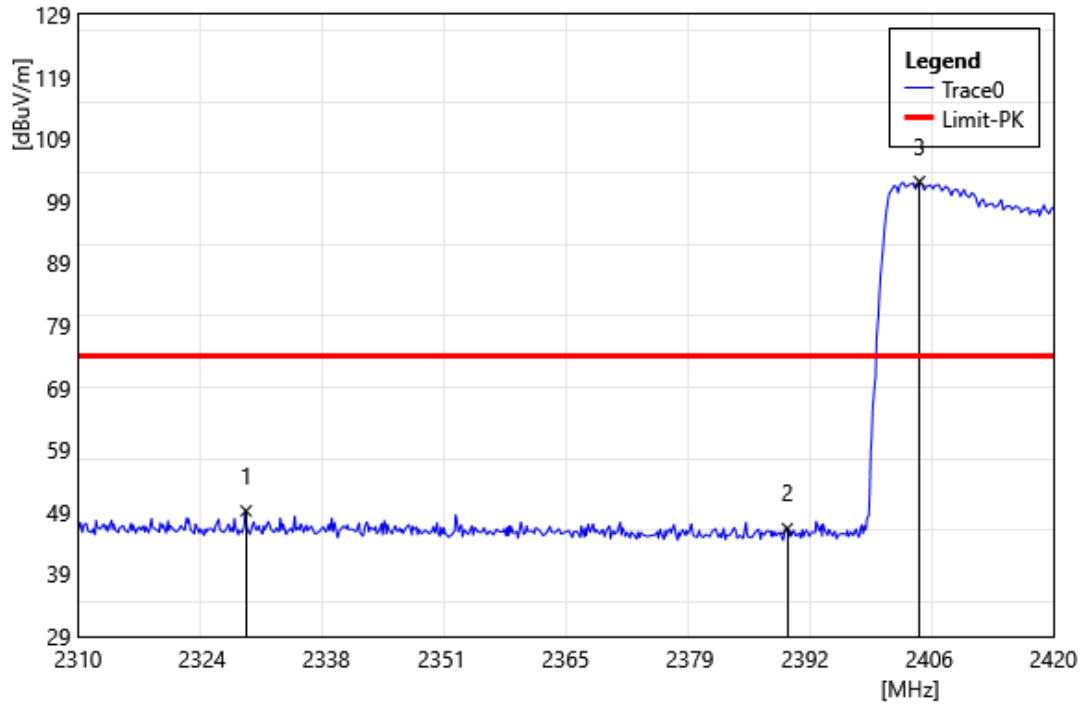

ID	Frequency MHz	Reading dBuV	Correct Factor dB/m	Result dBuV/m	Limit dBuV/m	Margin dB	ReMark
1	2328.95	53.90	-4.72	49.18	74.00	-24.82	PEAK
2	2390.00	51.35	-5.00	46.35	74.00	-27.65	PEAK
3	2404.89	107.24	-5.10	102.14	74.00	28.14	PEAK

Test Site:	96603-WG	Standard:	Part 15.247
Test Mode:	BT 8DPSK Hopping CH High		
Polarization:	Horizontal		
ReMark:			

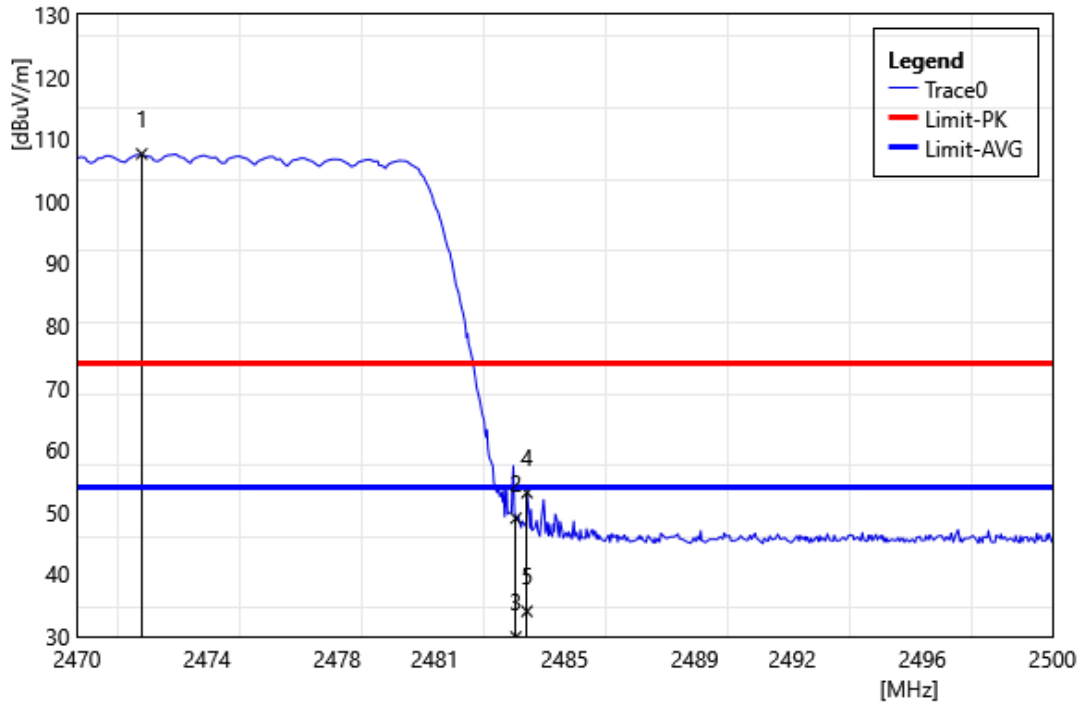

ID	Frequency MHz	Reading dBuV	Correct Factor dB/m	Result dBuV/m	Limit dBuV/m	Margin dB	ReMark
1	2471.99	112.68	-5.08	107.60	74.00	33.60	PEAK
2	2483.50	54.05	-5.03	49.02	74.00	-24.98	PEAK
3	2483.50	34.95	-5.03	29.92	54.00	-24.08	AVG
4	2483.84	58.14	-5.02	53.12	74.00	-20.88	PEAK
5	2483.84	39.05	-5.02	34.03	54.00	-19.97	AVG

Test Site:	96603-WG	Standard:	Part 15.247
Test Mode:	BT 8DPSK Hopping CH High		
Polarization:	Vertical		
ReMark:			

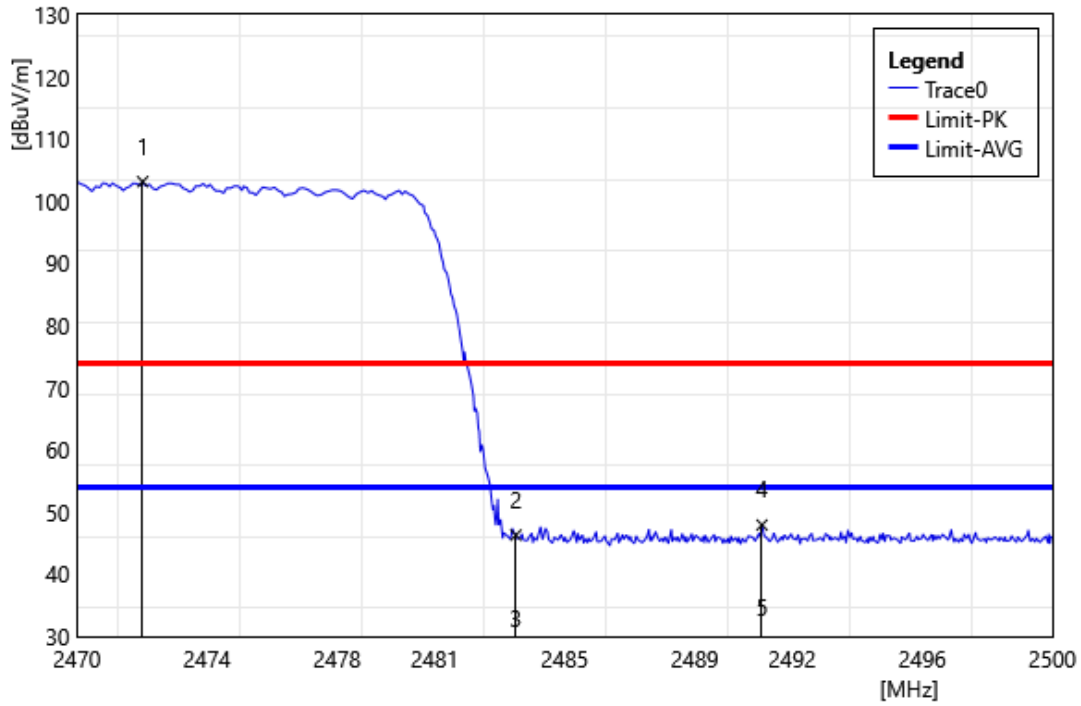

ID	Frequency MHz	Reading dBuV	Correct Factor dB/m	Result dBuV/m	Limit dBuV/m	Margin dB	ReMark
1	2472.02	108.23	-5.08	103.15	74.00	29.15	PEAK
2	2483.50	51.33	-5.03	46.30	74.00	-27.70	PEAK
3	2483.50	32.24	-5.03	27.21	54.00	-26.79	AVG
4	2491.07	52.92	-5.00	47.92	74.00	-26.08	PEAK
5	2491.07	33.83	-5.00	28.83	54.00	-25.17	AVG

---END---