

Annex 1: Measurement diagrams
to TEST REPORT
No.: 16-1-0019501T07a

According to:
FCC Regulations
Part 22, Part 24, Part 15C

IC-Regulations
RSS-132 Issue 3, RSS-133 Issue 6,
RSS-Gen Issue 4

for

u-Blox AG

GSM/W-CDMA Module SARA-U201

FCC-ID: XPY1CGM5NNN
IC: 8595A-1CGM5NNN
PMN: SARA-U201
HVIN: SARA-U201







Laboratory Accreditation and Listings			
 DAkKS Deutsche Akkreditierungsstelle D-PL-12047-01-01	 FEDERAL COMMUNICATIONS COMMISSION USA MRA US-EU 0003	 Industry Canada Reg. No.: 3462D-1 Reg. No.: 3462D-2 Reg. No.: 3462D-3	 Voluntary Controls for Electromagnetic Emissions Reg. No.: R-2666 C-2914, T-1967, G-301
 WiFi ALLIANCE AUTHORIZED RF LABORATORY	 ctia Authorized Test Lab Lab Code: 20011130-00		
accredited according to DIN EN ISO/IEC 17025			
<p align="center">CETECOM GmbH Laboratory Radio Communications & Electromagnetic Compatibility Im Teelbruch 116 • 45219 Essen • Germany Registered in Essen, Germany, Reg. No.: HRB Essen 8984 Tel.: + 49 (0) 20 54 / 95 19-954 • Fax: + 49 (0) 20 54 / 95 19-964 E-mail: info@cetecom.com • Internet: www.cetecom.com</p>			

Table of contents

1. MEASUREMENT DIAGRAMS.....	3
1.1. Magnetic field strength emissions measurements accord. §15.209	3
1.2. Spurious emissions radiated (850 MHz transmitting mode).....	9
1.3. Spurious emissions radiated (1900 MHz transmitting mode).....	12
1.4. Radiated emissions on 850 MHz transmitting band-edge.....	15
1.5. Radiated emissions on 1900 MHz transmitting band-edge.....	17
1.6. Power Measurements and PAPR-Value	21
1.7. 26dBc Emission bandwidth	29
1.8. 99% Occupied bandwidth.....	36
1.9. Spurious emissions conducted (850 MHz transmitting mode)	42
1.10. Spurious emissions conducted (1900 MHz transmitting mode)	48
1.11. Conducted emissions on 850 MHz transmitting band-edge.....	51
1.12. Conducted emissions on 1900 MHz transmitting band-edge.....	53

1. Measurement diagrams

1.1. Magnetic field strength emissions measurements accord. §15.209

Diagram No. 2.01_Channel_128

Test description:	Date: 07.06.2016 Page 1 of 5
Test site and distance:	Magnetic Field Strength Measurement related to 30/300 m distance
Version of Testsoftware:	Ref.-Nr. 441 Semi Anechoic Room (SAR) with 3 m measurement distance
Distance correction:	EMC32 V9.25.0
Technical Data:	used accord. table, pls. see test report
Rec. antenna (pre-scan):	Please see page 2 for detailed data of measurement setup
Used filter:	height 1.00 m, parallel and 90° to EUT polarisation
Test specification:	bypass
	FCC 15.205 § 15.209; RSS-Gen: Issue 4
Operator:	AHo
Operating conditions:	TX-on
Power during tests:	3,8V DC, 120V/60Hz,
Comment 1:	Channel low=128
Comment 2:	

EUT Information

Manufacturer:	u-blox AG
Model:	SARA-U201
Type:	GSM/WCDMA module

EUT:	-
HW version:	261A01
SW version:	23.56
SVN:	-
Config:	-
Serial number:	357520070020959
Connected Interfaces:	Antenna GSATT1505001611 and Headset
Power Supply:	3.8V DC
Comments:	-

Full Spectrum

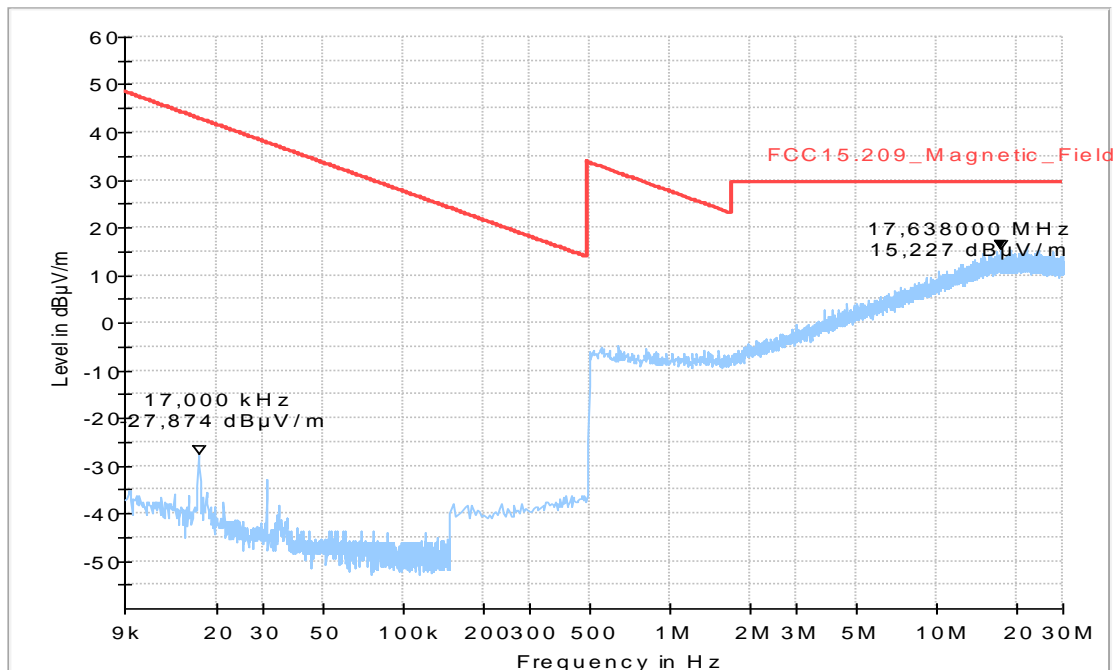

Diagram No. 2.02_V_Ch192

Date:	30.05.2016	Page 1 of 5
Test description:	Magnetic Field Strength Measurement related to 30/300 m distance	
Test site and distance:	Ref.-Nr. 441 Semi Anechoic Room (SAR) with 3 m measurement distance	
Version of Testsoftware:	EMC32 V9.25.0	
Distance correction:	used accord. table, pls. see test report	
Technical Data:	Please see page 2 for detailed data of measurement setup	
Rec. antenna (pre-scan):	height 1.00 m, parallel and 90° to EUT polarisation	
Used filter:	bypass	
Test specification:	FCC 15.205 § 15.209; RSS-Gen: Issue 4	
Operator:	Ase	
Operating conditions:	TX-on	
Power during tests:	12V DC, 3.8V DC	
Comment 1:	Channel middle=192	
Comment 2:	EUT vertical	

EUT Information

Manufacturer:	u-blox AG
Model:	SARA-U201
Type:	GSM/WCDMA module

EUT:	-
HW version:	261A01
SW version:	23.56
SVN:	-
Config:	-
Serial number:	357520070020959
Connected Interfaces:	Antenna GSATT1505001611 and Headset
Power Supply:	3.8V DC
Comments:	-

Full Spectrum

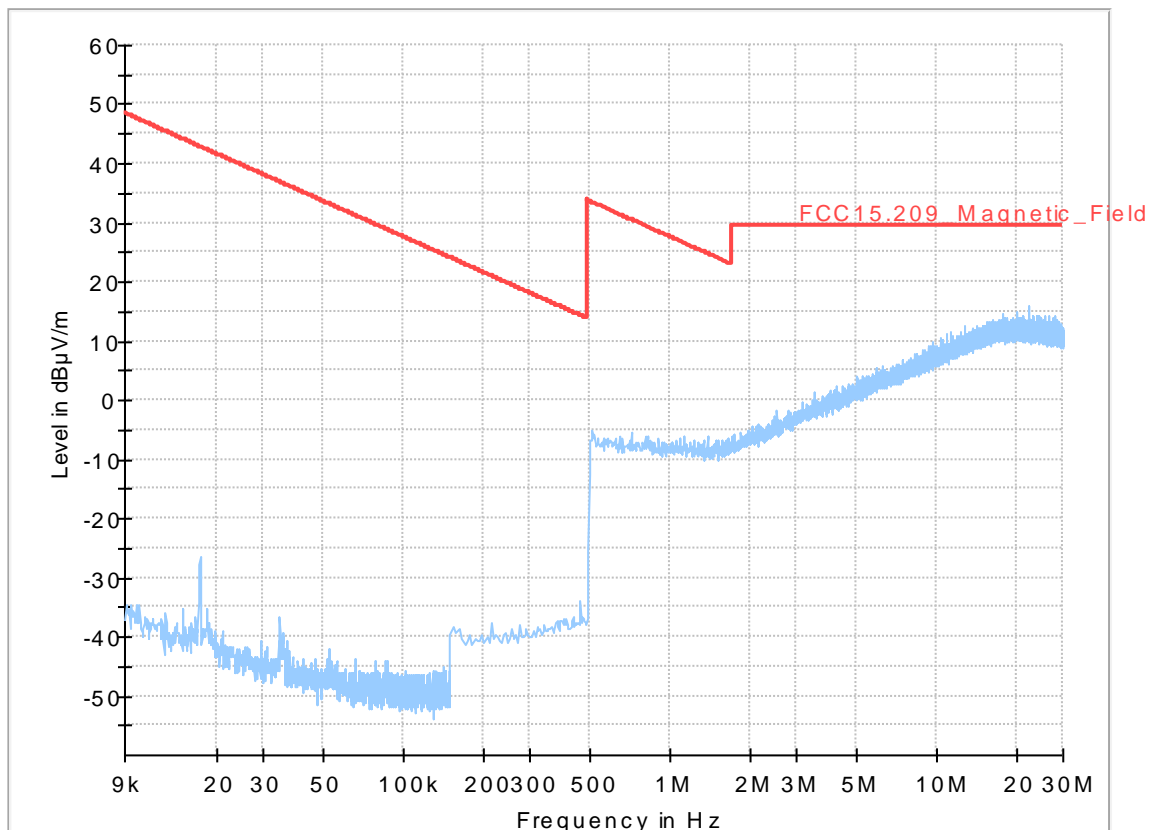

Diagram No. 2.03_V_Ch251

Date:	30.05.2016	Page 1 of 5
Test description:	Magnetic Field Strength Measurement related to 30/300 m distance	
Test site and distance:	Ref.-Nr. 441 Semi Anechoic Room (SAR) with 3 m measurement distance	
Version of Testsoftware:	EMC32 V9.25.0	
Distance correction:	used accord. table, pls. see test report	
Technical Data:	Please see page 2 for detailed data of measurement setup	
Rec. antenna (pre-scan):	height 1.00 m, parallel and 90° to EUT polarisation	
Used filter:	bypass	
Test specification:	FCC 15.205 § 15.209; RSS-Gen: Issue 4	
Operator:	Ase	
Operating conditions:	TX-on	
Power during tests:	12V DC, 3.8V DC	
Comment 1:	Channel high =251	
Comment 2:	EUT vertical	

EUT Information

Manufacturer:	u-blox AG
Model:	SARA-U201
Type:	GSM/WCDMA module

EUT:	-
HW version:	261A01
SW version:	23.56
SVN:	-
Config:	-
Serial number:	357520070020959
Connected Interfaces:	Antenna GSATT1505001611 and Headset
Power Supply:	3.8V DC
Comments:	-

Full Spectrum

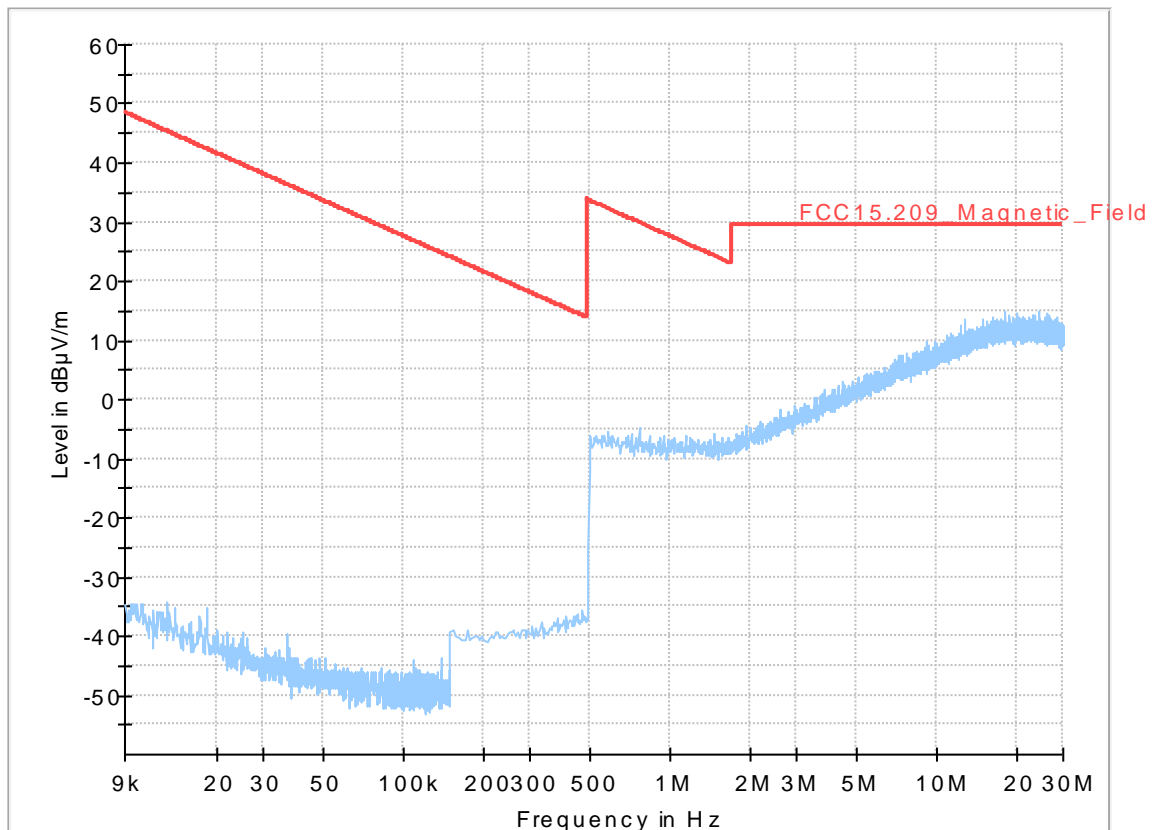

Diagram No. 2.23_Channel_512

Test description:	Date: 07.06.2016 Page 1 of 5
Test site and distance:	Magnetic Field Strength Measurement related to 30/300 m distance
Version of Testsoftware:	Ref.-Nr. 441 Semi Anechoic Room (SAR) with 3 m measurement distance
Distance correction:	EMC32 V9.25.0
Technical Data:	used accord. table, pls. see test report
Rec. antenna (pre-scan):	Please see page 2 for detailed data of measurement setup
Used filter:	height 1.00 m, parallel and 90° to EUT polarisation
Test specification:	bypass
	FCC 15.205 § 15.209; RSS-Gen: Issue 4
Operator:	AHo
Operating conditions:	TX-on
Power during tests:	3,8V DC, 120V/60Hz,
Comment 1:	Channel 512
Comment 2:	

EUT Information

Manufacturer:	u-blox AG
Model:	SARA-U201
Type:	GSM/WCDMA module

EUT:	-
HW version:	261A01
SW version:	23.56
SVN:	-
Config:	-
Serial number:	357520070020959
Connected Interfaces:	Antenna GSATT1505001611 and Headset
Power Supply:	3.8V DC
Comments:	-

Full Spectrum

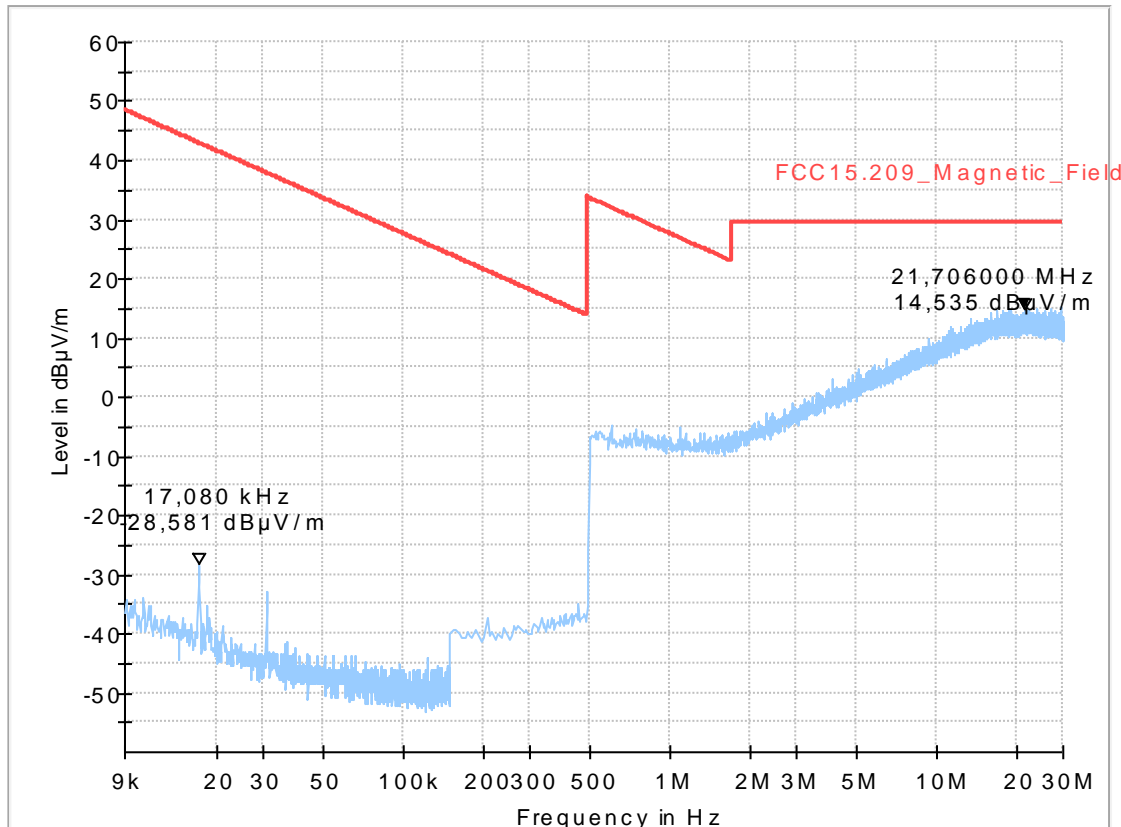

Diagram No. 2.24_Channel_661

Test description:	Date: 07.06.2016 Page 1 of 5
Test site and distance:	Magnetic Field Strength Measurement related to 30/300 m distance
Version of Testsoftware:	Ref.-Nr. 441 Semi Anechoic Room (SAR) with 3 m measurement distance
Distance correction:	EMC32 V9.25.0
Technical Data:	used accord. table, pls. see test report
Rec. antenna (pre-scan):	Please see page 2 for detailed data of measurement setup
Used filter:	height 1.00 m, parallel and 90° to EUT polarisation
Test specification:	bypass
	FCC 15.205 § 15.209; RSS-Gen: Issue 4

Operator:	AHo
Operating conditions:	TX-on
Power during tests:	3,8V DC, 120V/60Hz,
Comment 1:	Channel 661
Comment 2:	

EUT Information

Manufacturer:	u-blox AG
Model:	SARA-U201
Type:	GSM/WCDMA module

EUT:	-
HW version:	261A01
SW version:	23.56
SVN:	-
Config:	-
Serial number:	357520070020959
Connected Interfaces:	Antenna GSATT1505001611 and Headset
Power Supply:	3.8V DC
Comments:	-

Full Spectrum

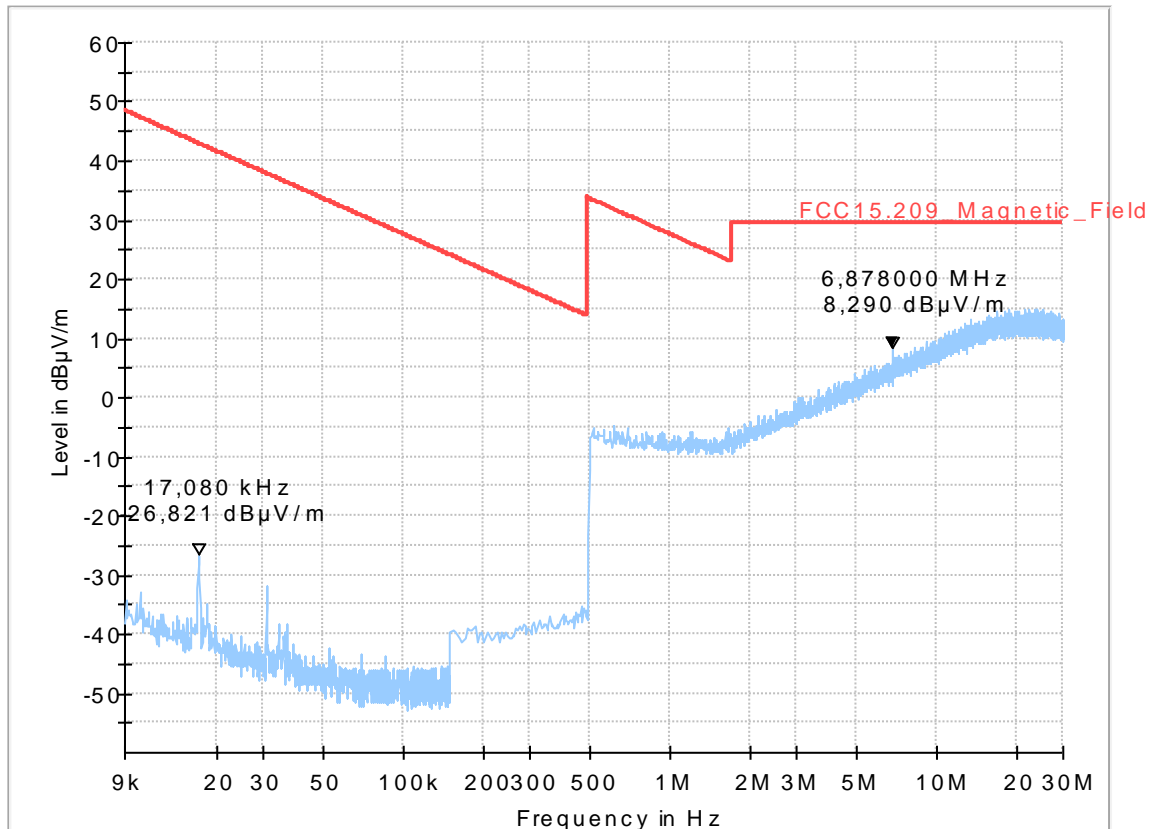

Diagram No. 2.25_Channel_810

Date:	07.06.2016	Page 1 of 5
Test description:	Magnetic Field Strength Measurement related to 30/300 m distance	
Test site and distance:	Ref.-Nr. 441 Semi Anechoic Room (SAR) with 3 m measurement distance	
Version of Testsoftware:	EMC32 V9.25.0	
Distance correction:	used accord. table, pls. see test report	
Technical Data:	Please see page 2 for detailed data of measurement setup	
Rec. antenna (pre-scan):	height 1.00 m, parallel and 90° to EUT polarisation	
Used filter:	bypass	
Test specification:	FCC 15.205 § 15.209; RSS-Gen: Issue 4	
Operator:	AHo	
Operating conditions:	TX-on	
Power during tests:	3,8V DC, 120V/60Hz,	
Comment 1:	Channel 810	
Comment 2:		

EUT Information

Manufacturer:	u-blox AG
Model:	SARA-U201
Type:	GSM/WCDMA module

EUT:	-
HW version:	261A01
SW version:	23.56
SVN:	-
Config:	-
Serial number:	357520070020959
Connected Interfaces:	Antenna GSATT1505001611 and Headset
Power Supply:	3.8V DC
Comments:	-

Full Spectrum

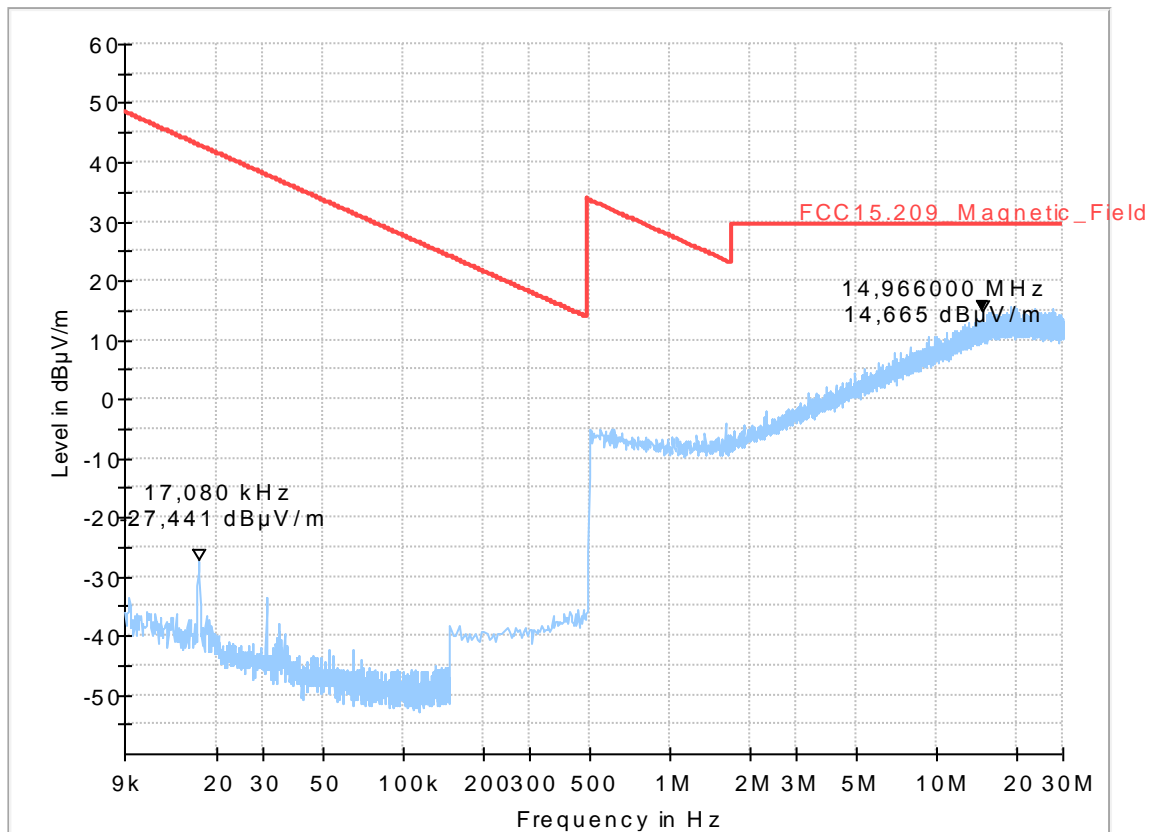

1.2. Spurious emissions radiated (850 MHz transmitting mode)

Diagram 8.04_RSE_R_Ch128_GPRS

Common Information

Test Description:	Radiated Emissions GSM850
Test Site Location:	CETECOM GmbH Essen
Test Site:	Fully Anechoic Room (FAR) - EMC32 V9.26.0
Test Standard:	FCC Part22.917/RSS-132
Test Case:	-
Operating Mode:	MS allocated UL channel 128
Exclusionband:	824 - 849MHz
Environmental Conditions:	Humidity: 50%rH; Temperature: 22°C
Operator:	AHo

EUT Information

Manufacturer:	u-blox AG
Model:	SARA-U201
Type:	GSM/WCDMA module

EUT:	-
HW version:	261A01
SW version:	23.56
SVN:	-
Config:	-
Serial number:	357520070020959
Connected Interfaces:	Antenna GSATT1505001611 and Headset
Power Supply:	3.8V DC
Comments:	-

Full Spectrum

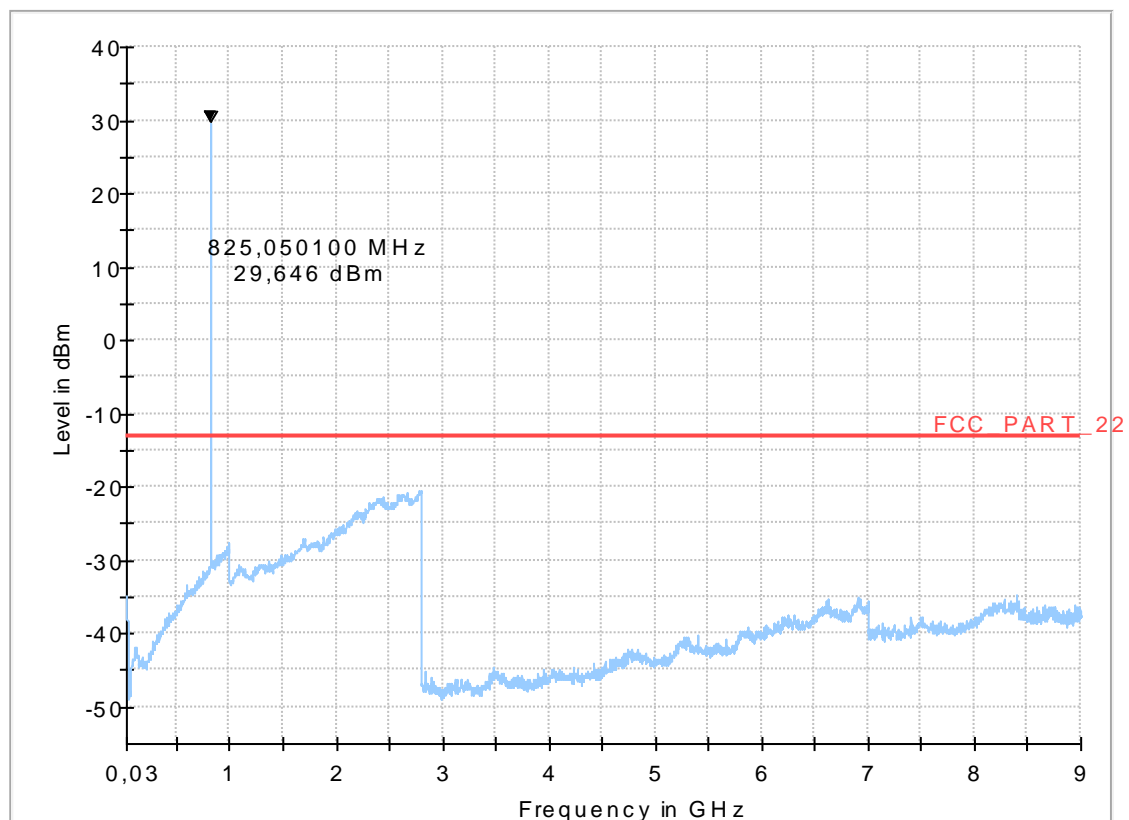

Diagram 8.05_RSE_R_Ch192_GPRS

Common Information

Test Description:	Radiated Emissions GSM850
Test Site Location:	CETECOM GmbH Essen
Test Site:	Fully Anechoic Room (FAR)
Test Standard:	FCC Part22.917/RSS-132
Test Case:	-
Operating Mode:	MS allocated UL channel 192
Exclusionband:	824 - 849MHz
Environmental Conditions:	Humidity: 50%rH; Temperature: 22°C
Operator:	Aho

EUT Information

Manufacturer:	u-blox AG
Model:	SARA-U201
Type:	GSM/WCDMA module

EUT:	-
HW version:	261A01
SW version:	23.56
SVN:	-
Config:	-
Serial number:	357520070020959
Connected Interfaces:	Antenna GSATT1505001611 and Headset
Power Supply:	3.8V DC
Comments:	-

Full Spectrum

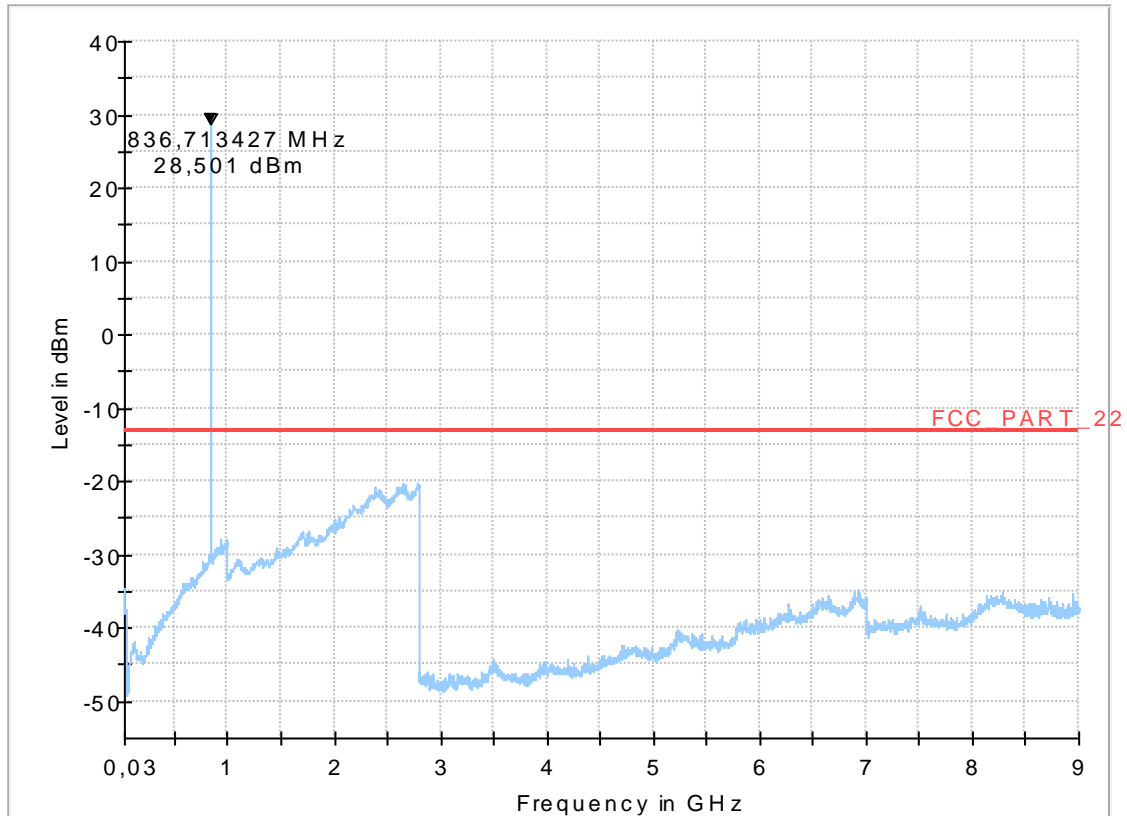

Diagram 8.06_RSE_R_Ch251_GPRS

Common Information

Test Description:	Radiated Emissions GSM850
Test Site Location:	CETECOM GmbH Essen
Test Site:	Fully Anechoic Room (FAR) - EMC32 V9.26.0
Test Standard:	FCC Part22.917/RSS-132
Test Case:	-
Operating Mode:	MS allocated UL channel 251
Exclusionband:	824 - 849MHz
Environmental Conditions:	Humidity: 50%rH; Temperature: 22°C
Operator:	AHo

EUT Information

Manufacturer:	u-blox AG
Model:	SARA-U201
Type:	GSM/WCDMA module

EUT:	-
HW version:	261A01
SW version:	23.56
SVN:	-
Config:	-
Serial number:	357520070020959
Connected Interfaces:	Antenna GSATT1505001611 and Headset
Power Supply:	3.8V DC
Comments:	-

Full Spectrum

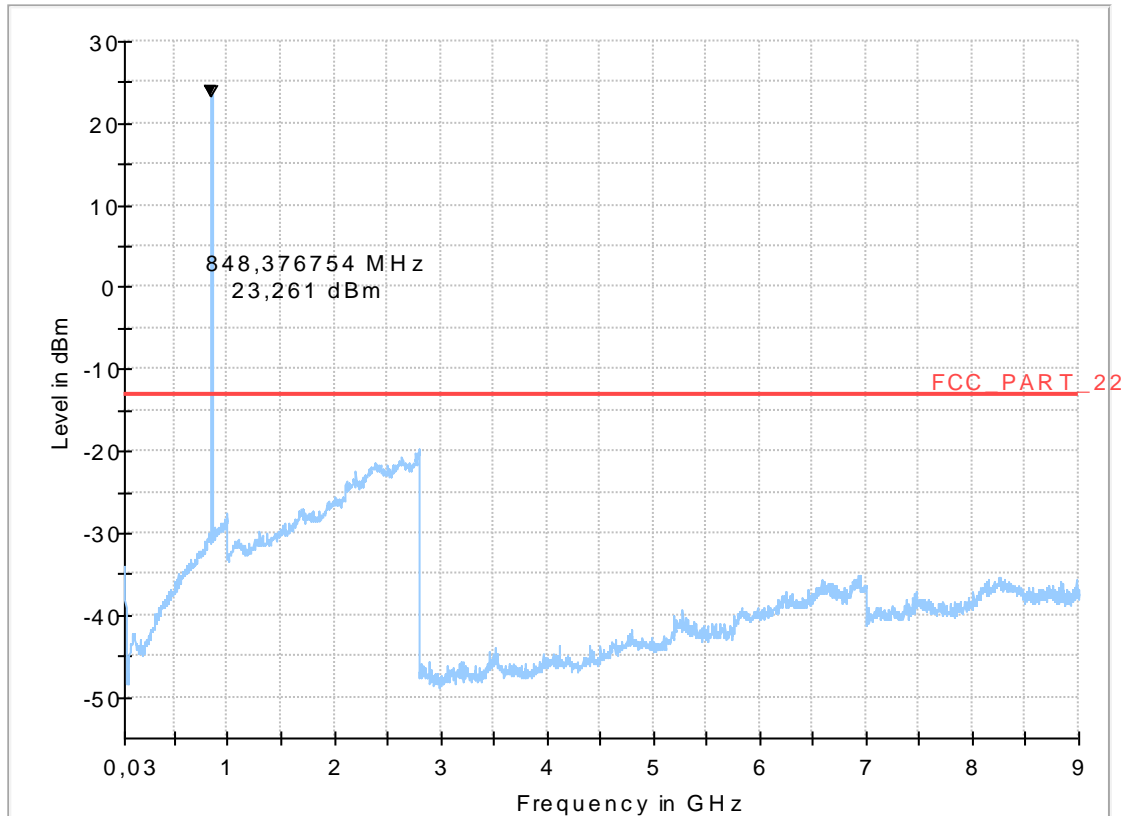

1.3. Spurious emissions radiated (1900 MHz transmitting mode)

Diagram 8.13_RSE_R_Ch512_GPRS

Common Information

Test Description:	Radiated Emissions GSM850
Test Site Location:	CETECOM GmbH Essen
Test Site:	Fully Anechoic Room (FAR) - EMC32 V9.26.0
Test Standard:	FCC Part24.238
Test Case:	-
Operating Mode:	MS allocated UL channel 512
Exclusionband:	1850 - 1910MHz
Environmental Conditions:	Humidity: 50%rH; Temperature: 22°C
Operator:	AHo

EUT Information

Manufacturer:	u-blox AG
Model:	SARA-U201
Type:	GSM/WCDMA module

EUT:	-
HW version:	261A01
SW version:	23.56
SVN:	-
Config:	-
Serial number:	357520070020959
Connected Interfaces:	Antenna GSATT1505001611 and Headset
Power Supply:	3.8V DC
Comments:	-

Full Spectrum

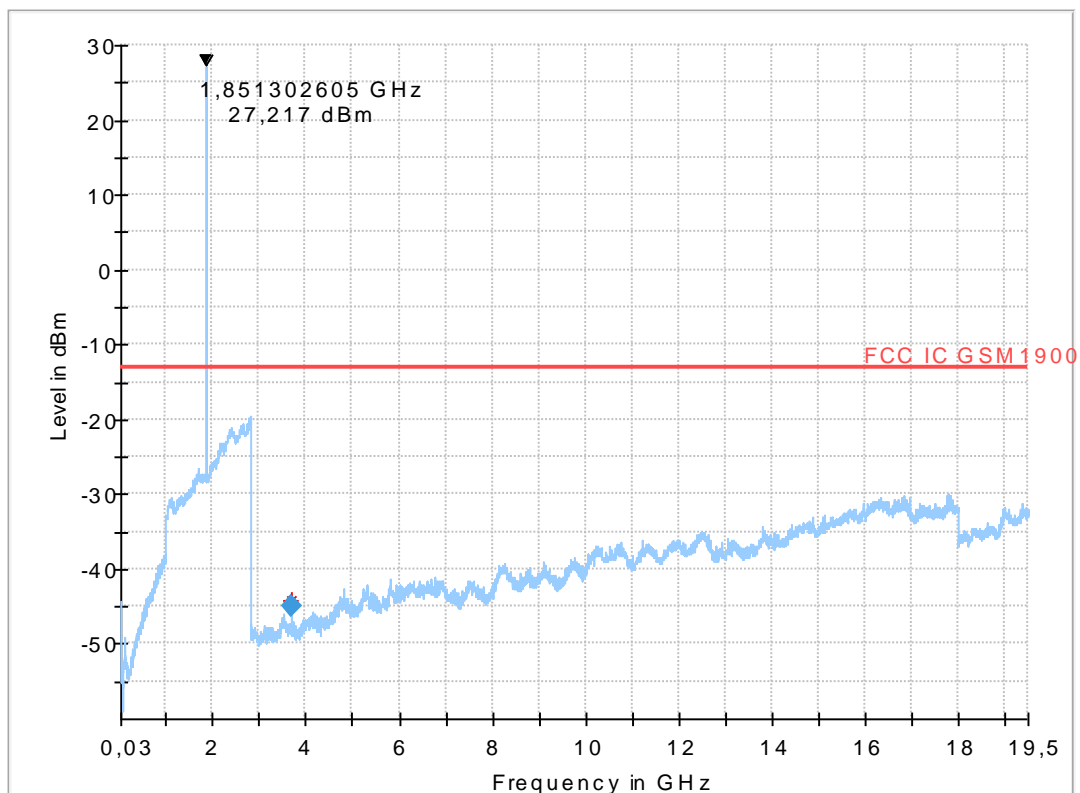

Final Result

Frequency (MHz)	Limit (dBm)	Margin (dB)	Meas. Time (ms)	Pol	Azimuth (deg)	Elevation (deg)	Corr. (dB)
3700.245491	-13.00	31.96	1000.0	H	275.0	90.0	-94.9

Diagram 8.14_RSE_R_Ch661_GPRS

Common Information

Test Description:	Radiated Emissions GSM850
Test Site Location:	CETECOM GmbH Essen
Test Site:	Fully Anechoic Room (FAR) - EMC32 V9.26.0
Test Standard:	FCC Part24.238
Test Case:	-
Operating Mode:	MS allocated UL channel 661
Exclusionband:	1850 - 1910MHz
Environmental Conditions:	Humidity: 50%rH; Temperature: 22°C
Operator:	AHo

EUT Information

Manufacturer:	u-blox AG
Model:	SARA-U201
Type:	GSM/WCDMA module

EUT:	-
HW version:	261A01
SW version:	23.56
SVN:	-
Config:	-
Serial number:	357520070020959
Connected Interfaces:	Antenna GSATT1505001611 and Headset
Power Supply:	3.8V DC
Comments:	-

Full Spectrum

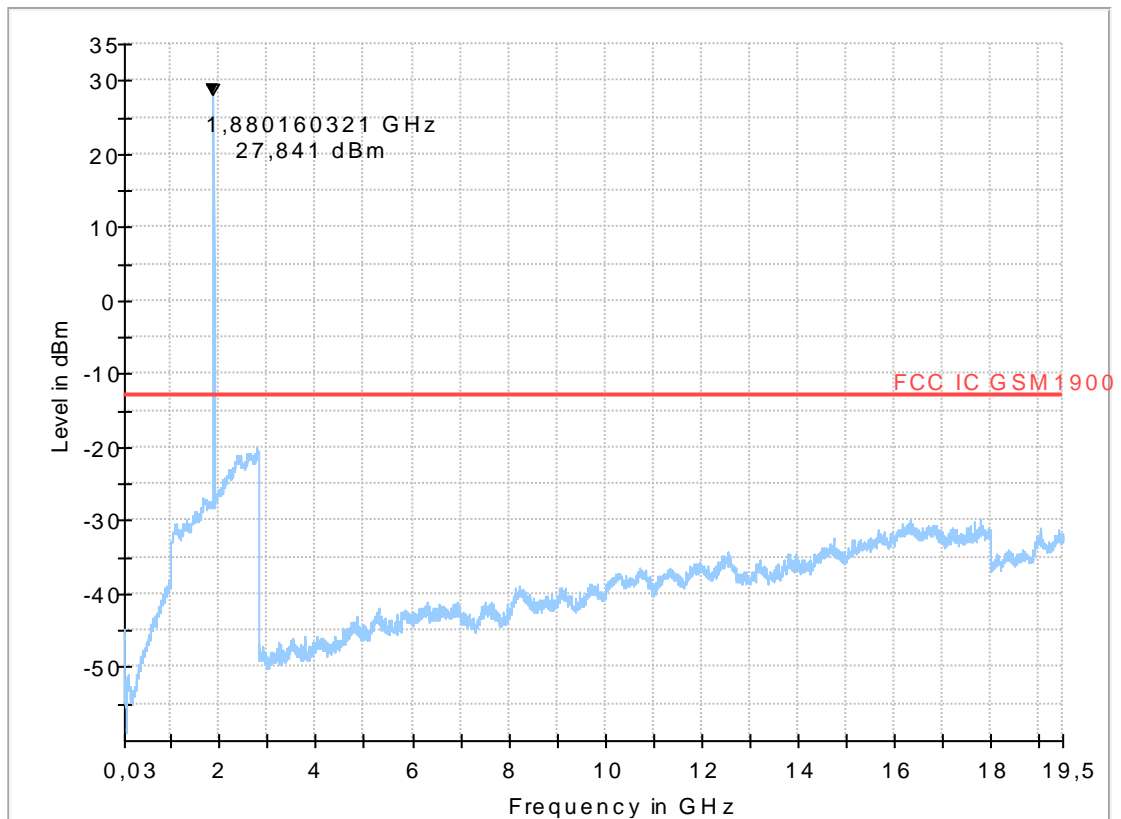

Diagram 8.15_RSE_R_Ch810_GPRS

Common Information

Test Description:	Radiated Spurious Emissions GSM1900
Test Site Location:	CETECOM GmbH Essen
Test Site:	Fully Anechoic Room (FAR) - EMC32 V9.26.0
Test Standard:	FCC Part24.238
Test Case:	-
Operating Mode:	MS allocated UL channel 810
Exclusionband:	1850 - 1910MHz
Environmental Conditions:	Humidity: 50%rH; Temperature: 22°C
Operator:	AHo

EUT Information

Manufacturer:	u-blox AG
Model:	SARA-U201
Type:	GSM/WCDMA module

EUT:	-
HW version:	261A01
SW version:	23.56
SVN:	-
Config:	-
Serial number:	357520070020959
Connected Interfaces:	Antenna GSATT1505001611 and Headset
Power Supply:	3.8V DC
Comments:	-

Full Spectrum

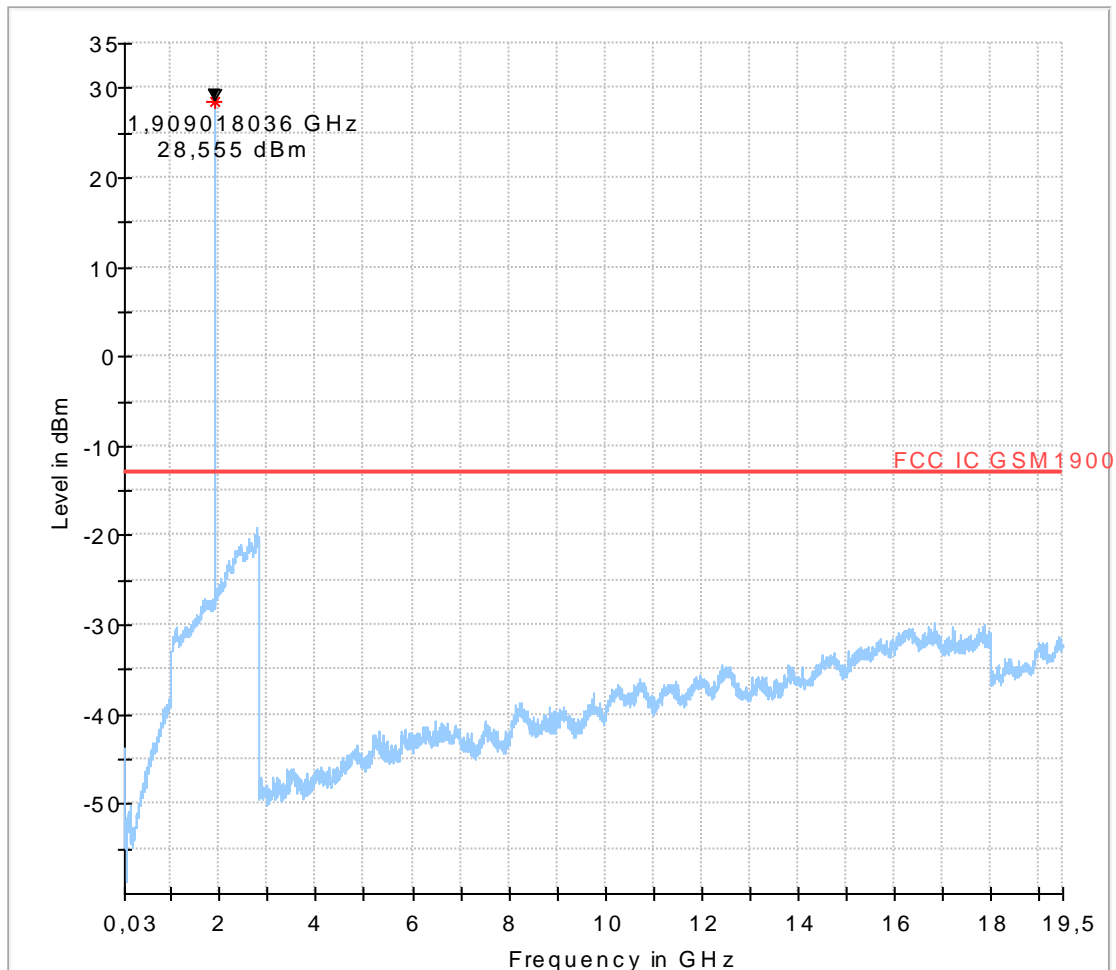

1.4. Radiated emissions on 850 MHz transmitting band-edge

Diagram: 9.03_RSE_R_Ch128_GPRS

Common Information

Test Description:	Radiated Band Edge Compliance GSM850
Test Site Location:	CETECOM GmbH Essen
Test Site:	Fully Anechoic Room (FAR) - EMC32 V9.26.0
Test Standard:	FCC Part22.917/RSS-132
Operating Mode:	MS allocated channel 128 (fc = 824.2MHz), Voice, PCL5 (+33dBm)
Exclusionband:	824 - 849MHz
Environmental Conditions:	Humidity: 49%rH; Temperature: 23°C
Operator:	AHo

EUT Information

Manufacturer:	u-blox AG
Model:	SARA-U201
Type:	GSM/WCDMA module

EUT:	-
HW version:	261A01
SW version:	23.56
SVN:	-
Config:	-
Serial number:	357520070020959
Connected Interfaces:	Antenna GSATT1505001611 and Headset
Power Supply:	3.8V DC
Comments:	-

Full Spectrum

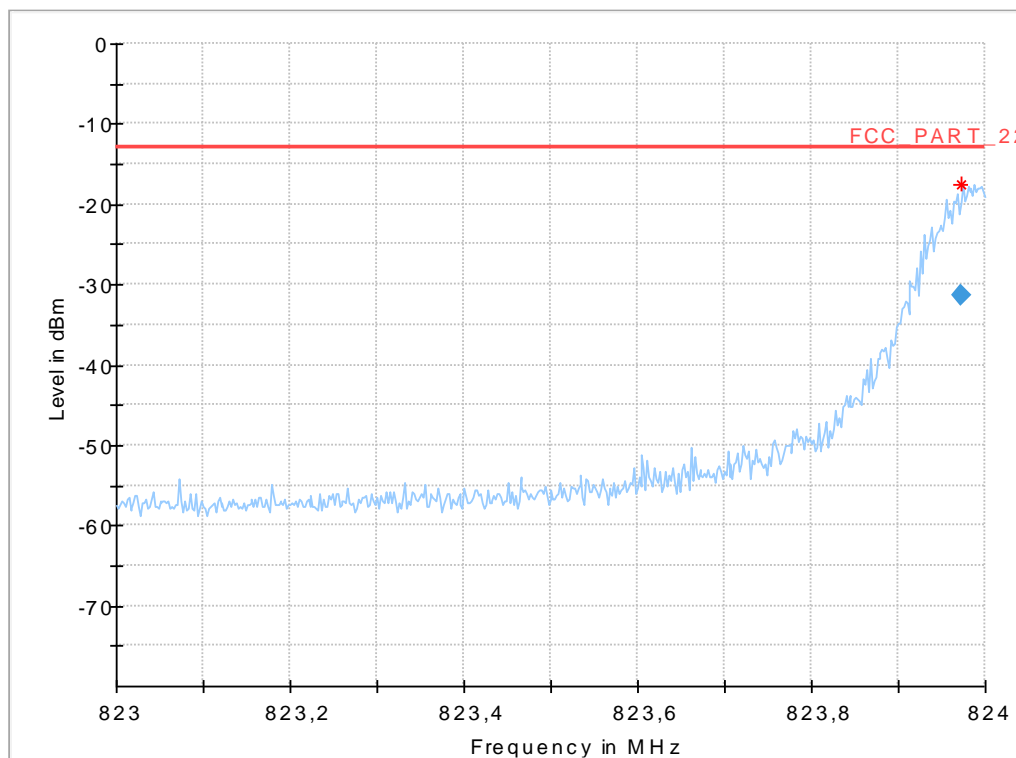

Final Result

Frequency (MHz)	Limit (dBm)	Margin (dB)	Meas. Time (ms)	Pol	Azimuth (deg)	Elevation (deg)	Corr. (dB)
823.971944	-13.00	18.29	10000.0	H	154.0	0.0	-75.8

Diagram 9.04_RSE_R_Ch251_GPRS

Common Information

Test Description:	Radiated Band Edge Compliance GSM850
Test Site Location:	CETECOM GmbH Essen
Test Site:	Fully Anechoic Room (FAR)
Test Standard:	FCC Part22.917/RSS-132
Operating Mode:	MS allocated channel 251 (fc = 848.8MHz), Voice, PCL0 (+33dBm)
Exclusionband:	824 - 849MHz
Environmental Conditions:	Humidity: 49%rH; Temperature: 23°C
Operator:	AHo

EUT Information

Manufacturer:	u-blox AG
Model:	SARA-U201
Type:	GSM/WCDMA module

EUT:	-
HW version:	261A01
SW version:	23.56
SVN:	-
Config:	-
Serial number:	357520070020959
Connected Interfaces:	Antenna GSATT1505001611 and Headset
Power Supply:	3.8V DC
Comments:	-

Full Spectrum

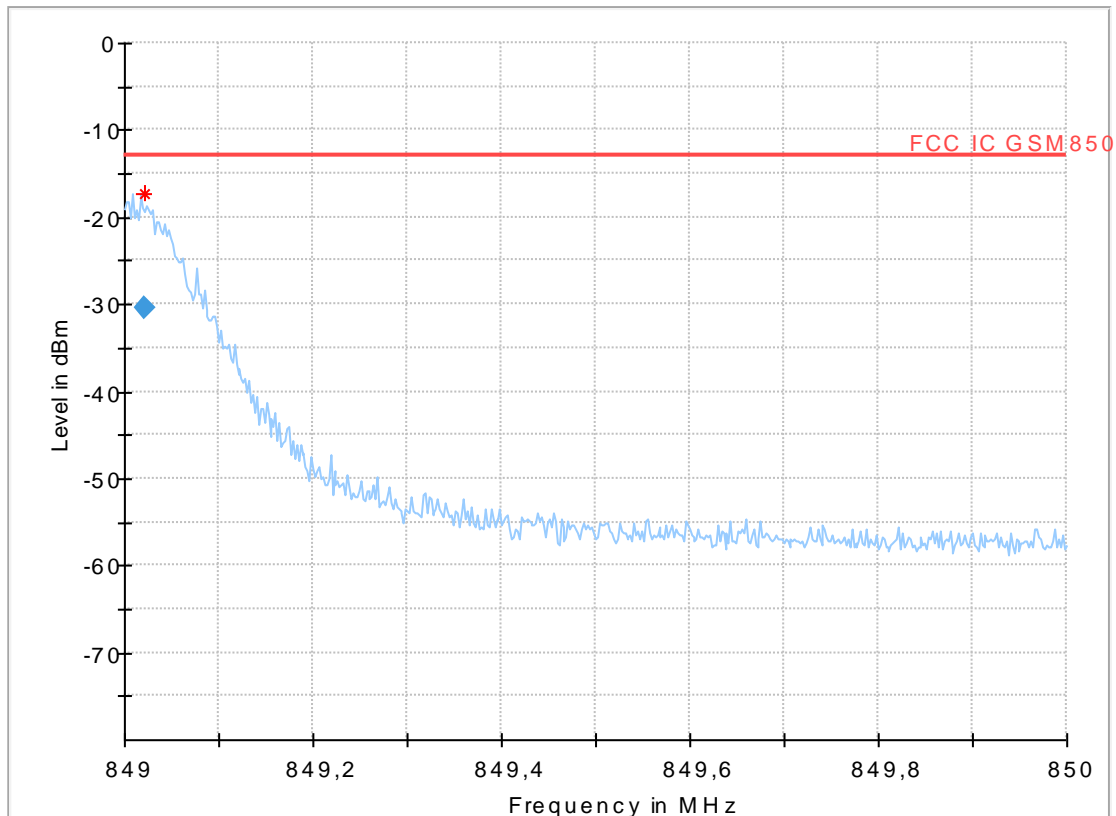

Final Result

Frequency (MHz)	Limit (dBm)	Margin (dB)	Meas. Time (ms)	Pol	Azimuth (deg)	Elevation (deg)	Corr. (dB)
849.022044	-13.00	17.39	10000.0	H	220.0	0.0	-76.0

1.5. Radiated emissions on 1900 MHz transmitting band-edge

Diagram 9.09_BE_R_Ch512_GPRS_1900

Common Information

Test Description:	Radiated Spurious Emissions GSM1900
Test Site Location:	CETECOM GmbH Essen
Test Site:	Fully Anechoic Room (FAR)
Test Standard:	FCC Part22.917 / RSS-133
Comm. Link:	GSM1900, Voice/EDGE
Operating Mode:	MS allocated channel 512 (UL = 1850.2MHz)
Exclusionband:	1850- 1910MHz
Environmental Conditions:	Humidity: 61%rH; Temperature: 22°C
Operator:	Ris

EUT Information

Manufacturer:	u-blox AG
Model:	SARA-U201
Type:	GSM/WCDMA module

EUT:	-
HW version:	261A01
SW version:	23.56
SVN:	-
Config:	-
Serial number:	357520070020959
Connected Interfaces:	Antenna GSATT1505001611 and Headset
Power Supply:	3.8V DC
Comments:	-

Full Spectrum

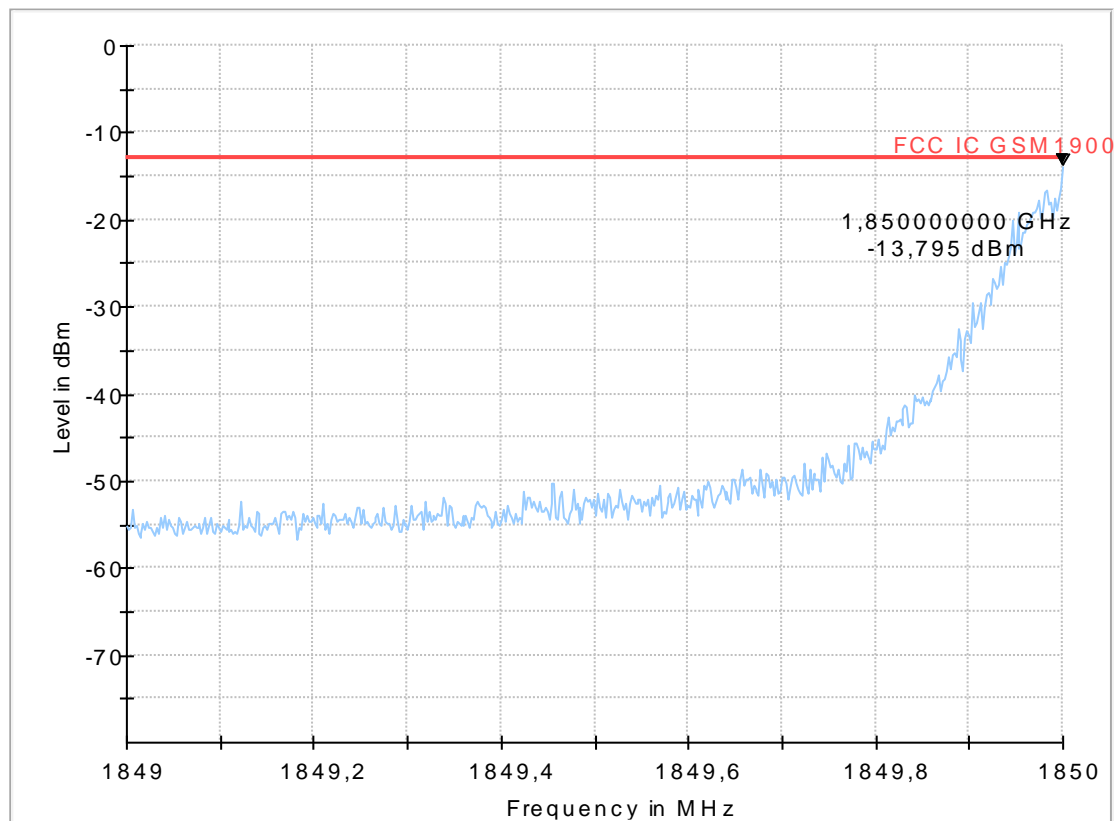

Diagram 9.10_BE_R_Ch810_GPRS_1900

Common Information

Test Description:	Radiated Spurious Emissions GSM1900
Test Site Location:	CETECOM GmbH Essen
Test Site:	Fully Anechoic Room (FAR)
Test Standard:	FCC Part 24.238
Comm. Link:	GSM1900, Voice/EDGE
Operating Mode:	MS allocated channel 810 (UL = 1909.8MHz)
Exclusionband:	1850- 1910MHz
Environmental Conditions:	Humidity: 61%rH; Temperature: 22°C
Operator:	RIs

EUT Information

Manufacturer:	u-blox AG
Model:	SARA-U201
Type:	GSM/WCDMA module

EUT:	-
HW version:	261A01
SW version:	23.56
SVN:	-
Config:	-
Serial number:	357520070020959
Connected Interfaces:	Antenna GSATT1505001611 and Headset
Power Supply:	3.8V DC
Comments:	-

Full Spectrum

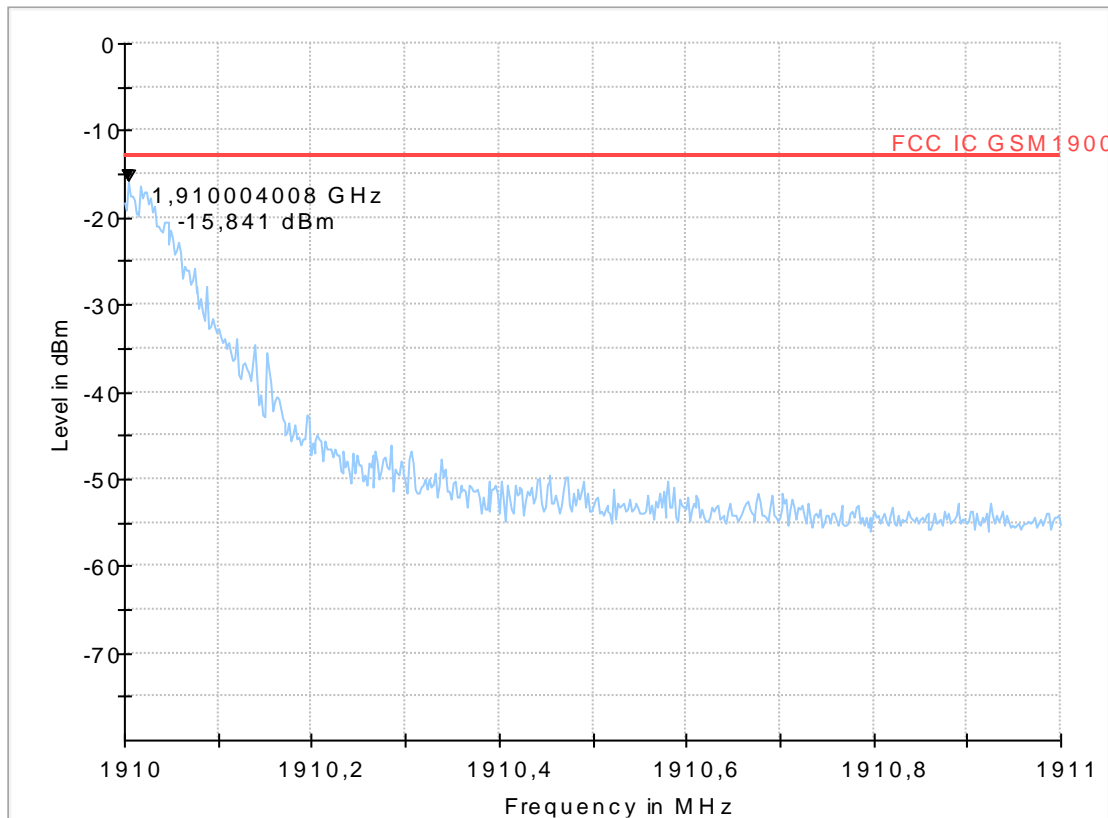

Diagram 9.11_BE_R_Ch512_EGPRS

Common Information

Test Description:	Radiated Spurious Emissions GSM1900
Test Site Location:	CETECOM GmbH Essen
Test Site:	Fully Anechoic Room (FAR)
Test Standard:	FCC Part 24.238
Comm. Link:	EGPRS
Operating Mode:	MS allocated channel 512 (UL = 1850.2MHz)
Exclusionband:	1850- 1910MHz
Environmental Conditions:	Humidity: 59%rH; Temperature: 22°C
Operator:	RLs

EUT Information

Manufacturer:	u-blox AG
Model:	SARA-U201
Type:	GSM/WCDMA module

EUT:	-
HW version:	261A01
SW version:	23.56
SVN:	-
Config:	-
Serial number:	357520070020959
Connected Interfaces:	Antenna GSATT1505001611 and Headset
Power Supply:	3.8V DC
Comments:	-

Full Spectrum



Diagramm 9.12_BE_R_Ch810_EGPRS

Common Information

Test Description:	Radiated Spurious Emissions GSM1900
Test Site Location:	CETECOM GmbH Essen
Test Site:	Fully Anechoic Room (FAR)
Test Standard:	FCC Part 24.238
Comm. Link:	EGPRS
Operating Mode:	MS allocated channel 810 (UL = 1909.8MHz)
Exclusionband:	1850- 1910MHz
Environmental Conditions:	Humidity: 60%rH; Temperature: 22°C
Operator:	RLs

EUT Information

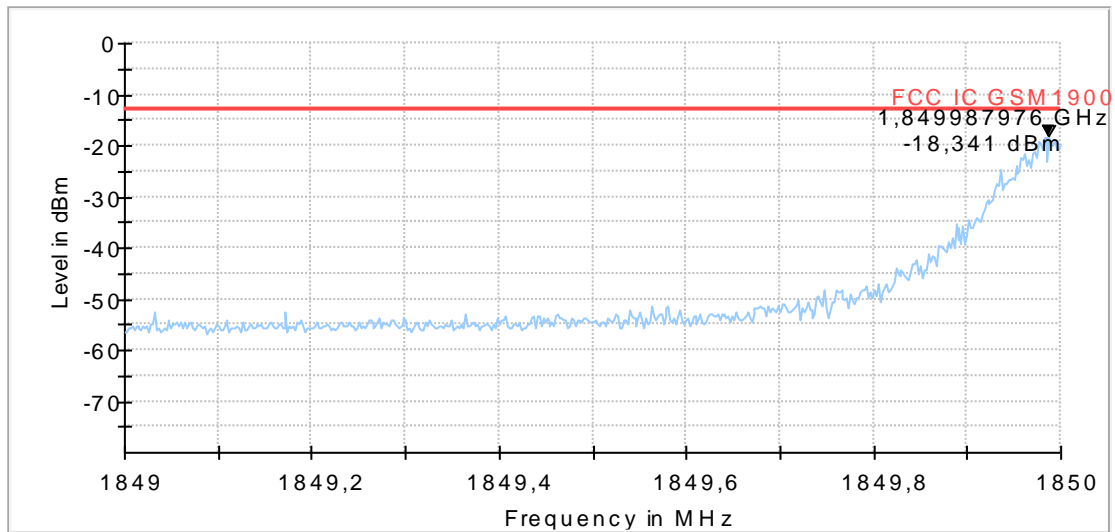
Manufacturer:	u-blox AG
Model:	SARA-U201
Type:	GSM/WCDMA module

EUT:	-
HW version:	261A01
SW version:	23.56
SVN:	-
Config:	-
Serial number:	357520070020959
Connected Interfaces:	Antenna GSATT1505001611 and Headset
Power Supply:	3.8V DC
Comments:	-

Full Spectrum

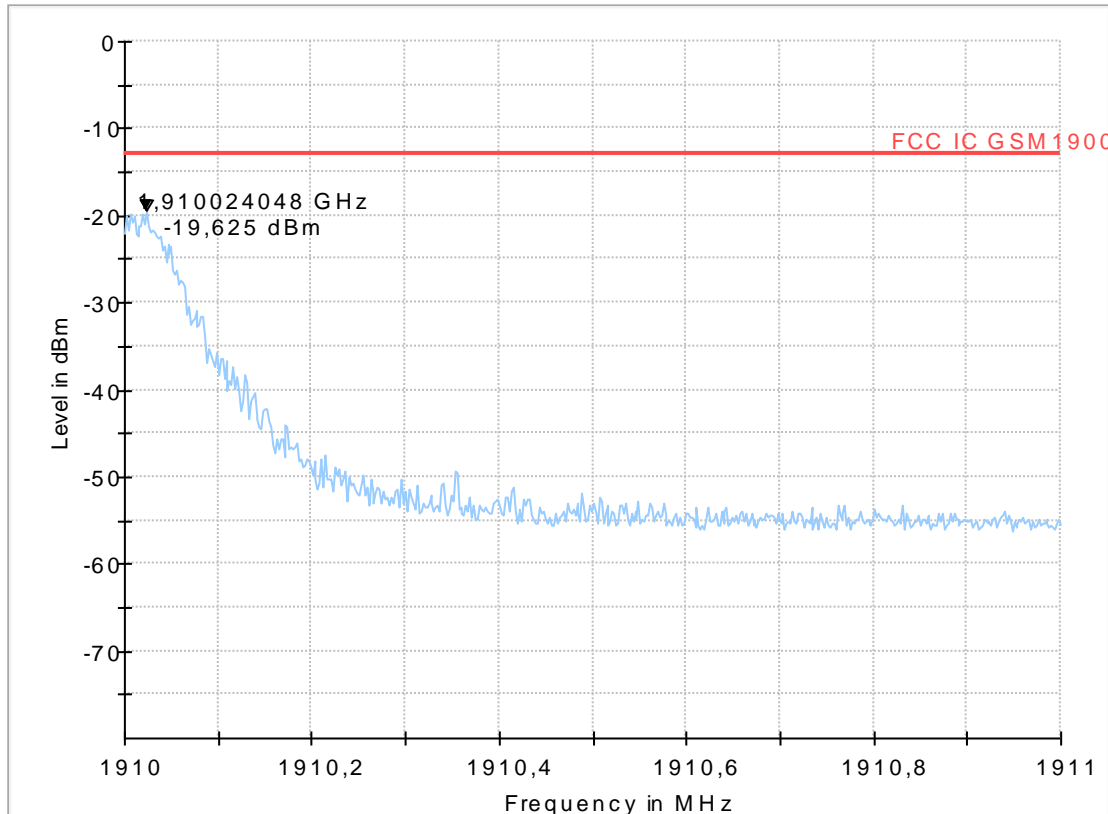

1.6. Power Measurements and PAPR-Value

1.6.1. GSM 850 (GMSK Modulation)

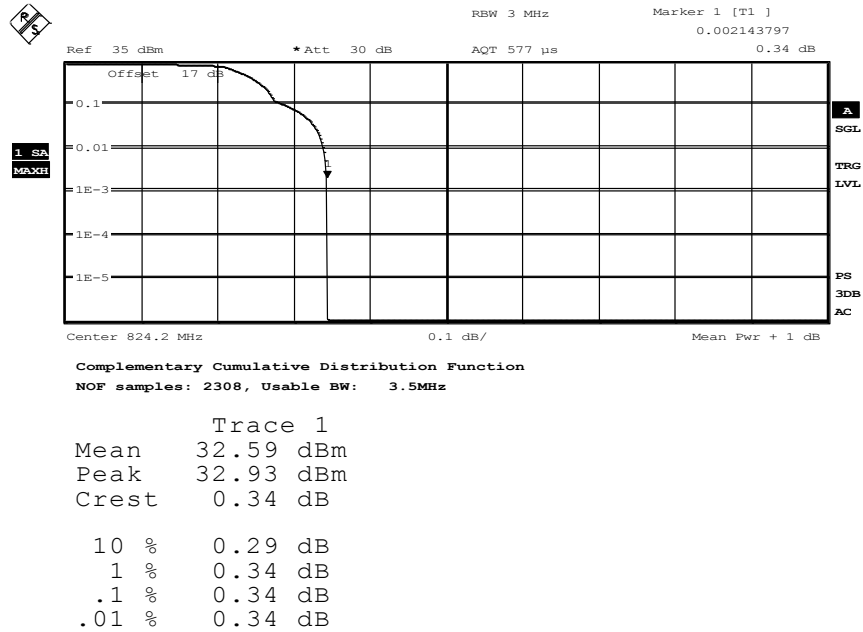

Date: 15.JUN.2016 14:19:06

Channel 128

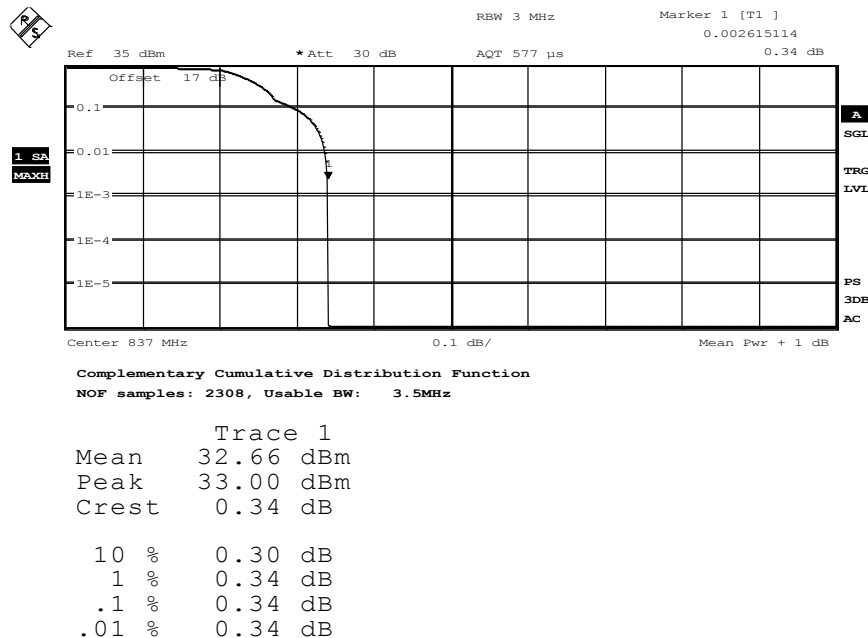

Date: 15.JUN.2016 14:18:21

Channel 192

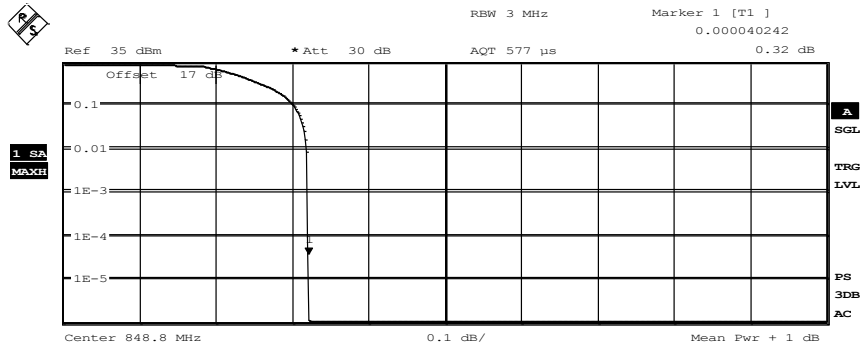

Complementary Cumulative Distribution Function
 NOF samples: 2308, Usable BW: 3.5MHz

Trace 1
 Mean 32.82 dBm
 Peak 33.14 dBm
 Crest 0.32 dB

10 %	0.30 dB
1 %	0.32 dB
.1 %	0.32 dB
.01 %	0.32 dB

Date: 15.JUN.2016 14:17:50

Channel 251

1.6.2. GSM 850 (8-PSK Modulation)

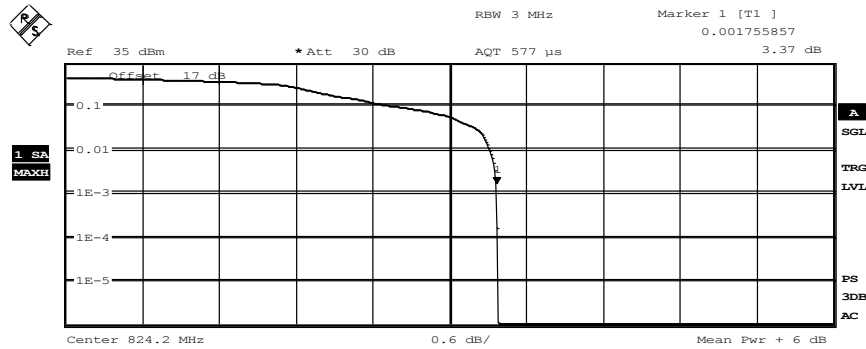

Complementary Cumulative Distribution Function
 NOF samples: 2308, Usable BW: 3.5MHz

Trace 1	
Mean	26.81 dBm
Peak	30.18 dBm
Crest	3.37 dB
10 %	2.63 dB
1 %	3.32 dB
.1 %	3.37 dB
.01 %	3.38 dB

Date: 15.JUN.2016 14:11:49

Channel 128

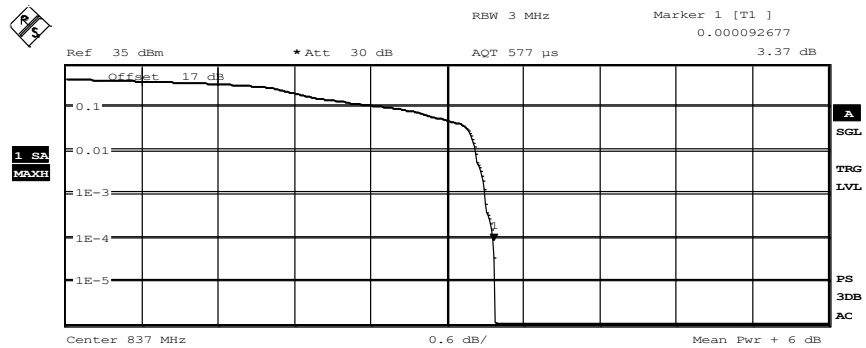

Complementary Cumulative Distribution Function
 NOF samples: 2308, Usable BW: 3.5MHz

Trace 1	
Mean	27.02 dBm
Peak	30.39 dBm
Crest	3.38 dB
10 %	2.61 dB
1 %	3.23 dB
.1 %	3.30 dB
.01 %	3.37 dB

Date: 15.JUN.2016 14:12:44

Channel 192



Complementary Cumulative Distribution Function
 NOF samples: 2308, Usable BW: 3.5MHz

Trace 1	
Mean	26.96 dBm
Peak	30.46 dBm
Crest	3.50 dB
10 %	2.64 dB
1 %	3.39 dB
.1 %	3.49 dB
.01 %	3.51 dB

Date: 15.JUN.2016 14:13:58

Channel 251

1.6.3. GSM 1900 (GMSK Modulation)

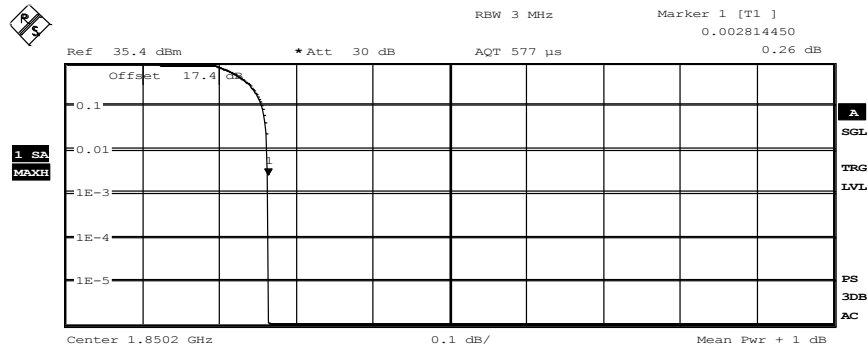

Complementary Cumulative Distribution Function
 NOF samples: 2308, Usable BW: 3.5MHz

Trace 1	
Mean	30.25 dBm
Peak	30.51 dBm
Crest	0.26 dB
10 %	0.25 dB
1 %	0.26 dB
.1 %	0.26 dB
.01 %	0.26 dB

Date: 15.JUN.2016 14:22:49

Channel 512

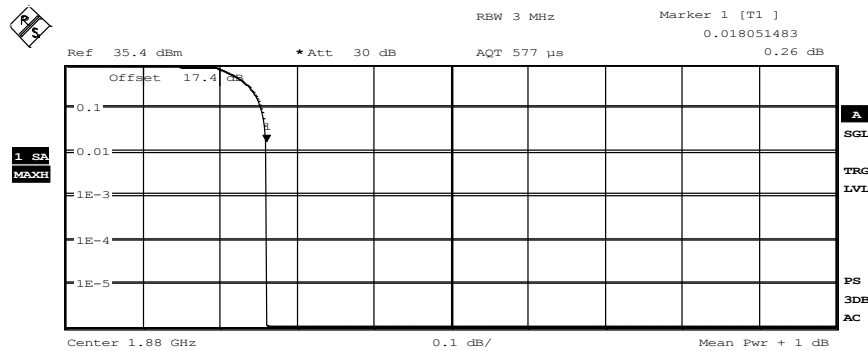

Complementary Cumulative Distribution Function
 NOF samples: 2308, Usable BW: 3.5MHz

Trace 1	
Mean	30.25 dBm
Peak	30.51 dBm
Crest	0.26 dB
10 %	0.25 dB
1 %	0.26 dB
.1 %	0.26 dB
.01 %	0.26 dB

Date: 15.JUN.2016 14:23:56

Channel 661

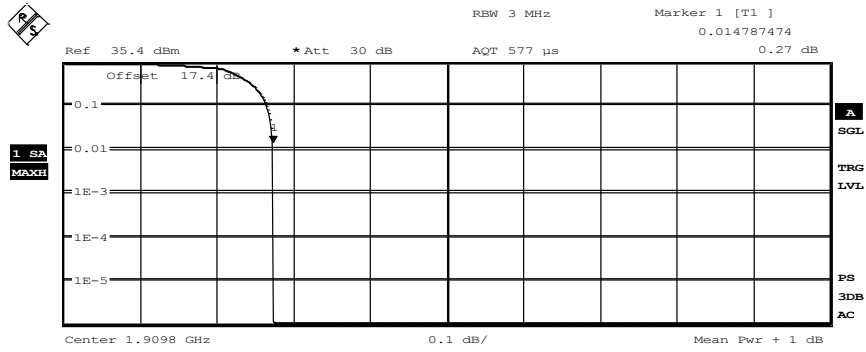

Complementary Cumulative Distribution Function
 NOF samples: 2308, Usable BW: 3.5MHz

Trace 1	
Mean	30.59 dBm
Peak	30.86 dBm
Crest	0.27 dB
10 %	0.26 dB
1 %	0.27 dB
.1 %	0.27 dB
.01 %	0.27 dB

Date: 15.JUN.2016 14:24:31

Channel 810

1.6.4. GSM 1900 (8-PSK Modulation)

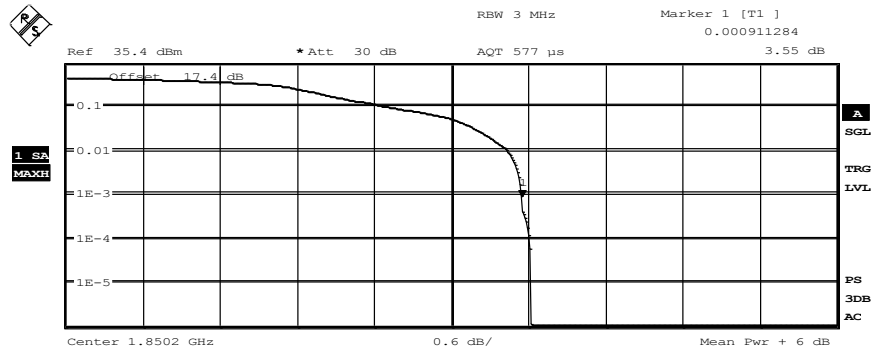

Complementary Cumulative Distribution Function
 NOF samples: 2308, Usable BW: 3.5MHz

Trace 1	
Mean	25.97 dBm
Peak	29.59 dBm
Crest	3.62 dB
10 %	2.53 dB
1 %	3.43 dB
.1 %	3.55 dB
.01 %	3.61 dB

Date: 15.JUN.2016 14:29:00

Channel 512

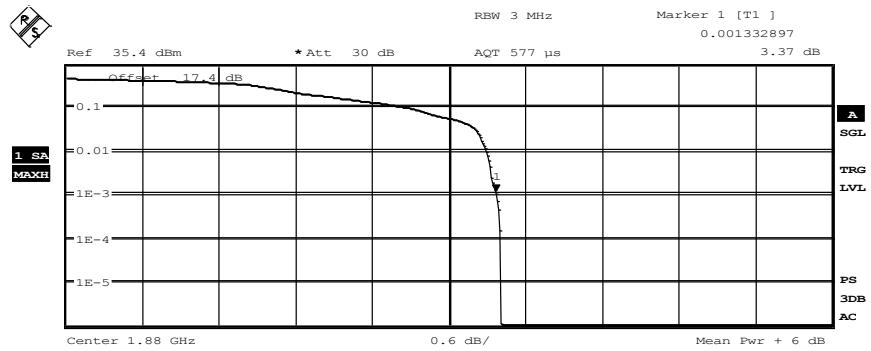

Complementary Cumulative Distribution Function
 NOF samples: 2308, Usable BW: 3.5MHz

Trace 1	
Mean	26.26 dBm
Peak	29.66 dBm
Crest	3.40 dB
10 %	2.71 dB
1 %	3.30 dB
.1 %	3.38 dB
.01 %	3.40 dB

Date: 15.JUN.2016 14:28:13

Channel 661

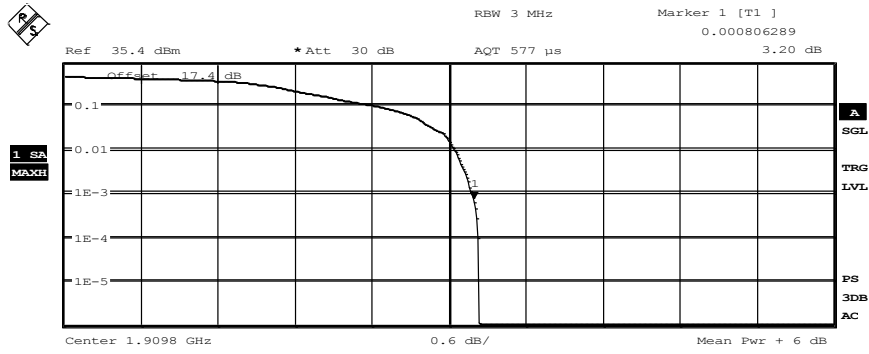

Complementary Cumulative Distribution Function
 NOF samples: 2308, Usable BW: 3.5MHz

Trace 1	
Mean	26.64 dBm
Peak	29.87 dBm
Crest	3.23 dB
10 %	2.47 dB
1 %	3.05 dB
.1 %	3.18 dB
.01 %	3.23 dB

Date: 15.JUN.2016 14:27:29

Channel 810

1.7. 26dBc Emission bandwidth

1.7.1. GPRS 850 MHz TX-Mode (GMSK)

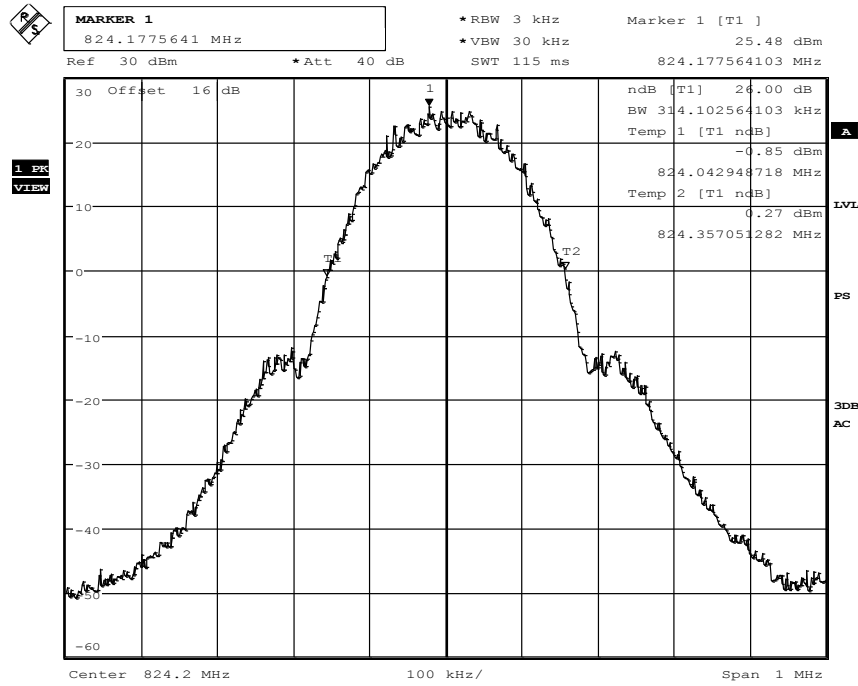

Date: 15.JUN.2016 12:19:57

Channel 128

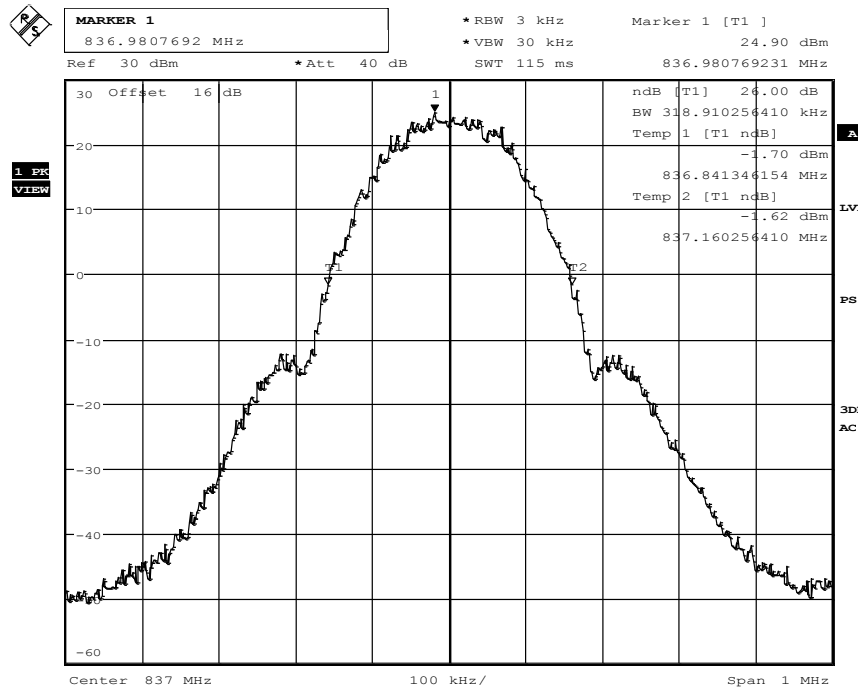

Date: 15.JUN.2016 12:23:59

Channel 192

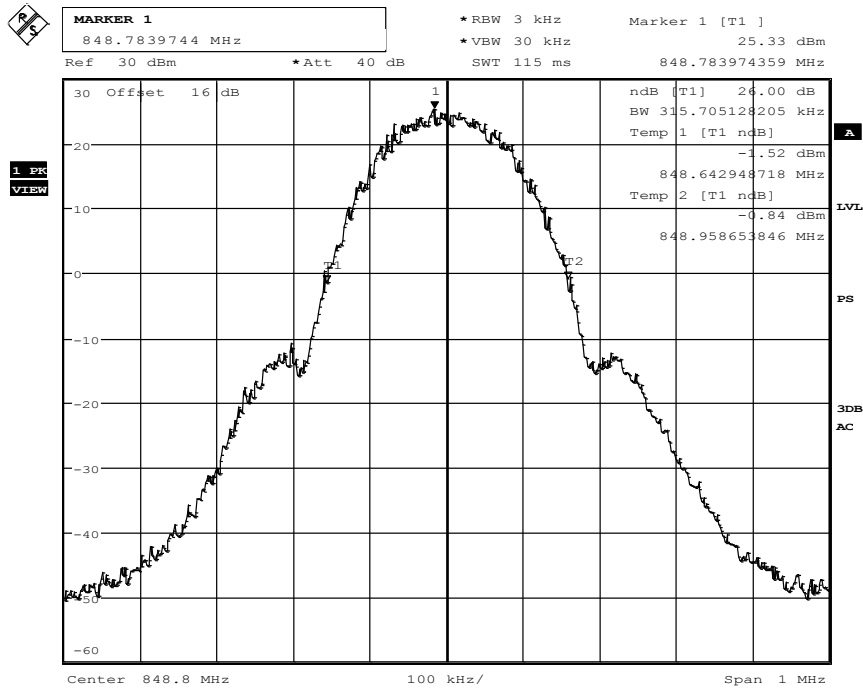

Date: 15.JUN.2016 12:29:03

Channel 251

1.7.2. E-GPRS 850 MHz TX-Mode (8PSK)

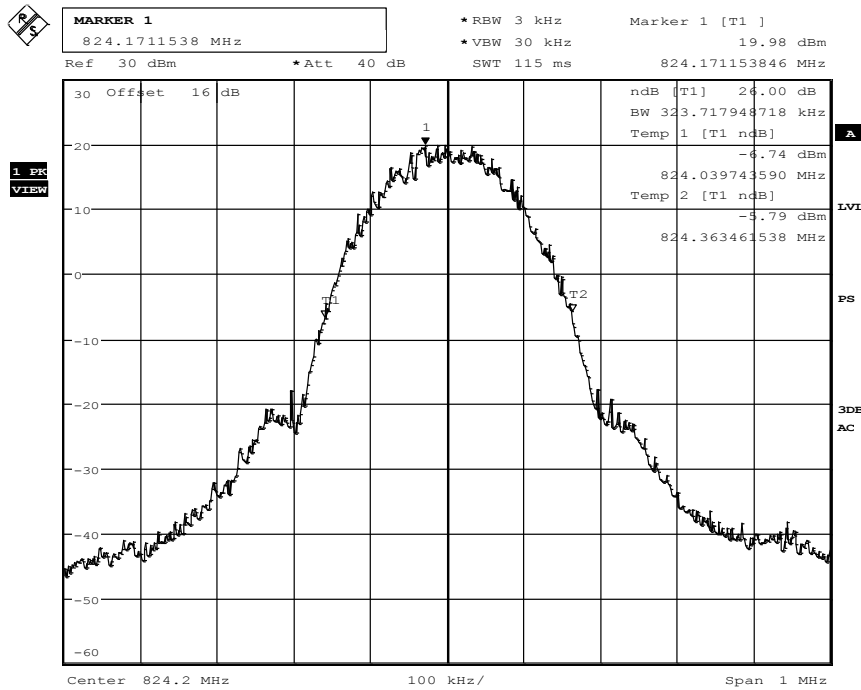

Date: 15.JUN.2016 13:18:36

Channel 128

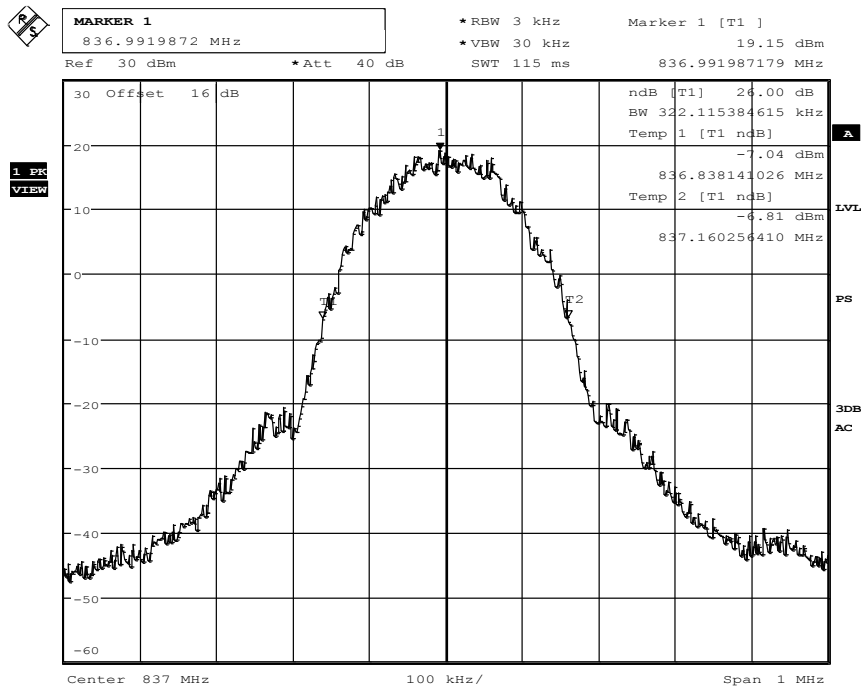

Date: 15.JUN.2016 13:12:19

Channel 192

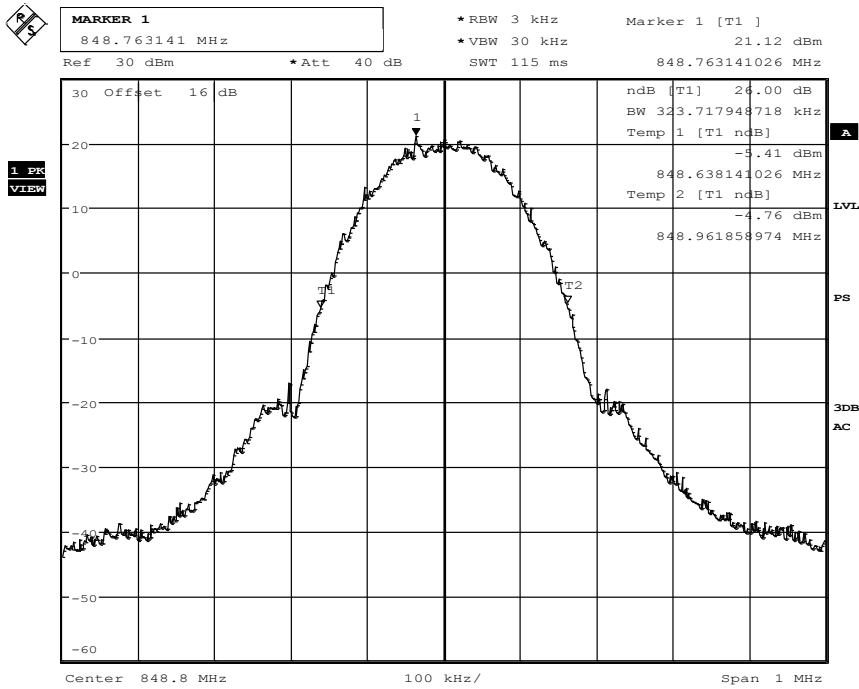

Date: 15.JUN.2016 13:05:42

Channel 251

1.7.3. GPRS 1900 MHz TX-Mode

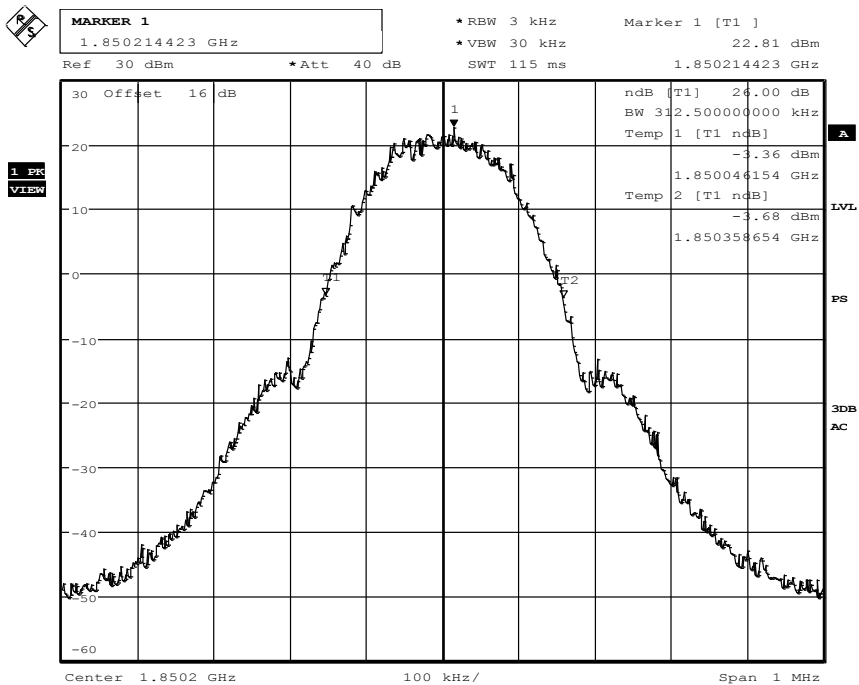

Date: 15.JUN.2016 10:45:47

Channel 512

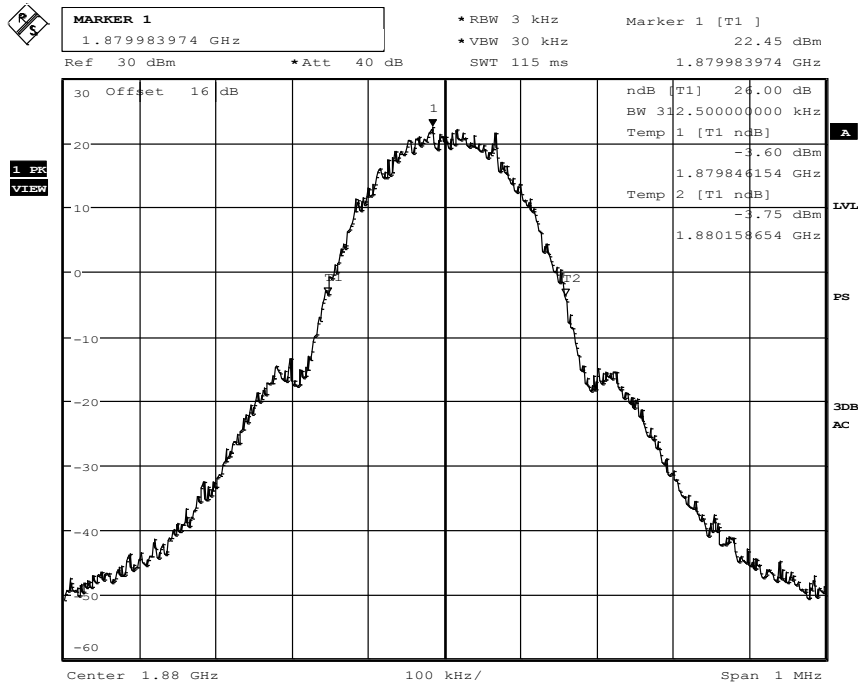

Date: 15.JUN.2016 10:49:34

Channel 661

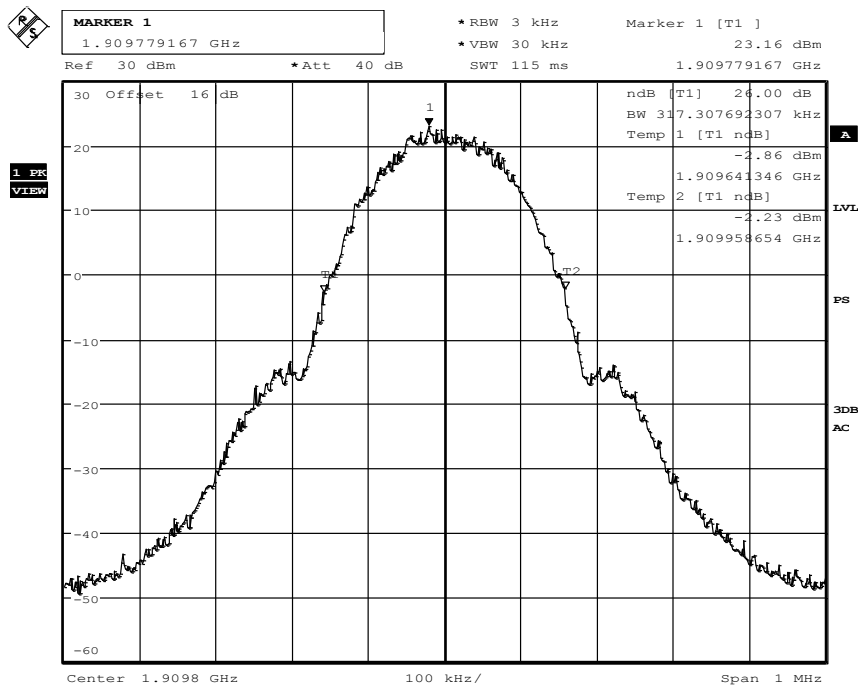

Date: 15.JUN.2016 10:55:56

Channel 810

1.7.4.E-GPRS 1900 MHz TX-Mode

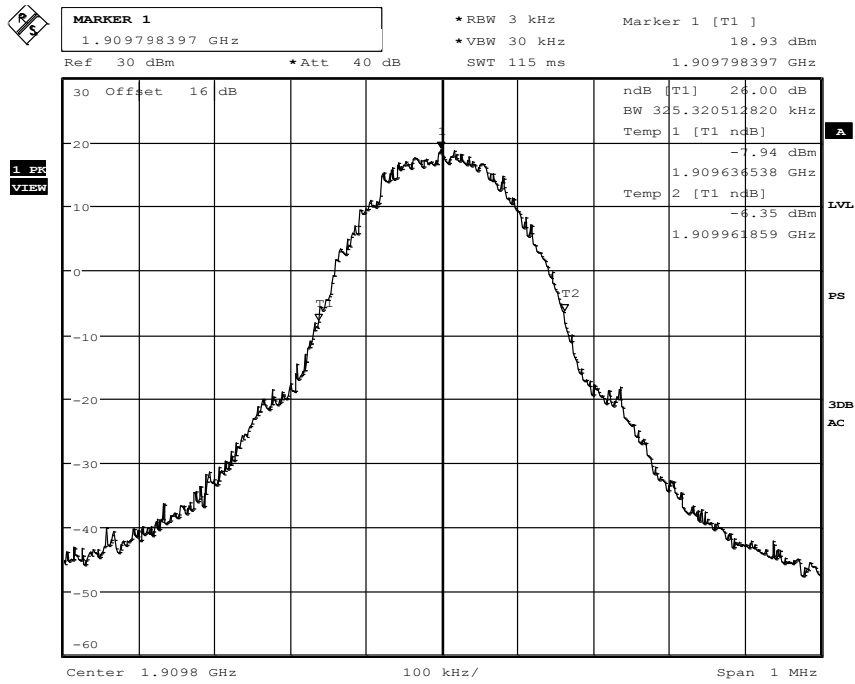

Date: 15.JUN.2016 11:05:20

Channel 512

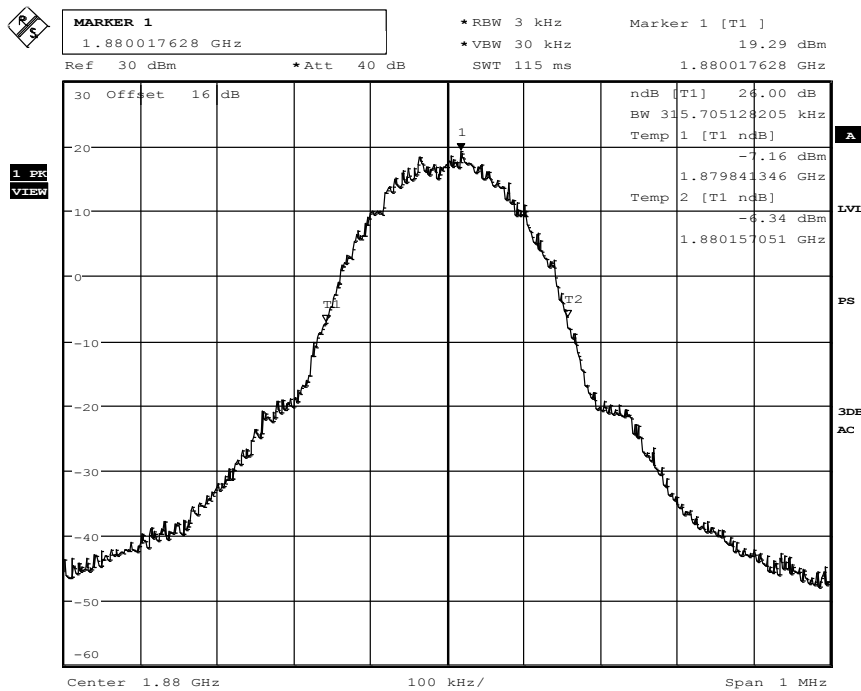

Date: 15.JUN.2016 11:10:39

Channel 661

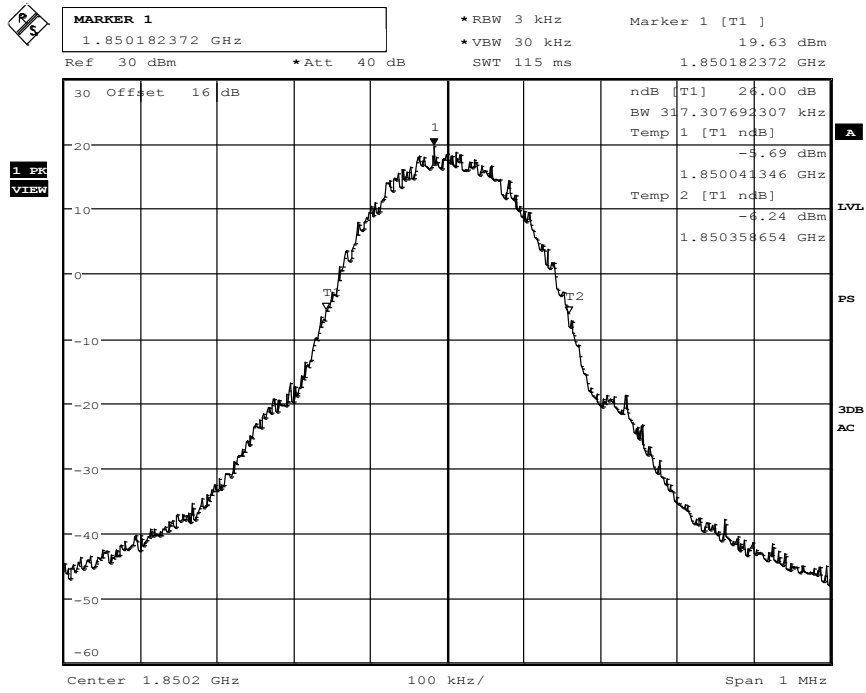

Date: 15.JUN.2016 11:17:00

Channel 810

1.8. 99% Occupied bandwidth

1.8.1. GPRS 850 MHz TX-Mode

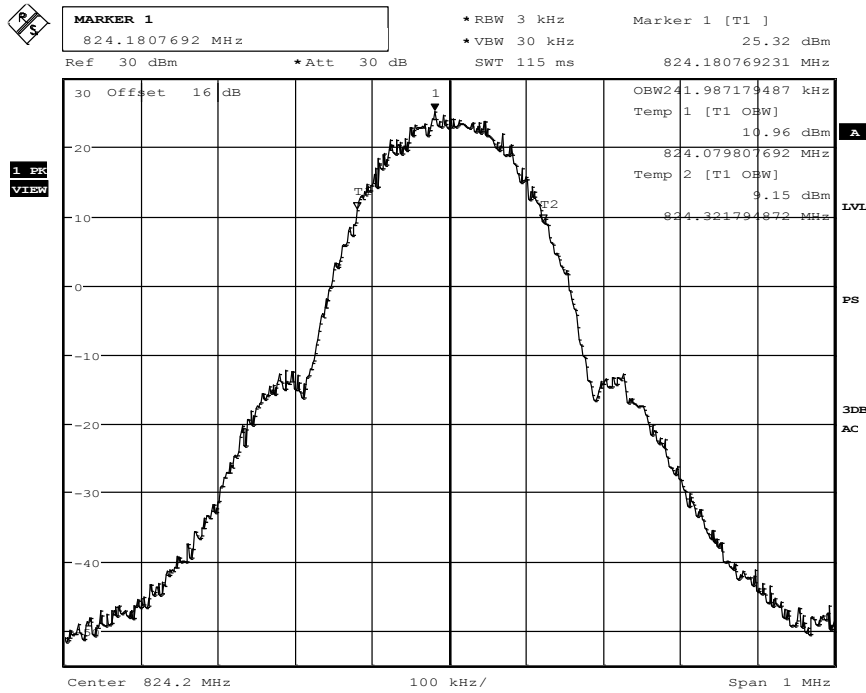

Date: 15.JUN.2016 12:15:27

Channel 128

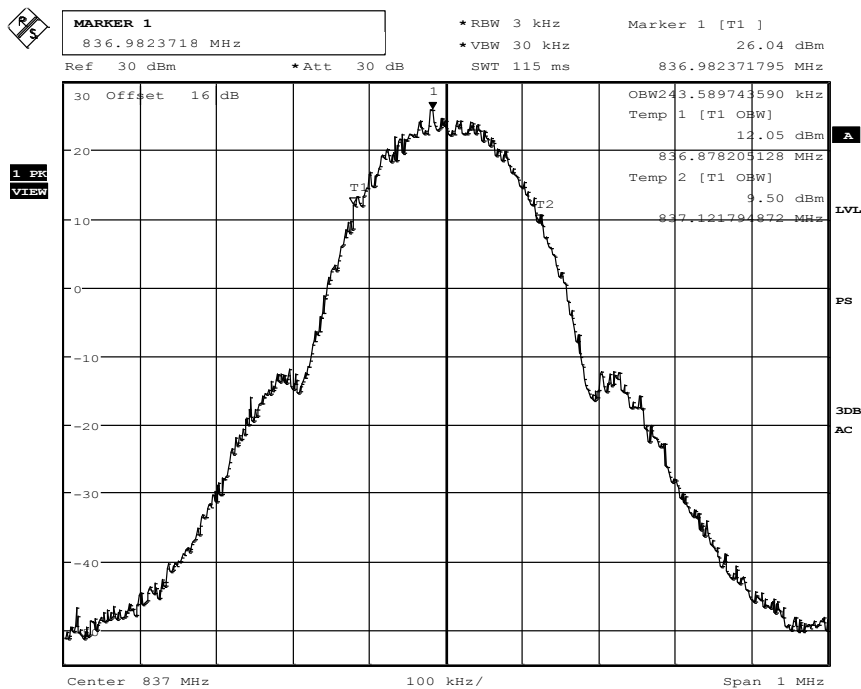

Date: 15.JUN.2016 12:11:55

Channel 192

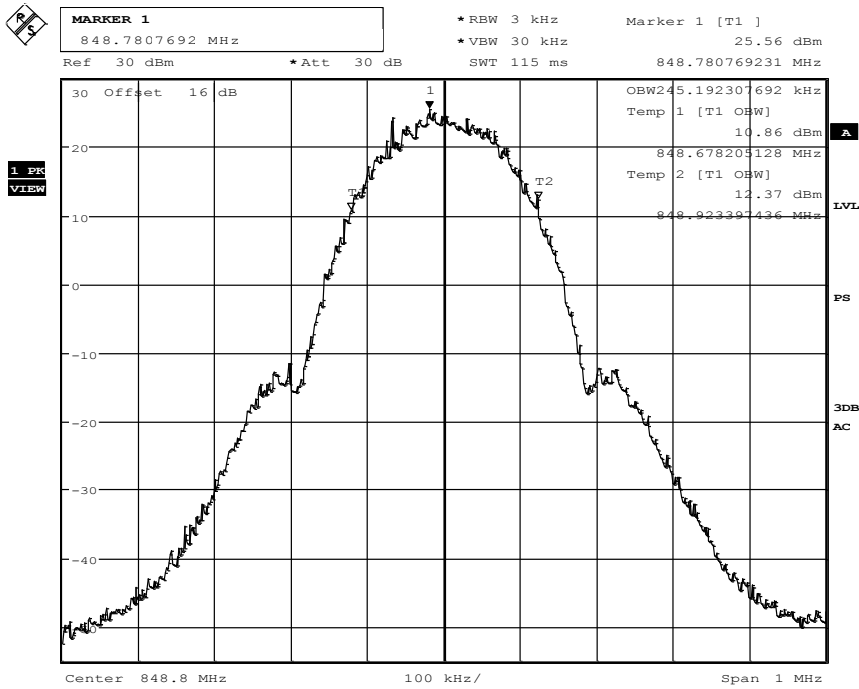

Date: 15.JUN.2016 12:07:20

Channel 251

1.8.2. E-GPRS 850 MHz TX-Mode

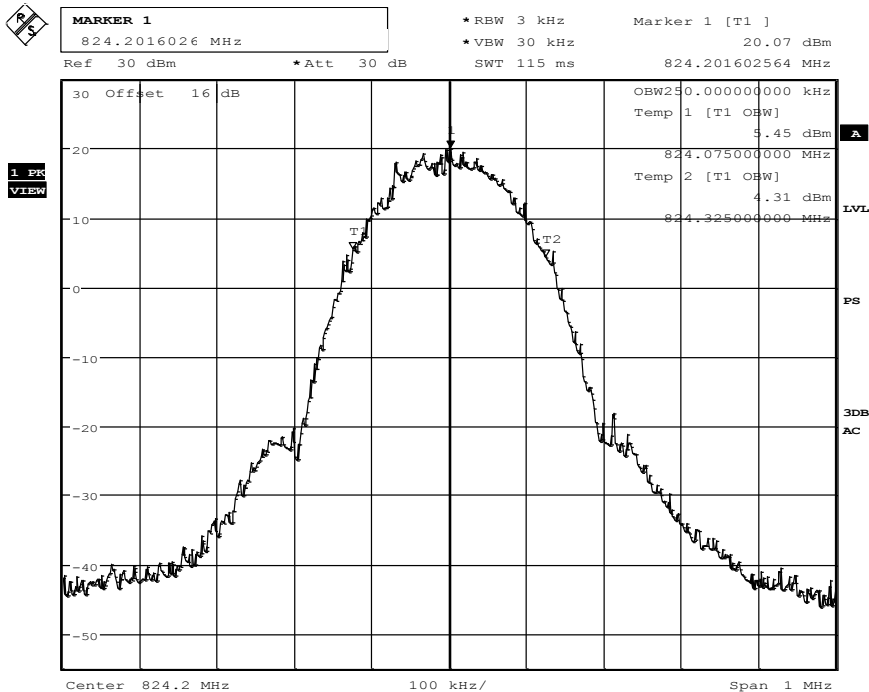

Date: 15.JUN.2016 13:24:09

Channel 128

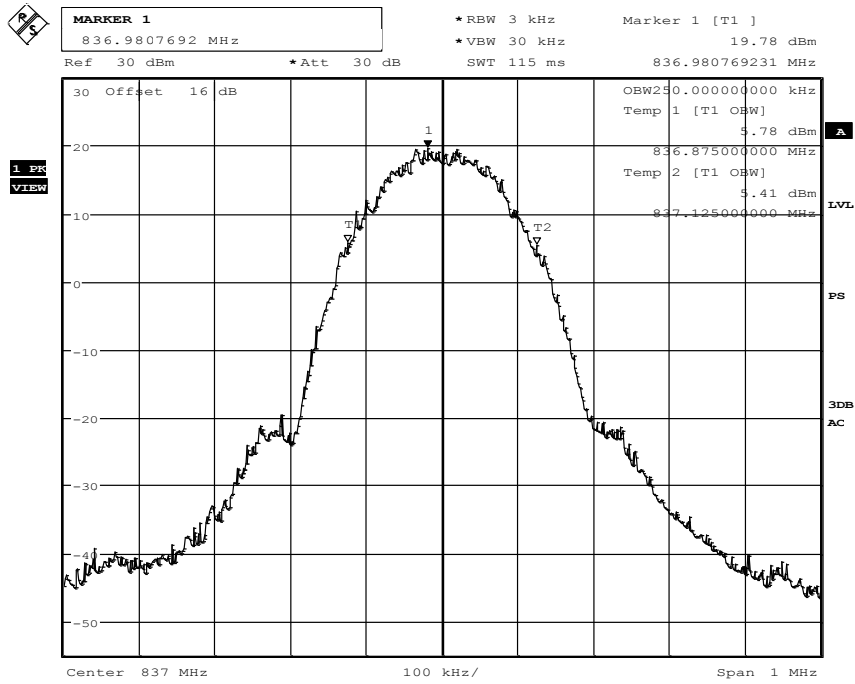

Date: 15.JUN.2016 13:30:01

Channel 192

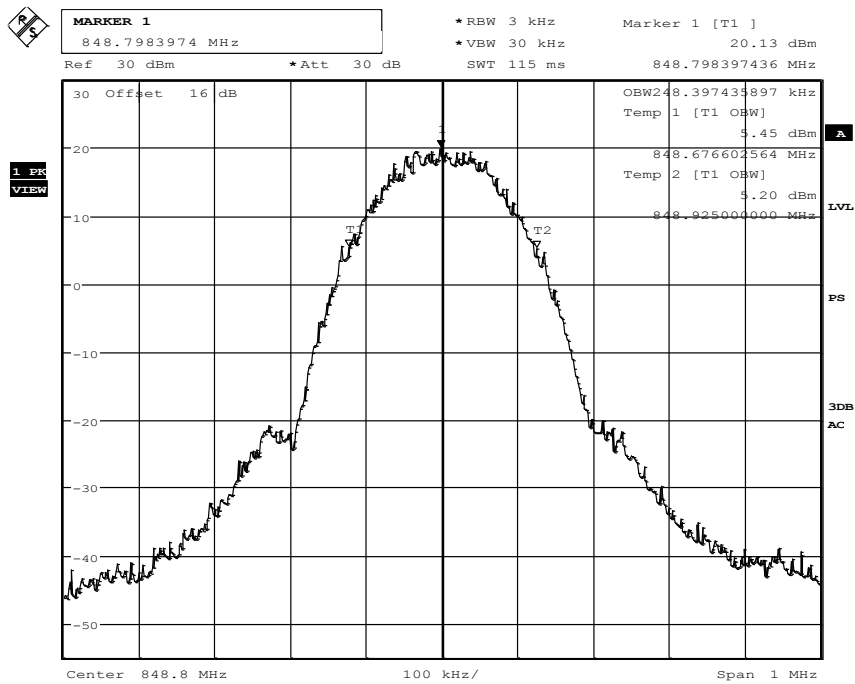

Date: 15.JUN.2016 13:34:48

Channel 251

1.8.3. GPRS 1900 MHz TX-Mode

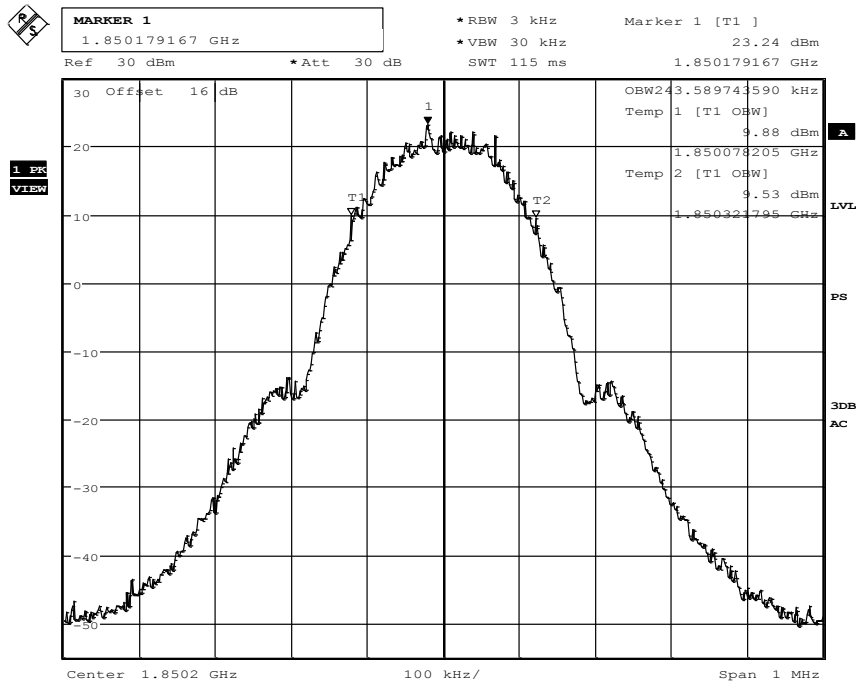

Date: 15.JUN.2016 11:49:36

Channel 512

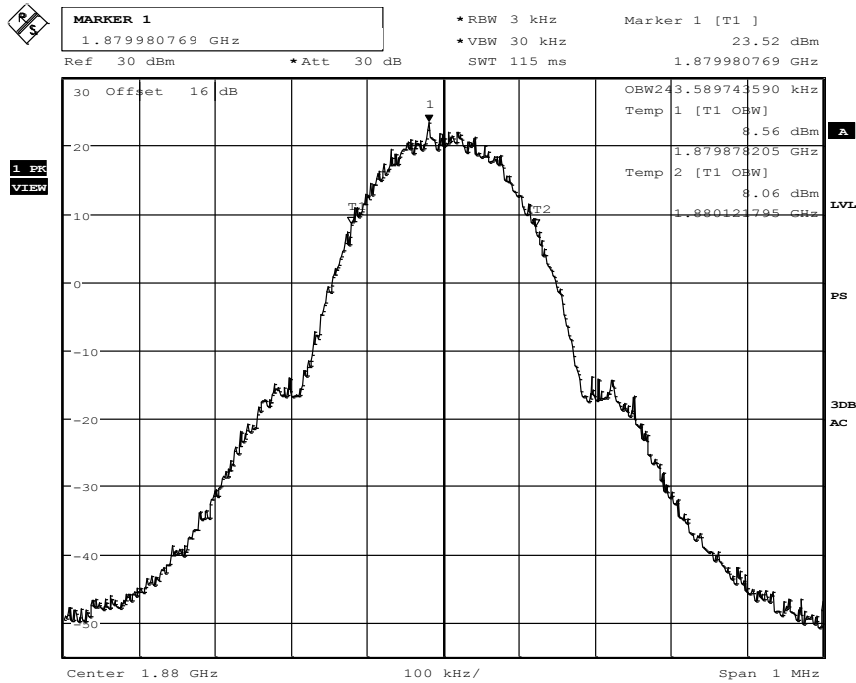

Date: 15.JUN.2016 11:44:56

Channel 661

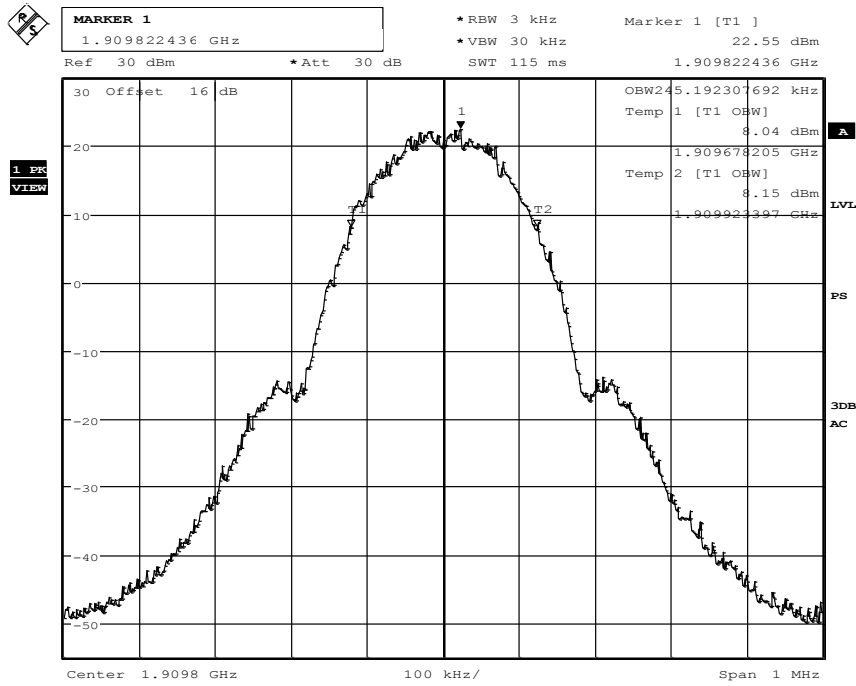

Date: 15.JUN.2016 11:39:05

Channel 810

1.8.4. E-GPRS 1900 MHz TX-Mode

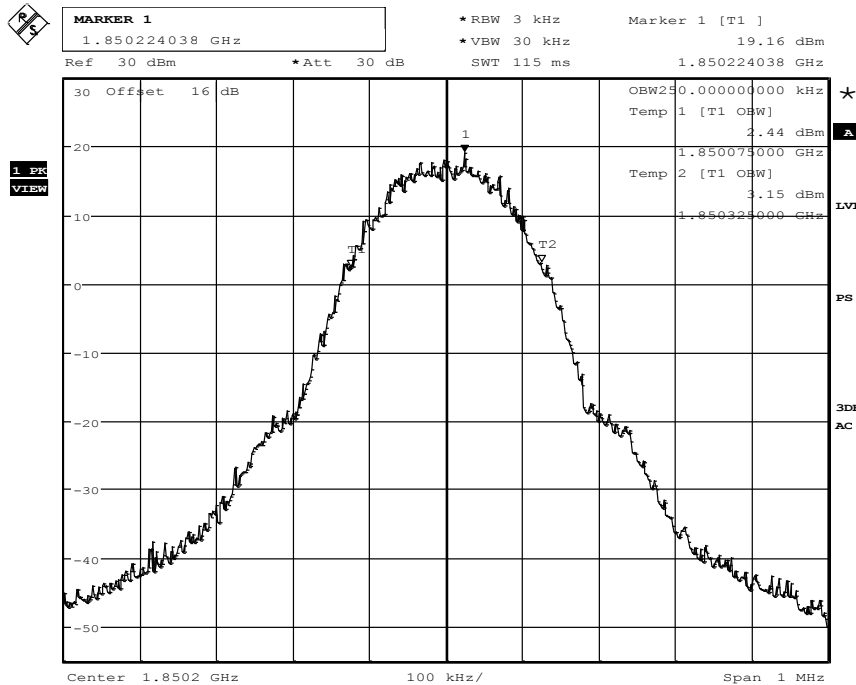

Date: 15.JUN.2016 11:21:57

Channel 512

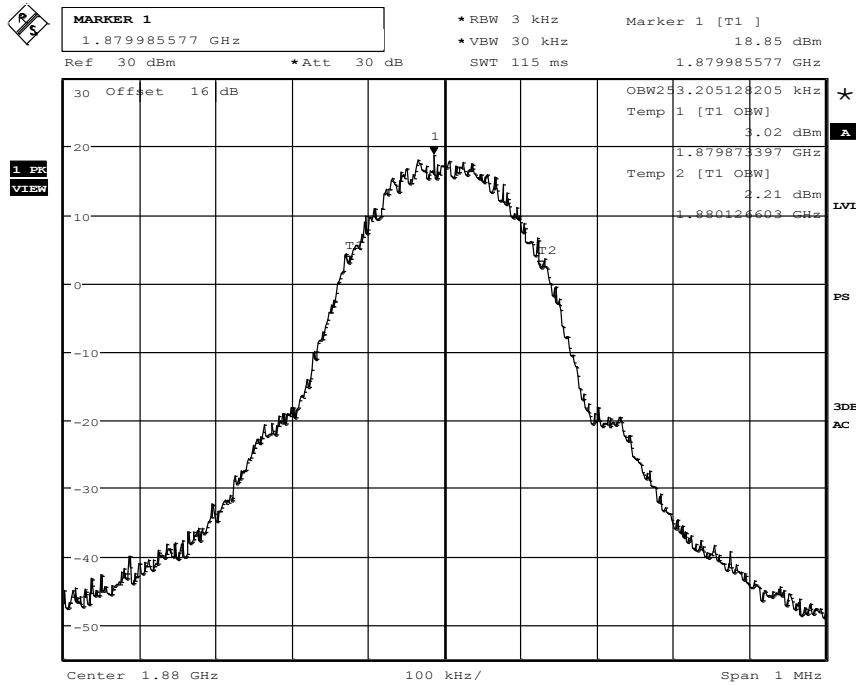

Date: 15.JUN.2016 11:27:04

Channel 661

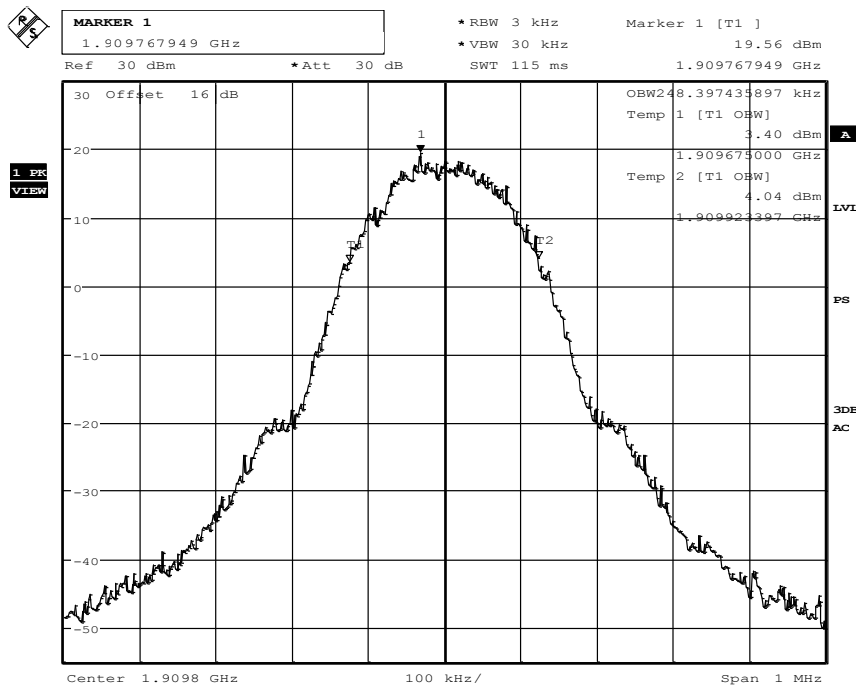

Date: 15.JUN.2016 11:31:02

Channel 810

1.9. Spurious emissions conducted (850 MHz transmitting mode)

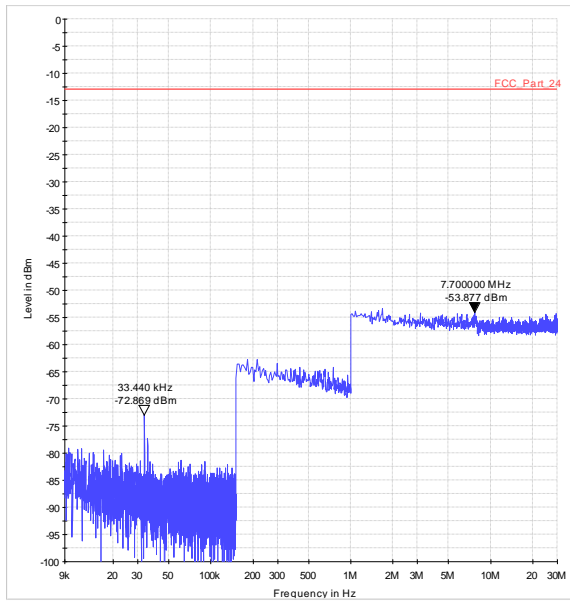

Diagram 36.07_Ch128_GRPS_Sweep1

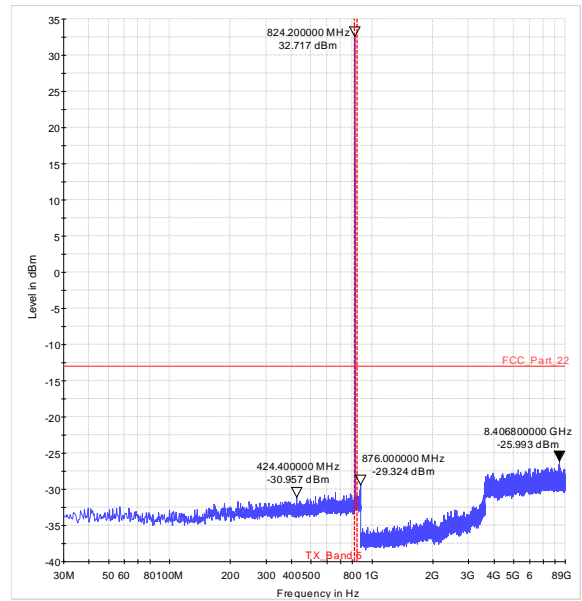

Diagram 36.08_Ch128_GRPS_Sweep2

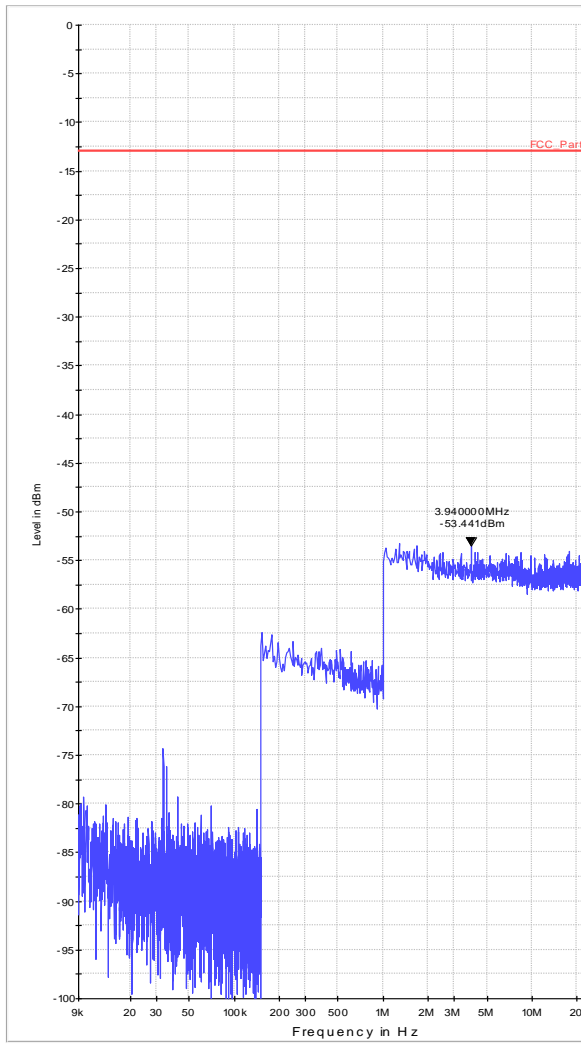

Diagram 36.09_Ch192_GRPS_Sweep1

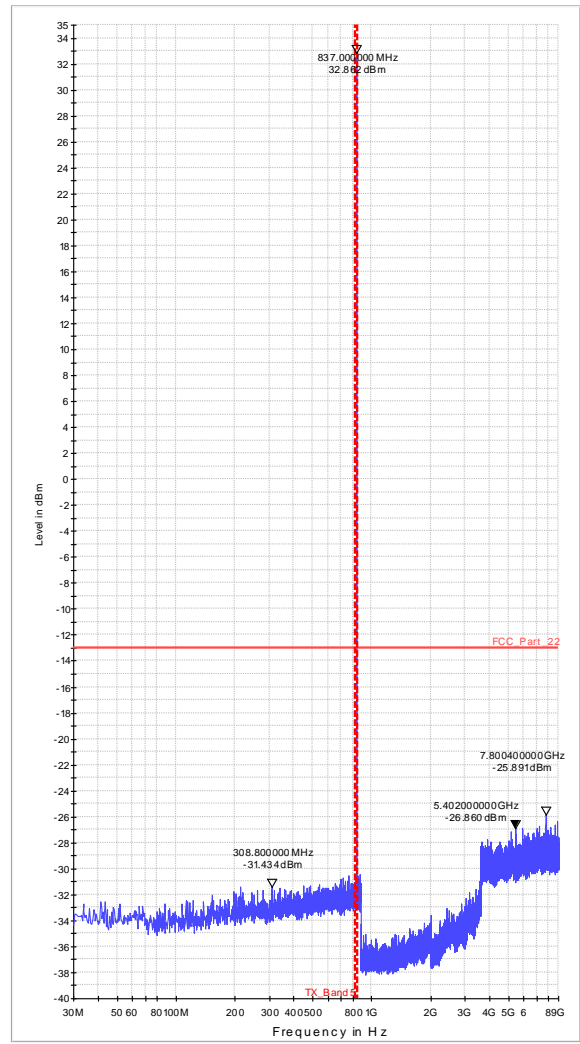

Diagram 36.10_Ch192_GRPS_Sweep2

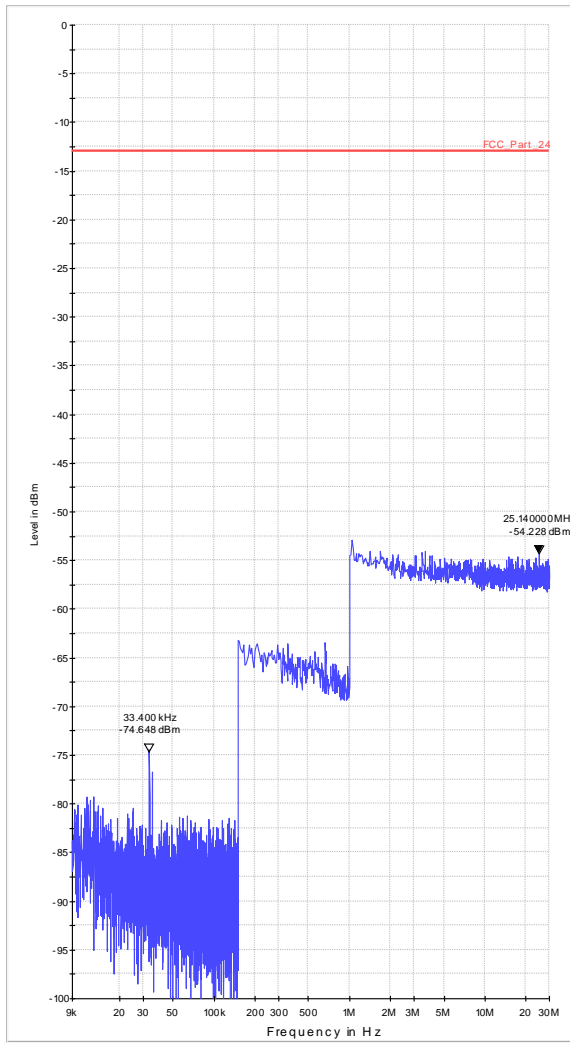

Diagram 36.11_Ch251_GRPS_Sweep1

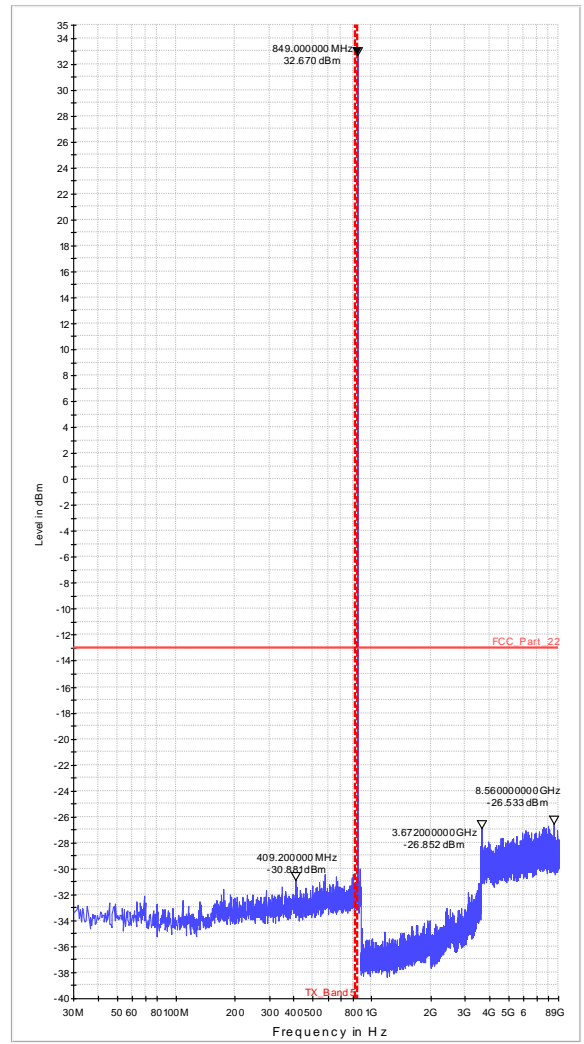

Diagram 36.12_Ch251_GRPS_Sweep2

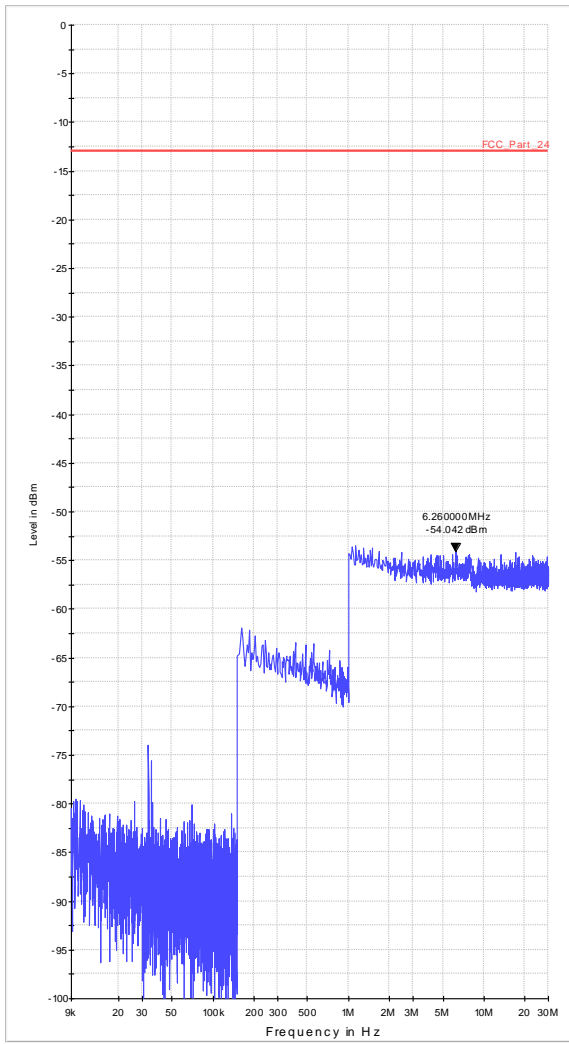

Diagram 36.13_RSE_Ch128_EGPRS_Sweep1

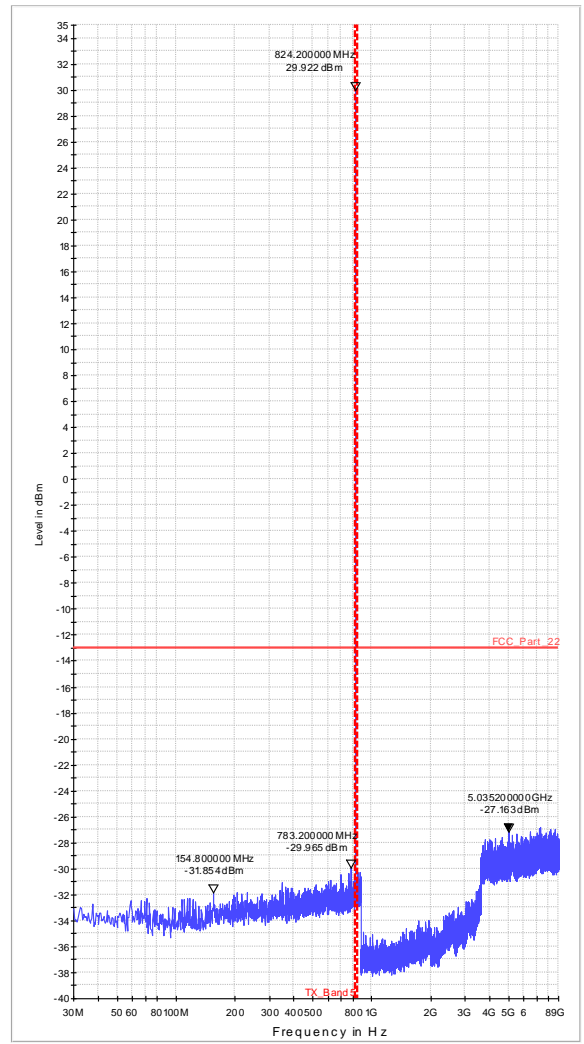

Diagram 36.14_RSE_Ch128_EGPRS_Sweep2

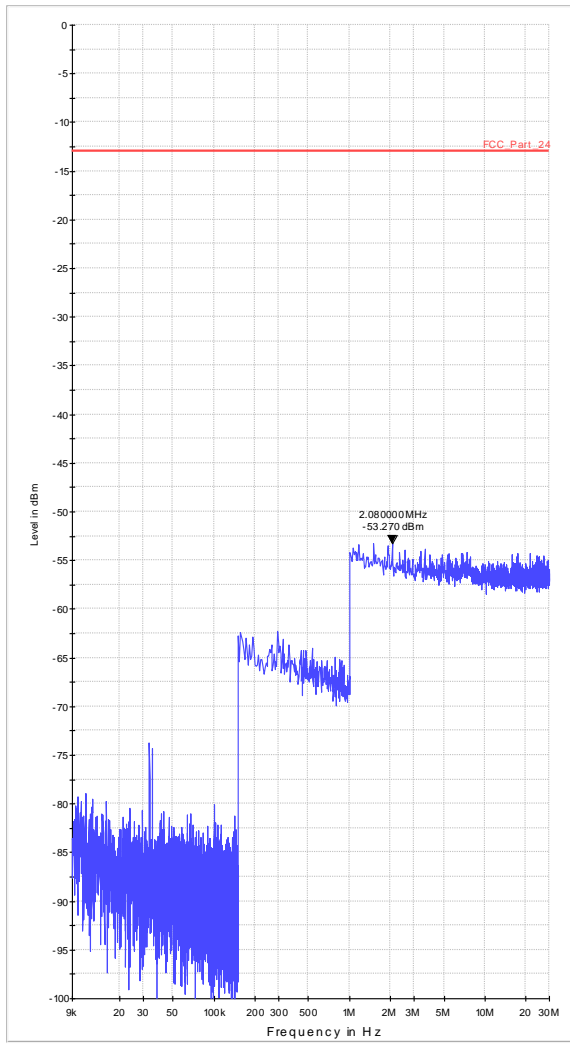

Diagram 36.15_RSE_Ch192_EGPRS_Sweep1

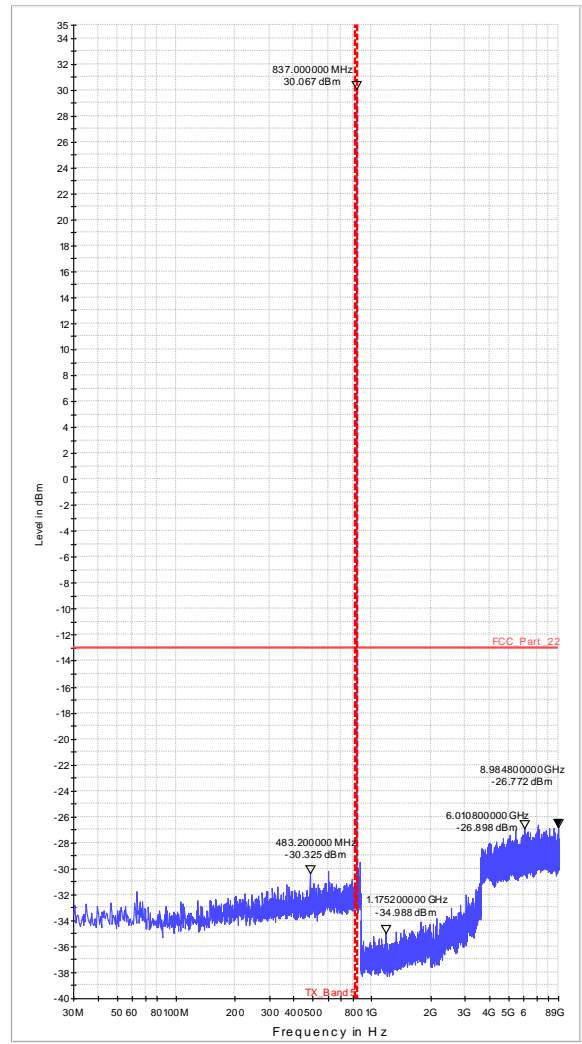

Diagram 36.16_RSE_Ch192_EGPRS_Sweep2

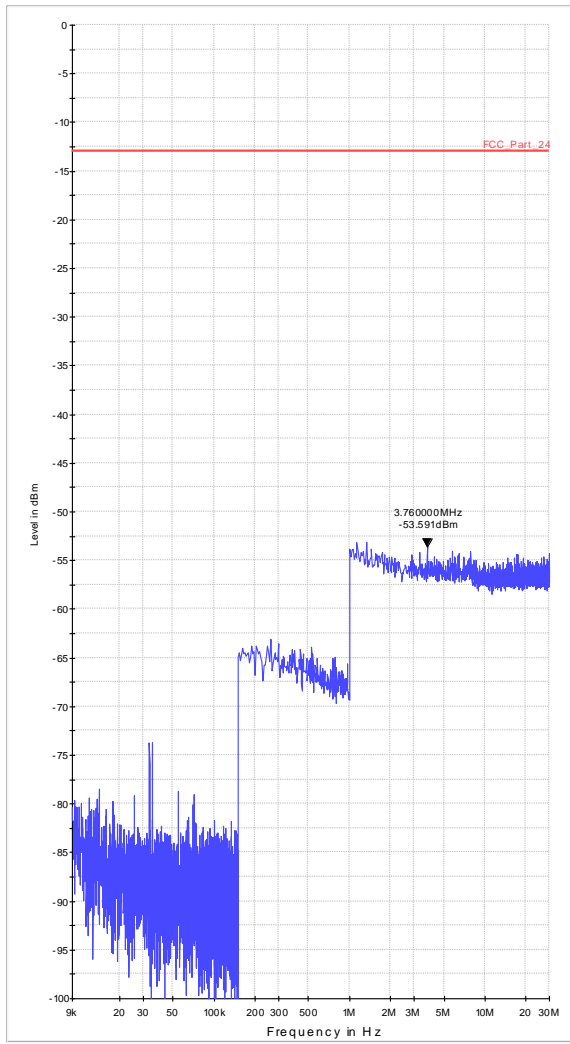

Diagram 36.17_RSE_Ch251_EGPRS_Sweep1

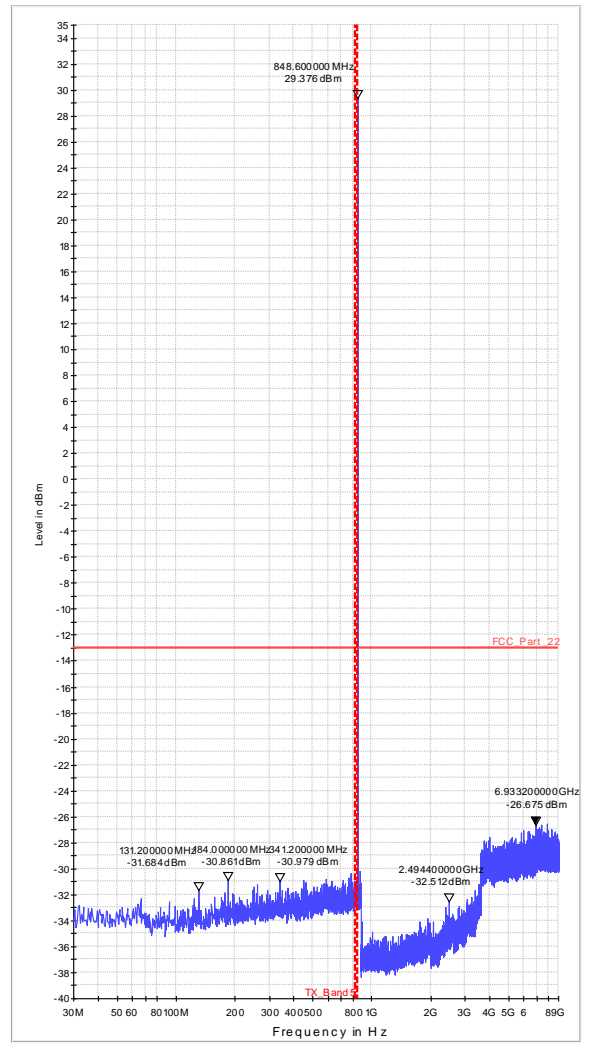

Diagram 36.18_RSE_Ch251_EGPRS_Sweep2

1.10. Spurious emissions conducted (1900 MHz transmitting mode)

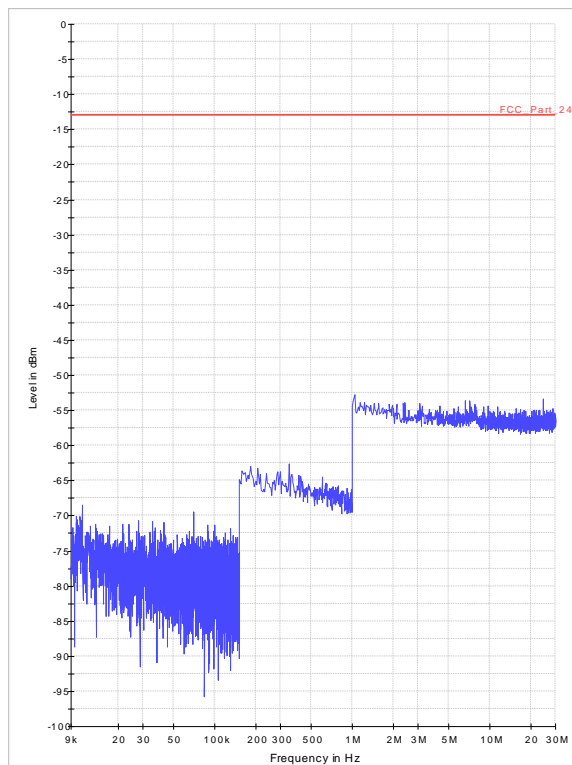

Diagram 36.20_RSE_Ch512_GPRS_Sweep1

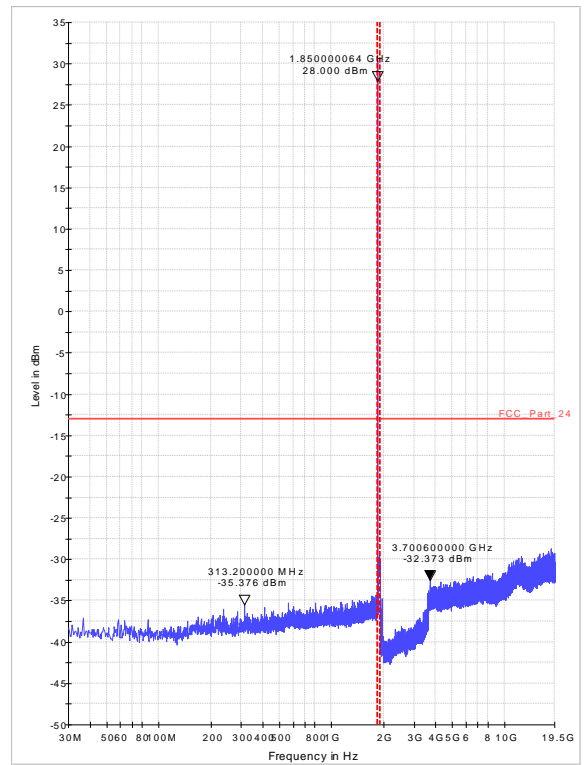

Diagram 36.21_RSE_Ch512_GPRS_Sweep2

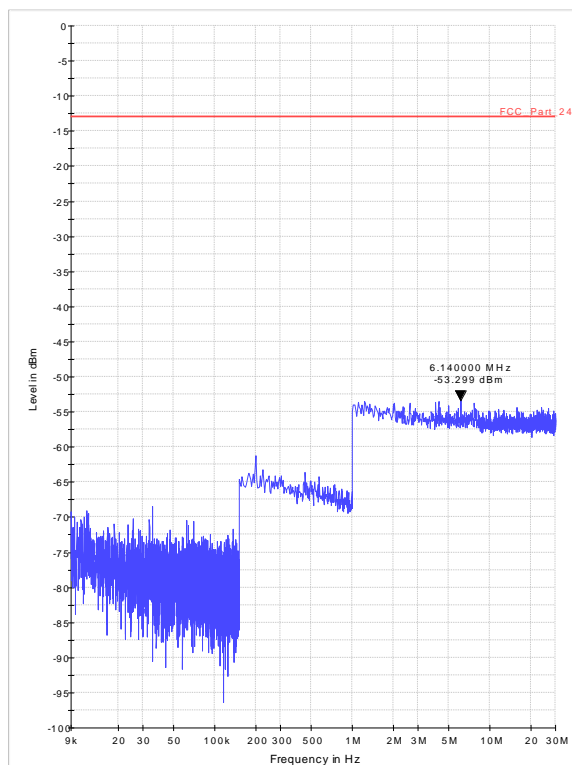

Diagram 36.22_RSE_Ch661_GPRS_Sweep1

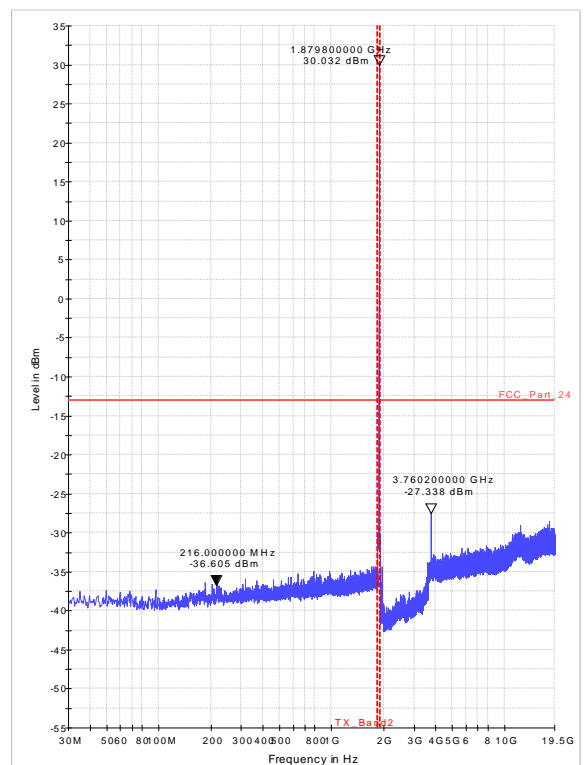

Diagram 36.23_RSE_Ch661_GPRS_Sweep2

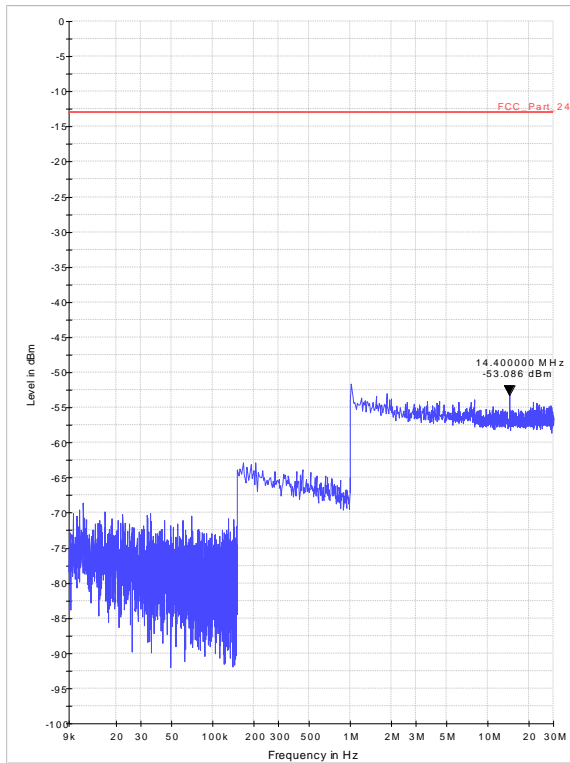

Diagram 36.24_RSE_Ch810_GPRS_Sweep1

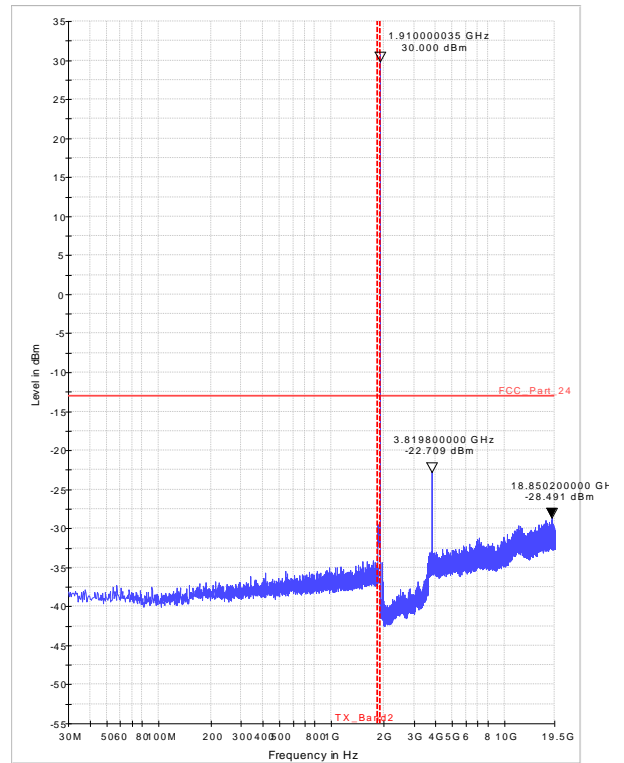

Diagram 36.25_RSE_Ch810_GPRS_Sweep2

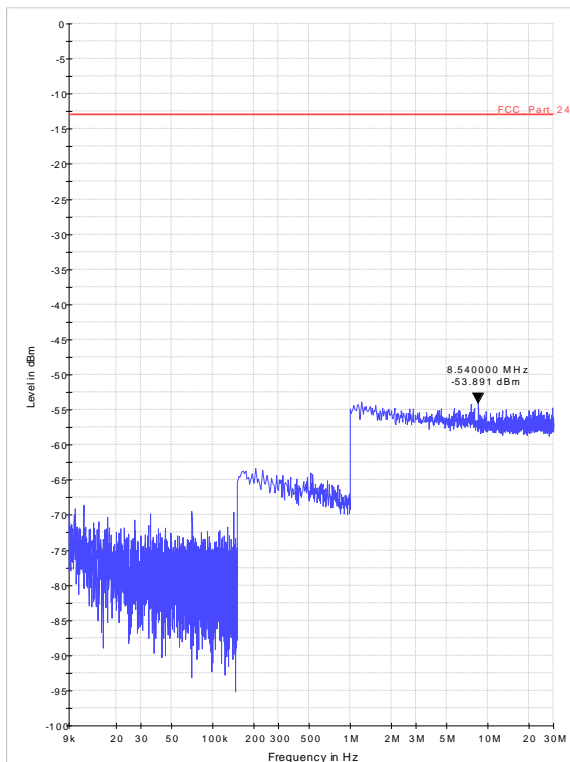

Diagram 36.26_RSE_Ch512_EGPRS_Sweep1

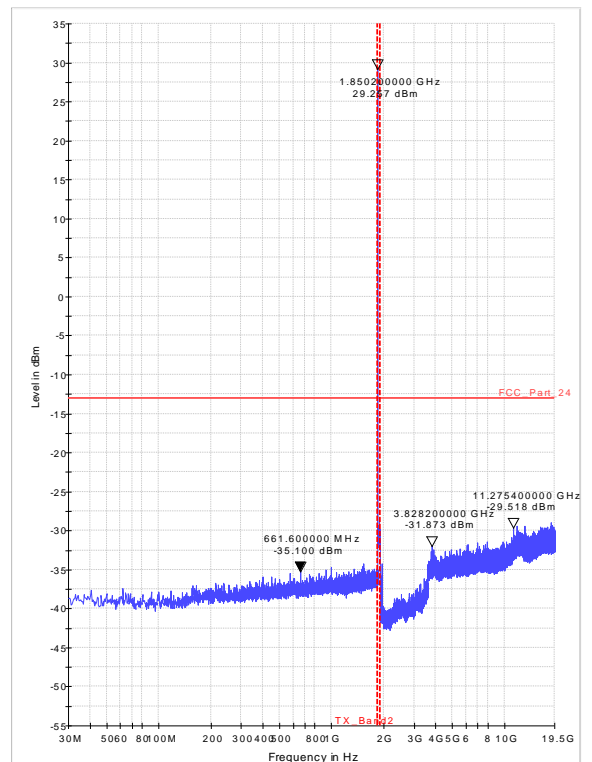

Diagram 36.27_RSE_Ch512_EGPRS_Sweep2

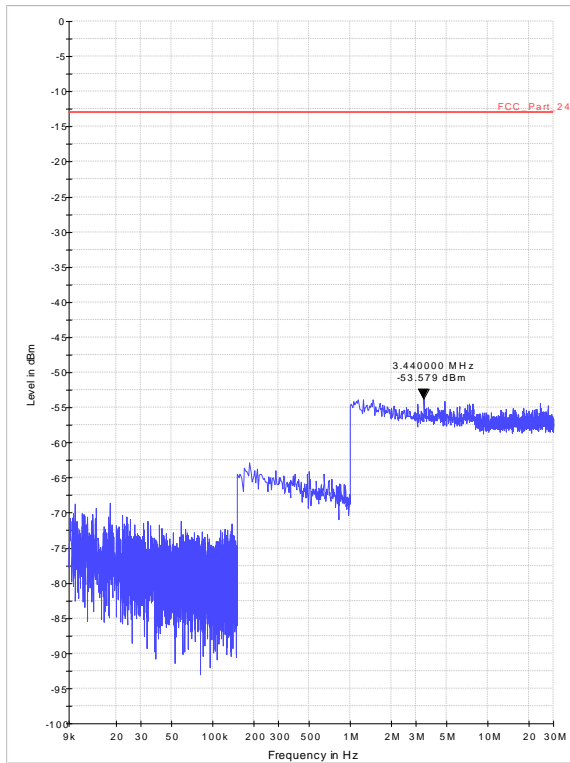

Diagram 36.28_RSE_Ch661_EGPRS_Sweep1

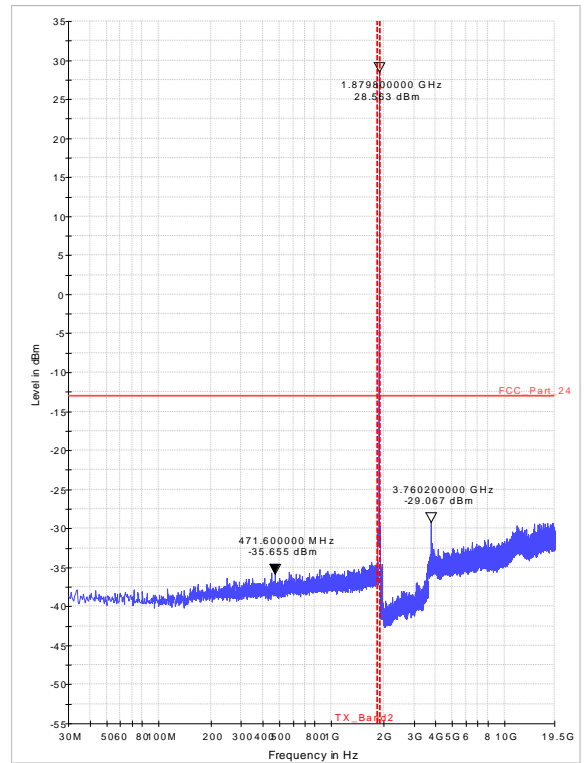

Diagram 36.29_RSE_Ch661_EGPRS_Sweep2

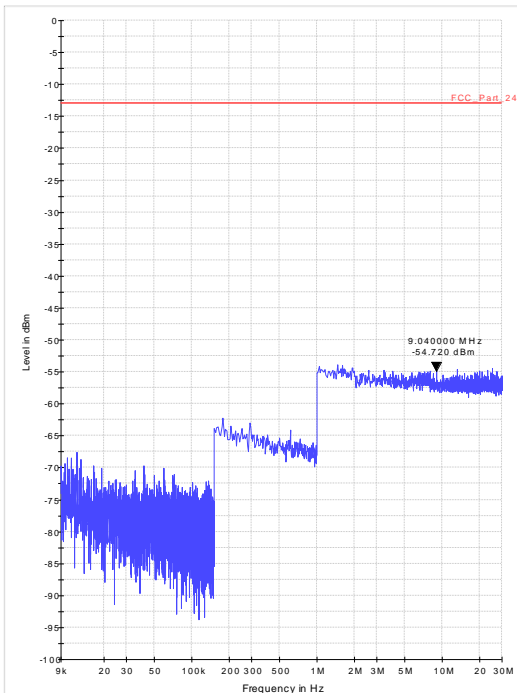

Diagram 36.30_RSE_Ch810_EGPRS_Sweep1

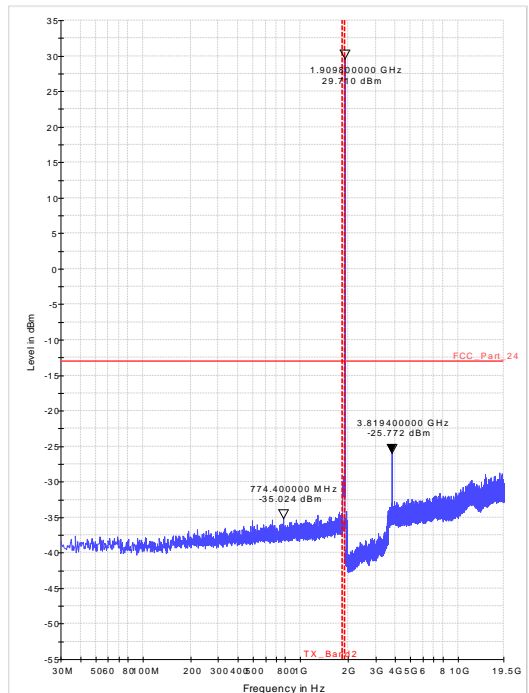

Diagram 36.31_RSE_Ch810_EGPRS_Sweep2

1.11. Conducted emissions on 850 MHz transmitting band-edge

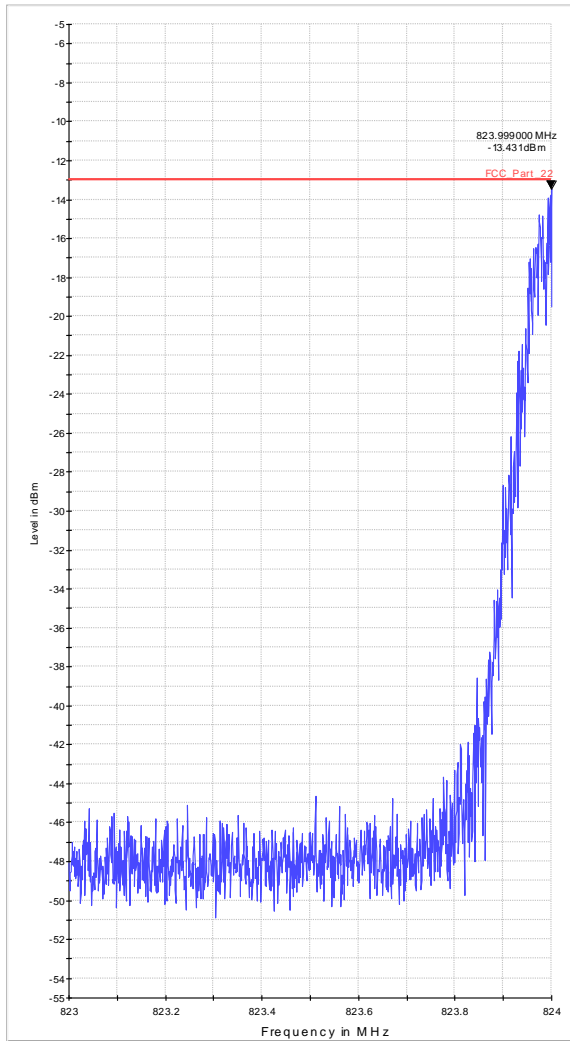

Diagram 37.03_BE_Ch128_GPRS

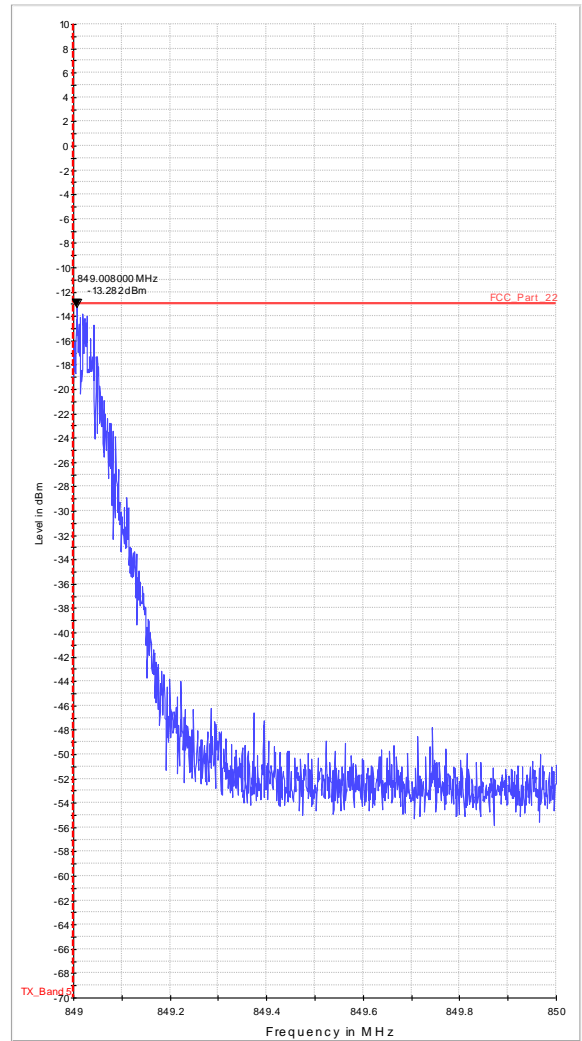

Diagram 37.04_BE_Ch251_GPRS

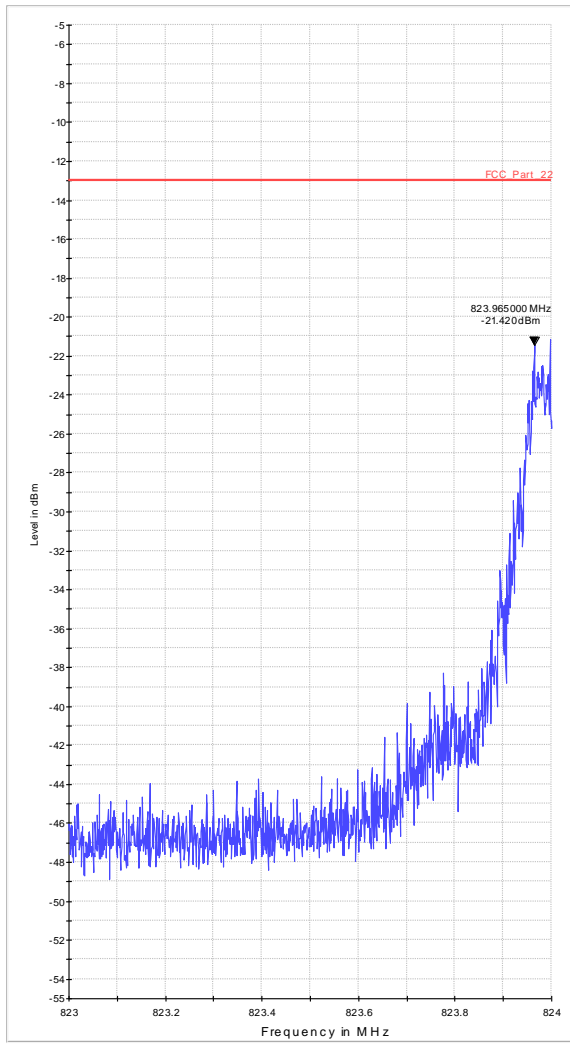

Diagram 37.05_BE_Ch128_EGPRS

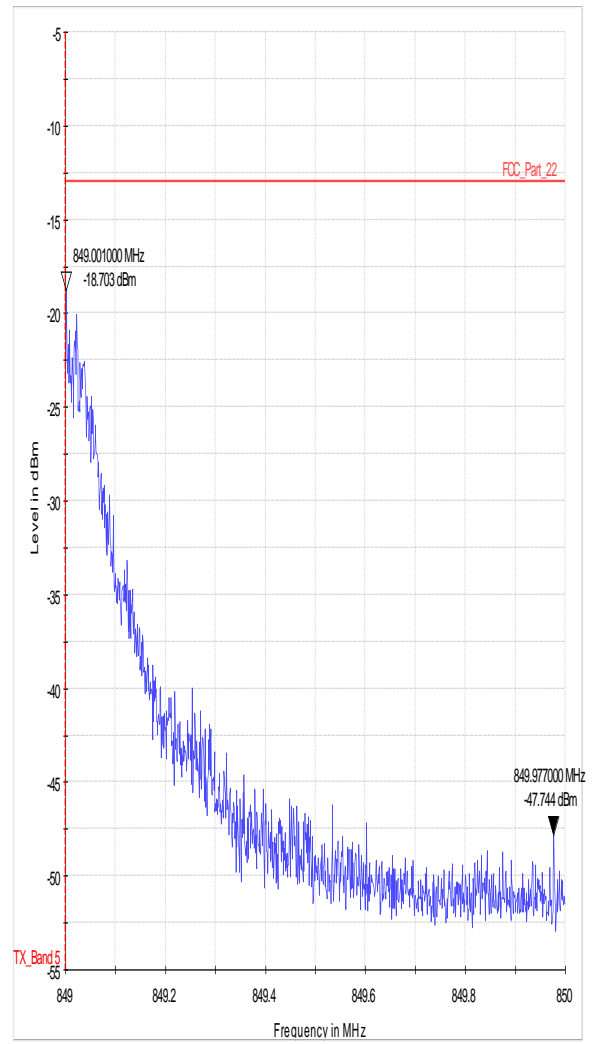

Diagram 37.06_BE_Ch251_EGPRS

1.12. Conducted emissions on 1900 MHz transmitting band-edge

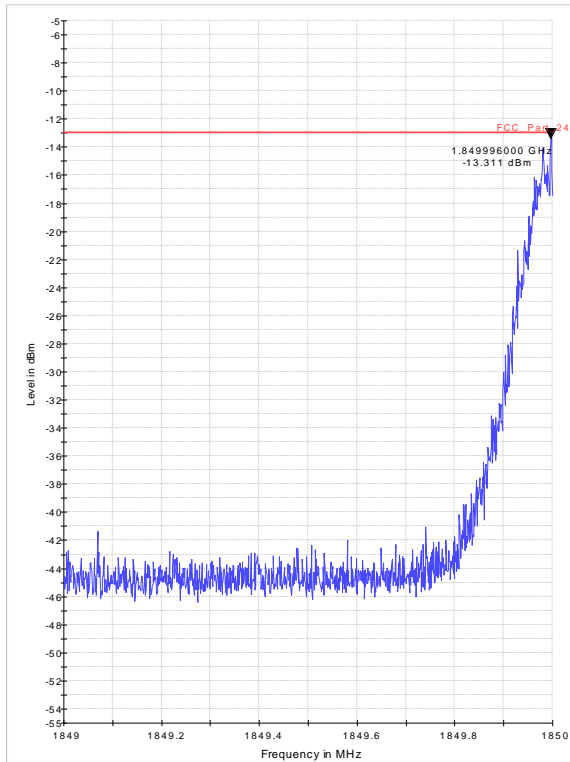

Diagram 37.10_BE_Ch512_GPRS_PK

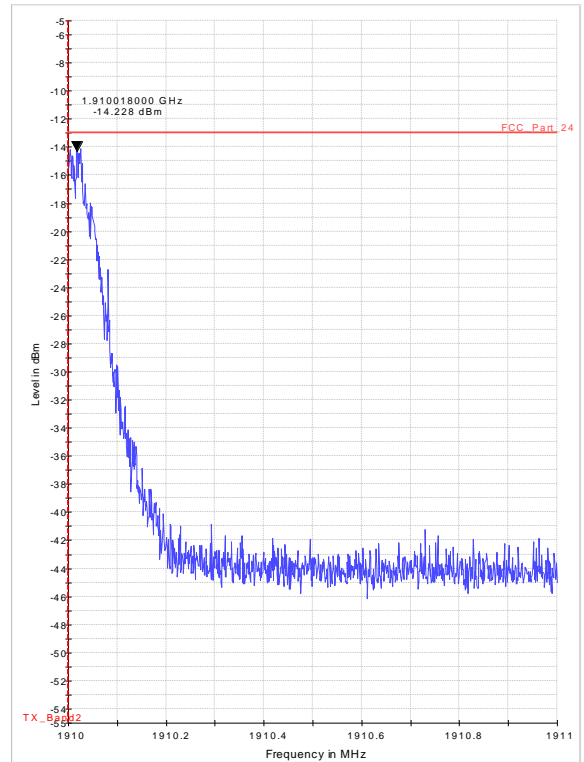

Diagram 37.11_BE_Ch810_GPRS_PK

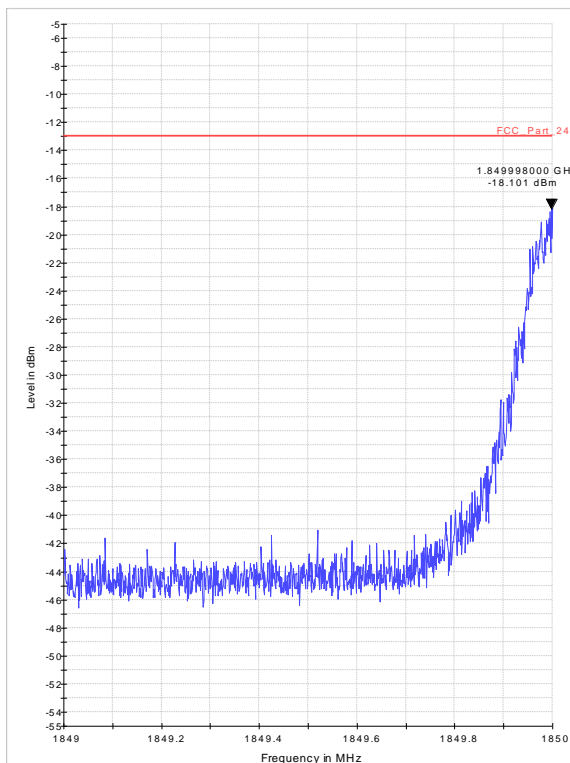

Diagram 37.12_BE_Ch512_EGPRS_PK

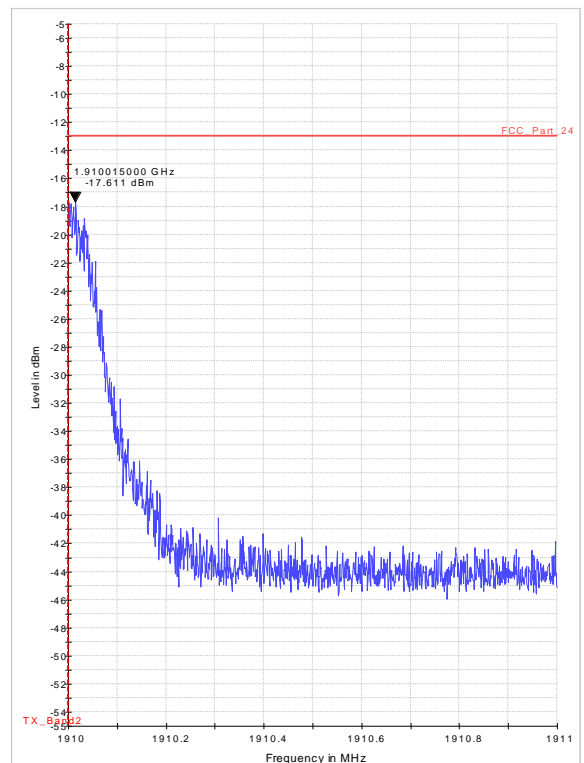

Diagram 37.13_BE_Ch810_EGPRS_PK