



# MEASUREMENT REPORT

## FCC PART 15.247/ RSS-247 Bluetooth

---

**FCC ID:** R5DSUNDAY  
**IC:** 22682-SUNDAY  
**APPLICANT:** 4MOD Technology

**Application Type:** Certification  
**Product:** Remote Control  
**FCC Model No.:** SUNDAY  
**FCC Serial No.:** 4MOD340X  
**IC Model No.:** SUNDAY  
**Brand Name:** SUNDAY  
**FCC Classification:** Digital Transmission System (DTS)  
**FCC Rule Part(s):** Part 15.247  
**IC Rule(s):** RSS-247 Issue 2, RSS-Gen Issue 5  
**Test Procedure(s):** ANSI C63.10-2013, KDB 558074 D01v05  
**Test Date:** September 14 ~ 19, 2018

Reviewed By : Sunny Sun  
( Sunny Sun )

Approved By : Robin Wu  
( Robin Wu )



The test results relate only to the samples tested.

This equipment has been shown to be capable of compliance with the applicable technical standards as indicated in the measurement report and was tested in accordance with the measurement procedures specified in KDB 558074 D01v05. Test results reported herein relate only to the item(s) tested.

The test report shall not be reproduced except in full without the written approval of MRT Technology (Suzhou) Co., Ltd.

### Revision History

Report No.	Version	Description	Issue Date	Note
1809RSU016-U1	Rev. 01	Initial report	09-21-2018	Valid

---

## CONTENTS

Description	Page
<b>1. INTRODUCTION .....</b>	<b>6</b>
1.1. Scope .....	6
1.2. MRT Test Location .....	6
<b>2. PRODUCT INFORMATION .....</b>	<b>7</b>
2.1. Feature of Equipment under Test .....	7
2.2. Product Specification Subjective to this Report.....	7
2.3. Working Frequencies for this report .....	8
2.4. Test Software .....	8
2.5. Device Capabilities .....	8
2.6. Test Configuration .....	8
2.7. EMI Suppression Device(s)/Modifications.....	8
2.8. Labeling Requirements.....	9
<b>3. DESCRIPTION OF TEST .....</b>	<b>10</b>
3.1. Evaluation Procedure .....	10
3.2. AC Line Conducted Emissions .....	10
3.3. Radiated Emissions .....	11
<b>4. ANTENNA REQUIREMENTS .....</b>	<b>12</b>
<b>5. TEST EQUIPMENT CALIBRATION DATE .....</b>	<b>13</b>
<b>6. MEASUREMENT UNCERTAINTY .....</b>	<b>14</b>
<b>7. TEST RESULT .....</b>	<b>15</b>
7.1. Summary .....	15
7.2. 6dB Bandwidth Measurement.....	16
7.2.1. Test Limit .....	16
7.2.2. Test Procedure used.....	16
7.2.3. Test Setting.....	16
7.2.4. Test Setup.....	16
7.2.5. Test Result.....	17
7.3. Output Power Measurement.....	18
7.3.1. Test Limit .....	18
7.3.2. Test Procedure Used .....	18
7.3.3. Test Setting.....	18
7.3.4. Test Setup.....	18
7.3.5. Test Result.....	19

---

7.4.	Power Spectral Density Measurement .....	20
7.4.1.	Test Limit .....	20
7.4.2.	Test Procedure Used .....	20
7.4.3.	Test Setting .....	20
7.4.4.	Test Setup.....	20
7.4.5.	Test Result.....	21
7.5.	Conducted Band Edge and Out-of-Band Emissions.....	22
7.5.1.	Test Limit .....	22
7.5.2.	Test Procedure Used .....	22
7.5.3.	Test Setting.....	22
7.5.4.	Test Setup.....	23
7.5.5.	Test Result.....	24
7.6.	Radiated Spurious Emission Measurement .....	26
7.6.1.	Test Limit .....	26
7.6.2.	Test Procedure Used .....	26
7.6.3.	Test Setting.....	26
7.6.4.	Test Setup.....	28
7.6.5.	Test Result.....	30
7.7.	Radiated Restricted Band Edge Measurement .....	35
7.7.1.	Test Limit .....	35
7.7.2.	Test Procedure Used .....	37
7.7.3.	Test Setting.....	37
7.7.4.	Test Setup.....	38
7.7.5.	Test Result.....	39
7.8.	AC Conducted Emissions Measurement.....	47
7.8.1.	Test Limit .....	47
7.8.2.	Test Setup.....	47
7.8.3.	Test Result.....	47
<b>8.</b>	<b>CONCLUSION.....</b>	<b>48</b>
	<b>Appendix A – Test Setup Photograph.....</b>	<b>49</b>
	<b>Appendix B – EUT Photograph .....</b>	<b>50</b>

## §2.1033 General Information

<b>Applicant:</b>	4MOD Technology		
<b>Applicant Address:</b>	203, Avenue Carnot, 33150 Cenon, France		
<b>Manufacturer:</b>	4MOD Technology		
<b>Manufacturer Address:</b>	203, Avenue Carnot, 33150 Cenon, France		
<b>Test Site:</b>	MRT Technology (Suzhou) Co., Ltd		
<b>Test Site Address:</b>	D8 Building, Youxin Industrial Park, No.2 Tian'edang Rd., Wuzhong Economic Development Zone, Suzhou, China		
<b>FCC Registration No.:</b>	893164		
<b>IC Registration No.:</b>	11384A		
<b>Test Device Serial No.:</b>	N/A	<input type="checkbox"/> Production	<input checked="" type="checkbox"/> Pre-Production <input type="checkbox"/> Engineering

### Test Facility / Accreditations

Measurements were performed at MRT Laboratory located in Tian'edang Rd., Suzhou, China.

- MRT facility is a FCC registered (MRT Reg. No. 893164) test facility with the site description report on file and has met all the requirements specified in ANSI C63.4-2014.
- MRT facility is an IC registered (MRT Reg. No. 11384A-1) test laboratory with the site description on file at Industry Canada.
- MRT facility is a VCCI registered (R-20025, G-20034, C-20020, T-20020) test laboratory with the site description on file at VCCI Council.
- MRT Lab is accredited to ISO 17025 by the American Association for Laboratory Accreditation (A2LA) under the American Association for Laboratory Accreditation Program (A2LA Cert. No. 3628.01) in EMC, Telecommunications, Radio and SAR testing.



# 1. INTRODUCTION

## 1.1. Scope

Measurement and determination of electromagnetic emissions (EMC) of radio frequency devices including intentional and/or unintentional radiators for compliance with the technical rules and regulations of the Federal Communications Commission and the Industry Canada Certification and Engineering Bureau.

## 1.2. MRT Test Location

The map below shows the location of the MRT LABORATORY, its proximity to the Taihu Lake. These measurement tests were conducted at the MRT Technology (Suzhou) Co., Ltd. Facility located at D8 Building, No.2 Tian'edang Rd., Wuzhong Economic Development Zone, Suzhou, China. The measurement facility compliant with the test site requirements specified in ANSI C63.4-2014.



## 2. PRODUCT INFORMATION

### 2.1. Feature of Equipment under Test

Product Name	Remote Control
FCC Model No.	SUNDAY
FCC Serial No.	4MOD340X
IC Model No.	SUNDAY
Brand Name	SUNDAY
Bluetooth Specification	v4.0 (BLE Only)

NOTE: The different models are only for marketing different clients. The PCBA configuration and software are the same for all models. All the materials used in different models are the same as well.

### 2.2. Product Specification Subjective to this Report

Bluetooth Frequency	2402~2480MHz
Bluetooth Version	v4.0
Data Rate	250kbps
Modulation	GFSK
Antenna Type	PIFA Antenna
Antenna Gain	0dBi

### 2.3. Working Frequencies for this report

Channel	Frequency	Channel	Frequency	Channel	Frequency
00	2402 MHz	01	2404 MHz	02	2406 MHz
03	2408 MHz	04	2410 MHz	05	2412 MHz
06	2414 MHz	07	2416 MHz	08	2418 MHz
09	2420 MHz	10	2422 MHz	11	2424 MHz
12	2426 MHz	13	2428 MHz	14	2430 MHz
15	2432 MHz	16	2434 MHz	17	2436 MHz
18	2438 MHz	19	2440 MHz	20	2442 MHz
21	2444 MHz	22	2446 MHz	23	2448 MHz
24	2450 MHz	25	2452 MHz	26	2454 MHz
27	2456 MHz	28	2458 MHz	29	2460 MHz
30	2462 MHz	31	2464 MHz	32	2466 MHz
33	2468 MHz	34	2470 MHz	35	2472 MHz
36	2474 MHz	37	2476 MHz	38	2478 MHz
39	2480 MHz	--	--	--	--

### 2.4. Test Software

The test utility software used during testing was “SmartRF Studio 7”, and the version was “2.7.0”.

### 2.5. Device Capabilities

This device contains the following capabilities:

Bluetooth v4.0 (BLE Only)

### 2.6. Test Configuration

The EUT was tested per the guidance of KDB 558074 D01v05. ANSI C63.10-2013 was used to reference the appropriate EUT setup for radiated spurious emissions testing and AC line conducted testing.

### 2.7. EMI Suppression Device(s)/Modifications

No EMI suppression device(s) were added and/or no modifications were made during testing.



## 2.8. Labeling Requirements

Per 2.1074 & 15.19; Docket 95-19

The label shall be permanently affixed at a conspicuous location on the device; instruction manual or pamphlet supplied to the user and be readily visible to the purchaser at the time of purchase.

However, when the device is so small wherein placement of the label with specified statement is not practical, only the FCC ID must be displayed on the device per Section 15.19(a)(5). Please see attachment for FCC ID label and label location.

RSP-100 Issue 11 Section 3

The manufacturer, importer or distributor shall meet the labelling requirements set out in this section for every unit:

- (i) prior to marketing in Canada, for products manufactured in Canada
- (ii) prior to importation into Canada, for imported products

For information regarding the e-labelling option, see Notice 2014–DRS1003. The label for the certified product represents the manufacturer's or importer's compliance with Innovation, Science and Economic Development Canada's (ISED) regulatory requirements.

Please see attachment for IC label and label location.

### 3. DESCRIPTION OF TEST

#### 3.1. Evaluation Procedure

The measurement procedures described in the American National Standard for Testing Unlicensed Wireless Devices (ANSI C63.10-2013), and the guidance provided in KDB 558074 D01v05 were used in the measurement.

**Deviation from measurement procedure.....None**

#### 3.2. AC Line Conducted Emissions

The line-conducted facility is located inside an 8'x4'x4' shielded enclosure. A 1m x 2m wooden table 80cm high is placed 40cm away from the vertical wall and 80cm away from the sidewall of the shielded room. Two 10kHz-30MHz, 50Ω/50uH Line-Impedance Stabilization Networks (LISNs) are bonded to the shielded room floor. Power to the LISNs is filtered by external high-current high-insertion loss power line filters. These filters attenuate ambient signal noise from entering the measurement lines. These filters are also bonded to the shielded enclosure.

The EUT is powered from one LISN and the support equipment is powered from the second LISN. All interconnecting cables more than 1 meter were shortened to a 1 meter length by non-inductive bundling (serpentine fashion) and draped over the back edge of the test table. All cables were at least 40cm above the horizontal reference ground-plane. Power cables for support equipment were routed down to the second LISN while ensuring that that cables were not draped over the second LISN.

Sufficient time for the EUT, support equipment, and test equipment was allowed in order for them to warm up to their normal operating condition. The RF output of the LISN was connected to the receiver and exploratory measurements were made to determine the frequencies producing the maximum emission from the EUT. The receiver was scanned from 150kHz to 30MHz. The detector function was set to peak mode for exploratory measurements while the bandwidth of the analyzer was set to 9kHz. The EUT, support equipment, and interconnecting cables were arranged and manipulated to maximize each emission. Each emission was also maximized by varying: power lines, the mode of operation or data exchange speed, or support equipment whichever determined the worst-case emission. Once the worst case emissions have been identified, the one EUT cable configuration/arrangement and mode of operation that produced these emissions were used for final measurements on the same test site. The analyzer is set to CISPR quasi-peak and average detectors with a 9kHz resolution bandwidth for final measurements.

An extension cord was used to connect to a single LISN which powered by EUT. The extension cord was calibrated with LISN, the impedance and insertion loss are compliance with the requirements as stated in ANSI C63.10-2013.

### 3.3. Radiated Emissions

The radiated test facilities consisted of an indoor 3 meter semi-anechoic chamber used for final measurements and exploratory measurements, when necessary. The measurement area is contained within the semi-anechoic chamber which is shielded from any ambient interference. For measurements above 1GHz absorbers are arranged on the floor between the turn table and the Antenna mast in such a way so as to maximize the reduction of reflections. For measurements below 1GHz, the absorbers are removed. A MF Model 210SS turntable is used for radiated measurement. It is a continuously rotatable, remote controlled, metallic turntable and 2 meters (6.56 ft.) in diameter. The turn table is flush with the raised floor of the chamber in order to maintain its function as a ground plane. An 80cm high PVC support structure is placed on top of the turntable. For all measurements, the spectrum was scanned through all EUT azimuths and from 1 to 4 meter receive Antenna height using a broadband Antenna from 30MHz up to the upper frequency shown in 15.33(b)(1) depending on the highest frequency generated or used in the device or on which the device operates or tunes. For frequencies above 1GHz, linearly polarized double ridge horn Antennas were used. For frequencies below 30MHz, a calibrated loop Antenna was used. When exploratory measurements were necessary, they were performed at 1 meter test distance inside the semi-anechoic chamber using broadband Antennas, broadband amplifiers, and spectrum analyzers to determine the frequencies and modes producing the maximum emissions. Sufficient time for the EUT, support equipment, and test equipment was allowed in order for them to warm up to their normal operating condition. The test set-up for frequencies below 1GHz was placed on top of the 0.8 meter high, 1 x 1.5 meter table; and test set-up for frequencies 1-40GHz was placed on top of the 1.5 meter high, 1 x 1.5 meter table. The EUT, support equipment, and interconnecting cables were arranged and manipulated to maximize each emission. Appropriate precaution was taken to ensure that all emissions from the EUT were maximized and investigated. The system configuration, clock speed, mode of operation or video resolution, if applicable, turntable azimuth, and receive Antenna height was noted for each frequency found.

Final measurements were made in the semi-anechoic chamber using calibrated, linearly polarized broadband and horn Antennas. The test setup was configured to the setup that produced the worst case emissions. The spectrum analyzer was set to investigate all frequencies required for testing to compare the highest radiated disturbances with respect to the specified limits. The turntable containing the EUT was rotated through 360 degrees and the height of the receive Antenna was varied 1 to 4 meters and stopped at the azimuth and height producing the maximum emission. Each emission was maximized by changing the orientation of the EUT through three orthogonal planes and changing the polarity of the receive Antenna, whichever produced the worst-case emissions. According to 3dB Beam-Width of horn Antenna, the horn Antenna should be always directed to the EUT when rising height.

## 4. ANTENNA REQUIREMENTS

### **Excerpt from §15.203 of the FCC Rules/Regulations:**

“An intentional radiator antenna shall be designed to ensure that no antenna other than that furnished by the responsible party can be used with the device. The use of a permanently attached antenna or of an antenna that uses a unique coupling to the intentional radiator shall be considered sufficient to comply with the provisions of this section.”

- The antenna of the **Remote Control** is **permanently attached**.
- There are no provisions for connection to an external antenna.

### **Conclusion:**

The EUT unit complies with the requirement of §15.203.

## 5. TEST EQUIPMENT CALIBRATION DATE

### Conducted Emissions - SR2

Instrument	Manufacturer	Type No.	Asset No.	Cali. Interval	Cali. Due Date
EMI Test Receiver	R&S	ESR7	MRTSUE06001	1 year	2019/08/14
Two-Line V-Network	R&S	ENV216	MRTSUE06002	1 year	2019/06/15
Two-Line V-Network	R&S	ENV216	MRTSUE06003	1 year	2019/06/15
Thermohygrometer	Testo	608-H1	MRTSUE06404	1 year	2019/08/14

### Radiated Emissions - AC2

Instrument	Manufacturer	Type No.	Asset No.	Cali. Interval	Cali. Due Date
Spectrum Analyzer	Keysight	N9038A	MRTSUE06125	1 year	2019/08/18
Loop Antenna	Schwarzbeck	FMZB 1519	MRTSUE06025	1 year	2018/11/20
Bilog Period Antenna	Schwarzbeck	VULB 9162	MRTSUE06022	1 year	2018/10/21
Horn Antenna	Schwarzbeck	BBHA9120D	MRTSUE06171	1 year	2018/11/18
Broadband Horn Antenna	Schwarzbeck	BBHA9170	MRTSUE06024	1 year	2018/12/14
Broadband Coaxial Preamplifier	Schwarzbeck	BBV 9718	MRTSUE06176	1 year	2018/11/17
Preamplifier	Schwarzbeck	BBV 9721	MRTSUE06121	1 year	2019/06/13
Temperature/Humidity Meter	Minggao	ETH529	MRTSUE06170	1 year	2018/12/12
Anechoic Chamber	RIKEN	Chamber-AC2	MRTSUE06213	1 year	2019/05/02

### Conducted Test Equipment - TR3

Instrument	Manufacturer	Type No.	Asset No.	Cali. Interval	Cali. Due Date
Spectrum Analyzer	Agilent	N9020A	MRTSUE06106	1 year	2019/04/24
Spectrum Analyzer	Agilent	N9010B	MRTSUE06106	1 year	2019/07/20
Power Meter	Agilent	U2021XA	MRTSUE06030	1 year	2018/12/06
Thermohygrometer	Testo	608-H1	MRTSUE06401	1 year	2019/08/14

Software	Version	Function
e3	V8.3.5	EMI Test Software

## 6. MEASUREMENT UNCERTAINTY

Where relevant, the following test uncertainty levels have been estimated for tests performed on the EUT as specified in CISPR 16-4-2. This uncertainty represents an expanded uncertainty expressed at approximately the 95% confidence level using a coverage factor of  $k = 2$ .

<b>AC Conducted Emission Measurement - SR2</b>
Measuring Uncertainty for a Level of Confidence of 95% ( $U=2Uc(y)$ ): 150kHz~30MHz: 3.46dB
<b>Radiated Emission Measurement - AC2</b>
Measuring Uncertainty for a Level of Confidence of 95% ( $U=2Uc(y)$ ): 9kHz ~ 1GHz: 3.84dB 1GHz ~ 25GHz: 4.33dB
<b>Spurious Emissions, Conducted - TR3</b>
Measuring Uncertainty for a Level of Confidence of 95% ( $U=2Uc(y)$ ): 0.78dB
<b>Output Power - TR3</b>
Measuring Uncertainty for a Level of Confidence of 95% ( $U=2Uc(y)$ ): 1.13dB
<b>Power Spectrum Density - TR3</b>
Measuring Uncertainty for a Level of Confidence of 95% ( $U=2Uc(y)$ ): 1.15dB
<b>Occupied Bandwidth - TR3</b>
Measuring Uncertainty for a Level of Confidence of 95% ( $U=2Uc(y)$ ): 0.28%

## 7. TEST RESULT

### 7.1. Summary

**Company Name:** 4MOD Technology  
**FCC ID:** R5DSUNDAY  
**IC:** 22682-SUNDAY

FCC Section(s)	RSS Section(s)	Test Description	Test Limit	Test Condition	Test Result	Reference
15.247(a)(2)	RSS-247 [5.2(a)]	6dB Bandwidth	$\geq 500\text{kHz}$	Conducted	Pass	Section 7.2
15.247(b)(3)	RSS-247 [5.4(d)]	Output Power	$\leq 1\text{Watt} \ \& \ \text{EIRP} \leq 4\text{Watt}$		Pass	Section 7.3
15.247(e)	RSS-247 [5.2(b)]	Power Spectral Density	$\leq 8\text{dBm}/3\text{kHz}$		Pass	Section 7.4
15.247(d)	RSS-247 [5.5]	Band Edge / Out-of-Band Emissions	$\leq 20\text{dBc(Peak)}$		Pass	Section 7.5
15.205 15.209	RSS-247 [5.5]	General Field Strength Limits (Restricted Bands and Radiated Emission Limits)	Emissions in restricted bands must meet the radiated limits detailed in 15.209	Radiated	Pass	Section 7.6 & 7.7
15.207	RSS-Gen [8.8]	AC Conducted Emissions 150kHz - 30MHz	< FCC 15.207 limits	Line Conducted	N/A	Section 7.8

**Note s:**

- 1) All modes of operation and data rates were investigated. For radiated emission test, every axis (X, Y, Z) was also verified. The test results shown in the following sections represent the worst case emissions.
- 2) The analyzer plots shown in this section were all taken with a correction table loaded into the analyzer. The correction table was used to account for the losses of the cables and attenuators used as part of the system to connect the EUT to the analyzer at all frequencies of interest.

## 7.2. 6dB Bandwidth Measurement

### 7.2.1. Test Limit

The minimum 6dB bandwidth shall be at least 500 kHz.

### 7.2.2. Test Procedure used

ANSI C63.10-2013 - Section 11.8.1 Option 2

### 7.2.3. Test Setting

1. The Spectrum's automatic bandwidth measurement capability was used to perform the 6dB bandwidth measurement. The "X" dB bandwidth parameter was set to  $X = 6$ . The bandwidth measurement was not influenced by any intermediate power nulls in the fundamental emission.
2. Set RBW = 100 kHz
3. VBW  $\geq 3 \times$  RBW
4. Detector = Peak
5. Trace mode = max hold
6. Sweep = auto couple
7. Allow the trace was allowed to stabilize

### 7.2.4. Test Setup

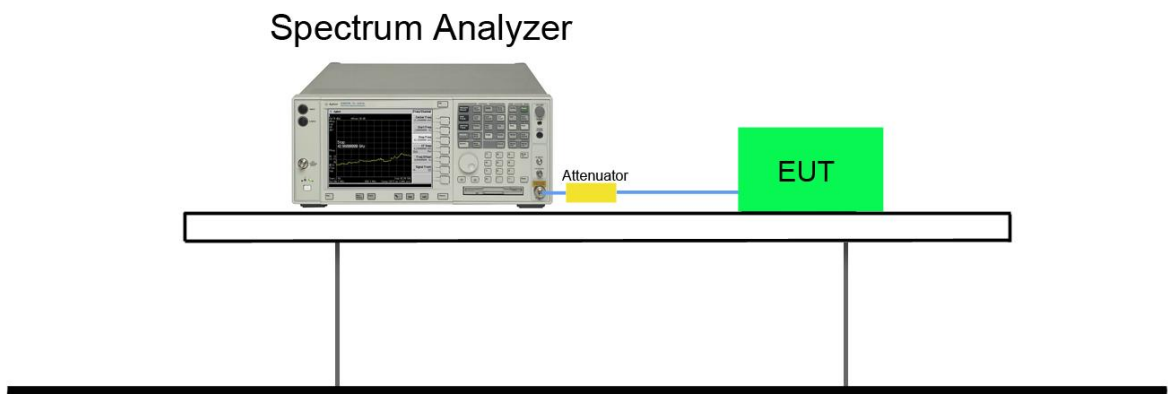



### 7.2.5. Test Result

Product	Remote Control	Temperature	25°C
Test Engineer	Ternence Wang	Relative Humidity	52%
Test Site	TR3	Test Date	2018/09/17

Test Mode	Data Rate (Mbps)	Channel No.	Frequency (MHz)	6dB Bandwidth (MHz)	Limit (MHz)	Result
BLE	1	00	2402	0.71	≥ 0.5	Pass
BLE	1	19	2440	0.73	≥ 0.5	Pass
BLE	1	39	2480	0.72	≥ 0.5	Pass

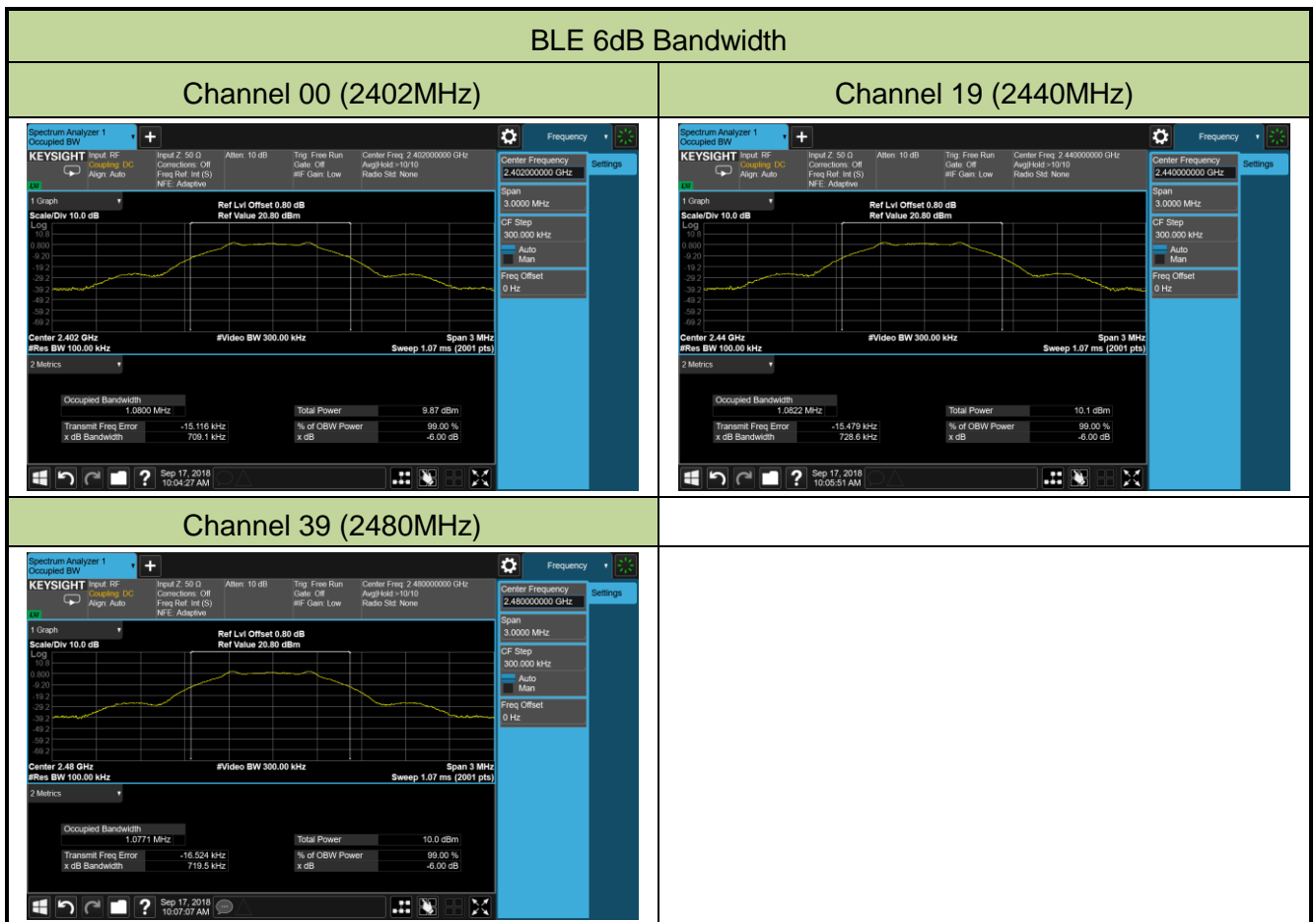

### 7.3. Output Power Measurement

#### 7.3.1. Test Limit

The maximum out power shall be less 1 Watt (30dBm) and E.I.R.P shall be less 4 Watt (36dBm).

#### 7.3.2. Test Procedure Used

ANSI C63.10-2013 - Section 11.9.1.3 PKPM1 Peak power meter method

ANSI C63.10-2013 - Section 11.9.2.3.2 Method AVGPM-G

#### 7.3.3. Test Setting

##### **PKPM1 Peak-reading power meter method**

The maximum peak conducted output power may be measured using a broadband peak RF power meter. The power meter shall have a video bandwidth that is greater than or equal to the DTS bandwidth and shall utilize a fast-responding diode detector.

##### **Method AVGPM-G (Measurement using a gated RF average-reading power meter)**

Measurements may be performed using a wideband gated RF power meter provided that the gate parameters are adjusted such that the power is measured only when the EUT is transmitting at its maximum power control level. Since this measurement is made only during the ON time of the transmitter, no duty cycle correction is required.

#### 7.3.4. Test Setup

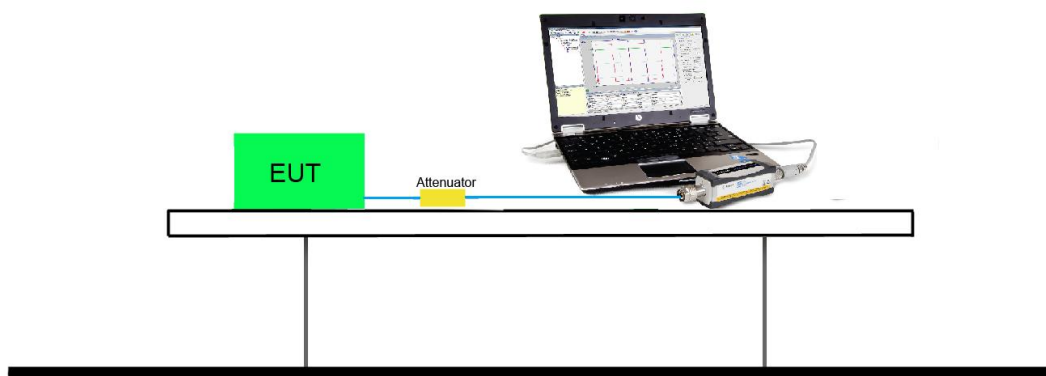

### 7.3.5. Test Result

Product	Remote Control	Temperature	25°C
Test Engineer	Ternence Wang	Relative Humidity	52%
Test Site	TR3	Test Date	2018/09/17

Test Mode	Data Rate (Mbps)	Channel No.	Frequency (MHz)	Output Power (dBm)	Limit (dBm)	E.I.R.P (dBm)	Limit (dBm)	Result
Test Result of Peak Output Power								
BLE	1	00	2402	3.35	≤ 30	3.35	≤ 36	Pass
BLE	1	19	2440	3.29	≤ 30	3.29	≤ 36	Pass
BLE	1	39	2480	3.20	≤ 30	3.20	≤ 36	Pass
Test Result of Average Output Power (Reporting Only)								
BLE	1	00	2402	3.23	≤ 30	3.23	≤ 36	Pass
BLE	1	19	2440	3.16	≤ 30	3.16	≤ 36	Pass
BLE	1	39	2480	3.08	≤ 30	3.08	≤ 36	Pass

Note: E.I.R.P (dBm) = Peak Output Power (dBm) + Antenna Gain (dBi).

## 7.4. Power Spectral Density Measurement

### 7.4.1. Test Limit

The maximum permissible power spectral density is 8dBm in any 3 kHz band.

### 7.4.2. Test Procedure Used

ANSI C63.10-2013 - Section 11.10.2 Method PKPSD (peak PSD)

### 7.4.3. Test Setting

1. Analyzer was set to the center frequency of the DTS channel under investigation
2. Span = 1.5 times the DTS channel bandwidth
3. RBW = 3kHz
4. VBW = 10kHz
5. Detector = peak
6. Sweep time = auto couple
7. Trace mode = max hold
8. Trace was allowed to stabilize

### 7.4.4. Test Setup

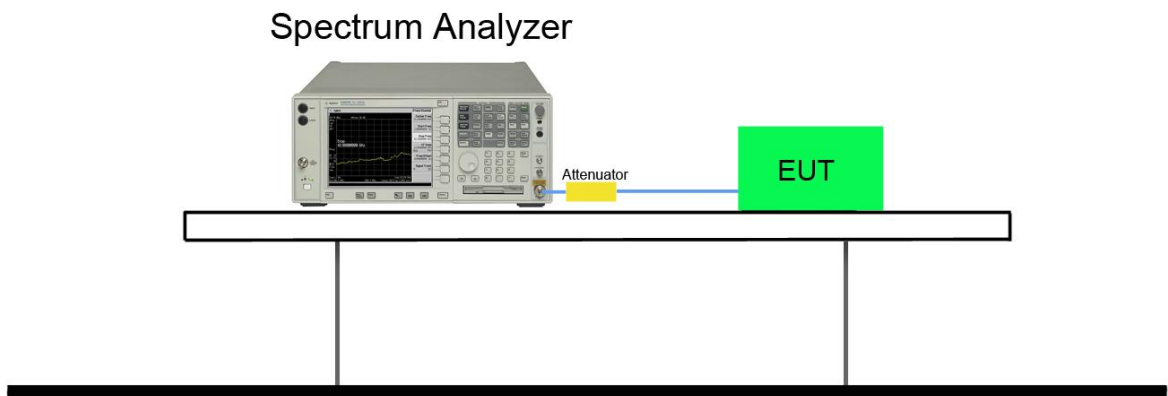

### 7.4.5. Test Result

Product	Remote Control	Temperature	25°C
Test Engineer	Ternence Wang	Relative Humidity	52%
Test Site	TR3	Test Date	2018/09/17

Test Mode	Data Rate (Mbps)	Channel No.	Frequency (MHz)	PSD Result (dBm / 3kHz)	Limit (dBm / 3kHz)	Result
BLE	1	00	2402	-7.68	≤ 8.00	Pass
BLE	1	19	2440	-5.79	≤ 8.00	Pass
BLE	1	39	2480	-5.68	≤ 8.00	Pass

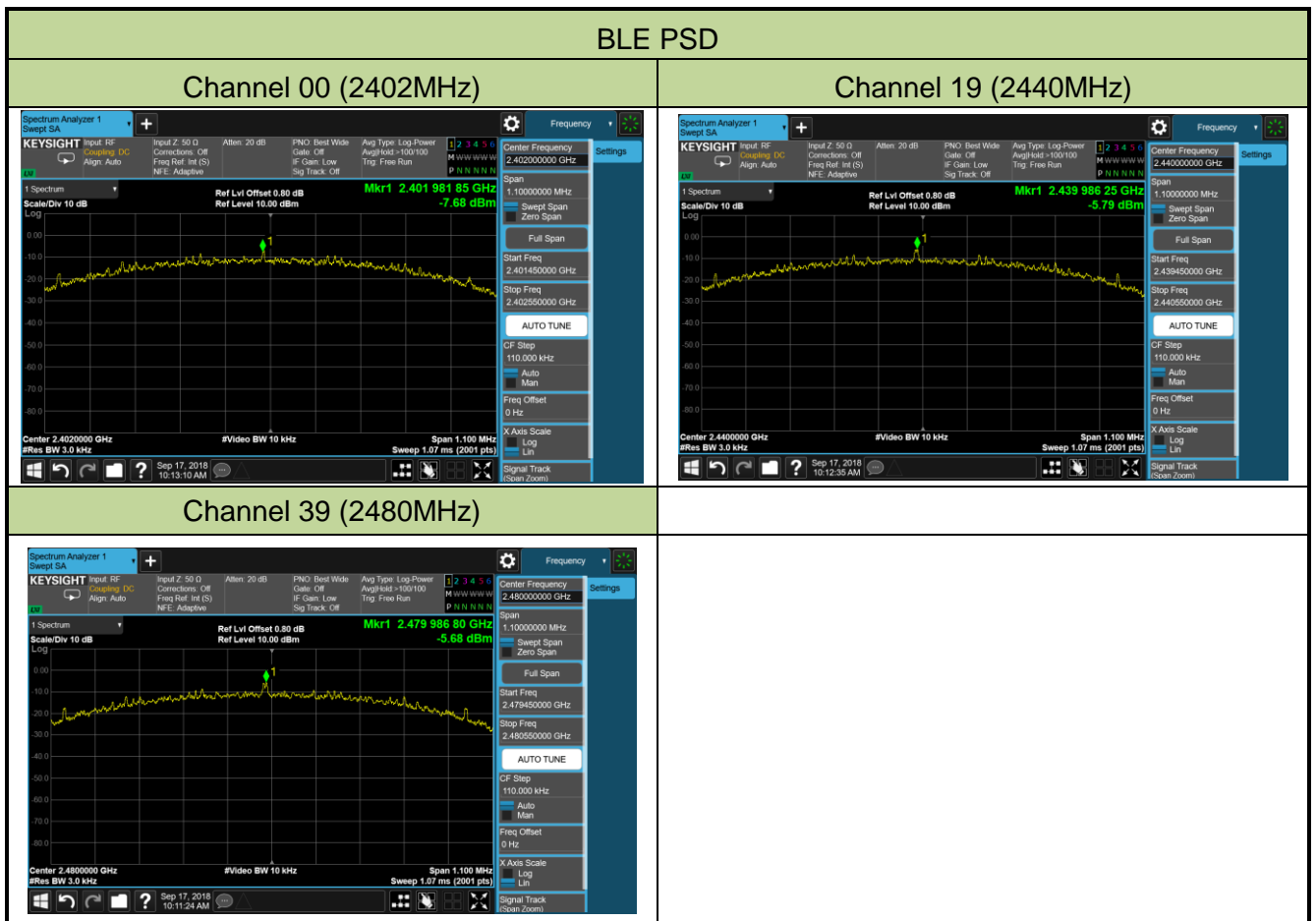

## **7.5. Conducted Band Edge and Out-of-Band Emissions**

### **7.5.1. Test Limit**

The limit for out-of-band spurious emissions at the band edge is 20dB below the fundamental emission level, as determined from the in-band power measurement of the DTS channel performed in a 100kHz bandwidth per the PSD procedure.

### **7.5.2. Test Procedure Used**

ANSI C63.10-2013 - Section 11.11

### **7.5.3. Test Setting**

#### **Reference level measurement**

1. Set instrument center frequency to DTS channel center frequency
2. Set the span to  $\geq 1.5$  times the DTS bandwidth
3. Set the RBW = 100 kHz
4. Set the VBW  $\geq 3 \times$  RBW
5. Detector = peak
6. Sweep time = auto couple
7. Trace mode = max hold
8. Allow trace to fully stabilize

#### **Emission level measurement**

Set the center frequency and span to encompass frequency range to be measured

RBW = 100kHz

VBW = 300kHz

Detector = Peak

Number of sweep points  $\geq 2 \times$  Span/RBW

Trace mode = max hold

Sweep time = auto couple

The trace was allowed to stabilize

### 7.5.4. Test Setup

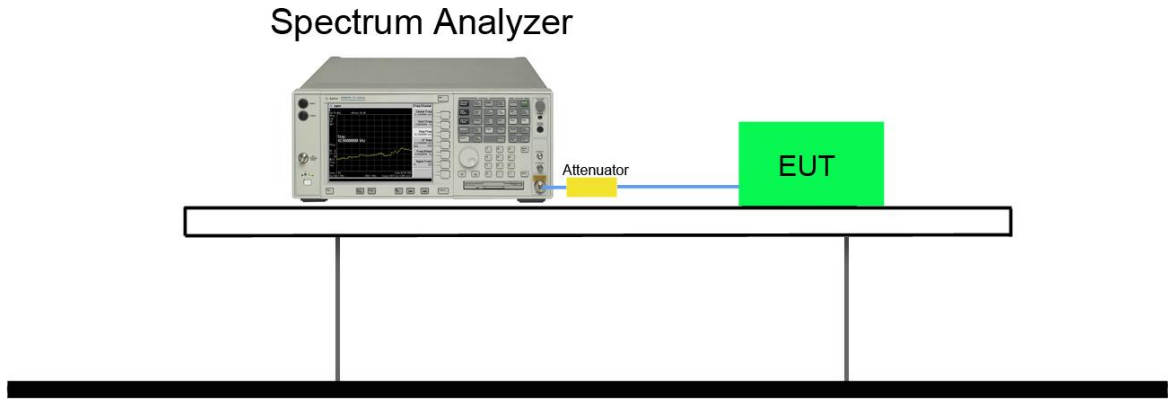

### 7.5.5. Test Result

Product	Remote Control	Temperature	25°C
Test Engineer	Ternence Wang	Relative Humidity	52%
Test Site	TR3	Test Date	2018/09/17

Test Mode	Data Rate (Mbps)	Channel No.	Frequency (MHz)	Limit	Result
BLE	1	00	2402	20dBc	Pass
BLE	1	19	2440	20dBc	Pass
BLE	1	39	2480	20dBc	Pass

#### BLE Out-of-Band Emissions

##### Channel 00 (2402MHz)

###### 100kHz PSD reference Level

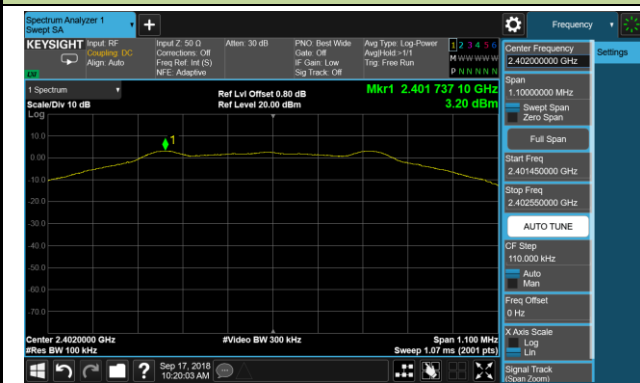

###### Low Band Edge



#### Spurious Emission 30MHz ~ 25GHz





Channel 19 (2440MHz)

100kHz PSD reference Level

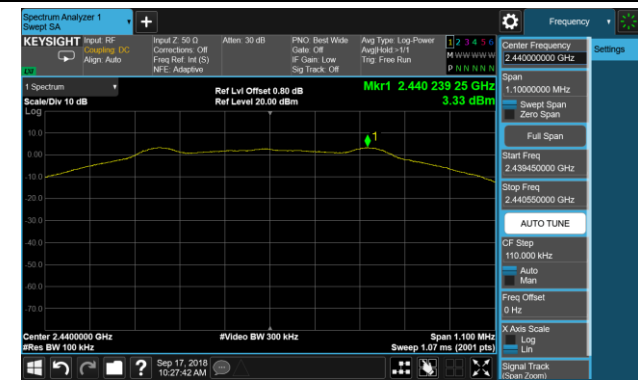

Spurious Emission 30MHz ~ 25GHz

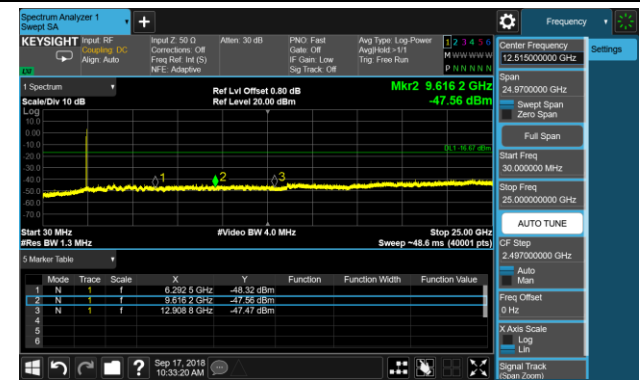

Channel 39 (2480MHz)

100kHz PSD reference Level

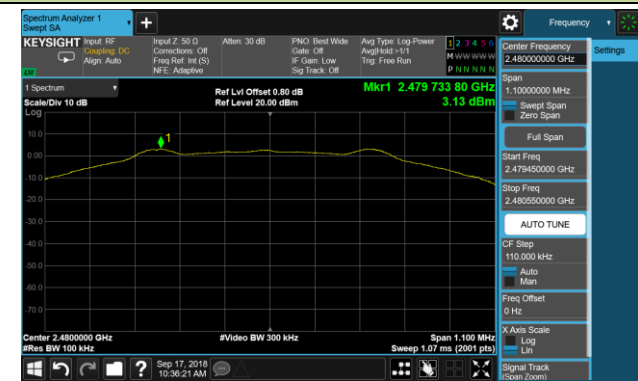

High Band Edge



Spurious Emission 30MHz ~ 25GHz



## 7.6. Radiated Spurious Emission Measurement

### 7.6.1. Test Limit

FCC Part 15 Subpart C Paragraph 15.209 & RSS-Gen		
Frequency (MHz)	Field Strength (uV/m)	Measurement Distance (m)
0.009 ~ 0.490	2400/F(kHz)	300
0.490 ~ 1.705	24000/F(kHz)	30
1.705 ~ 30.0	30	30
30 ~ 80	100**	3
80 ~ 216	150**	3
216 ~ 960	200**	3
Above 960	500	3

Note 1: The lower limit shall apply at the transition frequency.

Note 2: Distance refers to the distance in meters between the measuring instrument antenna and the closed point of any part of the device or system.

Note 3: E field strength (dBuV/m) = 20 log E field strength (uV/m).

### 7.6.2. Test Procedure Used

ANSI C63.10-2013 - Section 11.12

### 7.6.3. Test Setting

#### Peak Field Strength Measurements

1. Analyzer center frequency was set to the frequency of the radiated spurious emission of interest
2. RBW = as specified in Table 1
3. VBW = 3MHz
4. Detector = peak
5. Sweep time = auto couple
6. Trace mode = max hold
7. Trace was allowed to stabilize

**Table 1 - RBW as a function of frequency**

Frequency	RBW
9 ~ 150 kHz	200 ~ 300 Hz
0.15 ~ 30 MHz	9 ~ 10 kHz
30 ~ 1000 MHz	100 ~ 120 kHz
> 1000 MHz	1 MHz

**Average Field Strength Measurements**

1. Analyzer center frequency was set to the frequency of the radiated spurious emission of interest
2. RBW = 1MHz
3. VBW  $\geq$  1/T
4. De As an alternative, the instrument may be set to linear detector mode. Ensure that video filtering is applied in linear voltage domain (rather than in a log or dB domain). Some instruments require linear display mode in order to accomplish this. Others have a setting for Average-VBW Type, which can be set to "Voltage" regardless of the display mode
5. Detector = Peak
6. Sweep time = auto
7. Trace mode = max hold
8. Allow max hold to run for at least 50 times (1/duty cycle) traces

### 7.6.4. Test Setup

#### 9kHz ~ 30MHz Test Setup:

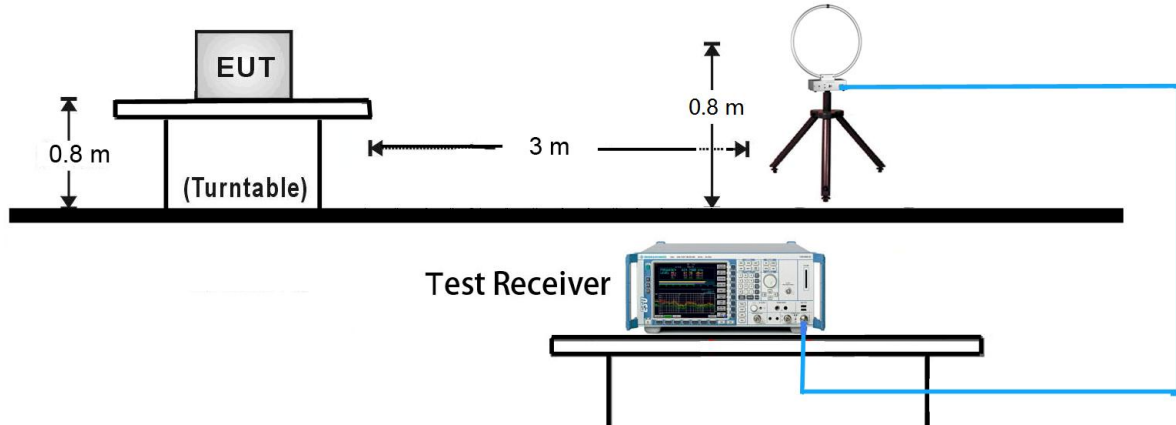

#### 30MHz ~ 1GHz Test Setup:

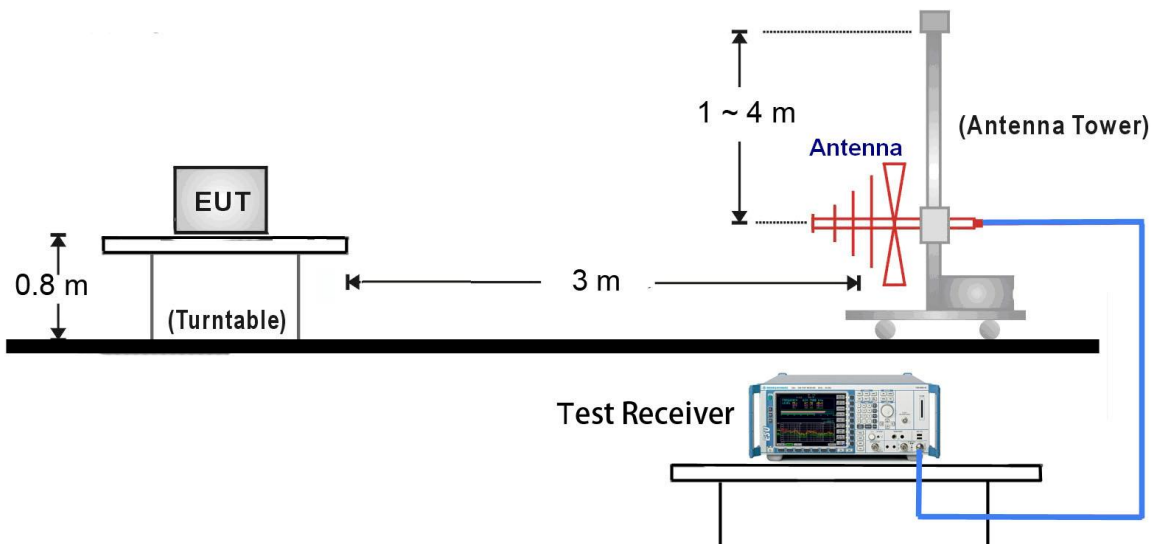

1GHz ~ 18GHz Test Setup:

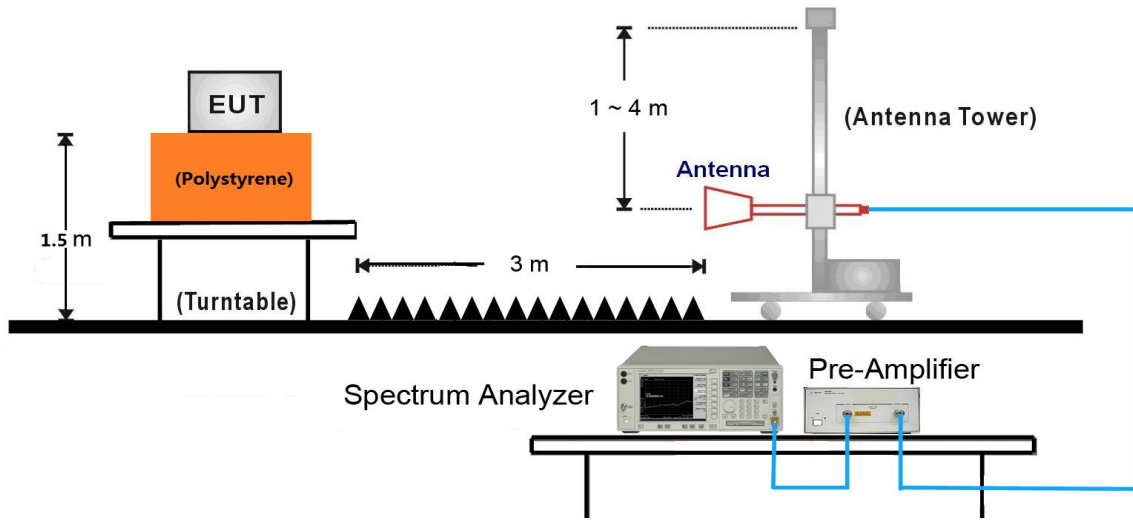

Above 18GHz Test Setup:

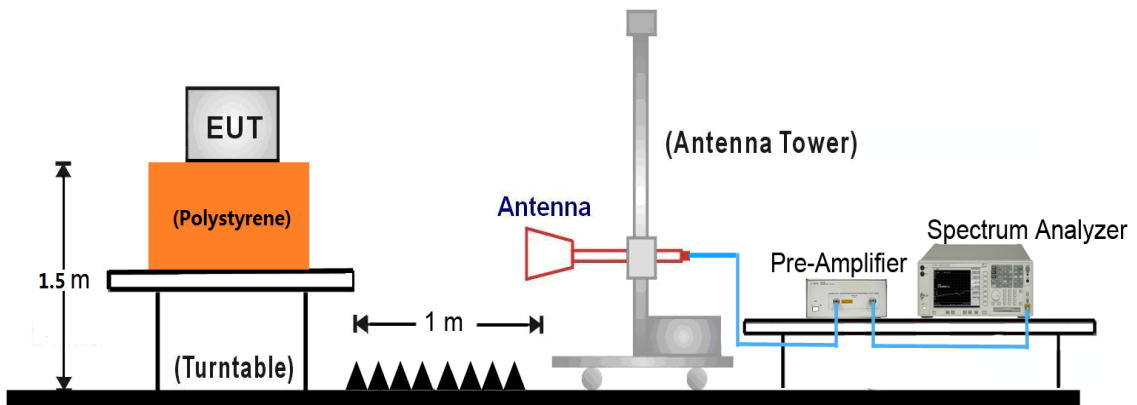

### 7.6.5. Test Result

Test Mode:	BLE	Test Site:	AC2
Test Channel:	00	Test Engineer:	Messiah Li
Remark:	1. Average measurement was not performed if peak level lower than average limit. 2. Other frequency was 20dB below limit line within 1-18GHz, there is not show in the report.		

Mark	Frequency (MHz)	Reading Level (dB $\mu$ V)	Factor (dB)	Measure Level (dB $\mu$ V/m)	Limit (dB $\mu$ V/m)	Margin (dB)	Detector	Polarization
	4804.0	40.8	5.8	46.6	74.0	-27.4	Peak	Horizontal
	5114.0	37.6	6.6	44.3	74.0	-29.7	Peak	Horizontal
*	7206.0	39.2	12.6	51.8	79.4	-27.6	Peak	Horizontal
*	9721.0	34.9	15.7	50.6	79.4	-28.7	Peak	Horizontal
	4804.0	41.9	5.8	47.7	74.0	-26.3	Peak	Vertical
*	6440.0	36.8	9.6	46.4	79.4	-32.9	Peak	Vertical
*	7206.0	38.2	12.6	50.8	79.4	-28.5	Peak	Vertical
	8140.0	37.0	13.4	50.3	74.0	-23.7	Peak	Vertical

Note 1: "\*" is not in restricted band, its limit is 20dBc of the fundamental emission level (99.4dB $\mu$ V/m) or 15.209 which is higher.

Note 2: Measure Level (dB $\mu$ V/m) = Reading Level (dB $\mu$ V) + Factor (dB)

Factor (dB) = Cable Loss (dB) + Antenna Factor (dB/m) - Pre\_Amplifier Gain (dB)

Test Mode:	BLE	Test Site:	AC2
Test Channel:	19	Test Engineer:	Messiah Li
Remark:	1. Average measurement was not performed if peak level lower than average limit. 2. Other frequency was 20dB below limit line within 1-18GHz, there is not show in the report.		

Mark	Frequency (MHz)	Reading Level (dBμV)	Factor (dB)	Measure Level (dBμV/m)	Limit (dBμV/m)	Margin (dB)	Detector	Polarization
	4880.0	37.7	6.0	43.6	74.0	-30.4	Peak	Horizontal
*	6593.0	36.7	10.2	46.9	79.7	-32.8	Peak	Horizontal
	7320.0	36.7	12.6	49.3	74.0	-24.7	Peak	Horizontal
*	8684.0	36.2	13.1	49.2	79.7	-30.4	Peak	Horizontal
	4880.0	37.8	6.0	43.8	74.0	-30.2	Peak	Vertical
*	5819.5	37.0	7.6	44.6	79.7	-35.0	Peak	Vertical
	7320.0	37.9	12.6	50.5	74.0	-23.5	Peak	Vertical
*	7791.5	36.2	13.1	49.3	79.7	-30.3	Peak	Vertical

Note 1: "\*" is not in restricted band, its limit is 20dBc of the fundamental emission level (99.7dBμV/m) or 15.209 which is higher.

Note 2: Measure Level (dBμV/m) = Reading Level (dBμV) + Factor (dB)

Factor (dB) = Cable Loss (dB) + Antenna Factor (dB/m) - Pre\_Amplifier Gain (dB)

Test Mode:	BLE	Test Site:	AC2
Test Channel:	39	Test Engineer:	Messiah Li
Remark:	1. Average measurement was not performed if peak level lower than average limit. 2. Other frequency was 20dB below limit line within 1-18GHz, there is not show in the report.		

Mark	Frequency (MHz)	Reading Level (dB $\mu$ V)	Factor (dB)	Measure Level (dB $\mu$ V/m)	Limit (dB $\mu$ V/m)	Margin (dB)	Detector	Polarization
	4960.0	37.5	6.1	43.6	74.0	-30.4	Peak	Horizontal
*	6525.0	36.8	10.0	46.8	79.8	-33.0	Peak	Horizontal
	7440.0	36.8	12.9	49.7	74.0	-24.3	Peak	Horizontal
*	10511.5	35.5	17.6	53.0	79.8	-26.8	Peak	Horizontal
	4960.0	38.9	6.1	45.0	74.0	-29.0	Peak	Vertical
*	6576.0	35.9	10.2	46.1	79.8	-33.7	Peak	Vertical
	7440.0	39.4	12.9	52.3	74.0	-21.7	Peak	Vertical
*	9593.5	35.7	15.2	50.9	79.8	-28.9	Peak	Vertical

Note 1: "\*" is not in restricted band, its limit is 20dBc of the fundamental emission level (99.8dB $\mu$ V/m) or 15.209 which is higher.

Note 2: Measure Level (dB $\mu$ V/m) = Reading Level (dB $\mu$ V) + Factor (dB)

Factor (dB) = Cable Loss (dB) + Antenna Factor (dB/m) - Pre\_Amplifier Gain (dB)



**The worst case of Radiated Emission below 1GHz:**

Site: AC2	Time: 2018/09/15 - 00:59
Limit: FCC_Part15.209_RE(3m)	Engineer: Messiah Li
Probe: VULB9162_0.03-8GHz	Polarity: Horizontal
EUT: Remote Control	Power: By Battery
<b>Worse Case Mode:</b> Transmit by BLE at channel 2402MHz	

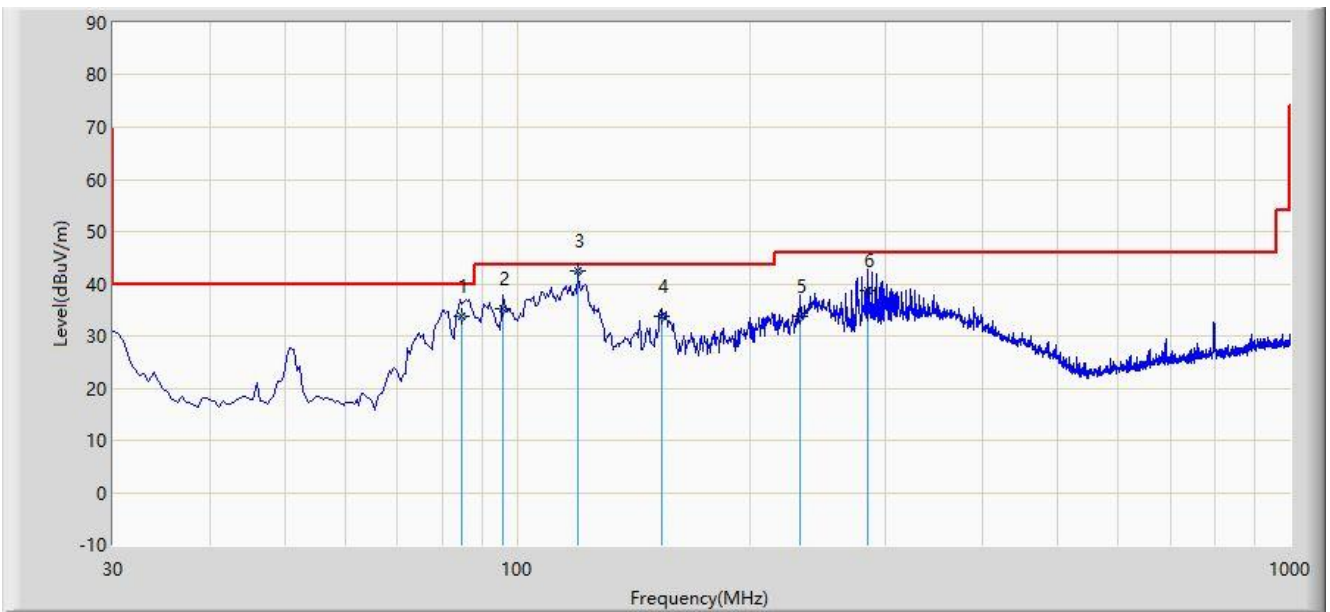

No	Flag	Mark	Frequency (MHz)	Measure Level (dBuV/m)	Reading Level (dBuV)	Over Limit (dB)	Limit (dBuV/m)	Factor (dB)	Type
1			84.740	33.824	23.612	-6.176	40.000	10.212	QP
2			95.960	35.122	24.360	-8.378	43.500	10.762	QP
3		*	119.887	42.504	29.300	-0.996	43.500	13.204	QP
4			153.675	33.754	18.460	-9.746	43.500	15.294	QP
5			232.245	33.775	21.115	-12.225	46.000	12.660	QP
6			283.655	38.772	24.770	-7.228	46.000	14.002	QP

Note 1: Measure Level (dBuV/m) = Reading Level (dBuV) + Factor (dB)

Factor (dB) = Cable Loss (dB) + Antenna Factor (dB/m)

Note 2: The test trace is same as the ambient noise and the amplitude of the emissions are attenuated more than 20dB below the permissible (the test frequency range: 9kHz ~ 30MHz, 18GHz ~ 25GHz), therefore no data appear in the report.

Site: AC2	Time: 2018/09/15 - 01:11
Limit: FCC_Part15.209_RE(3m)	Engineer: Messiah Li
Probe: VULB9162_0.03-8GHz	Polarity: Vertical
EUT: Remote Control	Power: By Battery
<b>Worse Case Mode:</b> Transmit by BLE at channel 2402MHz	

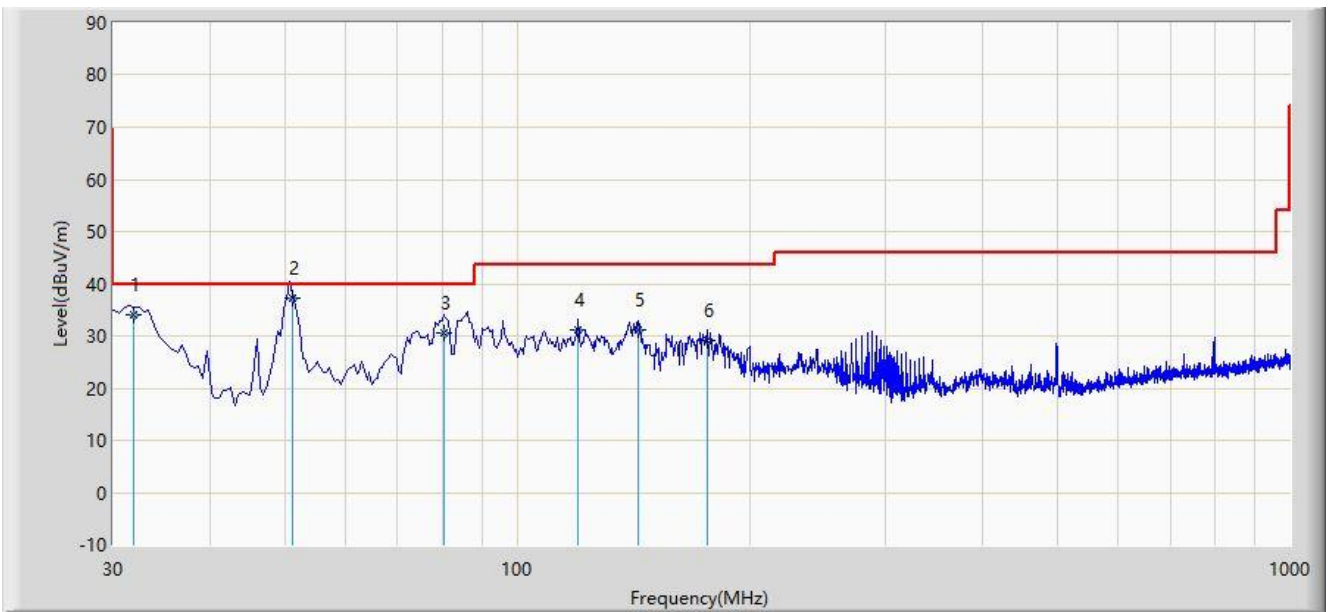

No	Flag	Mark	Frequency (MHz)	Measure Level (dBuV/m)	Reading Level (dBuV)	Over Limit (dB)	Limit (dBuV/m)	Factor (dB)	Type
1			31.940	34.001	20.189	-5.999	40.000	13.812	QP
2		*	51.109	37.310	23.200	-2.690	40.000	14.109	QP
3			80.442	30.708	20.540	-9.292	40.000	10.169	QP
4			119.725	31.195	18.005	-12.305	43.500	13.190	QP
5			143.490	31.193	16.360	-12.307	43.500	14.833	QP
6			175.985	28.996	15.493	-14.504	43.500	13.503	QP

Note 1: Measure Level (dBμV/m) = Reading Level (dBμV) + Factor (dB)

Factor (dB) = Cable Loss (dB) + Antenna Factor (dB/m)

Note 2: The test trace is same as the ambient noise and the amplitude of the emissions are attenuated more than 20dB below the permissible (the test frequency range: 9kHz ~ 30MHz, 18GHz ~ 25GHz), therefore no data appear in the report.

## 7.7. Radiated Restricted Band Edge Measurement

### 7.7.1. Test Limit

#### **For 15.205 requirement:**

Radiated emissions which fall in the restricted bands, as defined in Section 15.205(a) of FCC part 15, must also comply with the radiated emission limits specified in Section 15.209(a).

Frequency (MHz)	Frequency (MHz)	Frequency (MHz)	Frequency (GHz)
0.090 - 0.110	16.42 - 16.423	399.9 - 410	4.5 - 5.15
<sup>1</sup> 0.495 - 0.505	16.69475 - 16.69525	608 - 614	5.35 - 5.46
2.1735 - 2.1905	16.80425 - 16.80475	960 - 1240	7.25 - 7.75
4.125 - 4.128	25.5 - 25.67	1300 - 1427	8.025 - 8.5
4.17725 - 4.17775	37.5 - 38.25	1435 - 1626.5	9.0 - 9.2
4.20725 - 4.20775	73 - 74.6	1645.5 - 1646.5	9.3 - 9.5
6.215 - 6.218	74.8 - 75.2	1660 - 1710	10.6 - 12.7
6.26775 - 6.26825	108 - 121.94	1718.8 - 1722.2	13.25 - 13.4
6.31175 - 6.31225	123 - 138	2200 - 2300	14.47 - 14.5
8.291 - 8.294	149.9 - 150.05	2310 - 2390	15.35 - 16.2
8.362 - 8.366	156.52475 - 156.525	2483.5 - 2500	17.7 - 21.4
8.37625 - 8.38675	156.7 - 156.9	2690 - 2900	22.01 - 23.12
8.41425 - 8.41475	162.0125 - 167.17	3260 - 3267	23.6 - 24.0
12.29 - 12.293	167.72 - 173.2	3332 - 3339	31.2 - 31.8
12.51975 - 12.52025	240 - 285	3345.8 - 3358	36.43 - 36.5
12.57675 - 12.57725	322 - 335.4	3600 - 4400	( <sup>2</sup> )
13.36 - 13.41	--	--	--

All out of band emissions appearing in a restricted band as specified in Section 15.205 of the Title 47CFR must not exceed the limits shown in Table per Section 15.209.

FCC Part 15 Subpart C Paragraph 15.209		
Frequency [MHz]	Field Strength [uV/m]	Measured Distance [Meters]
0.009 - 0.490	2400/F (kHz)	300
0.490 - 1.705	24000/F (kHz)	30
1.705 - 30	30	30
30 - 88	100	3
88 - 216	150	3
216 - 960	200	3
Above 960	500	3

**For RSS-Gen Section 8.10 Requirement:**

Radiated emissions which fall in the restricted bands, as defined in Section 8.10 of RSS-Gen, must also comply with the radiated emission limits specified in Section 8.9.

Frequency (MHz)	Frequency (MHz)	Frequency (MHz)	Frequency (GHz)
0.090 - 0.110	16.42 - 16.423	1645.5 - 1646.5	9.0 - 9.2
0.495 - 0.505	16.69475 - 16.69525	1660 - 1710	9.3 - 9.5
2.1735 - 2.1905	16.80425 - 16.80475	1718.8-1722.2	10.6 - 12.7
3.020 - 3.026	25.5 - 25.67	2200 - 2300	13.25 - 13.4
4.125 - 4.128	37.5 - 38.25	2310-2390	14.47 - 14.5
4.17725 - 4.17775	73 - 74.6	2483.5 - 2500	15.35 - 16.2
4.20725 - 4.20775	74.8 - 75.2	2655 - 2900	17.7 - 21.4
5.677 - 5.683	108 - 138	3260 - 3267	22.01 - 23.12
6.215 - 6.218	149.9 - 150.05	3332 - 3339	23.6 - 24.0
6.26775 - 6.26825	156.52475 - 156.52525	3345.8 - 3358	31.2 - 31.8
6.31175 - 6.31225	156.7 - 156.9	3500 - 4400	36.43 - 36.5
8.291 - 8.294	162.0125 - 167.17	4500 - 5150	Above 38.6
8.362 - 8.366	167.72 - 173.2	5350 - 5460	--
8.37625 - 8.38675	240 - 285	7250 - 7750	--
8.41425 - 8.41475	322 - 335.4	8025 - 8500	--
12.29 - 12.293	399.9 - 410	--	--
12.51975 - 12.52025	608 - 614	--	--
12.57675 - 12.57725	960 - 1427	--	--
13.36 -13.41	1435 - 1626.5	--	--

**7.7.2. Test Procedure Used**

ANSI C63.10-2013 - Section 6.10.5

**7.7.3. Test Setting**

**Peak Field Strength Measurements**

1. Analyzer center frequency was set to the frequency of the radiated spurious emission of interest
2. RBW = as specified in Table 1
3. VBW = 3MHz
4. Detector = peak

5. Sweep time = auto couple
6. Trace mode = max hold
7. Trace was allowed to stabilize

### **Average Field Strength Measurements**

1. Analyzer center frequency was set to the frequency of the radiated spurious emission of interest
2. RBW = 1MHz
3. VBW  $\geq 1/T$
4. De As an alternative, the instrument may be set to linear detector mode. Ensure that video filtering is applied in linear voltage domain (rather than in a log or dB domain). Some instruments require linear display mode in order to accomplish this. Others have a setting for Average-VBW Type, which can be set to "Voltage" regardless of the display mode
5. Detector = Peak
6. Sweep time = auto
7. Trace mode = max hold
8. Allow max hold to run for at least 50 times (1/duty cycle) traces

#### **7.7.4. Test Setup**

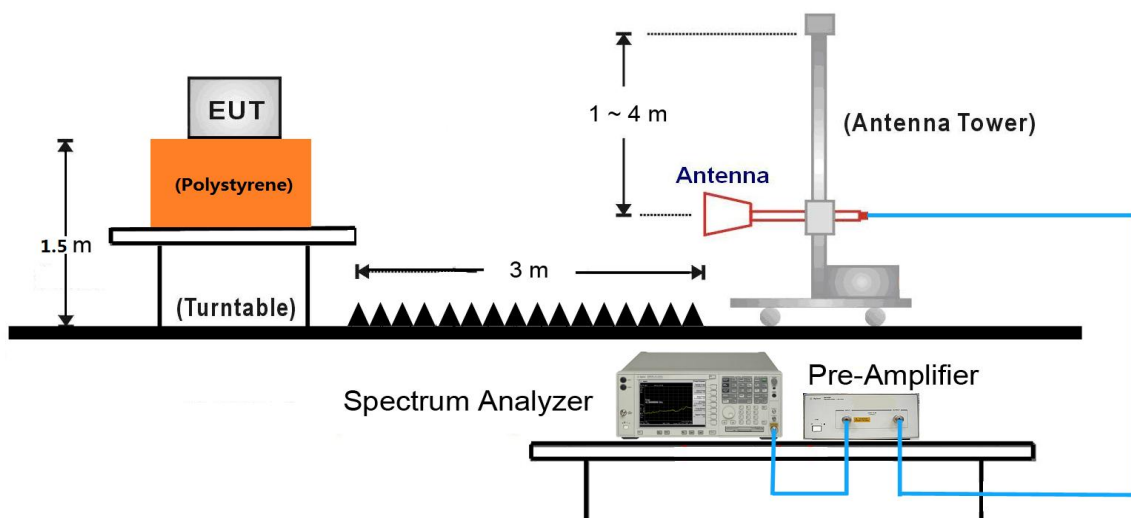

### 7.7.5. Test Result

Site: AC2	Time: 2018/09/14 - 21:05
Limit: FCC_Part15.209_RE(3m)	Engineer: Messiah Li
Probe: BBHA9120D_1-18GHz	Polarity: Horizontal
EUT: Remote Control	Power: By Battery
Test Mode: Transmit by BLE at channel 2402MHz	

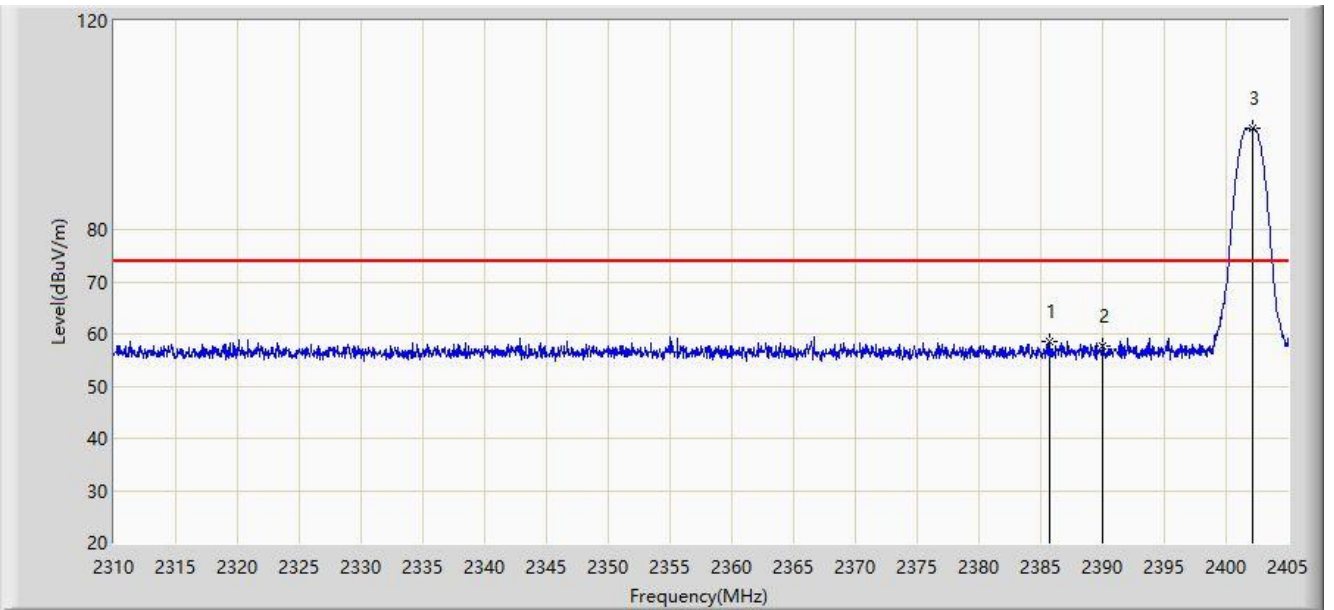

No	Flag	Mark	Frequency (MHz)	Measure Level (dBuV/m)	Reading Level (dBuV)	Over Limit (dB)	Limit (dBuV/m)	Factor (dB)	Type
1			2385.715	58.677	26.344	-15.323	74.000	32.333	PK
2			2390.000	57.687	25.360	-16.313	74.000	32.327	PK
3		*	2402.198	99.358	67.054	N/A	N/A	32.304	PK

Note: Measure Level (dBμV/m) = Reading Level (dBμV) + Factor (dB)

Factor (dB) = Cable Loss (dB) + Antenna Factor (dB/m)

Site: AC2	Time: 2018/09/14 - 21:07
Limit: FCC_Part15.209_RE(3m)	Engineer: Messiah Li
Probe: BBHA9120D_1-18GHz	Polarity: Horizontal
EUT: Remote Control	Power: By Battery
Test Mode: Transmit by BLE at channel 2402MHz	

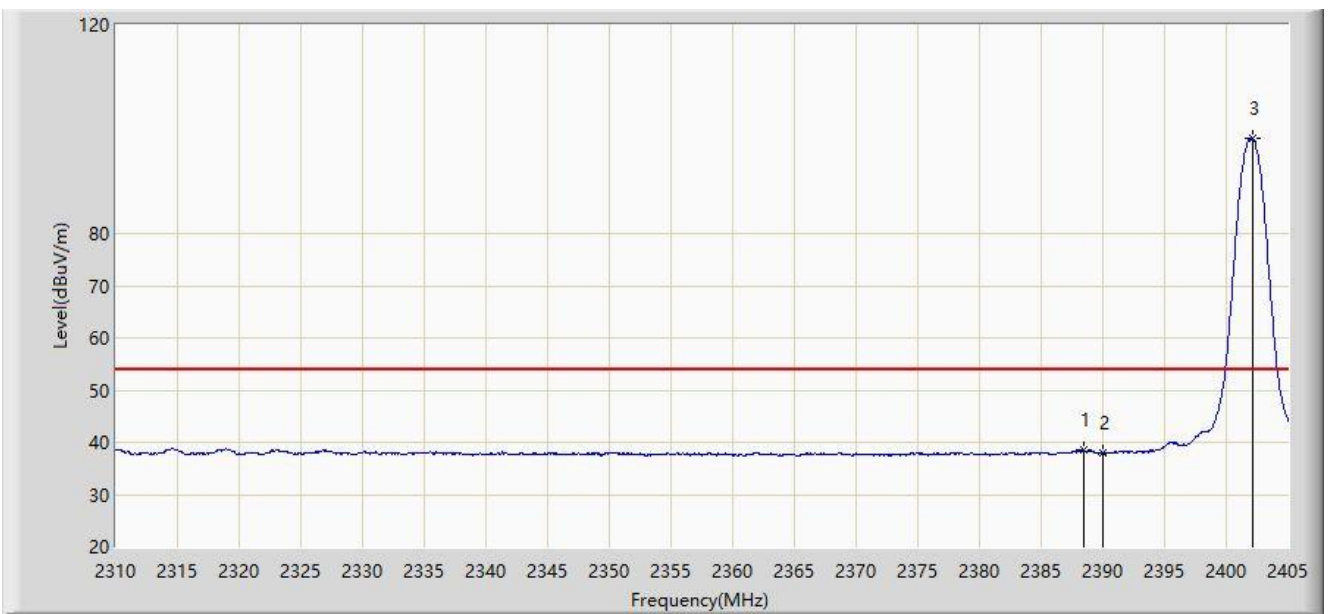

No	Flag	Mark	Frequency (MHz)	Measure Level (dBuV/m)	Reading Level (dBuV)	Over Limit (dB)	Limit (dBuV/m)	Factor (dB)	Type
1			2388.423	38.548	6.219	-15.452	54.000	32.329	AV
2			2390.000	37.993	5.666	-16.007	54.000	32.327	AV
3		*	2402.150	98.218	65.914	N/A	N/A	32.304	AV

Note: Measure Level (dBμV/m) = Reading Level (dBμV) + Factor (dB)

Factor (dB) = Cable Loss (dB) + Antenna Factor (dB/m)



Site: AC2	Time: 2018/09/14 - 21:08
Limit: FCC_Part15.209_RE(3m)	Engineer: Messiah Li
Probe: BBHA9120D_1-18GHz	Polarity: Vertical
EUT: Remote Control	Power: By Battery
Test Mode: Transmit by BLE at channel 2402MHz	

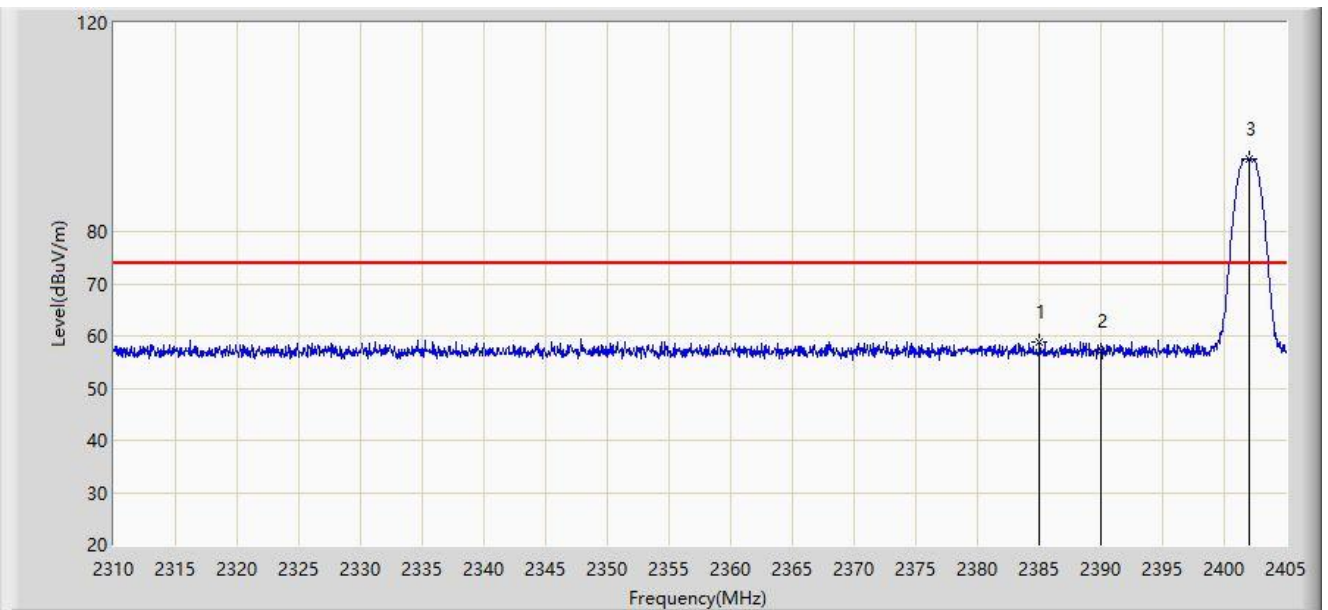

No	Flag	Mark	Frequency (MHz)	Measure Level (dBuV/m)	Reading Level (dBuV)	Over Limit (dB)	Limit (dBuV/m)	Factor (dB)	Type
1			2385.002	58.765	26.431	-15.235	74.000	32.334	PK
2			2390.000	57.040	24.713	-16.960	74.000	32.327	PK
3		*	2402.008	93.913	61.609	N/A	N/A	32.305	PK

Note: Measure Level (dB $\mu$ V/m) = Reading Level (dB $\mu$ V) + Factor (dB)

Factor (dB) = Cable Loss (dB) + Antenna Factor (dB/m)

Site: AC1	Time: 2018/09/14 - 21:10
Limit: FCC_Part15.209_RE(3m)	Engineer: Messiah Li
Probe: BBHA9120D_1-18GHz	Polarity: Vertical
EUT: Remote Control	Power: By Battery
Test Mode: Transmit by BLE at channel 2402MHz	

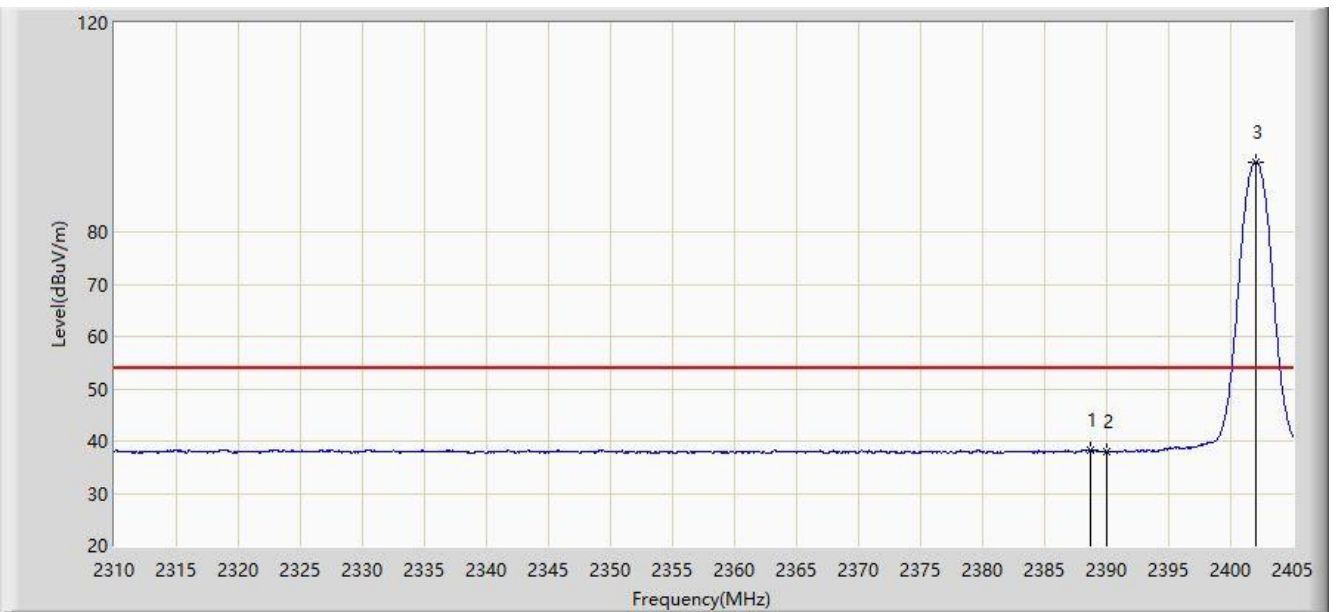

No	Flag	Mark	Frequency (MHz)	Measure Level (dBuV/m)	Reading Level (dBuV)	Over Limit (dB)	Limit (dBuV/m)	Factor (dB)	Type
1			2388.708	38.246	5.917	-15.754	54.000	32.328	AV
2			2390.000	37.996	5.669	-16.004	54.000	32.327	AV
3		*	2402.008	93.454	61.150	N/A	N/A	32.305	AV

Note: Measure Level (dB $\mu$ V/m) = Reading Level (dB $\mu$ V) + Factor (dB)

Factor (dB) = Cable Loss (dB) + Antenna Factor (dB/m)

Site: AC2	Time: 2018/09/14 - 21:21
Limit: FCC_Part15.209_RE(3m)	Engineer: Messiah Li
Probe: BBHA9120D_1-18GHz	Polarity: Horizontal
EUT: Remote Control	Power: By Battery
Test Mode: Transmit by BLE at channel 2480MHz	

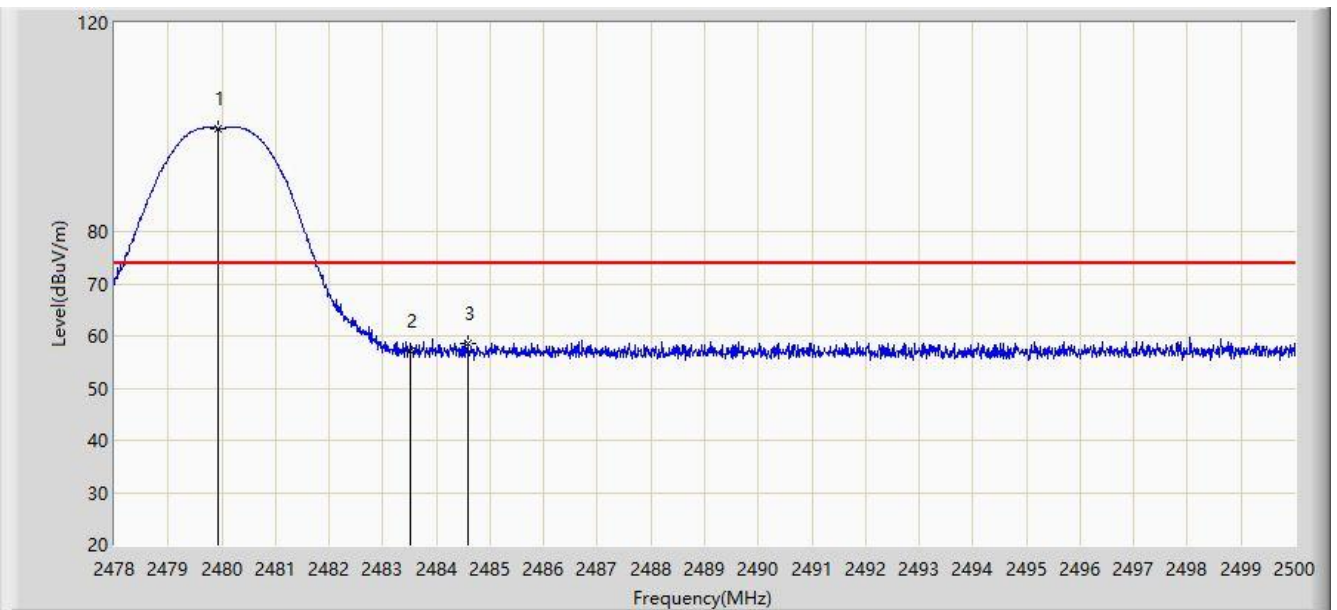

No	Flag	Mark	Frequency (MHz)	Measure Level (dBuV/m)	Reading Level (dBuV)	Over Limit (dB)	Limit (dBuV/m)	Factor (dB)	Type
1		*	2479.936	99.821	67.496	N/A	N/A	32.325	PK
2			2483.500	57.019	24.680	-16.981	74.000	32.340	PK
3			2484.578	58.665	26.322	-15.335	74.000	32.344	PK

Note: Measure Level (dB $\mu$ V/m) = Reading Level (dB $\mu$ V) + Factor (dB)

Factor (dB) = Cable Loss (dB) + Antenna Factor (dB/m)

Site: AC2	Time: 2018/09/14 - 21:23
Limit: FCC_Part15.209_RE(3m)	Engineer: Messiah Li
Probe: BBHA9120D_1-18GHz	Polarity: Horizontal
EUT: Remote Control	Power: By Battery
Test Mode: Transmit by BLE at channel 2480MHz	

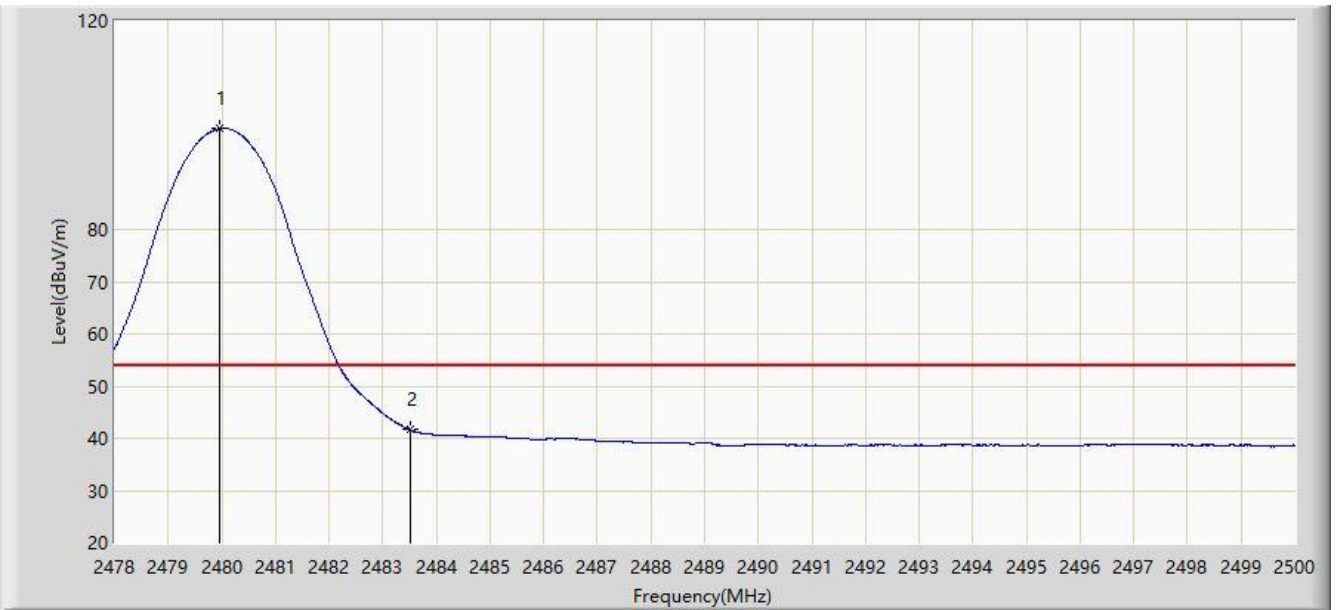

No	Flag	Mark	Frequency (MHz)	Measure Level (dBuV/m)	Reading Level (dBuV)	Over Limit (dB)	Limit (dBuV/m)	Factor (dB)	Type
1		*	2479.958	99.348	67.023	N/A	N/A	32.325	AV
2			2483.500	41.616	9.277	-12.384	54.000	32.340	AV

Note: Measure Level (dB $\mu$ V/m) = Reading Level (dB $\mu$ V) + Factor (dB)

Factor (dB) = Cable Loss (dB) + Antenna Factor (dB/m)

Site: AC2	Time: 2018/09/14 - 21:24
Limit: FCC_Part15.209_RE(3m)	Engineer: Messiah Li
Probe: BBHA9120D_1-18GHz	Polarity: Vertical
EUT: Remote Control	Power: By Battery
Test Mode: Transmit by BLE at channel 2480MHz	

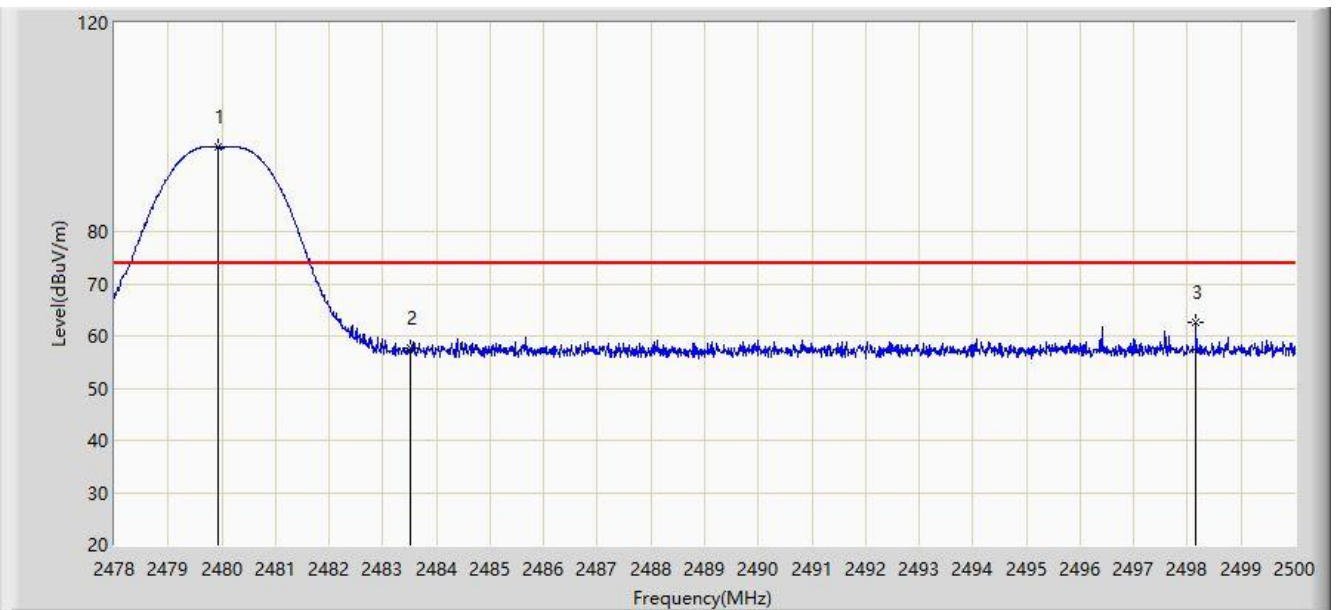

No	Flag	Mark	Frequency (MHz)	Measure Level (dBuV/m)	Reading Level (dBuV)	Over Limit (dB)	Limit (dBuV/m)	Factor (dB)	Type
1		*	2479.936	96.109	63.784	N/A	N/A	32.325	PK
2			2483.500	57.719	25.380	-16.281	74.000	32.340	PK
3			2498.163	62.672	30.280	-11.328	74.000	32.392	PK

Note: Measure Level (dB $\mu$ V/m) = Reading Level (dB $\mu$ V) + Factor (dB)

Factor (dB) = Cable Loss (dB) + Antenna Factor (dB/m)

Site: AC2	Time: 2018/09/14 - 21:26
Limit: FCC_Part15.209_RE(3m)	Engineer: Messiah Li
Probe: BBHA9120D_1-18GHz	Polarity: Vertical
EUT: Remote Control	Power: By Battery
Test Mode: Transmit by BLE at channel 2480MHz	

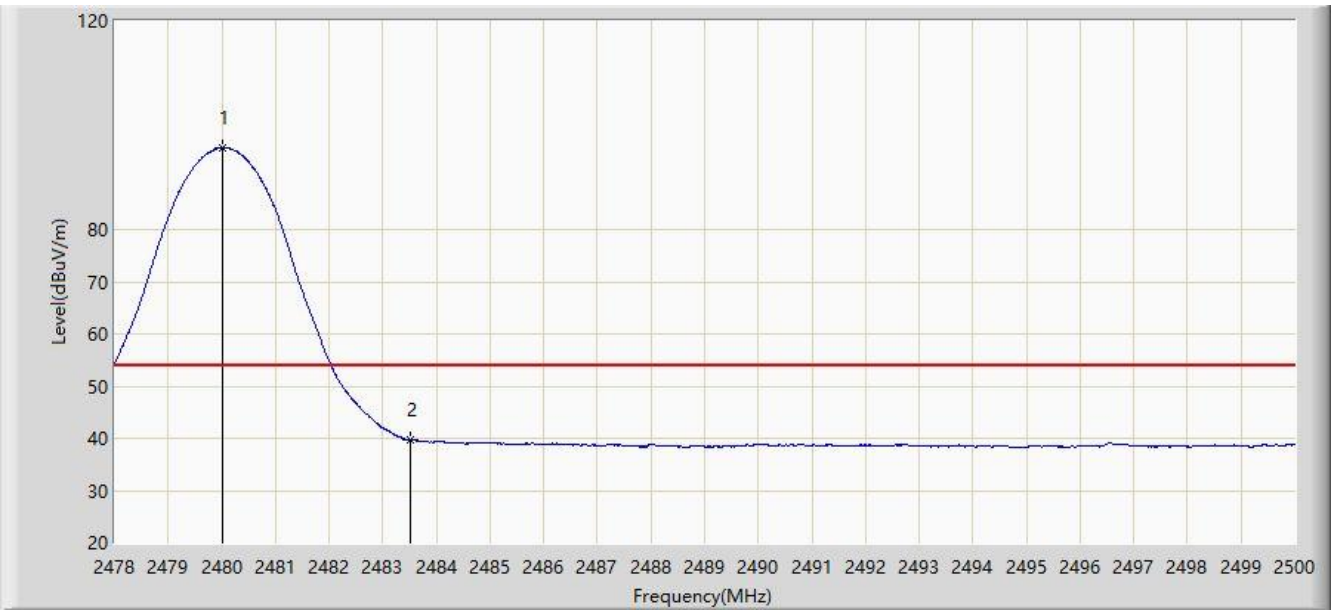

No	Flag	Mark	Frequency (MHz)	Measure Level (dBuV/m)	Reading Level (dBuV)	Over Limit (dB)	Limit (dBuV/m)	Factor (dB)	Type
1		*	2480.002	95.624	63.299	N/A	N/A	32.325	AV
2			2483.500	39.599	7.260	-14.401	54.000	32.340	AV

Note: Measure Level (dB $\mu$ V/m) = Reading Level (dB $\mu$ V) + Factor (dB)

Factor (dB) = Cable Loss (dB) + Antenna Factor (dB/m)

## 7.8. AC Conducted Emissions Measurement

### 7.8.1. Test Limit

FCC 15.207 & RSS-Gen Limits		
Frequency (MHz)	QP (dBuV)	AV (dBuV)
0.15 ~ 0.50	66 ~ 56	56 ~ 46
0.50 ~ 5.0	56	46
5.0 ~ 30	60	50

Note 1: The lower limit shall apply at the transition frequencies.

Note 2: The limit decreases linearly with the logarithm of the frequency in the range 0.15MHz to 0.5MHz.

### 7.8.2. Test Setup

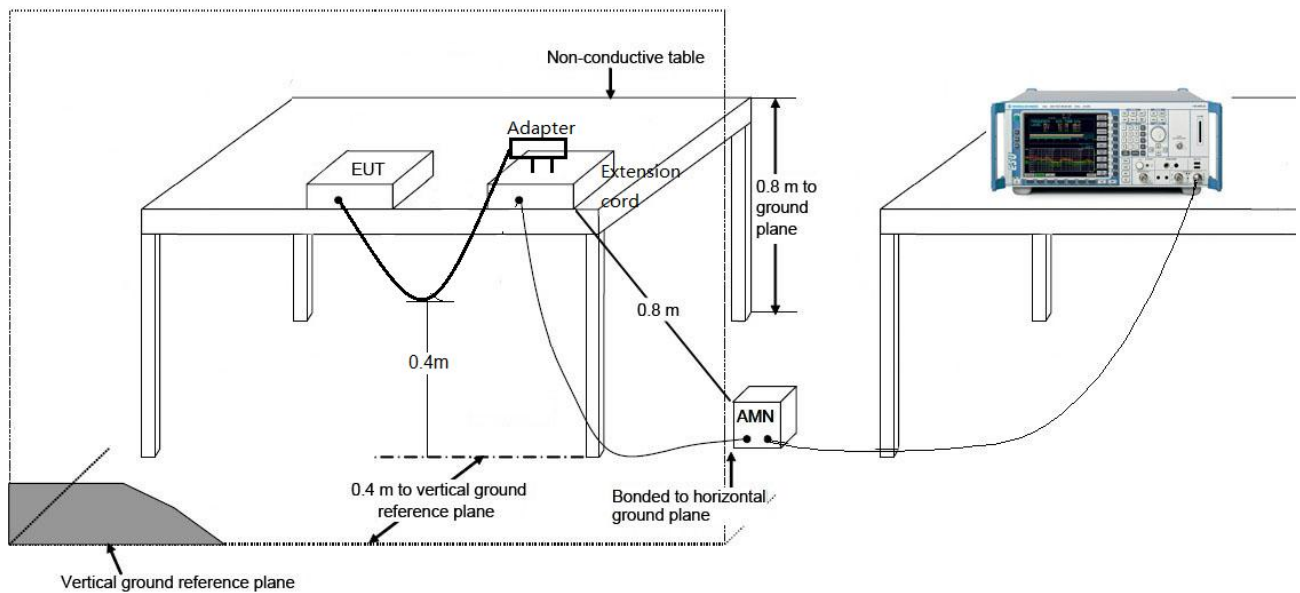

### 7.8.3. Test Result

The EUT is powered by battery, so this requirement does not apply.

## 8. CONCLUSION

The data collected relate only the item(s) tested and show that the **Remote Control** is in compliance with Part 15C of the FCC Rules and ISED Rules.

\_\_\_\_\_ The End \_\_\_\_\_



## Appendix A – Test Setup Photograph

Refer to “1809RSU016-UT” file.

## **Appendix B – EUT Photograph**

Refer to “1809RSU016-UE” file.