

10.5. Test graphs

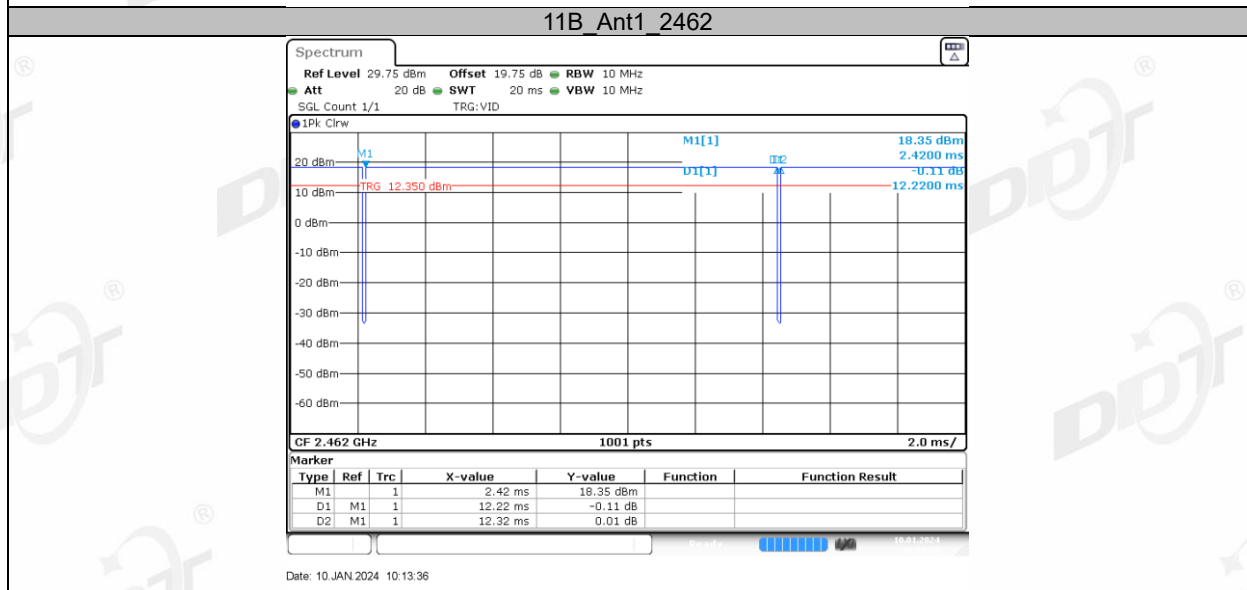

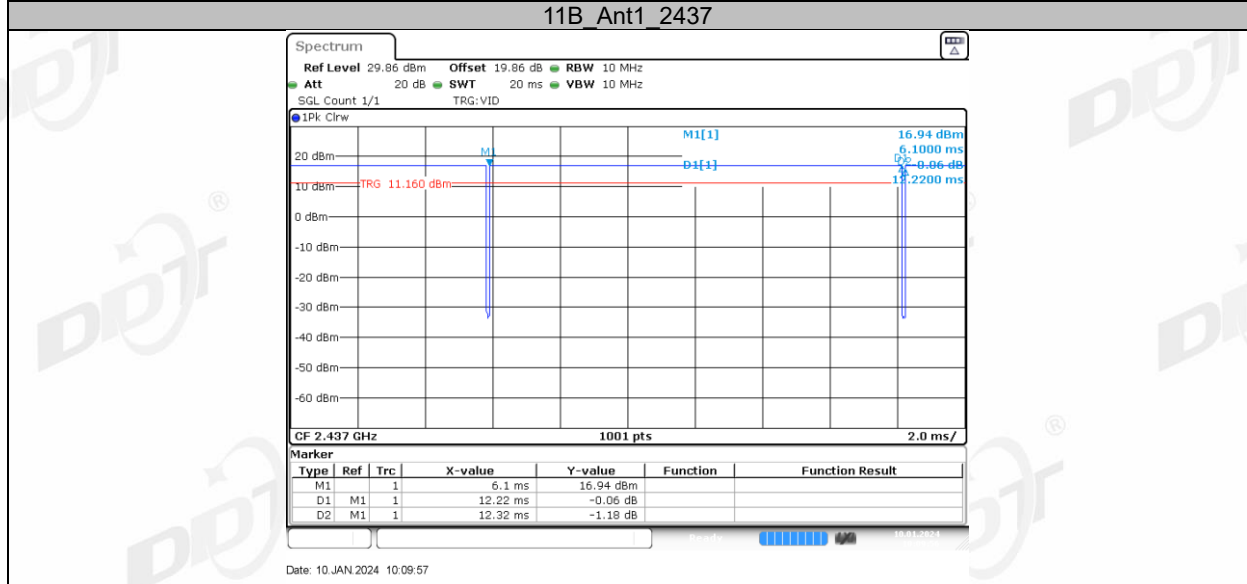

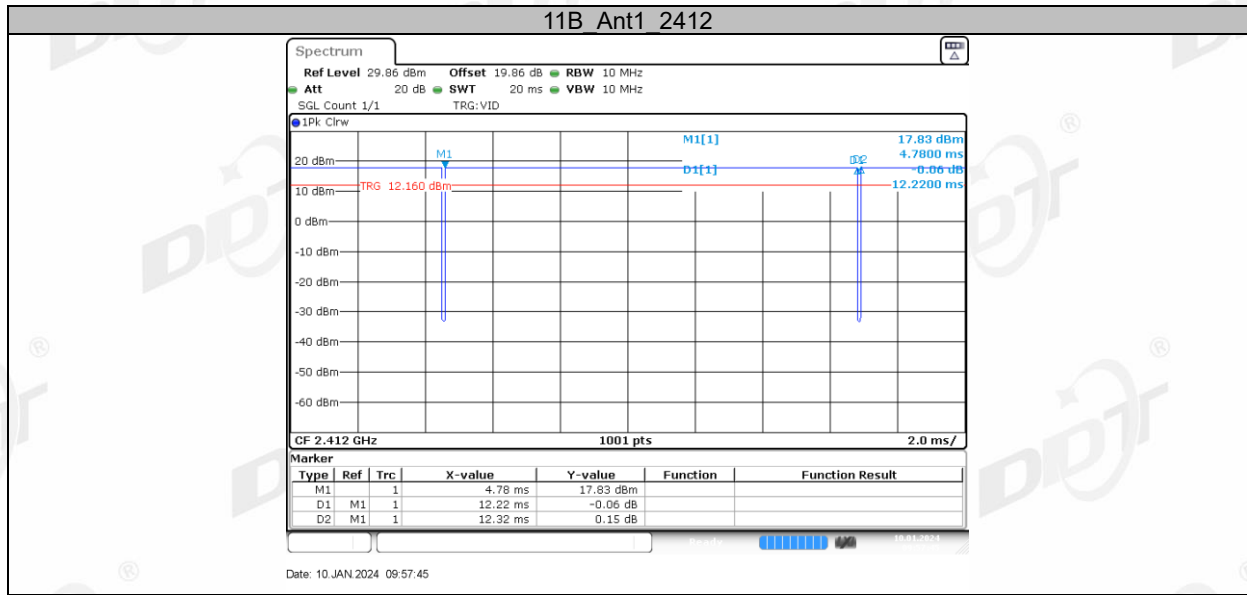

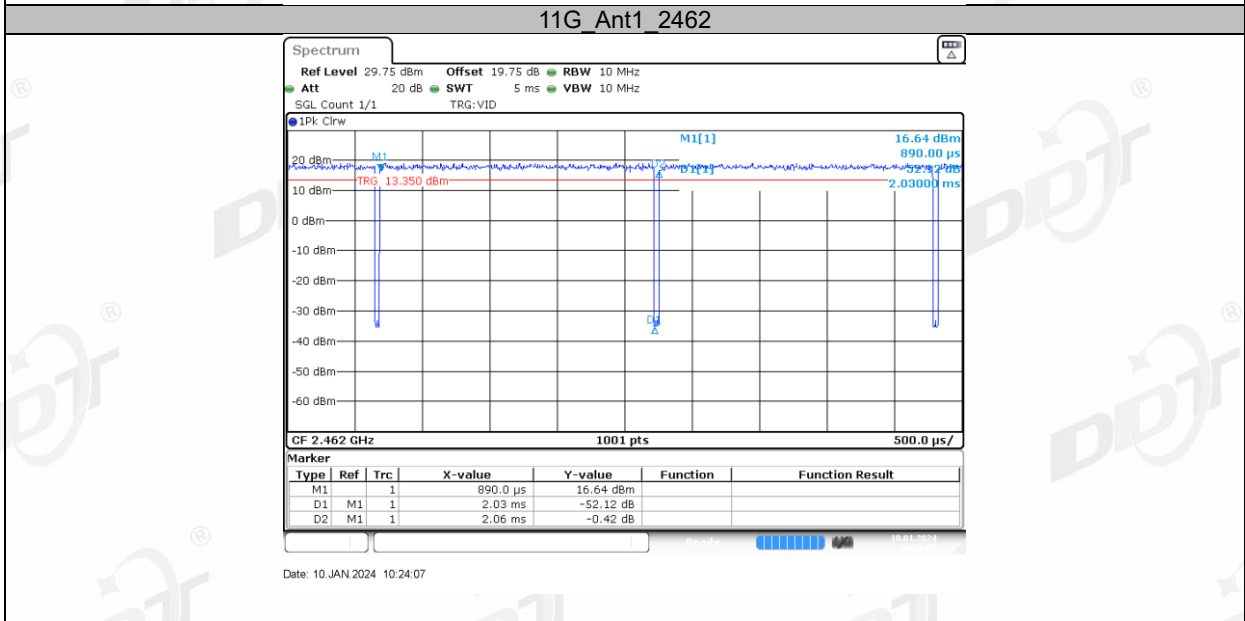
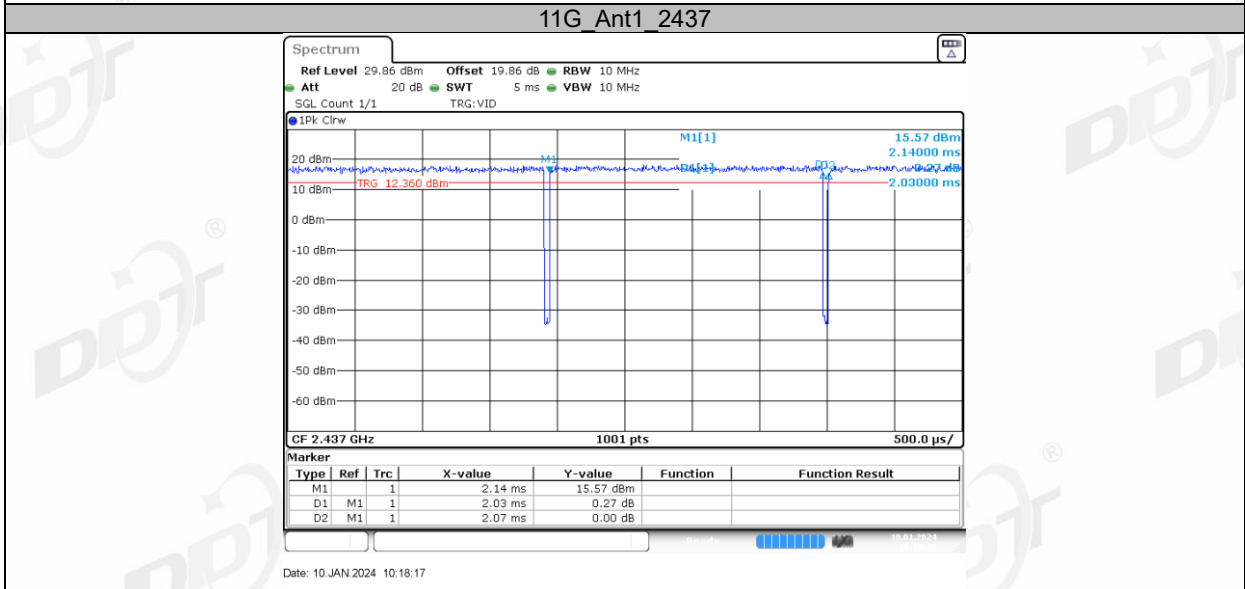
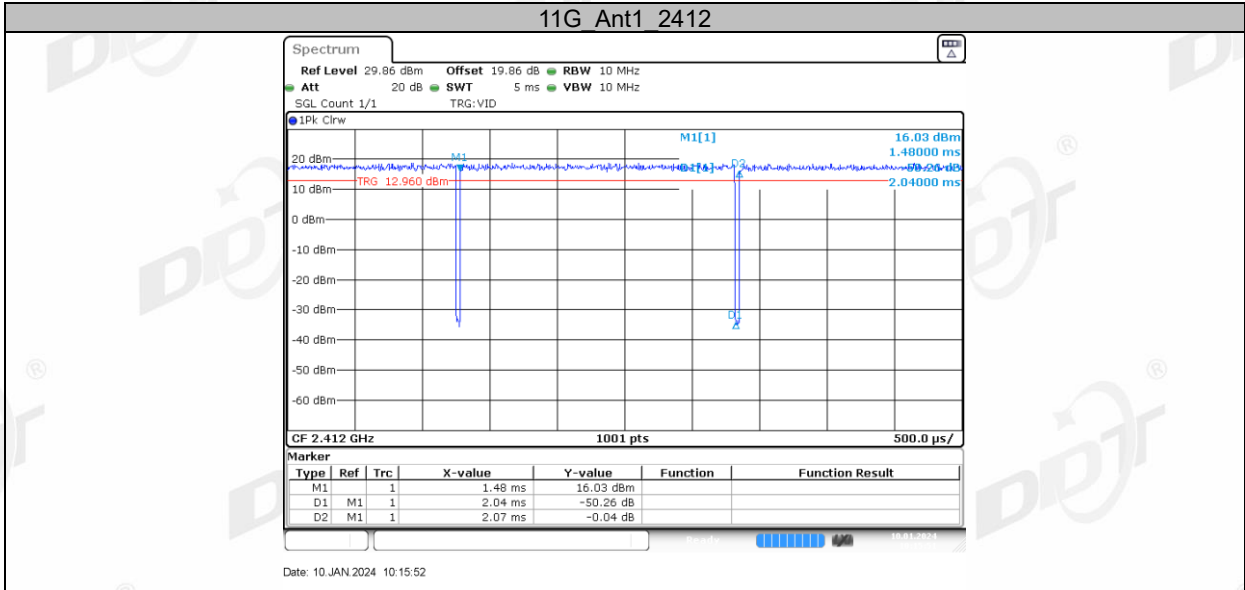
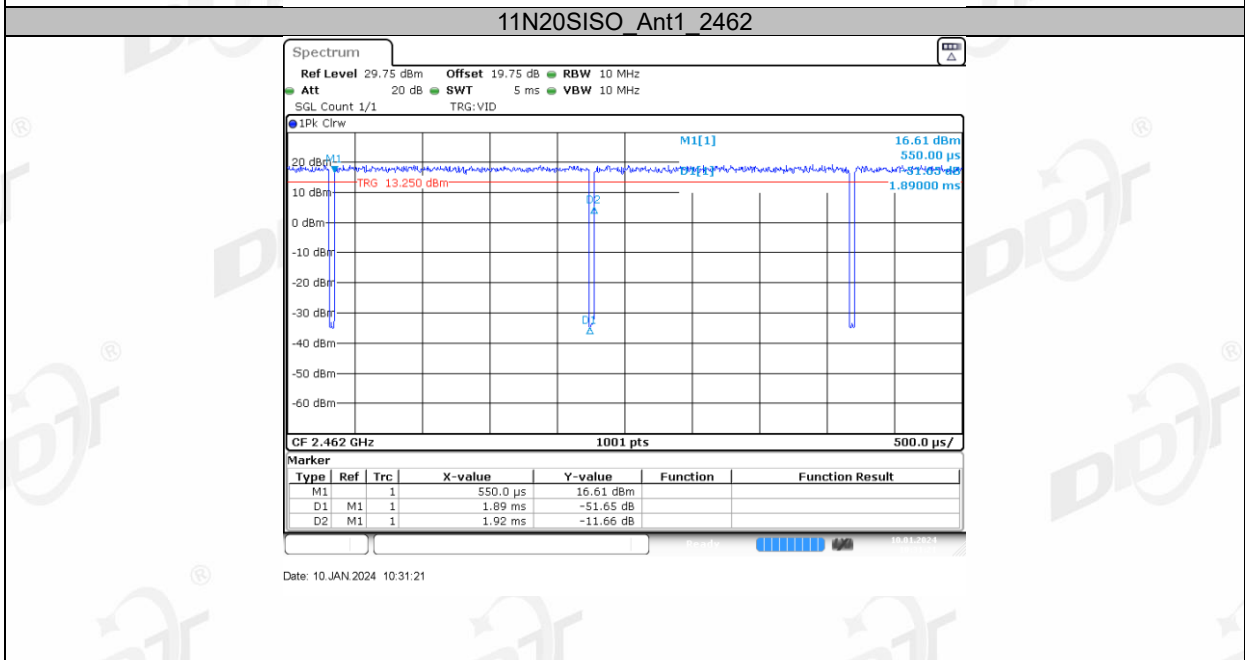
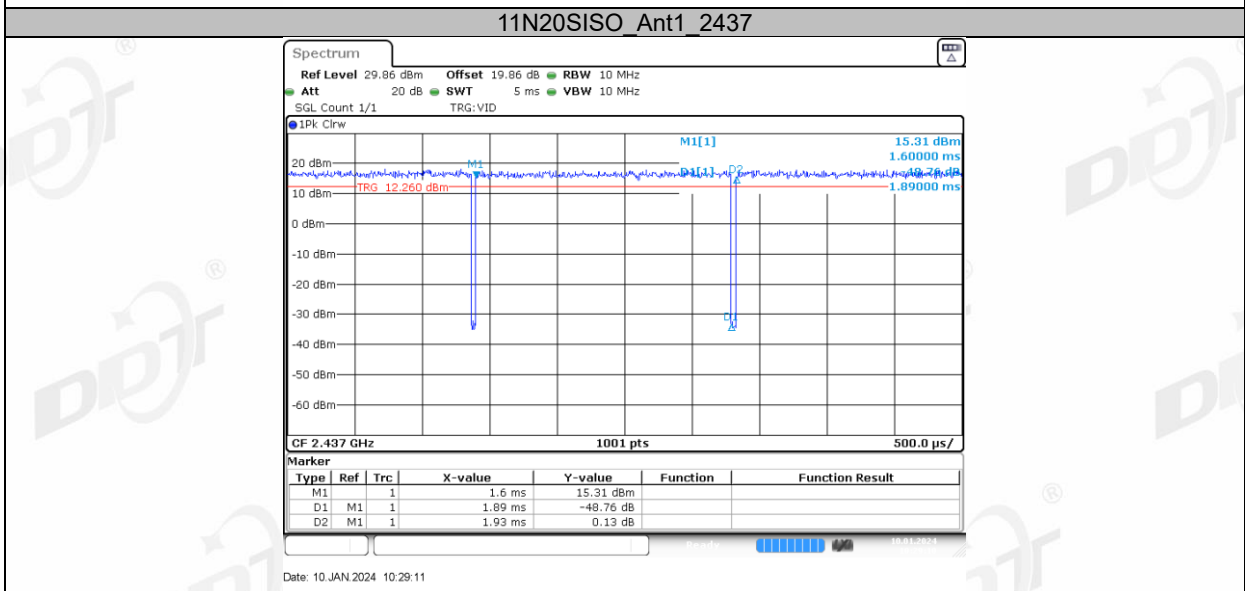
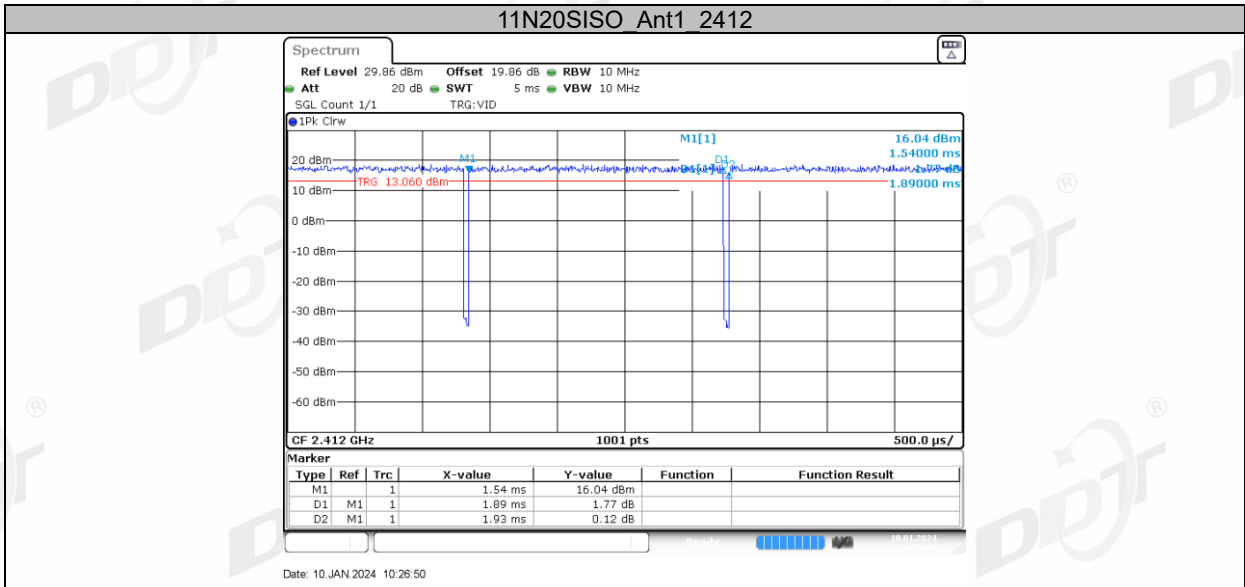
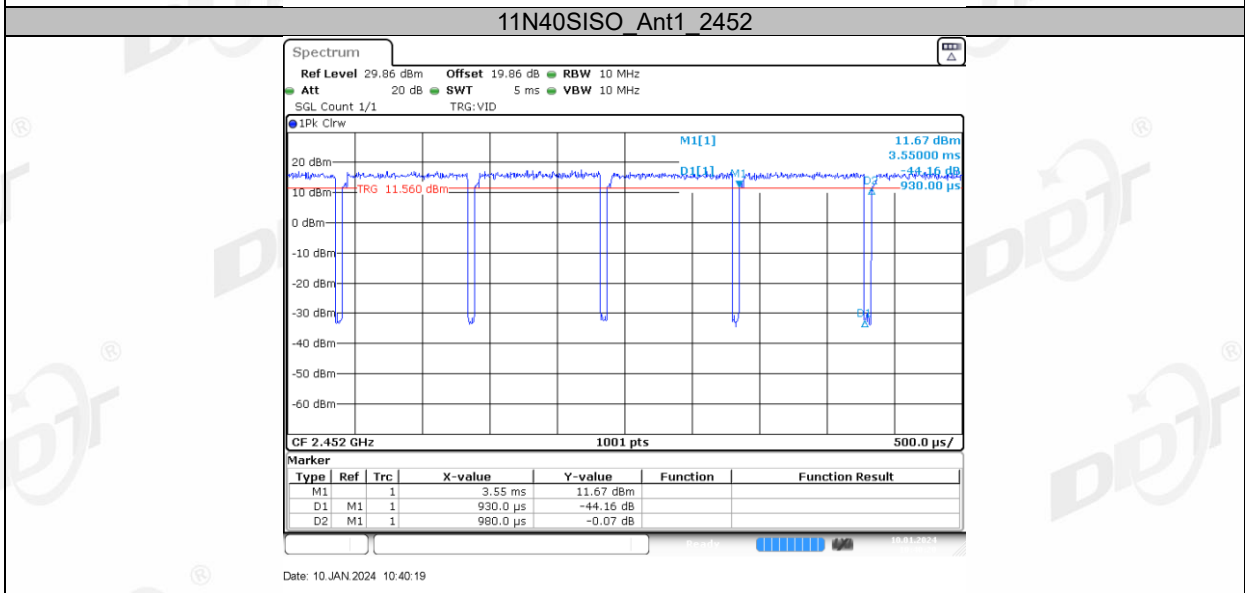
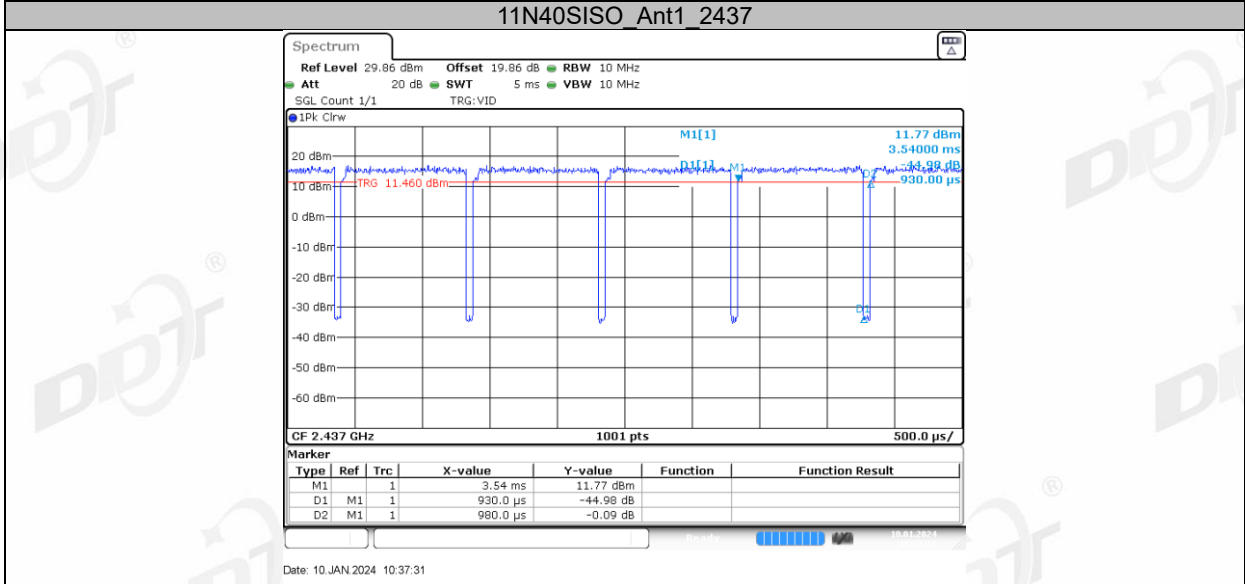
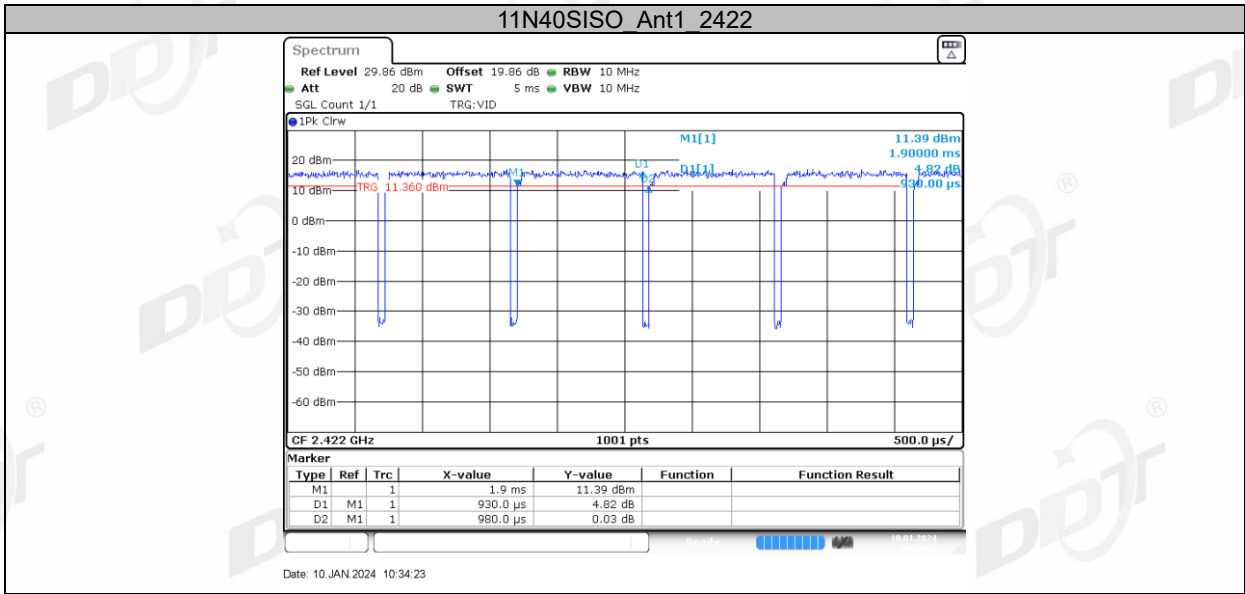

11. Radiated Spurious Emissions

11.1. Test equipment

Equipment	Manufacturer	Model No.	Serial Number	Due Date	Cal. Interval
☑ Radiation 3# Chamber					
EMI TEST RECEIVER	R&S	ESU26	100472	2024/04/22	1 Year
PSA Series Spectrum Analyzer	Agilent	E4447A	MY50180031	2024/04/22	1 Year
Active Loop Antenna	Schwarzbeck	FMZB-1519	1519-038	2024/09/10	1 Year
Trilog Broadband Antenna	Schwarzbeck	VULB 9163	01429	2024/07/11	1 Year
Double Ridged Horn Antenna	Schwarzbeck	BBHA 9120 D	02468	2024/09/17	1 Year
Broad Band Horn Antenna	Schwarzbeck	BBHA 9170	790	2024/04/25	1 Year
Pre-amplifier	COM-POWER	PAM-118A	18040084	2024/07/14	1 Year
Pre-amplifier	COM-POWER	PAM-840A	461369	2024/04/26	1 Year
RE Cable	N/A	W23.02 CP1-X2 + W23.09 AP1-X8+ JCT26S-NJ-NJ-1.5M	4.5M+8M+1.5M	2024/04/20	1 Year
RF Cable	Yuhu	JCTB810-NJ-NJ-9M+ ZT26S-SMAJ-SMAJ-1M	21123964	2024/04/22	1 Year
Band Reject Filter (2400-2500 MHz)	REBES	BRM50702	G555	N/A	N/A
Test Software	Tonscend	JS32-RE	V 5.0.0.1	N/A	N/A

11.2. Block diagram of test setup

In 3 m Anechoic Chamber, test setup diagram for 9 kHz - 30 MHz:

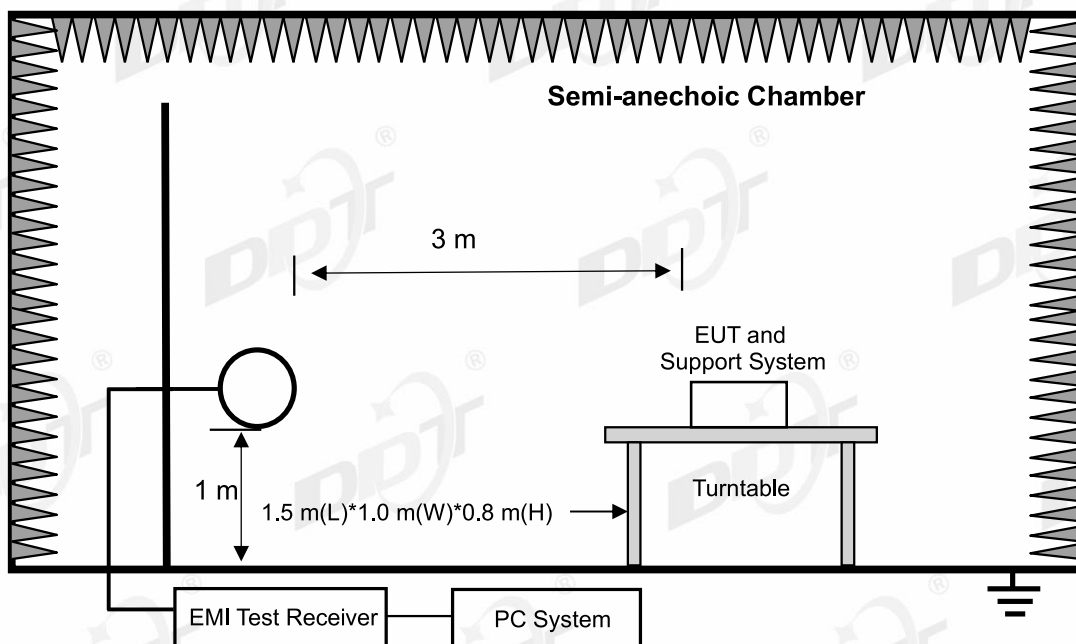

In 3 m Anechoic Chamber, test setup diagram for 30 MHz - 1 GHz:

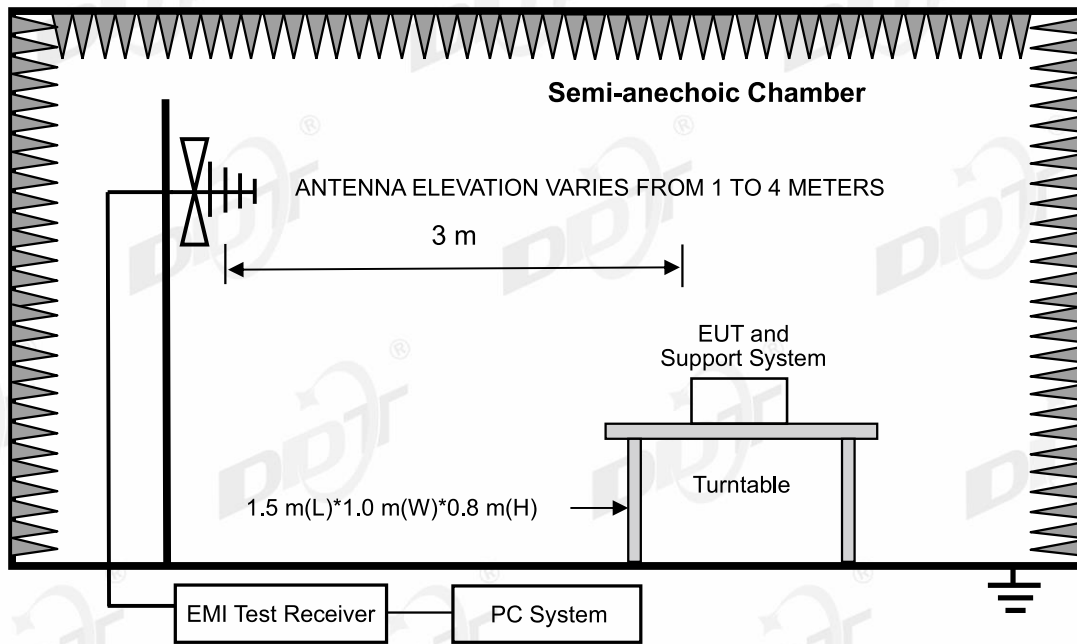

In 3 m Anechoic Chamber, test setup diagram for frequency above 1 GHz:

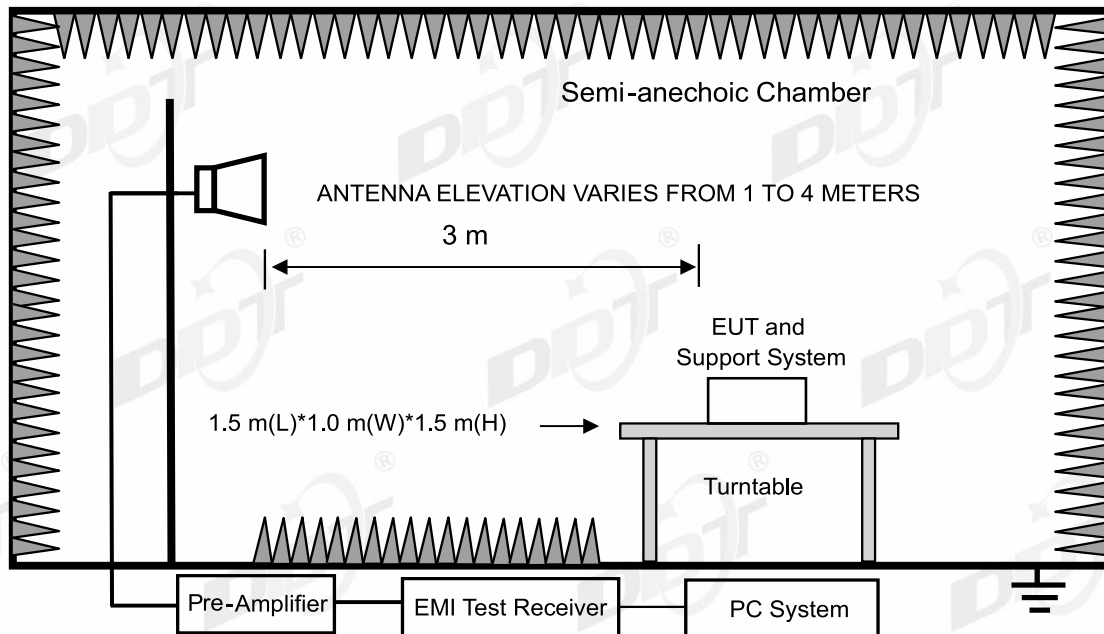

Note: For harmonic emissions test an appropriate high pass filter was inserted in the input port of AMP.

11.3. Limit

(1) FCC 15.205 Restricted frequency band:

MHz	MHz	MHz	GHz
0.090-0.110	16.42-16.423	399.9-410	4.5-5.15
¹ 0.495-0.505	16.69475-16.69525	608-614	5.35-5.46
2.1735-2.1905	16.80425-16.80475	960-1240	7.25-7.75
4.125-4.128	25.5-25.67	1300-1427	8.025-8.5
4.1772&4.17775	37.5-38.25	1435-1626.5	9.0-9.2
4.2072&4.20775	73-74.6	1645.5-1646.5	9.3-9.5
6.215-6.218	74.8-75.2	1660-1710	10.6-12.7
6.26775-6.26825	108-121.94	1718.8-1722.2	13.25-13.4
6.31175-6.31225	123-138	2200-2300	14.47-14.5
8.291-8.294	149.9-150.05	2310-2390	15.35-16.2
8.362-8.366	156.52475-156.52525	2483.5-2500	17.7-21.4
8.37625-8.38675	156.7-156.9	2690-2900	22.01-23.12
8.41425-8.41475	162.0125-167.17	3260-3267	23.6-24.0
12.29-12.293	167.72-173.2	3332-3339	31.2-31.8
12.51975-12.52025	240-285	3345.8-3358	36.43-36.5
12.57675-12.57725	322-335.4	3600-4400	(²)
13.36-13.41			

¹Until February 1, 1999, this restricted band shall be 0.490-0.510 MHz.

²Above 38.6

RSS-Gen section 8.10 Restricted frequency bands*

MHz	MHz	MHz	GHz
0.090-0.110	12.51975-12.52025	240-285	3.5-4.4
0.495-0.505	12.57675-12.57725	322-335.4	4.5-5.15
2.1735-2.1905	13.36-13.41	399.9-410	5.35-5.46
3.020-3.026	16.42-16.423	608-614	7.25-7.75
4.125-4.128	16.69475-16.69525	960-1427	8.025-8.5
4.1772&4.17775	16.80425-16.80475	1435-1626.5	9.0-9.2
4.2072&4.20775	25.5-25.67	1645.5-1646.5	9.3-9.5
5.677-5.683	37.5-38.25	1660-1710	10.6-12.7
6.215-6.218	73-74.6	1718.8-1722.2	13.25-13.4
6.26775-6.26825	74.8-75.2	2200-2300	14.47-14.5
6.31175-6.31225	108-138	2310-2390	15.35-16.2
8.291-8.294	149.9-150.05	2483.5-2500	17.7-21.4
8.362-8.366	156.52475-156.52525	2655-2900	22.01-23.12

8.37625-8.38675	156.7-156.9	3260-3267	23.6-24.0
8.41425-8.41475	162.0125-167.17	3332-3339	31.2-31.8
12.29-12.293	167.72-173.2	3345.8-3358	36.43-36.5
			Above 38.6

* Certain frequency bands listed in table and in bands above 38.6 GHz are designated for licence-exempt applications. These frequency bands and the requirements that apply to related devices are set out in the 200 and 300 series of RSSs.

(2) FCC 15.209 Limit.

Frequency (MHz)	Measurement distance (meters)	Field strength limit	
		$\mu\text{V}/\text{m}$	$\text{dB}(\mu\text{V})/\text{m}$
0.009 ~ 0.490	300	$2400/F(\text{kHz})$	$67.6-20\log(F)$
0.490 ~ 1.705	30	$24000/F(\text{kHz})$	$87.6-20\log(F)$
1.705 ~ 30.0	30	30	29.54
30 ~ 88	3	100	40.0
88 ~ 216	3	150	43.5
216 ~ 960	3	200	46.0
960 ~ 1000	3	500	54.0
Above 1000	3	74.0 $\text{dB}(\mu\text{V})/\text{m}$ (Peak), 54.0 $\text{dB}(\mu\text{V})/\text{m}$ (Average)	

Note:

(1) The emission limits shown in the above table are based on measurements employing a CISPR QP detector except for the frequency bands 9-90kHz, 110-490kHz and above 1000MHz, radiated emissions limits in these three bands are based on measurements employing an average detector.

(2) At frequencies below 30MHz, measurement may be performed at a distance closer than that specified, and the limit at closer measurement distance can be extrapolated by below

formula:

$$\text{Limit}_{3\text{m}}(\text{dB}\mu\text{V}/\text{m}) = \text{Limit}_{30\text{m}}(\text{dB}\mu\text{V}/\text{m}) + 40\log(30\text{m}/3\text{m})$$

(3) Limit for this EUT

The emissions appearing within 15.205 restricted frequency bands shall not exceed the limits shown in 15.209, and the emissions appearing within RSS-Gen section 8.10 Restricted frequency bands shall not exceed the limits shown in RSS-Gen section 8.9, all the other emissions shall be at least 20 dB below the fundamental emissions or comply with 15.209 limits and RSS-Gen section 8.9 limits.

11.4. Test procedure

- (1) EUT height should be 0.8 m for below 1 GHz at a semi - anechoic chamber while EUT height should be 1.5 m for above 1 GHz at full chamber or semi - anechoic chamber ground with absorbers.
- (2) The antenna used as below table.

Test frequency range	Test antenna used	Test antenna distance
9kHz-30MHz	Active Loop antenna	3m
30MHz-1GHz	Trilog Broadband Antenna	3m
1GHz-18GHz	Double Ridged Horn Antenna (1GHz-18GHz)	3m
18GHz-40GHz	Horn Antenna (18GHz-40GHz)	1m

According ANSI C63.10:2013 clause 6.4.6 and 6.5.3, for measurements below 30 MHz, Antenna was located 3 m from EUT, the loop antenna was positioned in three antenna orientations (parallel, perpendicular, and round-parallel), for each measurement antenna alignment, the EUT shall be rotated through 0° to 360° on a turntable, and the lowest height of the magnetic antenna shall be 1 m above the ground. For measurement above 30MHz, the trilog Broadband Antenna or Horn Antenna was located 3m from EUT, Measurements were made with the antenna positioned in both the horizontal and vertical planes of Polarization, and the measurement antenna was varied from 1 m to 4 m. in height above the reference ground plane to obtain the maximum signal strength.

(3) Below pre-scan procedure was first performed in order to find prominent frequency spectrum radiated emissions from 9 kHz to 25 GHz:

(a) Scanning the peak frequency spectrum with the antenna specified in step (3), and the EUT was rotated 360 degree, the antenna height was varied from 1 m to 4 m (Except loop antenna, it's fixed 1m above ground.)

(b) Change work frequency or channel of device if practicable.

(c) Change modulation type of device if practicable.

(d) Change power supply range from 85% to 115% of the rated supply voltage

(e) Rotated EUT though three orthogonal axes to determine the attitude of EUT arrangement produces highest emissions.

Spectrum frequency from 9 kHz to 25 GHz (tenth harmonic of fundamental frequency) was investigated, and no any obvious emission were detected from 18GHz to 25GHz, so below final test was performed with frequency range from 9kHz to 18GHz.

(4) For final emissions measurements at each frequency of interest, the EUT was rotated and the antenna height was varied between 1 m and 4 m in order to maximize the emission.

Measurements in both horizontal and vertical polarities were made and the data was recorded. In order to find the maximum emission, the relative positions of equipment and all of the interface cables were changed according to ANSI C63.10 2013 on Radiated Emission test.

- (5) The emissions from 9 kHz to 1 GHz were measured based on CISPR QP detector except for the frequency bands 9-90 kHz, 110-490 kHz, for emissions from 9 kHz-90 kHz, 110 kHz-490 kHz and above 1 GHz were measured based on average detector, for emissions above 1 GHz, peak emissions also be measured and need comply with Peak limit.
- (6) The emissions from 9 kHz to 1 GHz, QP or average values were measured with EMI receiver with below RBW

Frequency band	RBW
9 kHz-150 kHz	200 Hz
150 kHz-30 MHz	9 kHz
30 MHz-1 GHz	120 kHz

- (7) For emissions above 1GHz, both Peak and Average level were measured with Spectrum Analyzer, and the RBW is set at 1 MHz, VBW is set at 3 MHz for Peak measure; RMS detector RBW 1 MHz VBW 10 Hz for Average measure (according ANSI C63.10:2013 clause 4.2.3.2.3 procedure for average measure).

11.5. Test result

Pass. (See below detailed test result)

All the emissions except fundamental emission from 9 kHz to 25 GHz were comply with 15.209 limits and RSS-Gen section 8.9 limits.

Note 1: According exploratory test, the emission levels are 20 dB below the limit detected from 9 kHz to 30 MHz and 18 GHz to 25 GHz, so the final test was performed with frequency range from 30 MHz to 18 GHz and recorded in below.

Note 2: 30 MHz ~ 25 GHz: (Scan with all mode, the worst case is 802.11b mode)

Note 3: For emissions below 1 GHz, according exploratory explorer test, when change Tx mode and channel, have no distinct influence on emissions level, so for emissions below 1 GHz, the final test was only performed with EUT working in 802.11b mode, Tx 2412 MHz.

Note 4: For emissions above 1 GHz. If peak results comply with AV limit, AV Result is deemed to comply with AV limit, only recorded the worst case in this report.

Radiated Emission test (below 1GHz) TR-4-E-009 Radiated Emission Test Result

Test Date: 2023-11-01 **Tested By:** Bairong
EUT: All-In-One Desktop Android HiFi Music Player **Model Number:** F3051R
Test Mode: 2.4GWIFI **Power Supply:** AC 120V/60Hz
Condition: Temp:22.6°C;Humi:57.0% **Test Site:** DDT 3# Chamber
File Path: d:\ts\2023 report data\Q23101912-2E F3051R\FCC BELOW 1G\20231101-212800_H
Memo: Sample Number:S23101912-01 Power Setting:NA

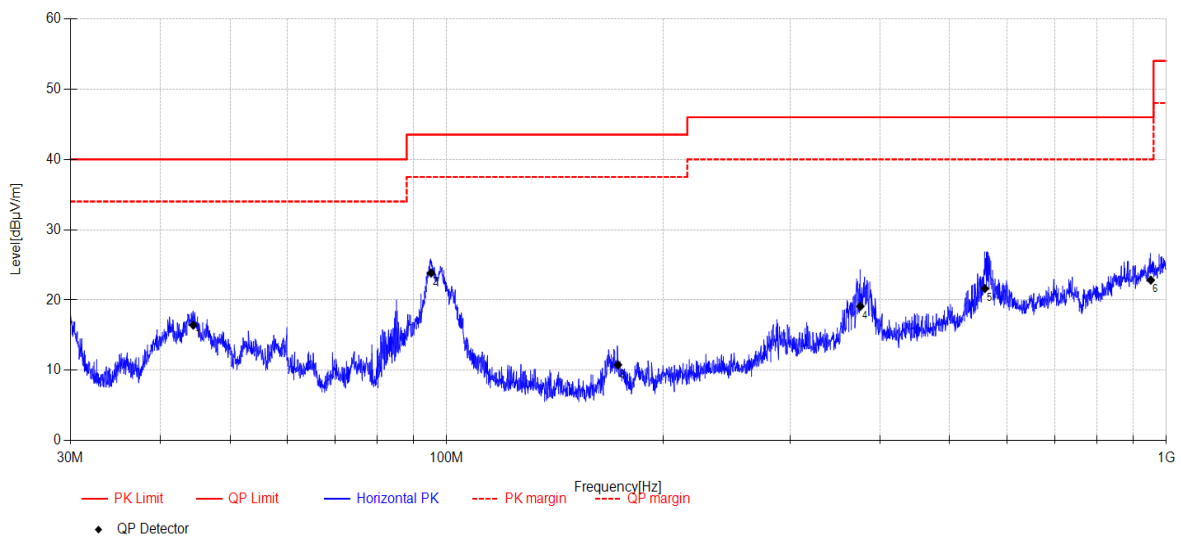

Data List										
NO.	Freq. [MHz]	Reading [dBµV/m]	Antenna Factor [dB]	Cable Loss [dB]	AMP [dB]	Result [dBµV/m]	Limit [dBµV/m]	Margin [dB]	Detector	Polarity
1	44.46	30.96	13.09	4.66	-32.28	16.43	40.00	23.57	QP	Horizontal
2	95.14	40.53	10.54	5.01	-32.24	23.84	43.50	19.66	QP	Horizontal
3	173.02	27.91	9.59	5.51	-32.23	10.78	43.50	32.72	QP	Horizontal
4	375.75	29.48	15.41	6.57	-32.35	19.11	46.00	26.89	QP	Horizontal
5	559.58	29.13	17.98	7.17	-32.64	21.64	46.00	24.36	QP	Horizontal
6	951.44	23.57	22.38	8.52	-31.63	22.84	46.00	23.16	QP	Horizontal

Note:

1. Result Level = Reading + Cable loss + Antenna Factor + AMP
2. If Peak Result complies with QP limit, QP Result is deemed to comply with QP limit.
3. Test setup: RBW: 120 kHz, VBW: 300 kHz, Sweep time: auto.

TR-4-E-009 Radiated Emission Test Result

Test Date: 2023-11-01 **Tested By:** Bairong
EUT: All-In-One Desktop Android HiFi Music Player **Model Number:** F3051R
Test Mode: 2.4GWIFI **Power Supply:** AC 120V/60Hz
Condition: Temp:22.6°C;Humi:57.0% **Test Site:** DDT 3# Chamber
File Path: d:\ts\2023 report data\Q23101912-2E F3051R\FCC BELOW 1G\20231101-212845_V
Memo: Sample Number:S23101912-01 Power Setting:NA

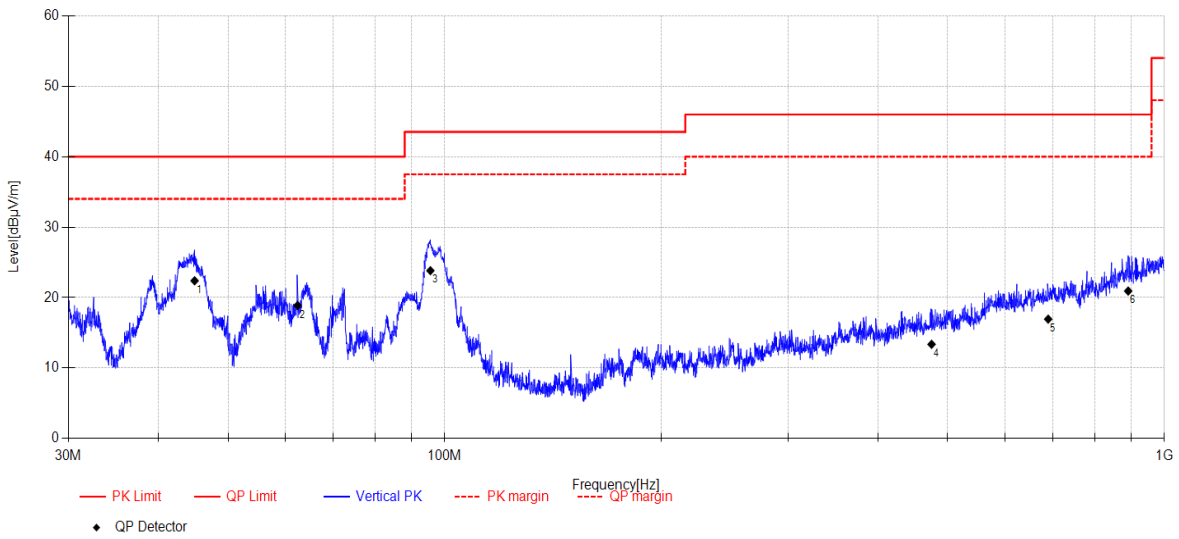

Data List										
NO.	Freq. [MHz]	Reading [dBµV/m]	Antenna Factor [dB]	Cable Loss [dB]	AMP [dB]	Result [dBµV/m]	Limit [dBµV/m]	Margin [dB]	Detector	Polarity
1	44.93	36.82	13.19	4.66	-32.28	22.39	40.00	17.61	QP	Vertical
2	62.47	33.77	12.61	4.77	-32.27	18.88	40.00	21.12	QP	Vertical
3	95.54	40.4	10.66	5.01	-32.24	23.83	43.50	19.67	QP	Vertical
4	474.90	22.71	16.29	6.87	-32.49	13.38	46.00	32.62	QP	Vertical
5	689.62	22.6	19.48	7.72	-32.85	16.95	46.00	29.05	QP	Vertical
6	890.75	23.37	21.54	8.31	-32.28	20.94	46.00	25.06	QP	Vertical

Note:

1. Result Level = Reading + Cable loss + Antenna Factor + AMP
2. If Peak Result complies with QP limit, QP Result is deemed to comply with QP limit.
3. Test setup: RBW: 120 kHz, VBW: 300 kHz, Sweep time: auto.

TR-4-E-009 Radiated Emission Test Result

Test Date: 2023-11-10 **Tested By:** Bairong
EUT: All-In-One Desktop Android HiFi Music Player **Model Number:** F3051R
Test Mode: 11B TX 2412MHz **Power Supply:** AC 230V/50Hz
Condition: Temp:22.6°C;Humi:57.0% **Test Site:** DDT 3# Chamber
File Path: d:\ts\2023 report data\Q23101912-2E F3051R\FCC ABOVE 1G 2.4GWIFI\24
Memo: Sample Number:S23101912-01 Power Setting:NA

Test Graph

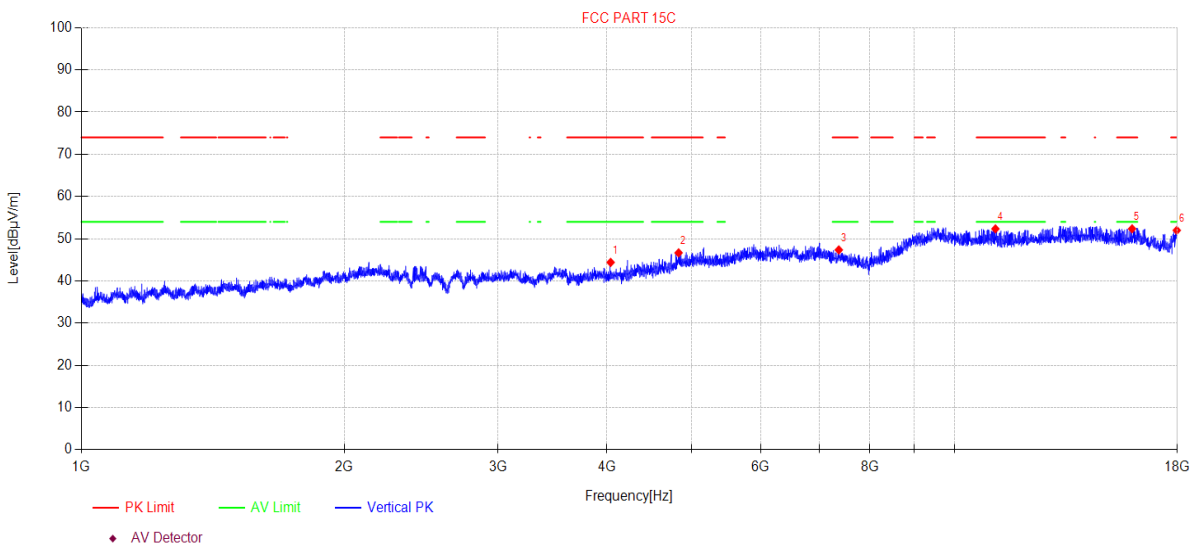

Data List										
NO.	Freq. [MHz]	Reading [dBμV/m]	Antenna Factor [dB]	Cable loss [dB]	AMP [dB]	Level [dBμV/m]	Limit [dBμV/m]	Margin [dB]	Detector	Polarity
1	4038.65	47.92	30.98	5.93	-40.44	44.39	74.00	29.61	PK	Vertical
2	4831.20	45.96	33.31	7.53	-40.14	46.66	74.00	27.34	PK	Vertical
3	7371.53	44.58	36.76	7.64	-41.63	47.35	74.00	26.65	PK	Vertical
4	11140.84	42.46	39.26	9.78	-39.16	52.34	74.00	21.66	PK	Vertical
5	15974.78	37.89	38.03	15.77	-39.34	52.35	74.00	21.65	PK	Vertical
6	17974.01	38.95	42.27	13.10	-42.34	51.98	74.00	22.02	PK	Vertical

Note:

1. Level = Reading + Cable loss + Antenna Factor + AMP
2. If Peak Result complies with AV limit, AV Result is deemed to comply with AV limit.
3. Test setup: RBW: 1 MHz, VBW: 3 MHz, Sweep time: auto.

TR-4-E-009 Radiated Emission Test Result

Test Date: 2023-11-10 **Tested By:** Bairong
EUT: All-In-One Desktop Android HiFi Music Player **Model Number:** F3051R
Test Mode: 11B TX 2437MHz **Power Supply:** AC 230V/50Hz
Condition: Temp:22.6°C;Humi:57.0% **Test Site:** DDT 3# Chamber
File Path: d:\ts\2023 report data\Q23101912-2E F3051R\FCC ABOVE 1G 2.4GWIFI\25
Memo: Sample Number:S23101912-01 Power Setting:NA

Test Graph

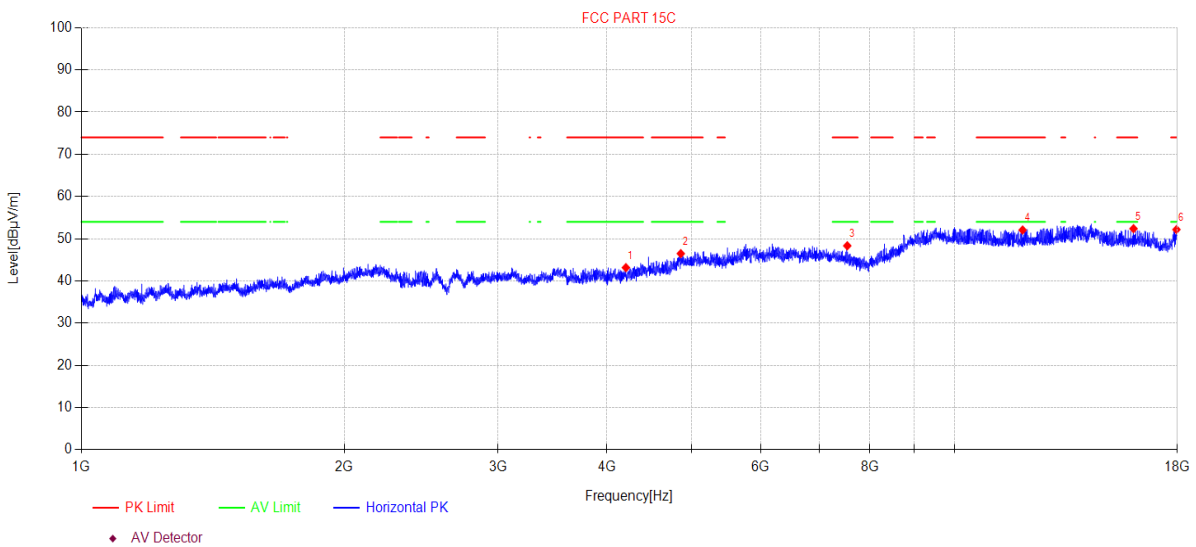

Data List										
NO.	Freq. [MHz]	Reading [dBμV/m]	Antenna Factor [dB]	Cable loss [dB]	AMP [dB]	Level [dBμV/m]	Limit [dBμV/m]	Margin [dB]	Detector	Polarity
1	4204.19	46.05	31.22	6.26	-40.37	43.16	74.00	30.84	PK	Horizontal
2	4859.21	45.36	33.65	7.59	-40.13	46.47	74.00	27.53	PK	Horizontal
3	7537.41	46.29	36.43	7.65	-42.04	48.33	74.00	25.67	PK	Horizontal
4	11968.67	41.99	39.11	10.51	-39.55	52.06	74.00	21.94	PK	Horizontal
5	16034.91	38.06	37.97	15.74	-39.39	52.38	74.00	21.62	PK	Horizontal
6	17958.43	39.22	42.19	13.08	-42.31	52.18	74.00	21.82	PK	Horizontal

Note:

1. Level = Reading + Cable loss + Antenna Factor + AMP
2. If Peak Result complies with AV limit, AV Result is deemed to comply with AV limit.
3. Test setup: RBW: 1 MHz, VBW: 3 MHz, Sweep time: auto.

TR-4-E-009 Radiated Emission Test Result

Test Date: 2023-11-10 **Tested By:** Bairong
EUT: All-In-One Desktop Android HiFi Music Player **Model Number:** F3051R
Test Mode: 11B TX 2437MHz **Power Supply:** AC 230V/50Hz
Condition: Temp:22.6°C;Humi:57.0% **Test Site:** DDT 3# Chamber
File Path: d:\ts\2023 report data\Q23101912-2E F3051R\FCC ABOVE 1G 2.4GWIFI\26
Memo: Sample Number:S23101912-01 Power Setting:NA

Test Graph

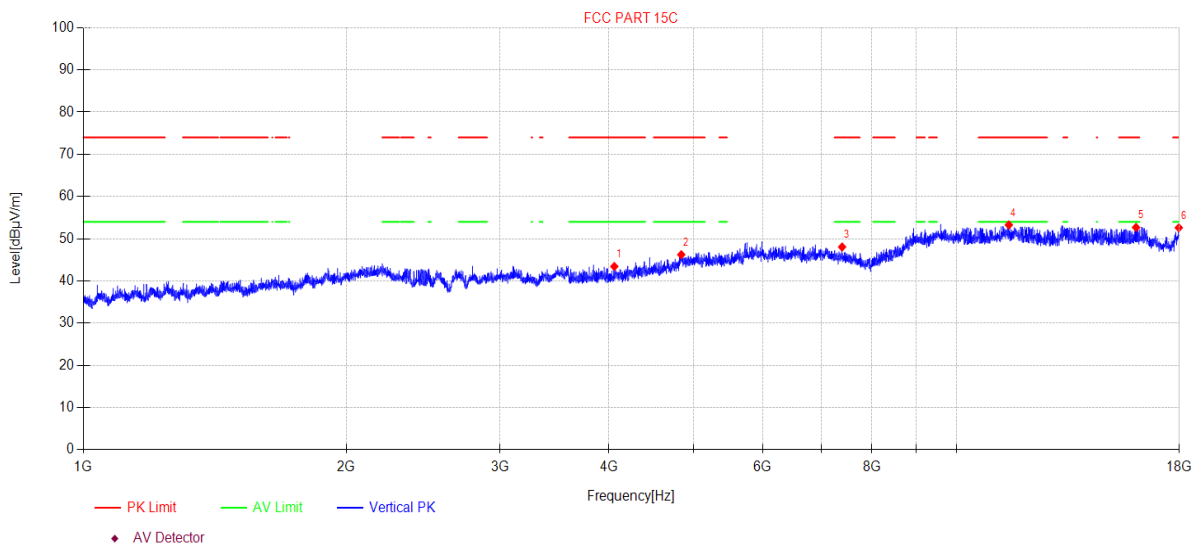

Data List										
NO.	Freq. [MHz]	Reading [dBμV/m]	Antenna Factor [dB]	Cable loss [dB]	AMP [dB]	Level [dBμV/m]	Limit [dBμV/m]	Margin [dB]	Detector	Polarity
1	4056.19	46.89	31.01	5.96	-40.43	43.43	74.00	30.57	PK	Vertical
2	4839.59	45.28	33.53	7.55	-40.14	46.22	74.00	27.78	PK	Vertical
3	7397.14	45.39	36.71	7.64	-41.69	48.05	74.00	25.95	PK	Vertical
4	11480.79	43.29	39.22	10.08	-39.32	53.27	74.00	20.73	PK	Vertical
5	16058.10	38.50	37.94	15.65	-39.41	52.68	74.00	21.32	PK	Vertical
6	17974.01	39.58	42.27	13.10	-42.34	52.61	74.00	21.39	PK	Vertical

Note:

1. Level = Reading + Cable loss + Antenna Factor + AMP
2. If Peak Result complies with AV limit, AV Result is deemed to comply with AV limit.
3. Test setup: RBW: 1 MHz, VBW: 3 MHz, Sweep time: auto.

TR-4-E-009 Radiated Emission Test Result

Test Date: 2023-11-10 **Tested By:** Bairong
EUT: All-In-One Desktop Android HiFi Music Player **Model Number:** F3051R
Test Mode: 11B TX 2462MHz **Power Supply:** AC 230V/50Hz
Condition: Temp:22.6°C;Humi:57.0% **Test Site:** DDT 3# Chamber
File Path: d:\ts\2023 report data\Q23101912-2E F3051R\FCC ABOVE 1G 2.4GWIFI\27
Memo: Sample Number:S23101912-01 Power Setting:NA

Test Graph

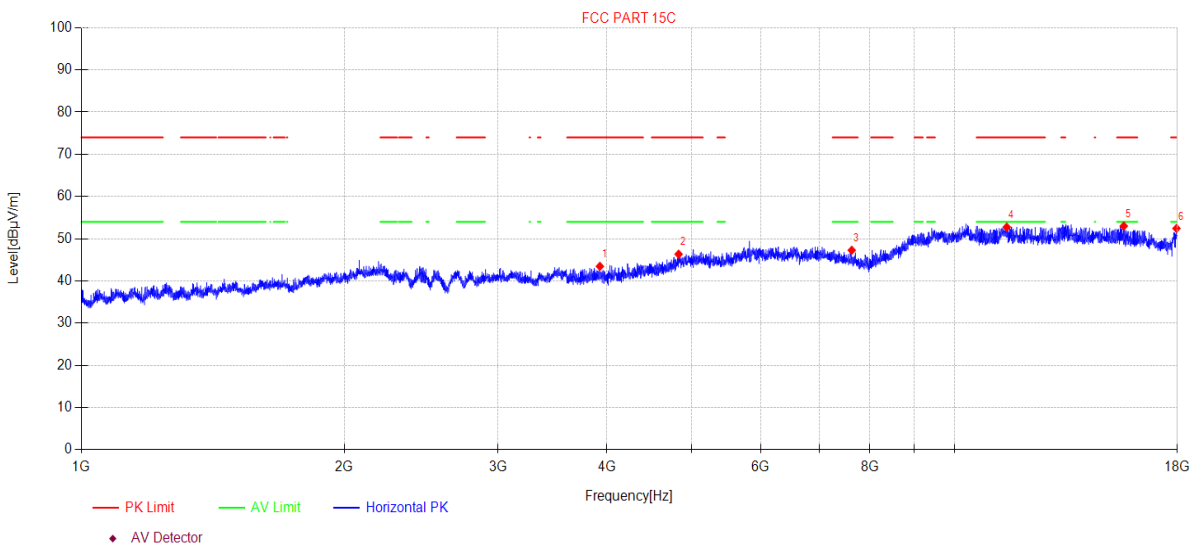

Data List										
NO.	Freq. [MHz]	Reading [dBμV/m]	Antenna Factor [dB]	Cable loss [dB]	AMP [dB]	Level [dBμV/m]	Limit [dBμV/m]	Margin [dB]	Detector	Polarity
1	3925.87	46.88	31.15	5.83	-40.40	43.46	74.00	30.54	PK	Horizontal
2	4831.20	45.63	33.31	7.53	-40.14	46.33	74.00	27.67	PK	Horizontal
3	7627.26	45.34	36.55	7.65	-42.27	47.27	74.00	26.73	PK	Horizontal
4	11477.47	42.78	39.22	10.07	-39.31	52.76	74.00	21.24	PK	Horizontal
5	15627.73	39.38	38.57	14.19	-39.14	53.00	74.00	21.00	PK	Horizontal
6	17958.43	39.48	42.19	13.08	-42.31	52.44	74.00	21.56	PK	Horizontal

Note:

1. Level = Reading + Cable loss + Antenna Factor + AMP
2. If Peak Result complies with AV limit, AV Result is deemed to comply with AV limit.
3. Test setup: RBW: 1 MHz, VBW: 3 MHz, Sweep time: auto.

TR-4-E-009 Radiated Emission Test Result

Test Date: 2023-11-10 **Tested By:** Bairong
EUT: All-In-One Desktop Android HiFi Music Player **Model Number:** F3051R
Test Mode: 11B TX 2462MHz **Power Supply:** AC 230V/50Hz
Condition: Temp:22.6°C;Humi:57.0% **Test Site:** DDT 3# Chamber
File Path: d:\ts\2023 report data\Q23101912-2E F3051R\FCC ABOVE 1G 2.4GWIFI\28
Memo: Sample Number:S23101912-01 Power Setting:NA

Test Graph

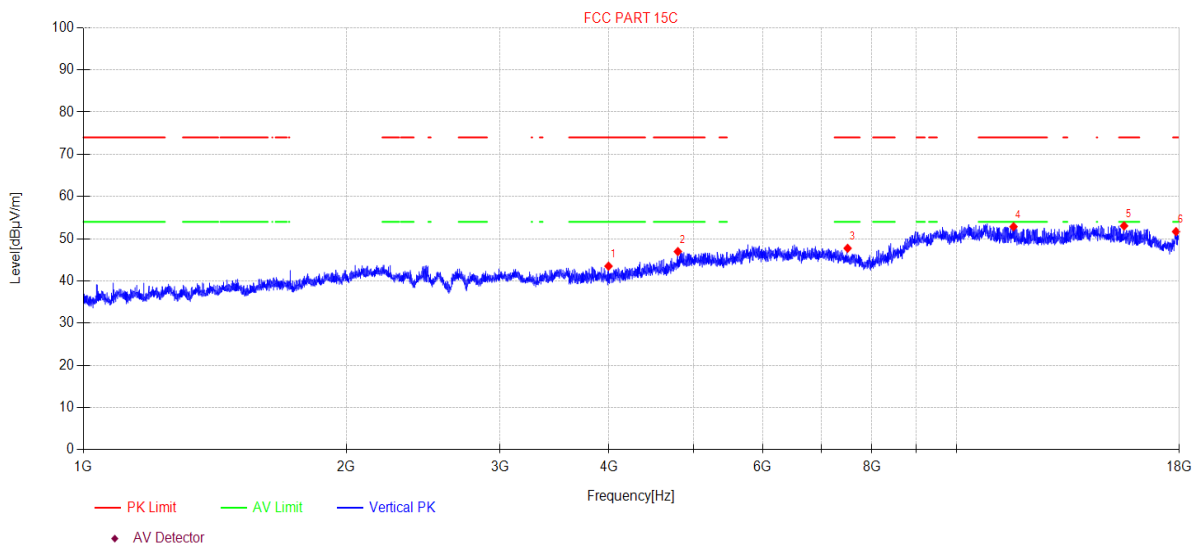

Data List										
NO.	Freq. [MHz]	Reading [dBμV/m]	Antenna Factor [dB]	Cable loss [dB]	AMP [dB]	Level [dBμV/m]	Limit [dBμV/m]	Margin [dB]	Detector	Polarity
1	3994.54	47.18	30.92	5.85	-40.45	43.50	74.00	30.50	PK	Vertical
2	4796.42	47.17	32.49	7.46	-40.16	46.96	74.00	27.04	PK	Vertical
3	7504.81	45.56	36.49	7.65	-41.96	47.74	74.00	26.26	PK	Vertical
4	11624.35	43.02	39.00	10.21	-39.38	52.85	74.00	21.15	PK	Vertical
5	15560.13	39.57	38.68	13.89	-39.10	53.04	74.00	20.96	PK	Vertical
6	17844.61	39.50	41.29	12.94	-42.05	51.68	74.00	22.32	PK	Vertical

Note:

1. Level = Reading + Cable loss + Antenna Factor + AMP
2. If Peak Result complies with AV limit, AV Result is deemed to comply with AV limit.
3. Test setup: RBW: 1 MHz, VBW: 3 MHz, Sweep time: auto.

12. Radiated Band Edge Compliance

12.1. Test equipment

Equipment	Manufacturer	Model No.	Serial Number	Due Date	Cal. Interval
☑Radiation 3#Chamber					
EMI TEST RECEIVER	R&S	ESU26	100472	2024/04/22	1 Year
Double Ridged Horn Antenna	Schwarzbeck	BBHA 9120 D	02468	2024/09/17	1 Year
Pre-amplifier	COM-POWER	PAM-118A	18040084	2024/07/14	1 Year
RF Cable	Yuhu	JCTB810-NJ-NJ-9M+ ZT26S-SMAJ-SMAJ-1M	21123964	2024/04/22	1 Year
Test Software	Tonscend	JS32-RE	V 5.0.0.1	N/A	N/A

12.2. Block diagram of test setup

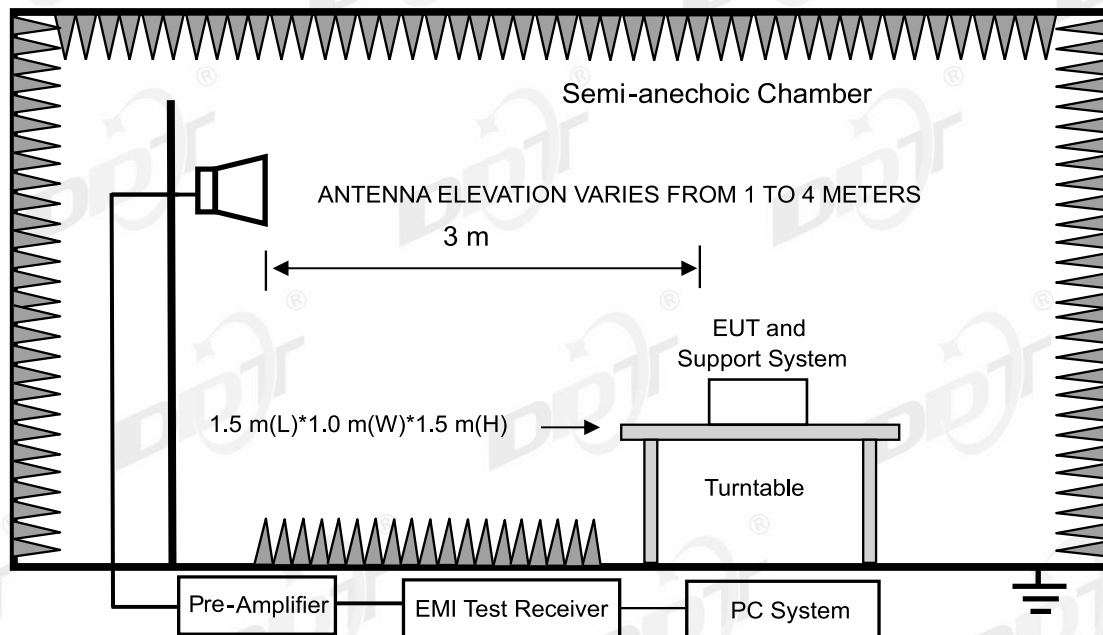

12.3. Limit

All restricted frequency bands shall not exceed the limits shown in 15.209, all the other emissions outside operation frequency band 2400 MHz to 2483.5 MHz shall be at least 20dB below the fundamental emissions or comply with RSS-Gen Issue 5 clause 6.13.2 (Same as FCC 15.209) limits.

12.4. Test procedure

Same with Radiated Spurious Emissions except change investigated frequency range from 2310 MHz to 2430 MHz and 2445 MHz to 2500 MHz.

12.5. Test result

Pass. (See below detailed test result)

TR-4-E-009 Radiated Emission Test Result

Test Date: 2023-11-10 **Tested By:** Bairong
EUT: All-In-One Desktop Android HiFi Music Player **Model Number:** F3051R
Test Mode: 11B TX 2412MHz **Power Supply:** AC 230V/50Hz
Condition: Temp:22.6°C;Humi:57.0% **Test Site:** DDT 3# Chamber
File Path: d:\ts\2023 report data\Q23101912-2E F3051R\FCC ABOVE 1G 2.4GWIFI\33
Memo: Sample Number:S23101912-01 Power Setting:NA

Test Graph

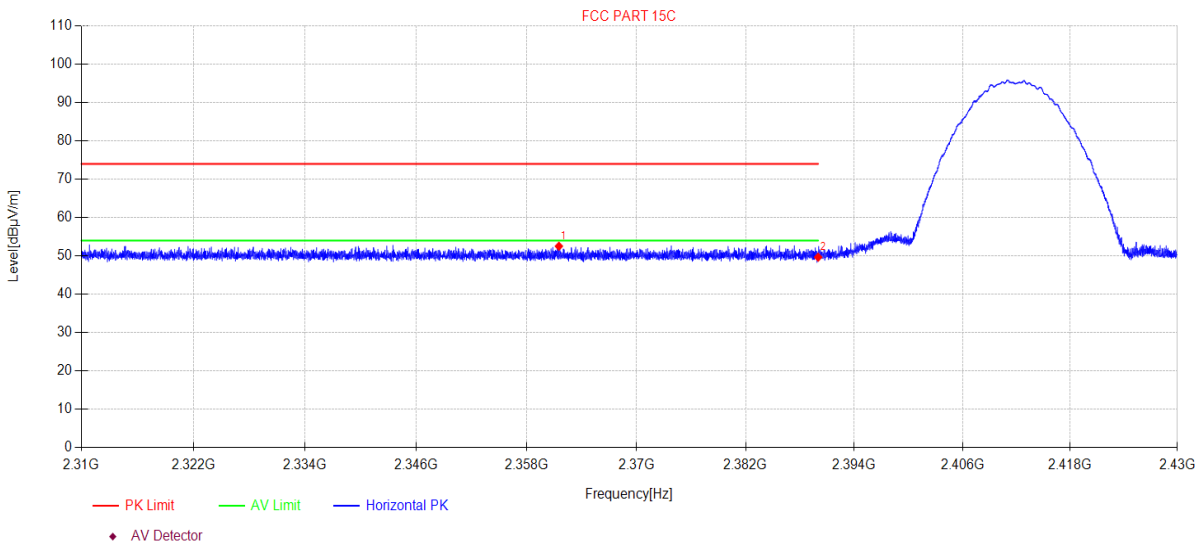

Data List										
NO.	Freq. [MHz]	Reading [dBµV/m]	Antenna Factor [dB]	Cable loss [dB]	AMP [dB]	Level [dBµV/m]	Limit [dBµV/m]	Margin [dB]	Detector	Polarity
1	2361.54	49.57	27.15	3.84	-28.03	52.53	74.00	21.47	PK	Horizontal
2	2390.00	46.64	27.26	3.87	-28.11	49.66	74.00	24.34	PK	Horizontal

Note:

1. Level = Reading + Cable loss + Antenna Factor + AMP
2. If Peak Result complies with AV limit, AV Result is deemed to comply with AV limit.
3. Test setup: RBW: 1 MHz, VBW: 3 MHz, Sweep time: auto.

TR-4-E-009 Radiated Emission Test Result

Test Date: 2023-11-10 **Tested By:** Bairong
EUT: All-In-One Desktop Android HiFi Music Player **Model Number:** F3051R
Test Mode: 11B TX 2412MHz **Power Supply:** AC 230V/50Hz
Condition: Temp:22.6°C;Humi:57.0% **Test Site:** DDT 3# Chamber
File Path: d:\ts\2023 report data\Q23101912-2E F3051R\FCC ABOVE 1G 2.4GWIFI\34
Memo: Sample Number:S23101912-01 Power Setting:NA

Test Graph

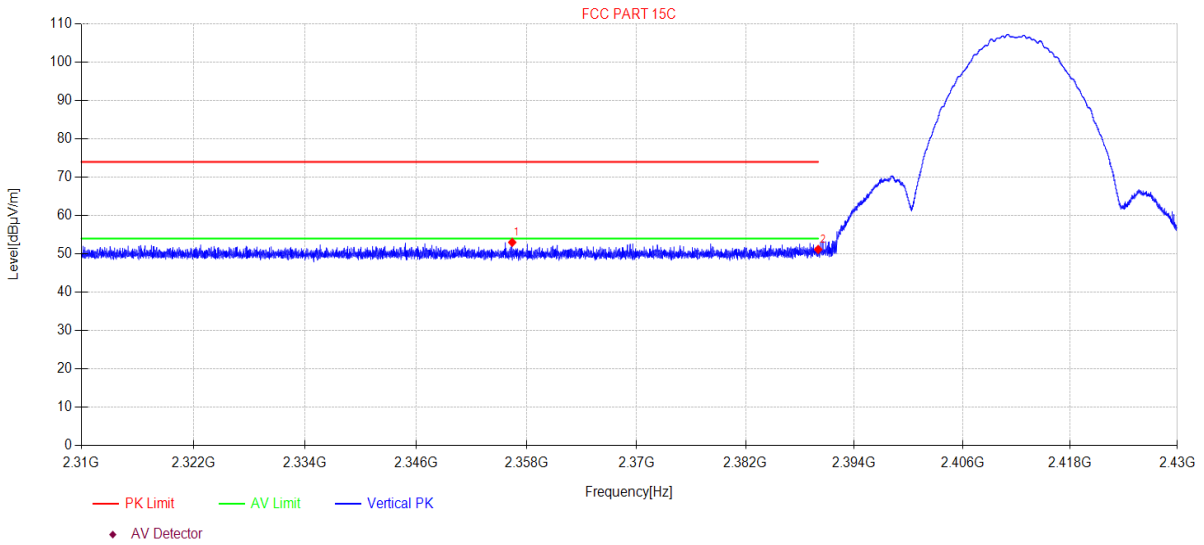

Data List										
NO.	Freq. [MHz]	Reading [dBµV/m]	Antenna Factor [dB]	Cable loss [dB]	AMP [dB]	Level [dBµV/m]	Limit [dBµV/m]	Margin [dB]	Detector	Polarity
1	2356.45	50.06	27.13	3.84	-28.02	53.01	74.00	20.99	PK	Vertical
2	2390.00	48.16	27.26	3.87	-28.11	51.18	74.00	22.82	PK	Vertical

Note:

1. Level = Reading + Cable loss + Antenna Factor + AMP
2. If Peak Result complies with AV limit, AV Result is deemed to comply with AV limit.
3. Test setup: RBW: 1 MHz, VBW: 3 MHz, Sweep time: auto.

TR-4-E-009 Radiated Emission Test Result

Test Date: 2023-11-10 **Tested By:** Bairong
EUT: All-In-One Desktop Android HiFi Music Player **Model Number:** F3051R
Test Mode: 11B TX 2462MHz **Power Supply:** AC 230V/50Hz
Condition: Temp:22.6°C;Humi:57.0% **Test Site:** DDT 3# Chamber
File Path: d:\ts\2023 report data\Q23101912-2E F3051R\FCC ABOVE 1G 2.4GWIFI\35
Memo: Sample Number:S23101912-01 Power Setting:NA

Test Graph

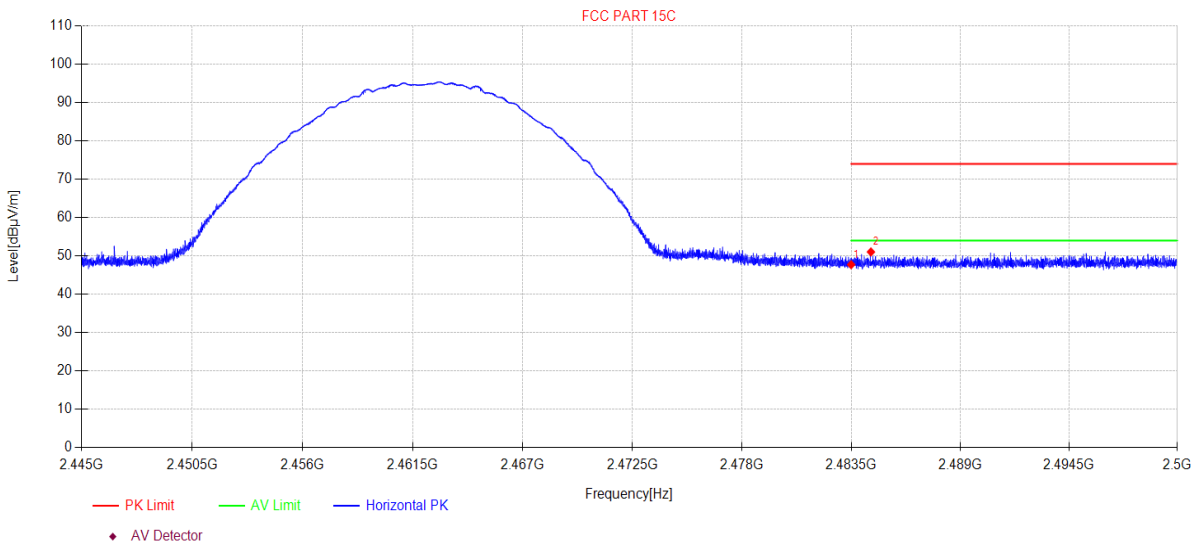

Data List										
NO.	Freq. [MHz]	Reading [dBµV/m]	Antenna Factor [dB]	Cable loss [dB]	AMP [dB]	Level [dBµV/m]	Limit [dBµV/m]	Margin [dB]	Detector	Polarity
1	2483.50	44.63	27.53	3.94	-28.38	47.72	74.00	26.28	PK	Horizontal
2	2484.50	47.93	27.54	3.94	-28.38	51.03	74.00	22.97	PK	Horizontal

Note:

1. Level = Reading + Cable loss + Antenna Factor + AMP
2. If Peak Result complies with AV limit, AV Result is deemed to comply with AV limit.
3. Test setup: RBW: 1 MHz, VBW: 3 MHz, Sweep time: auto.

TR-4-E-009 Radiated Emission Test Result

Test Date: 2023-11-10 **Tested By:** Bairong
EUT: All-In-One Desktop Android HiFi Music Player **Model Number:** F3051R
Test Mode: 11B TX 2462MHz **Power Supply:** AC 230V/50Hz
Condition: Temp:22.6°C;Humi:57.0% **Test Site:** DDT 3# Chamber
File Path: d:\ts\2023 report data\Q23101912-2E F3051R\FCC ABOVE 1G 2.4GWIFI\36
Memo: Sample Number:S23101912-01 Power Setting:NA

Test Graph

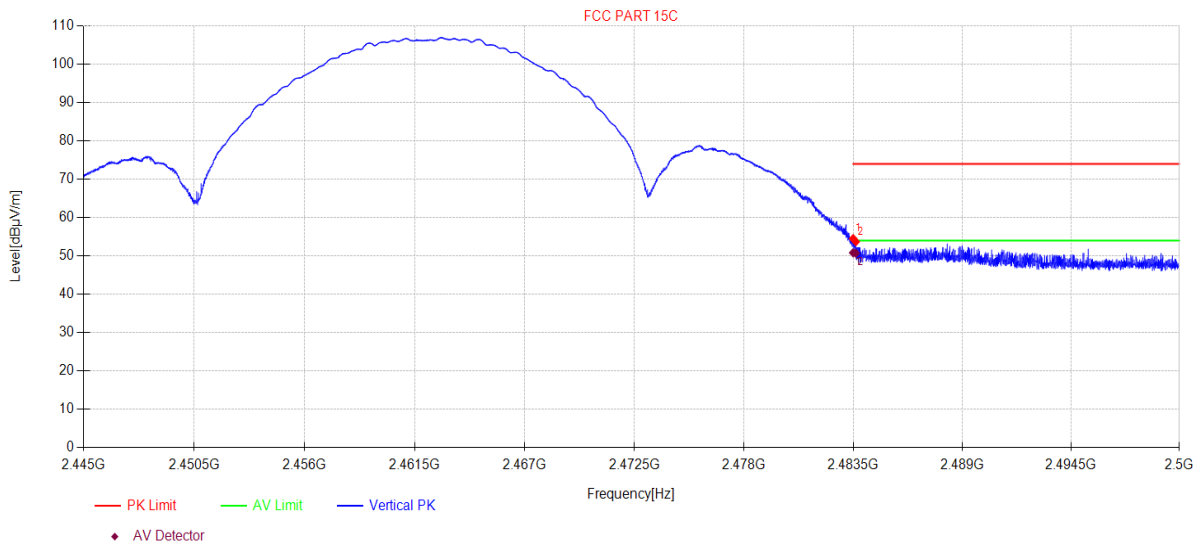

Data List										
NO.	Freq. [MHz]	Reading [dBµV/m]	Antenna Factor [dB]	Cable loss [dB]	AMP [dB]	Level [dBµV/m]	Limit [dBµV/m]	Margin [dB]	Detector	Polarity
1	2483.50	51.43	27.53	3.94	-28.38	54.52	74.00	19.48	PK	Vertical
2	2483.64	50.62	27.53	3.94	-28.38	53.71	74.00	20.29	PK	Vertical

Data List										
NO.	Freq. [MHz]	Reading [dBµV/m]	Antenna Factor [dB]	Cable loss [dB]	AMP [dB]	Level [dBµV/m]	Limit [dBµV/m]	Margin [dB]	Detector	Polarity
1	2483.50	47.73	27.53	3.94	-28.38	50.82	54.00	3.18	AV	Vertical
2	2483.64	47.62	27.53	3.94	-28.38	50.71	54.00	3.29	AV	Vertical

Note:

1. Level = Reading + Cable loss + Antenna Factor + AMP
2. If Peak Result complies with AV limit, AV Result is deemed to comply with AV limit.
3. Test setup: RBW: 1 MHz, VBW: 3 MHz, Sweep time: auto.

TR-4-E-009 Radiated Emission Test Result

Test Date: 2023-11-10 **Tested By:** Bairong
EUT: All-In-One Desktop Android HiFi Music Player **Model Number:** F3051R
Test Mode: 11G TX 2412MHz **Power Supply:** AC 230V/50Hz
Condition: Temp:22.6°C;Humi:57.0% **Test Site:** DDT 3# Chamber
File Path: d:\ts\2023 report data\Q23101912-2E F3051R\FCC ABOVE 1G 2.4GWIFI\37
Memo: Sample Number:S23101912-01 Power Setting:NA

Test Graph

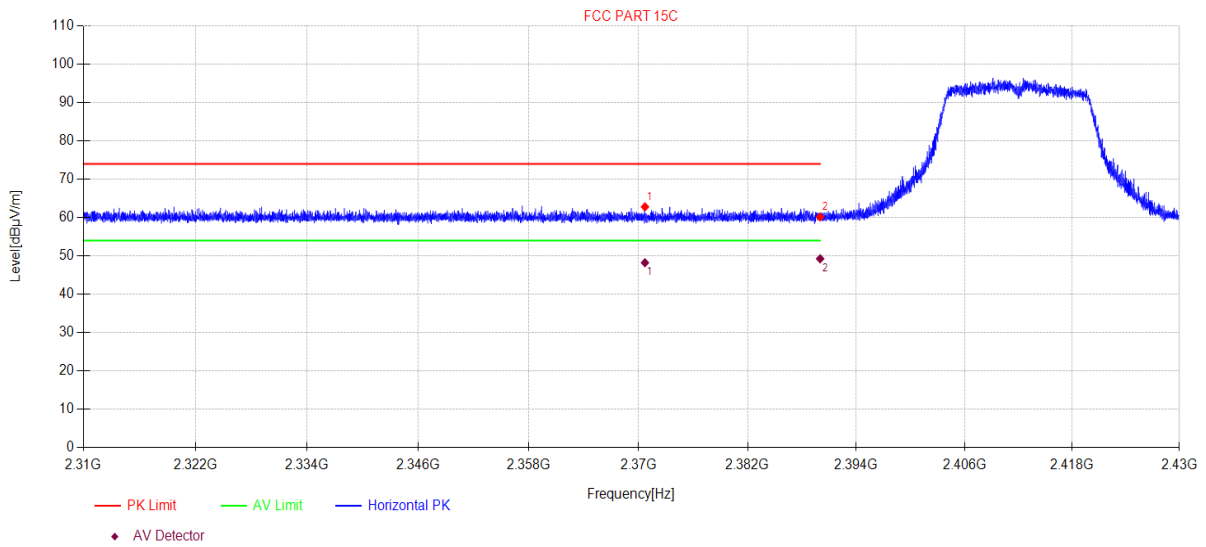

Data List										
NO.	Freq. [MHz]	Reading [dBµV/m]	Antenna Factor [dB]	Cable loss [dB]	AMP [dB]	Level [dBµV/m]	Limit [dBµV/m]	Margin [dB]	Detector	Polarity
1	2370.73	49.82	27.18	3.85	-18.06	62.79	74.00	11.21	PK	Horizontal
2	2390.00	47.14	27.26	3.87	-18.11	60.16	74.00	13.84	PK	Horizontal

Data List										
NO.	Freq. [MHz]	Reading [dBµV/m]	Antenna Factor [dB]	Cable loss [dB]	AMP [dB]	Level [dBµV/m]	Limit [dBµV/m]	Margin [dB]	Detector	Polarity
1	2370.73	35.26	27.18	3.85	-18.06	48.23	54.00	5.77	AV	Horizontal
2	2390.00	36.24	27.26	3.87	-18.11	49.26	54.00	4.74	AV	Horizontal

Note:

- Level = Reading + Cable loss + Antenna Factor + AMP
- If Peak Result complies with AV limit, AV Result is deemed to comply with AV limit.
- Test setup: RBW: 1 MHz, VBW: 3 MHz, Sweep time: auto.

TR-4-E-009 Radiated Emission Test Result

Test Date: 2023-11-10 **Tested By:** Bairong
EUT: All-In-One Desktop Android HiFi Music Player **Model Number:** F3051R
Test Mode: 11G TX 2412MHz **Power Supply:** AC 230V/50Hz
Condition: Temp:22.6°C;Humi:57.0% **Test Site:** DDT 3# Chamber
File Path: d:\ts\2023 report data\Q23101912-2E F3051R\FCC ABOVE 1G 2.4GWIFI\38
Memo: Sample Number:S23101912-01 Power Setting:NA

Test Graph

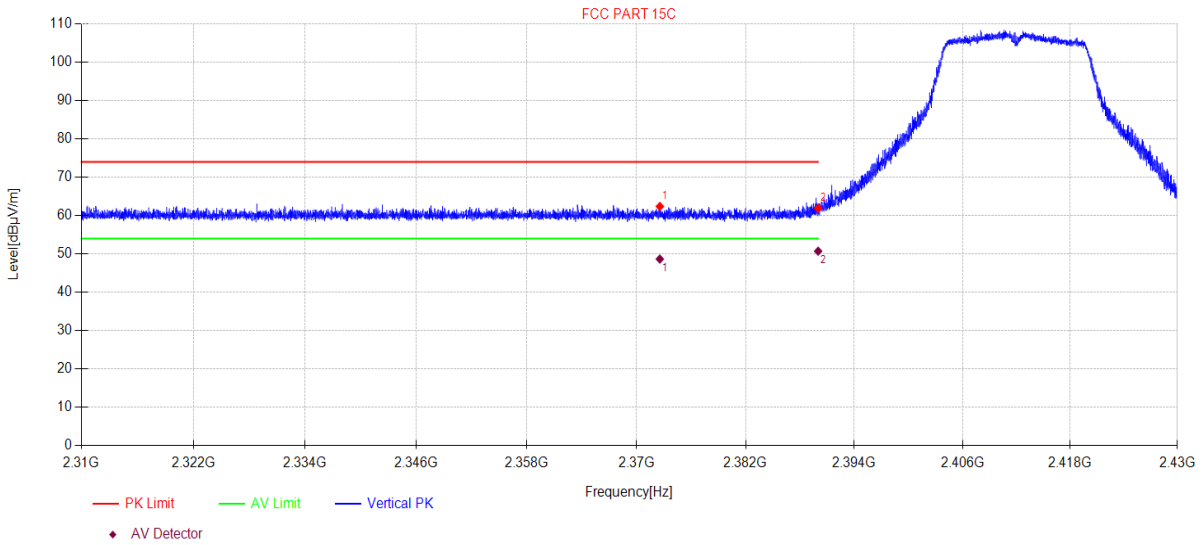

Data List										
NO.	Freq. [MHz]	Reading [dBµV/m]	Antenna Factor [dB]	Cable loss [dB]	AMP [dB]	Level [dBµV/m]	Limit [dBµV/m]	Margin [dB]	Detector	Polarity
1	2372.58	49.40	27.19	3.85	-18.06	62.38	74.00	11.62	PK	Vertical
2	2390.00	48.90	27.26	3.87	-18.11	61.92	74.00	12.08	PK	Vertical

Data List										
NO.	Freq. [MHz]	Reading [dBµV/m]	Antenna Factor [dB]	Cable loss [dB]	AMP [dB]	Level [dBµV/m]	Limit [dBµV/m]	Margin [dB]	Detector	Polarity
1	2372.58	35.68	27.19	3.85	-18.06	48.66	54.00	5.34	AV	Vertical
2	2390.00	37.7	27.26	3.87	-18.11	50.72	54.00	3.28	AV	Vertical

Note:

1. Level = Reading + Cable loss + Antenna Factor + AMP
2. If Peak Result complies with AV limit, AV Result is deemed to comply with AV limit.
3. Test setup: RBW: 1 MHz, VBW: 3 MHz, Sweep time: auto.

TR-4-E-009 Radiated Emission Test Result

Test Date: 2023-11-10 **Tested By:** Bairong
EUT: All-In-One Desktop Android HiFi Music Player **Model Number:** F3051R
Test Mode: 11G TX 2462MHz **Power Supply:** AC 230V/50Hz
Condition: Temp:22.6°C;Humi:57.0% **Test Site:** DDT 3# Chamber
File Path: d:\ts\2023 report data\Q23101912-2E F3051R\FCC ABOVE 1G 2.4GWIFI\39
Memo: Sample Number:S23101912-01 Power Setting:NA

Test Graph

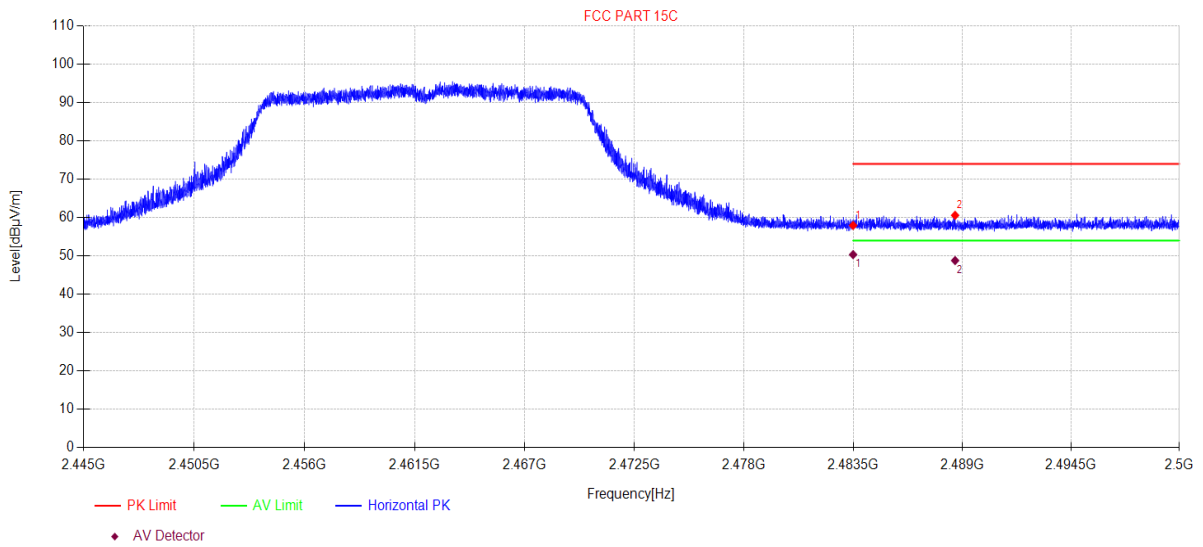

Data List										
NO.	Freq. [MHz]	Reading [dBµV/m]	Antenna Factor [dB]	Cable loss [dB]	AMP [dB]	Level [dBµV/m]	Limit [dBµV/m]	Margin [dB]	Detector	Polarity
1	2483.50	44.85	27.53	3.94	-18.38	57.94	74.00	16.06	PK	Horizontal
2	2488.65	47.48	27.55	3.94	-18.39	60.58	74.00	13.42	PK	Horizontal

Data List										
NO.	Freq. [MHz]	Reading [dBµV/m]	Antenna Factor [dB]	Cable loss [dB]	AMP [dB]	Level [dBµV/m]	Limit [dBµV/m]	Margin [dB]	Detector	Polarity
1	2483.50	37.25	27.53	3.94	-18.38	50.34	54.00	3.66	AV	Horizontal
2	2488.65	35.69	27.55	3.94	-18.39	48.79	54.00	5.21	AV	Horizontal

Note:

- Level = Reading + Cable loss + Antenna Factor + AMP
- If Peak Result complies with AV limit, AV Result is deemed to comply with AV limit.
- Test setup: RBW: 1 MHz, VBW: 3 MHz, Sweep time: auto.

TR-4-E-009 Radiated Emission Test Result

Test Date: 2023-11-10 **Tested By:** Bairong
EUT: All-In-One Desktop Android HiFi Music Player **Model Number:** F3051R
Test Mode: 11G TX 2462MHz **Power Supply:** AC 230V/50Hz
Condition: Temp:22.6°C;Humi:57.0% **Test Site:** DDT 3# Chamber
File Path: d:\ts\2023 report data\Q23101912-2E F3051R\FCC ABOVE 1G 2.4GWIFI\40
Memo: Sample Number:S23101912-01 Power Setting:NA

Test Graph

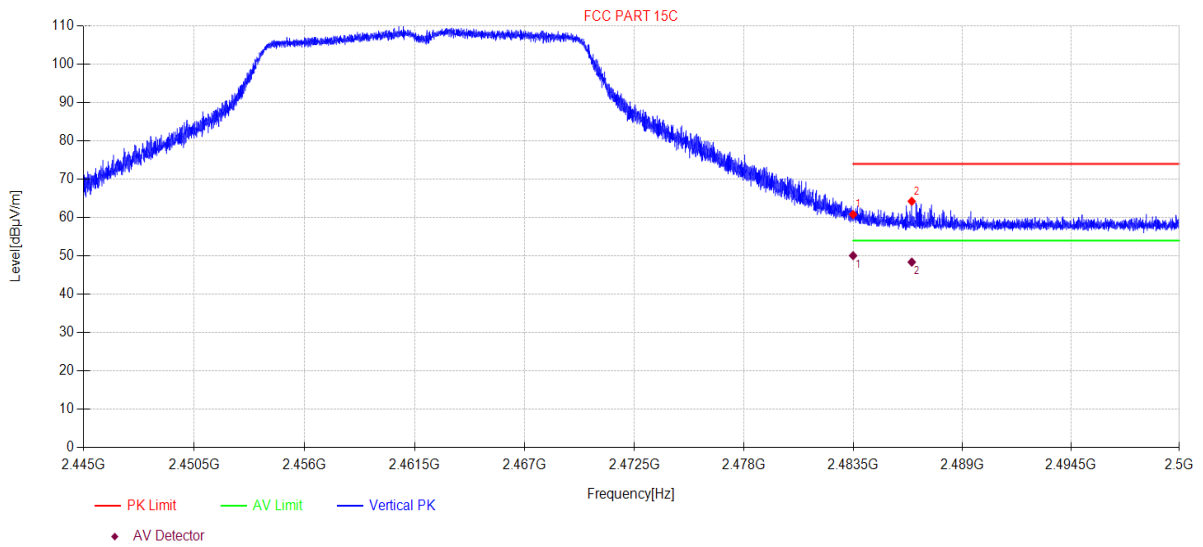

Data List										
NO.	Freq. [MHz]	Reading [dBµV/m]	Antenna Factor [dB]	Cable loss [dB]	AMP [dB]	Level [dBµV/m]	Limit [dBµV/m]	Margin [dB]	Detector	Polarity
1	2483.50	47.72	27.53	3.94	-18.38	60.81	74.00	13.19	PK	Vertical
2	2486.46	51.13	27.55	3.94	-18.39	64.23	74.00	9.77	PK	Vertical

Data List										
NO.	Freq. [MHz]	Reading [dBµV/m]	Antenna Factor [dB]	Cable loss [dB]	AMP [dB]	Level [dBµV/m]	Limit [dBµV/m]	Margin [dB]	Detector	Polarity
1	2483.50	36.97	27.53	3.94	-18.38	50.06	54.00	3.94	AV	Vertical
2	2486.46	35.29	27.55	3.94	-18.39	48.39	54.00	5.61	AV	Vertical

Note:

1. Level = Reading + Cable loss + Antenna Factor + AMP
2. If Peak Result complies with AV limit, AV Result is deemed to comply with AV limit.
3. Test setup: RBW: 1 MHz, VBW: 3 MHz, Sweep time: auto.

TR-4-E-009 Radiated Emission Test Result

Test Date: 2023-11-15 **Tested By:** Bairong
EUT: All-In-One Desktop Android HiFi Music Player **Model Number:** F3051R
Test Mode: 11N20 TX 2412MHz **Power Supply:** AC 230V/50Hz
Condition: Temp:22.6°C;Humi:57.0% **Test Site:** DDT 3# Chamber
File Path: d:\ts\2023 report data\Q23101912-2E F3051R\FCC ABOVE 1G 2.4GWIFI\41
Memo: Sample Number:S23101912-01 Power Setting:NA

Test Graph

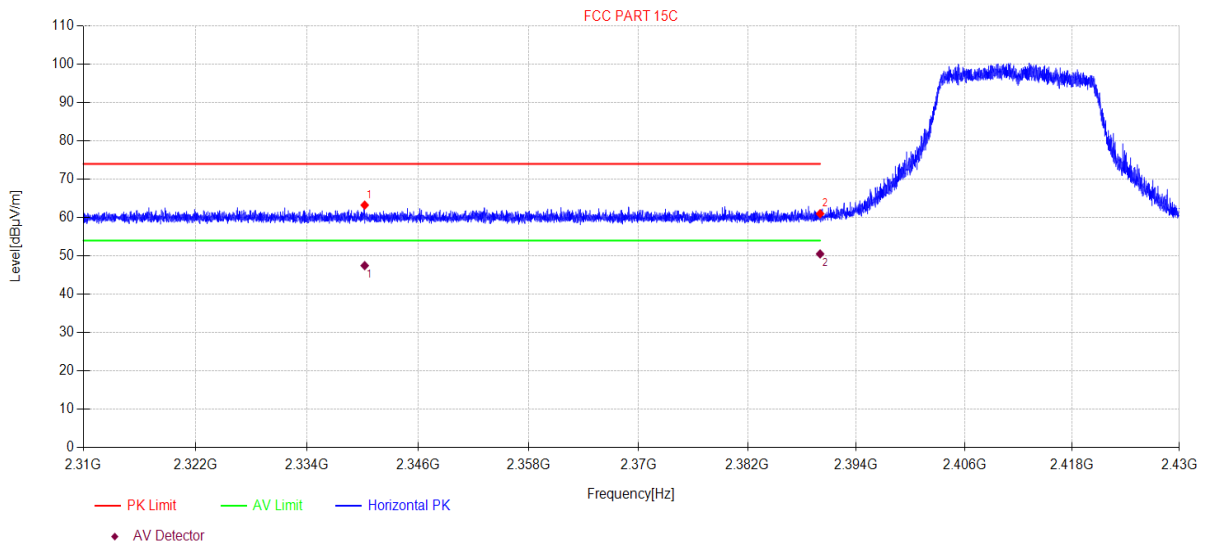

Data List										
NO.	Freq. [MHz]	Reading [dBµV/m]	Antenna Factor [dB]	Cable loss [dB]	AMP [dB]	Level [dBµV/m]	Limit [dBµV/m]	Margin [dB]	Detector	Polarity
1	2340.23	50.34	27.04	3.83	-17.97	63.24	74.00	10.76	PK	Horizontal
2	2390.00	47.98	27.26	3.87	-18.11	61.00	74.00	13.00	PK	Horizontal

Data List										
NO.	Freq. [MHz]	Reading [dBµV/m]	Antenna Factor [dB]	Cable loss [dB]	AMP [dB]	Level [dBµV/m]	Limit [dBµV/m]	Margin [dB]	Detector	Polarity
1	2340.23	34.57	27.04	3.83	-17.97	47.47	54.00	6.53	AV	Horizontal
2	2390.00	37.50	27.26	3.87	-18.11	50.52	54.00	3.48	AV	Horizontal

Note:

1. Level = Reading + Cable loss + Antenna Factor + AMP
2. If Peak Result complies with AV limit, AV Result is deemed to comply with AV limit.
3. Test setup: RBW: 1 MHz, VBW: 3 MHz, Sweep time: auto.

TR-4-E-009 Radiated Emission Test Result

Test Date: 2023-11-15 **Tested By:** Bairong
EUT: All-In-One Desktop Android HiFi Music Player **Model Number:** F3051R
Test Mode: 11N20 TX 2412MHz **Power Supply:** AC 230V/50Hz
Condition: Temp:22.6°C;Humi:57.0% **Test Site:** DDT 3# Chamber
File Path: d:\ts\2023 report data\Q23101912-2E F3051R\FCC ABOVE 1G 2.4GWIFI\42
Memo: Sample Number:S23101912-01 Power Setting:NA

Test Graph

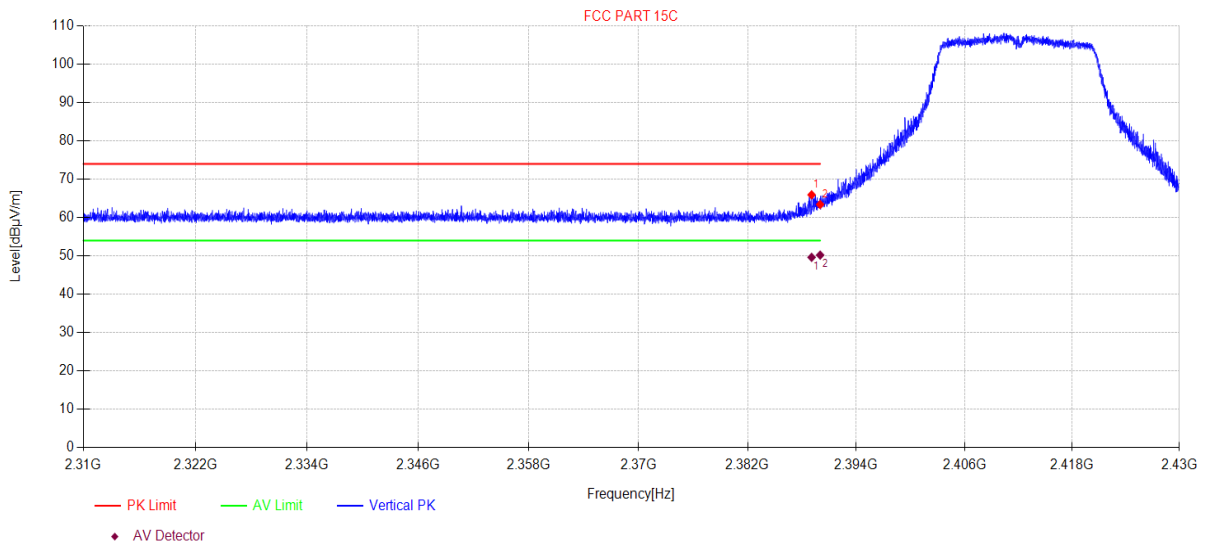

Data List										
NO.	Freq. [MHz]	Reading [dBµV/m]	Antenna Factor [dB]	Cable loss [dB]	AMP [dB]	Level [dBµV/m]	Limit [dBµV/m]	Margin [dB]	Detector	Polarity
1	2389.06	52.90	27.26	3.87	-18.11	65.92	74.00	8.08	PK	Vertical
2	2390.00	50.38	27.26	3.87	-18.11	63.40	74.00	10.60	PK	Vertical

Data List										
NO.	Freq. [MHz]	Reading [dBµV/m]	Antenna Factor [dB]	Cable loss [dB]	AMP [dB]	Level [dBµV/m]	Limit [dBµV/m]	Margin [dB]	Detector	Polarity
1	2389.06	36.61	27.26	3.87	-18.11	49.63	54.00	4.37	AV	Vertical
2	2390.00	37.20	27.26	3.87	-18.11	50.22	54.00	3.78	AV	Vertical

Note:

1. Level = Reading + Cable loss + Antenna Factor + AMP
2. If Peak Result complies with AV limit, AV Result is deemed to comply with AV limit.
3. Test setup: RBW: 1 MHz, VBW: 3 MHz, Sweep time: auto.

TR-4-E-009 Radiated Emission Test Result

Test Date: 2023-11-15 **Tested By:** Bairong
EUT: All-In-One Desktop Android HiFi Music Player **Model Number:** F3051R
Test Mode: 11N20 TX 2462MHz **Power Supply:** AC 230V/50Hz
Condition: Temp:22.6°C;Humi:57.0% **Test Site:** DDT 3# Chamber
File Path: d:\ts\2023 report data\Q23101912-2E F3051R\FCC ABOVE 1G 2.4GWIFI\43
Memo: Sample Number:S23101912-01 Power Setting:NA

Test Graph

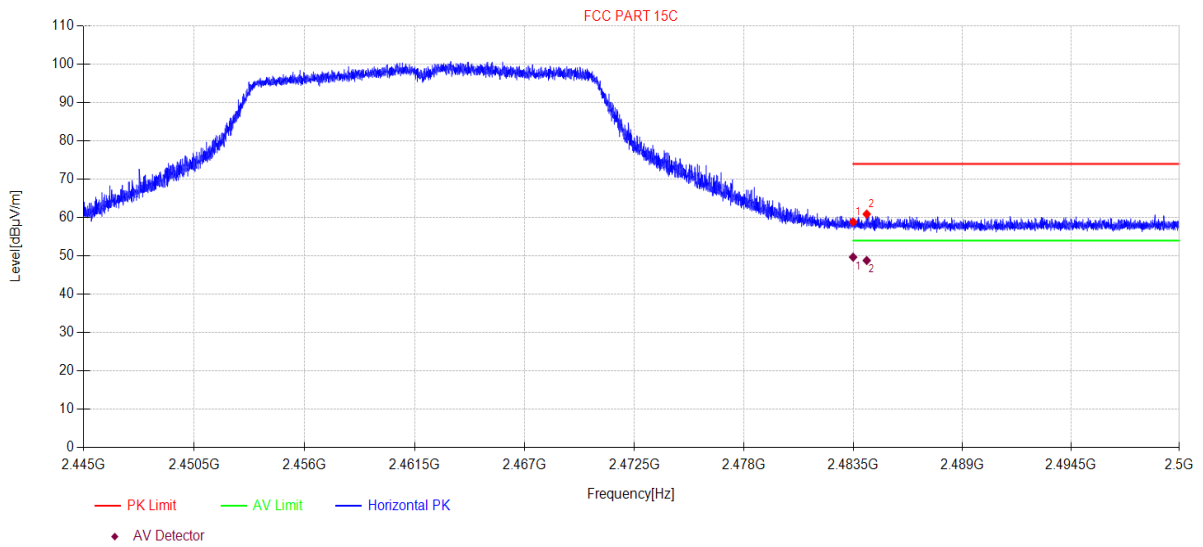

Data List										
NO.	Freq. [MHz]	Reading [dBµV/m]	Antenna Factor [dB]	Cable loss [dB]	AMP [dB]	Level [dBµV/m]	Limit [dBµV/m]	Margin [dB]	Detector	Polarity
1	2483.50	45.75	27.53	3.94	-18.38	58.84	74.00	15.16	PK	Horizontal
2	2484.19	47.80	27.54	3.94	-18.38	60.90	74.00	13.10	PK	Horizontal

Data List										
NO.	Freq. [MHz]	Reading [dBµV/m]	Antenna Factor [dB]	Cable loss [dB]	AMP [dB]	Level [dBµV/m]	Limit [dBµV/m]	Margin [dB]	Detector	Polarity
1	2483.50	36.59	27.53	3.94	-18.38	49.68	54.00	4.32	AV	Horizontal
2	2484.19	35.71	27.54	3.94	-18.38	48.81	54.00	5.19	AV	Horizontal

Note:

1. Level = Reading + Cable loss + Antenna Factor + AMP
2. If Peak Result complies with AV limit, AV Result is deemed to comply with AV limit.
3. Test setup: RBW: 1 MHz, VBW: 3 MHz, Sweep time: auto.

TR-4-E-009 Radiated Emission Test Result

Test Date: 2023-11-15 **Tested By:** Bairong
EUT: All-In-One Desktop Android HiFi Music Player **Model Number:** F3051R
Test Mode: 11N20 TX 2462MHz **Power Supply:** AC 230V/50Hz
Condition: Temp:22.6°C;Humi:57.0% **Test Site:** DDT 3# Chamber
File Path: d:\ts\2023 report data\Q23101912-2E F3051R\FCC ABOVE 1G 2.4GWIFI\44
Memo: Sample Number:S23101912-01 Power Setting:NA

Test Graph

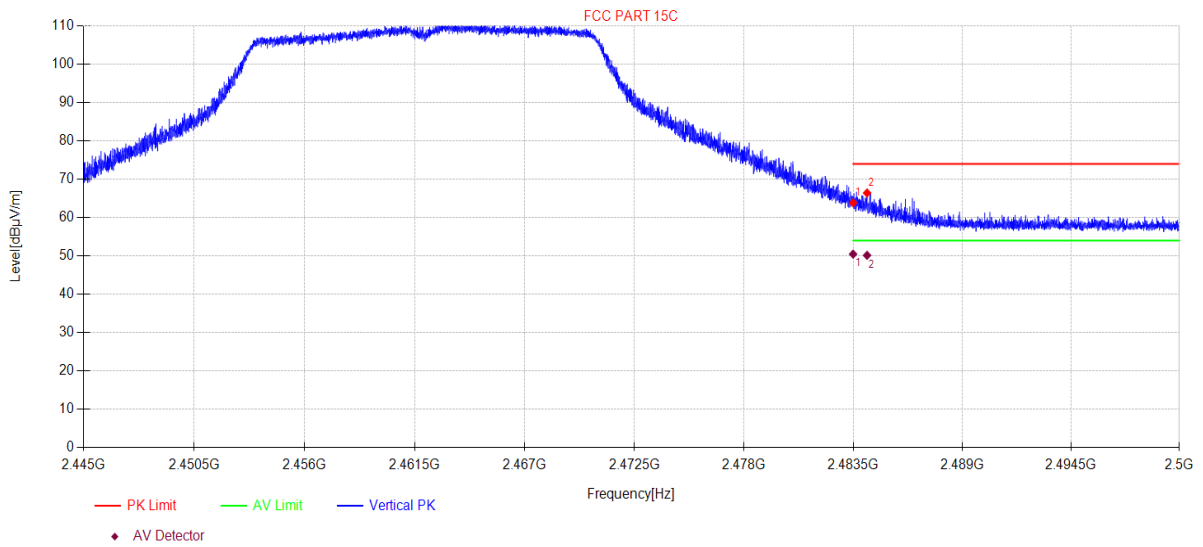

Data List										
NO.	Freq. [MHz]	Reading [dBµV/m]	Antenna Factor [dB]	Cable loss [dB]	AMP [dB]	Level [dBµV/m]	Limit [dBµV/m]	Margin [dB]	Detector	Polarity
1	2483.50	50.75	27.53	3.94	-18.38	63.84	74.00	10.16	PK	Vertical
2	2484.20	53.31	27.54	3.94	-18.38	66.41	74.00	7.59	PK	Vertical

Data List										
NO.	Freq. [MHz]	Reading [dBµV/m]	Antenna Factor [dB]	Cable loss [dB]	AMP [dB]	Level [dBµV/m]	Limit [dBµV/m]	Margin [dB]	Detector	Polarity
1	2483.50	37.38	27.53	3.94	-18.38	50.47	54.00	3.53	AV	Vertical
2	2484.20	37.05	27.54	3.94	-18.38	50.15	54.00	3.85	AV	Vertical

Note:

1. Level = Reading + Cable loss + Antenna Factor + AMP
2. If Peak Result complies with AV limit, AV Result is deemed to comply with AV limit.
3. Test setup: RBW: 1 MHz, VBW: 3 MHz, Sweep time: auto.

TR-4-E-009 Radiated Emission Test Result

Test Date: 2023-11-15 **Tested By:** Bairong
EUT: All-In-One Desktop Android HiFi Music Player **Model Number:** F3051R
Test Mode: 11N40 TX 2422MHz **Power Supply:** AC 230V/50Hz
Condition: Temp:22.6°C;Humi:57.0% **Test Site:** DDT 3# Chamber
File Path: d:\ts\2023 report data\Q23101912-2E F3051R\FCC ABOVE 1G 2.4GWIFI\45
Memo: Sample Number:S23101912-01 Power Setting:NA

Test Graph

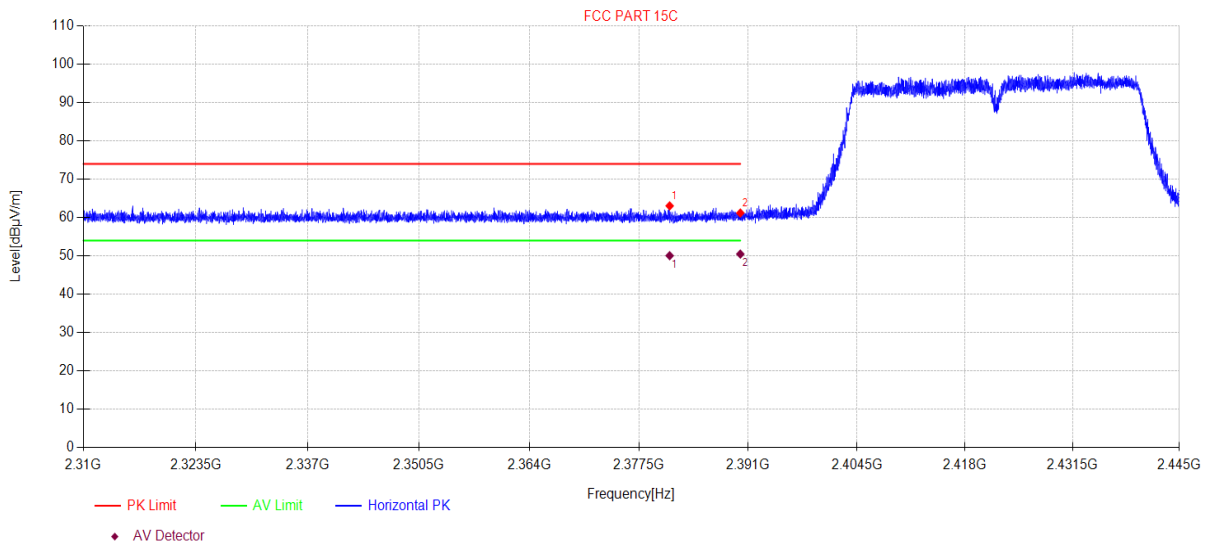

Data List										
NO.	Freq. [MHz]	Reading [dBµV/m]	Antenna Factor [dB]	Cable loss [dB]	AMP [dB]	Level [dBµV/m]	Limit [dBµV/m]	Margin [dB]	Detector	Polarity
1	2381.27	50.04	27.23	3.86	-18.09	63.04	74.00	10.96	PK	Horizontal
2	2390.00	48.16	27.26	3.87	-18.11	61.18	74.00	12.82	PK	Horizontal

Data List										
NO.	Freq. [MHz]	Reading [dBµV/m]	Antenna Factor [dB]	Cable loss [dB]	AMP [dB]	Level [dBµV/m]	Limit [dBµV/m]	Margin [dB]	Detector	Polarity
1	2381.27	37.06	27.23	3.86	-18.09	50.06	54.00	3.94	AV	Horizontal
2	2390.00	37.46	27.26	3.87	-18.11	50.48	54.00	3.52	AV	Horizontal

Note:

- Level = Reading + Cable loss + Antenna Factor + AMP
- If Peak Result complies with AV limit, AV Result is deemed to comply with AV limit.
- Test setup: RBW: 1 MHz, VBW: 3 MHz, Sweep time: auto.

TR-4-E-009 Radiated Emission Test Result

Test Date: 2023-11-15 **Tested By:** Bairong
EUT: All-In-One Desktop Android HiFi Music Player **Model Number:** F3051R
Test Mode: 11N40 TX 2422MHz **Power Supply:** AC 230V/50Hz
Condition: Temp:22.6°C;Humi:57.0% **Test Site:** DDT 3# Chamber
File Path: d:\ts\2023 report data\Q23101912-2E F3051R\FCC ABOVE 1G 2.4GWIFI\46
Memo: Sample Number:S23101912-01 Power Setting:NA

Test Graph

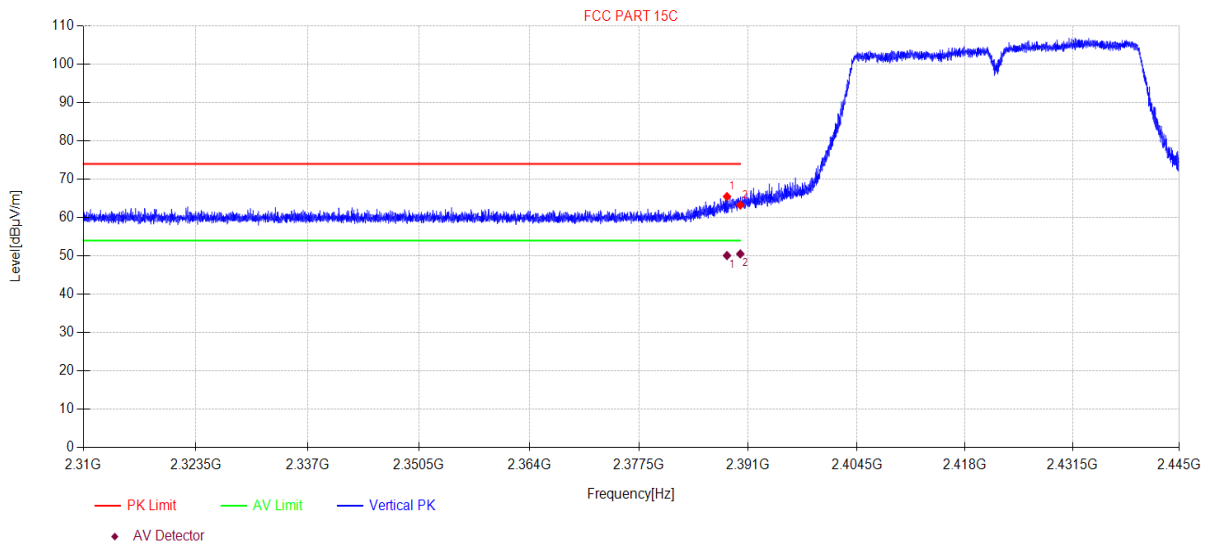

Data List										
NO.	Freq. [MHz]	Reading [dBµV/m]	Antenna Factor [dB]	Cable loss [dB]	AMP [dB]	Level [dBµV/m]	Limit [dBµV/m]	Margin [dB]	Detector	Polarity
1	2388.35	52.45	27.25	3.87	-18.11	65.46	74.00	8.54	PK	Vertical
2	2390.00	50.22	27.26	3.87	-18.11	63.24	74.00	10.76	PK	Vertical

Data List										
NO.	Freq. [MHz]	Reading [dBµV/m]	Antenna Factor [dB]	Cable loss [dB]	AMP [dB]	Level [dBµV/m]	Limit [dBµV/m]	Margin [dB]	Detector	Polarity
1	2388.35	37.09	27.25	3.87	-18.11	50.10	54.00	3.90	AV	Vertical
2	2390.00	37.51	27.26	3.87	-18.11	50.53	54.00	3.47	AV	Vertical

Note:

1. Level = Reading + Cable loss + Antenna Factor + AMP
2. If Peak Result complies with AV limit, AV Result is deemed to comply with AV limit.
3. Test setup: RBW: 1 MHz, VBW: 3 MHz, Sweep time: auto.

TR-4-E-009 Radiated Emission Test Result

Test Date: 2023-11-15 **Tested By:** Bairong
EUT: All-In-One Desktop Android HiFi Music Player **Model Number:** F3051R
Test Mode: 11N40 TX 2452MHz **Power Supply:** AC 230V/50Hz
Condition: Temp:22.6°C;Humi:57.0% **Test Site:** DDT 3# Chamber
File Path: d:\ts\2023 report data\Q23101912-2E F3051R\FCC ABOVE 1G 2.4GWIFI\47
Memo: Sample Number:S23101912-01 Power Setting:NA

Test Graph

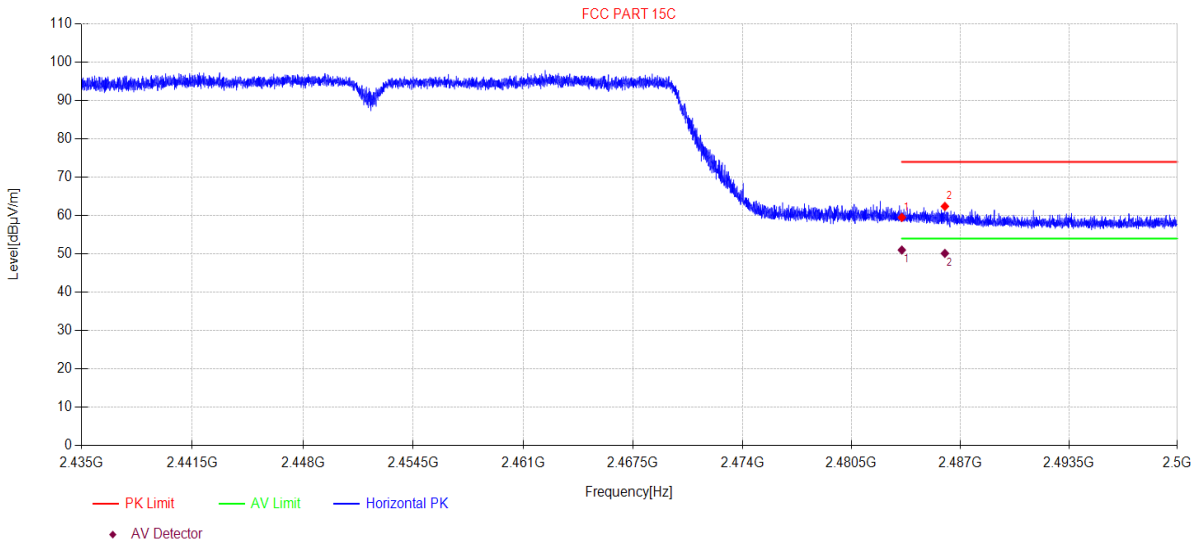

Data List										
NO.	Freq. [MHz]	Reading [dBµV/m]	Antenna Factor [dB]	Cable loss [dB]	AMP [dB]	Level [dBµV/m]	Limit [dBµV/m]	Margin [dB]	Detector	Polarity
1	2483.50	46.42	27.53	3.94	-18.38	59.51	74.00	14.49	PK	Horizontal
2	2486.07	49.30	27.54	3.94	-18.39	62.39	74.00	11.61	PK	Horizontal

Data List										
NO.	Freq. [MHz]	Reading [dBµV/m]	Antenna Factor [dB]	Cable loss [dB]	AMP [dB]	Level [dBµV/m]	Limit [dBµV/m]	Margin [dB]	Detector	Polarity
1	2483.50	37.92	27.53	3.94	-18.38	51.01	54.00	2.99	AV	Horizontal
2	2486.07	37.05	27.54	3.94	-18.39	50.14	54.00	3.86	AV	Horizontal

Note:

1. Level = Reading + Cable loss + Antenna Factor + AMP
2. If Peak Result complies with AV limit, AV Result is deemed to comply with AV limit.
3. Test setup: RBW: 1 MHz, VBW: 3 MHz, Sweep time: auto.

TR-4-E-009 Radiated Emission Test Result

Test Date: 2023-11-15 **Tested By:** Bairong
EUT: All-In-One Desktop Android HiFi Music Player **Model Number:** F3051R
Test Mode: 11N40 TX 2452MHz **Power Supply:** AC 230V/50Hz
Condition: Temp:22.6°C;Humi:57.0% **Test Site:** DDT 3# Chamber
File Path: d:\ts\2023 report data\Q23101912-2E F3051R\FCC ABOVE 1G 2.4GWIFI\48
Memo: Sample Number:S23101912-01 Power Setting:NA

Test Graph

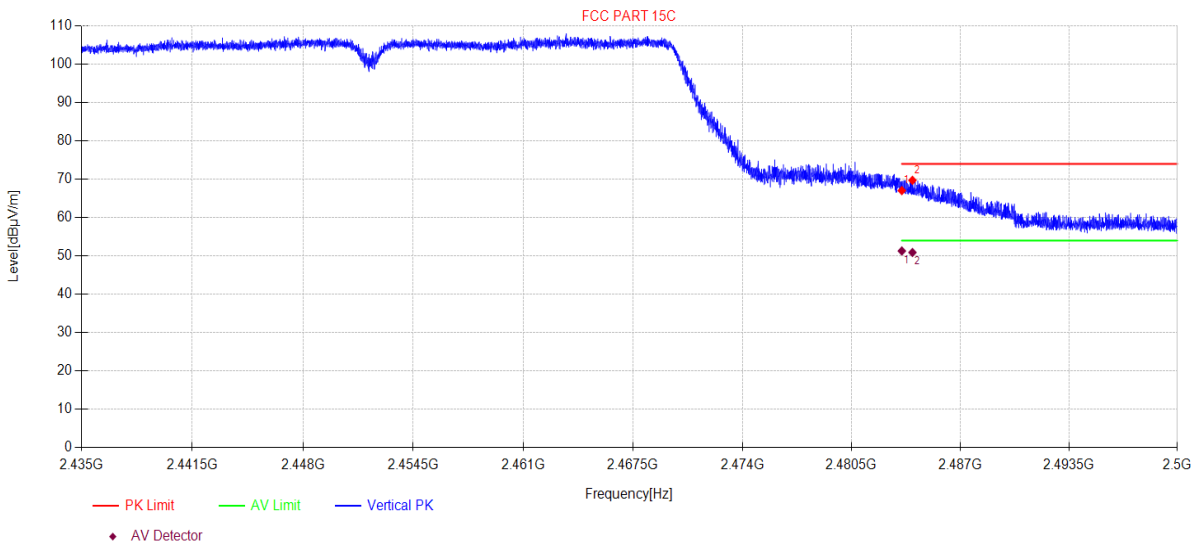

Data List										
NO.	Freq. [MHz]	Reading [dBµV/m]	Antenna Factor [dB]	Cable loss [dB]	AMP [dB]	Level [dBµV/m]	Limit [dBµV/m]	Margin [dB]	Detector	Polarity
1	2483.50	53.94	27.53	3.94	-18.38	67.03	74.00	6.97	PK	Vertical
2	2484.13	56.59	27.54	3.94	-18.38	69.69	74.00	4.31	PK	Vertical

Data List										
NO.	Freq. [MHz]	Reading [dBµV/m]	Antenna Factor [dB]	Cable loss [dB]	AMP [dB]	Level [dBµV/m]	Limit [dBµV/m]	Margin [dB]	Detector	Polarity
1	2483.50	38.20	27.53	3.94	-18.38	51.29	54.00	2.71	AV	Vertical
2	2484.13	37.80	27.54	3.94	-18.38	50.90	54.00	3.10	AV	Vertical

Note:

1. Level = Reading + Cable loss + Antenna Factor + AMP
2. If Peak Result complies with AV limit, AV Result is deemed to comply with AV limit.
3. Test setup: RBW: 1 MHz, VBW: 3 MHz, Sweep time: auto.

13. Power Line Conducted Emission

13.1. Test equipment

Equipment	Manufacturer	Model No.	Serial No.	Last Cal.	Cal. Interval
☒ Power Line Conducted Emissions Test 1#					
Test Receiver	R&S	ESCI	100551	Jul. 11, 2023	1 Year
LISN 1	R&S	ENV216	101109	Jul. 11, 2023	1 Year
LISN 2	R&S	ESH2-Z5	100309	Jul. 12, 2023	1 Year
Pulse Limiter	R&S	ESH3-Z2	101242	Jul. 15, 2023	1 Year
CE Cable 1	HUBSER	N/A	W10.01	Jul. 15, 2023	1 Year
Test software	Audix	E3	V 6.11111b	N/A	N/A
Measurement uncertainty: 3.72dB (9 kHz to 150 kHz), 3.34dB (150 kHz to 30 MHz).					

13.2. Block diagram of test setup

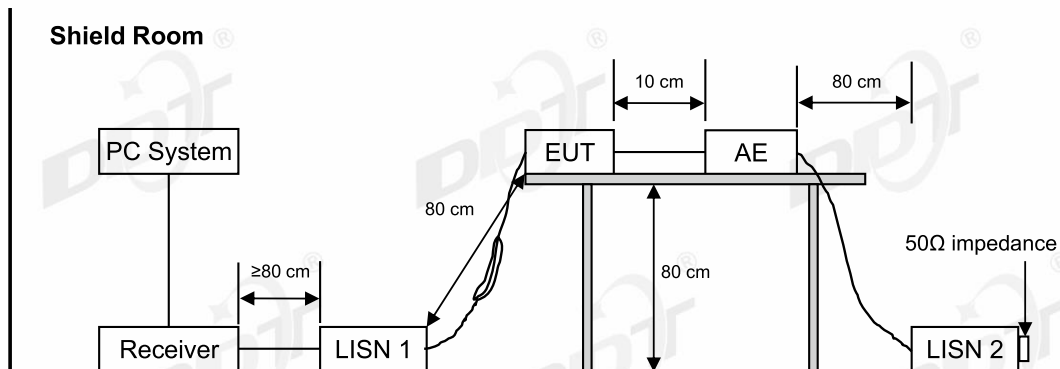

13.3. Power Line Conducted Emission Limits

Frequency	Quasi-Peak Level dB(μV)	Average Level dB(μV)
150 kHz ~ 500 kHz	66 ~ 56*	56 ~ 46*
500 kHz ~ 5 MHz	56	46
5 MHz ~ 30 MHz	60	50

Note 1: * Decreasing linearly with logarithm of frequency.

Note 2: The lower limit shall apply at the transition frequencies.

13.4. Test procedure

The EUT and Support equipment, if needed, were put placed on a non-metallic table, 80cm above the ground plane.

All support equipment power received from a second LISN.

Emissions were measured on each current carrying line of the EUT using an EMI Test Receiver connected to the LISN powering the EUT.

The Receiver scanned from 150 kHz to 30 MHz for emissions in each of the test modes.

During the above scans, the emissions were maximized by cable manipulation.

The test mode(s) described in clause 2.4 were scanned during the preliminary test.

After the preliminary scan, we found the test mode producing the highest emission level.

The EUT configuration and worse cable configuration of the above highest emission levels were recorded for reference of the final test.

EUT and support equipment were set up on the test bench as per the configuration with highest emission level in the preliminary test.

A scan was taken on both power lines, Neutral and Line, recording at least the six highest emissions.

Emission frequency and amplitude were recorded into a computer in which correction factors were used to calculate the emission level and compare reading to the applicable limit.

The test data of the worst-case condition(s) was recorded.

The bandwidth of test receiver is set at 9 kHz.

13.5. Test result

Pass. (See below detailed test result)

Note1: All emissions not reported below are too low against the prescribed limits.

Note2: “-----” means peak detection; “-----” means average detection

Note3: Pre-test AC conducted emission at both voltage AC 120V/60Hz and AC 240V/60Hz, recorded worse case.

TR-4-E-010 Conducted Emission Test Result

Test Site : DDT 1# Shield Room
Test Date : 2023-11-15
EUT : All-In-One Desktop Android HiFi Music Player
Power Supply : AC 120V/60Hz
Condition : TEMP:26.2°C, RH:58.9%
Memo : Sample Number:S23101912-01

D:\2023 CE report data\Q23101912-2E F3051R\FCC CE.EM6
Tested By : Junchang Du
Model Number : F3051R
Test Mode : 2.4GWiFi TX
LISN : 2023 1# ENV216/NEUTRAL

Data: 14

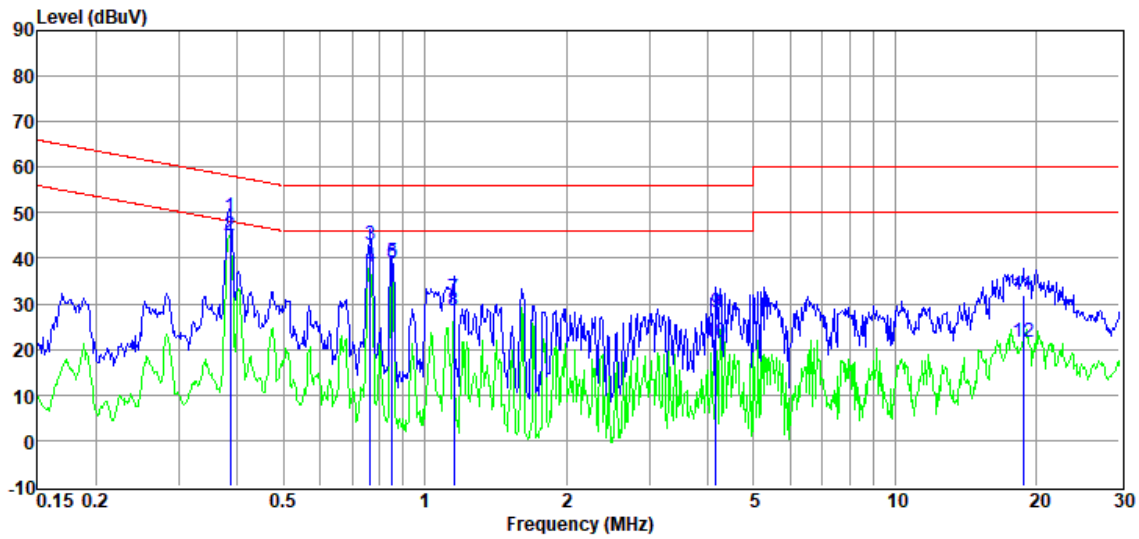

Item	Freq.	Read Level	LISN Factor	Cable Loss	Pulse Limiter Factor	Result Level	Limit Line	Over Limit	Detector	Phase
(Mark)	(MHz)	(dBμV)	(dB)	(dB)	(dB)	(dBμV)	(dBμV)	(dB)		
1	0.39	28.95	9.71	0.85	9.71	49.22	58.17	-8.95	QP	NEUTRAL
2	0.39	24.76	9.71	0.85	9.71	45.03	48.17	-3.14	Average	NEUTRAL
3	0.77	22.77	9.82	0.75	9.72	43.06	56.00	-12.94	QP	NEUTRAL
4	0.77	17.72	9.82	0.75	9.72	38.01	46.00	-7.99	Average	NEUTRAL
5	0.85	18.90	9.81	0.71	9.73	39.15	56.00	-16.85	QP	NEUTRAL
6	0.85	18.55	9.81	0.71	9.73	38.80	46.00	-7.20	Average	NEUTRAL
7	1.15	11.10	9.71	0.66	9.74	31.21	56.00	-24.79	QP	NEUTRAL
8	1.15	8.25	9.71	0.66	9.74	28.36	46.00	-17.64	Average	NEUTRAL
9	4.16	7.90	9.75	0.55	9.79	27.99	56.00	-28.01	QP	NEUTRAL
10	4.16	1.51	9.75	0.55	9.79	21.60	46.00	-24.40	Average	NEUTRAL
11	18.72	11.84	9.86	0.30	9.91	31.91	60.00	-28.09	QP	NEUTRAL
12	18.72	1.45	9.86	0.30	9.91	21.52	50.00	-28.48	Average	NEUTRAL

Note:

1. Result Level = Read Level + LISN Factor + Pulse Limiter Factor + Cable loss.
2. If QP Result complies with AV limit, AV Result is deemed to comply with AV limit.
3. Test setup: RBW: 200 Hz (9 kHz—150 kHz), 9 kHz (150 kHz—30 MHz).
4. Step size: 80Hz (0.009MHz-0.15MHz), 4 kHz (0.15MHz-30MHz), Scan time: auto.

TR-4-E-010 Conducted Emission Test Result

Test Site : DDT 1# Shield Room
Test Date : 2023-11-15
EUT : All-In-One Desktop Android HiFi Music Player
Power Supply : AC 120V/60Hz
Condition : TEMP:26.2°C, RH:58.9%
Memo : Sample Number:S23101912-01

D:\2023 CE report data\Q23101912-2E F3051R\FCC CE.EM6
Tested By : Junchang Du
Model Number : F3051R
Test Mode : 2.4GWiFi TX
LISN : 2023 1# ENV216/LINE

Data: 16

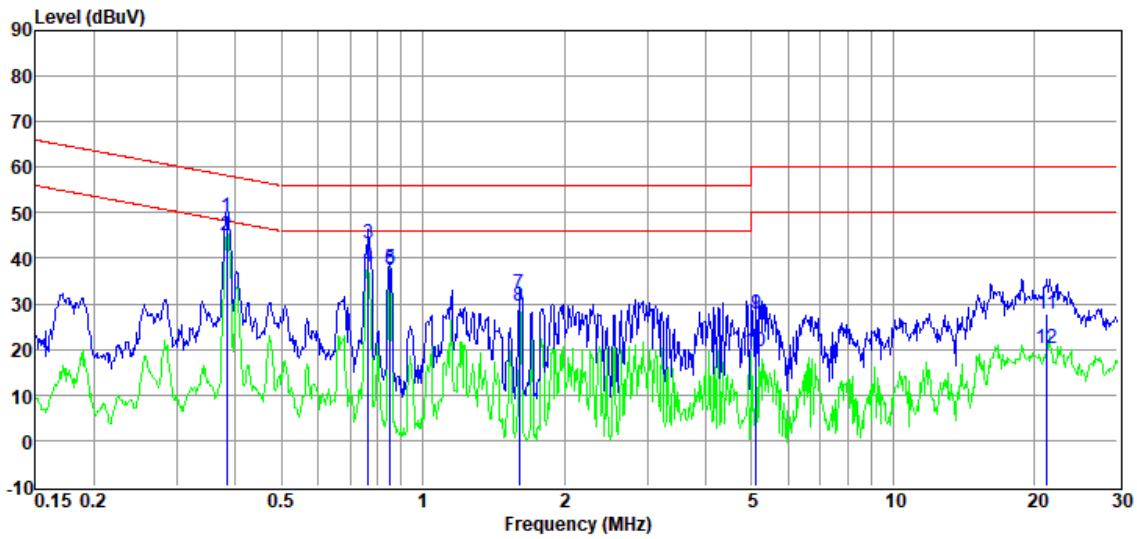

Item	Freq.	Read Level	LISN Factor	Cable Loss	Pulse Limiter Factor	Result Level	Limit Line	Over Limit	Detector	Phase
(Mark)	(MHz)	(dBμV)	(dB)	(dB)	(dB)	(dBμV)	(dBμV)	(dB)		
1	0.38	28.71	9.75	0.85	9.71	49.02	58.21	-9.19	QP	LINE
2	0.38	24.54	9.75	0.85	9.71	44.85	48.21	-3.36	Average	LINE
3	0.77	23.03	9.79	0.75	9.72	43.29	56.00	-12.71	QP	LINE
4	0.77	17.88	9.79	0.75	9.72	38.14	46.00	-7.86	Average	LINE
5	0.85	17.54	9.70	0.71	9.73	37.68	56.00	-18.32	QP	LINE
6	0.85	17.39	9.70	0.71	9.73	37.53	46.00	-8.47	Average	LINE
7	1.60	12.05	9.67	0.65	9.75	32.12	56.00	-23.88	QP	LINE
8	1.60	9.45	9.67	0.65	9.75	29.52	46.00	-16.48	Average	LINE
9	5.11	7.69	9.74	0.52	9.79	27.74	60.00	-32.26	QP	LINE
10	5.11	-0.61	9.74	0.52	9.79	19.44	50.00	-30.56	Average	LINE
11	21.26	7.68	9.96	0.37	9.92	27.93	60.00	-32.07	QP	LINE
12	21.26	-0.17	9.96	0.37	9.92	20.08	50.00	-29.92	Average	LINE

Note:

1. Result Level = Read Level + LISN Factor + Pulse Limiter Factor + Cable loss.
2. If QP Result complies with AV limit, AV Result is deemed to comply with AV limit.
3. Test setup: RBW: 200 Hz (9 kHz—150 kHz), 9 kHz (150 kHz—30 MHz).
4. Step size: 80Hz (0.009MHz-0.15MHz), 4 kHz (0.15MHz-30MHz), Scan time: auto.

14. Antenna Requirements

14.1. Limit

For intentional device, according to FCC 47 CFR Section 15.203, an intentional radiator shall be designed to ensure that no antenna other than that furnished by the responsible party shall be used with the device. And according to FCC 47 CFR Section 15.247 (b), if transmitting antennas of directional gain greater than 6 dBi are used, the power shall be reduced by the amount in dB that the directional gain of the antenna exceeds 6 dBi.

14.2. Result

The antenna used for this product as Antenna information described in section 2.1 of the report, and there is no other antenna than that furnished by the responsible party shall be used with the device.

16. Photos of the EUT

Please refer to appendix I.

END OF REPORT