

FCC Test Report

Report No.: RF180323D03-1

FCC ID: R4V-SDIZ90N

Test Model: SDIZ90N

Received Date: Mar. 23, 2018

Issued Date: Dec. 20, 2018

Applicant: Western Digital Technologies, Inc.

Address: 951 SanDisk Dr. Milpitas, California, 95035, USA

Issued By: Bureau Veritas Consumer Products Services (H.K.) Ltd., Taoyuan Branch

Lab Address: No. 47-2, 14th Ling, Chia Pau Vil., Lin Kou Dist., New Taipei City, Taiwan, R.O.C.

**FCC Registration /
Designation Number:** 198487 / TW2021



This report is for your exclusive use. Any copying or replication of this report to or for any other person or entity, or use of our name or trademark, is permitted only with our prior written permission. This report sets forth our findings solely with respect to the test samples identified herein. The results set forth in this report are not indicative or representative of the quality or characteristics of the lot from which a test sample was taken or any similar or identical product unless specifically and expressly noted. Our report includes all of the tests requested by you and the results thereof based upon the information that you provided to us. You have 60 days from date of issuance of this report to notify us of any material error or omission caused by our negligence, provided, however, that such notice shall be in writing and shall specifically address the issue you wish to raise. A failure to raise such issue within the prescribed time shall constitute your unqualified acceptance of the completeness of this report, the tests conducted and the correctness of the report contents. Unless specific mention, the uncertainty of measurement has been explicitly taken into account to declare the compliance or non-compliance to the specification. The report must not be used by the client to claim product certification, approval, or endorsement by TAF or any government agencies.

Table of Contents

Release Control Record	4
1 Certificate of Conformity	5
2 Summary of Test Results	6
2.1 Measurement Uncertainty	6
2.2 Modification Record	6
3 General Information	7
3.1 General Description of EUT	7
3.2 Description of Test Modes	8
3.2.1 Test Mode Applicability and Tested Channel Detail	9
3.3 Description of Support Units	11
3.3.1 Configuration of System under Test	11
3.4 Duty Cycle of Test Signal	12
3.5 General Description of Applied Standards	12
4 Test Types and Results	13
4.1 Radiated Emission and Bandedge Measurement	13
4.1.1 Limits of Radiated Emission and Bandedge Measurement	13
4.1.2 Test Instruments	14
4.1.3 Test Procedures	15
4.1.4 Deviation from Test Standard	15
4.1.5 Test Setup	16
4.1.6 EUT Operating Conditions	17
4.1.7 Test Results	18
4.2 Conducted Emission Measurement	23
4.2.1 Limits of Conducted Emission Measurement	23
4.2.2 Test Instruments	23
4.2.3 Test Procedures	24
4.2.4 Deviation from Test Standard	24
4.2.5 Test Setup	24
4.2.6 EUT Operating Conditions	24
4.2.7 Test Results	25
4.3 6dB Bandwidth Measurement	27
4.3.1 Limits of 6dB Bandwidth Measurement	27
4.3.2 Test Setup	27
4.3.3 Test Instruments	27
4.3.4 Test Procedure	27
4.3.5 Deviation from Test Standard	27
4.3.6 EUT Operating Conditions	27
4.3.7 Test Result	28
4.4 Conducted Output Power Measurement	29
4.4.1 Limits OF Conducted Output Power Measurement	29
4.4.2 Test Setup	29
4.4.3 Test Instruments	29
4.4.4 Test Procedures	29
4.4.5 Deviation from Test Standard	29
4.4.6 EUT Operating Conditions	29
4.4.7 Test Results	30
4.5 Power Spectral Density Measurement	31
4.5.1 Limits of Power Spectral Density Measurement	31
4.5.2 Test Setup	31
4.5.3 Test Instruments	31
4.5.4 Test Procedure	31
4.5.5 Deviation from Test Standard	31

4.5.6 EUT Operating Condition	31
4.5.7 Test Results	32
4.6 Conducted Out of Band Emission Measurement	33
4.6.1 Limits of Conducted Out of Band Emission Measurement.....	33
4.6.2 Test Setup.....	33
4.6.3 Test Instruments	33
4.6.4 Test Procedure	33
4.6.5 Deviation from Test Standard	33
4.6.6 EUT Operating Condition	33
4.6.7 Test Results	34
5 Pictures of Test Arrangements.....	35
Appendix – Information on the Testing Laboratories	36

Release Control Record

Issue No.	Description	Date Issued
RF180323D03-1	Original release.	Dec. 20, 2018

1 Certificate of Conformity

Product: iXpand Wireless Charger

Brand: SANDISK

Test Model: SDIZ90N

Sample Status: Engineering sample

Applicant: Western Digital Technologies, Inc.

Test Date: Nov. 29 ~ Dec. 3, 2018

Standards: 47 CFR FCC Part 15, Subpart C (Section 15.247)
ANSI C63.10: 2013

The above equipment has been tested by **Bureau Veritas Consumer Products Services (H.K.) Ltd., Taoyuan Branch**, and found compliance with the requirement of the above standards. The test record, data evaluation & Equipment Under Test (EUT) configurations represented herein are true and accurate accounts of the measurements of the sample's RF characteristics under the conditions specified in this report.

Prepared by : Jessica Cheng , **Date:** Dec. 20, 2018
Jessica Cheng / Senior Specialist

Approved by : Rex Lai , **Date:** Dec. 20, 2018
Rex Lai / Associate Technical Manager

2 Summary of Test Results

47 CFR FCC Part 15, Subpart C (SECTION 15.247)			
FCC Clause	Test Item	Result	Remarks
15.207	AC Power Conducted Emission	PASS	Meet the requirement of limit. Minimum passing margin is -9.83dB at 0.69941MHz.
15.205 & 209 & 15.247(d)	Radiated Emissions & Band Edge Measurement	PASS	Meet the requirement of limit. Minimum passing margin is -4.44dB at 2483.50MHz.
15.247(d)	Antenna Port Emission	PASS	Meet the requirement of limit.
15.247(a)(2)	6dB bandwidth	PASS	Meet the requirement of limit.
15.247(b)	Conducted power	PASS	Meet the requirement of limit.
15.247(e)	Power Spectral Density	PASS	Meet the requirement of limit.
15.203	Antenna Requirement	PASS	No antenna connector is used.

2.1 Measurement Uncertainty

Where relevant, the following measurement uncertainty levels have been estimated for tests performed on the EUT as specified in CISPR 16-4-2:

Measurement	Frequency	Expanded Uncertainty (k=2) (\pm)
Conducted Emissions at mains ports	150kHz ~ 30MHz	2.79 dB
Radiated Emissions up to 1 GHz	9kHz ~ 30MHz	2.38 dB
	30MHz ~ 1000MHz	5.54 dB
Radiated Emissions above 1 GHz	Above 1GHz	5.48 dB

2.2 Modification Record

There were no modifications required for compliance.

3 General Information

3.1 General Description of EUT

Product	iXpand Wireless Charger
Brand	SANDISK
Test Model	SDIZ90N
Status of EUT	Engineering sample
Nominal Voltage	12Vdc from adapter
Modulation Type	GFSK
Transfer Rate	Up to 1Mbps
Operating Frequency	2402MHz ~2480MHz
Number of Channel	40
Output Power	2.812mW
Antenna Type	Printed antenna with 2.46 dBi gain
Antenna Connector	N/A
Accessory Device	Refer to Note as below
Data Cable Supplied	N/A

Note:

1. The EUT uses following adapter.

Brand	Ktec
Model	KSA-18F-120150D5
Input Power	100-240Vac 50/60Hz 0.5A
Output Power	12Vdc 1.5A
Power Cord	AC 2-Pin Non-shielded DC cable (1.8m)

2. WLAN (2.4GHz) & BT & Qi technologies cannot transmit at same time.

3. The above EUT information is declared by manufacturer and for more detailed features description, please refer to the manufacturer's specifications or user's manual.

3.2 Description of Test Modes

40 channels are provided to this EUT:

CHANNEL	FREQ. (MHz)	CHANNEL	FREQ. (MHz)	CHANNEL	FREQ. (MHz)	CHANNEL	FREQ. (MHz)
0	2402	10	2422	20	2442	30	2462
1	2404	11	2424	21	2444	31	2464
2	2406	12	2426	22	2446	32	2466
3	2408	13	2428	23	2448	33	2468
4	2410	14	2430	24	2450	34	2470
5	2412	15	2432	25	2452	35	2472
6	2414	16	2434	26	2454	36	2474
7	2416	17	2436	27	2456	37	2476
8	2418	18	2438	28	2458	38	2478
9	2420	19	2440	29	2460	39	2480

3.2.1 Test Mode Applicability and Tested Channel Detail

EUT CONFIGURE MODE	APPLICABLE TO				DESCRIPTION
	RE \geq 1G	RE $<$ 1G	PLC	APCM	
-	√	√	√	√	-

Where **RE \geq 1G**: Radiated Emission above 1GHz **RE $<$ 1G**: Radiated Emission below 1GHz
PLC: Power Line Conducted Emission **APCM**: Antenna Port Conducted Measurement

Radiated Emission Test (Above 1GHz):

- Pre-Scan has been conducted to determine the worst-case mode from all possible combinations between available modulations, data rates and antenna ports (if EUT with antenna diversity architecture).
- Following channel(s) was (were) selected for the final test as listed below.

EUT Configure Mode	Available Channel	Tested Channel	Modulation Type	Data Rate (Mbps)
-	0 to 39	0, 19, 39	GFSK	1

Radiated Emission Test (Below 1GHz):

- Pre-Scan has been conducted to determine the worst-case mode from all possible combinations between available modulations, data rates and antenna ports (if EUT with antenna diversity architecture).
- Following channel(s) was (were) selected for the final test as listed below.

EUT Configure Mode	Available Channel	Tested Channel	Modulation Type	Data Rate (Mbps)
-	0 to 39	0	GFSK	1

Power Line Conducted Emission Test:

- Pre-Scan has been conducted to determine the worst-case mode from all possible combinations between available modulations, data rates and antenna ports (if EUT with antenna diversity architecture).
- Following channel(s) was (were) selected for the final test as listed below.

EUT Configure Mode	Available Channel	Tested Channel	Modulation Type	Data Rate (Mbps)
-	0 to 39	0	GFSK	1

Antenna Port Conducted Measurement:

- This item includes all test value of each mode, but only includes spectrum plot of worst value of each mode.
- Pre-Scan has been conducted to determine the worst-case mode from all possible combinations between available modulations, data rates and antenna ports (if EUT with antenna diversity architecture).
- Following channel(s) was (were) selected for the final test as listed below.

EUT Configure Mode	Available Channel	Tested Channel	Modulation Type	Data Rate (Mbps)
-	0 to 39	0, 19, 39	GFSK	1

Test Condition:

APPLICABLE TO	ENVIRONMENTAL CONDITIONS	INPUT POWER	TESTED BY
RE \geq 1G	20deg. C, 70%RH	120Vac, 60Hz	Starlitaly Wu
RE<1G	20deg. C, 70%RH	120Vac, 60Hz	Starlitaly Wu
PLC	25deg. C, 75%RH	120Vac, 60Hz	Ian Chang
APCM	25deg. C, 76%RH	120Vac, 60Hz	Saxon Lee

3.3 Description of Support Units

The EUT has been tested as an independent unit together with other necessary accessories or support units. The following support units or accessories were used to form a representative test configuration during the tests.

ID	Product	Brand	Model No.	Serial No.	FCC ID	Remarks
A.	LOAD	N/A	N/A	N/A	N/A	Provided by Lab

Note: All power cords of the above support units are non-shielded (1.8m).

ID	Descriptions	Qty.	Length (m)	Shielding (Yes/No)	Cores (Qty.)	Remarks
1.	DC cable	1	1.8	N	0	Supplied by client
2.	USB cable	1	1.0	Y	0	Provided by Lab

Note: The core(s) is(are) originally attached to the cable(s)

3.3.1 Configuration of System under Test

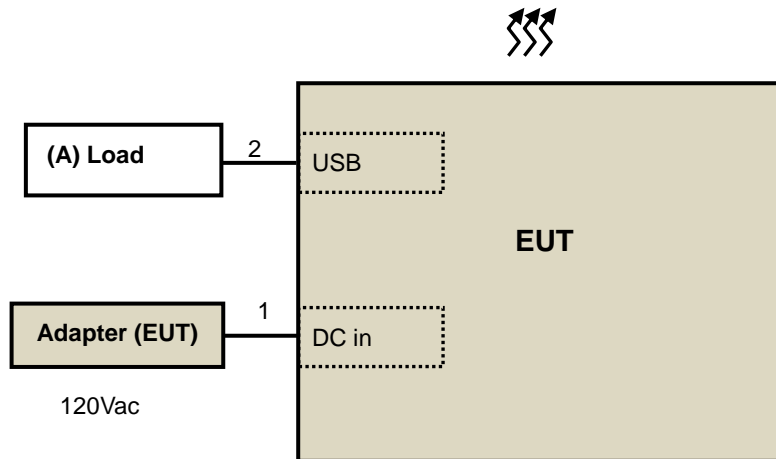

3.4 Duty Cycle of Test Signal

Duty cycle of test signal is < 98 %, duty factor shall be considered.

Duty cycle = $0.418\text{ms} / 0.626\text{ms} = 0.668$, Duty factor = $10 * \log(1/0.668) = 1.75$

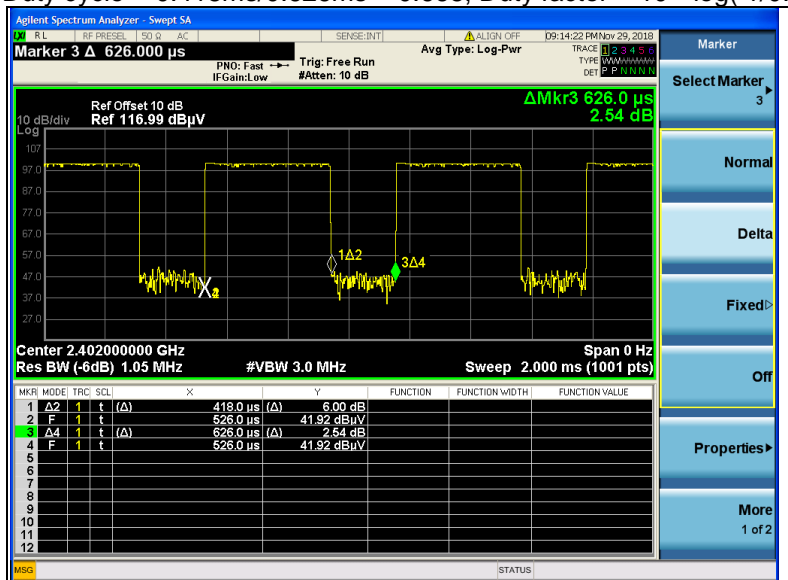

3.5 General Description of Applied Standards

The EUT is a RF Product. According to the specifications of the manufacturer, it must comply with the requirements of the following standards:

FCC Part 15, Subpart C (15.247)
KDB 558074 D01 15.247 Meas Guidance v05

ANSI C63.10-2013

All test items have been performed and recorded as per the above standards.

4 Test Types and Results

4.1 Radiated Emission and Bandedge Measurement

4.1.1 Limits of Radiated Emission and Bandedge Measurement

Radiated emissions which fall in the restricted bands must comply with the radiated emission limits specified as below table. Other emissions shall be at least 20dB below the highest level of the desired power:

Frequencies (MHz)	Field Strength (microvolts/meter)	Measurement Distance (meters)
0.009 ~ 0.490	2400/F(kHz)	300
0.490 ~ 1.705	24000/F(kHz)	30
1.705 ~ 30.0	30	30
30 ~ 88	100	3
88 ~ 216	150	3
216 ~ 960	200	3
Above 960	500	3

NOTE:

1. The lower limit shall apply at the transition frequencies.
2. Emission level (dBuV/m) = 20 log Emission level (uV/m).
3. For frequencies above 1000MHz, the field strength limits are based on average detector, however, the peak field strength of any emission shall not exceed the maximum permitted average limits, specified above by more than 20dB under any condition of modulation.

4.1.2 Test Instruments

DESCRIPTION & MANUFACTURER	MODEL NO.	SERIAL NO.	CALIBRATED DATE	CALIBRATED UNTIL
HP Preamplifier	8447D	2432A03504	Feb. 21, 2018	Feb. 20, 2019
HP Preamplifier	8449B	3008A01201	Feb. 22, 2018	Feb. 21, 2019
MITEQ Preamplifier	AMF-6F-260400-33-8P	892164	Feb. 21, 2018	Feb. 20, 2019
Agilent TEST RECEIVER	N9038A	MY51210129	Feb. 6, 2018	Feb. 5, 2019
Schwarzbeck Antenna	VULB 9168	139	Nov. 26, 2018	Nov. 25, 2019
Schwarzbeck Antenna	VHBA 9123	480	May 19, 2017	May 18, 2019
Schwarzbeck Horn Antenna	BBHA-9170	212	Dec. 1, 2017	Nov. 30, 2018
			Nov. 25, 2018	Nov. 24, 2019
Schwarzbeck Horn Antenna	BBHA 9120-D1	D130	Dec. 1, 2017	Nov. 30, 2018
			Nov. 25, 2018	Nov. 24, 2019
ADT. Turn Table	TT100	0306	NA	NA
ADT. Tower	AT100	0306	NA	NA
Software	Radiated_V7.6.15.9.5	NA	NA	NA
SUHNER RF cable With 4dB PAD	SF102	Cable-CH6-01	Aug. 13, 2018	Aug. 12, 2019
SUHNER RF cable With 3/4dB PAD	SF102	Cable-CH8-3.6m	Aug. 13, 2018	Aug. 12, 2019
KEYSIGHT MIMO Powermeasurement Test set	U2021XA	U2021XA-001	Jun. 4, 2018	Jun. 3, 2019
KEYSIGHT Spectrum Analyzer	N9030A	MY54490260	Aug. 3, 2018	Aug. 2, 2019
Loop Antenna EMCI	LPA600	270	Aug. 11, 2017	Aug. 10, 2019
EMCO Horn Antenna	3115	00028257	Nov. 30, 2017	Nov. 29, 2018
			Nov. 25, 2018	Nov. 24, 2019
Highpass filter Wainwright Instruments	WHK 3.1/18G-10SS	SN 8	NA	NA
ROHDE & SCHWARZ Spectrum Analyzer	FSV40	101042	Sep. 27, 2018	Sep. 26, 2019
Anritsu Power Sensor	MA2411B	0738404	Apr. 26, 2018	Apr. 25, 2019
Anritsu Power Meter	ML2495A	0842014	Apr. 26, 2018	Apr. 25, 2019

- NOTE:** 1. The calibration interval of the above test instruments is 12/24 months. And the calibrations are traceable to NML/ROC and NIST/USA.
2. The horn antenna and HP preamplifier (model: 8449B) are used only for the measurement of emission frequency above 1GHz if tested.
3. The test was performed in Chamber No. 6.
4. The Industry Canada Reference No. IC 7450E-6.

4.1.3 Test Procedures

For Radiated emission below 30MHz

- a. The EUT was placed on the top of a rotating table 0.8 meters above the ground at a 3 meter chamber room. The table was rotated 360 degrees to determine the position of the highest radiation.
- b. The EUT was set 3 meters away from the interference-receiving antenna, which was mounted on the top of a variable-height antenna tower.
- c. Parallel, perpendicular, and ground-parallel orientations of the antenna are set to make the measurement.
- d. For each suspected emission, the EUT was arranged to its worst case and the rotatable table was turned from 0 degrees to 360 degrees to find the maximum reading.
- e. The test-receiver system was set to Quasi-Peak Detect Function and Specified Bandwidth with Maximum Hold Mode.

NOTE:

1. The resolution bandwidth and video bandwidth of test receiver/spectrum analyzer is 9kHz at frequency below 30MHz.

For Radiated emission above 30MHz

- a. The EUT was placed on the top of a rotating table 0.8 meters (for 30MHz ~ 1GHz) / 1.5 meters (for above 1GHz) above the ground at 3 meter chamber room for test. The table was rotated 360 degrees to determine the position of the highest radiation.
- b. The EUT was set 3 meters away from the interference-receiving antenna, which was mounted on the top of a variable-height antenna tower.
- c. The height of antenna is varied from one meter to four meters above the ground to determine the maximum value of the field strength. Both horizontal and vertical polarizations of the antenna are set to make the measurement.
- d. For each suspected emission, the EUT was arranged to its worst case and then the antenna was tuned to heights from 1 meter to 4 meters and the rotatable table was turned from 0 degrees to 360 degrees to find the maximum reading.
- e. The test-receiver system was set to quasi-peak detect function and specified bandwidth with maximum hold mode when the test frequency is below 1 GHz.
- f. The test-receiver system was set to peak and average detect function and specified bandwidth with maximum hold mode when the test frequency is above 1 GHz. If the peak reading value also meets average limit, measurement with the average detector is unnecessary.

Note:

1. The resolution bandwidth and video bandwidth of test receiver/spectrum analyzer is 120kHz for Quasi-peak detection (QP) at frequency below 1GHz.
2. The resolution bandwidth of test receiver/spectrum analyzer is 1 MHz and the video bandwidth is 3 MHz for Peak detection (PK) at frequency above 1GHz.
3. The resolution bandwidth of test receiver/spectrum analyzer is 1MHz and the video bandwidth is $\geq 1/T$ (Duty cycle $< 98\%$) or 10Hz (Duty cycle $\geq 98\%$) for Average detection (AV) at frequency above 1GHz.
4. All modes of operation were investigated and the worst-case emissions are reported.

4.1.4 Deviation from Test Standard

No deviation.

4.1.5 Test Setup

For Radiated emission below 30MHz

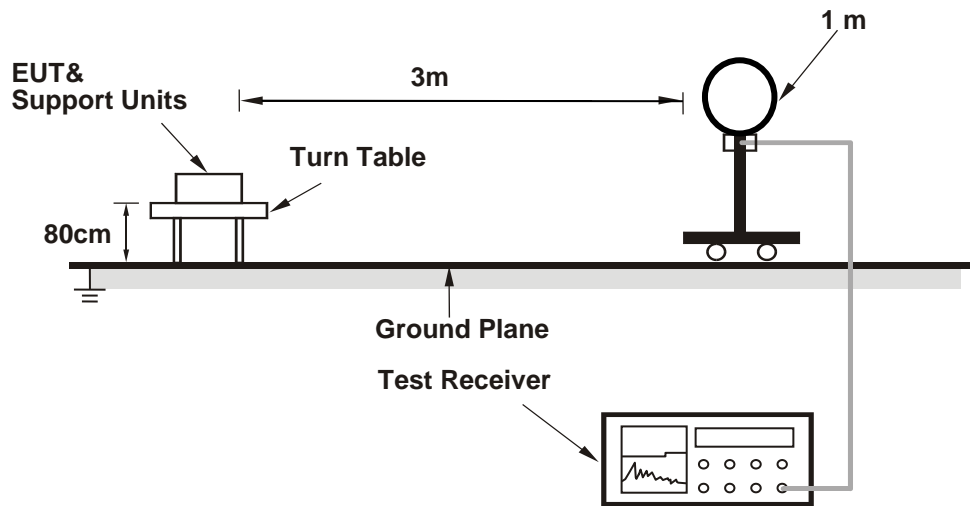

For Radiated emission 30MHz to 1GHz

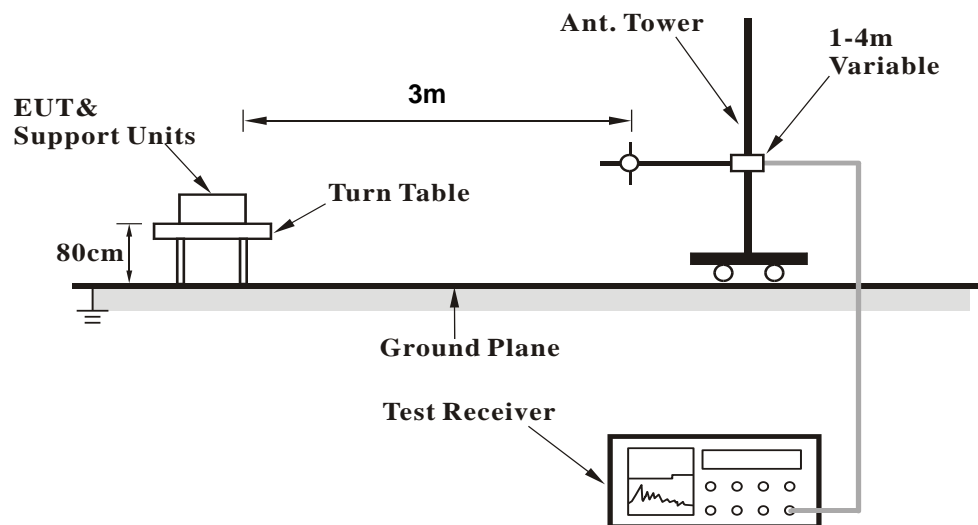

For Radiated emission above 1GHz

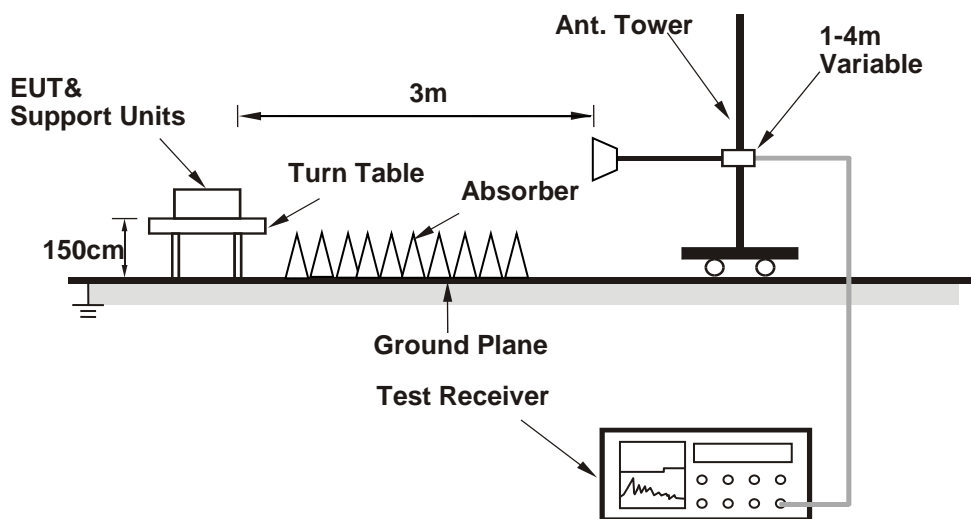

For the actual test configuration, please refer to the attached file (Test Setup Photo).

4.1.6 EUT Operating Conditions

- a. Connected the EUT with the Adapter.
- b. Set the EUT under transmission condition continuously at specific channel frequency continuously.

4.1.7 Test Results

ABOVE 1GHz DATA

CHANNEL	TX Channel 0	DETECTOR FUNCTION	Peak (PK)
FREQUENCY RANGE	1GHz ~ 25GHz		Average (AV)

ANTENNA POLARITY & TEST DISTANCE: HORIZONTAL AT 3 M								
NO.	FREQ. (MHz)	EMISSION LEVEL (dBuV/m)	LIMIT (dBuV/m)	MARGIN (dB)	ANTENNA HEIGHT (m)	TABLE ANGLE (Degree)	RAW VALUE (dBuV)	CORRECTION FACTOR (dB/m)
1	2390.00	63.68 PK	74.00	-10.32	1.49 H	25	65.18	-1.50
2	2390.00	41.16 AV	54.00	-12.84	1.49 H	25	42.66	-1.50
3	*2402.00	98.74 PK			1.49 H	25	100.33	-1.59
4	*2402.00	97.73 AV			1.49 H	25	99.32	-1.59
5	4804.00	46.28 PK	74.00	-27.72	1.18 H	209	41.55	4.73
6	4804.00	36.55 AV	54.00	-17.45	1.18 H	209	31.82	4.73

ANTENNA POLARITY & TEST DISTANCE: VERTICAL AT 3 M								
NO.	FREQ. (MHz)	EMISSION LEVEL (dBuV/m)	LIMIT (dBuV/m)	MARGIN (dB)	ANTENNA HEIGHT (m)	TABLE ANGLE (Degree)	RAW VALUE (dBuV)	CORRECTION FACTOR (dB/m)
1	2390.00	61.95 PK	74.00	-12.05	3.87 V	355	63.45	-1.50
2	2390.00	40.74 AV	54.00	-13.26	3.87 V	355	42.24	-1.50
3	*2402.00	97.48 PK			3.87 V	355	99.07	-1.59
4	*2402.00	96.52 AV			3.87 V	355	98.11	-1.59
5	4804.00	44.86 PK	74.00	-29.14	2.31 V	9	40.13	4.73
6	4804.00	34.48 AV	54.00	-19.52	2.31 V	9	29.75	4.73

REMARKS:

1. Emission Level(dBuV/m) = Raw Value(dBuV) + Correction Factor(dB/m)
2. Correction Factor(dB/m) = Antenna Factor(dB/m) + Cable Factor(dB) – Pre-Amplifier Factor(dB)
3. The other emission levels were very low against the limit.
4. Margin value = Emission Level – Limit value
5. " * ": Fundamental frequency.

CHANNEL	TX Channel 19	DETECTOR FUNCTION	Peak (PK)
FREQUENCY RANGE	1GHz ~ 25GHz		Average (AV)

ANTENNA POLARITY & TEST DISTANCE: HORIZONTAL AT 3 M

NO.	FREQ. (MHz)	EMISSION LEVEL (dBuV/m)	LIMIT (dBuV/m)	MARGIN (dB)	ANTENNA HEIGHT (m)	TABLE ANGLE (Degree)	RAW VALUE (dBuV)	CORRECTION FACTOR (dB/m)
1	*2440.00	97.67 PK			1.30 H	25	99.42	-1.75
2	*2440.00	96.51 AV			1.30 H	25	98.26	-1.75
3	4880.00	46.06 PK	74.00	-27.94	1.21 H	216	41.19	4.87
4	4880.00	36.56 AV	54.00	-17.44	1.21 H	216	31.69	4.87

ANTENNA POLARITY & TEST DISTANCE: VERTICAL AT 3 M

NO.	FREQ. (MHz)	EMISSION LEVEL (dBuV/m)	LIMIT (dBuV/m)	MARGIN (dB)	ANTENNA HEIGHT (m)	TABLE ANGLE (Degree)	RAW VALUE (dBuV)	CORRECTION FACTOR (dB/m)
1	*2440.00	96.71 PK			3.92 V	349	98.46	-1.75
2	*2440.00	95.88 AV			3.92 V	349	97.63	-1.75
3	4880.00	45.29 PK	74.00	-28.71	2.33 V	15	40.42	4.87
4	4880.00	34.50 AV	54.00	-19.50	2.33 V	15	29.63	4.87

REMARKS:

1. Emission Level(dBuV/m) = Raw Value(dBuV) + Correction Factor(dB/m)
2. Correction Factor(dB/m) = Antenna Factor(dB/m) + Cable Factor(dB) – Pre-Amplifier Factor(dB)
3. The other emission levels were very low against the limit.
4. Margin value = Emission Level – Limit value
5. " * ": Fundamental frequency.

CHANNEL	TX Channel 39	DETECTOR FUNCTION	Peak (PK)
FREQUENCY RANGE	1GHz ~ 25GHz		Average (AV)

ANTENNA POLARITY & TEST DISTANCE: HORIZONTAL AT 3 M

NO.	FREQ. (MHz)	EMISSION LEVEL (dBuV/m)	LIMIT (dBuV/m)	MARGIN (dB)	ANTENNA HEIGHT (m)	TABLE ANGLE (Degree)	RAW VALUE (dBuV)	CORRECTION FACTOR (dB/m)
1	*2480.00	96.07 PK			1.13 H	20	97.44	-1.37
2	*2480.00	95.00 AV			1.13 H	20	96.37	-1.37
3	2483.50	69.56 PK	74.00	-4.44	1.13 H	20	70.88	-1.32
4	2483.50	41.01 AV	54.00	-12.99	1.13 H	20	42.33	-1.32
5	4960.00	46.51 PK	74.00	-27.49	1.11 H	218	41.78	4.73
6	4960.00	36.21 AV	54.00	-17.79	1.11 H	218	31.48	4.73

ANTENNA POLARITY & TEST DISTANCE: VERTICAL AT 3 M

NO.	FREQ. (MHz)	EMISSION LEVEL (dBuV/m)	LIMIT (dBuV/m)	MARGIN (dB)	ANTENNA HEIGHT (m)	TABLE ANGLE (Degree)	RAW VALUE (dBuV)	CORRECTION FACTOR (dB/m)
1	*2480.00	95.13 PK			3.79 V	349	96.50	-1.37
2	*2480.00	93.97 AV			3.79 V	349	95.34	-1.37
3	2483.50	64.13 PK	74.00	-9.87	3.79 V	349	65.45	-1.32
4	2483.50	38.84 AV	54.00	-15.16	3.79 V	349	40.16	-1.32
5	4960.00	44.89 PK	74.00	-29.11	2.25 V	13	40.16	4.73
6	4960.00	34.04 AV	54.00	-19.96	2.25 V	13	29.31	4.73

REMARKS:

1. Emission Level(dBuV/m) = Raw Value(dBuV) + Correction Factor(dB/m)
2. Correction Factor(dB/m) = Antenna Factor(dB/m) + Cable Factor(dB) – Pre-Amplifier Factor(dB)
3. The other emission levels were very low against the limit.
4. Margin value = Emission Level – Limit value
5. " * ": Fundamental frequency.

Below 1GHz Data:

CHANNEL	TX Channel 0	DETECTOR FUNCTION	Quasi-Peak (QP)
FREQUENCY RANGE	9kHz ~ 1GHz		

ANTENNA POLARITY & TEST DISTANCE: HORIZONTAL AT 3 M								
NO.	FREQ. (MHz)	EMISSION LEVEL (dBuV/m)	LIMIT (dBuV/m)	MARGIN (dB)	ANTENNA HEIGHT (m)	TABLE ANGLE (Degree)	RAW VALUE (dBuV)	CORRECTION FACTOR (dB/m)
1	76.56	26.81 QP	40.00	-13.19	1.74 H	72	37.38	-10.57
2	173.03	25.81 QP	43.50	-17.69	1.49 H	86	33.37	-7.56
3	308.44	31.39 QP	46.00	-14.61	1.82 H	220	36.37	-4.98
4	372.31	29.67 QP	46.00	-16.33	2.13 H	336	33.48	-3.81
5	530.47	27.92 QP	46.00	-18.08	2.20 H	346	28.73	-0.81
6	626.74	29.19 QP	46.00	-16.81	1.98 H	234	27.67	1.52
7	717.44	33.93 QP	46.00	-12.07	1.87 H	163	31.30	2.63

REMARKS:

1. Emission Level(dBuV/m) = Raw Value(dBuV) + Correction Factor(dB/m)
2. Correction Factor(dB/m) = Antenna Factor(dB/m) + Cable Factor(dB) – Pre-Amplifier Factor(dB)
3. The other emission levels were very low against the limit.
4. Margin value = Emission Level – Limit value
5. The emission levels were very low against the limit of frequency range 9kHz ~ 30MHz :the amplitude of spurious emissions attenuated more than 20 dB below the permissible value to be report.

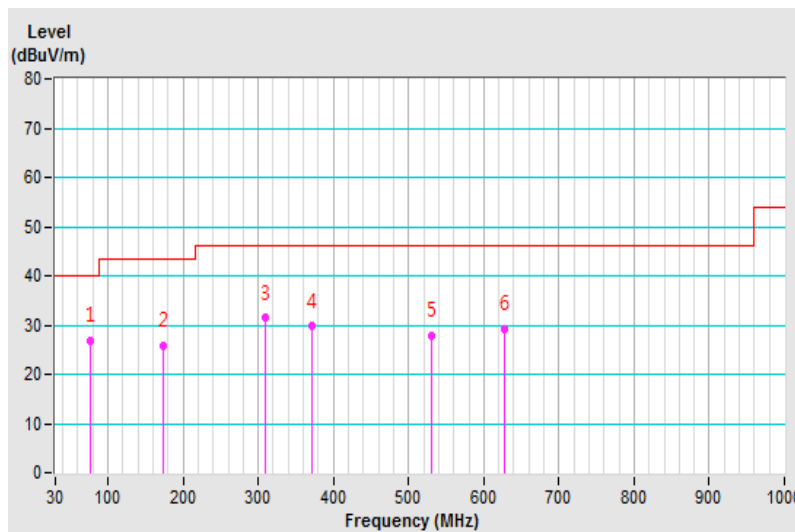

CHANNEL	TX Channel 0	DETECTOR FUNCTION	Quasi-Peak (QP)
FREQUENCY RANGE	9kHz ~ 1GHz		

ANTENNA POLARITY & TEST DISTANCE: VERTICAL AT 3 M								
NO.	FREQ. (MHz)	EMISSION LEVEL (dBuV/m)	LIMIT (dBuV/m)	MARGIN (dB)	ANTENNA HEIGHT (m)	TABLE ANGLE (Degree)	RAW VALUE (dBuV)	CORRECTION FACTOR (dB/m)
1	61.67	31.60 QP	40.00	-8.40	2.05 V	145	39.34	-7.74
2	108.52	23.53 QP	43.50	-19.97	1.69 V	64	34.06	-10.53
3	160.85	23.92 QP	43.50	-19.58	1.80 V	16	30.80	-6.88
4	229.38	22.06 QP	46.00	-23.94	1.39 V	94	31.45	-9.39
5	316.93	30.36 QP	46.00	-15.64	2.63 V	206	35.09	-4.73
6	540.66	28.35 QP	46.00	-17.65	1.97 V	360	29.03	-0.68

REMARKS:

1. Emission Level(dBuV/m) = Raw Value(dBuV) + Correction Factor(dB/m)
2. Correction Factor(dB/m) = Antenna Factor(dB/m) + Cable Factor(dB) – Pre-Amplifier Factor(dB)
3. The other emission levels were very low against the limit.
4. Margin value = Emission Level – Limit value
5. The emission levels were very low against the limit of frequency range 9kHz ~ 30MHz :the amplitude of spurious emissions attenuated more than 20 dB below the permissible value to be report.

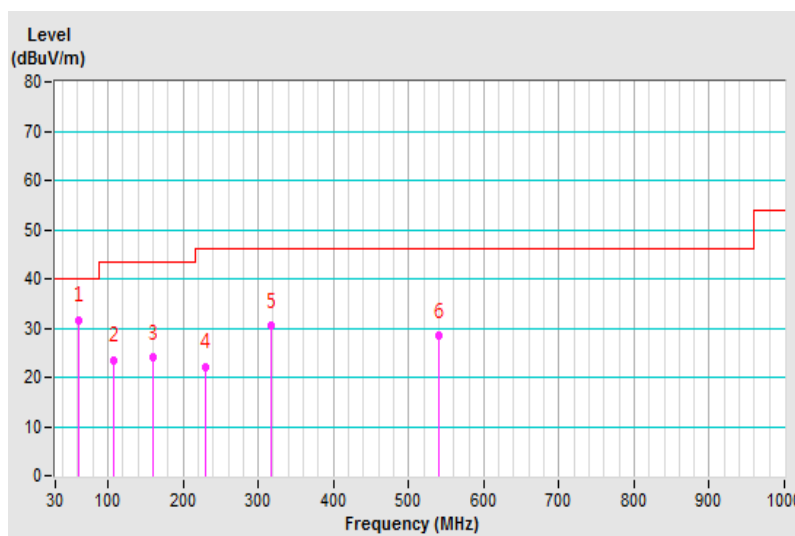

4.2 Conducted Emission Measurement

4.2.1 Limits of Conducted Emission Measurement

Frequency (MHz)	Conducted Limit (dBuV)	
	Quasi-peak	Average
0.15 - 0.5	66 - 56	56 - 46
0.50 - 5.0	56	46
5.0 - 30.0	60	50

Note: 1. The lower limit shall apply at the transition frequencies.

2. The limit decreases in line with the logarithm of the frequency in the range of 0.15 to 0.50MHz.

4.2.2 Test Instruments

Description & Manufacturer	Model No.	Serial No.	Cal. Date	Cal. Due
ROHDE & SCHWARZ TEST RECEIVER	ESR3	102414	Feb. 7, 2018	Feb. 6, 2019
ROHDE & SCHWARZ Artificial Mains Network (for EUT)	ENV216	101197	May 23, 2018	May 22, 2019
LISN With Adapter (for EUT)	AD10	C10Ada-002	May 23, 2018	May 22, 2019
ROHDE & SCHWARZ Artificial Mains Network (for peripherals)	38215	9504-2359	Jul. 26, 2018	Jul. 25, 2019
SCHWARZBECK Artificial Mains Network (For EUT)	NNLK8129	8129229	May 3, 2018	May 2, 2019
Software	Cond_V7.3.7.4	NA	NA	NA
RF cable (JYEBAO) With 10dB PAD	5D-FB	Cable-C10.01	Feb. 14, 2018	Feb. 13, 2019
SUHNTER Terminator (For ROHDE & SCHWARZ LISN)	65BNC-5001	E1-011484	May 8, 2018	May 7, 2019
ROHDE & SCHWARZ Artificial Mains Network (For TV EUT)	ESH3-Z5	100220	Nov. 21, 2018	Nov. 20, 2019
LISN With Adapter (for TV EUT)	100220	N/A	Nov. 21, 2018	Nov. 20, 2019

Notes: 1. The calibration interval of the above test instruments is 12 months and the calibrations are traceable to NML/ROC and NIST/USA.

2. The test was performed in Shielded Room No. 10.

4.2.3 Test Procedures

- a. The EUT was placed 0.4 meters from the conducting wall of the shielded room with EUT being connected to the power mains through a line impedance stabilization network (LISN). Other support units were connected to the power mains through another LISN. The two LISNs provide 50 ohm/ 50uH of coupling impedance for the measuring instrument.
- b. Both lines of the power mains connected to the EUT were checked for maximum conducted interference.
- c. The frequency range from 150kHz to 30MHz was searched. Emission levels under (Limit - 20dB) was not recorded.

NOTE: The resolution bandwidth and video bandwidth of test receiver is 9kHz for quasi-peak detection (QP) and average detection (AV) at frequency 0.15MHz-30MHz.

4.2.4 Deviation from Test Standard

No deviation.

4.2.5 Test Setup

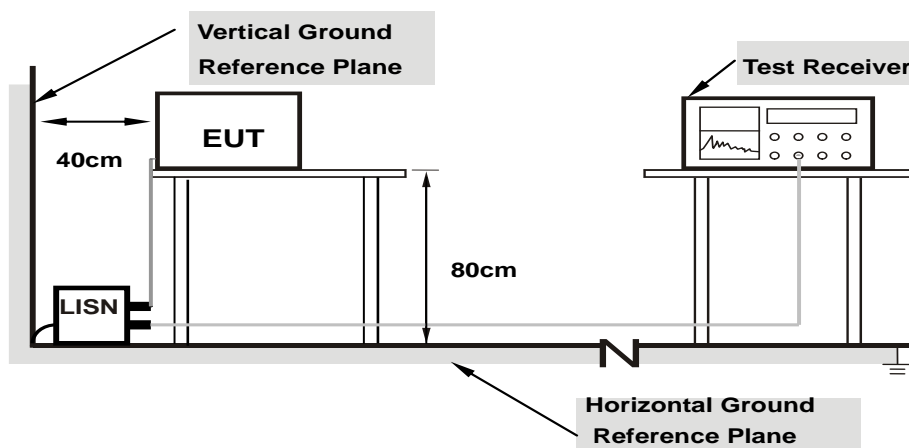

Note: 1.Support units were connected to second LISN.

For the actual test configuration, please refer to the attached file (Test Setup Photo).

4.2.6 EUT Operating Conditions

Same as Item 4.1.6.

4.2.7 Test Results

Phase	Line (L)	Detector Function	Quasi-Peak (QP) / Average (AV)
-------	----------	-------------------	--------------------------------

Phase Of Power : Line (L)										
No	Frequency (MHz)	Correction Factor (dB)	Reading Value (dBuV)		Emission Level (dBuV)		Limit (dBuV)		Margin (dB)	
			Q.P.	AV.	Q.P.	AV.	Q.P.	AV.	Q.P.	AV.
1	0.15391	9.68	28.91	10.07	38.59	19.75	65.79	55.79	-27.20	-36.04
2	0.21621	9.70	26.39	11.72	36.09	21.42	62.96	52.96	-26.87	-31.54
3	0.69941	9.81	31.06	26.36	40.87	36.17	56.00	46.00	-15.13	-9.83
4	1.97016	9.98	12.55	8.07	22.53	18.05	56.00	46.00	-33.47	-27.95
5	3.64364	10.05	8.10	5.13	18.15	15.18	56.00	46.00	-37.85	-30.82
6	14.52867	10.30	8.96	4.59	19.26	14.89	60.00	50.00	-40.74	-35.11

Remarks:

1. Q.P. and AV. are abbreviations of quasi-peak and average individually.
2. The emission levels of other frequencies were very low against the limit.
3. Margin value = Emission level – Limit value
4. Correction factor = Insertion loss + Cable loss
5. Emission Level = Correction Factor + Reading Value

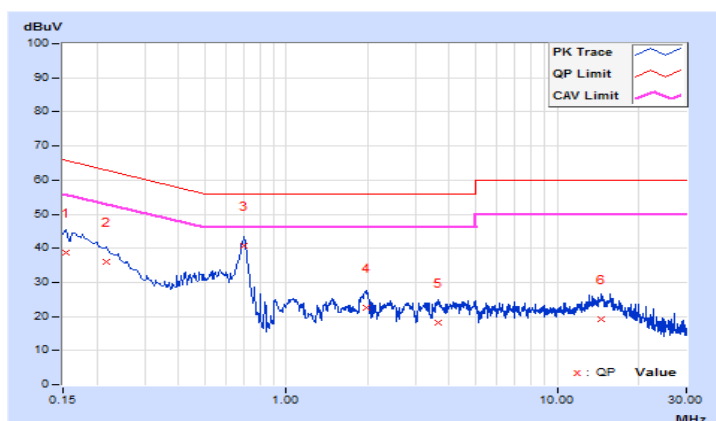

Phase	Neutral (N)	Detector Function	Quasi-Peak (QP) / Average (AV)
-------	-------------	-------------------	--------------------------------

Phase Of Power : Neutral (N)										
No	Frequency (MHz)	Correction Factor (dB)	Reading Value (dBuV)		Emission Level (dBuV)		Limit (dBuV)		Margin (dB)	
			Q.P.	AV.	Q.P.	AV.	Q.P.	AV.	Q.P.	AV.
1	0.15000	9.69	29.00	10.64	38.69	20.33	66.00	56.00	-27.31	-35.67
2	0.23993	9.74	21.49	7.06	31.23	16.80	62.10	52.10	-30.87	-35.30
3	0.70332	9.85	24.57	14.17	34.42	24.02	56.00	46.00	-21.58	-21.98
4	1.92092	9.98	10.41	1.97	20.39	11.95	56.00	46.00	-35.61	-34.05
5	4.72280	10.09	10.90	3.37	20.99	13.46	56.00	46.00	-35.01	-32.54
6	14.48175	10.30	10.44	2.81	20.74	13.11	60.00	50.00	-39.26	-36.89

Remarks:

1. Q.P. and AV. are abbreviations of quasi-peak and average individually.
2. The emission levels of other frequencies were very low against the limit.
3. Margin value = Emission level – Limit value
4. Correction factor = Insertion loss + Cable loss
5. Emission Level = Correction Factor + Reading Value

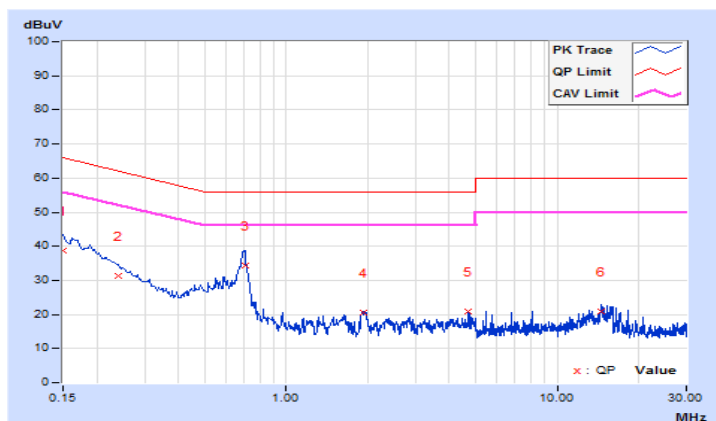

4.3 6dB Bandwidth Measurement

4.3.1 Limits of 6dB Bandwidth Measurement

The minimum of 6dB Bandwidth Measurement is 0.5 MHz.

4.3.2 Test Setup

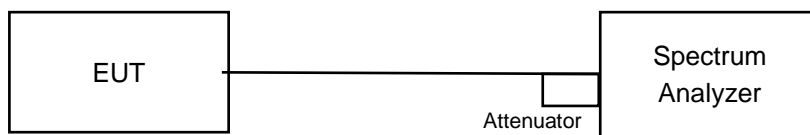

4.3.3 Test Instruments

Refer to section 4.1.2 to get information of above instrument.

4.3.4 Test Procedure

- a. Set resolution bandwidth (RBW) = 100kHz
- b. Set the video bandwidth (VBW) $\geq 3 \times$ RBW, Detector = Peak.
- c. Trace mode = max hold.
- d. Sweep = auto couple.
- e. Measure the maximum width of the emission that is constrained by the frequencies associated with the two amplitude points (upper and lower) that are attenuated by 6 dB relative to the maximum level measured in the fundamental emission

4.3.5 Deviation from Test Standard

No deviation.

4.3.6 EUT Operating Conditions

The software provided by client to enable the EUT under transmission condition continuously at lowest, middle and highest channel frequencies individually.

4.3.7 Test Result

Channel	Frequency (MHz)	6dB Bandwidth (MHz)	Minimum Limit (MHz)	Pass / Fail
0	2402	0.69	0.5	Pass
19	2440	0.70	0.5	Pass
39	2480	0.71	0.5	Pass

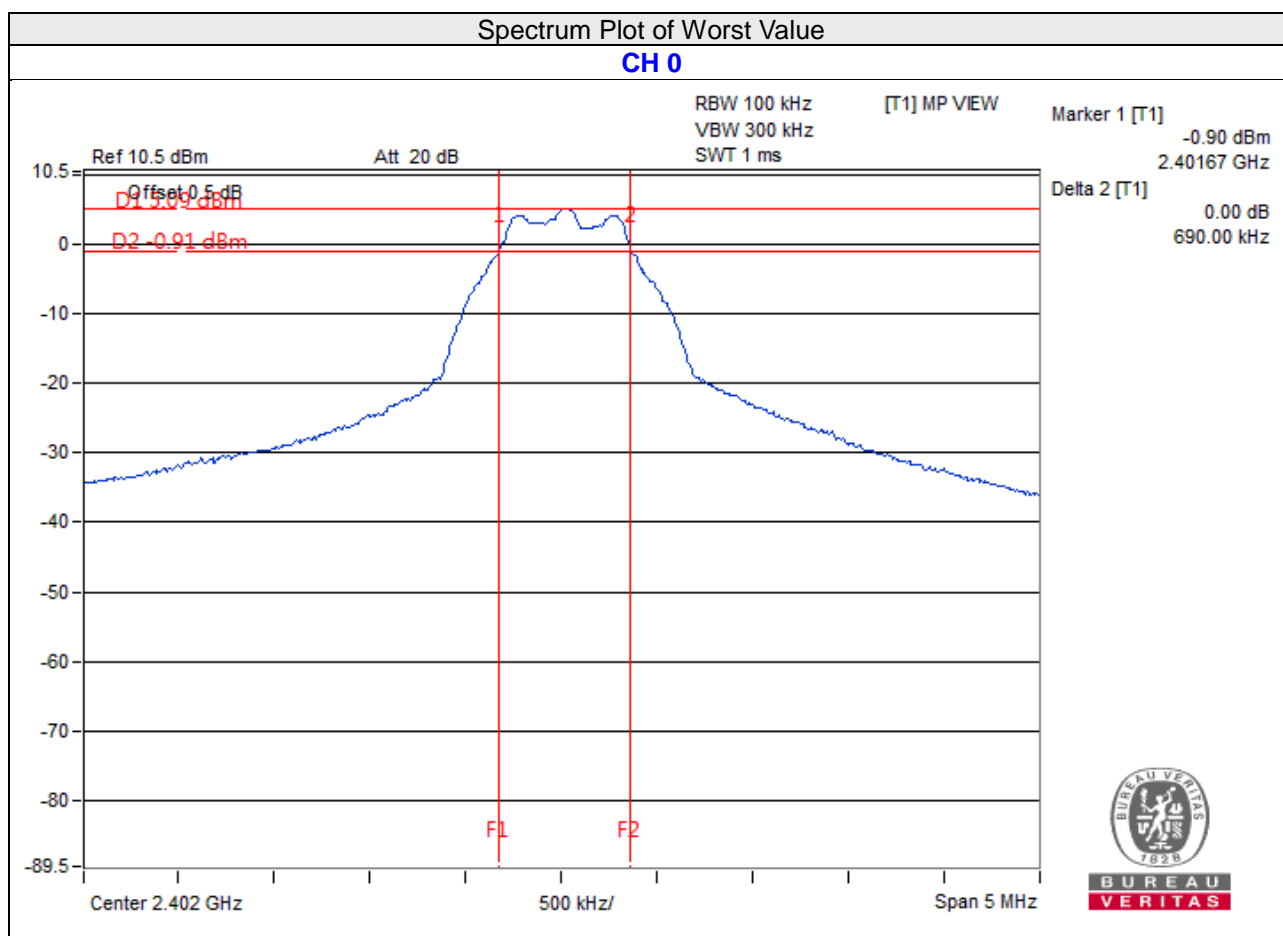

4.4 Conducted Output Power Measurement

4.4.1 Limits OF Conducted Output Power Measurement

For systems using digital modulation in the 2400–2483.5 MHz bands: 1 Watt (30dBm)

4.4.2 Test Setup

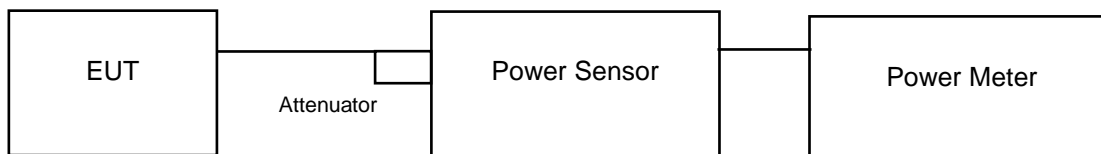

4.4.3 Test Instruments

Refer to section 4.1.2 to get information of above instrument.

4.4.4 Test Procedures

A peak power sensor was used on the output port of the EUT. A power meter was used to read the response of the peak power sensor. Record the power level.

Average power sensor was used to perform output power measurement, trigger and gating function of wide band power meter is enabled to measure max output power of TX on burst. Duty factor is not added to measured value.

4.4.5 Deviation from Test Standard

No deviation.

4.4.6 EUT Operating Conditions

Same as Item 4.3.6.

4.4.7 Test Results

FOR PEAK POWER

Channel	Frequency (MHz)	Peak Power (mW)	Peak Power (dBm)	Limit (dBm)	Pass/Fail
0	2402	2.812	4.49	30	Pass
19	2440	2.729	4.36	30	Pass
39	2480	2.63	4.20	30	Pass

FOR AVERAGE POWER

Channel	Frequency (MHz)	Average Power (mW)	Average Power (dBm)
0	2402	2.077	4.43
19	2440	2.685	4.29
39	2480	2.582	4.12

4.5 Power Spectral Density Measurement

4.5.1 Limits of Power Spectral Density Measurement

The Maximum of Power Spectral Density Measurement is 8dBm.

4.5.2 Test Setup

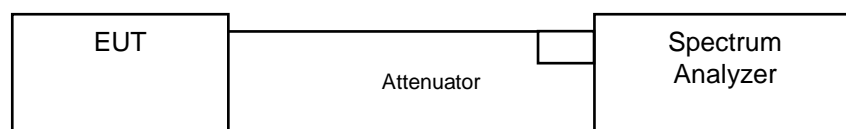

4.5.3 Test Instruments

Refer to section 4.1.2 to get information of above instrument.

4.5.4 Test Procedure

- a. Set analyzer center frequency to DTS channel center frequency.
- b. Set the span to 1.5 times the DTS bandwidth.
- c. Set the RBW to: $3 \text{ kHz} \leq \text{RBW} \leq 100 \text{ kHz}$.
- d. Set the VBW $\geq 3 \times \text{RBW}$.
- e. Detector = peak.
- f. Sweep time = auto couple.
- g. Trace mode = max hold.
- h. Allow trace to fully stabilize.
- i. Use the peak marker function to determine the maximum amplitude level within the RBW.

4.5.5 Deviation from Test Standard

No deviation.

4.5.6 EUT Operating Condition

Same as Item 4.3.6

4.5.7 Test Results

Channel	Freq. (MHz)	PSD (dBm/3kHz)	Limit (dBm/3kHz)	Pass /Fail
0	2402	-9.45	8	Pass
19	2440	-9.94	8	Pass
39	2480	-9.48	8	Pass

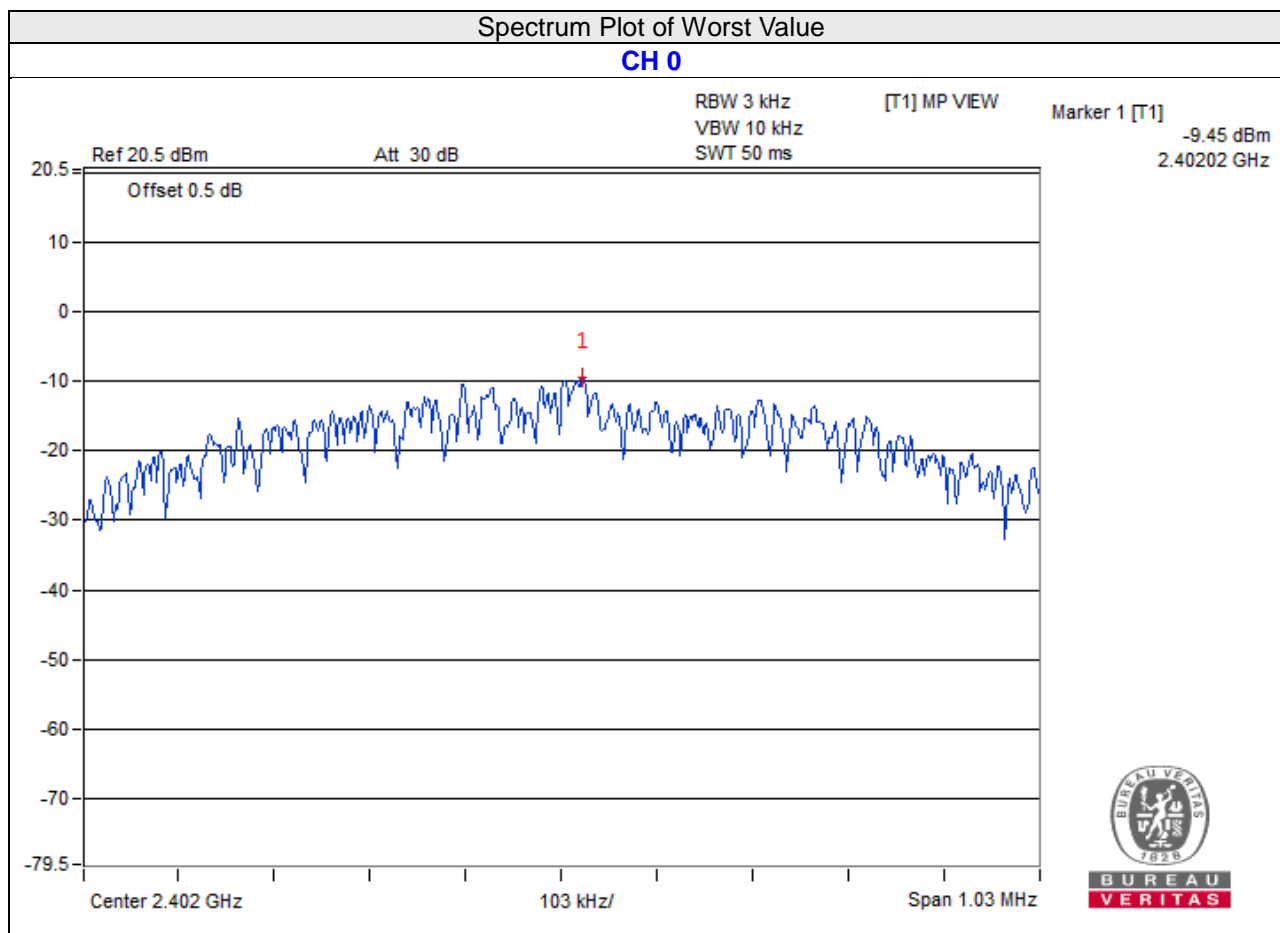

4.6 Conducted Out of Band Emission Measurement

4.6.1 Limits of Conducted Out of Band Emission Measurement

Below -20dB of the highest emission level of operating band (in 100kHz Resolution Bandwidth).

4.6.2 Test Setup

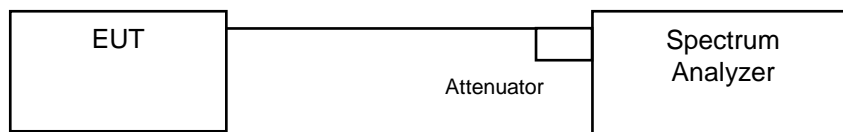

4.6.3 Test Instruments

Refer to section 4.1.2 to get information of above instrument.

4.6.4 Test Procedure

MEASUREMENT PROCEDURE REF

1. Set the RBW = 100 kHz.
2. Set the VBW \geq 300 kHz.
3. Detector = peak.
4. Sweep time = auto couple.
5. Trace mode = max hold.
6. Allow trace to fully stabilize.
7. Use the peak marker function to determine the maximum power level in any 100 kHz band segment within the fundamental EBW.

MEASUREMENT PROCEDURE OOBE

1. Set RBW = 100 kHz.
2. Set VBW \geq 300 kHz.
3. Detector = peak.
4. Sweep = auto couple.
5. Trace Mode = max hold.
6. Allow trace to fully stabilize.
7. Use the peak marker function to determine the maximum amplitude level.

4.6.5 Deviation from Test Standard

No deviation.

4.6.6 EUT Operating Condition

Same as Item 4.3.6

4.6.7 Test Results

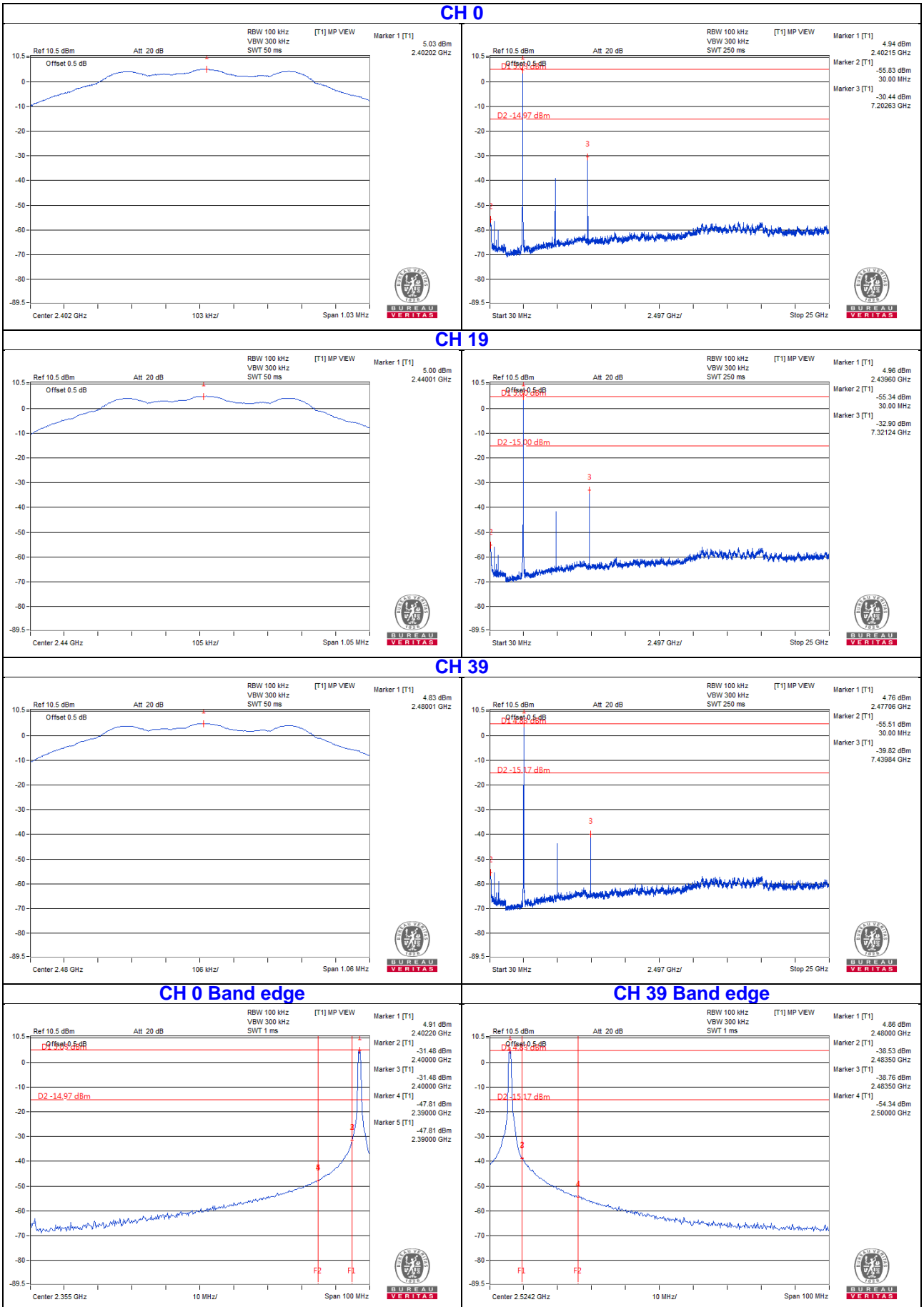

5 Pictures of Test Arrangements

Please refer to the attached file (Test Setup Photo).

Appendix – Information on the Testing Laboratories

We, Bureau Veritas Consumer Products Services (H.K.) Ltd., Taoyuan Branch, were founded in 1988 to provide our best service in EMC, Radio, Telecom and Safety consultation. Our laboratories are FCC recognized accredited test firms and accredited according to ISO/IEC 17025.

If you have any comments, please feel free to contact us at the following:

Linkou EMC/RF Lab

Tel: 886-2-26052180

Fax: 886-2-26051924

Hsin Chu EMC/RF/Telecom Lab

Tel: 886-3-6668565

Fax: 886-3-6668323

Hwa Ya EMC/RF/Safety Lab

Tel: 886-3-3183232

Fax: 886-3-3270892

Email: service.adt@tw.bureauveritas.com

Web Site: www.bureauveritas-adt.com

The address and road map of all our labs can be found in our web site also.

--- END ---