

Test Report

Product	DECT Base Station with USB		
Name and address of the applicant	DSEA A/S Kongebakken 9, DK-2765 Smørum Denmark		
Name and address of the manufacturer	DSEA A/S Kongebakken 9, DK-2765 Smørum Denmark		
Model	SCDB9 / SCDB12 / SCDB13		
Rating	Mains (100-240V _{AC} , 50-60Hz, 150mA)		
Trademark	EPOS		
Serial number	See clause 1.1		
Additional information	DECT 6.0, USB		
Tested according to	FCC Part 15, subpart D Isochronous UPCS Device, 1920 – 1930 MHz		
Order number	408910		
Tested in period	2020-11-05 to 2020-12-16 and 2021-04-30		
Issue date	2021-05-10		
Name and address of the testing laboratory	 Instituttveien 6 Kjeller, Norway www.nemko.com	CAB Number: FCC: NO0001 ISED: NO0470 TEL: +47 22 96 03 30 FAX: +47 22 96 05 50	 
An accredited technical test executed under the Norwegian accreditation scheme			
 Prepared by [Frode Sveinsen]		 Approved by [G.Suhanthakumar]	
This report shall not be reproduced except in full without the written approval of Nemko. Opinions and interpretations expressed within this report are not part of the current accreditation. This report was originally distributed electronically with digital signatures. For more information please contact Nemko.			

CONTENTS

1	INFORMATION	3
1.1	Tested Item.....	3
1.2	Description of Tested Device.....	3
1.3	Test Conditions.....	4
1.4	Test Engineer(s).....	4
1.5	Digital Modulation Techniques.....	4
1.6	Labeling Requirements.....	4
1.7	Antenna Requirement.....	4
1.8	Channel Frequencies.....	5
1.9	Other Comments	5
2	TEST REPORT SUMMARY	6
2.1	General.....	6
2.2	Test Summary	7
3	TEST RESULTS.....	8
3.1	Power Line Conducted Emissions	8
3.2	Automatic Discontinuation of Transmission	10
3.3	Peak Power Output.....	11
3.4	Emission Bandwidth <i>B</i>	13
3.5	Power Spectral Density	15
3.6	In-Band Unwanted Emissions, Conducted	17
3.7	Out-of-band Emissions, Conducted.....	19
3.8	Carrier Frequency Stability	22
3.9	Frame Repetition Stability.....	23
3.10	Frame Period and Jitter	23
3.11	Monitoring Threshold, Least Interfered Channel.....	25
3.12	Threshold Monitoring Bandwidth	27
3.13	Reaction Time and Monitoring Interval	28
3.14	Time and Spectrum Window Access Procedure.....	30
3.15	Acknowledgements and Transmission Duration.....	32
3.16	Dual Access Criteria Check.....	33
3.17	Alternative Monitoring Interval	33
4	MEASUREMENT UNCERTAINTY	34
5	TEST SETUPS	35
5.1	Frequency Measurements	35
5.2	Timing Measurements	35
5.3	Conducted Emission Test.....	35
5.4	Power Line Conducted Emissions Test	35
5.5	Monitoring Tests	36
6	TEST EQUIPMENT USED	37

1 INFORMATION

1.1 Tested Item

Name	EPOS
Model name	SCDB9 SCDB12 SCDB13
FCC ID	R3USCDB9
Serial number	Conducted Sample: 51253052 Radiated Sample: 51253036
Hardware identity and/or version	Rev3
Software identity and/or version	173
Frequency Range	1921.536 – 1928.448 MHz
Number of Channels	5 RF Channels, 5x12 = 60 TDMA Duplex Channels
Type of Modulation	Digital (Gaussian Frequency Shift Keying)
Conducted Output Power	89 mW (Peak)
Antenna Connector	None (Internal Antennas)
Number of Antennas	2
Antenna Diversity	Yes
Power Supply	USB or AC Adaptor
AC Adaptor	PSAC05E-060L6 (Input: 100-240V, 200mA, 50-60Hz; Output: 5.9V, 0.85A, 5.015W)
Interfaces	USB, PSTN

1.2 Description of Tested Device

The EUT is a DECT Base Station and is a responding device as described in ANSI C63.17 and is designed to operate together with a DECT Handset, which is the initiating device.

All tests were performed on a SCDB9 base station.

All variants have the same main PCB and DECT part. The difference between the models is different design of the housing. All models are available with different interface cards.

1.3 Test Conditions

Temperature:	20 – 23 °C
Relative humidity:	30 – 50 %
Normal test voltage:	120 V 60 Hz

The values are the limit registered during the test period.

1.4 Test Engineer(s)

Frode Sveinsen

1.5 Digital Modulation Techniques

The EUT uses Multi Carrier / Time Division Multiple Access / Time Division Duplex and Digital GFSK modulation. For further details see the operational description provided by the applicant.

Requirement, FCC 15.319(b), RSS-213 Issue 3, clause 5.1:

All transmissions must use only digital modulation techniques.

1.6 Labeling Requirements

See separate documents showing the label design and the placement of the label on the EUT.

Requirements FCC 15.19

The FCC Identifier shall be displayed on the label, and the device(s) shall bear the following statement in a conspicuous location on the device or in the user manual if the device is too small:

This device complies with Part 15 of the FCC Rules. Operation is subject to the following two conditions: (1) this device may not cause harmful interference, and (2) this device must accept any interference received, including interference that may cause undesired operation.

The label itself shall be of a permanent type, not a paper label, and shall last the lifetime of the equipment.

1.7 Antenna Requirement

Does the EUT have detachable antenna(s)?	<input type="checkbox"/> YES	<input checked="" type="checkbox"/> NO
If detachable, is the antenna connector(s) non-standard?	<input type="checkbox"/> YES	<input type="checkbox"/> NO
The tested equipment has only integral antennas. The conducted tests were performed on a sample with a temporary antenna connector.		

Requirement: FCC 15.203, 15.204, 15.317, RSS-GEN Issue 5, clause 6.8

1.8 Channel Frequencies

UPCS CHANNEL	FREQUENCY (MHz)
Upper Band Edge	1930.000
0 (Highest)	1928.448
1	1926.720
2	1924.992
3	1923.264
4 (Lowest)	1921.536
Lower Band Edge	1920.000

Requirement: FCC 15.303, RSS-213 Issue 3, clause 5.1:

Within 1920 -1930 MHz band for isochronous devices.

1.9 Other Comments

The Monitoring and Time and Spectrum Window Access tests were performed with Test Set-Up 6 (Ref. clause 5). A clock signal from the Base Station was used to synchronize the Pulse Pattern Generator and the Spectrum Analyzer to the start of the DECT time window. The EUT was limited by administrative commands to operate on only two frequency carriers. For the tests where the EUT was required to operate on only one frequency carrier, one carrier was blocked by applying a CW interfering signal from RF Generator 3. The Pulse Pattern Generator was used to apply time synchronized interference to time windows where this was required.

Since the EUT was programmed to operate on only two RF carriers, it was only necessary with two RF generators for the monitoring tests, however a third generator was applied for the tests that required specific time slots to be blocked.

The tested EUT supports both normal DECT slot length and DECT Long slot. Long slot is an extended DECT slot that allows a higher data rate for bit rates higher than 32kbps.

This EUT supports Least Interfered Channel procedure (LIC), the Monitoring and Time and Spectrum Window Access tests were conducted as specified for EUTs that support LIC procedure.

All tests except Power-Line Conducted Emissions were performed in conducted mode with a temporary antenna connector.

2 TEST REPORT SUMMARY

2.1 General

All measurements are traceable to national standards.

The tests were conducted on a sample of the equipment for the purpose of demonstrating compliance with FCC CFR47 Part 15D for Isochronous UPCS Devices.

All tests were conducted in accordance with ANSI C63.4-2014 and ANSI C63.17-2013.

A description of the test facility is on file with FCC.

- | | |
|---|---|
| <input checked="" type="checkbox"/> New Submission | <input checked="" type="checkbox"/> Production Unit |
| <input type="checkbox"/> Class II Permissive Change | <input type="checkbox"/> Pre-production Unit |
| PUB Equipment Code | <input type="checkbox"/> Family Listing |



THIS TEST REPORT APPLIES ONLY TO THE ITEM(S) AND CONFIGURATIONS TESTED.

Deviations from, additions to, or exclusions from the test specifications are described in "Summary of Test Data".

Nemko Group authorizes the above named entity to reproduce this report provided it is reproduced in its entirety and for use by the entity's employees only. Any reproduction of parts of this report requires approval in writing from Nemko Group.

Any use that a third party makes of this report, or any reliance on or decisions to be made based on it, are the responsibility of such third parties. Nemko Group accepts no responsibility for damages suffered by any third party caused by decisions made or actions based on this report.

2.2 Test Summary

Name of test	FCC CFR 47 Paragraph #	Verdict
Power Line Conducted Emission	15.107(a) 15.207(a)	Complies
Digital Modulation Techniques	15.319(b)	Complies
Labeling requirements	15.19(a)(3)	Complies
Antenna Requirement	15.317, 15.203	Complies
Channel Frequencies	15.303	Complies
Automatic discontinuation of transmission	15.319(f)	Complies
Emission Bandwidth	15.323(a)	Complies
Occupied Bandwidth	N/A	Complies
In-band emissions	15.323(d)	Complies
Out-of-band emissions	15.323(d)	Complies
Peak Transmit Power and Antenna Gain	15.319(c)(e), 15.31(e)	Complies
Power Spectral Density	15.319(d)	Complies
Carrier frequency stability	15.323(f)	Complies
Frame repetition stability	15.323(e)	Complies
Frame period and jitter	15.323(e)	Complies
Monitoring threshold, Least interfered channel	15.323(c)(2)(5)(9)	Complies
Monitoring of intended transmit window and maximum reaction time	15.323(c)(1)	Complies
Threshold monitoring bandwidth	15.323(c)(7)	Complies
Reaction time and monitoring interval	15.323(c)(1)(5)(7)	Complies
Access criteria test interval	15.323(c)(4)(6)	Complies
Access Criteria functional test	15.323(c)(4)(6)	Complies
Acknowledgements	15.323(c)(4)	Complies
Transmission duration	15.323(c)(3)	N/A ¹
Dual access criteria	15.323(c)(10)	N/A ¹
Alternative monitoring interval	15.323(c)(11)(12)	N/A ²
Spurious Emissions (Radiated)	15.319(g) 15.109(a) 15.209(a)	N/A ³

¹ Only applies for EUT that can be initiating device

² The client declares that the tested equipment does not implement this provision

³ Not required if the Conducted Out-of-Band Emissions test is Passed

3 TEST RESULTS

3.1 Power Line Conducted Emissions

FCC Part 15.207

ISED RSS-213 Issue 3, Clause 6.3

RSS-GEN Issue 5, Clause 7.2 / 8.8

Measurement procedure: ANSI C63.4-2014 using 50 μ H/50 ohms LISN

Test Results: Complies

Measurement Data: See attached plots

Highest measured value (L1 and N):

On-Hook Mode, 120V 60Hz:

Frequency (MHz)	QuasiPeak (dB μ V)	Average (dB μ V)	Limit (dB μ V)	Margin (dB)	Meas. Time (ms)	Bandwidth (kHz)	Line	Filter
0.488	41.84	---	56.20	14.36	1000	9	L1	OFF
0.496	42.99	---	56.07	13.08	1000	9	L1	OFF
0.524	---	35.58	46.00	10.42	1000	9	L1	OFF

Off-Hook Mode, 120V 60Hz:

Frequency (MHz)	QuasiPeak (dB μ V)	Average (dB μ V)	Limit (dB μ V)	Margin (dB)	Meas. Time (ms)	Bandwidth (kHz)	Line	Filter
0.488	41.59	---	56.20	14.61	1000	9	L1	OFF
0.496	---	33.07	46.07	12.99	1000	9	L1	OFF
0.496	42.06	---	56.07	14.01	1000	9	L1	OFF
0.500	---	31.82	46.00	14.18	1000	9	L1	OFF

On-Hook Mode, 120V 60Hz:

Full Spectrum

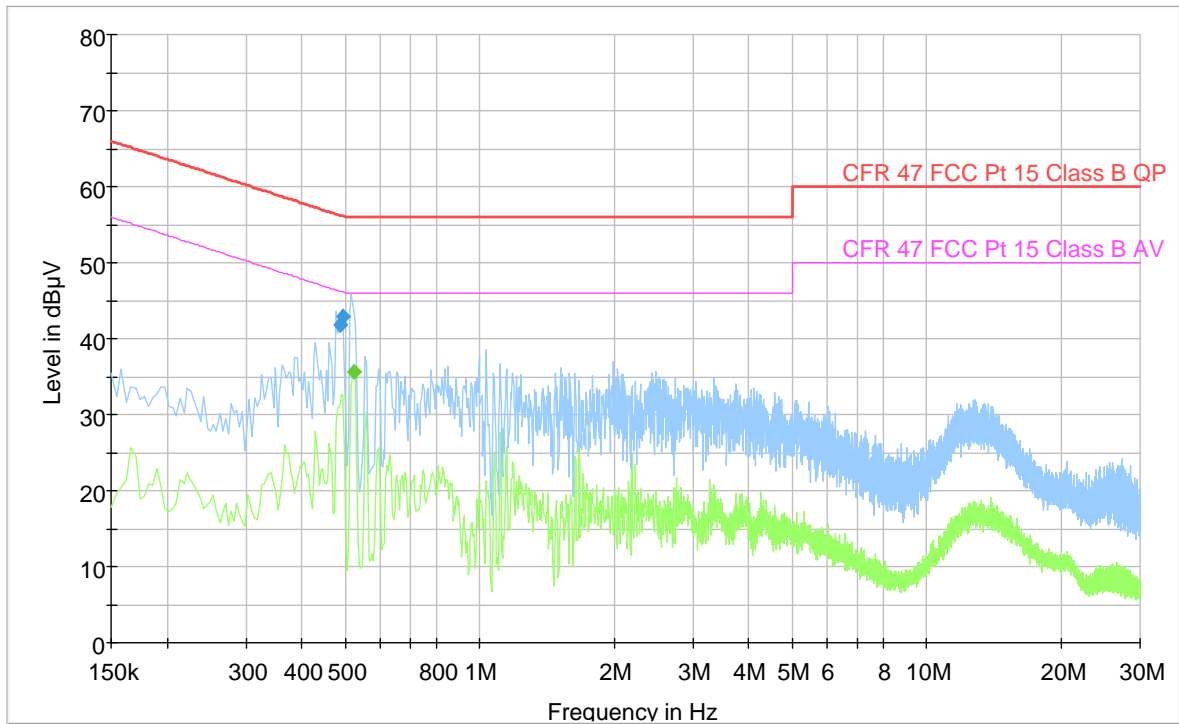

Off-Hook Mode, 120V 60Hz:

Full Spectrum

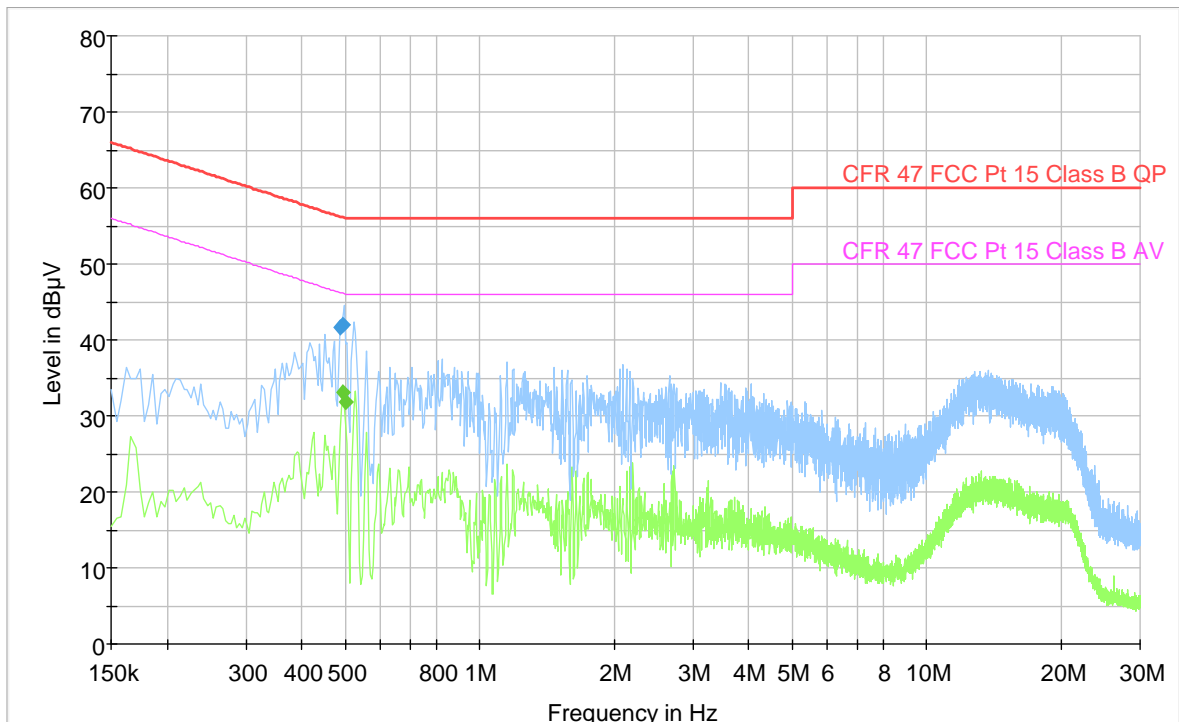

3.2 Automatic Discontinuation of Transmission

Does the EUT transmit Control and Signaling Information?	<input checked="" type="checkbox"/> YES	<input type="checkbox"/> NO
TYPE OF EUT :	<input type="checkbox"/> INITIATING DEVICE	<input checked="" type="checkbox"/> RESPONDING DEVICE

The following tests simulate the reaction of the EUT in case of either absence of information to transmit or operational failure after a connection with the companion device is established.

Number	Test	EUT Reaction	Verdict
1	Power removed from EUT	B	Pass
2	Switch Off EUT	N/A	Pass
3	Hook-On by EUT	N/A	Pass
4	Power Removed from Companion Device	B	Pass
5	Switch Off Companion Device	B	Pass
6	Hook-On by Companion Device	B	Pass

- A - Connection breakdown, Cease of all transmissions
- B - Connection breakdown, EUT transmits control and signaling information
- C - Connection breakdown, Companion Device transmits control and signaling information
- N/A - Not Applicable (EUT does not have On/Off switch and cannot perform Hook-On)

Requirements, FCC 15.319(f), RSS-213 Issue 3, Clause 5.2:

The device shall automatically discontinue transmission in case of either absence of information to transmit or operational failure. These provisions are not intended to preclude transmission of control and signaling information or use of repetitive codes used by certain digital technologies to complete frame or burst intervals.

3.3 Peak Power Output

Test Method:

ANSI C63.17, clause 6.1.2.

Test Results: Complies

Measurement Data:

Maximum Conducted Output Power

Channel No.	Frequency (MHz)	Maximum Conducted Output Power (dBm)	Maximum Antenna Gain (dBi)	Maximum Radiated Output Power (dBm)
4	1921.536	19.5	2.0*	21.5
2	1924.992	19.4	2.0*	21.4
0	1928.448	19.4	2.0*	21.4

*Antenna Gain is value declared by manufacturer

For this test it was also checked that input voltage variation of 85 and 115% of nominal value did not have any effect on the measured output power.

Limit:

Conducted: $100 \mu\text{W} \times \text{SQRT}(B)$ where B is the measured Emission Bandwidth in Hz

FCC 15.319(c)(e): 20.76 dBm (119 mW)

ISED RSS-213, Issue 3: 20.45 dBm (111 mW)

The antenna gain is below 3 dBi, no reduction in transmit power is necessary.

Requirements,

FCC 15.319(c)(e):

Peak transmit power shall not exceed 100 microwatts multiplied by the square root of the emission bandwidth in Hertz.

RSS-213 Issue 3, clause 5.6:

Peak transmit power shall not exceed 100 microwatts multiplied by the square root of the occupied bandwidth in Hertz.

FCC 15.319(c)(e); RSS-213 Issue 3, clause 5.6:

The peak transmit power shall be reduced by the amount in decibels that the maximum directional gain of the antenna exceeds 3 dBi.

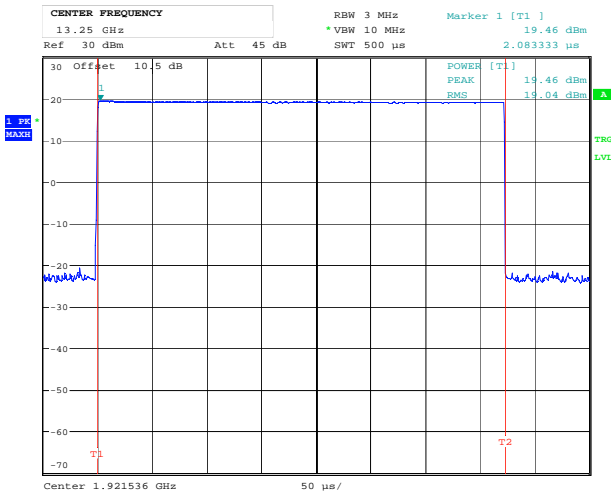

Date: 13.NOV.2020 12:50:34

Centered Peak Output Power, Lower Channel

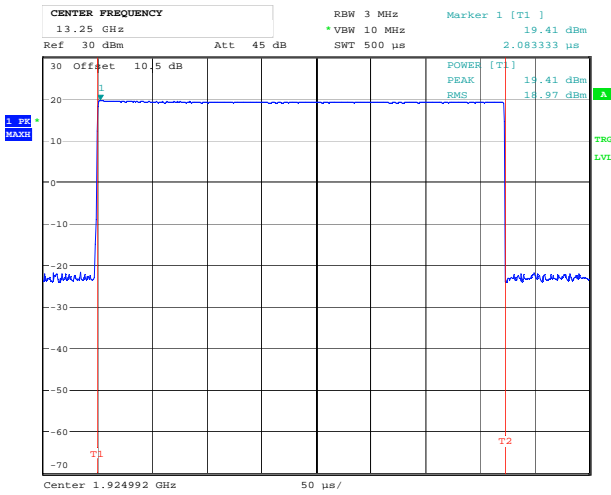

Date: 13.NOV.2020 12:48:42

Conducted Peak Output Power, Middle Channel

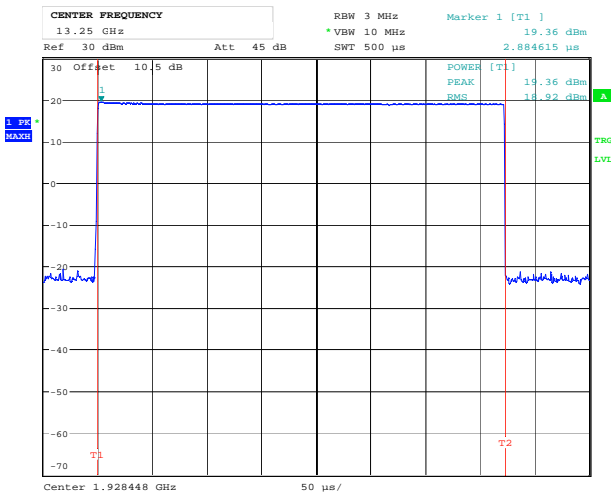

Date: 13.NOV.2020 12:49:38

Conducted Peak Output Power, Upper Channel

3.4 Emission Bandwidth *B*

Test Method:

ANSI C63.17, clause 6.1.3.

Test Results: Complies

Measurement Data:

Channel No.	Frequency (MHz)	Emission Bandwidth <i>B</i> (MHz)
4	1921.536	1.42
0	1928.448	1.45

Channel No.	Frequency (MHz)	Occupied Bandwidth (MHz)
2	1924.992	1.23

Requirements, FCC 15.323(a), RSS-213 Issue 3, clause 5.5:

The Emission Bandwidth *B* shall be larger than 50 kHz and less than 2.5 MHz.

No requirements for 6 and 12 dB Bandwidth, these values are only used for testing Monitoring Bandwidth if the Simple Compliance test fails (ANSI C63.17, clause 7.4).

RSS-GEN Issue 5, clause 6.7:

Occupied Bandwidth (99%) is measured according to RSS-GEN Issue 5, clause 6.7. No requirement specified.

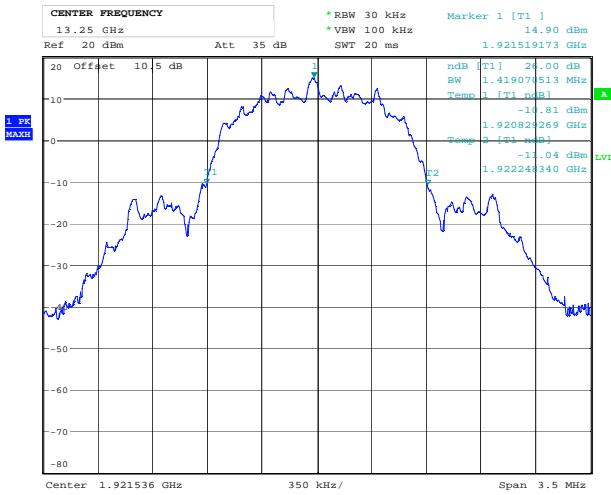

Date: 13.NOV.2020 12:52:13

Emission Bandwidth B, Lower Channel

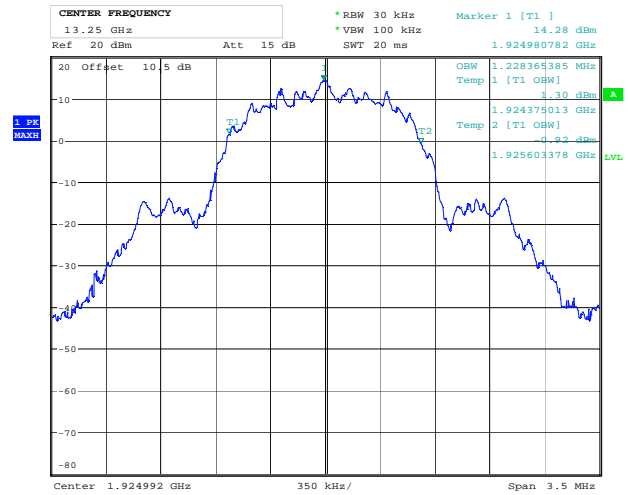

Date: 13.NOV.2020 13:23:42

99% Bandwidth, Middle Channel

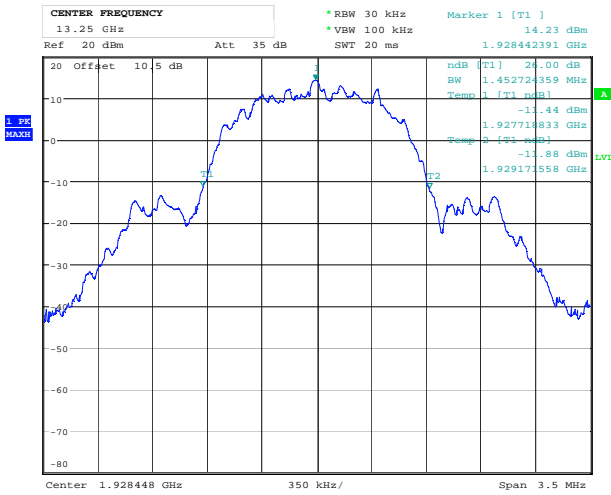

Date: 13.NOV.2020 13:05:52

Emission Bandwidth B, Upper Channel

3.5 Power Spectral Density

Test Method:

ANSI C63.17, clause 6.1.5.

Test Results: Complies

Measurement Data:

Channel No.	Frequency (MHz)	Power Spectral Density (dBm)
4	1921.536	-1.5
0	1928.448	-1.8

Averaged over 500 sweeps.

Requirements, FCC 15.319(d), RSS-213 Issue 3, clause 5.7

The Power Spectral Density shall be less than 3 mW (4.77 dBm) when averaged over at least 100 sweeps.

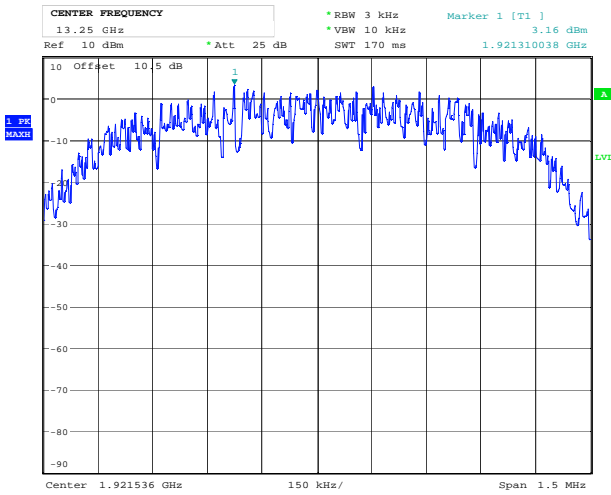

Date: 13.NOV.2020 12:55:10

PSD Overview, Lower Channel

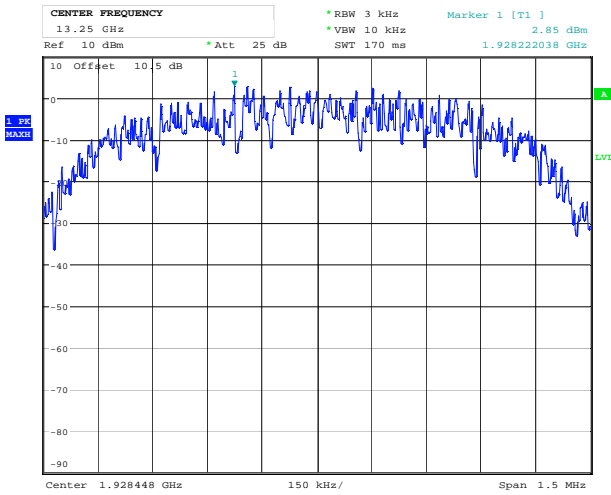

Date: 13.NOV.2020 13:06:38

PSD Overview, Upper Channel

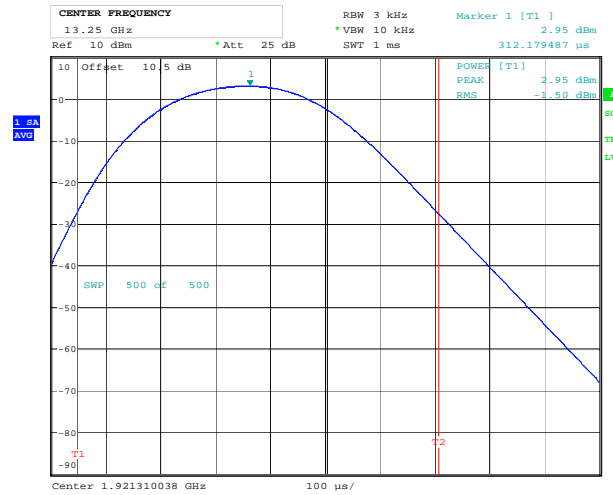

Date: 13.NOV.2020 12:55:52

PSD Averaged, Lower Channel

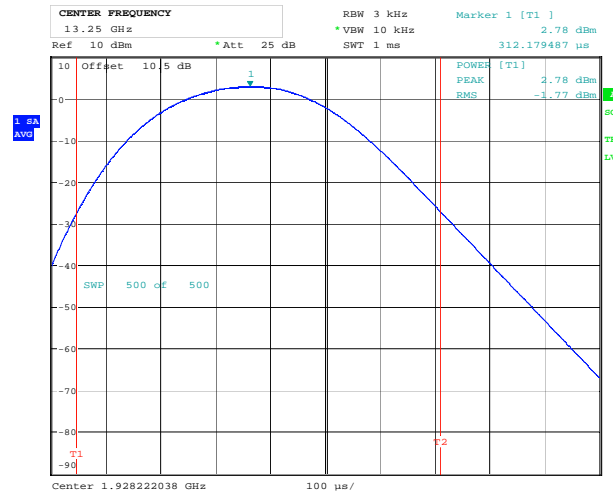

Date: 13.NOV.2020 13:07:20

PSD Averaged, Upper Channel

3.6 In-Band Unwanted Emissions, Conducted

Test Method:

ANSI C63.17, clause 6.1.6.1.

Test Results: Complies

Measurement Data:

See plots.

Requirements, FCC 15.323(d), RSS-213 Issue 3, clause 5.8.2:

$B < f \leq 2B$: at least 30 dB below max. permitted peak power

$2B < f \leq 3B$: at least 50 dB below max. permitted peak power

$3B < f \leq$ UPCS Band Edge : at least 60 dB below max. permitted peak power

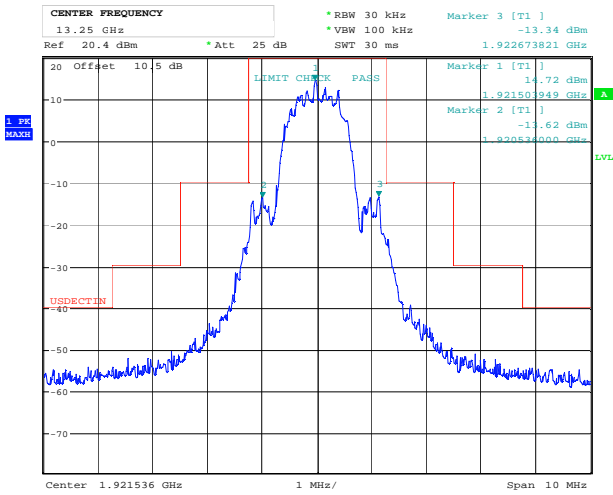

Date: 13.NOV.2020 12:53:25

In-Band Unwanted Emissions, Lower Channel

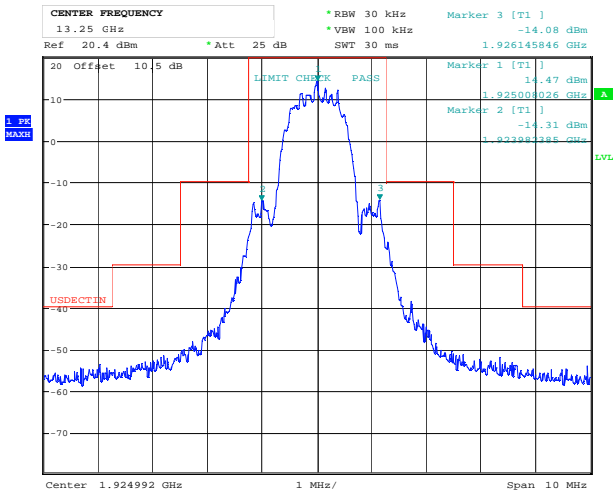

Date: 13.NOV.2020 13:02:24

In-Band Unwanted Emissions, Middle Channel

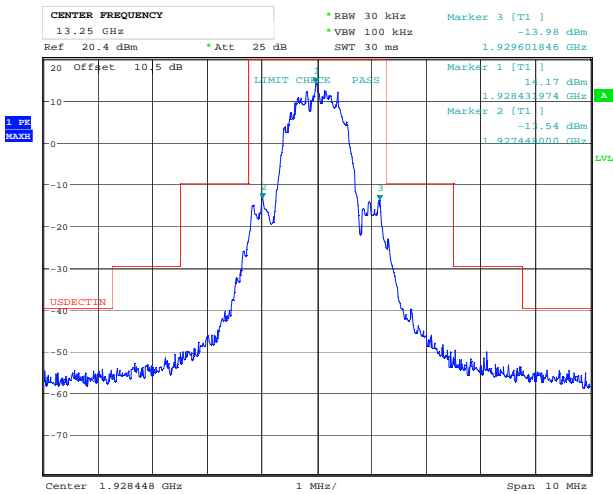

Date: 13.NOV.2020 13:03:55

In-Band Unwanted Emissions, Upper Channel

3.7 Out-of-band Emissions, Conducted

Test Method:

ANSI C63.17, clause 6.1.6.2.

Test Results: Complies

Requirements, FCC 15.323(d), RSS-213 Issue 3, clause 5.8.1:

$f \leq 1.25\text{MHz}$ outside UPCS band :	$\leq -9.5\text{dBm}$
$1.25\text{MHz} \leq f \leq 2.5\text{MHz}$ outside UPCS band :	$\leq -29.5 \text{ dBm}$
$f \geq 2.5\text{MHz}$ outside UPCS band :	$\leq -39.5 \text{ dBm}$

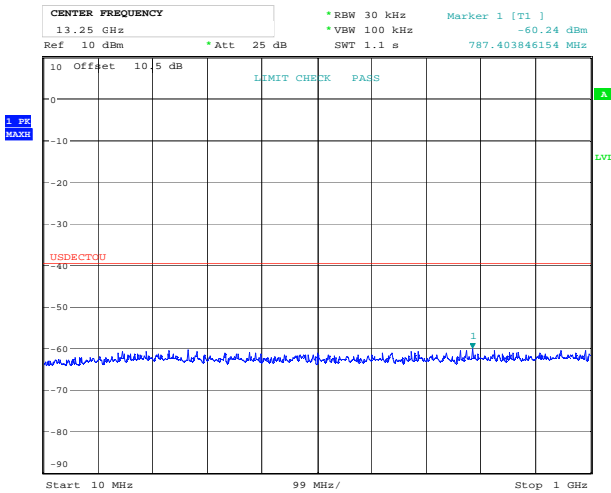

Date: 13.NOV.2020 13:26:48

Out-of-Band Emissions, Lower Channel

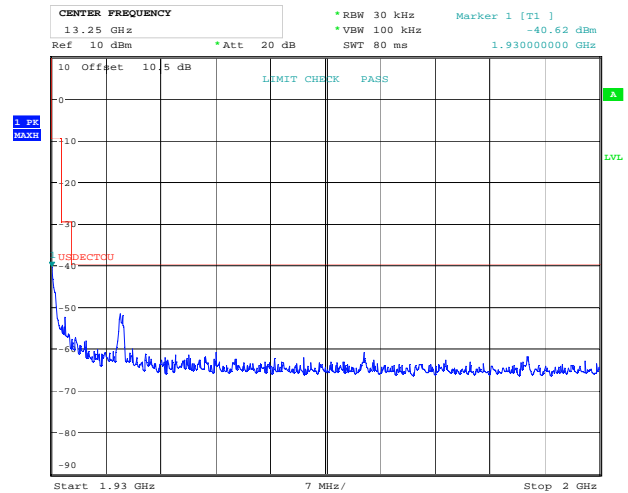

Date: 13.NOV.2020 14:22:35

Out-of-Band Emissions, Upper Channel

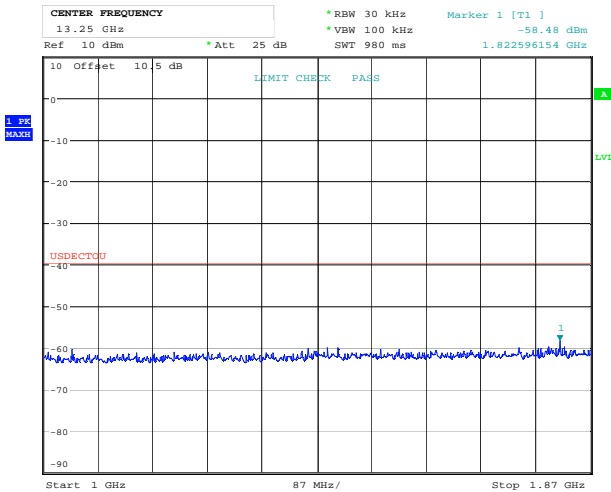

Date: 13.NOV.2020 13:27:35

Out-of-Band Emissions, Lower Channel

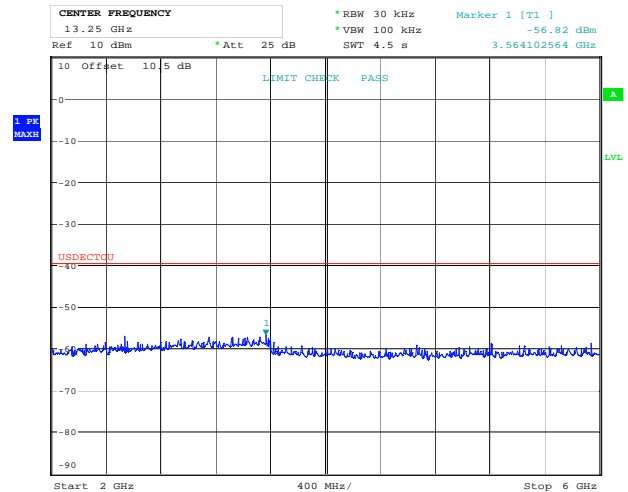

Date: 13.NOV.2020 13:46:51

Out-of-Band Emissions, Middle Channel

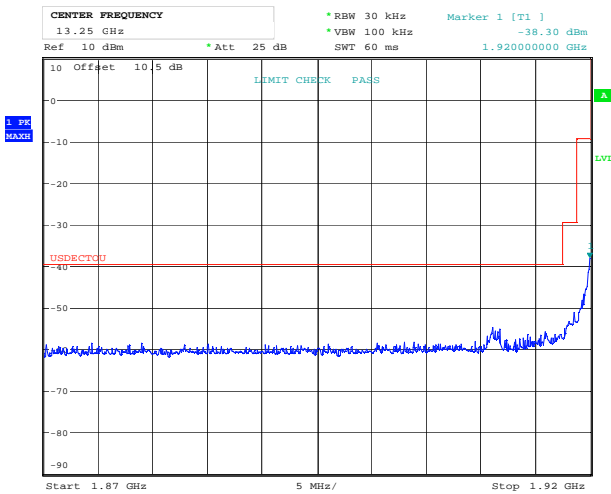

Date: 13.NOV.2020 13:31:51

Out-of-Band Emissions, Lower Channel

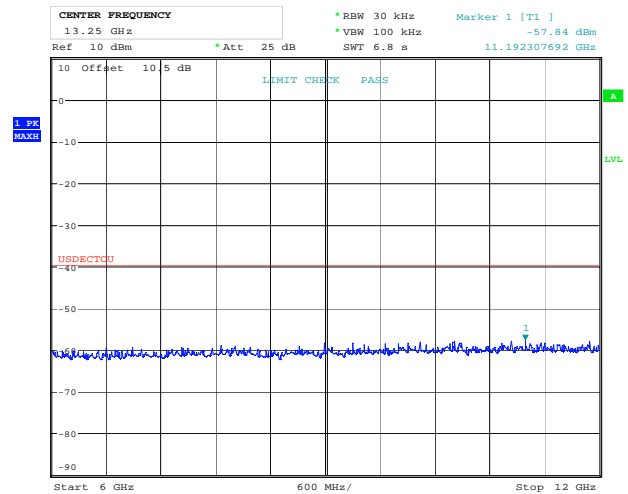

Date: 13.NOV.2020 13:49:05

Out-of-Band Emissions, Middle Channel

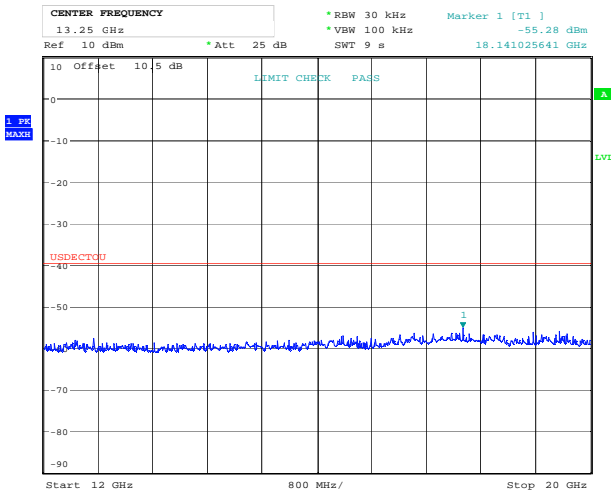

Date: 13.NOV.2020 13:50:02

Out-of-Band Emissions, Middle Channel

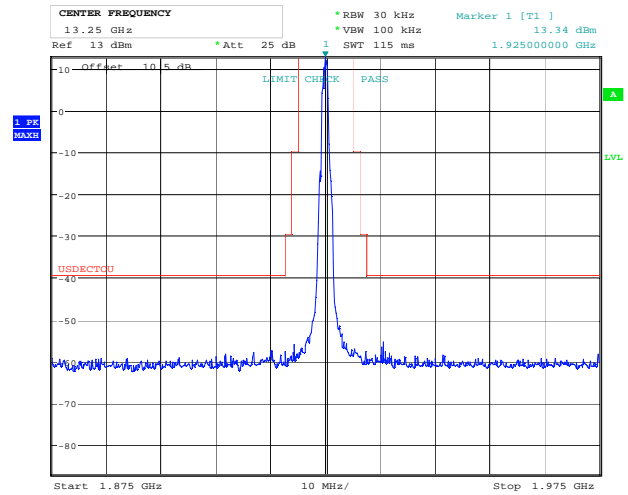

Date: 13.NOV.2020 13:48:08

Out-of-Band Emissions, Middle Channel

3.8 Carrier Frequency Stability

Test Method:

ANSI C63.17, clause 6.2.1.

Test Results: Complies

Measurement Data:

Long Term Frequency Stability is measured with the HP53310A Modulation Domain analyzer. The HP53310A is logged by a computer programmed to get new readings as fast as possible over the noted time period or number of readings. The peak-to-peak difference was recorded and the mean value and deviation in ppm was calculated.

The Carrier Frequency Stability over Power Supply Voltage and over Temperature is measured with a Frequency Domain Analyzer in histogram mode.

Carrier Frequency Stability over Time at Nominal Temperature

Average Mean Carrier Frequency (MHz)	Max. Diff. (kHz)	Min. Diff. (kHz)	Max. Dev. (ppm)	Limit
1924.982865	-6.665	-12.465	-1.7	±10 ppm

Deviation ppm = ((Diff. - Mean Diff) / Mean Carrier Freq.) x 10⁶

Deviation (ppm) is calculated from 3000 readings.

Frequency Stability over Power Supply Voltage at Nominal Temperature

Voltage	Measured Carrier Frequency (MHz)	Difference (kHz)	Deviation (ppm)	Limit
V _{nom}	1924.9832	0	0	±10 ppm
85% of V _{nom}	1924.9810	-2.2	-1.1	
115% of V _{nom}	1924.9832	0.0	0.0	

Deviation ppm = ((Mean – Measured Frequency) / Mean) x 10⁶

Frequency Stability over Temperature

Temperature	Measured Carrier Frequency (MHz)	Difference (kHz)	Deviation (ppm)	Limit
T = +20 °C	1924.9832	0	0	±10 ppm
T = -20 °C	1924.9831	-0.1	-0.1	
T = +50 °C	1924.9832	0.0	0.0	

Deviation ppm = ((Mean – Measured Frequency) / Mean) x 10⁶

Ref. FCC 15.323(e), RSS-213 Issue 3, clause 5.3

3.9 Frame Repetition Stability

Test Method:

ANSI C63.17, clause 6.2.2.

Test Results: Complies

Measurement Data:

The envelope of the RF signal from the EUT is detected with a Crystal Detector and the mean and standard deviation of the frame repetition frequency is then gated over 100 frames and measured with a Frequency Domain Analyzer. The frame repetition stability is 3 times the standard deviation.

Carrier Frequency (MHz)	Mean (Hz)	Standard Deviation (µHz)	Standard Deviation (ppm)	Frame Repetition Stability (ppm)
1924.992	100.000	0.8455	0.008	0.025

Limit:

Frame Repetition Stability	±10 ppm (TDMA)
----------------------------	----------------

Ref. FCC 15.323(e), RSS-213 Issue 3, clause 5.2

3.10 Frame Period and Jitter

Test Method:

ANSI C63.17, clause 6.2.3.

Test Results: Complies

Measurement Data:

The envelope of the RF signal from the EUT is detected with a Crystal Detector and the frame period and jitter is measured with a Frequency Domain Analyzer over at least 100.000 frames.

Carrier Frequency (MHz)	Frame Period (ms)	Pk-Pk Jitter (µHz)	St.Dev. Jitter (µHz)	Max Jitter (µs)	3x St.Dev. Jitter (µs)
1924.992	10.000	579.1	82.3	-0.029	-0.025

Max Jitter = (1/ (Frame period + Pk-Pk/2)) - (1/Frame Period), when Pk-Pk and Frame Period are in Hz

3x St.Dev. Jitter = 3x (1/(Frame Period + St.Dev) – 1/St.Dev) x 10⁶

Limit:

Frame Period	20 or 10 ms
Max Jitter	25 µs
3 times St.Dev of Jitter	12.5 µs

Ref. FCC 15.323(e), RSS-213 Issue 3, clause 5.2

(hp) Freq A t1k
 acquiring data

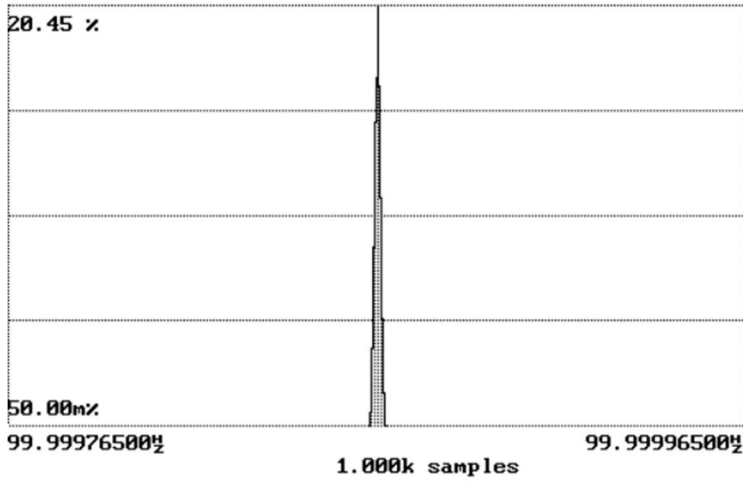

Mean 99.9998650866µs 1/Mean 10.000ms
 Pk-Pk 4.90µs Std Dev 845.5ns

Frame Repetition Stability, Gated over 100 Frames

(hp) Freq A ren t1k
 acquiring data

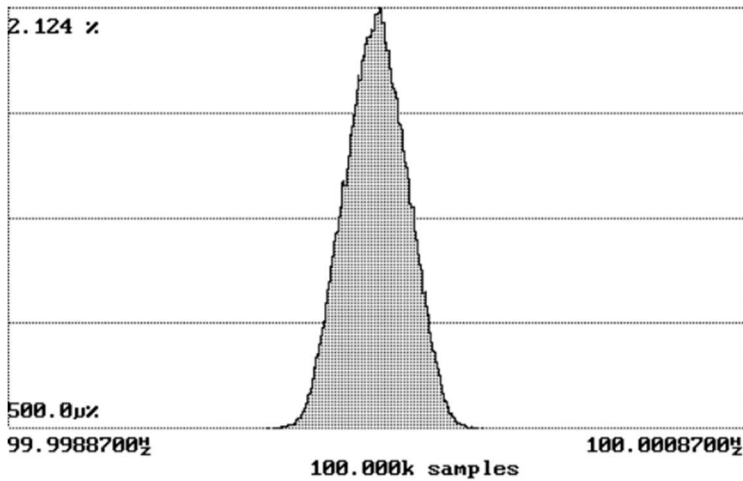

Mean 99.9998674047µs 1/Mean 10.000ms
 Pk-Pk 579.1µs Std Dev 82.3054µs

Frame Period and Jitter

3.11 Monitoring Threshold, Least Interfered Channel

Monitoring Threshold Limits:

Threshold Level:

$$T_L = -174 + 10 \log B + 30 + P_{MAX} - P_{EUT} \text{ (dBm)}$$

B is measured Emission Bandwidth (FCC 15.323) or Occupied Bandwidth (RSS-213 Issue 3) in Hz

P_{MAX} is the power limit in dBm

P_{EUT} is measured Transmitter Power in dBm

Calculated values:

	FCC 15.323, RSS-213 Issue 3, clause 5.2
Threshold Level (FCC 15.323)	-81.2 dBm
Threshold Level (RSS-213 Issue 3)	-82.2 dBm

Least Interfered Channel Procedure (LIC) may only be used by systems with more than 20 duplex system access channels. Systems with less than 20 duplex system access channels are not allowed to transmit when interferer level is above Threshold Level.

Measurement Procedure:

Test only when Least Interfered Channel Procedure is NOT used:	
Lower Threshold	N/A The EUT uses LIC procedure

Least Interfered Channel (LIC) Procedure Test, FCC 15.323(b), (c)(2) and (c)(5)

ANSI C63.17 clause 7.3.2 ref.	Observation	Verdict
b) <i>f</i> ₁ at <i>T</i> _L + <i>U</i> _M + 7 dB, <i>f</i> ₂ at <i>T</i> _L + <i>U</i> _M	Transmission always on <i>f</i> ₂	Pass
c) <i>f</i> ₁ at <i>T</i> _L + <i>U</i> _M , <i>f</i> ₂ at <i>T</i> _L + <i>U</i> _M + 7 dB	Transmission always on <i>f</i> ₁	Pass
d) <i>f</i> ₁ at <i>T</i> _L + <i>U</i> _M + 1 dB, <i>f</i> ₂ at <i>T</i> _L + <i>U</i> _M - 6 dB	Transmission always on <i>f</i> ₂	Pass
e) <i>f</i> ₁ at <i>T</i> _L + <i>U</i> _M - 6 dB, <i>f</i> ₂ at <i>T</i> _L + <i>U</i> _M + 1 dB	Transmission always on <i>f</i> ₁	Pass

Selected Channel Confirmation, FCC 15.323(c)(1) and (5)

ANSI C63.17 clause 7.3.3	Observation	Verdict
b) Shall not transmit on f_2	EUT transmits on f_2	Pass
d) Shall not transmit on f_2	EUT transmits on f_1	Pass

Limits:

	FCC 15.323, RSS-213 Issue 3, clause 5.2
Threshold Level + 6 dB margin (FCC 15.323)	-75.2 dBm
Threshold Level + 6 dB margin (RSS-213 Issue 3)	-76.2 dBm

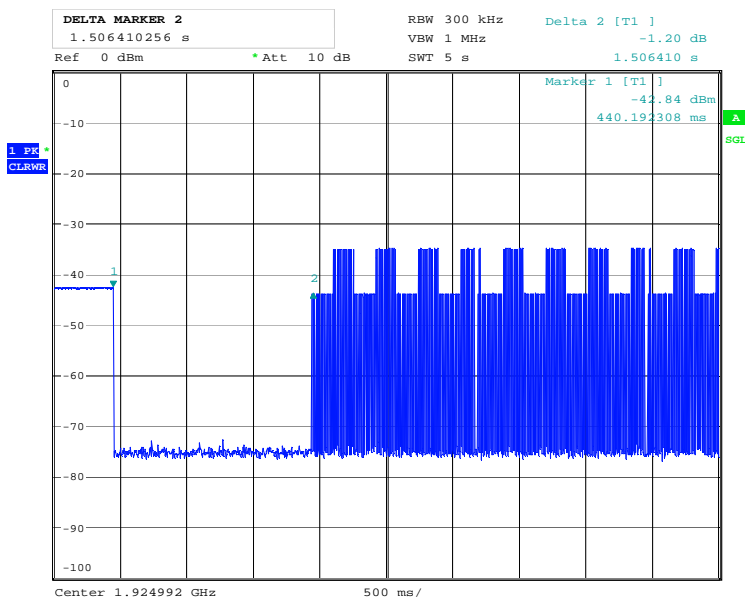

Date: 3.DEC.2020 14:03:29

7.3.4 Selected Channel Confirmation, Connection 1.5s after interferer removed

3.12 Threshold Monitoring Bandwidth

This test is only required if a dedicated monitoring receiver is used. However, if the test is not carried out the manufacturer shall declare and provide proper evidence that the monitoring is made through the radio receiver used for communication.

Measurement Procedure:

Simple Compliance Test, ANSI C63.17, clause 7.4.1

More Detailed Test, ANSI C63.17, clause 7.4.2

The test is passed if **either** the Simple Compliance Test or the More Detailed test is passed.

During this test the spectrum analyzer is observed visually to see if the EUT transmits or not.

Test Results:

Test performed	Observation	Verdict
Simple Compliance test, at $\pm 30\%$ of <i>B</i>	N/A	N/A
More Detailed Test, at -6 dB points	N/A	N/A
More Detailed Test, at -12 dB points	N/A	N/A

The more detailed test must be pass at both the -6 and -12 dB points if the Simple Compliance test fails.

Comment: The manufacturer declares that the tested EUT uses the same receiver for monitoring and communication, this test is therefore not required.

Limits, FCC 15.323(c)(7), RSS-213 Issue 3, clause 5.2:

The monitoring system bandwidth must be equal to or greater than the emission bandwidth of the intended transmission.

3.13 Reaction Time and Monitoring Interval

Measurement Procedure

ANSI C63.17, clause 7.5

Test results:

By administrative commands and out-of-operating region interference, the EUT is restricted to operate on two RF carrier frequencies.

A CW interferer signal at a level T_L is applied on f_1 and time-synchronized pulsed interference at a level $T_L + U_M$ dB is applied on f_2 . The level on f_2 was raised 6 dB for part d) with 35 μ s pulses.

The pulses are synchronized with the EUT timeslots and applied centered within all timeslots.

For both tests the test is passed if the EUT transmits on f_1 .

Pulse Width, ref. to ANSI C63.17 clause 7.5	Observation	Verdict
c) > largest of 50 μ s and $50 \cdot \text{SQRT}(1.25/B)$	EUT transmits on f_1	Pass
d) > largest of 35 μ s and $35 \cdot \text{SQRT}(1.25/B)$, and with interference level raised 6 dB	EUT transmits on f_1	Pass

Comment: The test was performed with pulse lengths of 50 μ s and 35 μ s.

Limits, FCC 15.323(c)(1), (5) and (7), RSS-213 Issue 3, clause 5.2:

The maximum reaction time must be less than $50 \cdot \text{SQRT}(1.25/\text{emission bandwidth in MHz})$ microseconds for signals at the applicable threshold level but shall not be required to be less than 50 μ s.

If a signal is detected that is 6 dB or more above the applicable threshold level, the maximum reaction time shall be $35 \cdot \text{SQRT}(1.25/\text{emission bandwidth in MHz})$ microseconds but shall not be required to be less than 35 μ s.

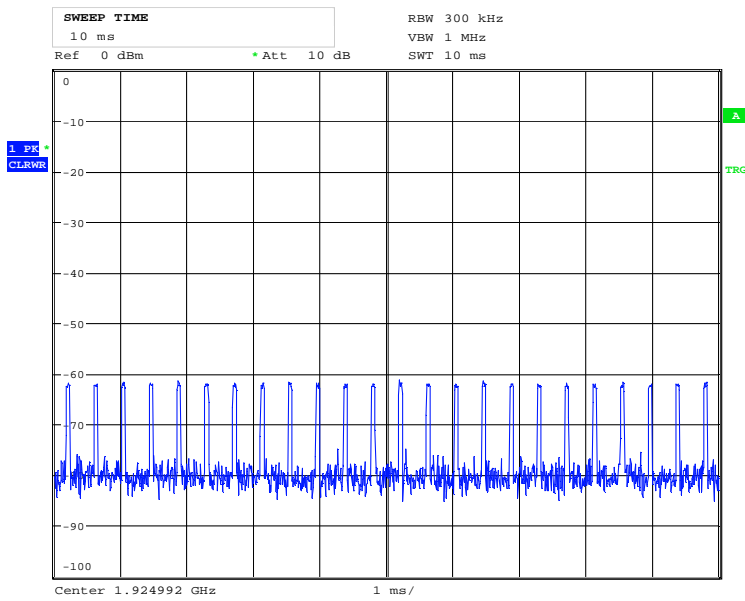

Date: 3.DEC.2020 14:09:20

50 μ s Pulses

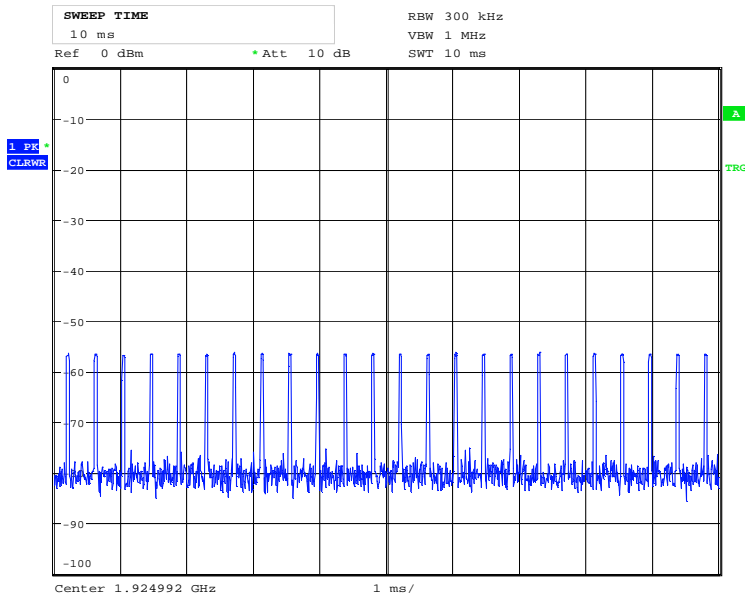

Date: 3.DEC.2020 14:10:55

35 μ s Pulses

3.14 Time and Spectrum Window Access Procedure

This requirement is only for EUTs which transmit unacknowledged control and signaling information.

Measurement Procedure:

Timing for EUTs using control and signaling channel type transmissions: ANSI C63.17, clause 8.1

Test results:

Access Criteria, ref. to ANSI C63.17 clause 8.1.1	Observation	Verdict
b) Check that the EUT transmits on the interference free time-slot	EUT transmits on interference-free slot	Pass
b) The EUT must terminate or pause in its repetitive transmission of the control and signalling channel on the open channel to repeat the access criteria not less frequently than every 30 s	1.28 seconds	Pass

If FCC 15.323(c)(6) option, **If Random Waiting Interval is NOT implemented**

Access Criteria, ref. to ANSI C63.17 clause 8.1.2	Observation	Verdict
b) Check that the EUT changes to an interference-free slot when interference is introduced on the time slot in use	EUT changes to interference-free slot	Pass

If FCC 15.323(c)(6) option, **Only if Random Waiting Interval is implemented**

Access Criteria, ref. to ANSI C63.17 clause 8.1.3	Observation	Verdict
b-d) Check that the EUT uses random waiting interval before continuing transmission on an interfered time slot	N/A	N/A

Comment: The EUT does not use the random waiting interval option.

Limits:

FCC 15.323(c)(4), RSS-213 Issue 3, clause 5.2, RSS-213 Issue 3, clause 5.2:

Once access to specific combined time and spectrum windows is obtained an acknowledgement from a system participant must be received by the initiating transmitter within one second or transmission must cease. Periodic acknowledgements must be received at least every 30 seconds or transmission must cease. Channels used exclusively for control and signaling information may transmit continuously for 30 seconds without receiving an acknowledgement, at which time the access criteria must be repeated.

FCC 15.323(c)(6), RSS-213 Issue 3, clause 5.2, RSS-213 Issue 3, clause 5.2:

If the selected combined time and spectrum windows are unavailable, the device may either monitor and select different windows or seek to use the same windows after waiting an amount of time, randomly chosen from a uniform random distribution between 10 and 150 milliseconds, commencing when the channel becomes available

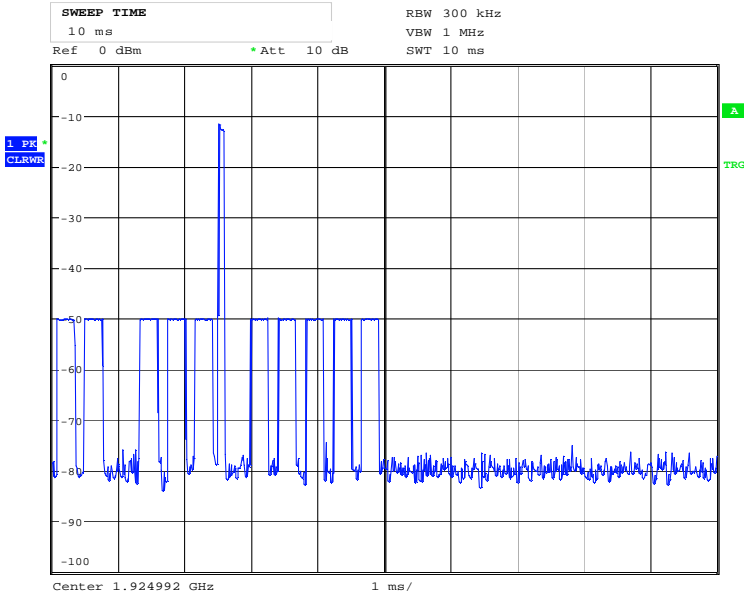

Date: 30.APR.2021 13:10:54

Access Criteria, Before

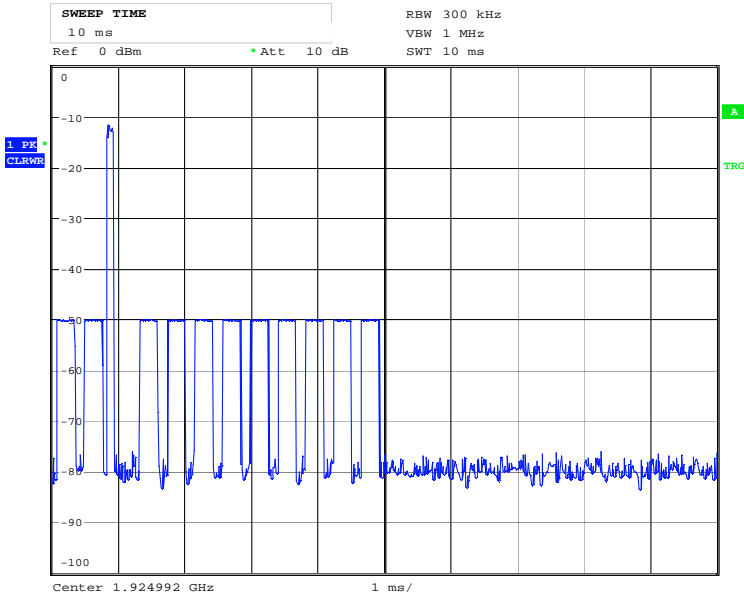

Date: 30.APR.2021 13:11:32

Access Criteria, After

3.15 Acknowledgements and Transmission Duration

Measurement Procedure:

Acknowledgements: ANSI C63.17, clause 8.2.1

Transmission Duration: ANSI C63.17, clause 8.2.2

During the test **Initial transmission without acknowledgements** the signal from the EUT to the companion device is blocked by circulators in addition to the tunable attenuator.

The test **Transmission time after loss of acknowledgements** is performed by cutting-off the signal from the companion device by a RF switch and measuring the time until the EUT stops transmitting.

The **Transmission Duration** test is performed by monitoring the slot in use and measuring the time until the EUT changes to a different slot.

Test Results:

Acknowledgements

Test ref. to ANSI C63.17 clause 8.2.1	Observation	Verdict
a) Initial transmission without acknowledgements	Not applicable for EUT that transmits control and signaling information	N/A
c) Transmission time after loss of acknowledgements	5 sec	Pass

Transmission Duration

Test ref. to ANSI C63.17 clause 8.2.2	Observation	Verdict
b) Transmission duration on same time and frequency window	Only for initiating device that controls which time slot is used	N/A

Comment: /

Limits, FCC 15.323(c)(3) and (4), RSS-213 Issue 3, clause 5.2:

Occupation of the same combined time and spectrum windows by a device or group of cooperating devices continuously over a period of time longer than 8 hours is not permitted without repeating the access criteria.

Once access to specific combined time and spectrum windows is obtained an acknowledgement from a system participant must be received by the initiating transmitter within one second or transmission must cease.

Periodic acknowledgements must be received at least every 30 seconds or transmission must cease. Channels used exclusively for control and signaling information may transmit continuously for 30 seconds without receiving an acknowledgement, at which time the access criteria must be repeated.

3.16 Dual Access Criteria Check

Measurement Procedure:

EUTs that does not implement the LIC procedure: ANSI C63.17, clause 8.3.1

EUTs that implement the LIC procedure: ANSI C63.17, clause 8.3.2

This test is required for equipment that uses the access criteria in FCC 15.323(c)(10).

Test Results:

EUTs that do NOT implements the LIC procedure:

Test ref. to ANSI C63.17 clause 8.3.1	Observation	Verdict
b) EUT is restricted to a single carrier f_i for TDMA systems. The Test is Pass if EUT can transmit	N/A	N/A
c) d) Interference at level $T_L + U_M$ on all timeslots except one receive slot where interference is at least 10 dB below T_L	N/A	N/A
e) f) Interference at level $T_L + U_M$ on all timeslots except one transmit slot where interference is at least 10 dB below T_L	N/A	N/A

EUTs that implements the LIC procedure:

Test ref. to ANSI C63.17 clause 8.3.2	Observation	Verdict
b) EUT is restricted to a single carrier f_i for TDMA systems. The Test is Pass if EUT can transmit	N/A	N/A
c) d) Transmission on interference-free receive time/spectrum window	N/A	N/A
e) f) Transmission on interference-free transmit time/spectrum window	N/A	N/A

Comment: This test is only applicable for EUT that can be initiating device.

Limits, FCC 15.323(c)(10), RSS-213 Issue 3, clause 5.2:

An initiating device may attempt to establish a duplex connection by monitoring both its intended transmit and receive time and spectrum windows. If both the intended transmit and receive time and spectrum windows meet the access criteria, then the initiating device can initiate a transmission in the intended transmit time and spectrum window. If the power detected by the responding device can be decoded as a duplex connection signal from the initiating device, then the responding device may immediately begin transmitting on the receive time and spectrum window monitored by the initiating device.

3.17 Alternative Monitoring Interval

Test procedure described in ANSI C63.17 clause 8.4.

This test is required if the EUT implements the provisions of FCC 15.323(c)(11).

Test result:

Not Tested. The tested EUT does not implement this provision. See manufacturers' declaration.

4 Measurement Uncertainty

Measurement Uncertainty Values		
Test Item		Uncertainty
Output Power		±0.5 dB
Power Spectral Density		±0.5 dB
Out of Band Emissions, Conducted (RBW < 100 kHz)	< 3.6 GHz	±0.6 dB
	> 3.6 GHz	±0.9 dB
Spurious Emissions, Radiated	< 1 GHz	±2.5 dB
	> 1 GHz	±2.2 dB
Emission Bandwidth		±4 %
Power Line Conducted Emissions		+2.9 / -4.1 dB
Spectrum Mask Measurements	Frequency	±5 %
	Amplitude	±1.0 dB
Frequency Error		±0.6 ppm
Timing and Jitter Measurements		±2.0 ns
Frame Timing Measurements		±1.4 ppm
Temperature Uncertainty		±1 °C

All uncertainty values are expanded standard uncertainty to give a confidence level of 95%, based on coverage factor k=2

5 Test Setups

5.1 Frequency Measurements



Test Set-up 1

This setup is used for measuring Carrier frequency stability at normal and extreme temperatures.

5.2 Timing Measurements

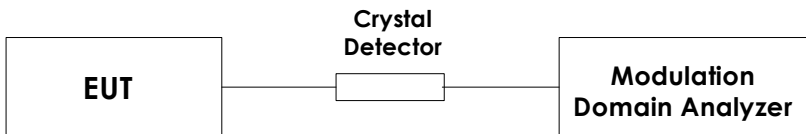

Test Set-up 2

This setup is used for measuring Frame repetition stability, Frame period and Jitter.

5.3 Conducted Emission Test

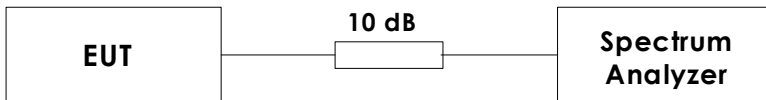

Test Set-up 3

This setup is used for all conducted emission tests.

5.4 Power Line Conducted Emissions Test

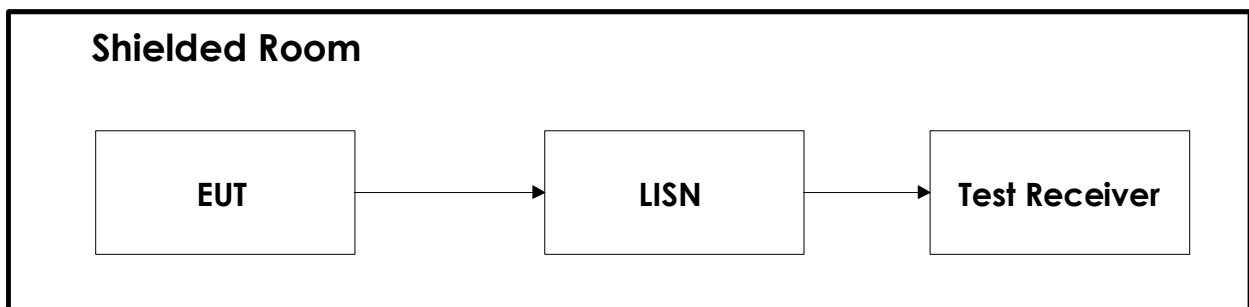

Test Set-Up 5

5.5 Monitoring Tests

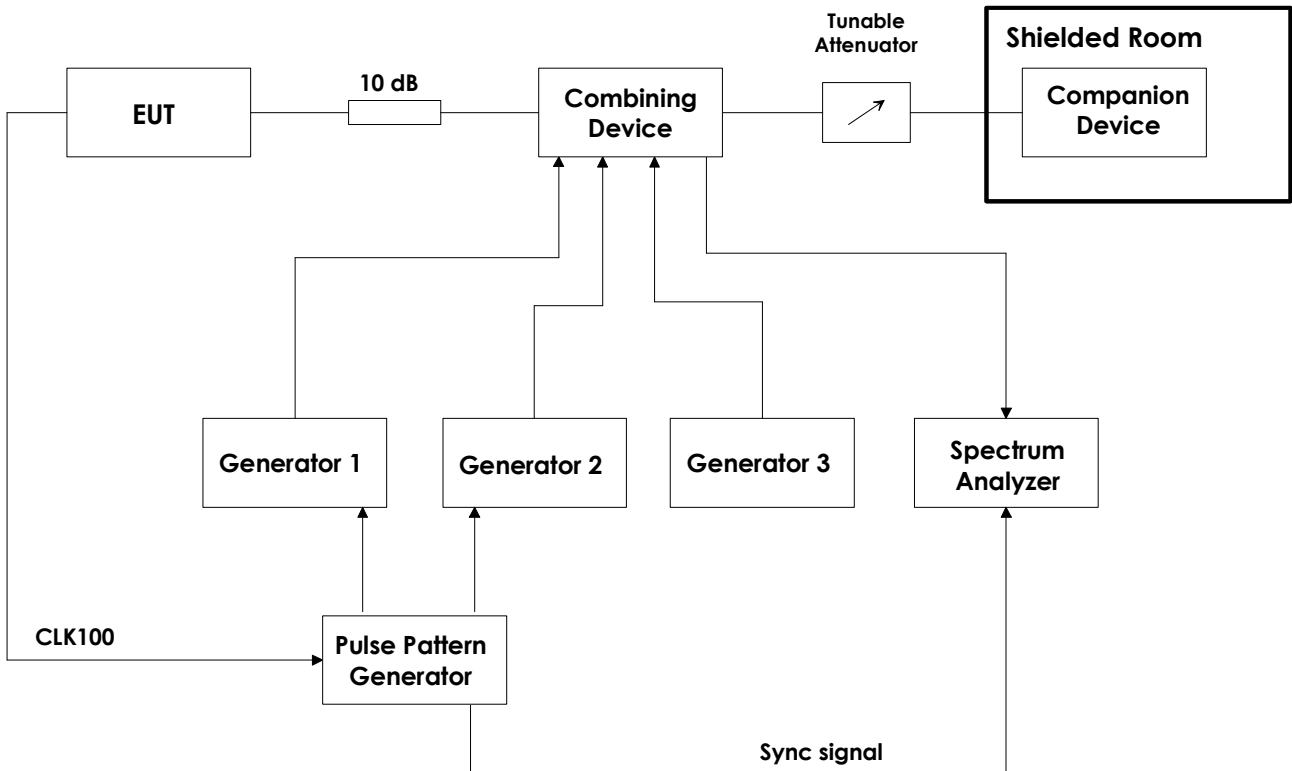

Test Set-Up 6

This test setup is used for all Monitoring and Time and Spectrum Access Procedure tests. The path loss from the signal generators to the EUT is measured with a power meter before the testing is started.

The CLK100 is used to synchronize the Pulse-/ Pattern generator to the start of the DECT frame, this signal always comes from the base station. If the EUT is a DECT Portable Part (i.e. a handset) the CLK100 signal will come from the Companion Device.

The sync signal to the Spectrum Analyzer is the CLK100 signal that is regenerated in the Pulse-/ Pattern Generator, this is used to synchronize the Spectrum Analyzer to the DECT frame when in zero span. The Pulse-/ Pattern Generator is used for tests that require time synchronized pulses or blocking of specific time slots.

6 Test Equipment Used

To facilitate inclusion on each page of the test equipment used for related tests, each item of test equipment and ancillaries are identified (numbered) by the Testhouse.

No.	Model number	Description	Manufacturer	Ref. no.	Cal. date	Cal. Due
1	FSU26	Spectrum Analyzer	Rohde & Schwarz	LR 1504	2020-01	2022-01
2	SME03	Signal generator	Rohde & Schwarz	LR 1238	COU	
3	SMIQ03B	Signal generator	Rohde & Schwarz	LR 1516	COU	
4	SMHU52	Signal generator	Rohde & Schwarz	LR 1240	COU	
5	53310A	Modulation Domain Analyzer	Hewlett Packard	LR 1483	2020-04	2022-04
6	81110A	Pulse-/ Pattern Generator	Agilent	LR 1725	COU	
7	8470B	Crystal Detector	Hewlett Packard	LR 1207	N/A	
8	ESCI3	Measuring Receiver	Rohde & Schwarz	N-4259	2019-10	2021-10
9	6810.17B	Attenuator	Suhner	LR 1669	2020-08	2021-08
10	745-69	Step Attenuator	Narda	LR 1442	N/A	
11	WE 1506A	Power Splitter	Weinchel	LR 244	COU	
12	WE 1506A	Power Splitter	Weinchel	LR 245	COU	
13	H-9	Hybrid	Anzac	LR 86	COU	
14	H-9	Hybrid	Anzac	LR 257	COU	
15	S212DS	RF Switch	Narda	LR 1244	N/A	
16	ENV216	Two Line V-Network	Rohde & Schwarz	LR 1665	2019-11	2021-11
17	6812B	AC Power Source	Agilent	LR 1515	2020-04	2021-04
18	Model 87 V	Multimeter	Fluke	LR-1600	2020-02	2022-02
19	87H35-1	Circulator	Racal-MESL	s.no.: 140	N/A	
20	87H35-1	Circulator	Racal-MESL	s.no.: 141	N/A	
21	87H35-1	Circulator	Racal-MESL	s.no.: 142	N/A	
22	TY80	Climatic Chamber	ACS	LR 1083	2019-04	2021-04
27	U2000A	Average Power Sensor	Agilent	LR 1523	2020-09	2021-09

COU = Cal on use

The software listed below has been used for one or more tests.

No.	Manufacturer	Name	Version	Comment
1	Rohde & Schwarz	EMC32	10.40.10	Power Line Conducted test software
2	Rohde & Schwarz	EMC32	10.50.10	Radiated Emission test software
3	Nemko AS	RSPlot	1.0.8.0	Screenshots from R&S Spectrum Analyzers
4	Agilent	Intuitlink Data Capture	2.1.0	Screenshots from HP 53310A

Revision history

Revision	Date	Comment	Sign
00	2021.03.26	First edition	FS
01	2021.05.04	Updated Monitoring Tests	FS
02	2021.05.10	Manufacturer corrected	FS