

EPOS

H3 Hybrid

Bluetooth® Gaming headset

Quick Guide

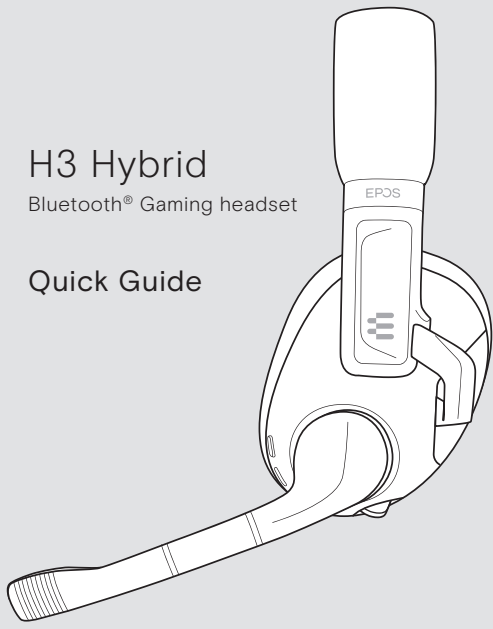

Model: SCBT25

Package contents

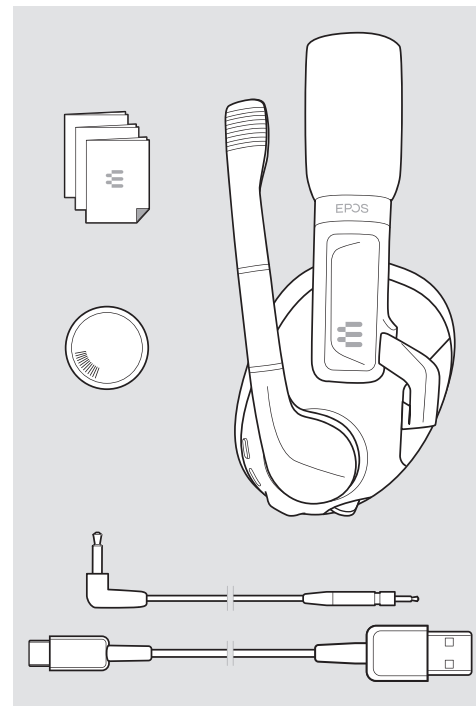

Switching the headset on/off

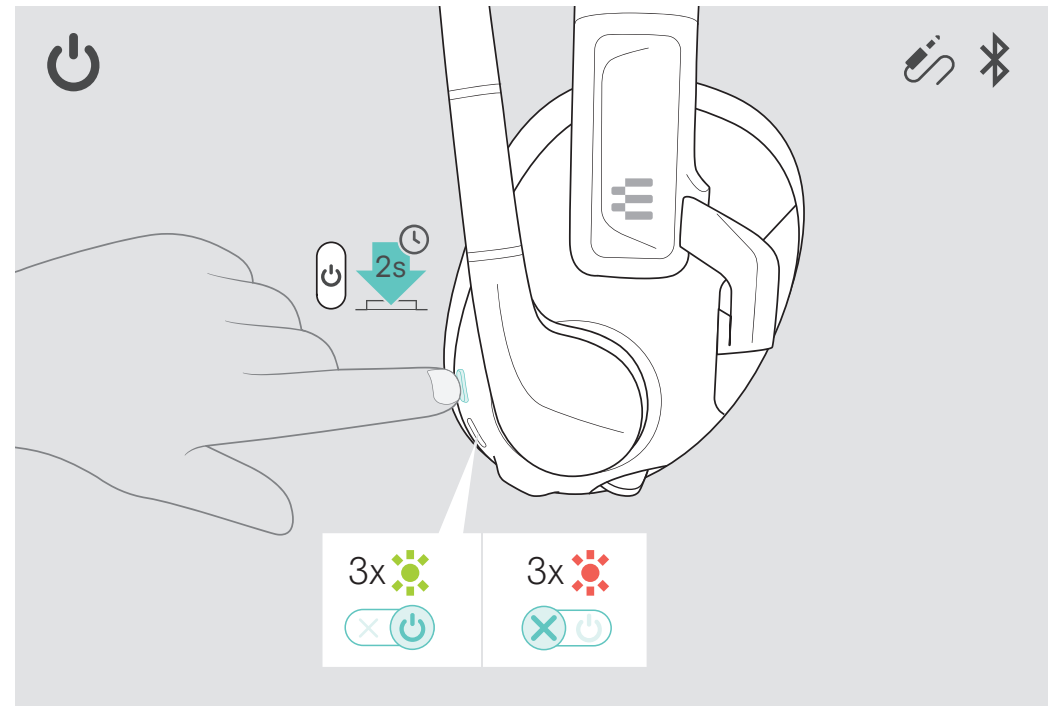

More features: User Guide

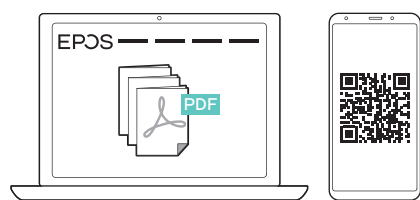

www.eposaudio.com/gaming/downloads

FAQs & support:

www.eposaudio.com/gaming/support

Connection possibilities



Connecting to PC via USB & charging the battery

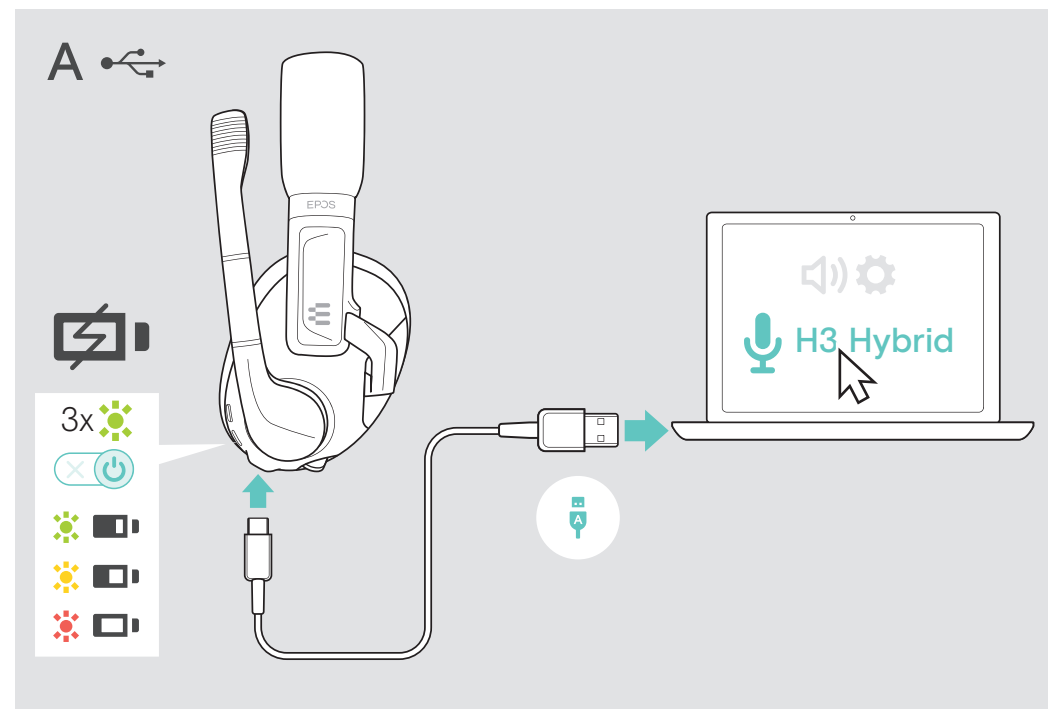

DSEA A/S

Kongebakken 9, DK-2765 Smørum, Denmark
www.eposaudio.com

Printed in China, Publ. 02/21, 770-00363/A01

Connecting the headset via console cable or Bluetooth

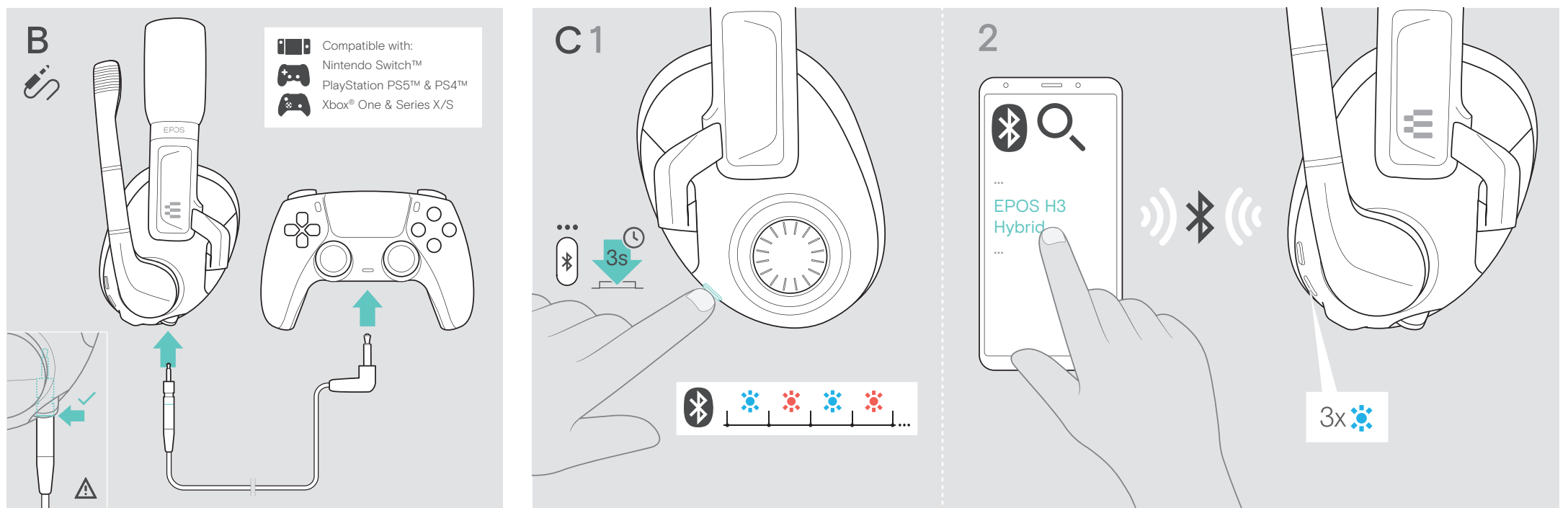

Adjusting and wearing the headset

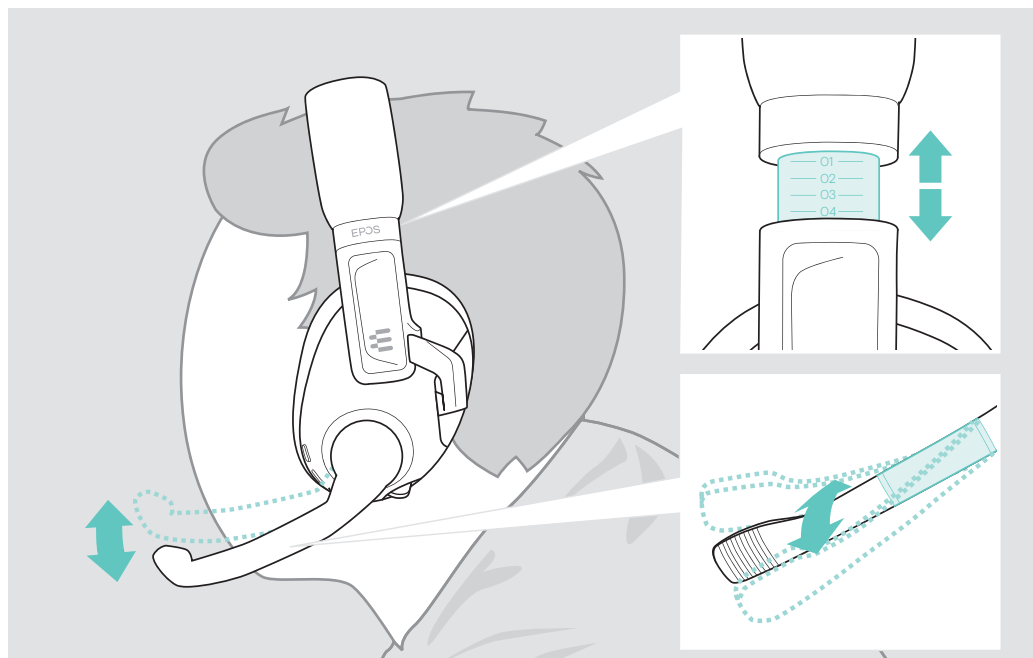

Enhance your audio experience

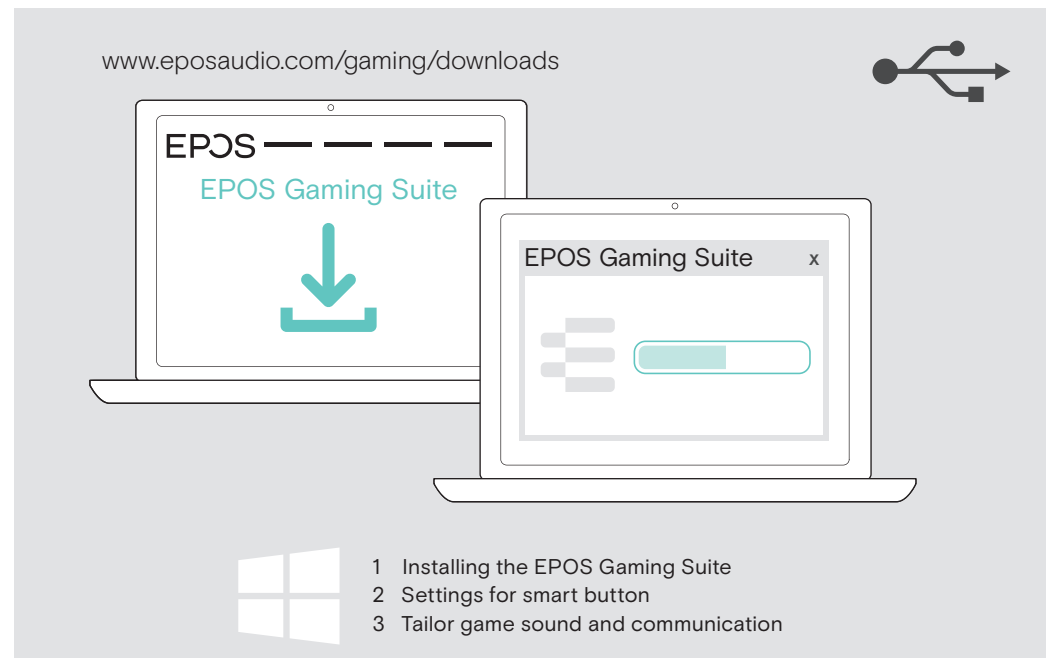

Mixing audio: two devices connected

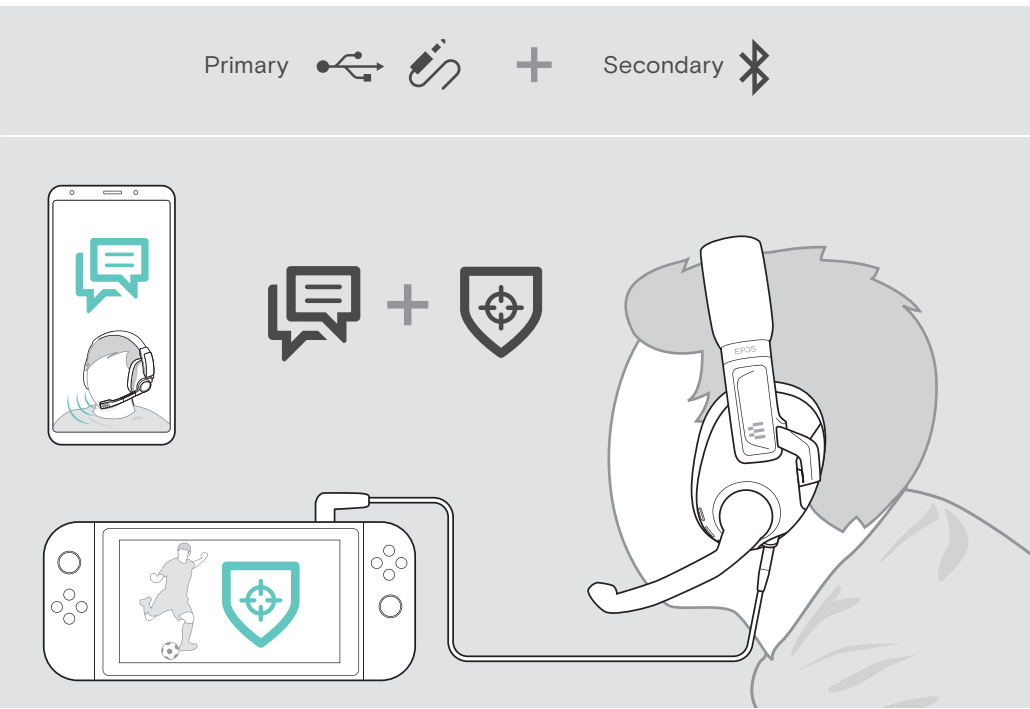

Adjusting the volume

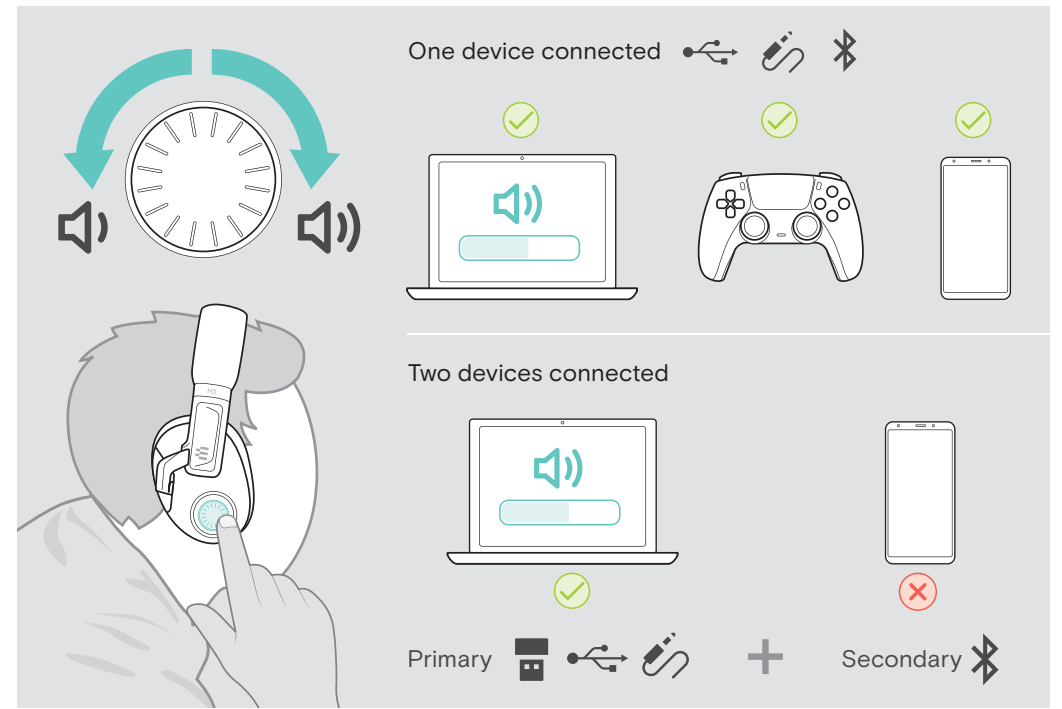

Using the headset on the go

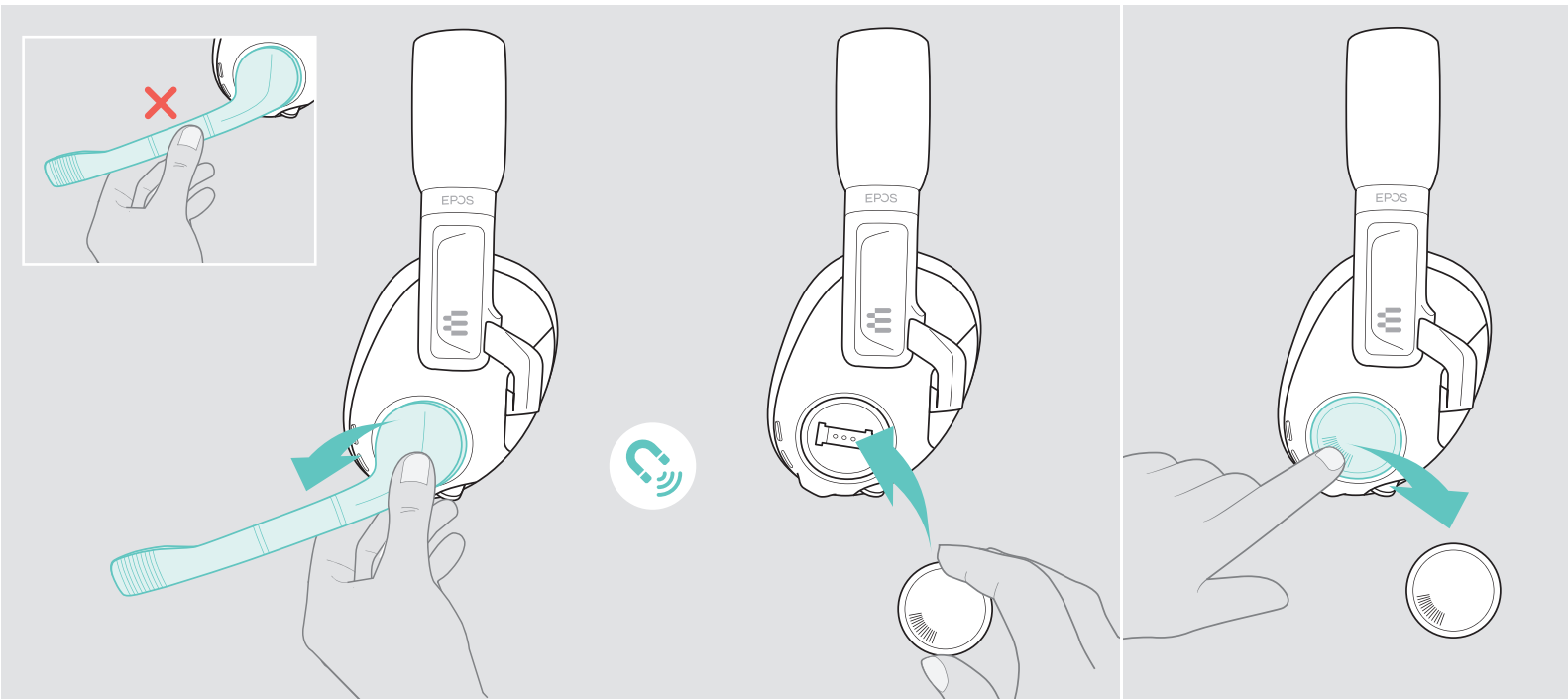

Accessories

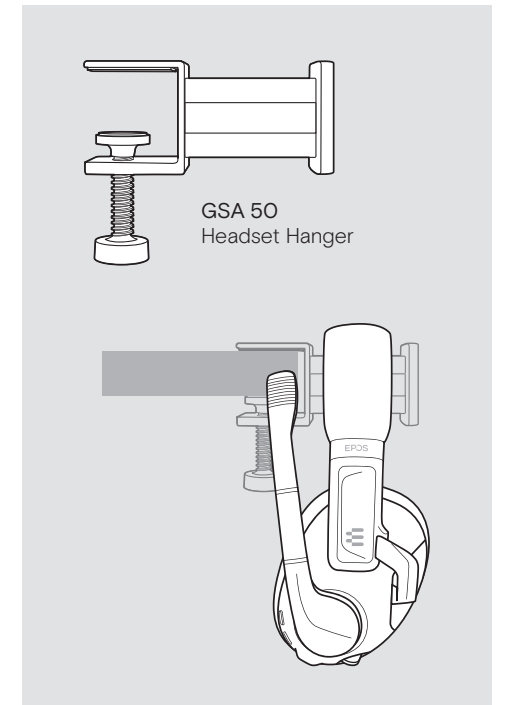

Using the Smart button

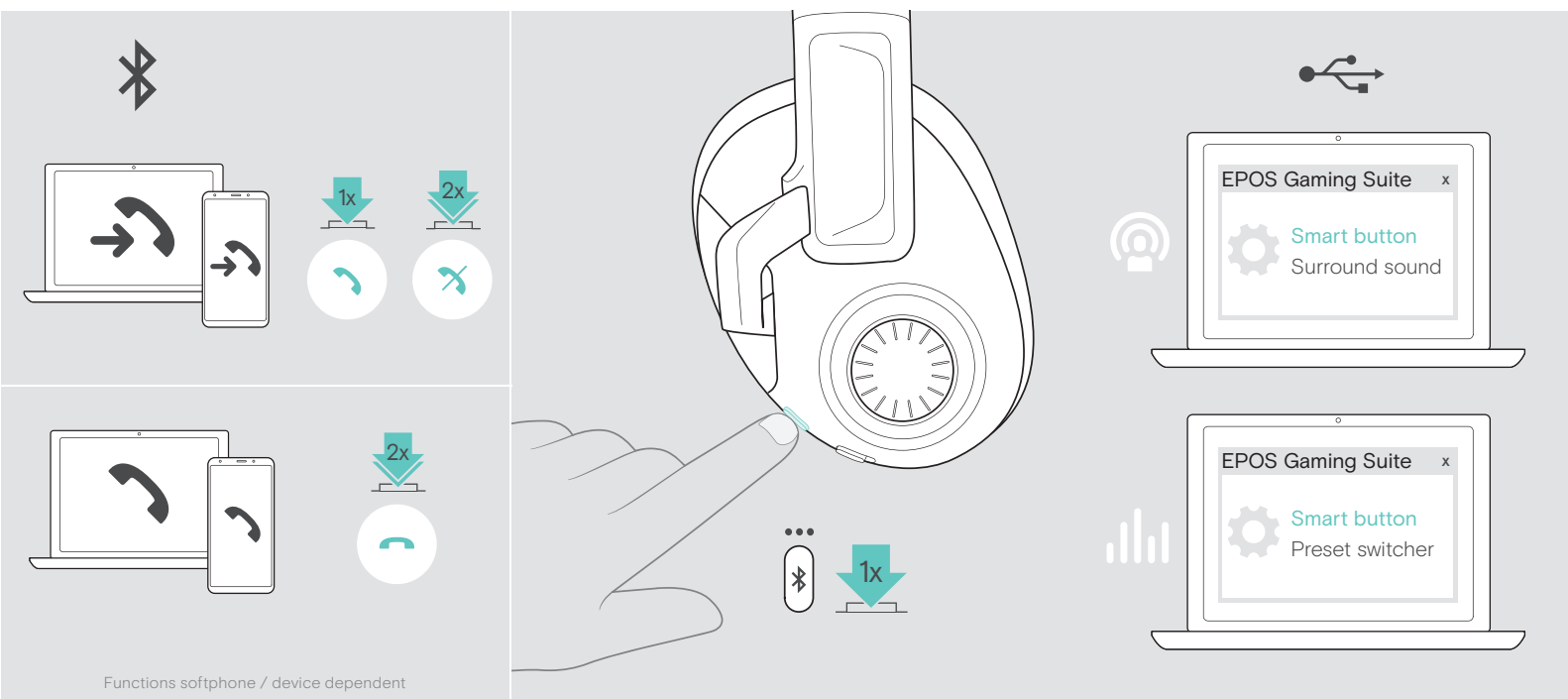

Cleaning the product

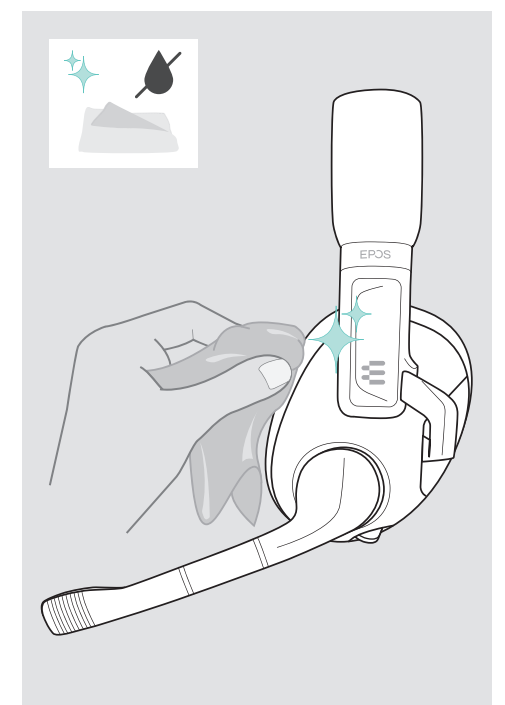

Muting the microphone

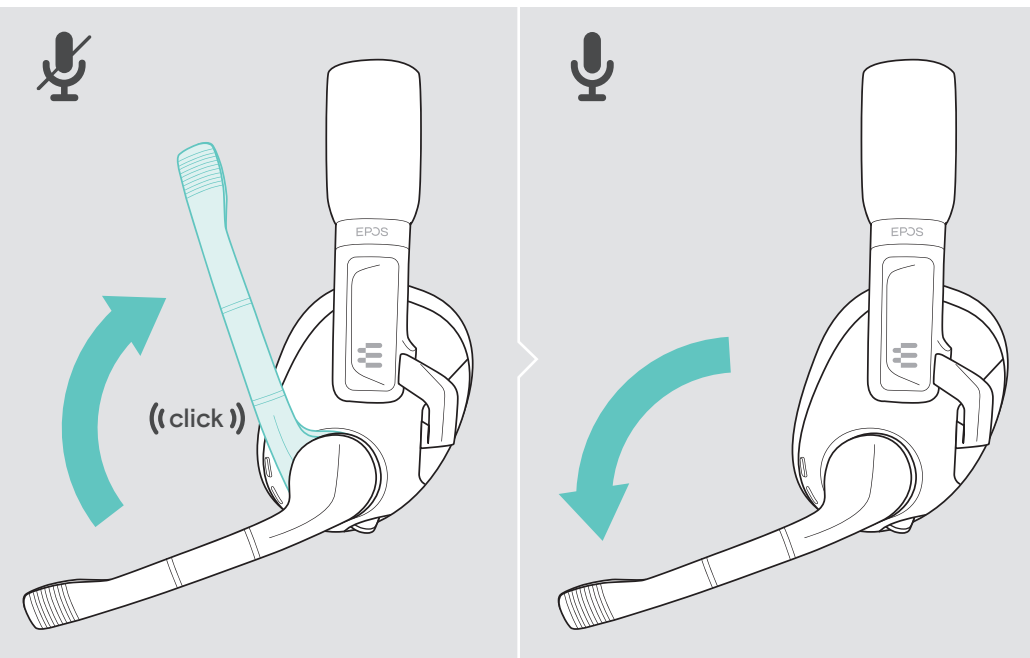

Replacing the ear pads

