

FCC Test Report

FCC ID : R3USCBT17
Product Description : In-ear neckband Bluetooth headset
Model No. : SCBT17
Brand Name : EPOS | SENNHEISER
Applicant : Sennheiser Communications
Address : Industriparken 27, Ballerup 2750, Denmark
Standard : 47 CFR FCC Part 15.247
Received Date : Dec. 10, 2019
Tested Date : Dec. 17 ~ Dec. 27, 2019

We, International Certification Corp., would like to declare that the tested sample has been evaluated and in compliance with the requirement of the above standards. The test results contained in this report refer exclusively to the product. It may be duplicated completely for legal use with the approval of the applicant. It shall not be reproduced except in full without the written approval of our laboratory.

Reviewed by:



Along Chen / Assistant Manager

Approved by:



Gary Chang / Manager



Table of Contents

1	GENERAL DESCRIPTION	5
1.1	Information.....	5
1.2	Local Support Equipment List	8
1.3	Test Setup Chart	8
1.4	The Equipment List	9
1.5	Test Standards	10
1.6	Deviation from Test Standard and Measurement Procedure.....	10
1.7	Measurement Uncertainty	10
2	TEST CONFIGURATION	11
2.1	Testing Condition	11
2.2	Testing Facility.....	11
2.3	The Worst Test Modes and Channel Details	11
3	TRANSMITTER TEST RESULTS.....	12
3.1	Conducted Emissions.....	12
3.2	Unwanted Emissions into Restricted Frequency Bands	15
3.3	Unwanted Emissions into Non-Restricted Frequency Bands	32
3.4	Conducted Output Power	37
3.5	Number of Hopping Frequency	40
3.6	20dB and Occupied Bandwidth	43
3.7	Channel Separation.....	48
3.8	Number of Dwell Time.....	53
4	PHOTOGRAPHS OF EUT	58
5	TEST LABORATORY INFORMATION	59

Release Record

Report No.	Version	Description	Issued Date
FR9D1001	Rev. 01	Initial issue	Feb. 24, 2020

Summary of Test Results

FCC Rules	Test Items	Measured	Result
15.207	Conducted Emissions	[dBuV]: 4.478MHz 40.44 (Margin -15.56dB) - QP	Pass
15.247(d) 15.209	Radiated Emissions	[dBuV/m at 3m]: 34.85MHz 30.79 (Margin -9.21dB) - PK	Pass
15.247(d)	Band Edge	Meet the requirement of limit	Pass
15.247(b)(1)	Conducted Output Power	Power [dBm]: 10.66	Pass
15.247(a)(1)(iii)	Number of Hopping Channels	Meet the requirement of limit	Pass
15.247(a)(1)	Hopping Channel Separation	Meet the requirement of limit	Pass
15.247(a)(1)(iii)	Dwell Time	Meet the requirement of limit	Pass
15.203	Antenna Requirement	Meet the requirement of limit	Pass

Declaration of Conformity:

The test results with all measurement uncertainty excluded are presented in accordance with the regulation limits or requirements declared by manufacturers.

Comments and Explanations:

The declared of product specification for EUT presented in the report are provided by the manufacturer, and the manufacturer takes all the responsibilities for the accuracy of product specification.

1 General Description

1.1 Information

1.1.1 Product Details

The following models are provided to this EUT.

Brand name	Model name	Product name	Product description	Difference
EPOS SENNHEISER	SCBT17	ADAPT 460	In-ear neckband Bluetooth headset	Only for FW different.
		ADAPT 460T		

1.1.2 Specification of the Equipment under Test (EUT)

RF General Information				
Frequency Range (MHz)	Bluetooth Mode	Ch. Frequency (MHz)	Channel Number	Data Rate
2400-2483.5	BR V5.0	2402-2480	0-78 [79]	1 Mbps
2400-2483.5	EDR V5.0	2402-2480	0-78 [79]	2 Mbps
2400-2483.5	EDR V5.0	2402-2480	0-78 [79]	3 Mbps

Note 1: RF output power specifies that Maximum Peak Conducted Output Power.
 Note 2: Bluetooth BR uses a GFSK.
 Note 3: Bluetooth EDR uses a combination of $\pi/4$ -DQPSK and 8DPSK.

1.1.3 Antenna Details

Ant. No.	Type	Connector	Gain (dBi)	Remarks
1	PIFA	N/A	2	---

1.1.4 Power Supply Type of Equipment under Test (EUT)

Power Supply Type	5Vdc from host Battery 3.7Vdc
--------------------------	----------------------------------

1.1.5 Accessories

Accessories		
No.	Equipment	Description
1	Battery	Brand: Synergi Model: AHB621333PCT Rating: 3.7Vdc, 230mAh
2	USB cable (for charging use)	1.27m shielded without core. Brand: SENNHEISER / Model: EPU1201
3	USB dongle	Brand: SENNHEISER / Model: BTD 800 USB

1.1.6 Channel List

Frequency band (MHz)				2400~2483.5			
Channel	Frequency (MHz)	Channel	Frequency (MHz)	Channel	Frequency (MHz)	Channel	Frequency (MHz)
0	2402	20	2422	40	2442	60	2462
1	2403	21	2423	41	2443	61	2463
2	2404	22	2424	42	2444	62	2464
3	2405	23	2425	43	2445	63	2465
4	2406	24	2426	44	2446	64	2466
5	2407	25	2427	45	2447	65	2467
6	2408	26	2428	46	2448	66	2468
7	2409	27	2429	47	2449	67	2469
8	2410	28	2430	48	2450	68	2470
9	2411	29	2431	49	2451	69	2471
10	2412	30	2432	50	2452	70	2472
11	2413	31	2433	51	2453	71	2473
12	2414	32	2434	52	2454	72	2474
13	2415	33	2435	53	2455	73	2475
14	2416	34	2436	54	2456	74	2476
15	2417	35	2437	55	2457	75	2477
16	2418	36	2438	56	2458	76	2478
17	2419	37	2439	57	2459	77	2479
18	2420	38	2440	58	2460	78	2480
19	2421	39	2441	59	2461	---	---

1.1.7 Test Tool and Duty Cycle

Test Tool	CBT control	
Modulation Mode	Duty Cycle (%)	Duty Factor (dB)
DH5	78.61%	1.05
3DH5	78.03%	1.08

1.1.8 Power Index of Test Tool

Modulation Mode	Test Frequency (MHz)		
	2402	2441	2480
GFSK/1Mbps	Default	Default	Default
$\pi/4$ -DQPSK /2Mbps	Default	Default	Default
8DPSK/3Mbps	Default	Default	Default

1.2 Local Support Equipment List

Support Equipment List					
No.	Equipment	Brand	Model	FCC ID	Remarks
1	Adapter	Samsung	ETA-U90JWs	---	---
2	USB Cable	SENNHEISER	BTD 800 USB	---	Provided by applicant.

1.3 Test Setup Chart

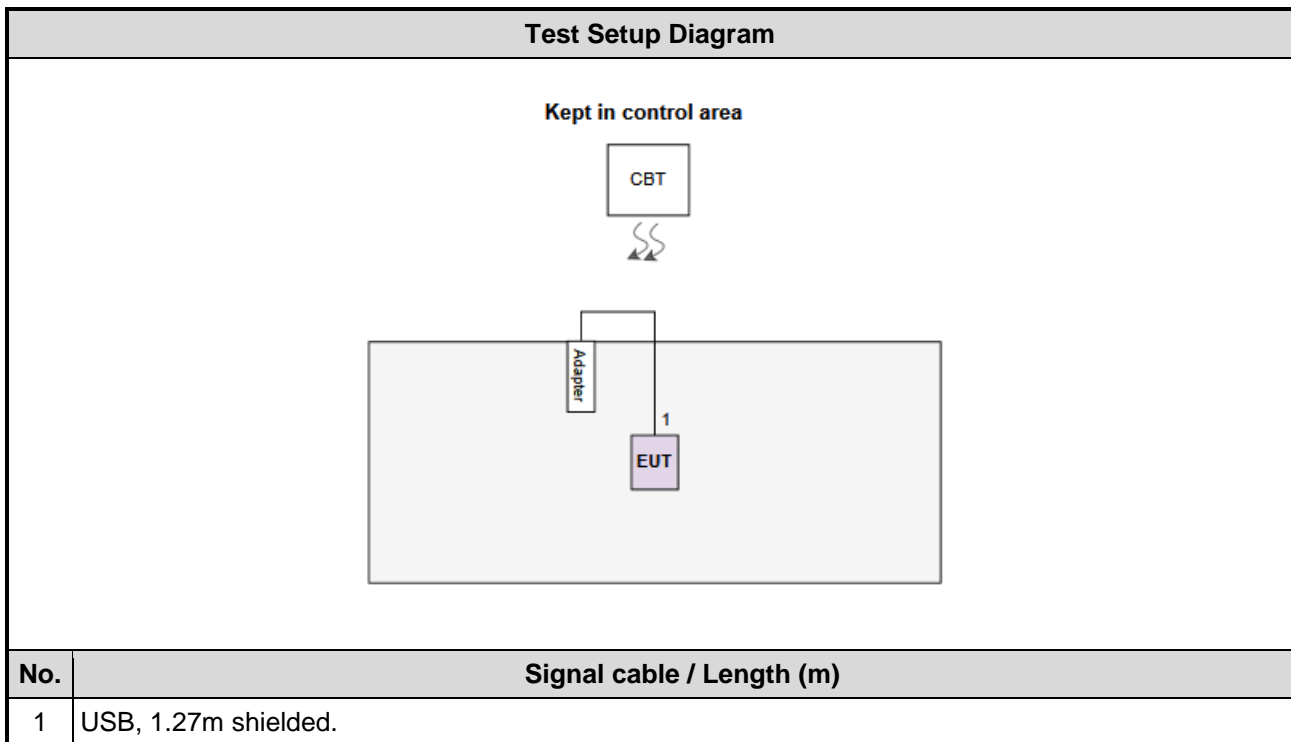

1.4 The Equipment List

Test Item	Conducted Emission				
Test Site	Conduction room 1 / (CO01-WS)				
Instrument	Manufacturer	Model No.	Serial No.	Calibration Date	Calibration Until
Receiver	R&S	ESR3	101658	Dec. 12, 2019	Dec. 11, 2020
LISN	R&S	ENV216	101579	Mar. 08, 2019	Mar. 07, 2020
RF Cable-CON	Woken	CFD200-NL	CFD200-NL-001	Oct. 22, 2019	Oct. 21, 2020
Measurement Software	AUDIX	e3	6.120210k	NA	NA

Note: Calibration Interval of instruments listed above is one year.

Test Item	Radiated Emission				
Test Site	966 chamber1 / (03CH01-WS)				
Instrument	Manufacturer	Model No.	Serial No.	Calibration Date	Calibration Until
Bluetooth Tester	R&S	CBT	100959	Oct. 18, 2019	Oct. 17, 2020
Spectrum Analyzer	R&S	FSV40	101498	Dec. 17, 2019	Dec. 16, 2020
Receiver	R&S	ESR3	101658	Dec. 12, 2019	Dec. 11, 2020
Bilog Antenna	SCHWARZBECK	VULB9168	VULB9168-522	Jul. 12, 2019	Jul. 11, 2020
Horn Antenna 1G-18G	SCHWARZBECK	BBHA 9120 D	BBHA 9120 D 1096	Dec. 12, 2019	Dec. 11, 2020
Horn Antenna 18G-40G	SCHWARZBECK	BBHA 9170	BBHA 9170517	Nov. 15, 2019	Nov. 14, 2020
Loop Antenna	R&S	HFH2-Z2	100330	Nov. 13, 2019	Nov. 12, 2020
Loop Antenna Cable	KOAX KABEL	101354-BW	101354-BW	Oct. 07, 2019	Oct. 06, 2020
Preamplifier	EMC	EMC02325	980225	Jul. 09, 2019	Jul. 08, 2020
Preamplifier	Agilent	83017A	MY39501308	Oct. 08, 2019	Oct. 07, 2020
Preamplifier	EMC	EMC184045B	980192	Aug. 01, 2019	Jul. 31, 2020
RF Cable	EMC	EMC104-SM-SM-8000	181106	Oct. 07, 2019	Oct. 06, 2020
RF Cable	HUBER+SUHNER	SUCOFLEX104	MY16019/4	Oct. 07, 2019	Oct. 06, 2020
RF Cable	HUBER+SUHNER	SUCOFLEX104	MY16014/4	Oct. 07, 2019	Oct. 06, 2020
LF cable 1M	EMC	EMCCFD400-NM-NM-1000	160502	Oct. 07, 2019	Oct. 06, 2020
LF cable 3M	Woken	CFD400NL-LW	CFD400NL-001	Oct. 07, 2019	Oct. 06, 2020
LF cable 10M	Woken	CFD400NL-LW	CFD400NL-002	Oct. 07, 2019	Oct. 06, 2020
Measurement Software	AUDIX	e3	6.120210g	NA	NA

Note: Calibration Interval of instruments listed above is one year.

Test Item	RF Conducted				
Test Site	(TH01-WS)				
Instrument	Manufacturer	Model No.	Serial No.	Calibration Date	Calibration Until
Bluetooth Tester	R&S	CBT	100959	Oct. 18, 2019	Oct. 17, 2020
Spectrum Analyzer	R&S	FSV40	101063	Apr. 17, 2019	Apr. 16, 2020
Power Meter	Anritsu	ML2495A	1241002	Oct. 23, 2019	Oct. 22, 2020
Power Sensor	Anritsu	MA2411B	1207366	Oct. 23, 2019	Oct. 22, 2020
DC POWER SOURCE	GW INSTEK	GPC-6030D	GES855395	Oct. 29, 2019	Oct. 28, 2020
Measurement Software	ICC	SENSE-15247_FS	V5.10.1	NA	NA
Note: Calibration Interval of instruments listed above is one year.					

1.5 Test Standards

According to the specification of EUT, the EUT must comply with following standards and KDB documents.

47 CFR FCC Part 15.247

ANSI C63.10-2013

FCC KDB 558074 D01 15.247 Meas Guidance v05r02

1.6 Deviation from Test Standard and Measurement Procedure

None

1.7 Measurement Uncertainty

ISO/IEC 17025 and ANSI C63.10 require that an estimate of the measurement uncertainties associated with the emissions test results be included in the report. The measurement uncertainties given below are based on a 95% confidence level (based on a coverage factor (k=2)).

Measurement Uncertainty	
Parameters	Uncertainty
Bandwidth	±34.130 Hz
Conducted power	±0.808 dB
Power density	±0.583 dB
Conducted emission	±2.715 dB
AC conducted emission	±2.92 dB
Radiated emission ≤ 1GHz	±3.41 dB
Radiated emission > 1GHz	±4.59 dB
Time	±0.1%

2 Test Configuration

2.1 Testing Condition

Test Item	Test Site	Ambient Condition	Tested By
AC Conduction	CO01-WS	23°C / 69%	Akun Chung
Radiated Emissions	03CH01-WS	22-23°C / 64-66%	Brad Wu
RF Conducted	TH01-WS	22°C / 64%	Brad Wu

- FCC Designation No.: TW2732
- FCC site registration No.: 181692
- ISED#: 10807A
- CAB identifier: TW2732

2.2 Testing Facility

Test Laboratory	International Certification Corp.
Test Site	CO01-WS, 03CH01-WS, TH01-WS
Address of Test Site (Kwei Shan)	No. 3-1, Lane 6, Wen San 3rd St., Kwei Shan District, Tao Yuan City 333, Taiwan, R.O.C.

2.3 The Worst Test Modes and Channel Details

Test item	Mode	Test Frequency (MHz)	Data Rate (Mbps)	Test Configuration
Conducted Emissions	8DPSK	2441	3Mbps	---
Radiated Emissions ≤ 1GHz	8DPSK	2441	3Mbps	---
Radiated Emissions > 1GHz	GFSK 8DPSK	2402, 2441, 2480 2402, 2441, 2480	1Mbps 3Mbps	---
Conducted Output Power	GFSK π/4 DQPSK 8DPSK	2402, 2441, 2480 2402, 2441, 2480 2402, 2441, 2480	1Mbps 2Mbps 3Mbps	---
Number of Hopping Channels	GFSK π/4 DQPSK 8DPSK	2402~2480 2402~2480 2402~2480	1Mbps 2Mbps 3Mbps	---
Hopping Channel Separation 20dB and Occupied bandwidth	GFSK π/4 DQPSK 8DPSK	2402, 2441, 2480 2402, 2441, 2480 2402, 2441, 2480	1Mbps 2Mbps 3Mbps	---
Dwell Time	GFSK π/4 DQPSK 8DPSK	2441 2441 2441	1Mbps 2Mbps 3Mbps	---

NOTE: The EUT was pretested with 3 orientations placed on the table for the radiated emission measurement – X, Y, and Z-plane. The **X-plane** results were found as the worst case and were shown in this report.

3 Transmitter Test Results

3.1 Conducted Emissions

3.1.1 Limit of Conducted Emissions

Conducted Emissions Limit		
Frequency Emission (MHz)	Quasi-Peak	Average
0.15-0.5	66 - 56 *	56 - 46 *
0.5-5	56	46
5-30	60	50

Note 1: * Decreases with the logarithm of the frequency.

3.1.2 Test Procedures

1. The device is placed on a test table, raised 80 cm above the reference ground plane. The vertical conducting plane is located 40 cm to the rear of the device.
2. The device is connected to line impedance stabilization network (LISN) and other accessories are connected to other LISN. Measured levels of AC power line conducted emission are across the 50 Ω LISN port.
3. AC conducted emission measurements is made over frequency range from 150 kHz to 30 MHz.
4. This measurement was performed with AC 120V/60Hz

3.1.3 Test Setup



- Note: 1. Support units were connected to second LISN.
 2. Both of LISNs (AMN) are 80 cm from EUT and at least 80 cm from other units and other metal planes

3.1.4 Test Result of Conducted Emissions

Modulation Mode	8DPSK	Test Freq. (MHz)	2441
Power Phase	Line		

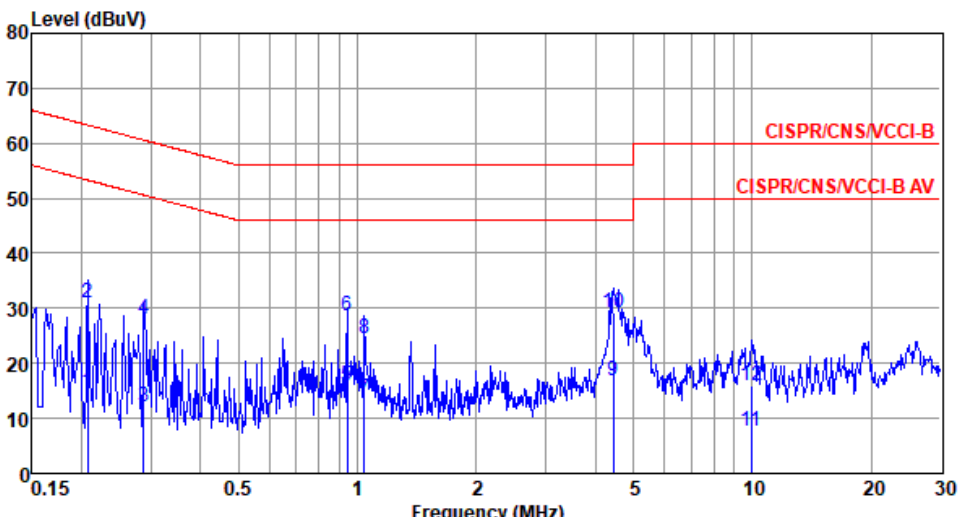

	Freq MHz	Level dBuV	Limit Line dBuV	Over Limit dB	Read Level dBuV	LISN factor dB	cable loss dB	Remark
1	0.207	14.79	53.32	-38.53	5.00	9.54	0.06	Average
2	0.207	31.07	63.32	-32.25	21.28	9.54	0.06	QP
3	0.288	11.96	50.59	-38.63	2.11	9.56	0.07	Average
4	0.288	27.95	60.59	-32.64	18.10	9.56	0.07	QP
5	0.943	15.85	46.00	-30.15	5.81	9.60	0.12	Average
6	0.943	28.55	56.00	-27.45	18.51	9.60	0.12	QP
7	1.043	13.58	46.00	-32.42	3.54	9.60	0.12	Average
8	1.043	24.44	56.00	-31.56	14.40	9.60	0.12	QP
9	4.454	16.83	46.00	-29.17	6.55	9.61	0.30	Average
10*	4.454	29.08	56.00	-26.92	18.80	9.61	0.30	QP
11	9.966	7.77	50.00	-42.23	-2.67	9.65	0.39	Average
12	9.966	15.92	60.00	-44.08	5.48	9.65	0.39	QP

Note 1: Level (dBuV) = Read Level (dBuV) + LISN Factor (dB) + Cable Loss (dB).
 Note 2: Over Limit (dB) = Level (dBuV) – Limit Line (dBuV).

Modulation Mode	8DPSK	Test Freq. (MHz)	2441
Power Phase	Neutral		

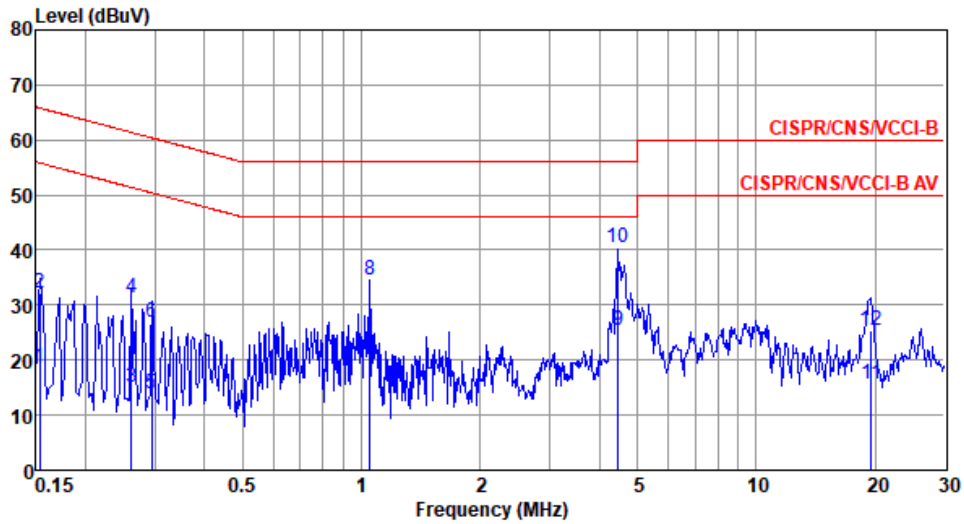

	Freq MHz	Level dBuV	Limit Line dBuV	Over Limit dB	Read Level dBuV	LISN factor dB	cable loss dB	Remark
1	0.153	18.72	55.82	-37.10	8.98	9.57	0.05	Average
2	0.153	32.20	65.82	-33.62	22.46	9.57	0.05	QP
3	0.262	15.17	51.38	-36.21	5.35	9.59	0.07	Average
4	0.262	31.30	61.38	-30.08	21.48	9.59	0.07	QP
5	0.294	14.00	50.41	-36.41	4.17	9.60	0.07	Average
6	0.294	26.89	60.41	-33.52	17.06	9.60	0.07	QP
7	1.049	20.47	46.00	-25.53	10.51	9.64	0.12	Average
8	1.049	34.59	56.00	-21.41	24.63	9.64	0.12	QP
9	4.478	25.42	46.00	-20.58	15.18	9.67	0.30	Average
10*	4.478	40.44	56.00	-15.56	30.20	9.67	0.30	QP
11	19.532	15.52	50.00	-34.48	4.55	9.81	0.65	Average
12	19.532	25.39	60.00	-34.61	14.42	9.81	0.65	QP

Note 1: Level (dBuV) = Read Level (dBuV) + LISN Factor (dB) + Cable Loss (dB).
 2: Over Limit (dB) = Level (dBuV) – Limit Line (dBuV).

3.2 Unwanted Emissions into Restricted Frequency Bands

3.2.1 Limit of Unwanted Emissions into Restricted Frequency Bands

Restricted Band Emissions Limit			
Frequency Range (MHz)	Field Strength (uV/m)	Field Strength (dBuV/m)	Measure Distance (m)
0.009~0.490	2400/F(kHz)	48.5 - 13.8	300
0.490~1.705	24000/F(kHz)	33.8 - 23	30
1.705~30.0	30	29	30
30~88	100	40	3
88~216	150	43.5	3
216~960	200	46	3
Above 960	500	54	3

Note 1:
Qusai-Peak value is measured for frequency below 1GHz except for 9–90 kHz, 110–490 kHz frequency band. Peak and average value are measured for frequency above 1GHz. The limit on average radio frequency emission is as above table. The limit on peak radio frequency emissions is 20 dB above the maximum permitted average emission limit

Note 2:
Measurements may be performed at a distance other than what is specified provided. When performing measurements at a distance other than that specified, the results shall be extrapolated to the specified distance using an extrapolation factor as below, Frequency at or above 30 MHz: 20 dB/decade Frequency below 30 MHz: 40 dB/decade.

3.2.2 Test Procedures

1. Measurement is made at a semi-anechoic chamber that incorporates a turntable allowing a EUT rotation of 360°. A continuously-rotating, remotely-controlled turntable is installed at the test site to support the EUT and facilitate determination of the direction of maximum radiation for each EUT emission frequency. The EUT is placed at test table. For emissions testing at or below 1 GHz, the table height is 80 cm above the reference ground plane. For emission measurements above 1 GHz, the table height is 1.5 m
2. Measurement is made with the antenna positioned in both the horizontal and vertical planes of polarization. The measurement antenna is varied in height (1m ~ 4m) above the reference ground plane to obtain the maximum signal strength. Distance between EUT and antenna is 3 m.
3. This investigation is performed with the EUT rotated 360°, the antenna height scanned between 1 m and 4 m, and the antenna rotated to repeat the measurements for both the horizontal and vertical antenna polarizations.

Note:

1. 120kHz measurement bandwidth of test receiver and Quasi-peak detector is for radiated emission below 1GHz.

2. Radiated emission above 1GHz / Peak value
RBW=1MHz, VBW=3MHz and Peak detector

Radiated emission above 1GHz / Average value for harmonics

The average value is: Average = Peak value + 20log(Duty cycle) Where the duty factor is calculated from following formula for DH5 packet type which has worst duty factor:

3.
$$20\log(\text{Duty cycle}) = 20\log \frac{1\text{s} / 1600 * 5}{100\text{ ms}} = -30.1\text{dB}$$

4. Radiated emission above 1GHz / Average value for other emissions
RBW=1MHz, VBW=1/T and Peak detector

3.2.3 Test Setup

Radiated Emissions below 1 GHz

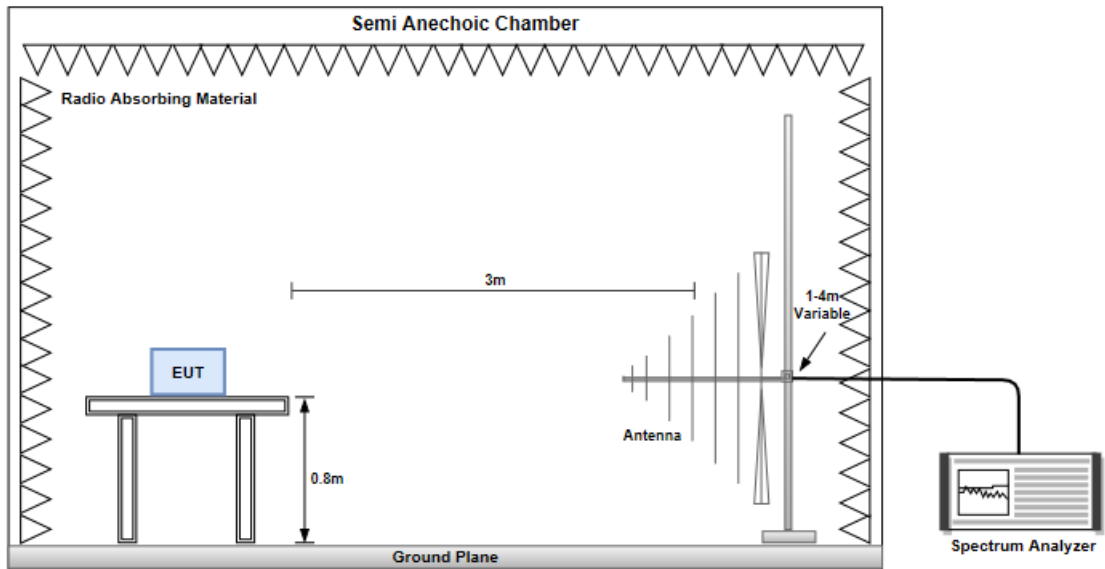

Radiated Emissions above 1 GHz

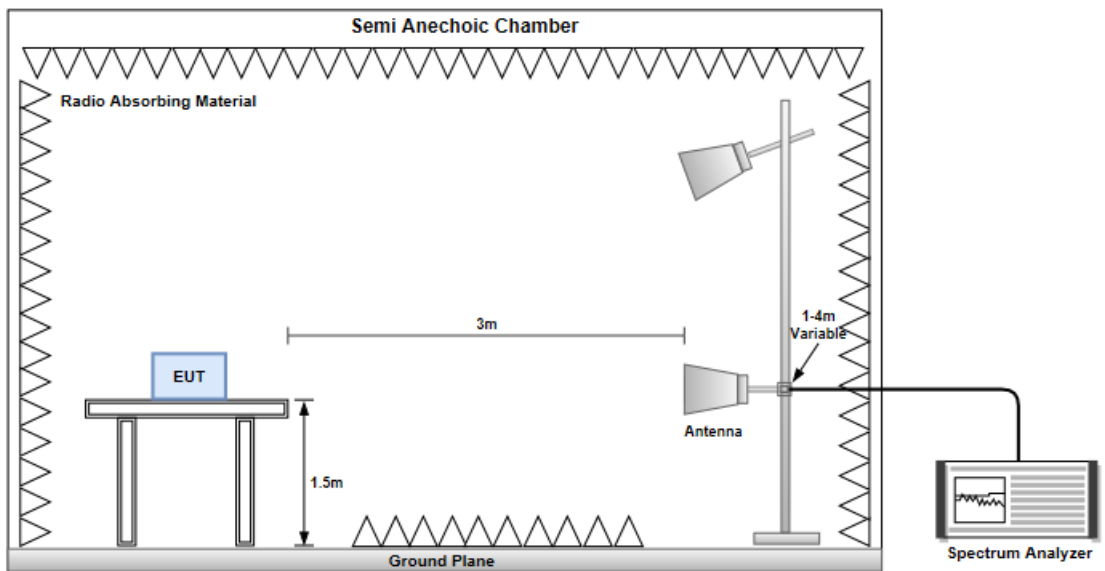

3.2.4 Transmitter Radiated Unwanted Emissions (Below 1GHz)

Modulation	8DPSK	Test Freq. (MHz)	2441
Polarization	Horizontal		

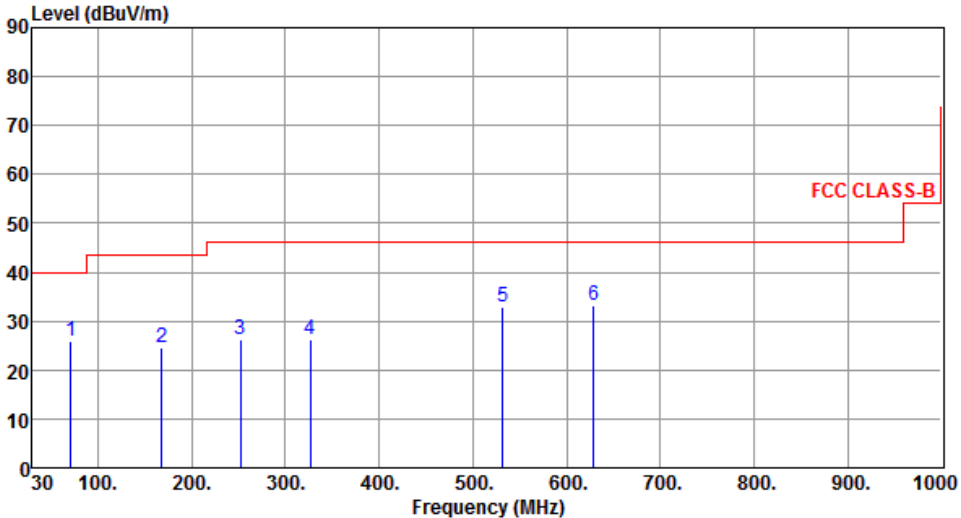

	Freq. MHz	Emission level dBuV/m	Limit dBuV/m	Margin dB	SA reading dBuV	Factor dB	Remark	ANT High cm	Turn Table deg
1	70.74	25.86	40.00	-14.14	36.58	-10.72	Peak	---	---
2	167.74	24.72	43.50	-18.78	33.42	-8.70	Peak	---	---
3	252.13	26.09	46.00	-19.91	35.95	-9.86	Peak	---	---
4	326.82	26.36	46.00	-19.64	33.59	-7.23	Peak	---	---
5	531.49	33.03	46.00	-12.97	35.67	-2.64	Peak	---	---
6	628.49	33.31	46.00	-12.69	33.77	-0.46	Peak	---	---

Note 1: Emission Level (dBuV/m) = SA Reading (dBuV/m) + Factor* (dB)
*Factor includes antenna factor , cable loss and amplifier gain
Note 2: Margin (dB) = Emission level (dBuV/m) – Limit (dBuV/m).
Note 3: All spurious emissions below 30MHz are more than 20 dB below the limit.

Modulation	8DPSK	Test Freq. (MHz)	2441
Polarization	Vertical		

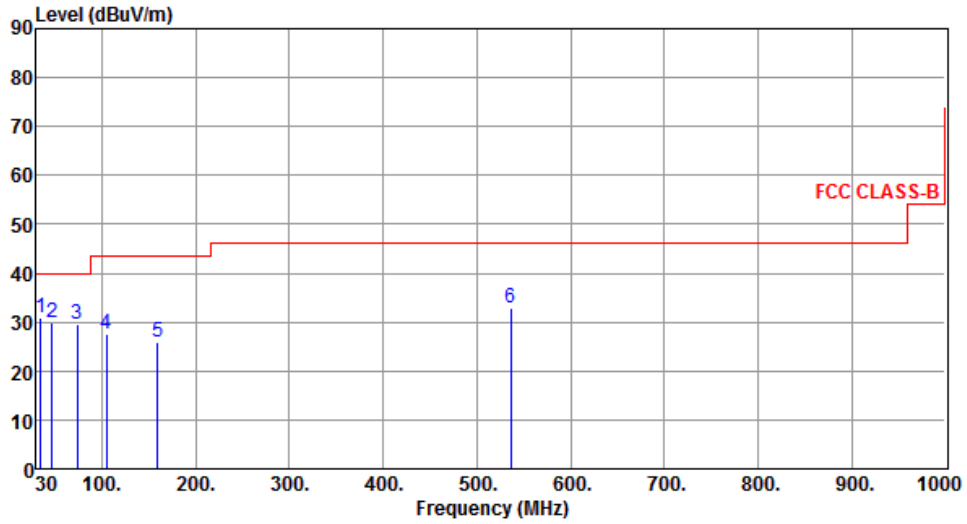

	Freq. MHz	Emission level dBuV/m	Limit dBuV/m	Margin dB	SA reading dBuV	Factor dB	Remark	ANT High cm	Turn Table deg
1	34.85	30.79	40.00	-9.21	40.01	-9.22	Peak	---	---
2	46.49	29.98	40.00	-10.02	38.34	-8.36	Peak	---	---
3	73.65	29.43	40.00	-10.57	40.92	-11.49	Peak	---	---
4	104.69	27.53	43.50	-15.97	39.74	-12.21	Peak	---	---
5	159.01	25.93	43.50	-17.57	34.25	-8.32	Peak	---	---
6	536.34	32.82	46.00	-13.18	35.46	-2.64	Peak	---	---

Note 1: Emission Level (dBuV/m) = SA Reading (dBuV/m) + Factor* (dB)

*Factor includes antenna factor , cable loss and amplifier gain

Note 2: Margin (dB) = Emission level (dBuV/m) – Limit (dBuV/m).

Note 3: All spurious emissions below 30MHz are more than 20 dB below the limit.

3.2.5 Transmitter Radiated Unwanted Emissions (Above 1GHz) for GFSK

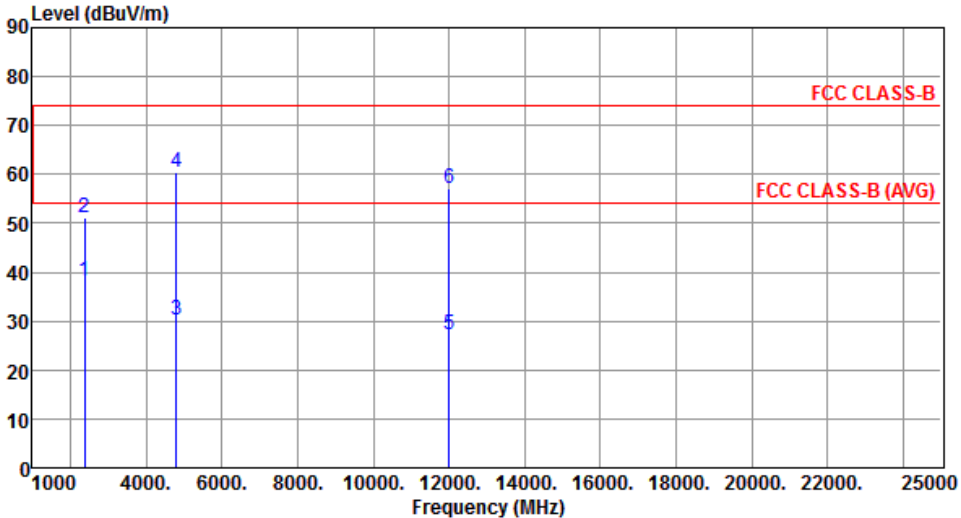
Modulation	GFSK	Test Freq. (MHz)	2402						
Polarization	Horizontal								
									
	Freq.	Emission level	Limit	Margin	SA reading	Factor	Remark	ANT High	Turn Table
	MHz	dBuV/m	dBuV/m	dB	dBuV	dB		cm	deg
1	2390.00	38.07	54.00	-15.93	40.89	-2.82	Average	130	226
2	2390.00	51.06	74.00	-22.94	53.88	-2.82	Peak	130	226
3	4804.00	30.30	54.00	-23.70	26.79	3.51	Average	133	240
4	4804.00	60.40	74.00	-13.60	56.89	3.51	Peak	133	240
5	12010.00	27.10	54.00	-26.90	13.18	13.92	Average	135	241
6	12010.00	57.20	74.00	-16.80	43.28	13.92	Peak	135	241
<p>Note 1: Emission Level (dBuV/m) = SA Reading (dBuV/m) + Factor* (dB) *Factor includes antenna factor , cable loss and amplifier gain Note 2: Margin (dB) = Emission level (dBuV/m) – Limit (dBuV/m).</p>									

Modulation	GFSK	Test Freq. (MHz)	2402
Polarization	Vertical		

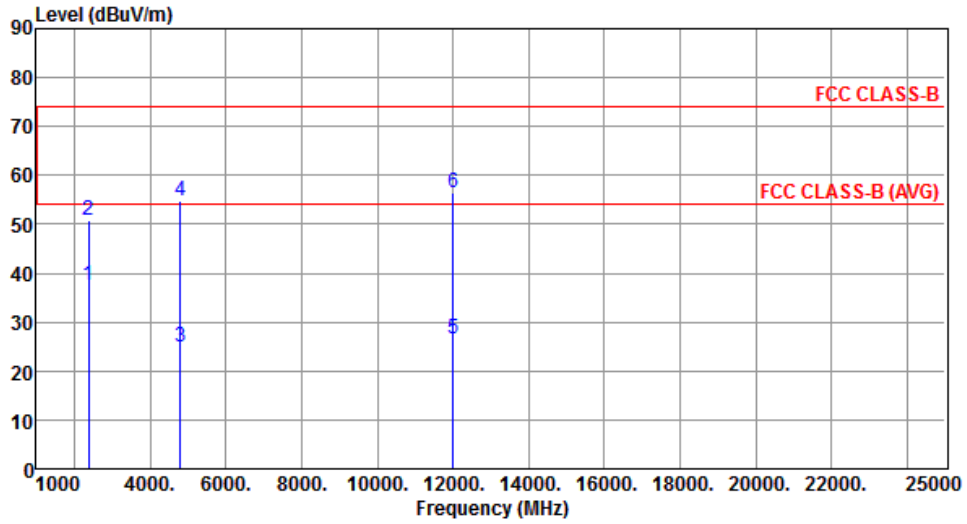

	Freq. MHz	Emission level dBuV/m	Limit dBuV/m	Margin dB	SA reading dBuV	Factor dB	Remark	ANT High cm	Turn Table deg
1	2390.00	37.51	54.00	-16.49	40.33	-2.82	Average	138	229
2	2390.00	50.82	74.00	-23.18	53.64	-2.82	Peak	138	229
3	4804.00	24.80	54.00	-29.20	21.29	3.51	Average	220	214
4	4804.00	54.90	74.00	-19.10	51.39	3.51	Peak	220	214
5	12010.00	26.47	54.00	-27.53	12.55	13.92	Average	215	211
6	12010.00	56.57	74.00	-17.43	42.65	13.92	Peak	215	211

Note 1: Emission Level (dBuV/m) = SA Reading (dBuV/m) + Factor* (dB)

*Factor includes antenna factor , cable loss and amplifier gain

Note 2: Margin (dB) = Emission level (dBuV/m) – Limit (dBuV/m).

Modulation	GFSK	Test Freq. (MHz)	2441
Polarization	Horizontal		

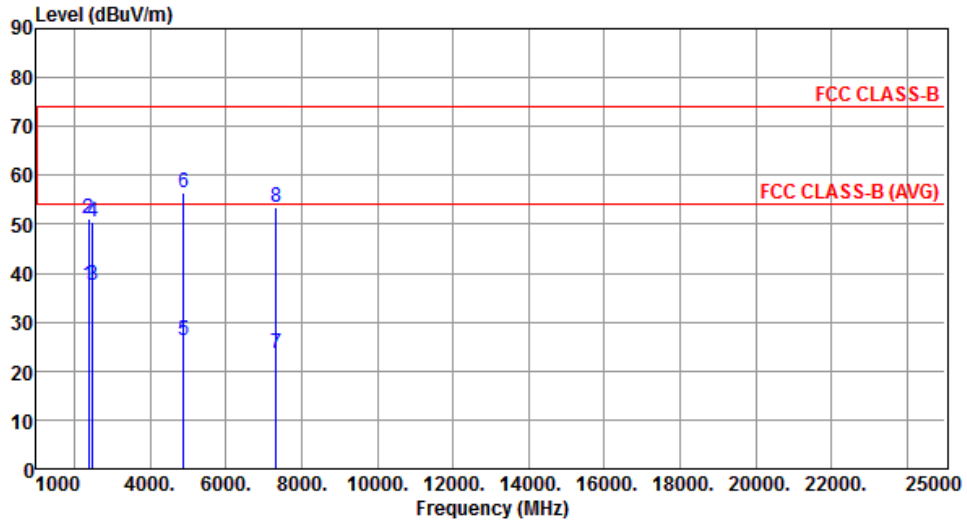

	Freq. MHz	Emission level dBuV/m	Limit dBuV/m	Margin dB	SA reading dBuV	Factor dB	Remark	ANT High cm	Turn Table deg
1	2390.00	37.52	54.00	-16.48	40.34	-2.82	Average	125	225
2	2390.00	51.29	74.00	-22.71	54.11	-2.82	Peak	125	225
3	2483.50	37.62	54.00	-16.38	40.52	-2.90	Average	125	225
4	2483.50	50.43	74.00	-23.57	53.33	-2.90	Peak	125	225
5	4882.00	26.25	54.00	-27.75	22.82	3.43	Average	134	242
6	4882.00	56.35	74.00	-17.65	52.92	3.43	Peak	134	242
7	7323.00	23.48	54.00	-30.52	14.23	9.25	Average	119	202
8	7323.00	53.58	74.00	-20.42	44.33	9.25	Peak	119	202

Note 1: Emission Level (dBuV/m) = SA Reading (dBuV/m) + Factor* (dB)

*Factor includes antenna factor , cable loss and amplifier gain

Note 2: Margin (dB) = Emission level (dBuV/m) – Limit (dBuV/m).

Modulation	GFSK	Test Freq. (MHz)	2441
Polarization	Vertical		

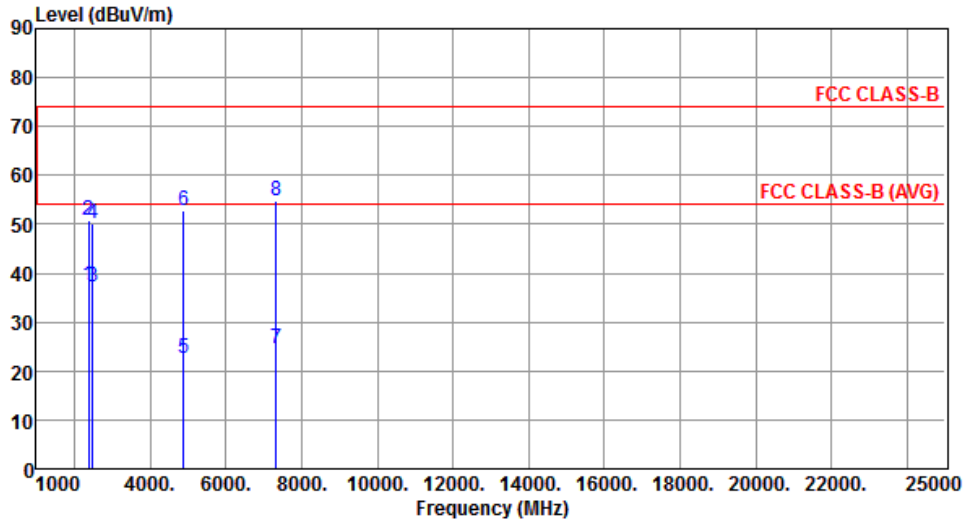

	Freq. MHz	Emission level dBuV/m	Limit dBuV/m	Margin dB	SA reading dBuV	Factor dB	Remark	ANT High cm	Turn Table deg
1	2390.00	37.44	54.00	-16.56	40.26	-2.82	Average	138	226
2	2390.00	50.74	74.00	-23.26	53.56	-2.82	Peak	138	226
3	2483.50	37.35	54.00	-16.65	40.25	-2.90	Average	138	226
4	2483.50	50.26	74.00	-23.74	53.16	-2.90	Peak	138	226
5	4882.00	22.68	54.00	-31.32	19.25	3.43	Average	216	216
6	4882.00	52.78	74.00	-21.22	49.35	3.43	Peak	216	216
7	7323.00	24.72	54.00	-29.28	15.47	9.25	Average	107	276
8	7323.00	54.82	74.00	-19.18	45.57	9.25	Peak	107	276

Note 1: Emission Level (dBuV/m) = SA Reading (dBuV/m) + Factor* (dB)

*Factor includes antenna factor , cable loss and amplifier gain

Note 2: Margin (dB) = Emission level (dBuV/m) – Limit (dBuV/m).

Modulation	GFSK	Test Freq. (MHz)	2480
Polarization	Horizontal		

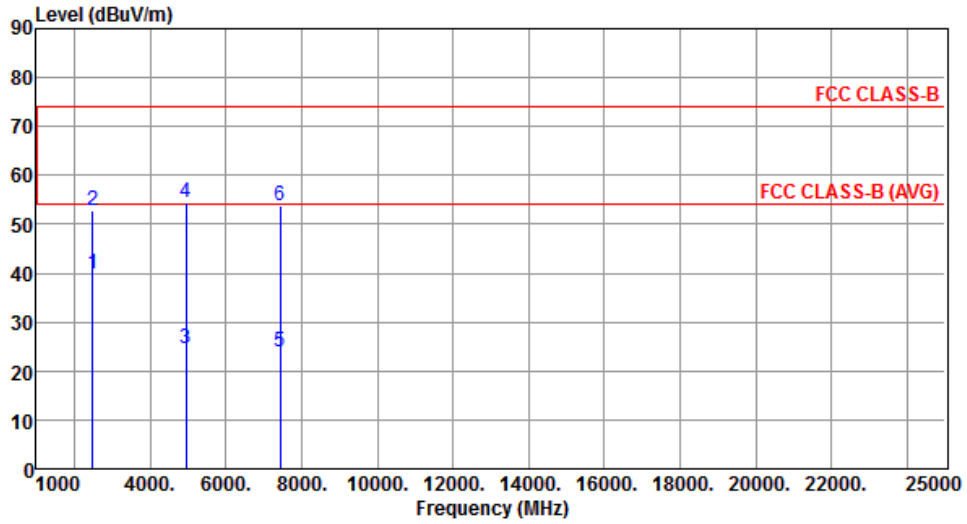

	Freq. MHz	Emission level dBuV/m	Limit dBuV/m	Margin dB	SA reading dBuV	Factor dB	Remark	ANT High cm	Turn Table deg
1	2483.50	39.88	54.00	-14.12	42.78	-2.90	Average	124	228
2	2483.50	52.89	74.00	-21.11	55.79	-2.90	Peak	124	228
3	4960.00	24.46	54.00	-29.54	20.65	3.81	Average	139	281
4	4960.00	54.56	74.00	-19.44	50.75	3.81	Peak	139	281
5	7440.00	23.76	54.00	-30.24	14.69	9.07	Average	121	199
6	7440.00	53.86	74.00	-20.14	44.79	9.07	Peak	121	199

Note 1: Emission Level (dBuV/m) = SA Reading (dBuV/m) + Factor* (dB)

*Factor includes antenna factor , cable loss and amplifier gain

Note 2: Margin (dB) = Emission level (dBuV/m) – Limit (dBuV/m).

Modulation	GFSK	Test Freq. (MHz)	2480
Polarization	Vertical		

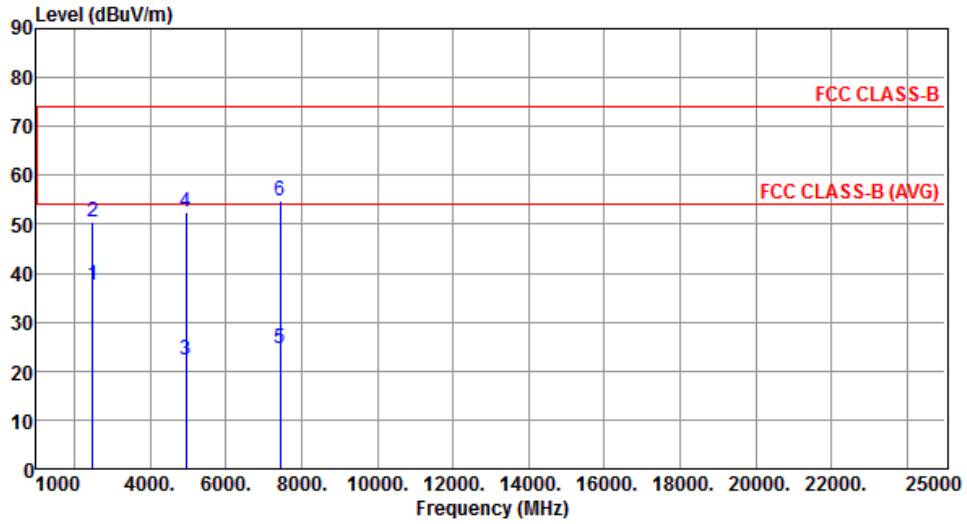

	Freq. MHz	Emission level dBuV/m	Limit dBuV/m	Margin dB	SA reading dBuV	Factor dB	Remark	ANT High cm	Turn Table deg
1	2483.50	37.46	54.00	-16.54	40.36	-2.90	Average	136	229
2	2483.50	50.39	74.00	-23.61	53.29	-2.90	Peak	136	229
3	4960.00	22.35	54.00	-31.65	18.54	3.81	Average	213	218
4	4960.00	52.45	74.00	-21.55	48.64	3.81	Peak	213	218
5	7440.00	24.59	54.00	-29.41	15.52	9.07	Average	108	281
6	7440.00	54.69	74.00	-19.31	45.62	9.07	Peak	108	281

Note 1: Emission Level (dBuV/m) = SA Reading (dBuV/m) + Factor* (dB)

*Factor includes antenna factor , cable loss and amplifier gain

Note 2: Margin (dB) = Emission level (dBuV/m) – Limit (dBuV/m).

3.2.6 Transmitter Radiated Unwanted Emissions (Above 1GHz) for 8DPSK

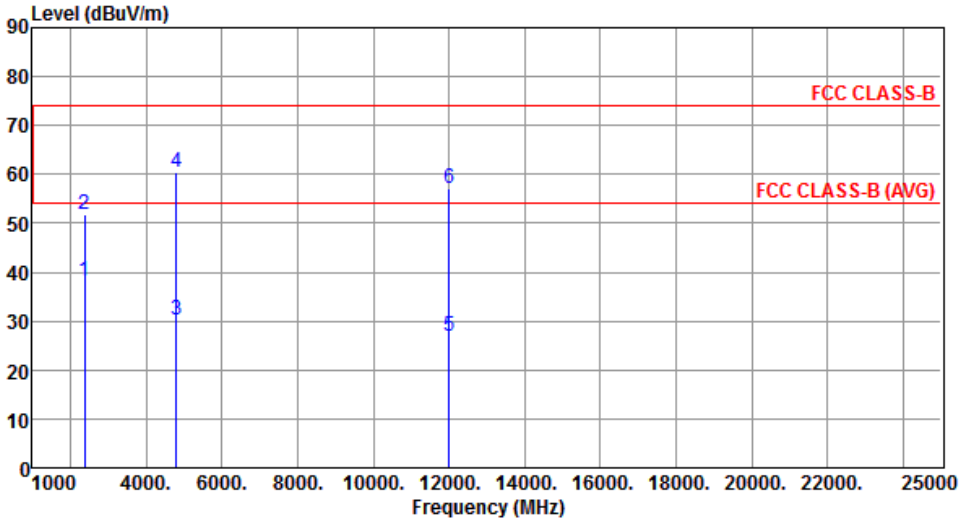
Modulation	8DPSK	Test Freq. (MHz)	2402						
Polarization	Horizontal								
									
	Freq.	Emission level	Limit	Margin	SA reading	Factor	Remark	ANT High	Turn Table
	MHz	dBuV/m	dBuV/m	dB	dBuV	dB		cm	deg
1	2390.00	38.15	54.00	-15.85	40.97	-2.82	Average	131	228
2	2390.00	51.86	74.00	-22.14	54.68	-2.82	Peak	131	228
3	4804.00	30.36	54.00	-23.64	26.85	3.51	Average	133	242
4	4804.00	60.46	74.00	-13.54	56.95	3.51	Peak	133	242
5	12010.00	27.04	54.00	-26.96	13.12	13.92	Average	133	242
6	12010.00	57.14	74.00	-16.86	43.22	13.92	Peak	133	242
<p>Note 1: Emission Level (dBuV/m) = SA Reading (dBuV/m) + Factor* (dB) *Factor includes antenna factor , cable loss and amplifier gain Note 2: Margin (dB) = Emission level (dBuV/m) – Limit (dBuV/m).</p>									

Modulation	8DPSK	Test Freq. (MHz)	2402
Polarization	Vertical		

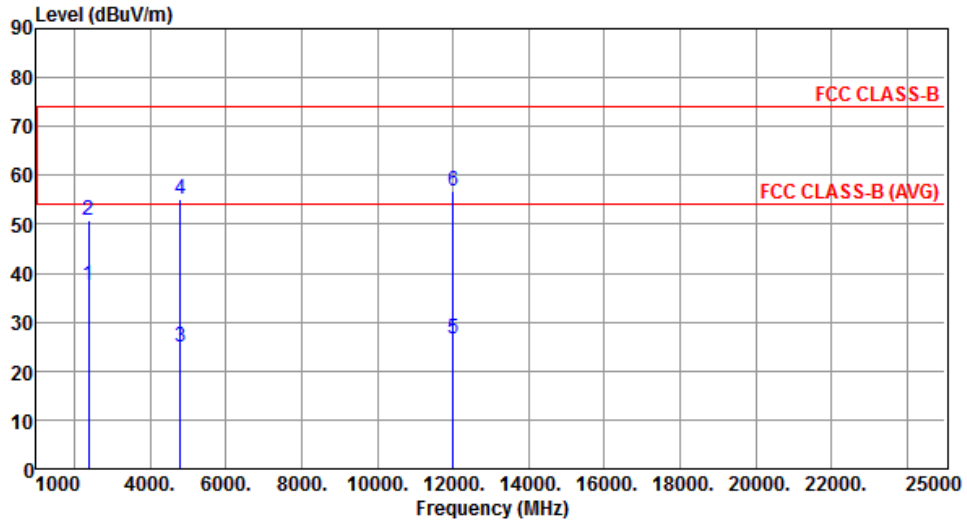

	Freq. MHz	Emission level dBuV/m	Limit dBuV/m	Margin dB	SA reading dBuV	Factor dB	Remark	ANT High cm	Turn Table deg
1	2390.00	37.64	54.00	-16.36	40.46	-2.82	Average	139	228
2	2390.00	50.92	74.00	-23.08	53.74	-2.82	Peak	139	228
3	4804.00	24.88	54.00	-29.12	21.37	3.51	Average	222	216
4	4804.00	54.98	74.00	-19.02	51.47	3.51	Peak	222	216
5	12010.00	26.59	54.00	-27.41	12.67	13.92	Average	215	213
6	12010.00	56.69	74.00	-17.31	42.77	13.92	Peak	215	213

Note 1: Emission Level (dBuV/m) = SA Reading (dBuV/m) + Factor* (dB)

*Factor includes antenna factor , cable loss and amplifier gain

Note 2: Margin (dB) = Emission level (dBuV/m) – Limit (dBuV/m).

Modulation	8DPSK	Test Freq. (MHz)	2441
Polarization	Horizontal		

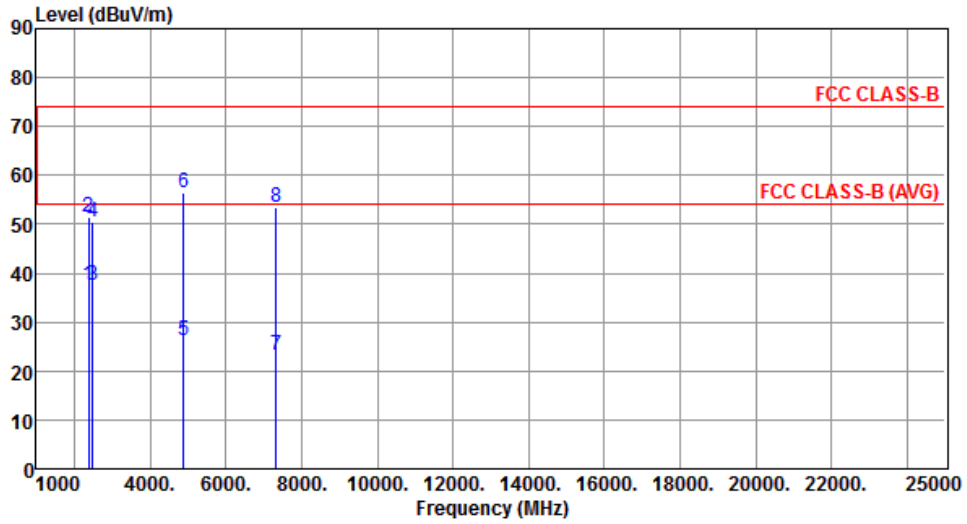

	Freq. MHz	Emission level dBuV/m	Limit dBuV/m	Margin dB	SA reading dBuV	Factor dB	Remark	ANT High cm	Turn Table deg
1	2390.00	37.56	54.00	-16.44	40.38	-2.82	Average	125	226
2	2390.00	51.35	74.00	-22.65	54.17	-2.82	Peak	125	226
3	2483.50	37.66	54.00	-16.34	40.56	-2.90	Average	125	226
4	2483.50	50.58	74.00	-23.42	53.48	-2.90	Peak	125	226
5	4882.00	26.31	54.00	-27.69	22.88	3.43	Average	136	245
6	4882.00	56.41	74.00	-17.59	52.98	3.43	Peak	136	245
7	7323.00	23.39	54.00	-30.61	14.14	9.25	Average	118	206
8	7323.00	53.49	74.00	-20.51	44.24	9.25	Peak	118	206

Note 1: Emission Level (dBuV/m) = SA Reading (dBuV/m) + Factor* (dB)

*Factor includes antenna factor , cable loss and amplifier gain

Note 2: Margin (dB) = Emission level (dBuV/m) – Limit (dBuV/m).

Modulation	8DPSK	Test Freq. (MHz)	2441
Polarization	Vertical		

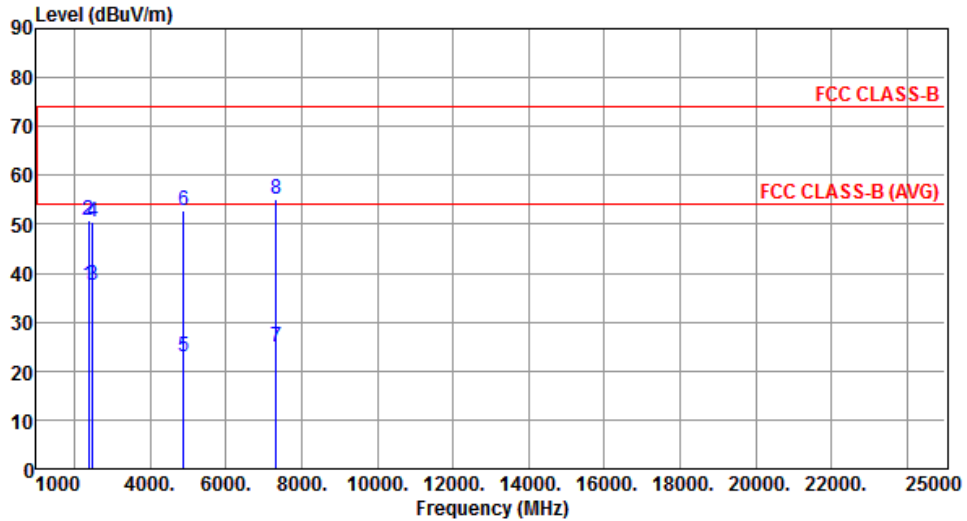

	Freq. MHz	Emission level dBuV/m	Limit dBuV/m	Margin dB	SA reading dBuV	Factor dB	Remark	ANT High cm	Turn Table deg
1	2390.00	37.45	54.00	-16.55	40.27	-2.82	Average	136	225
2	2390.00	50.72	74.00	-23.28	53.54	-2.82	Peak	136	225
3	2483.50	37.46	54.00	-16.54	40.36	-2.90	Average	136	225
4	2483.50	50.38	74.00	-23.62	53.28	-2.90	Peak	136	225
5	4882.00	22.76	54.00	-31.24	19.33	3.43	Average	216	211
6	4882.00	52.86	74.00	-21.14	49.43	3.43	Peak	216	211
7	7323.00	24.88	54.00	-29.12	15.63	9.25	Average	109	271
8	7323.00	54.98	74.00	-19.02	45.73	9.25	Peak	109	271

Note 1: Emission Level (dBuV/m) = SA Reading (dBuV/m) + Factor* (dB)

*Factor includes antenna factor , cable loss and amplifier gain

Note 2: Margin (dB) = Emission level (dBuV/m) – Limit (dBuV/m).

Modulation	8DPSK	Test Freq. (MHz)	2480
Polarization	Horizontal		

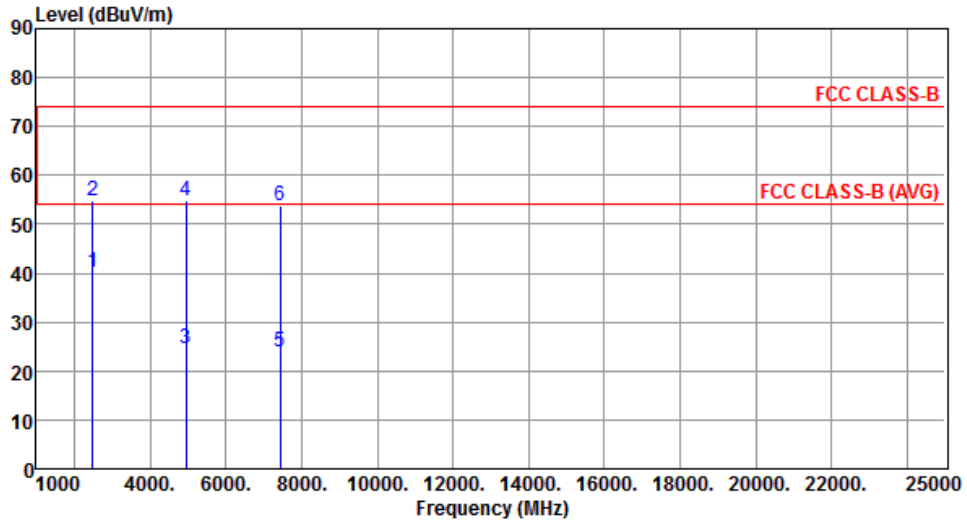

	Freq. MHz	Emission level dBuV/m	Limit dBuV/m	Margin dB	SA reading dBuV	Factor dB	Remark	ANT High cm	Turn Table deg
1	2483.50	40.22	54.00	-13.78	43.12	-2.90	Average	124	229
2	2483.50	54.93	74.00	-19.07	57.83	-2.90	Peak	124	229
3	4960.00	24.54	54.00	-29.46	20.73	3.81	Average	133	283
4	4960.00	54.64	74.00	-19.36	50.83	3.81	Peak	133	283
5	7440.00	23.82	54.00	-30.18	14.75	9.07	Average	125	204
6	7440.00	53.92	74.00	-20.08	44.85	9.07	Peak	125	204

Note 1: Emission Level (dBuV/m) = SA Reading (dBuV/m) + Factor* (dB)

*Factor includes antenna factor , cable loss and amplifier gain

Note 2: Margin (dB) = Emission level (dBuV/m) – Limit (dBuV/m).

Modulation	8DPSK	Test Freq. (MHz)	2480
Polarization	Vertical		

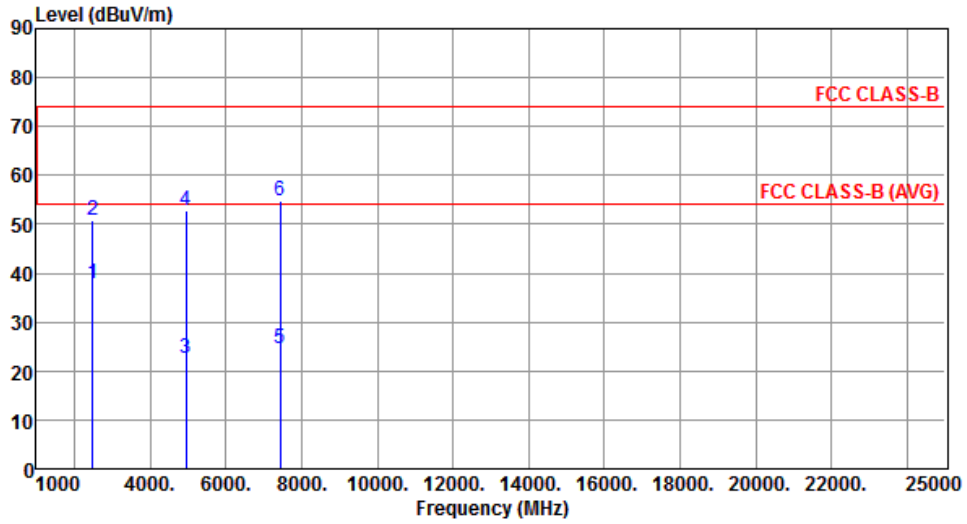

	Freq. MHz	Emission level dBuV/m	Limit dBuV/m	Margin dB	SA reading dBuV	Factor dB	Remark	ANT High cm	Turn Table deg
1	2483.50	37.81	54.00	-16.19	40.71	-2.90	Average	134	236
2	2483.50	50.96	74.00	-23.04	53.86	-2.90	Peak	134	236
3	4960.00	22.55	54.00	-31.45	18.74	3.81	Average	216	215
4	4960.00	52.65	74.00	-21.35	48.84	3.81	Peak	216	215
5	7440.00	24.71	54.00	-29.29	15.64	9.07	Average	109	276
6	7440.00	54.81	74.00	-19.19	45.74	9.07	Peak	109	276

Note 1: Emission Level (dBuV/m) = SA Reading (dBuV/m) + Factor* (dB)

*Factor includes antenna factor , cable loss and amplifier gain

Note 2: Margin (dB) = Emission level (dBuV/m) – Limit (dBuV/m).

3.3 Unwanted Emissions into Non-Restricted Frequency Bands

3.3.1 Limit of Unwanted Emissions into Non-Restricted Frequency Bands

Peak power in any 100 kHz bandwidth outside of the authorized frequency band shall be attenuated by at least 20 dB relative to the maximum in-band peak PSD level in 100 kHz.

3.3.2 Test Procedures

Reference level measurement

1. Set RBW=100kHz, VBW = 300kHz , Detector = Peak, Sweep time = Auto
2. Trace = max hold , Allow Trace to fully stabilize
3. Use the peak marker function to determine the maximum PSD level

Emission level measurement

1. Set RBW=100kHz, VBW = 300kHz , Detector = Peak, Sweep time = Auto
2. Trace = max hold , Allow Trace to fully stabilize
3. Scan Frequency range is up to 25GHz
4. Use the peak marker function to determine the maximum amplitude level

3.3.3 Test Setup

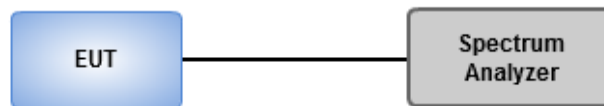

3.3.4 Unwanted Emissions into Non-Restricted Frequency Bands

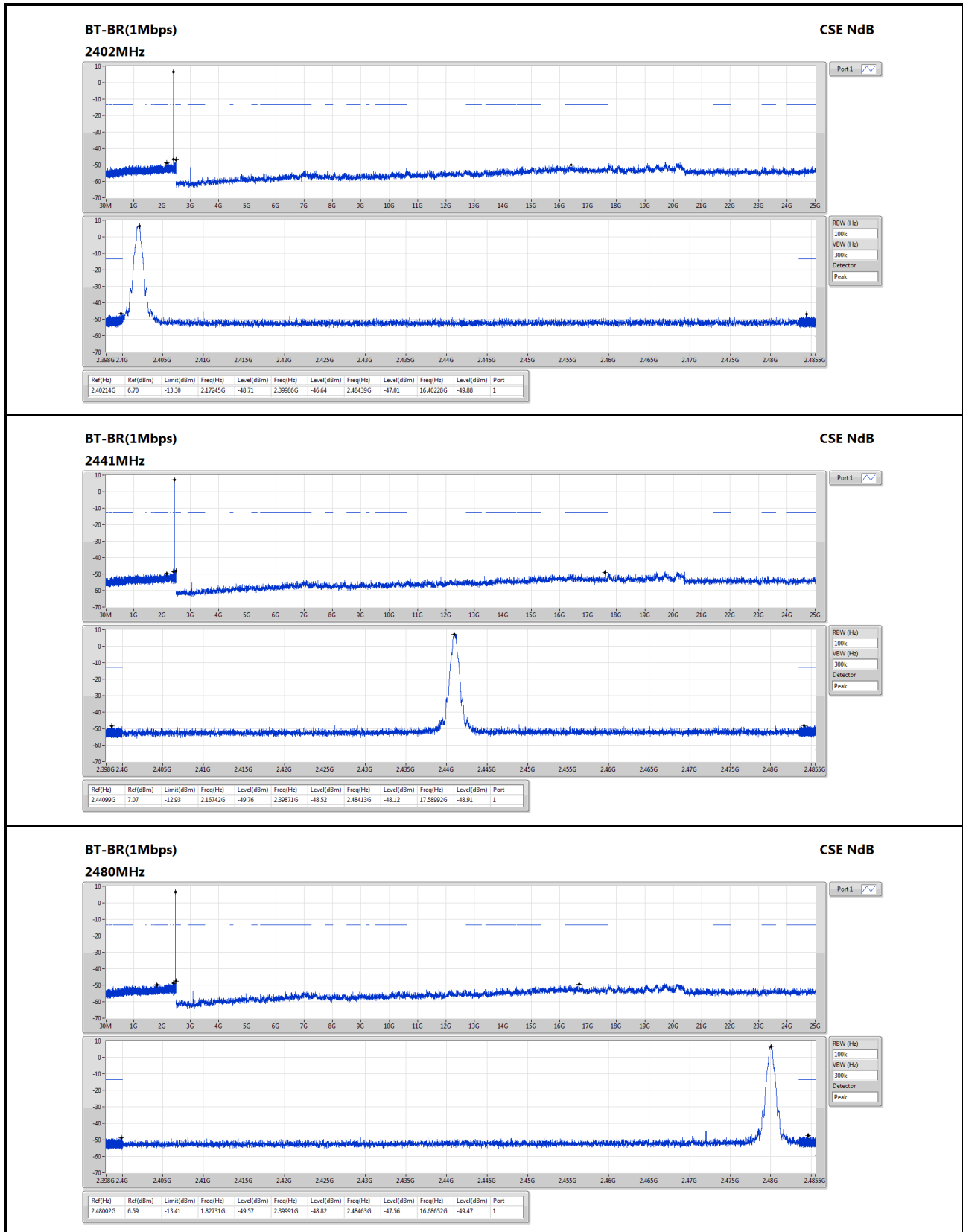

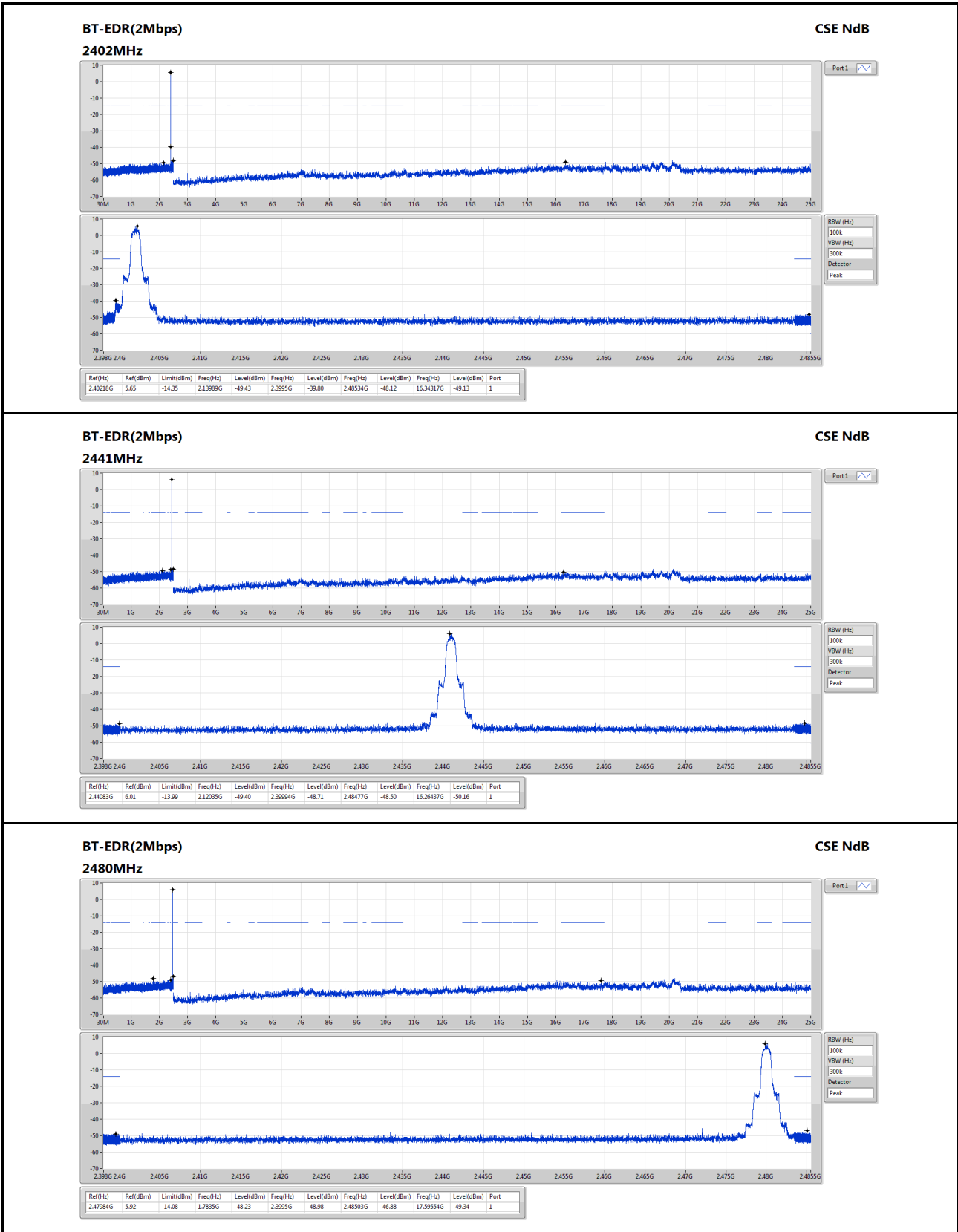

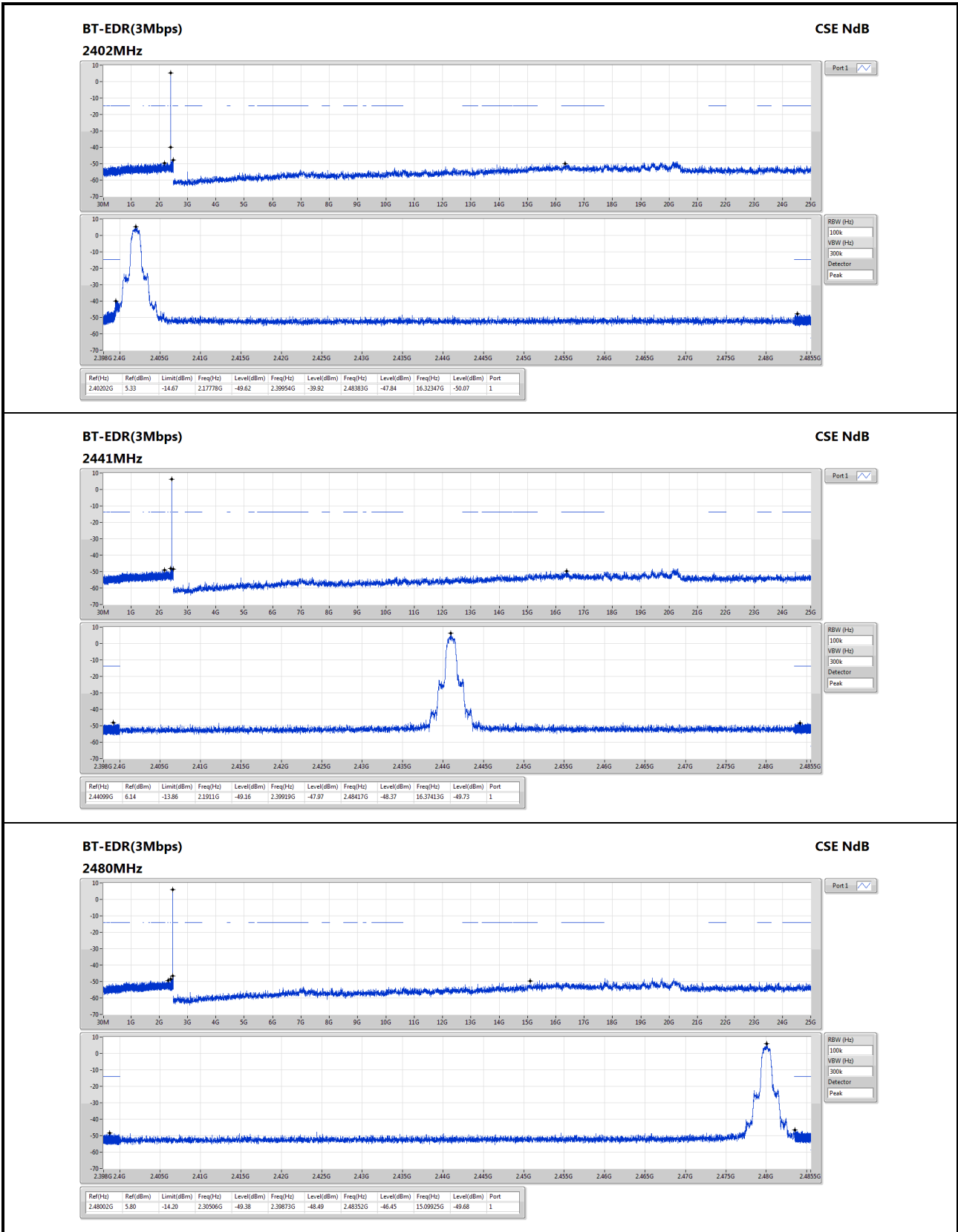

BT-BR(1Mbps)
2441MHz
Hopping Ch Bandedge (Non-restricted Band)

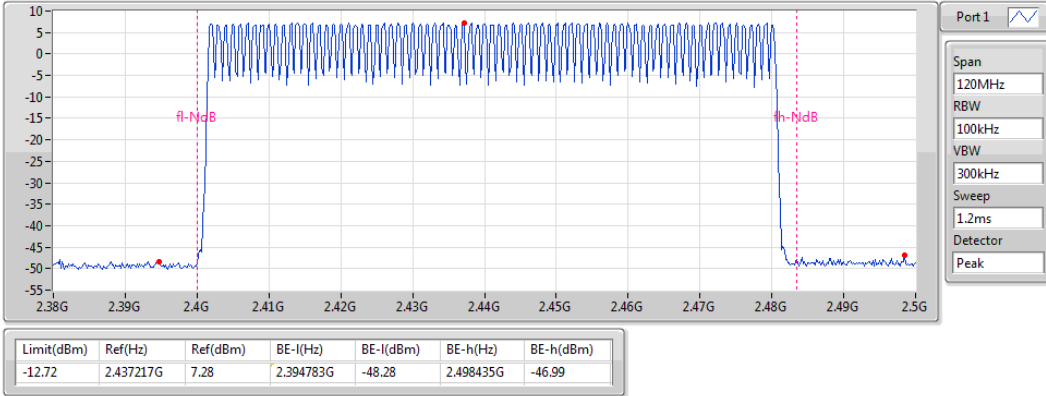

BT-EDR(2Mbps)
2441MHz
Hopping Ch Bandedge (Non-restricted Band)

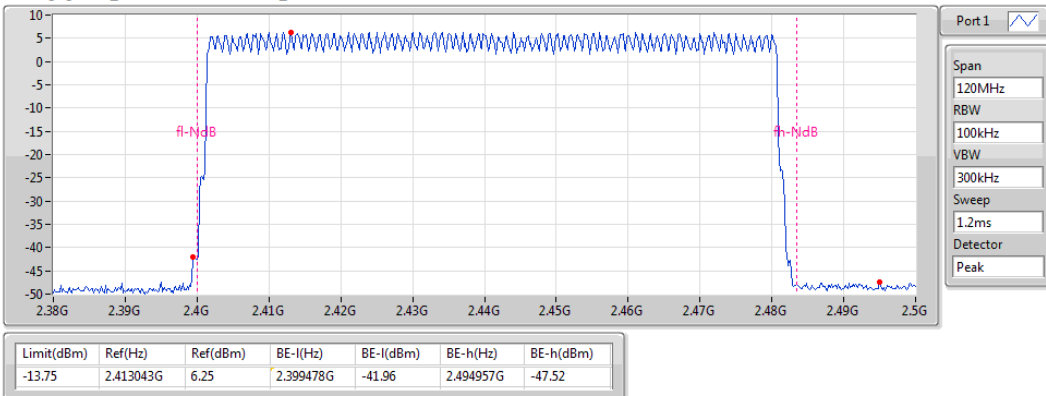

BT-EDR(3Mbps)
2441MHz
Hopping Ch Bandedge (Non-restricted Band)

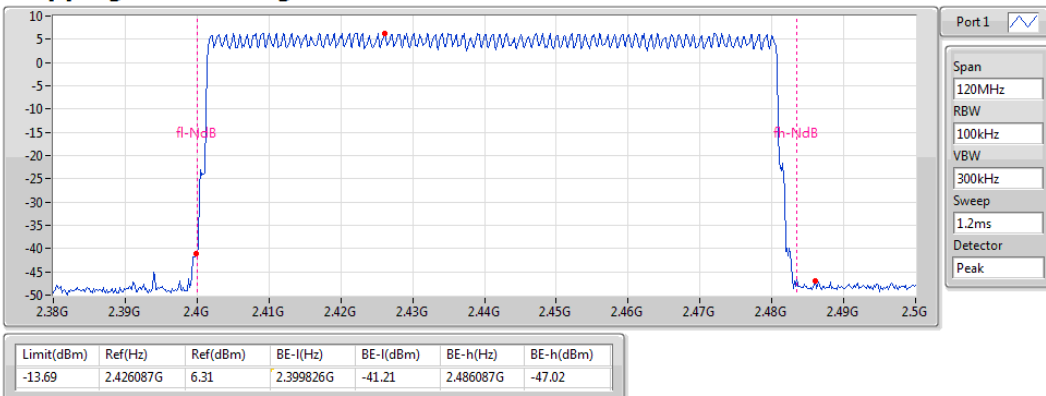

3.4 Conducted Output Power

3.4.1 Limit of Conducted Output Power

- 1 Watt
For frequency hopping systems operating in the 2400–2483.5 MHz band employing at least 75 non overlapping hopping channels, and all frequency hopping systems in the 5725–5850 MHz band.
- 0.125 Watt
For all other frequency hopping systems in the 2400–2483.5 MHz band.
- 0.125 Watt
For Frequency hopping systems operating in the 2400–2483.5 MHz band have hopping channel carrier frequencies that are separated by two-thirds of the 20 dB bandwidth of the hopping channel.

3.4.2 Test Procedures

1. A wideband power meter is used for power measurement. Bandwidth of power sensor and meter is 50MHz
2. If duty cycle of test signal is not 100 %, trigger and gating function of power meter will be enabled to capture transmission burst for measuring output power

3.4.3 Test Setup

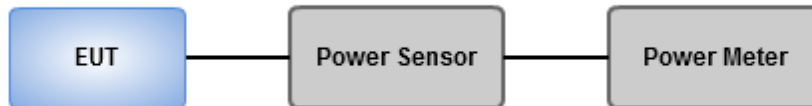

3.4.4 Test Result of Conducted Output Power

Summary of Peak Conducted Output Power

Mode	Power (dBm)	Power (W)
2.4-2.4835GHz	-	-
BT-BR(1Mbps)	8.29	0.00675
BT-EDR(2Mbps)	9.96	0.00991
BT-EDR(3Mbps)	10.66	0.01164

Result

Mode	Result	Gain (dBi)	Power (dBm)	Power Limit (dBm)
BT-BR(1Mbps)	-	-	-	-
2402MHz	Pass	2.00	8.19	21.00
2441MHz	Pass	2.00	8.29	21.00
2480MHz	Pass	2.00	8.12	21.00
BT-EDR(2Mbps)	-	-	-	-
2402MHz	Pass	2.00	9.84	21.00
2441MHz	Pass	2.00	9.96	21.00
2480MHz	Pass	2.00	9.81	21.00
BT-EDR(3Mbps)	-	-	-	-
2402MHz	Pass	2.00	10.51	21.00
2441MHz	Pass	2.00	10.66	21.00
2480MHz	Pass	2.00	10.53	21.00

Summary of Conducted (Average) Output Power

Mode	Power (dBm)	Power (W)
2.4-2.4835GHz	-	-
BT-BR(1Mbps)	8.22	0.00664
BT-EDR(2Mbps)	7.21	0.00526
BT-EDR(3Mbps)	7.22	0.00527

Result

Mode	Result	Gain (dBi)	Power (dBm)	Power Limit (dBm)
BT-BR(1Mbps)	-	-	-	-
2402MHz	Pass	2.00	8.11	-
2441MHz	Pass	2.00	8.22	-
2480MHz	Pass	2.00	8.05	-
BT-EDR(2Mbps)	-	-	-	-
2402MHz	Pass	2.00	7.09	-
2441MHz	Pass	2.00	7.21	-
2480MHz	Pass	2.00	7.03	-
BT-EDR(3Mbps)	-	-	-	-
2402MHz	Pass	2.00	7.10	-
2441MHz	Pass	2.00	7.22	-
2480MHz	Pass	2.00	7.04	-

Note: Average power is for reference only.

3.5 Number of Hopping Frequency

3.5.1 Limit of Number of Hopping Frequency

Frequency hopping systems in the 2400–2483.5 MHz band shall use at least 15 channels.

3.5.2 Test Procedures

1. Set RBW = 100kHz, VBW = 300kHz, Sweep time = Auto, Detector = Peak Trace max hold.
2. Allow trace to stabilize.

3.5.3 Test Setup

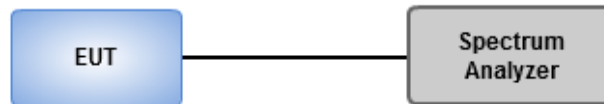

3.5.4 Test Result of Number of Hopping Frequency

Summary

Mode	Max-Hop No
2.4-2.4835GHz	-
BT-BR(1Mbps)	79
BT-EDR(2Mbps)	79
BT-EDR(3Mbps)	79

Result

Mode	Result	Hopping No	Limit
BT-BR(1Mbps)	-	-	-
2441MHz	Pass	79	15
BT-EDR(2Mbps)	-	-	-
2441MHz	Pass	79	15
BT-EDR(3Mbps)	-	-	-
2441MHz	Pass	79	15

BT-BR(1Mbps)
2441MHz

Hopping Ch

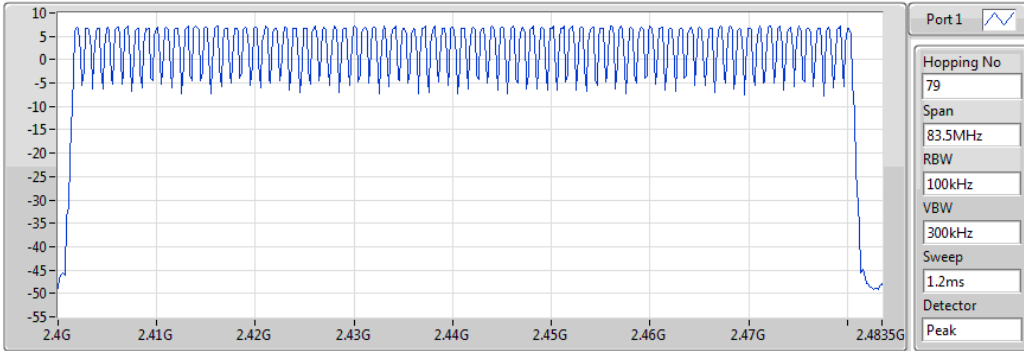

Port 1 

Hopping No
79

Span
83.5MHz

RBW
100kHz

VBW
300kHz

Sweep
1.2ms

Detector
Peak

Hopping No	Limit
79	15

BT-EDR(2Mbps)
2441MHz

Hopping Ch

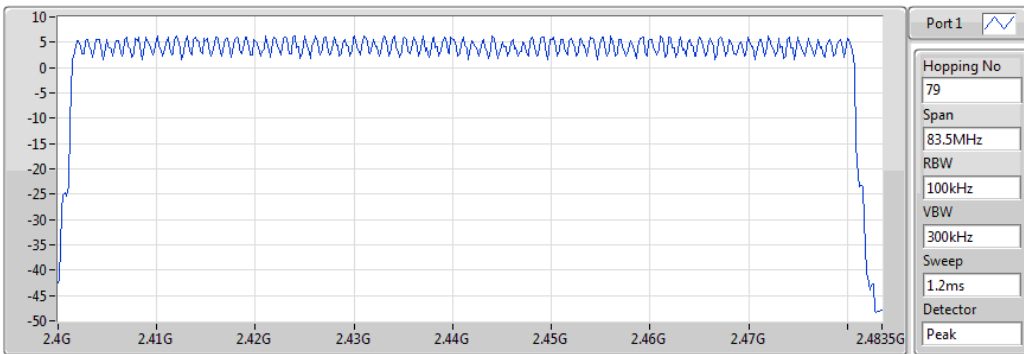

Port 1 

Hopping No
79

Span
83.5MHz

RBW
100kHz

VBW
300kHz

Sweep
1.2ms

Detector
Peak

Hopping No	Limit
79	15

BT-EDR(3Mbps)
2441MHz

Hopping Ch

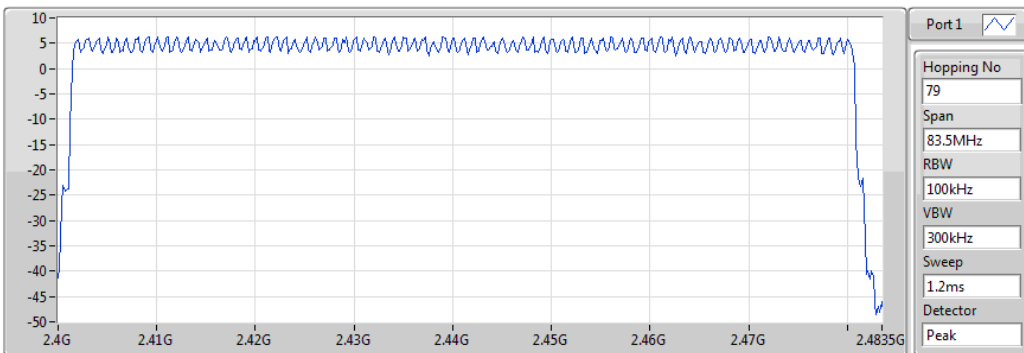

Port 1 

Hopping No
79

Span
83.5MHz

RBW
100kHz

VBW
300kHz

Sweep
1.2ms

Detector
Peak

Hopping No	Limit
79	15

3.6 20dB and Occupied Bandwidth

3.6.1 Test Procedures

20dB Bandwidth

1. Set RBW=10kHz VBW= 30kHz for BT BR mode, RBW=20kHz, VBW=100kHz for other modes, Sweep time = Auto, Detector=Peak , Trace max hold
2. Allow trace to stabilize
3. Measure the maximum width of the emission that is constrained by the frequencies associated with the two outermost amplitude points (upper and lower) that are attenuated by 20 dB relative to the maximum level measured in the fundamental emission.

Occupied Bandwidth

1. Set RBW=10kHz VBW= 30kHz for BT BR mode, RBW=20kHz, VBW=100kHz for other modes, Sweep time = Auto, Detector=Sample , Trace max hold
2. Allow trace to stabilize
3. Use Occupied bandwidth function of spectrum analyzer to measuring 99% occupied bandwidth

3.6.2 Test Setup

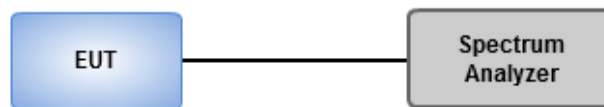

3.6.3 Test result of 20dB and Occupied Bandwidth

Summary

Mode	Max-N dB (Hz)	Max-OBW (Hz)	ITU-Code	Min-N dB (Hz)	Min-OBW (Hz)
2.4-2.4835GHz	-	-	-	-	-
BT-BR(1Mbps)	920.29k	879.161k	879KF1D	920.29k	875.543k
BT-EDR(2Mbps)	1.33M	1.23M	1M23G1D	1.326M	1.208M
BT-EDR(3Mbps)	1.348M	1.223M	1M22G1D	1.301M	1.212M

Max-N dB = Maximum 20dB down bandwidth; **Max-OBW** = Maximum 99% occupied bandwidth;
Min-N dB = Minimum 20dB down bandwidth; **Min-OBW** = Minimum 99% occupied bandwidth;

Result

Mode	Result	Limit (Hz)	Port 1-N dB (Hz)	Port 1-OBW (Hz)
BT-BR(1Mbps)	-	-	-	-
2402MHz	Pass	Inf	920.29k	875.543k
2441MHz	Pass	Inf	920.29k	879.161k
2480MHz	Pass	Inf	920.29k	875.543k
BT-EDR(2Mbps)	-	-	-	-
2402MHz	Pass	Inf	1.33M	1.208M
2441MHz	Pass	Inf	1.326M	1.23M
2480MHz	Pass	Inf	1.33M	1.226M
BT-EDR(3Mbps)	-	-	-	-
2402MHz	Pass	Inf	1.348M	1.219M
2441MHz	Pass	Inf	1.301M	1.223M
2480MHz	Pass	Inf	1.326M	1.212M

Port X-N dB = Port X 20dB down bandwidth; **Port X-OBW** = Port X 99% occupied bandwidth;

BT-BR(1Mbps)

EBW

2402MHz

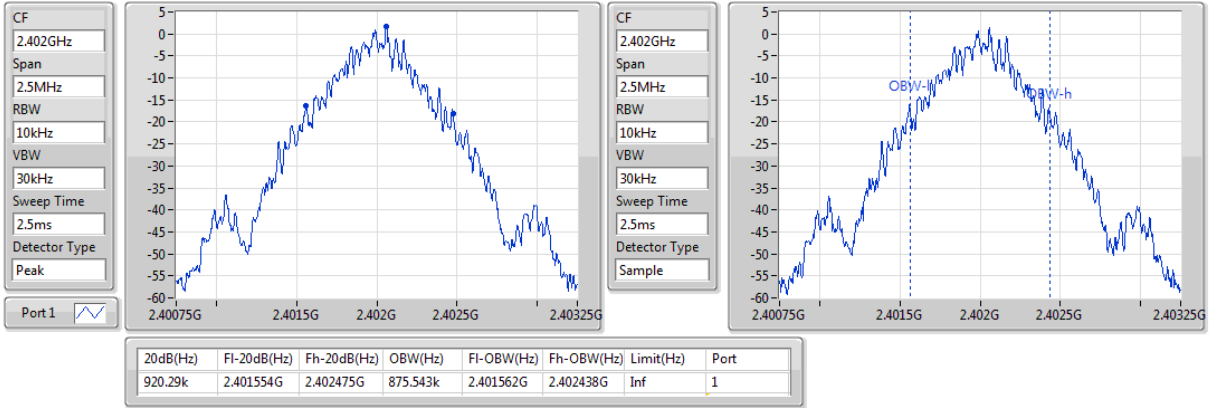

BT-BR(1Mbps)

EBW

2441MHz

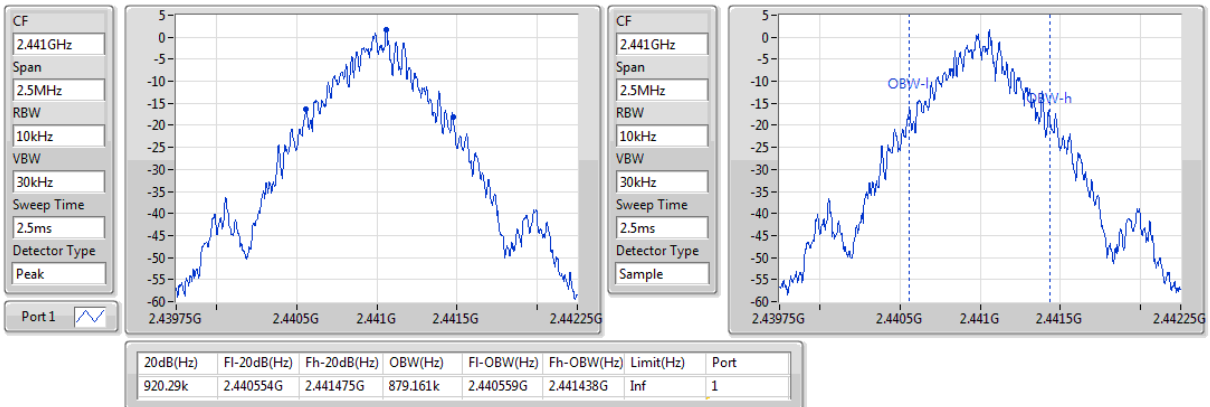

BT-BR(1Mbps)

EBW

2480MHz

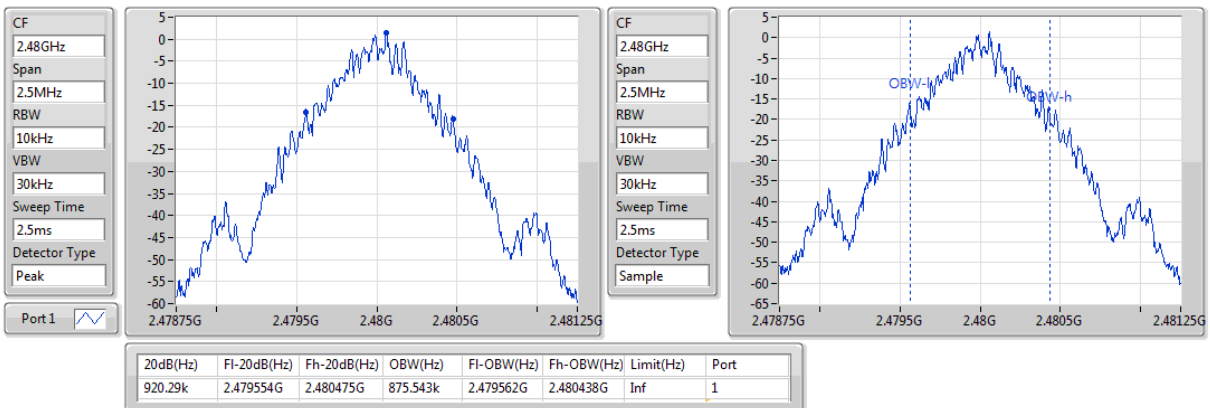

BT-EDR(2Mbps)

EBW

2402MHz

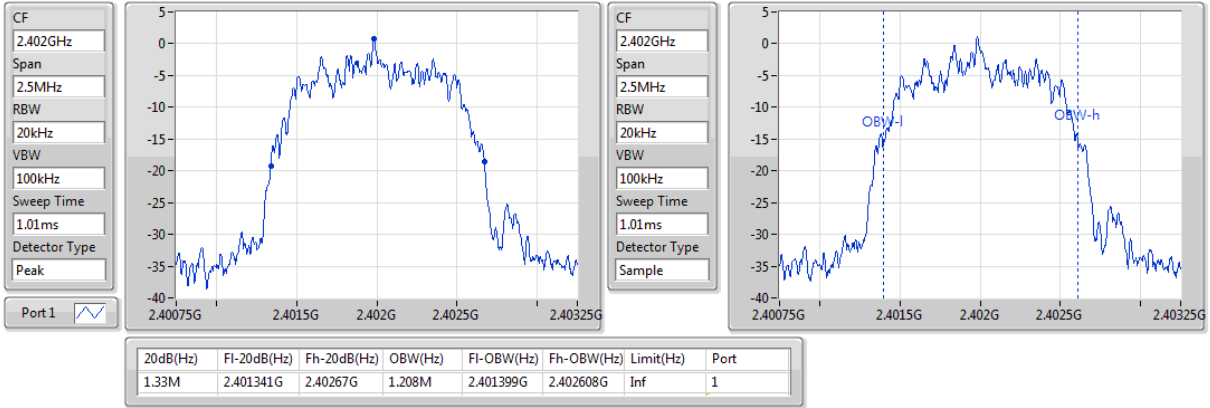

BT-EDR(2Mbps)

EBW

2441MHz

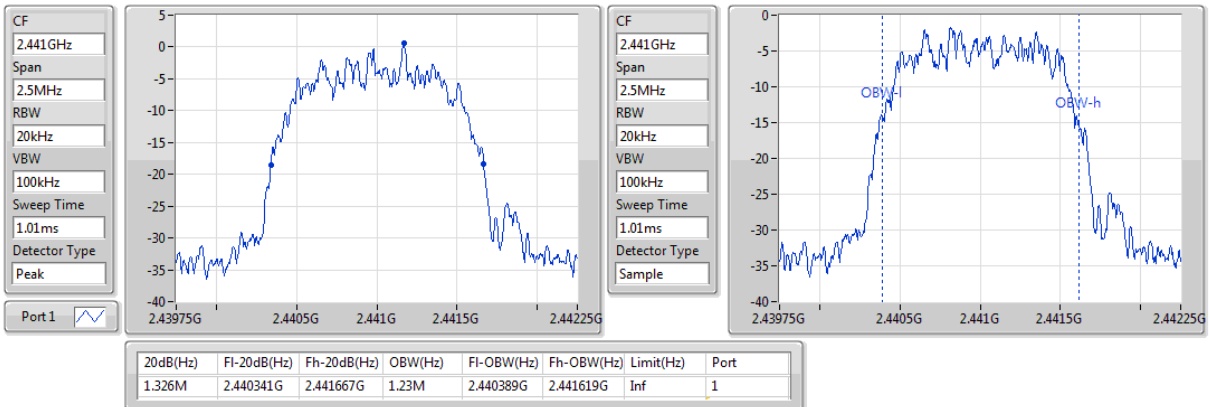

BT-EDR(2Mbps)

EBW

2480MHz

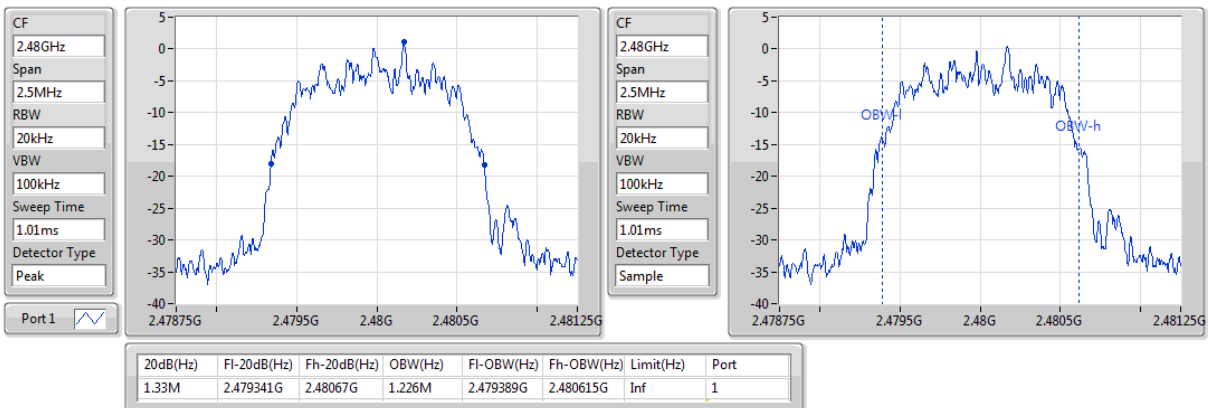

BT-EDR(3Mbps)

EBW

2402MHz

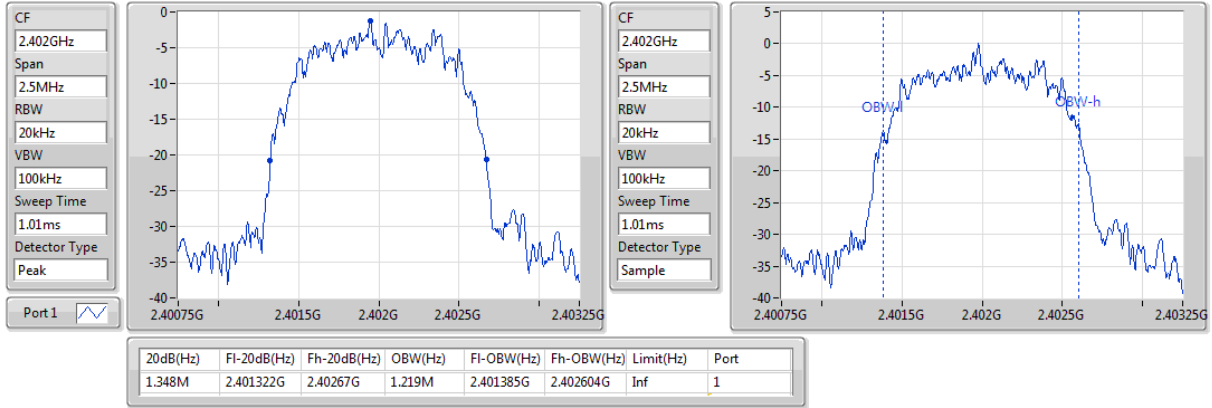

BT-EDR(3Mbps)

EBW

2441MHz

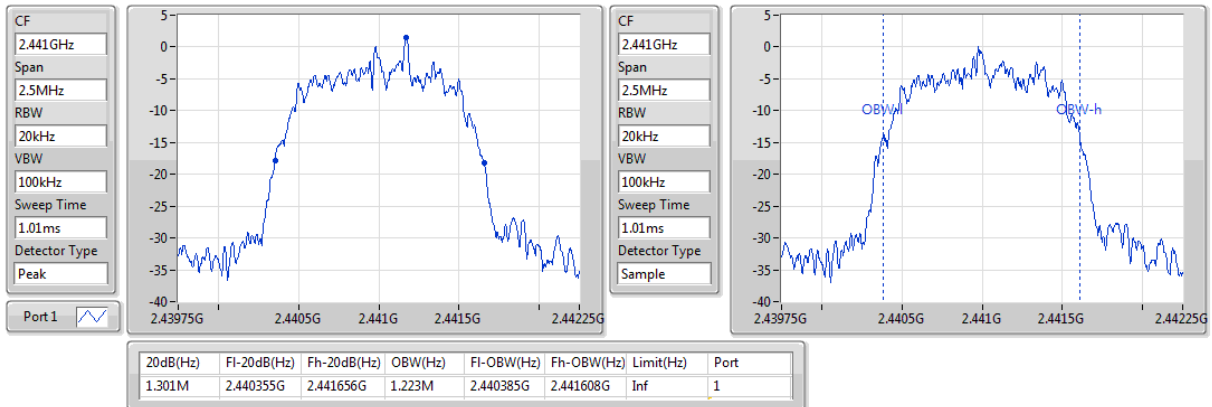

BT-EDR(3Mbps)

EBW

2480MHz

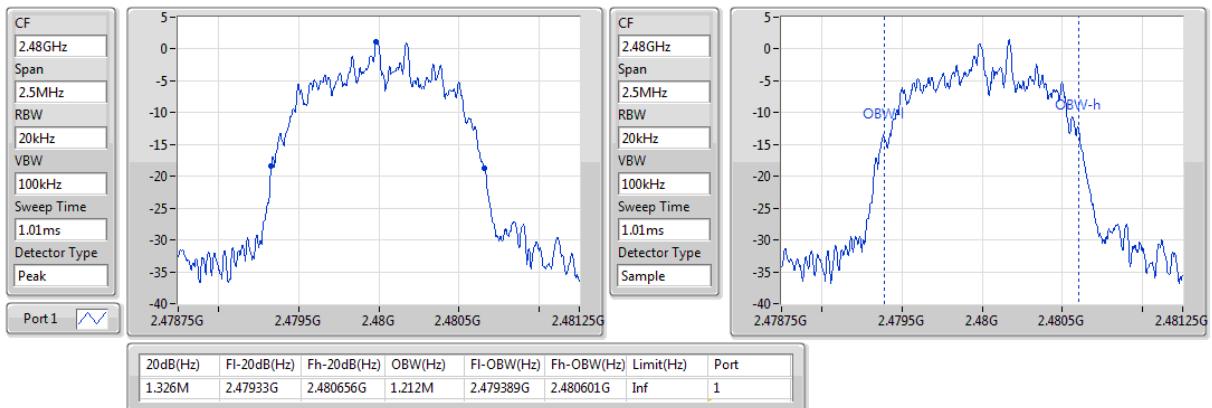

3.7 Channel Separation

3.7.1 Limit of Channel Separation

- Frequency hopping systems shall have hopping channel carrier frequencies separated by a minimum of 25 kHz or the 20 dB bandwidth of the hopping channel, whichever is greater.
- Frequency hopping systems operating in the 2400–2483.5 MHz band may have hopping channel carrier frequencies that are separated by 25 kHz or two-thirds of the 20 dB bandwidth of the hopping channel, whichever is greater.

3.7.2 Test Procedures

1. Set RBW=30kHz, VBW=100kHz, Sweep time = Auto, Detector=Peak Trace max hold
2. Allow trace to stabilize
3. Use the marker-delta function to determine the separation between the peaks of the adjacent channels. The EUT shall show compliance with the appropriate regulatory limit

3.7.3 Test Setup

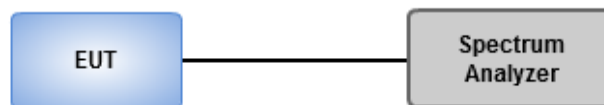

3.7.4 Test result of Channel Separation

Summary

Mode	Max-Space (Hz)	Min-Space (Hz)
2.4-2.4835GHz	-	-
BT-BR(1Mbps)	1.004348M	1M
BT-EDR(2Mbps)	1M	1M
BT-EDR(3Mbps)	1.178261M	1M

Result

Mode	Result	Fl (Hz)	Fh (Hz)	Ch.Space (Hz)	Limit (Hz)
BT-BR(1Mbps)	-	-	-	-	-
2402MHz	Pass	2.402057G	2.403061G	1.004348M	612.91314k
2441MHz	Pass	2.441061G	2.442061G	1M	612.91314k
2480MHz	Pass	2.479061G	2.480061G	1M	612.91314k
BT-EDR(2Mbps)	-	-	-	-	-
2402MHz	Pass	2.401991G	2.402991G	1M	885.78k
2441MHz	Pass	2.440991G	2.441991G	1M	883.116k
2480MHz	Pass	2.478991G	2.479991G	1M	885.78k
BT-EDR(3Mbps)	-	-	-	-	-
2402MHz	Pass	2.40217G	2.40317G	1M	897.768k
2441MHz	Pass	2.440991G	2.44217G	1.178261M	866.466k
2480MHz	Pass	2.478996G	2.479996G	1M	883.116k

BT-BR(1Mbps)

Channel Separation

2.402G/2.403GHz



F1(Hz)	Fh(Hz)	Ch.Space(Hz)	Limit(Hz)
2.402057G	2.403061G	1.004348M	612.91314k

BT-BR(1Mbps)

Channel Separation

2.441G/2.442GHz

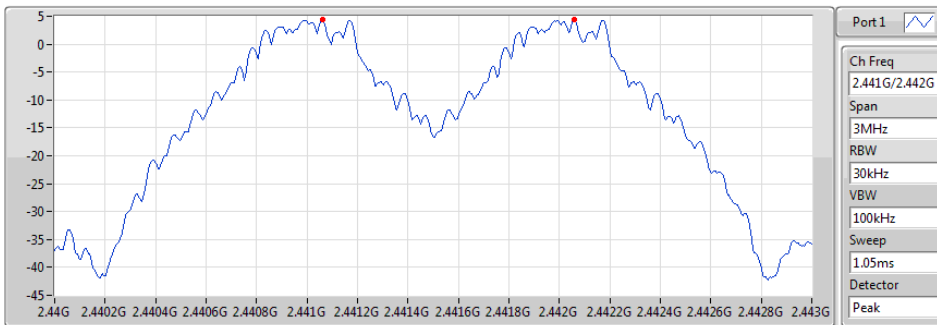

F1(Hz)	Fh(Hz)	Ch.Space(Hz)	Limit(Hz)
2.441061G	2.442061G	1M	612.91314k

BT-BR(1Mbps)

Channel Separation

2.48G/2.479GHz

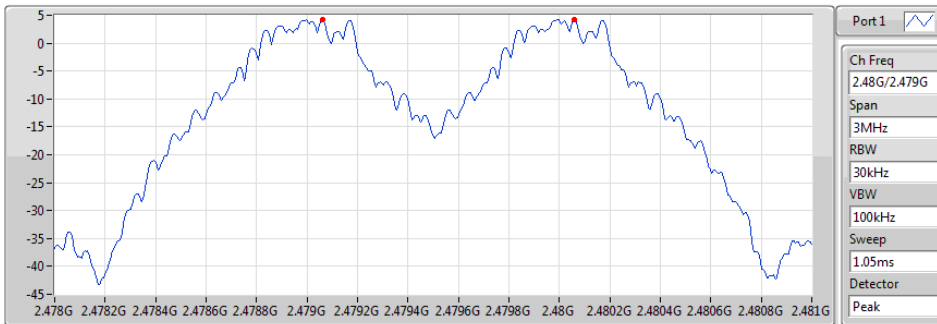

F1(Hz)	Fh(Hz)	Ch.Space(Hz)	Limit(Hz)
2.479061G	2.480061G	1M	612.91314k

BT-EDR(2Mbps)

Channel Separation

2.402G/2.403GHz

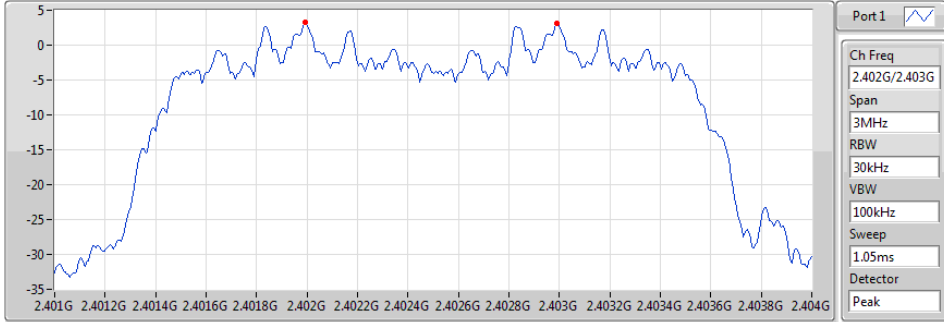

F1(Hz)	Fh(Hz)	Ch.Space(Hz)	Limit(Hz)
2.401991G	2.402991G	1M	885.78k

BT-EDR(2Mbps)

Channel Separation

2.441G/2.442GHz

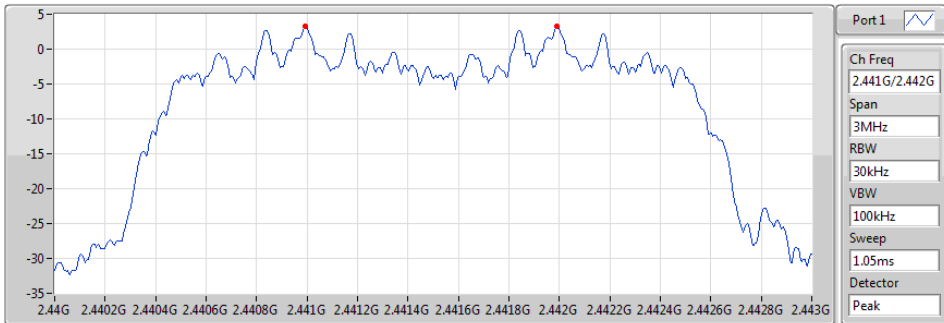

F1(Hz)	Fh(Hz)	Ch.Space(Hz)	Limit(Hz)
2.440991G	2.441991G	1M	883.116k

BT-EDR(2Mbps)

Channel Separation

2.48G/2.479GHz

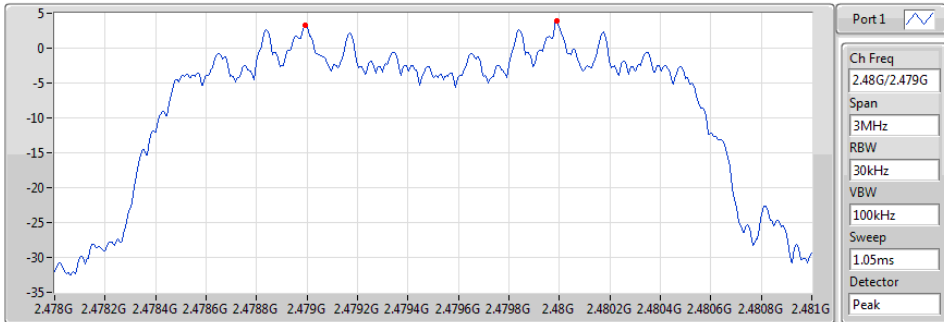

F1(Hz)	Fh(Hz)	Ch.Space(Hz)	Limit(Hz)
2.478991G	2.479991G	1M	885.78k

BT-EDR(3Mbps)

Channel Separation

2.402G/2.403GHz



Ff(Hz)	Fh(Hz)	Ch.Space(Hz)	Limit(Hz)
2.40217G	2.40317G	1M	897.768k

BT-EDR(3Mbps)

Channel Separation

2.441G/2.442GHz

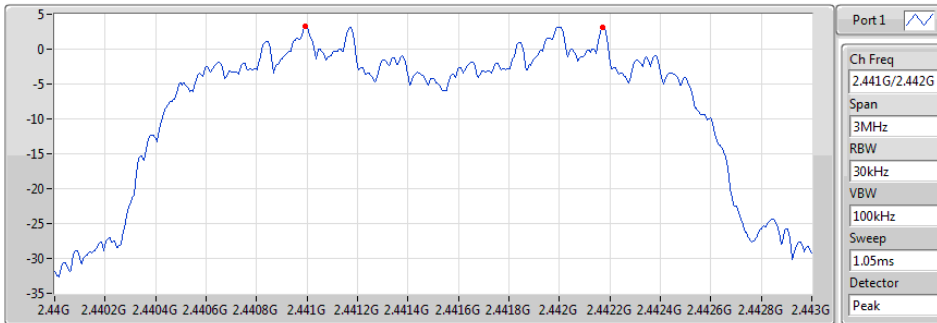

Ff(Hz)	Fh(Hz)	Ch.Space(Hz)	Limit(Hz)
2.440991G	2.44217G	1.178261M	866.466k

BT-EDR(3Mbps)

Channel Separation

2.48G/2.479GHz

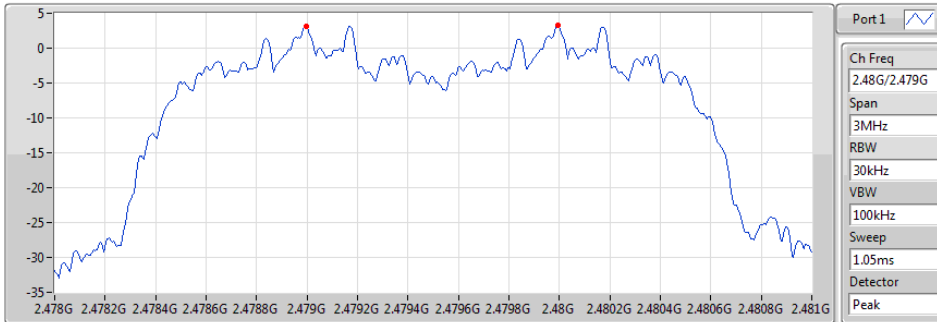

Ff(Hz)	Fh(Hz)	Ch.Space(Hz)	Limit(Hz)
2.478996G	2.479996G	1M	883.116k

3.8 Number of Dwell Time

3.8.1 Limit of Dwell time

The average time of occupancy on any channel shall not be greater than 0.4 seconds within a period of 0.4 seconds multiplied by the number of hopping channels employed.

3.8.2 Test Procedures

1. Set RBW=300kHz,VBW=1MHz,Sweep time = 10 ms, Detector=Peak, Span=0Hz,Trace max hold
2. Enable gating and trigger function of spectrum analyzer to measure burst on time.
3. The DH1 packet can cover a single time slot. A maximum length packet has duration of 1 time slots.
Non AFH mode
The hopping rate is 1600 hops/second so the maximum dwell time is 1/1600 seconds. DH1 Packet permit maximum $1600 / 79 / 2 = 10.12$ hops per second in each channel (1 time slot TX, 1 time slot RX). So, the dwell time is the time duration of the pulse times $10.12 \times 31.6 = 320$ within 31.6 seconds.
AFH mode
The hopping rate is 800 hops/second so the maximum dwell time is 1/800 seconds. DH1 Packet permit maximum $800 / 20 / 2 = 20$ hops per second in each channel (1 time slot TX, 1 time slot RX). So, the dwell time is the time duration of the pulse times $20 \times 8 = 160$ within 8 seconds.
4. The DH3 packet can cover up to 3 time slots. A maximum length packet has duration of 3 time slots.
Non AFH mode
The hopping rate is 1600 hops/second so the maximum dwell time is 3/1600 seconds. DH3 Packet permit maximum $1600 / 79 / 4 = 5.06$ hops per second in each channel (3 time slots TX, 1 time slot RX). So, the dwell time is the time duration of the pulse times $5.06 \times 31.6 = 160$ within 31.6 seconds.
AFH mode
The hopping rate is 800hops/second so the maximum dwell time is 3/800 seconds. DH3 Packet permit maximum $800 / 20 / 4 = 10$ hops per second in each channel (3 time slots TX, 1 time slot RX). So, the dwell time is the time duration of the pulse times $10 \times 8 = 80$ within 8 seconds.
5. The DH5 packet can cover up to 5 time slots. Operate DH5 at maximum dwell time and maximum duty cycle. A maximum length packet has duration of 5 time slots.
Non AFH mode
The hopping rate is 1600 hops/second so the maximum dwell time is 5/1600 seconds, or 3.125ms. DH5 Packet permit maximum $1600 / 79 / 6 = 3.37$ hops per second in each channel (5 time slots TX, 1 time slot RX). So, the dwell time is the time duration of the pulse times $3.37 \times 31.6 = 106.6$ within 31.6 seconds
AFH mode
The hopping rate is 800 hops/second so the maximum dwell time is 5/800 seconds. DH5 Packet permit maximum $800 / 20 / 6 = 6.667$ hops per second in each channel (5 time slots TX, 1 time slot RX). So, the dwell time is the time duration of the pulse times $6.667 \times 8 = 53.33$ within 8 seconds

3.8.3 Test Setup

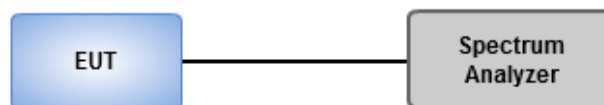

3.8.4 Test Result of Dwell Time

Summary

Mode	Max-Dwell (s)
2.4-2.4835GHz	-
BT-BR(1Mbps)	310.530435m_DH5
BT-EDR(2Mbps)	310.530435m_DH5
BT-EDR(3Mbps)	310.530435m_DH5

Result/ Non AFH mode

Mode	Result	Period (s)	Dwell (s)	Limit (s)	Tx On (s)
BT-BR(1Mbps)	-	-	-	-	-
2441MHz	Pass	31.6	310.530435m_DH5	400m	2.913043m
2441MHz	Pass	31.6	266.666667m_DH3	400m	1.666667m
2441MHz	Pass	31.6	129.855072m_DH1	400m	405.797101u
BT-EDR(2Mbps)	-	-	-	-	-
2441MHz	Pass	31.6	310.530435m_DH5	400m	2.913043m
2441MHz	Pass	31.6	266.666667m_DH3	400m	1.666667m
2441MHz	Pass	31.6	134.492754m_DH1	400m	420.289855u
BT-EDR(3Mbps)	-	-	-	-	-
2441MHz	Pass	31.6	310.530435m_DH5	400m	2.913043m
2441MHz	Pass	31.6	266.666667m_DH3	400m	1.666667m
2441MHz	Pass	31.6	129.855072m_DH1	400m	405.797101u

Result/ AFH mode

Mode	Result	Period (s)	Dwell (s)	Limit (s)	Tx On (s)
BT-BR(1Mbps)	-	-	-	-	-
2441MHz	Pass	8	155.3526m_DH5	400m	2.913043m
2441MHz	Pass	8	133.3334m_DH3	400m	1.666667m
2441MHz	Pass	8	64.92754m_DH1	400m	405.797101u
BT-EDR(2Mbps)	-	-	-	-	-
2441MHz	Pass	8	155.3526m_DH5	400m	2.913043m
2441MHz	Pass	8	133.3334m_DH3	400m	1.666667m
2441MHz	Pass	8	67.24638m_DH1	400m	420.289855u
BT-EDR(3Mbps)	-	-	-	-	-
2441MHz	Pass	8	155.3526m_DH5	400m	2.913043m
2441MHz	Pass	8	133.3334m_DH3	400m	1.666667m
2441MHz	Pass	8	64.92754m_DH1	400m	405.797101u

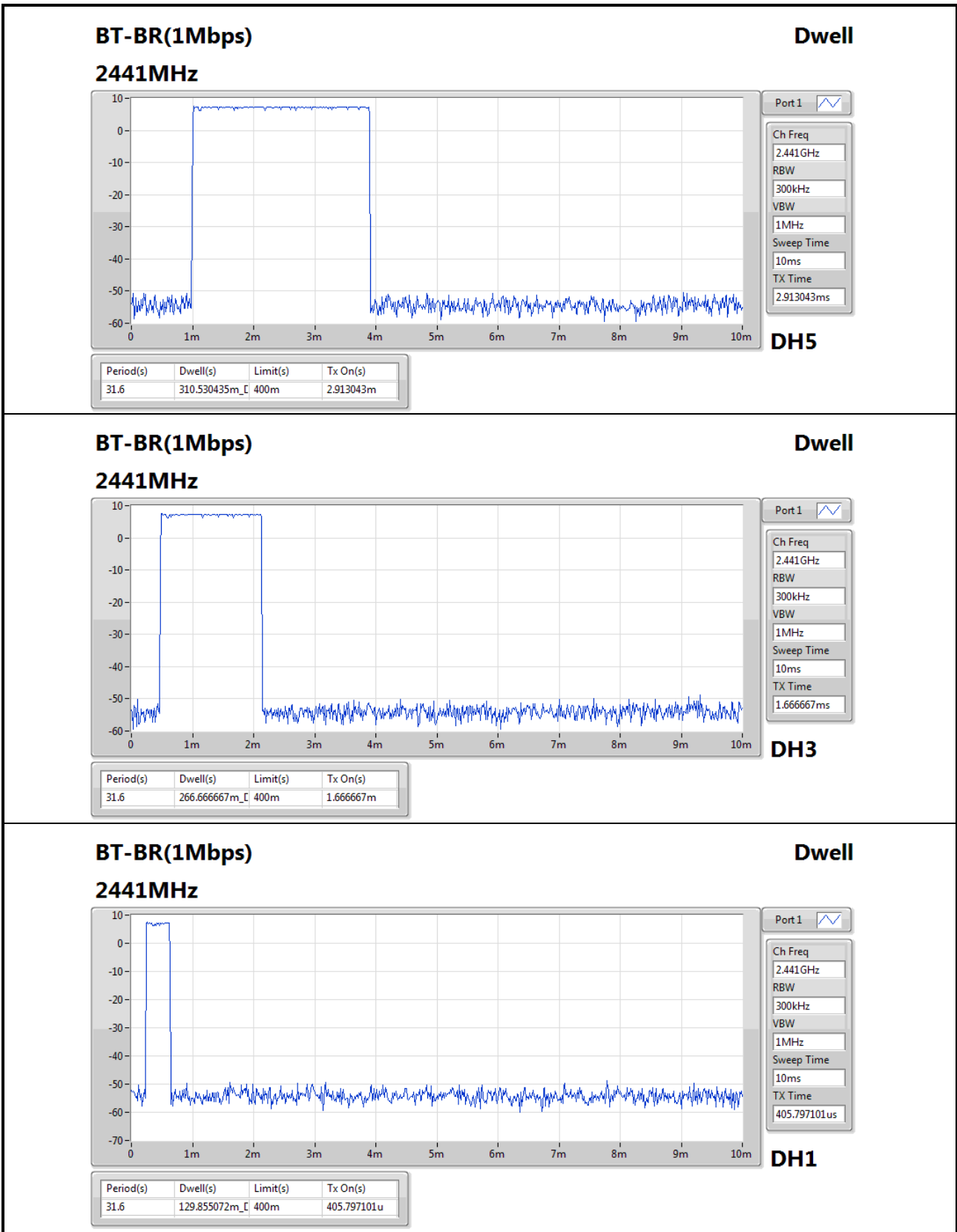

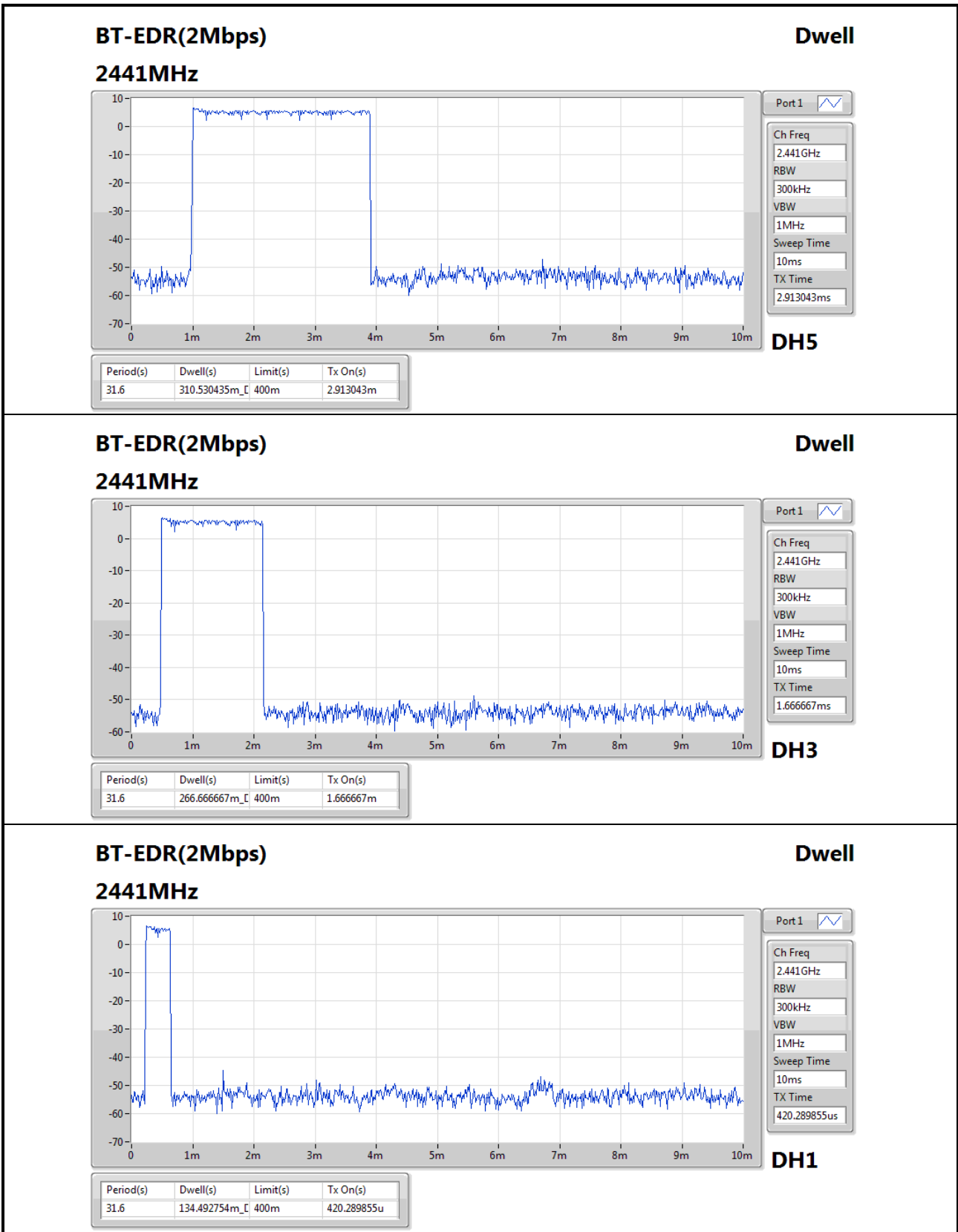

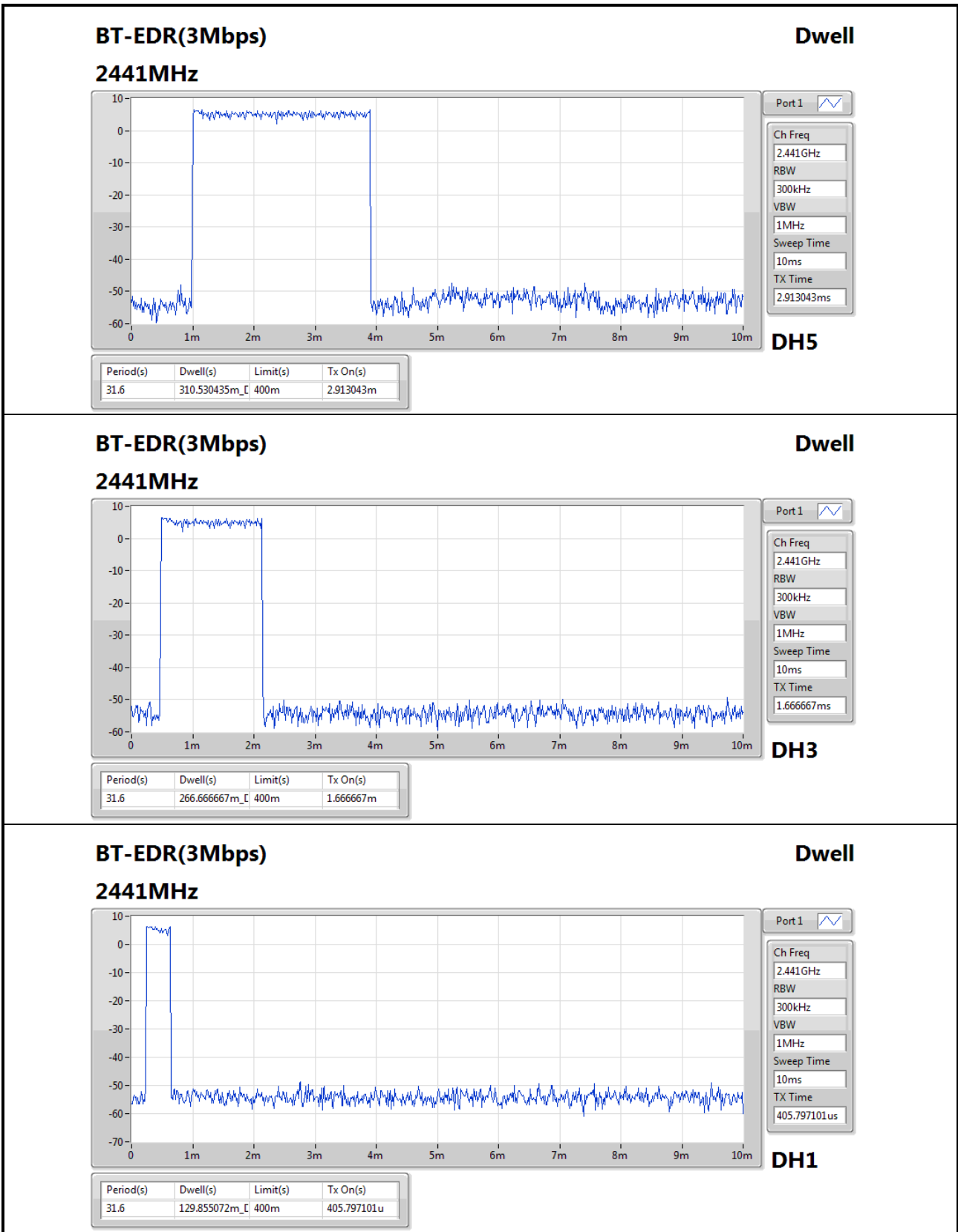

4 Photographs of EUT

Please refer to Photographs of EUT, reference No. EP9D1001.

5 Test laboratory information

Established in 2012, ICC provides foremost EMC & RF Testing and advisory consultation services by our skilled engineers and technicians. Our services employ a wide variety of advanced edge test equipment and one of the widest certification extents in the business.

International Certification Corp (EMC and Wireless Communication Laboratory), it is our definitive objective is to institute long term, trust-based associations with our clients. The expectation we set up with our clients is based on outstanding service, practical expertise and devotion to a certified value structure. Our passion is to grant our clients with best EMC / RF services by oriented knowledgeable and accommodating staff.

Our Test sites are located at Linkou District and Kwei Shan District. Location map can be found on our website <http://www.icertifi.com.tw>.

Linkou

Tel: 886-2-2601-1640

No. 30-2, Ding Fwu Tsuen, Lin
Kou District, New Taipei City,
Taiwan, R.O.C.

Kwei Shan

Tel: 886-3-271-8666

No. 3-1, Lane 6, Wen San 3rd St.,
Kwei Shan District, Tao Yuan City
333, Taiwan, R.O.C.

Kwei Shan Site II

Tel: 886-3-271-8640

No. 14-1, Lane 19, Wen San 3rd
St., Kwei Shan District, Tao Yuan
City 333, Taiwan, R.O.C.

If you have any suggestion, please feel free to contact us as below information.

Tel: 886-3-271-8666

Fax: 886-3-318-0155

Email: ICC_Service@icertifi.com.tw

==END==