

# DW 800

Instructions for use

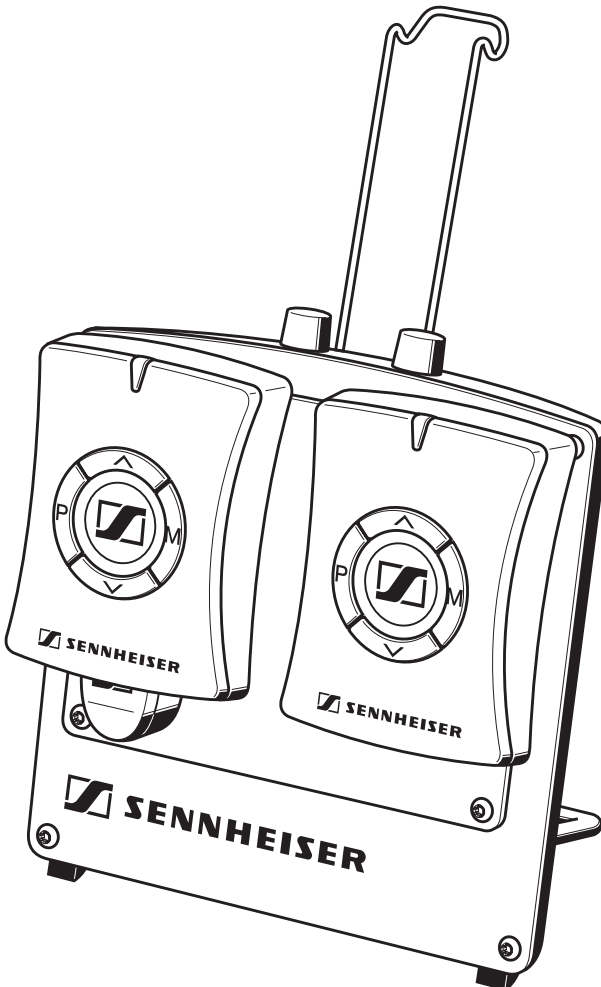

---

# Contents

Safety information .....	6
Delivery includes .....	6
System overview .....	7
Operating elements .....	8
Basic settings .....	8
The basic settings of the docking station .....	8
The basic settings of the mobile units .....	9
Putting the DW 800 system into operation .....	10
Setting up the docking station .....	10
Connecting the docking station to the telephone .....	10
Connecting a headset to a mobile unit .....	11
Testing the setup .....	11
Adjusting the DW 800 system to your telephone .....	12
Connecting the DW 800 docking station to a computer sound card .....	13
Connecting the DW 800 docking station to an external audio source .....	13
Charging the rechargeable batteries of the mobile units .....	14
Charging the rechargeable battery for the first time .....	14
Charging the rechargeable battery while telephoning (Hot Swap™) .....	14
Telephoning with the DW 800 system .....	16
Standard telephoning .....	16
Telephoning in voicelink automatic mode .....	16
Telephoning with a telephone controlling device .....	17
Basic intercom .....	17
Advanced settings .....	18
Making conference calls with the DW 800 system .....	19
Setting up the DW 800 system for conference calls .....	19
Ending a conference call .....	20
Intercom conference between up to five mobile units .....	21
Setting up the DW 800 system for an intercom conference .....	21
Ending the intercom mode .....	23
Pairing mobile units .....	23

---

<b>Personal settings</b> .....	25
Resetting the personal settings .....	26
If the push-to-talk mode (PTT) is switched on .....	26
If the voicelink automatic mode is switched on .....	26
Switching the buzzer on/off .....	27
<b>Maintenance and care</b> .....	28
<b>Further information</b> .....	28
Frequently asked questions .....	28
Accessories .....	28
Contact information .....	28
<b>Specifications</b> .....	29
Overall system .....	29
Docking station .....	29
Mobile units .....	29
<b>Warranty card</b> .....	29

**Note:** □

This equipment has been tested and found to comply with the limits for a □ Class B digital device, pursuant to Part 15 of the FCC Rules. □  
 These limits are designed to provide reasonable protection against harmful □ interference in a residential installation. This equipment generates, uses □ and can radiate radio frequency energy and, if not installed and used in □ accordance with the instructions, may cause harmful interference to radio □ communications. However, there is no guarantee that interference will not □ occur in a particular installation. If this equipment does cause harmful □ interference to radio or television reception, which can be determined by □ turning the equipment off and on, the user is encouraged to try to correct □ the interference by one or more of the following measures:□

- Reorient or relocate the receiving antenna.□
- Increase the separation between the equipment and receiver.□
- Connect the equipment into an outlet on a circuit different from that to which the receiver is connected.□
- Consult the dealer or an experienced radio/TV technician for help□

We have designed this product to give you reliable operation over many years. Over half a century of accumulated expertise in the design and manufacture of high-quality electro-acoustic equipment have made Sennheiser a world-leading company in this field.

Please take a few moments to read these instructions carefully, as we want you to enjoy your new Sennheiser product quickly and to the fullest.

## Safety information



Never open the docking station or a mobile unit. This must only be done by authorized personnel and is all the more important for units connected to AC outlets. If units are opened by customers in breach of this instruction, the warranty becomes null and void.



Set up the unit on an even surface. Lay the cables in such a way that no-one can stumble over them. Do not use the DW 800 system in a damp or dusty environment.



Use the DW 800 system in dry rooms only and keep liquids and small parts which conduct electricity away from the DW 800 system and its connecting sockets. For cleaning the DW 800 system, use a dry cloth only. Do not use any solvents or cleansing agents.



The DW 800 mobile units contain a Li-Ion rechargeable battery which must only be replaced by authorized personnel.

The rechargeable battery of the mobile units must only be charged in the DW 800 docking station! Never try to charge rechargeable batteries other than those of the DW 800 mobile units in the docking station!

## Delivery includes

- 1 DW 800 docking station with 2 mobile units
- 1 external mains unit
- 1 telephone connecting cable with 2 modular plugs
- 1 audio cable with two 3.5 mm stereo jack plugs
- 1 instructions for use

For accessories such as suitable headsets or a wall mount kit, please refer to "Further information" on page 28.

# System overview

The DW 800 wireless system:

- gives a standard wired telephone the ability for wireless telephony via a headset
- fits any Sennheiser telecom headset
- does not interfere with normal telephone functions and you can use your telephone in the usual way
- allows intercommunication between up to five mobile units
- permits conference calls between up to four persons
- allows voice over IP (internet telephony)

The system consists of the DW 800 docking station and two identical mobile units.

A wireless link is established between the mobile units. For telephoning purposes, one mobile unit has to stay in the left-hand charging slot of the docking station. This mobile unit establishes the telephone connection.

The second mobile unit, to which a headset is connected, can be moved around, thus allowing wireless telephony. When the built-in rechargeable battery of a mobile unit is going flat, the two mobile units can be exchanged without having to end a current call.

The DW 800 wireless system is based on state-of-the-art wireless technology. The indoor operating range is up to 150 m. If there is a free line of sight between the docking station and a mobile unit, the range is up to 300 m. The talking time is approx. 12 hours. The sound quality is excellent – as you have come to expect from Sennheiser.

# Operating elements

For the illustration of the operating elements please refer to the fold-out.

## DW 800 docking station







- 1 AUX button
- 2 Hinged headset holder
- 3 Headset button
- 4 Hinged stand
- 5 Interface
- 6 Charging slot
- 7 Modular socket PHONE for telephone connection
- 8 Modular socket HANDSET for handset connection
- 9 Telephone adjustment switch A-B-C
- 10 Telephone adjustment knob (microphone sensitivity 1-9)
- 11 DC IN socket POWER SUPPLY
- 12 Modular socket AUX for auxiliary equipment
- 13 Modular socket ACCESSORIES for a telephone controlling device

## DW 800 mobile unit













- 14 LED indicating the operating status
- 15 Headset socket
- 16 Program key
- 17 Hook key
- 18 Volume up key
- 19 Mute key
- 20 Volume down key



# Basic settings

## The basic settings of the docking station

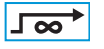
Function	Button	
	AUX	Headset
Telephony via the telephone handset		
Wireless telephony via the headset		
Listening to an external source/voice over IP		

## The basic settings of the mobile units

Function	Button(s) to be pressed simultaneously					Resulting signals (LED and buzzer)
						
Accepting a call/ making a call						–
Increasing the speaker volume (press during a call)						Increases the speaker volume in 5 steps
Reducing the speaker volume (press during a call)						Reduces the speaker volume in 5 steps
Muting/unmuting the headset microphone (press during a call)						Quick blue flashes 1 x 1 mid-range beep every 5 sec.
Switching “Sound Clarity™” on/off (press during a call)						1 x 3 green flashes 1 x 1 mid-range beep
Switching a mobile unit on/off (or simply place into docking station to switch it on)						1 x 3 green flashes 3 beeps
Finding a mislaid mobile unit (press while line is not busy)						Buzzer rings as long as keys are kept pressed

The meanings of the symbols:		Press the key (and release it immediately).
		Press the key and keep it pressed for four seconds.
		Press the key and keep it pressed until the desired parameter is set or the desired action is performed.

## Putting the DW 800 system into operation

### Setting up the docking station

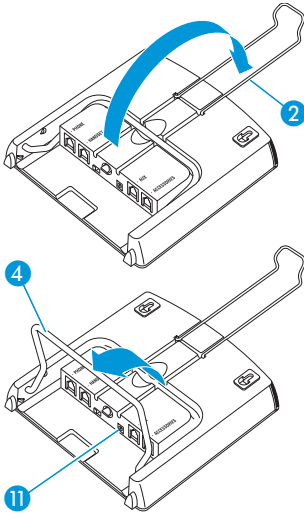

- ▶ Move the hinged headset holder 2 to a vertical position until a “click” is heard.
- ▶ Move the hinged stand 4 until you overcome a certain resistance.
- ▶ Move back the hinged stand 4 so that the docking station tilts back slightly.
- ▶ Connect the external mains unit to the DC IN socket 11 and to the mains.
- ▶ Charge the built-in rechargeable battery of the mobile units (see “Charging the rechargeable battery for the first time” on page 14).

#### Note:

For wall mounting the docking station, a wall mount kit is available (see “Further information” on page 28).

### Connecting the docking station to the telephone

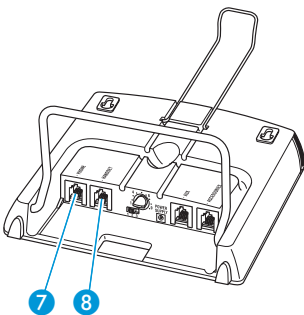

- ▶ Unplug the telephone handset (including the cable) from the telephone.
- ▶ Plug the handset into the modular socket 8 and return it to its place on the telephone.
- ▶ Plug one of the modular plugs of the telephone connecting cable to the modular socket to which the handset was connected.
- ▶ Plug the other modular plug of the telephone connecting cable to the modular socket 7.



## Connecting a headset to a mobile unit

To connect a headset to a mobile unit:

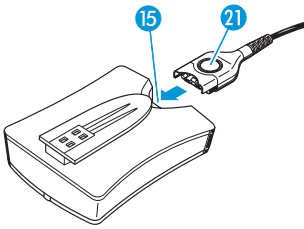

- ▶ Plug the headset plug into the headset socket 15 so that the release button 21 of the plug remains visible.

To disconnect the headset from a mobile unit:

- ▶ Press the release button 21 of the plug and keep it pressed while pulling the plug out of the socket.

### Note:

The headset can stay connected all the time, even when the mobile unit is placed into the **right-hand** charging slot. However, the headset must be removed from the mobile unit when the mobile unit is placed into the **left-hand** charging slot.

## Testing the setup

To test whether the DW 800 system is properly connected to the telephone and the headset:

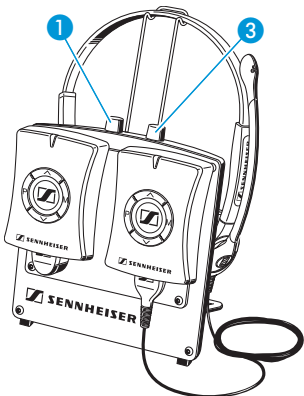

- ▶ Make sure that the AUX button 1 is in the “up” position.
- ▶ Make sure that the headset button 3 is in the “up” position.
- ▶ Remove the telephone’s handset from the telephone.
  - If a dial tone is heard in the handset, the system is connected properly.
  - If no dial tone is heard, please refer to “Connecting the docking station to the telephone” on page 10.

## Adjusting the DW 800 system to your telephone

To ensure optimum intelligibility, adjust the DW 800 system to your telephone as follows:

- ▶ Place one mobile unit into the left-hand charging slot.
- ▶ Place the mobile unit to which the headset is connected into the right-hand charging slot.
- ▶ Make sure that the AUX button 1 is in the “up” position.
- ▶ Press the headset button 3 to the “down” position.
- ▶ Put on the headset and adjust it for comfort.
- ▶ Press the hook key 17 on the mobile unit.  
A wireless link is established between the two mobile units.
- ▶ Remove the telephone’s handset from the telephone.  
A dial tone is heard in the headset.
- ▶ Set the telephone adjustment switch A-B-C 9 so that the dial tone can be heard loud and clear in the headset.
- ▶ Turn the telephone adjustment knob 10 to position 1.
- ▶ Make a test call to someone while adjusting the microphone sensitivity.
- ▶ Speak to the other party by alternately using the handset (headset button 3 is in the “up” position) and the headset (headset button 3 is in the “down” position), always starting with the handset.
- ▶ Turn the telephone adjustment knob 10 so that the other party can hear you at a comfortable level, whether you use the headset or the handset.
- ▶ To change the speaker volume, please refer to “The basic settings of the mobile units” on page 9.

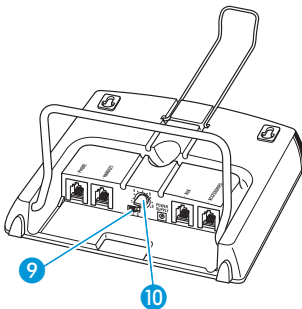
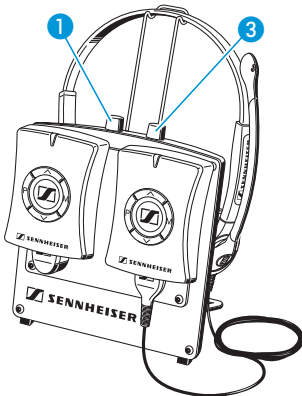

### Connecting the DW 800 docking station to a computer sound card

For multimedia purposes or voice over IP (internet telephony), the DW 800 docking station must be connected to a computer sound card as follows:

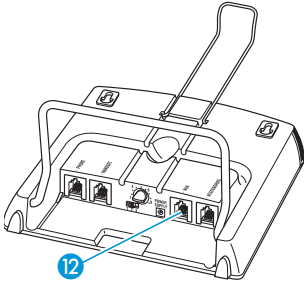

- ▶ Plug the red jack plug of the computer connecting cable into the line-in socket (not the mic-in socket!) of the sound card.
- ▶ Plug the green jack plug of the computer connecting cable into the line-out socket of the sound card.
- ▶ Plug the modular plug of the computer connecting cable into the modular socket 12 of the docking station.

### Connecting the DW 800 docking station to an external audio source

If you connect the DW 800 docking station to an external audio source with a 3.5 mm line-out socket (e. g. radio, portable CD, MP3 or minidisc player), you can hear the corresponding audio signal in your headset.

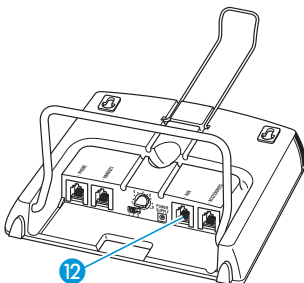

- ▶ Plug the green jack plug of the computer connecting cable into the 3.5 mm line-out socket of the external audio source. The red jack plug of the computer connecting cable remains unplugged.
- ▶ Plug the modular plug of the computer connecting cable into the docking station's modular socket 12.

## Charging the rechargeable batteries of the mobile units

The mobile units are fitted with a built-in Li-Ion rechargeable battery which provides an operating time of approx. 12 hours.

### Charging the rechargeable battery for the first time

- ▶ Place each mobile unit into a charging slot **6**. Since both mobile units are identical, there is no preferred charging slot for a mobile unit. The hook key **17** is backlit in blue and the LED **14** starts flashing in green every two seconds.

#### Note:

Make sure the mobile unit in the right-hand charging slot is connected to the headset to avoid the warning for missing audio connection (orange flashing and beeping).

- ▶ Do not interrupt the charging process for at least two hours!

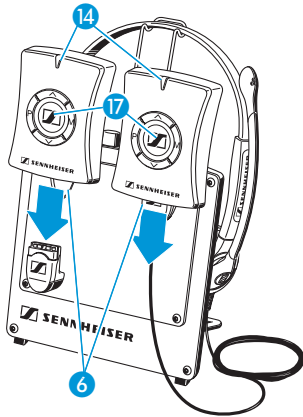

### Charging the rechargeable battery while telephoning (Hot Swap™)

When the rechargeable battery of a mobile unit is going flat

- a low buzzing tone can be heard in the headset twice every 5 seconds,
- a low buzzing tone from the mobile unit can be heard twice every 5 seconds – provided the buzzer is switched on (see “Switching the buzzer on/off” on page 27),
- the LED **14** flashes in red twice every 5 seconds,
- the rechargeable battery of the mobile unit has to be charged within the next 30 minutes.

**Note:**

You do not have to end a current call in order to charge the rechargeable battery of a mobile unit.

**Exception:** Do not charge the rechargeable battery of a mobile unit during a conference call (see "Making conference calls with the DW 800 system" on page 19) as this will end the conference mode immediately!

To charge the rechargeable battery of a mobile unit without interrupting a current call:

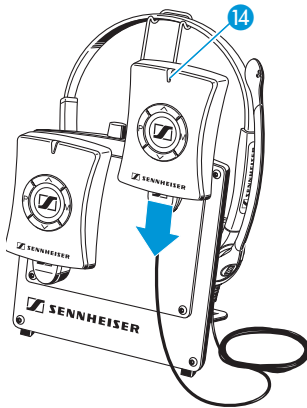

- ▶ Place the mobile unit into the **right-hand** charging slot of the docking station.  
The LED 14 flashes in green every two seconds.

To charge the rechargeable battery with a brief interruption of a current call:

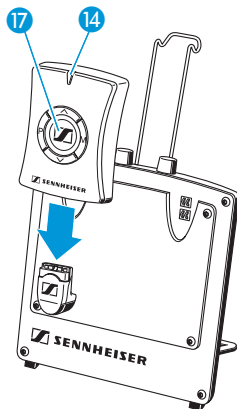

- ▶ Make sure the rechargeable battery of the mobile unit in the **left-hand** charging slot of the docking station is fully charged (the LED 14 lights up continuously in green).
- ▶ Unplug the headset from the mobile unit.  
The telephone connection remains operational. However, you cannot hear each other for the duration of the following two steps.
- ▶ Remove the mobile unit from the **left-hand** charging slot of the docking station.  
The green LED 14 goes off.
- ▶ Place the mobile unit whose rechargeable battery is going flat into the **left-hand** charging slot of the docking station.  
The LED 17 lights up in blue.
- ▶ Plug the headset to the mobile unit whose rechargeable battery is fully charged.  
The call is resumed.

**Note:**

When fully charged, the mobile units can stay in the charging slots. The rechargeable battery is protected against overcharging.

## Telephoning with the DW 800 system

There are four different modes available:

### Standard telephoning

- ▶ Remove the handset from the telephone.
- ▶ Press the hook key 17.
- ▶ Dial or talk.

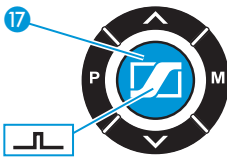

If you exceed the operating range of the mobile units:

- the LED 14 flashes in red once a second and
- the buzzer beeps in a mid-range tone.

### Telephoning in voicelink automatic mode

If you do not want to both remove the handset from the telephone and press the hook key, select the voicelink automatic mode (see "If the voicelink automatic mode is switched on" on page 26).

- ▶ Remove the handset from your telephone.  
The telephone and your headset are connected automatically. You can start to talk immediately.
- ▶ Dial or talk.

## Telephoning with a telephone controlling device

If a telephone controlling device (e.g. a handset lifter) is connected to your telephone:

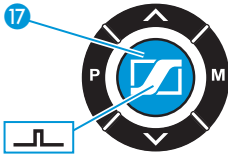

- ▶ Press the hook key 17.  
The device (e.g. handset lifter) establishes the connection and you can start to talk immediately.
- ▶ Dial or talk.





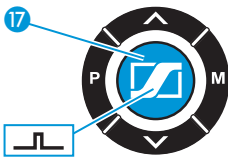





## Basic intercom



To communicate directly between the two mobile units, independently of the telephone network:



- ▶ Remove both mobile units from the docking station.
- ▶ Connect a headset to each of the two mobile units.
- ▶ To start intercom, press the hook key 17 on one mobile unit.  
The other mobile unit starts ringing.
- ▶ To accept the call, press the hook key 17 on the ringing mobile unit.

# Advanced settings

Function	Button(s) to be pressed simultaneously					Resulting signals (LED and buzzer)
						
Initiating "conference mode" (press while in docking station) (see page 19)						3 high beeps a second
Ending "conference mode" (press while in docking station) (see page 20)						-
Initiating "intercom mode" (press while in docking station) (see page 21)						3 high beeps a second
Ending "intercom mode" (press while in docking station) (see page 23)						-
Manual pairing (press on both mobile units simultaneously) (see page 23)						3 flashes (green, red, orange)

The meanings of the symbols:		Press the key (and release it immediately).
		Press the key and keep it pressed for four seconds.
		Press the key and keep it pressed until the desired parameter is set or the desired action is performed.



## Making conference calls with the DW 800 system

Up to four persons can make a conference call and telephone simultaneously with the same party. You require a mobile unit with a headset for each participant in the conference call.

### Attention!

Do not recharge the rechargeable battery of a mobile unit during a conference call as this will end the conference mode immediately!

### Setting up the DW 800 system for conference calls

To initiate the conference mode:

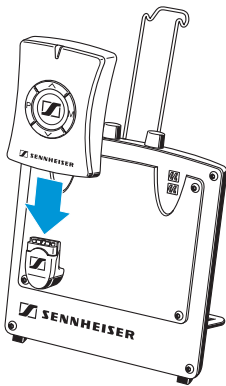

- ▶ Place a mobile unit into the **left-hand** charging slot of the docking station. This mobile unit becomes the master mobile unit and is able to control the other mobile units participating in the conference call.
- ▶ Initiate an outgoing call or accept an incoming call (see "Telephoning with the DW 800 system" on page 16).

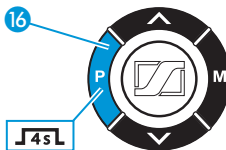

- ▶ Press the program key **16** on the master mobile unit and keep it pressed for four seconds. The master mobile unit starts beeping in a high tone three times a second, thus indicating conference initialization mode.

The mobile unit belonging to the master mobile unit automatically participates in the conference call without the necessity of making further settings.

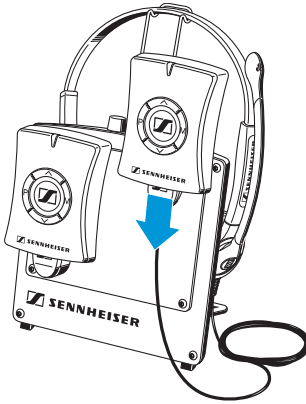

- ▶ Within one minute after the last mobile unit was placed into the docking station:  
If an additional mobile unit is to participate in the conference call, place it into the **right-hand** charging slot of the docking station. The mobile unit starts beeping the same way as the master mobile unit, indicating that the mobile unit has joined the conference call.
- ▶ Repeat the last step for up to three mobile units.

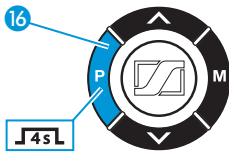

- ▶ Press the program key **16** on the master mobile unit and keep it pressed for four seconds. All mobile units stop beeping. The conference initialization mode is ended and the conference call begins.

**Note:**

The conference initialization mode ends automatically one minute after the last mobile unit is placed into a charging slot or the maximum number of participating mobile units is reached.

**Ending a conference call**

To make a mobile unit leave the conference call:

- ▶ Press the hook key **17** on the corresponding mobile unit. The remaining mobile units continue to participate in the conference call.

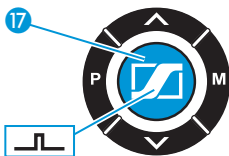

**Note:**

Once a mobile unit leaves a conference call, re-entry is impossible. The whole call has to be set up again from the beginning.

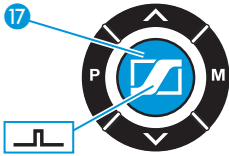

To end the conference call simultaneously for all mobile units:

- ▶ Press the hook key **17** on the master mobile unit. The conference call is ended for all mobile units.

**Note:**

When the conference call is ended, the corresponding mobile units automatically return to the operating status they had before the conference call started.

## Intercom conference between up to five mobile units

In addition to making conference calls via the telephone, you can use the mobile units for intercom conferences between up to five mobile units. Intercom works independently of the telephone line.

You require a separate headset for every mobile unit.

### Setting up the DW 800 system for an intercom conference

To initiate the intercom conference mode:

- ▶ Place a mobile unit into the **left-hand** charging slot of the docking station. This mobile unit becomes the master mobile unit and is able to control the other mobile units in the intercom system.

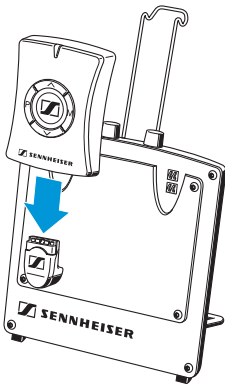

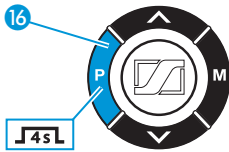

- ▶ Press the program key 16 on the master mobile unit and keep it pressed for four seconds.

The master mobile unit starts beeping in a high tone three times a second, thus indicating conference initialization mode.

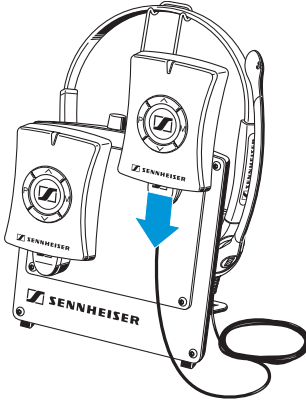

- ▶ Within one minute after the last mobile unit was placed into the docking station:

Place a mobile unit into the **right-hand** charging slot of the docking station.

The mobile unit starts beeping the same way as the master mobile unit, indicating that the mobile unit has joined the intercom conference.

- ▶ For larger intercom conferences:  
Repeat the last step for up to four mobile units.

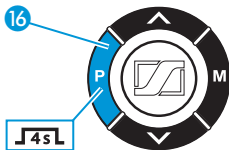

- ▶ Press the program key 16 on the master mobile unit and keep it pressed for four seconds.

All mobile units stop beeping. The conference initialization mode is ended.

**Note:**

The conference initialization mode ends automatically one minute after the last mobile unit is placed into a charging slot or the maximum number of participating mobile units is reached.

- ▶ Take the master mobile unit out of the **left-hand** charging slot of the docking station and connect a headset.

The voices of all participants are now audible.

## Ending the intercom mode

To make a mobile unit leave intercom:

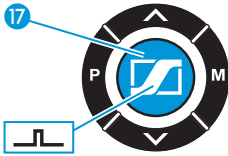

- ▶ Press the hook key 17 on the corresponding mobile unit.  
The remaining mobile units continue to inter-communicate.

### Note:

Once a mobile unit leaves an intercom conference, re-entry is impossible. The whole intercom conference has to be set up again from the beginning.

To end intercom for all mobile units simultaneously:

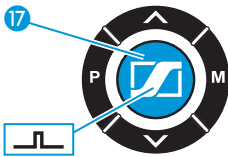

- ▶ Press the hook key 17 on the master mobile unit.

### Note:

When intercom is ended, the corresponding mobile units automatically return to the operating status they had before intercom started.

It is not possible to re-enter intercom once it has been exited.

## Pairing mobile units

Upon delivery, the two mobile units of a set are already paired, i.e. they automatically recognize each other and do not interfere with other wireless systems used in the vicinity. You do **not** have to pair the two mobile units.

If you switch off a mobile unit and switch it on again, the mobile units of a paired set automatically recognize each other.

However, if you have to exchange one of the two mobile units of a set for a new one, e.g. because it is

damaged, the two mobile units will not recognize each other until they are paired manually as follows:



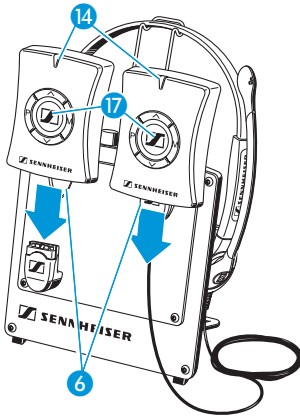











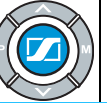





- ▶ Place both mobile units into the charging slots **6**. The mobile units are set to standby. The logo on the hook key **17** is backlit in blue, thus indicating correct contact to the docking station.





- ▶ On both mobile units, press the program keys **16** and the hook keys **17** at the same time and keep them all pressed for four seconds. After the two mobile units have been paired successfully, the LED **14** flashes once in green, then in red and in orange. If pairing was not successful, the LED **14** flashes in red every five seconds instead.

# Personal settings

The personal settings can only be changed **when the line is not busy**. The settings you make on one mobile unit are automatically transferred to the second mobile unit in your system.

Function	Button(s) to be pressed simultaneously					Resulting signals (LED and buzzer)
						
Increasing the ringing volume						You hear the selected ringing melody
Reducing the ringing volume						
Changing the ringing melody						
Switching the button-click on/off						1 x 3 green flashes 1 x 3 beeps
Switching the buzzer on						1 x 1 mid-range beep
Switching the buzzer off						1 x 1 mid-range beep
Switching the "ptt mode" on/off (see page 26)						1 x 3 green flashes 1 x 3 high beeps
Switching "voicelink automatic" on/off (see page 26)						1 x 3 green flashes 1 x 3 high beeps

The meanings of the symbols:		Press the key (and release it immediately).
		Press the key and keep it pressed for four seconds.
		Press the key and keep it pressed until the desired parameter is set or the desired action is performed.

## Resetting the personal settings

To reset the personal settings to the factory presets:

- ▶ Press all five keys and keep them pressed for four seconds.

All personal settings – except pairing – are reset to the factory presets.

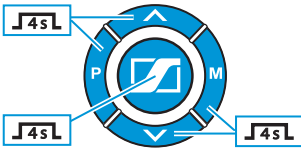

The factory presets are:

- Key click: off
- Buzzer: on
- Voicelink automatic: off
- Ringing melody: No. 1
- Ringing volume: medium (step 3 of 5)
- PTT mode: off
- Sound Clarity™: off

### If the push-to-talk mode (PTT) is switched on



- you can accept a call by pressing the hook key 17,
- you have to press the mute key 19 and keep it pressed as long as you talk,
- your headset's microphone is muted when you release the mute key 19,
- you can end a call by pressing the hook key 17 (and releasing it immediately).

### If the voicelink automatic mode is switched on

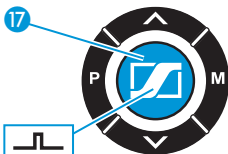

- you can accept a call or make a call by lifting the telephone handset without having to press the hook key 17,
- you can end a call by replacing the handset on the telephone without having to press the hook key 17.



**Note:**

The voicelink automatic mode detects sound. If no one speaks for 30 s, the wireless link between the two mobile units is shut down automatically to save energy. The wireless link is re-established automatically as soon as the call is resumed or you press the hook key **17**.

**Switching the buzzer on/off**

You can switch the buzzer off (silent mode). However, the buzzer will beep regardless of the buzzer setting if:

- a mobile unit is switched on or off (see “The basic settings of the mobile units” on page 9),
- a mobile unit is reset (see “Resetting the personal settings” on page 26),
- a mobile unit is set to conference initialization mode (see “Making conference calls with the DW 800 system” on page 19 and “Intercom conference between up to five mobile units” on page 21),
- a mislaid mobile unit is searched for (see “Pairing mobile units” on page 23),
- the ringing melody is changed (see “Personal settings” on page 25),
- the ringing volume is changed (see “Personal settings” on page 25).

## Maintenance and care

Use a soft or, if necessary, slightly damp cloth to clean the DW 800 system. Do not use any solvents or cleansing agents as these can damage the varnish of the DW 800 system.

## Further information

### Frequently asked questions

For possible solutions to problems, please refer to the FAQ on our web page:

[www.sennheisercommunications.com](http://www.sennheisercommunications.com)

and see under "Products", "Wireless solution" and "DW 800".

### Accessories

For accessories to the DW 800 system, please refer to:

[www.sennheisercommunications.com](http://www.sennheisercommunications.com)

and see under "Products", "Wireless solution" and "DW 800".

### Contact information

In case of further questions, please contact your local distributor. For a list of distributors, please refer to:

[www.sennheisercommunications.com](http://www.sennheisercommunications.com)

and see under "Support".

## Specifications **Overall system**

Host phone compatibility with all types of business phones which comply with the RF immunity standard IEC CISPR24/EN55024.

Indoor operating range  
(depending on the environment) . . . . . up to 150 m

Operating range with free line of sight . . . . . 300 m

### Docking station

Charging time of rechargeable battery . . approx. 3 h

### Mobile units

Talking time . . . . . approx. 12 h

Transmitting power . . . . . 250 mW peak

## Warranty card

Sennheiser Communications A/S gives a 2-year warranty on the DW 800 system. For details on the warranty conditions, please refer to:

[www.sennheisercommunications.com](http://www.sennheisercommunications.com)

and see under "Products", "Wireless solution" and "DW 800".

**Serial No.** Mobile unit 1

**Serial No.** Mobile unit 2

**Serial No.** Docking station

Note: □

□

This device complies with Part 15 of the FCC Rules. Operation is subject to □  
the following two conditions: (1) this device may not cause harmful □  
interference, and (2) this device must accept any interference received, □  
including interference that may cause undesired operation□

□

Modifications not expressly approved by this company could void the user's □  
authority to operate the equipment□

□

]

□

This device and its antenna must not be co-located or operating in □  
conjunction with any other antenna or transmitter.