

FCC Test Report

FCC ID : R3UDSBT1
Equipment : Bluetooth dongle
Model No. : DSBT1
Brand Name : EPOS
Applicant : DSEA A/S
Address : Kongebakken 9, DK-2765 Smørum, Denmark
Standard : 47 CFR FCC Part 15.247
Received Date : Mar. 07, 2022
Tested Date : Mar. 21 ~ Mar. 28, 2022

We, International Certification Corporation, would like to declare that the tested sample has been evaluated and in compliance with the requirement of the above standards. The test results contained in this report refer exclusively to the product. It shall not be reproduced except in full without the written approval of our laboratory.

Reviewed by:

Approved by:



Along Chen / Assistant Manager



Gary Chang / Manager

Table of Contents

1	GENERAL DESCRIPTION	5
1.1	Information.....	5
1.2	Local Support Equipment List	8
1.3	Test Setup Chart	8
1.4	The Equipment List	10
1.5	Test Standards	11
1.6	Reference Guidance	11
1.7	Deviation from Test Standard and Measurement Procedure.....	11
1.8	Measurement Uncertainty	11
2	TEST CONFIGURATION.....	12
2.1	Testing Facility	12
2.2	The Worst Test Modes and Channel Details	12
3	TRANSMITTER TEST RESULTS	13
3.1	Conducted Emissions.....	13
3.2	Unwanted Emissions into Restricted Frequency Bands	14
3.3	Unwanted Emissions into Non-Restricted Frequency Bands	17
3.4	Conducted Output Power	18
3.5	Number of Hopping Frequency	19
3.6	20dB and Occupied Bandwidth.....	20
3.7	Channel Separation.....	21
3.8	Number of Dwell Time.....	22
4	TEST LABORATORY INFORMATION	23

APPENDIX A. CONDUCTED EMISSIONS

APPENDIX B. UNWANTED EMISSIONS INTO RESTRICTED FREQUENCY BANDS

APPENDIX C. UNWANTED EMISSIONS INTO NON-RESTRICTED FREQUENCY BANDS

APPENDIX D1. CONDUCTED OUTPUT POWER

APPENDIX D2. CONDUCTED OUTPUT POWER

APPENDIX E. NUMBER OF HOPPING FREQUENCY

APPENDIX F. 20dB AND OCCUPIED BANDWIDTH

APPENDIX G. CHANNEL SEPARATION

APPENDIX H. NUMBER OF DWELL TIME

Release Record

Report No.	Version	Description	Issued Date
FR230702	Rev. 01	Initial issue	Apr. 28, 2022

Summary of Test Results

FCC Rules	Test Items	Measured	Result
15.207	Conducted Emissions	[dBuV]: 0.159MHz 46.23 (Margin -19.29dB) - QP	Pass
15.247(d) 15.209	Radiated Emissions	[dBuV/m at 3m]: 82.38MHz 35.43 (Margin -4.57dB) - PK	Pass
15.247(d)	Band Edge	Meet the requirement of limit	Pass
15.247(b)(1)	Conducted Output Power	Power [dBm]: 12.33	Pass
15.247(a)(1)(iii)	Number of Hopping Channels	Meet the requirement of limit	Pass
15.247(a)(1)	Hopping Channel Separation	Meet the requirement of limit	Pass
15.247(a)(1)(iii)	Dwell Time	Meet the requirement of limit	Pass
15.203	Antenna Requirement	Meet the requirement of limit	Pass

Declaration of Conformity:

The test results with all measurement uncertainty excluded are presented in accordance with the regulation limits or requirements declared by manufacturers.

Comments and Explanations:

The declared of product specification for EUT presented in the report are provided by the manufacturer, and the manufacturer takes all the responsibilities for the accuracy of product specification.

1 General Description

1.1 Information

1.1.1 Specification of the Equipment under Test (EUT)

RF General Information				
Frequency Range (MHz)	Bluetooth Mode	Ch. Frequency (MHz)	Channel Number	Data Rate
2400-2483.5	BR V5.2	2402-2480	0-78 [79]	1 Mbps
2400-2483.5	EDR V5.2	2402-2480	0-78 [79]	2 Mbps
2400-2483.5	EDR V5.2	2402-2480	0-78 [79]	3 Mbps

Note 1: RF output power specifies that Maximum Peak Conducted Output Power.
 Note 2: Bluetooth BR uses a GFSK.
 Note 3: Bluetooth EDR uses a combination of $\pi/4$ -DQPSK and 8DPSK.

1.1.2 Antenna Details

Ant. No.	Brand	Model	Type	Connector	Gain (dBi)
1	EPOS	3A	PIFA	No	-4.5

1.1.3 Power Supply Type of Equipment under Test (EUT)

Power Supply Type	5Vdc, 0.1 A
--------------------------	-------------

1.1.4 Accessories

No.	Equipment	Description
1	USB cable	Brand: EPOS Model: DSDUAL125 Line: 1.17m USB-A shielded extension cable without core
2	USB dongle stand	Brand: EPOS Model: DSDUAL101 Line: 0.91m USB-A shielded extension cable with stand

1.1.5 Channel List

Frequency band (MHz)				2400~2483.5			
Channel	Frequency (MHz)	Channel	Frequency (MHz)	Channel	Frequency (MHz)	Channel	Frequency (MHz)
0	2402	20	2422	40	2442	60	2462
1	2403	21	2423	41	2443	61	2463
2	2404	22	2424	42	2444	62	2464
3	2405	23	2425	43	2445	63	2465
4	2406	24	2426	44	2446	64	2466
5	2407	25	2427	45	2447	65	2467
6	2408	26	2428	46	2448	66	2468
7	2409	27	2429	47	2449	67	2469
8	2410	28	2430	48	2450	68	2470
9	2411	29	2431	49	2451	69	2471
10	2412	30	2432	50	2452	70	2472
11	2413	31	2433	51	2453	71	2473
12	2414	32	2434	52	2454	72	2474
13	2415	33	2435	53	2455	73	2475
14	2416	34	2436	54	2456	74	2476
15	2417	35	2437	55	2457	75	2477
16	2418	36	2438	56	2458	76	2478
17	2419	37	2439	57	2459	77	2479
18	2420	38	2440	58	2460	78	2480
19	2421	39	2441	59	2461	---	---

1.1.6 Test Tool and Duty Cycle

Test Tool	BlueSuite , V3.3.12 Bluetooth simulator: Brand: R&S , Model: CMW270	
Modulation Mode	Duty Cycle Of Test Signal (%)	Duty Factor (dB)
DH5	78.41%	1.06
2DH5	77.99%	1.08
3DH5	78.46%	1.05

1.1.7 Power Index of Test Tool

Modulation Mode	Test Frequency (MHz)		
	2402	2441	2480
GFSK / 1Mbps	Default	Default	Default
$\pi/4$ -DQPSK / 2Mbps	Default	Default	Default
8DPSK / 3Mbps	Default	Default	Default

1.2 Local Support Equipment List

Support Equipment List					
No.	Equipment	Brand	Model	FCC ID	Remarks
1	Notebook	DELL	Latitude E5400	DoC	---

1.3 Test Setup Chart

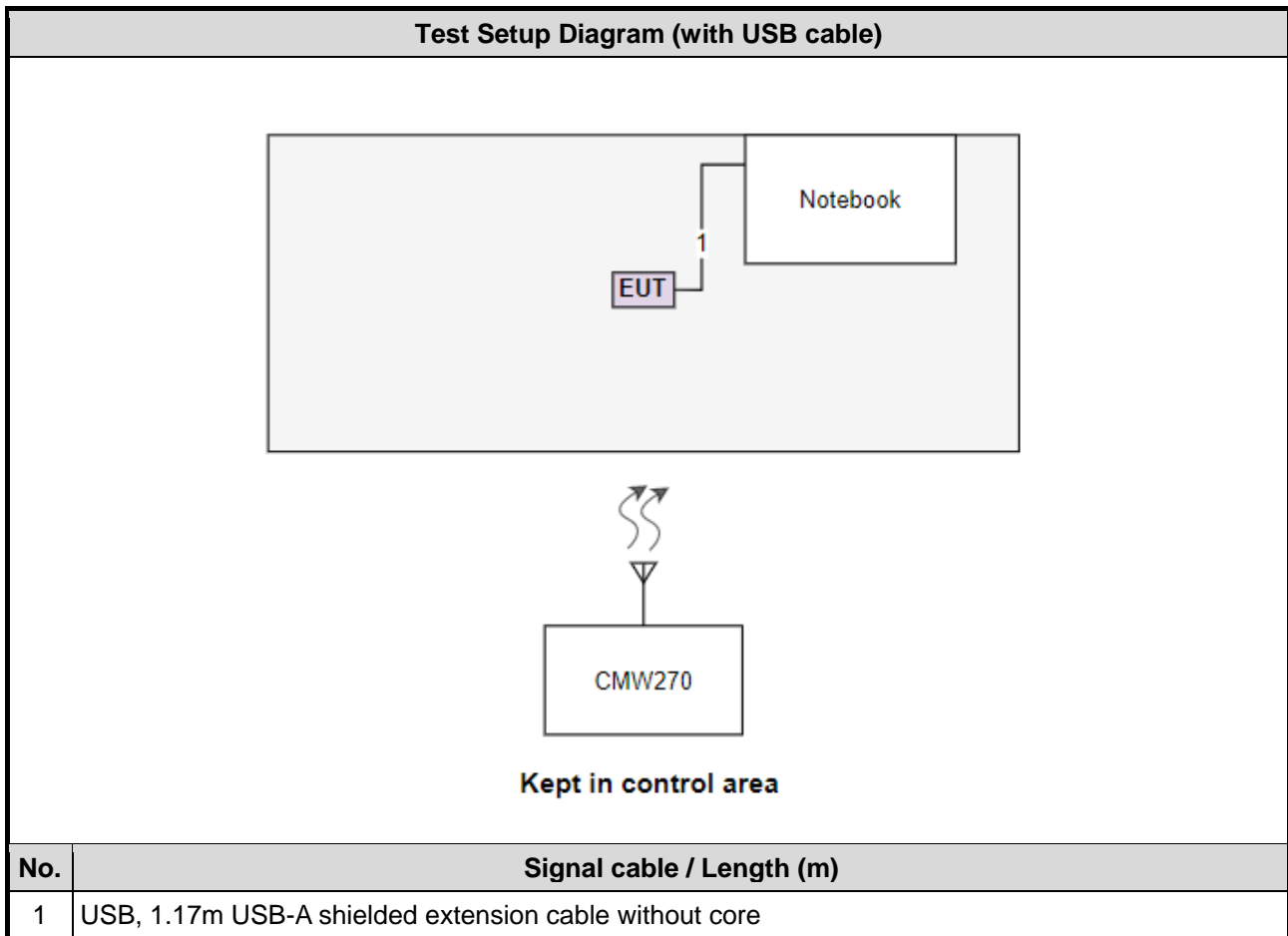

Test Setup Diagram (with USB dongle stand)

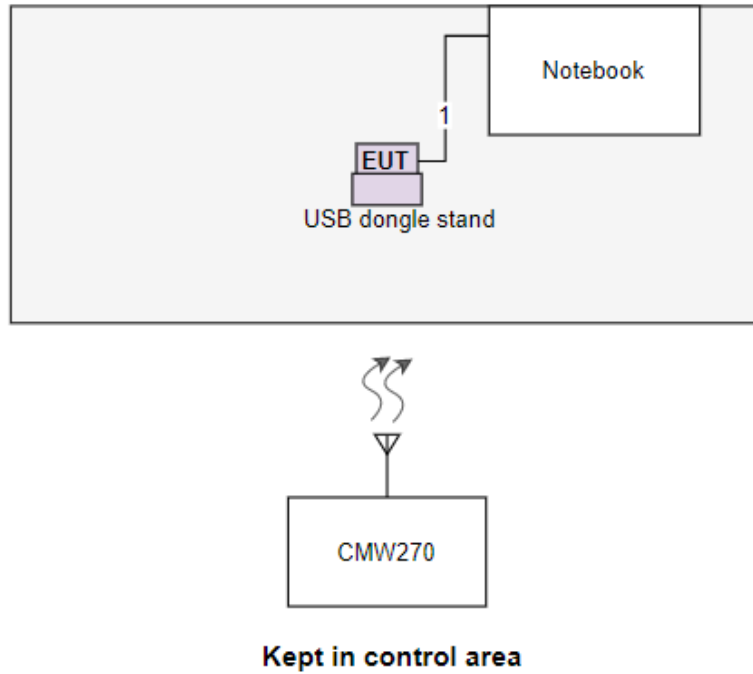

No.	Signal cable / Length (m)
1	USB, 0.91m USB-A shielded extension cable with stand

1.4 The Equipment List

Test Item	Conducted Emission				
Test Site	Conduction room 1 / (CO01-WS)				
Tested Date	Mar. 26, 2022				
Instrument	Brand	Model No.	Serial No.	Calibration Date	Calibration Until
Receiver	R&S	ESR3	101658	Feb. 16, 2022	Feb. 15, 2023
LISN	R&S	ENV216	101295	Jan. 12, 2022	Jan. 11, 2023
LISN (Support Unit)	SCHWARZBECK	NSLK 8127	8127667	Jan .07, 2022	Jan .06, 2023
RF Cable-CON	Woken	CFD200-NL	CFD200-NL-001	Oct. 19, 2021	Oct. 18, 2022
50 ohm terminal (Support Unit)	NA	50	04	May 25, 2021	May 24, 2022
Measurement Software	AUDIX	e3	6.120210k	NA	NA

Note: Calibration Interval of instruments listed above is one year.

Test Item	Radiated Emission				
Test Site	966 chamber1 / (03CH01-WS)				
Tested Date	Mar. 21, 2022				
Instrument	Brand	Model No.	Serial No.	Calibration Date	Calibration Until
Wireless connectivity tester	R&S	CMW270	100856	Nov. 01, 2021	Oct. 31, 2022
Receiver	R&S	ESR3	101657	Mar. 15, 2022	Mar. 14, 2023
Spectrum Analyzer	R&S	FSV40	101063	Apr. 19, 2021	Apr. 18, 2022
Loop Antenna	R&S	HFH2-Z2	100330	Nov. 08, 2021	Nov. 07, 2022
Bilog Antenna	SCHWARZBECK	VULB9168	VULB9168-522	Jun. 30, 2021	Jun. 29, 2022
Horn Antenna 1G-18G	SCHWARZBECK	BBHA 9120 D	BBHA 9120 D 1096	Dec. 03, 2021	Dec. 02, 2022
Horn Antenna 18G-40G	SCHWARZBECK	BBHA 9170	BBHA 9170508	Jan. 11, 2022	Jan. 10, 2023
Preamplifier	EMC	EMC02325	980225	Jun. 29, 2021	Jun. 28, 2022
Preamplifier	Agilent	83017A	MY39501308	Sep. 28, 2021	Sep. 27, 2022
Preamplifier	EMC	EMC184045B	980192	Jul. 14, 2021	Jul. 13, 2022
Loop Antenna Cable	KOAX KABEL	101354-BW	101354-BW	Oct. 05, 2021	Oct. 04, 2022
LF cable 3M	Woken	CFD400NL-LW	CFD400NL-001	Oct. 05, 2021	Oct. 04, 2022
LF cable 11M	EMC	EMCCFD400-NW-N W-11000	200801	Oct. 05, 2021	Oct. 04, 2022
LF cable 1M	EMC	EMCCFD400-NM-N M-1000	160502	Oct. 05, 2021	Oct. 04, 2022
RF Cable	EMC	EMC104-35M-35M-8000	210920	Oct. 05, 2021	Oct. 04, 2022
RF Cable	HUBER+SUHNER	SUCOFLEX104	MY16019/4	Oct. 05, 2021	Oct. 04, 2022
Measurement Software	AUDIX	e3	6.120210g	NA	NA

Note: Calibration Interval of instruments listed above is one year.

Test Item	RF Conducted				
Test Site	(TH01-WS)				
Tested Date	Mar. 28, 2022				
Instrument	Brand	Model No.	Serial No.	Calibration Date	Calibration Until
Wireless connectivity tester	R&S	CMW270	100856	Nov. 01, 2021	Oct. 31, 2022
Spectrum Analyzer	R&S	FSV40	101498	Nov. 29, 2021	Nov. 28, 2022
Power Meter	Anritsu	ML2495A	1241002	Nov. 07, 2021	Nov. 06, 2022
Power Sensor	Anritsu	MA2411B	1207366	Nov. 07, 2021	Nov. 06, 2022
Measurement Software	Sporton	SENSE-15247_FS	V5.10.7.11	NA	NA
Note: Calibration Interval of instruments listed above is one year.					

1.5 Test Standards

47 CFR FCC Part 15.247
ANSI C63.10-2013

1.6 Reference Guidance

FCC KDB 558074 D01 15.247 Meas Guidance v05r02

1.7 Deviation from Test Standard and Measurement Procedure

None

1.8 Measurement Uncertainty

The measurement uncertainties given below are based on a 95% confidence level (based on a coverage factor (k=2)).

Measurement Uncertainty	
Parameters	Uncertainty
Bandwidth	±34.130 Hz
Conducted power	±0.808 dB
Power density	±0.583 dB
Conducted emission	±2.715 dB
AC conducted emission	±2.92 dB
Radiated emission ≤ 1GHz	±3.41 dB
Radiated emission > 1GHz	±4.59 dB
Time	±0.1%

2 Test Configuration

2.1 Testing Facility

Test Laboratory	International Certification Corporation
Test Site	CO01-WS, 03CH01-WS, TH01-WS
Address of Test Site	No.3-1, Lane 6, Wen San 3rd St., Kwei Shan Dist., Tao Yuan City 33381, Taiwan (R.O.C.)

- FCC Designation No.: TW2732
- FCC site registration No.: 181692
- ISED#: 10807A
- CAB identifier: TW2732

2.2 The Worst Test Modes and Channel Details

Test item	Mode	Test Frequency (MHz)	Data Rate (Mbps)	Test Configuration
Conducted Emissions Radiated Emissions \leq 1GHz	GFSK	2441	1Mbps	1, 2
Radiated Emissions > 1GHz	GFSK 8DPSK	2402, 2441, 2480 2402, 2441, 2480	1Mbps 3Mbps	1
Conducted Output Power	GFSK π/4 DQPSK 8DPSK	2402, 2441, 2480 2402, 2441, 2480 2402, 2441, 2480	1Mbps 2Mbps 3Mbps	1
Number of Hopping Channels	GFSK π/4 DQPSK 8DPSK	2402~2480 2402~2480 2402~2480	1Mbps 2Mbps 3Mbps	1
Hopping Channel Separation 20dB and Occupied bandwidth	GFSK π/4 DQPSK 8DPSK	2402, 2441, 2480 2402, 2441, 2480 2402, 2441, 2480	1Mbps 2Mbps 3Mbps	1
Dwell Time	GFSK π/4 DQPSK 8DPSK	2402 2402 2402	1Mbps 2Mbps 3Mbps	1

NOTE:

1. The EUT was pretested with 3 orientations placed on the table for the radiated emission measurement – X, Y, and Z-plane. The **Y-plane** results were found as the worst case and were shown in this report.
2. Test configurations are listed as following:
 - 1) Configuration 1: with USB cable
 - 2) Configuration 2: with USB dongle stand

3 Transmitter Test Results

3.1 Conducted Emissions

3.1.1 Limit of Conducted Emissions

Conducted Emissions Limit		
Frequency Emission (MHz)	Quasi-Peak	Average
0.15-0.5	66 - 56 *	56 - 46 *
0.5-5	56	46
5-30	60	50

Note 1: * Decreases with the logarithm of the frequency.

3.1.2 Test Procedures

1. The device is placed on a test table, raised 80 cm above the reference ground plane. The vertical conducting plane is located 40 cm to the rear of the device.
2. The device is connected to line impedance stabilization network (LISN) and other accessories are connected to other LISN. Measured levels of AC power line conducted emission are across the 50 Ω LISN port.
3. AC conducted emission measurements is made over frequency range from 150 kHz to 30 MHz.
4. This measurement was performed with AC 120V/60Hz

3.1.3 Test Setup



- Note: 1. Support units were connected to second LISN.
2. Both of LISNs (AMN) are 80 cm from EUT and at least 80 cm from other units and other metal planes

3.1.4 Test Results

Refer to Appendix A.

3.2 Unwanted Emissions into Restricted Frequency Bands

3.2.1 Limit of Unwanted Emissions into Restricted Frequency Bands

Restricted Band Emissions Limit			
Frequency Range (MHz)	Field Strength (uV/m)	Field Strength (dBuV/m)	Measure Distance (m)
0.009~0.490	2400/F(kHz)	48.5 - 13.8	300
0.490~1.705	24000/F(kHz)	33.8 - 23	30
1.705~30.0	30	29	30
30~88	100	40	3
88~216	150	43.5	3
216~960	200	46	3
Above 960	500	54	3

Note 1:
Qusai-Peak value is measured for frequency below 1GHz except for 9–90 kHz, 110–490 kHz frequency band. Peak and average value are measured for frequency above 1GHz. The limit on average radio frequency emission is as above table. The limit on peak radio frequency emissions is 20 dB above the maximum permitted average emission limit

Note 2:
Measurements may be performed at a distance other than what is specified provided. When performing measurements at a distance other than that specified, the results shall be extrapolated to the specified distance using an extrapolation factor as below, Frequency at or above 30 MHz: 20 dB/decade Frequency below 30 MHz: 40 dB/decade.

3.2.2 Test Procedures

1. Measurement is made at a semi-anechoic chamber that incorporates a turntable allowing a EUT rotation of 360°. A continuously-rotating, remotely-controlled turntable is installed at the test site to support the EUT and facilitate determination of the direction of maximum radiation for each EUT emission frequency. The EUT is placed at test table. For emissions testing at or below 1 GHz, the table height is 80 cm above the reference ground plane. For emission measurements above 1 GHz, the table height is 1.5 m
2. Measurement is made with the antenna positioned in both the horizontal and vertical planes of polarization. The measurement antenna is varied in height (1m ~ 4m) above the reference ground plane to obtain the maximum signal strength. Distance between EUT and antenna is 3 m.
3. This investigation is performed with the EUT rotated 360°, the antenna height scanned between 1 m and 4 m, and the antenna rotated to repeat the measurements for both the horizontal and vertical antenna polarizations.

Note:

1. 120kHz measurement bandwidth of test receiver and Quasi-peak detector is for radiated emission below 1GHz.
2. Radiated emission above 1GHz / Peak value
RBW=1MHz, VBW=3MHz and Peak detector
Radiated emission above 1GHz / Average value for harmonics
The average value is: Average = Peak value + 20log(Duty cycle) Where the duty factor is calculated from following formula for DH5 packet type which has worst duty factor:
3.
$$20\log(\text{Duty cycle}) = 20\log \frac{1\text{s} / 1600 * 5}{100\text{ ms}} = -30.1\text{dB}$$
4. Radiated emission above 1GHz / Average value for other emissions
RBW=1MHz, VBW=1/T and Peak detector

3.2.3 Test Setup

Radiated Emissions below 1 GHz

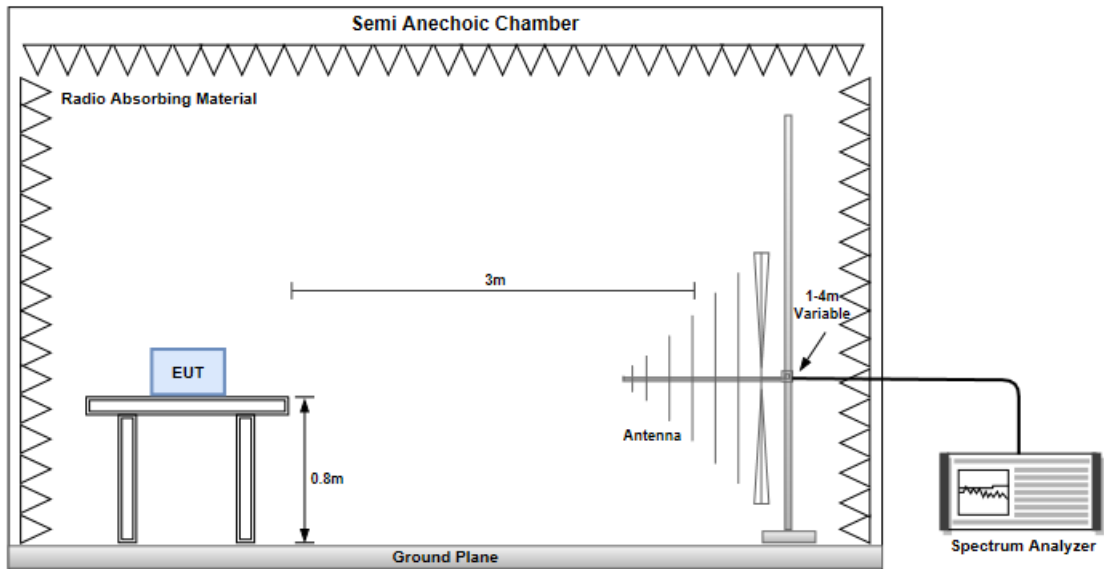

Radiated Emissions above 1 GHz

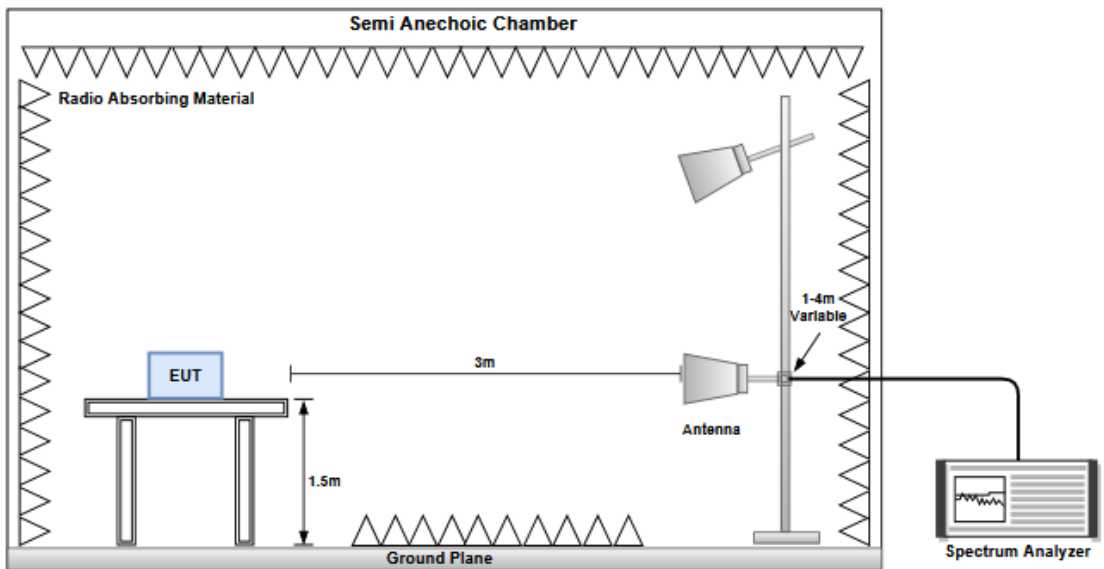

3.2.4 Test Results

Refer to Appendix B.

3.3 Unwanted Emissions into Non-Restricted Frequency Bands

3.3.1 Limit of Unwanted Emissions into Non-Restricted Frequency Bands

Peak power in any 100 kHz bandwidth outside of the authorized frequency band shall be attenuated by at least 20 dB relative to the maximum in-band peak PSD level in 100 kHz.

3.3.2 Test Procedures

Reference level measurement

1. Set RBW=100kHz, VBW = 300kHz , Detector = Peak, Sweep time = Auto
2. Trace = max hold , Allow Trace to fully stabilize
3. Use the peak marker function to determine the maximum PSD level

Emission level measurement

1. Set RBW=100kHz, VBW = 300kHz , Detector = Peak, Sweep time = Auto
2. Trace = max hold , Allow Trace to fully stabilize
3. Scan Frequency range is up to 25GHz
4. Use the peak marker function to determine the maximum amplitude level

3.3.3 Test Setup

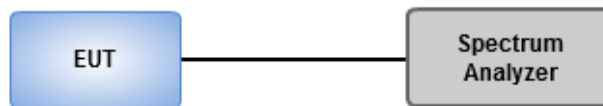

3.3.4 Test Results

Ambient Condition	21°C / 67%	Tested By	Aska Huang
--------------------------	------------	------------------	------------

Refer to Appendix C.

3.4 Conducted Output Power

3.4.1 Limit of Conducted Output Power

- 1 Watt
For frequency hopping systems operating in the 2400–2483.5 MHz band employing at least 75 non overlapping hopping channels, and all frequency hopping systems in the 5725–5850 MHz band.
- 0.125 Watt
For all other frequency hopping systems in the 2400–2483.5 MHz band.
- 0.125 Watt
For Frequency hopping systems operating in the 2400–2483.5 MHz band have hopping channel carrier frequencies that are separated by two-thirds of the 20 dB bandwidth of the hopping channel.

3.4.2 Test Procedures

1. A wideband power meter is used for power measurement. Bandwidth of power sensor and meter is 50MHz
2. If duty cycle of test signal is not 100 %, trigger and gating function of power meter will be enabled to capture transmission burst for measuring output power

3.4.3 Test Setup

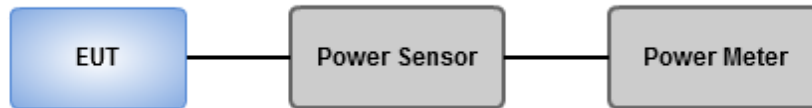

3.4.4 Test Results

Ambient Condition	21°C / 67%	Tested By	Aska Huang
--------------------------	------------	------------------	------------

Refer to Appendix D.

3.5 Number of Hopping Frequency

3.5.1 Limit of Number of Hopping Frequency

Frequency hopping systems in the 2400–2483.5 MHz band shall use at least 15 channels.

3.5.2 Test Procedures

1. Set RBW = 100kHz, VBW = 300kHz, Sweep time = Auto, Detector = Peak Trace max hold.
2. Allow trace to stabilize.

3.5.3 Test Setup

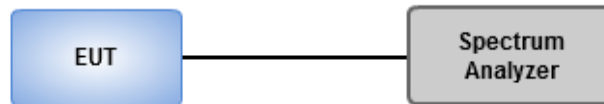

3.5.4 Test Results

Ambient Condition	21°C / 67%	Tested By	Aska Huang
-------------------	------------	-----------	------------

Refer to Appendix E.

3.6 20dB and Occupied Bandwidth

3.6.1 Test Procedures

20dB Bandwidth

1. Set RBW=20kHz, VBW=100kHz, Sweep time = Auto, Detector=Peak , Trace max hold
2. Allow trace to stabilize
3. Measure the maximum width of the emission that is constrained by the frequencies associated with the two outermost amplitude points (upper and lower) that are attenuated by 20 dB relative to the maximum level measured in the fundamental emission.

Occupied Bandwidth

1. Set RBW=20kHz, VBW=100kHz, Sweep time = Auto, Detector=Sample , Trace max hold
2. Allow trace to stabilize
3. Use Occupied bandwidth function of spectrum analyzer to measuring 99% occupied bandwidth

3.6.2 Test Setup

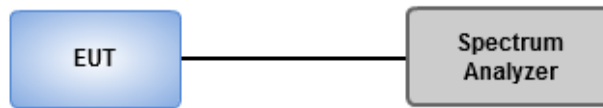

3.6.3 Test Results

Ambient Condition	21°C / 67%	Tested By	Aska Huang
--------------------------	------------	------------------	------------

Refer to Appendix F.

3.7 Channel Separation

3.7.1 Limit of Channel Separation

- Frequency hopping systems shall have hopping channel carrier frequencies separated by a minimum of 25 kHz or the 20 dB bandwidth of the hopping channel, whichever is greater.
- Frequency hopping systems operating in the 2400–2483.5 MHz band may have hopping channel carrier frequencies that are separated by 25 kHz or two-thirds of the 20 dB bandwidth of the hopping channel, whichever is greater.

3.7.2 Test Procedures

1. Set RBW=30kHz, VBW=100kHz, Sweep time = Auto, Detector=Peak Trace max hold
2. Allow trace to stabilize
3. Use the marker-delta function to determine the separation between the peaks of the adjacent channels. The EUT shall show compliance with the appropriate regulatory limit

3.7.3 Test Setup

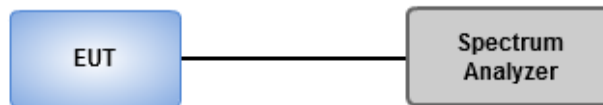

3.7.4 Test Results

Ambient Condition	21°C / 67%	Tested By	Aska Huang
--------------------------	------------	------------------	------------

Refer to Appendix G.

3.8 Number of Dwell Time

3.8.1 Limit of Dwell time

The average time of occupancy on any channel shall not be greater than 0.4 seconds within a period of 0.4 seconds multiplied by the number of hopping channels employed.

3.8.2 Test Procedures

1. Set RBW=300 kHz, VBW=1 MHz, Sweep time=8 ms, Detector=Peak, Span=0 Hz, Trace max hold.
2. Enable gating and trigger function of spectrum analyzer to measure burst on time.
3. Set RBW=300 kHz, VBW=1 MHz, Sweep time=5 s / 2 s, Detector=Peak, Span=0 Hz, Trace max hold.
4. Enable gating and trigger function of spectrum analyzer to measure burst on number of transmission.
5. Set RBW=300 kHz, VBW=1 MHz, Sweep time=31.6 s / 8 s, Detector=Peak, Span=0 Hz, Trace max hold.
6. Enable gating and trigger function of spectrum analyzer to measure burst on number of transmission of entire time cycle.

3.8.3 Test Setup

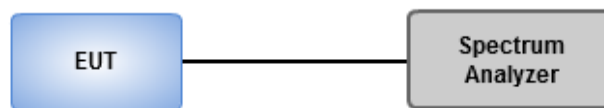

3.8.4 Test Results

Ambient Condition	21°C / 67%	Tested By	Aska Huang
--------------------------	------------	------------------	------------

Refer to Appendix H.

4 Test laboratory information

Established in 2012, ICC provides foremost EMC & RF Testing and advisory consultation services by our skilled engineers and technicians. Our services employ a wide variety of advanced edge test equipment and one of the widest certification extents in the business.

International Certification Corporation (EMC and Wireless Communication Laboratory), it is our definitive objective is to institute long term, trust-based associations with our clients. The expectation we set up with our clients is based on outstanding service, practical expertise and devotion to a certified value structure. Our passion is to grant our clients with best EMC / RF services by oriented knowledgeable and accommodating staff.

Our Test sites are located at Linkou District and Kwei Shan District. Location map can be found on our website <http://www.icertifi.com.tw>.

Linkou

Tel: 886-2-2601-1640

No.30-2, Ding Fwu Tsuen, Lin Kou
District, New Taipei City, Taiwan
(R.O.C.)

Kwei Shan

Tel: 886-3-271-8666

No.3-1, Lane 6, Wen San 3rd
St., Kwei Shan Dist., Tao Yuan
City 33381, Taiwan (R.O.C.)
No.2-1, Lane 6, Wen San 3rd
St., Kwei Shan Dist., Tao Yuan
City 33381, Taiwan (R.O.C.)

Kwei Shan Site II

Tel: 886-3-271-8640

No.14-1, Lane 19, Wen San 3rd
St., Kwei Shan Dist., Tao Yuan
City 333, Taiwan (R.O.C.)

If you have any suggestion, please feel free to contact us as below information.

Tel: 886-3-271-8666

Fax: 886-3-318-0345

Email: ICC_Service@icertifi.com.tw

==END==



Configuration 1: with USB cable

Modulation	8DPSK	Test Freq. (MHz)	2441
Power Phase	Line		

Test by : Joe Liao Temperature: 23°C Humidity: 60%

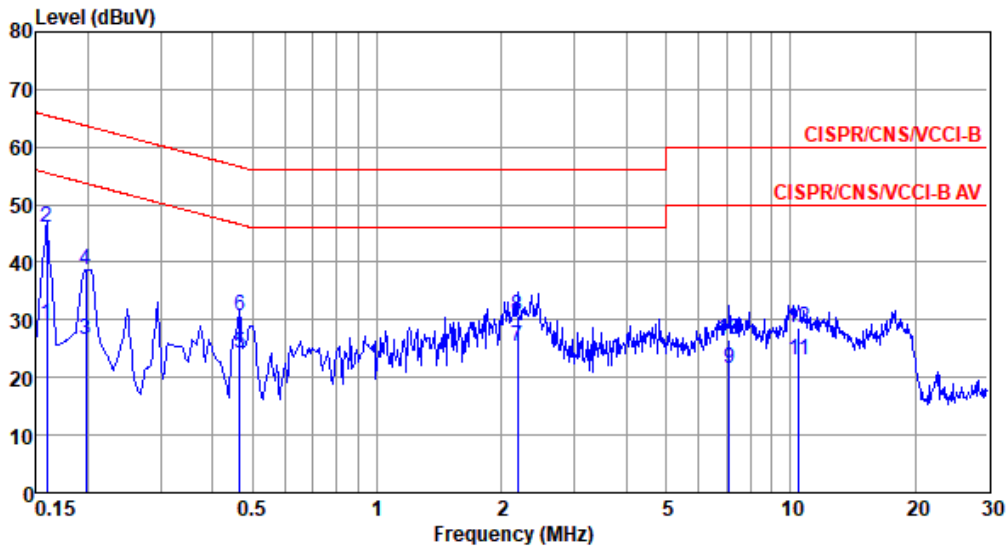

	Freq	Level	Limit	Over	Read	Factor	Cable	Aux	Remark
	MHz	dBuV	Line	Limit	Level	dB	loss	dB	
			dBuV	dB	dBuV		dB		
1	0.159	29.30	55.52	-26.22	19.62	9.60	0.08	0.00	Average
2*	0.159	46.10	65.52	-19.42	36.42	9.60	0.08	0.00	QP
3	0.198	26.43	53.71	-27.28	16.74	9.61	0.08	0.00	Average
4	0.198	38.53	63.71	-25.18	28.84	9.61	0.08	0.00	QP
5	0.466	24.25	46.58	-22.33	14.56	9.60	0.09	0.00	Average
6	0.466	30.72	56.58	-25.86	21.03	9.60	0.09	0.00	QP
7	2.190	25.36	46.00	-20.64	15.54	9.62	0.20	0.00	Average
8	2.190	30.71	56.00	-25.29	20.89	9.62	0.20	0.00	QP
9	7.100	21.53	50.00	-28.47	11.53	9.64	0.36	0.00	Average
10	7.100	26.50	60.00	-33.50	16.50	9.64	0.36	0.00	QP
11	10.452	22.90	50.00	-27.10	12.79	9.65	0.46	0.00	Average
12	10.452	28.56	60.00	-31.44	18.45	9.65	0.46	0.00	QP

Note 1: Level (dBuV) = Read Level (dBuV) + LISN Factor (dB) + Cable Loss (dB) + Aux (dB).
 2: Over Limit (dB) = Level (dBuV) – Limit Line (dBuV).



Modulation	8DPSK	Test Freq. (MHz)	2441
Power Phase	Neutral		

Test by : Joe Liao Temperature: 23°C Humidity: 60%

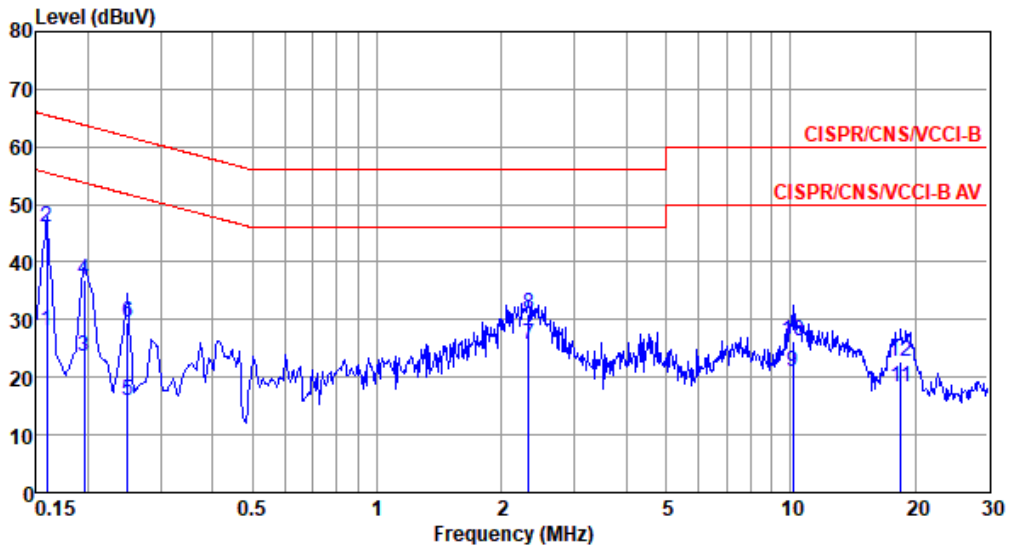

	Freq MHz	Level dBuV	Limit Line dBuV	Over Limit dB	Read Level dBuV	Factor dB	Cable loss dB	Aux dB	Remark
1	0.159	27.99	55.52	-27.53	18.32	9.59	0.08	0.00	Average
2*	0.159	46.16	65.52	-19.36	36.49	9.59	0.08	0.00	QP
3	0.195	23.62	53.80	-30.18	13.95	9.59	0.08	0.00	Average
4	0.195	36.95	63.80	-26.85	27.28	9.59	0.08	0.00	QP
5	0.249	15.81	51.78	-35.97	6.14	9.59	0.08	0.00	Average
6	0.249	29.50	61.78	-32.28	19.83	9.59	0.08	0.00	QP
7	2.321	25.69	46.00	-20.31	15.89	9.60	0.20	0.00	Average
8	2.321	30.92	56.00	-25.08	21.12	9.60	0.20	0.00	QP
9	10.125	20.89	50.00	-29.11	10.79	9.65	0.45	0.00	Average
10	10.125	26.20	60.00	-33.80	16.10	9.65	0.45	0.00	QP
11	18.524	18.17	50.00	-31.83	7.86	9.68	0.63	0.00	Average
12	18.524	22.80	60.00	-37.20	12.49	9.68	0.63	0.00	QP

Note 1: Level (dBuV) = Read Level (dBuV) + LISN Factor (dB) + Cable Loss (dB) + Aux (dB).
 2: Over Limit (dB) = Level (dBuV) – Limit Line (dBuV).



Configuration 2: with USB dongle stand

Modulation	8DPSK	Test Freq. (MHz)	2441
Power Phase	Line		

Test by : Joe Liao Temperature: 23°C Humidity: 60%

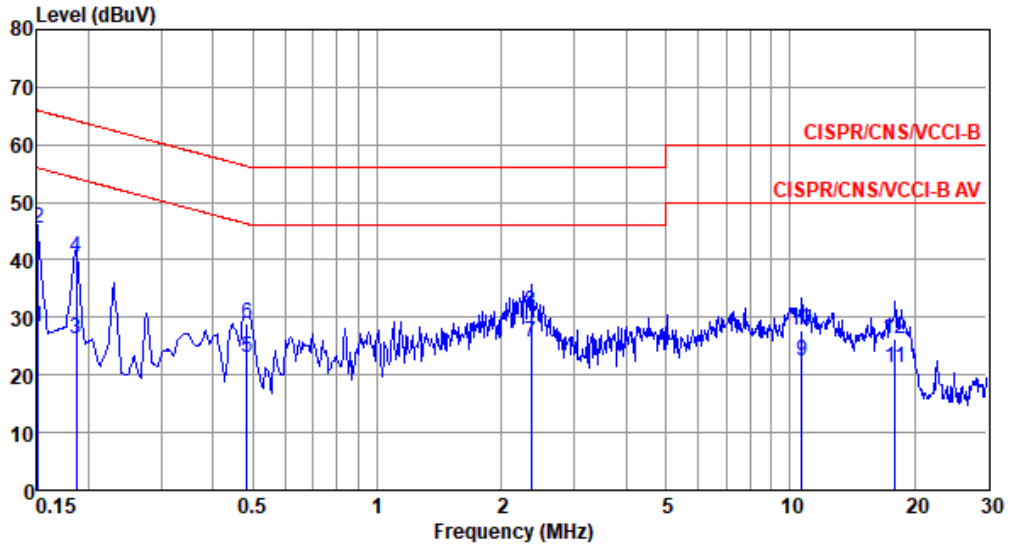

	Freq MHz	Level dBuV	Limit Line dBuV	Over Limit dB	Read Level dBuV	Factor dB	Cable loss dB	Aux dB	Remark
1	0.151	28.45	55.96	-27.51	18.77	9.60	0.08	0.00	Average
2	0.151	45.45	65.96	-20.51	35.77	9.60	0.08	0.00	QP
3	0.186	26.34	54.20	-27.86	16.65	9.61	0.08	0.00	Average
4	0.186	40.37	64.20	-23.83	30.68	9.61	0.08	0.00	QP
5	0.484	22.93	46.27	-23.34	13.23	9.60	0.10	0.00	Average
6	0.484	28.89	56.27	-27.38	19.19	9.60	0.10	0.00	QP
7*	2.358	25.75	46.00	-20.25	15.93	9.62	0.20	0.00	Average
8	2.358	30.98	56.00	-25.02	21.16	9.62	0.20	0.00	QP
9	10.676	22.37	50.00	-27.63	12.26	9.64	0.47	0.00	Average
10	10.676	27.84	60.00	-32.16	17.73	9.64	0.47	0.00	QP
11	17.944	21.32	50.00	-28.68	11.10	9.60	0.62	0.00	Average
12	17.944	26.37	60.00	-33.63	16.15	9.60	0.62	0.00	QP

Note 1: Level (dBuV) = Read Level (dBuV) + LISN Factor (dB) + Cable Loss (dB) + Aux (dB).
 2: Over Limit (dB) = Level (dBuV) – Limit Line (dBuV).



Modulation	8DPSK	Test Freq. (MHz)	2441
Power Phase	Neutral		

Test by : Joe Liao Temperature: 23°C Humidity: 60%

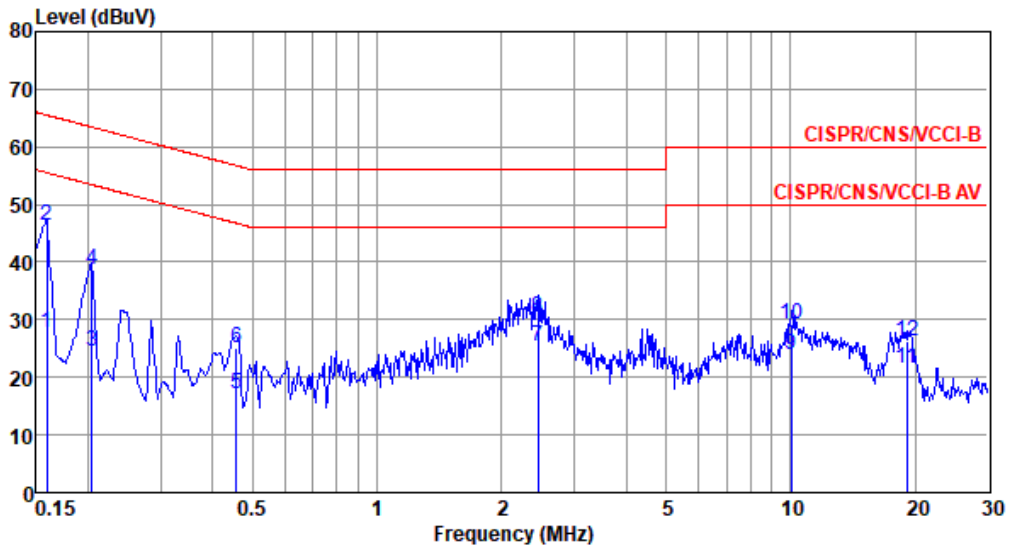

	Freq MHz	Level dBuV	Limit Line dBuV	Over Limit dB	Read Level dBuV	Factor dB	Cable loss dB	Aux dB	Remark
1	0.159	27.68	55.52	-27.84	18.01	9.59	0.08	0.00	Average
2*	0.159	46.23	65.52	-19.29	36.56	9.59	0.08	0.00	QP
3	0.204	24.44	53.45	-29.01	14.77	9.59	0.08	0.00	Average
4	0.204	38.65	63.45	-24.80	28.98	9.59	0.08	0.00	QP
5	0.456	17.22	46.76	-29.54	7.55	9.58	0.09	0.00	Average
6	0.456	25.20	56.76	-31.56	15.53	9.58	0.09	0.00	QP
7	2.448	25.25	46.00	-20.75	15.45	9.60	0.20	0.00	Average
8	2.448	30.40	56.00	-25.60	20.60	9.60	0.20	0.00	QP
9	10.019	23.79	50.00	-26.21	13.69	9.65	0.45	0.00	Average
10	10.019	29.17	60.00	-30.83	19.07	9.65	0.45	0.00	QP
11	19.122	21.60	50.00	-28.40	11.28	9.68	0.64	0.00	Average
12	19.122	26.37	60.00	-33.63	16.05	9.68	0.64	0.00	QP

Note 1: Level (dBuV) = Read Level (dBuV) + LISN Factor (dB) + Cable Loss (dB) + Aux (dB).
 2: Over Limit (dB) = Level (dBuV) – Limit Line (dBuV).



Configuration 1: with USB cable

Transmitter Radiated Unwanted Emissions (Below 1GHz)

Modulation	8DPSK	Test Freq. (MHz)	2441						
Polarization	Horizontal								
Test By :Brad Wu Temperature(°C):23 Humidity(%):64									
	Freq. MHz	Emission level dBuV/m	Limit dBuV/m	Margin dB	SA reading dBuV	Factor dB/m	Remark	ANT High cm	Turn Table deg
1	58.13	28.63	40.00	-11.37	37.82	-9.19	Peak	---	---
2	72.68	34.55	40.00	-5.45	45.98	-11.43	Peak	---	---
3	118.27	33.38	43.50	-10.12	44.24	-10.86	Peak	---	---
4	182.29	36.63	43.50	-6.87	47.07	-10.44	Peak	---	---
5	273.47	30.03	46.00	-15.97	38.98	-8.95	Peak	---	---
6	468.44	28.96	46.00	-17.04	32.95	-3.99	Peak	---	---

Note 1: Emission Level (dBuV/m) = SA Reading (dBuV) + Factor* (dB/m)
 *Factor includes antenna factor , cable loss and amplifier gain
 Note 2: Margin (dB) = Emission level (dBuV/m) – Limit (dBuV/m).
 Note 3: All spurious emissions below 30MHz are more than 20 dB below the limit.



Modulation	8DPSK	Test Freq. (MHz)	2441
Polarization	Vertical		

Test By :Brad Wu Temperature(°C):23 Humidity(%):64

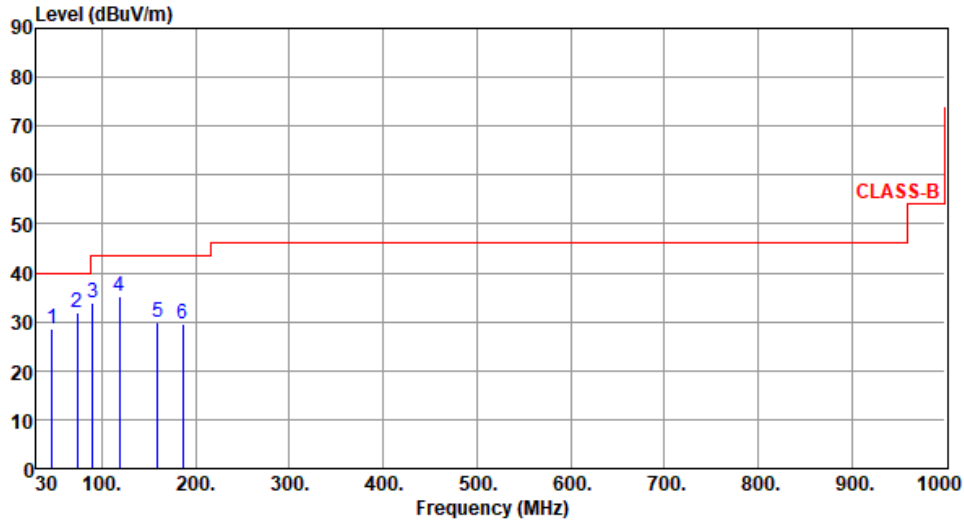

	Freq. MHz	Emission level dBuV/m	Limit dBuV/m	Margin dB	SA reading dBuV	Factor dB/m	Remark	ANT High cm	Turn Table deg
1	46.49	28.58	40.00	-11.42	37.07	-8.49	Peak	---	---
2	73.65	31.84	40.00	-8.16	43.70	-11.86	Peak	---	---
3	90.14	33.81	43.50	-9.69	48.51	-14.70	Peak	---	---
4	118.27	35.10	43.50	-8.40	45.96	-10.86	Peak	---	---
5	159.01	29.88	43.50	-13.62	38.57	-8.69	Peak	---	---
6	186.17	29.42	43.50	-14.08	40.34	-10.92	Peak	---	---

Note 1: Emission Level (dBuV/m) = SA Reading (dBuV) + Factor* (dB/m)

*Factor includes antenna factor , cable loss and amplifier gain

Note 2: Margin (dB) = Emission level (dBuV/m) – Limit (dBuV/m).

Note 3: All spurious emissions below 30MHz are more than 20 dB below the limit.



Transmitter Radiated Unwanted Emissions (Above 1GHz) for GFSK

Modulation	GFSK	Test Freq. (MHz)	2402
Polarization	Horizontal		

Test By :Brad Wu Temperature(°C):23 Humidity(%):64

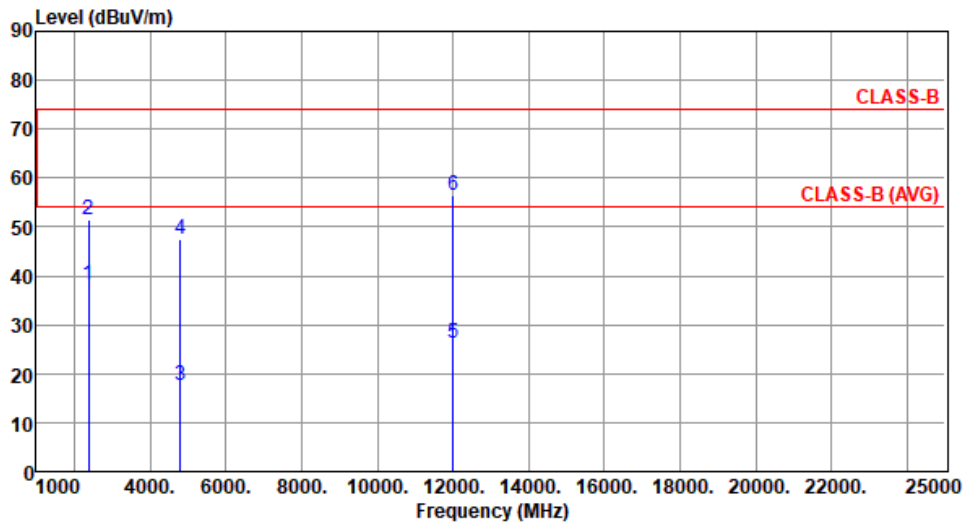

	Freq. MHz	Emission level dBuV/m	Limit dBuV/m	Margin dB	SA reading dBuV	Factor dB/m	Remark	ANT High cm	Turn Table deg
1	2390.00	38.34	54.00	-15.66	41.09	-2.75	Average	100	96
2	2390.00	51.56	74.00	-22.44	54.31	-2.75	Peak	100	96
3	4804.00	17.51	54.00	-36.49	13.38	4.13	Average	124	76
4	4804.00	47.61	74.00	-26.39	43.48	4.13	Peak	124	76
5	12010.00	26.26	54.00	-27.74	12.64	13.62	Average	100	19
6	12010.00	56.36	74.00	-17.64	42.74	13.62	Peak	100	19

Note 1: Emission Level (dBuV/m) = SA Reading (dBuV) + Factor* (dB/m)

*Factor includes antenna factor , cable loss and amplifier gain

Note 2: Margin (dB) = Emission level (dBuV/m) – Limit (dBuV/m).



Modulation	GFSK	Test Freq. (MHz)	2402
Polarization	Vertical		

Test By :Brad Wu Temperature(°C):23 Humidity(%):64

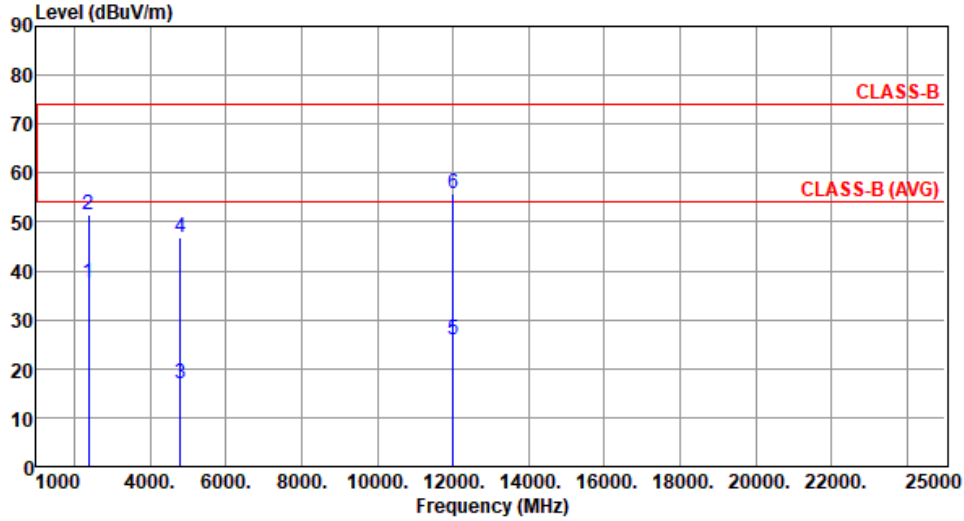

	Freq. MHz	Emission level dBuV/m	Limit dBuV/m	Margin dB	SA reading dBuV	Factor dB/m	Remark	ANT High cm	Turn Table deg
1	2390.00	37.61	54.00	-16.39	40.36	-2.75	Average	100	86
2	2390.00	51.46	74.00	-22.54	54.21	-2.75	Peak	100	86
3	4804.00	16.85	54.00	-37.15	12.72	4.13	Average	100	65
4	4804.00	46.95	74.00	-27.05	42.82	4.13	Peak	100	65
5	12010.00	25.85	54.00	-28.15	12.23	13.62	Average	100	25
6	12010.00	55.95	74.00	-18.05	42.33	13.62	Peak	100	25

Note 1: Emission Level (dBuV/m) = SA Reading (dBuV) + Factor* (dB/m)

*Factor includes antenna factor , cable loss and amplifier gain

Note 2: Margin (dB) = Emission level (dBuV/m) – Limit (dBuV/m).



Modulation	GFSK	Test Freq. (MHz)	2441
Polarization	Horizontal		

Test By :Brad Wu Temperature(°C):23 Humidity(%):64

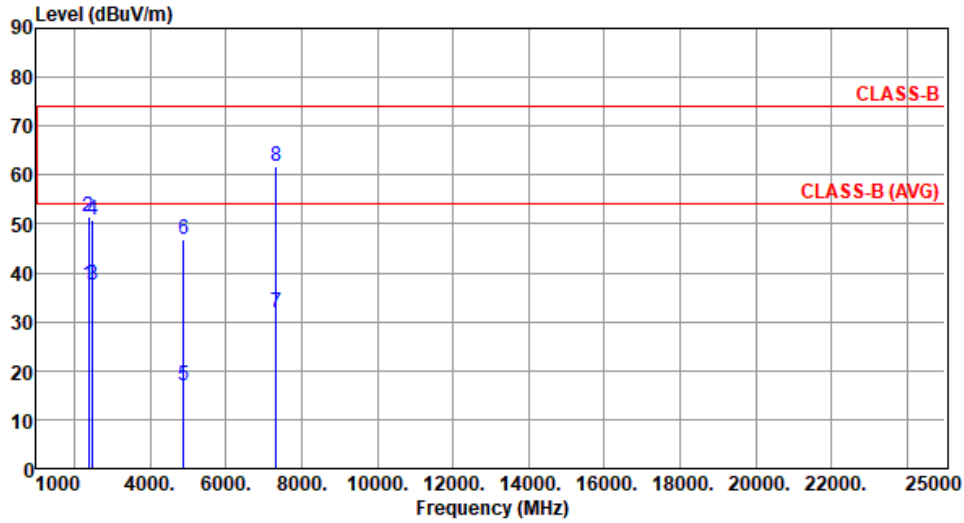

	Freq. MHz	Emission level dBuV/m	Limit dBuV/m	Margin dB	SA reading dBuV	Factor dB/m	Remark	ANT High cm	Turn Table deg
1	2390.00	37.57	54.00	-16.43	40.32	-2.75	Average	100	92
2	2390.00	51.41	74.00	-22.59	54.16	-2.75	Peak	100	92
3	2483.50	37.59	54.00	-16.41	40.29	-2.70	Average	100	92
4	2483.50	50.95	74.00	-23.05	53.65	-2.70	Peak	100	92
5	4882.00	16.85	54.00	-37.15	12.73	4.12	Average	129	78
6	4882.00	46.95	74.00	-27.05	42.83	4.12	Peak	129	78
7	7323.00	31.77	54.00	-22.23	22.50	9.27	Average	104	104
8	7323.00	61.87	74.00	-12.13	52.60	9.27	Peak	104	104

Note 1: Emission Level (dBuV/m) = SA Reading (dBuV) + Factor* (dB/m)

*Factor includes antenna factor , cable loss and amplifier gain

Note 2: Margin (dB) = Emission level (dBuV/m) – Limit (dBuV/m).



Modulation	GFSK	Test Freq. (MHz)	2441
Polarization	Vertical		

Test By :Brad Wu Temperature(°C):23 Humidity(%):64

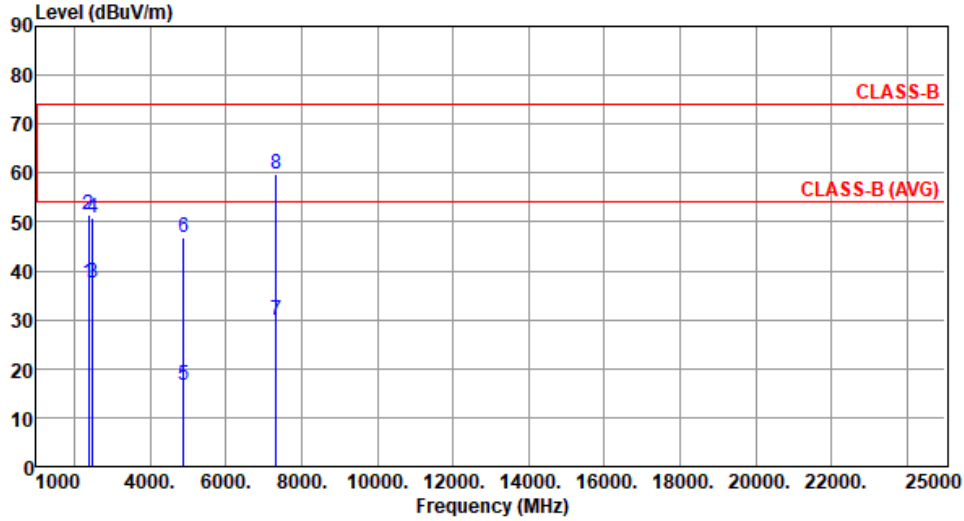

	Freq. MHz	Emission level dBUV/m	Limit dBUV/m	Margin dB	SA reading dBUV	Factor dB/m	Remark	ANT High cm	Turn Table deg
1	2390.00	37.56	54.00	-16.44	40.31	-2.75	Average	100	83
2	2390.00	51.37	74.00	-22.63	54.12	-2.75	Peak	100	83
3	2483.50	37.48	54.00	-16.52	40.18	-2.70	Average	100	83
4	2483.50	50.81	74.00	-23.19	53.51	-2.70	Peak	100	83
5	4882.00	16.59	54.00	-37.41	12.47	4.12	Average	100	61
6	4882.00	46.69	74.00	-27.31	42.57	4.12	Peak	100	61
7	7323.00	29.76	54.00	-24.24	20.49	9.27	Average	100	90
8	7323.00	59.86	74.00	-14.14	50.59	9.27	Peak	100	90

Note 1: Emission Level (dBUV/m) = SA Reading (dBUV) + Factor* (dB/m)

*Factor includes antenna factor , cable loss and amplifier gain

Note 2: Margin (dB) = Emission level (dBUV/m) – Limit (dBUV/m).



Modulation	GFSK	Test Freq. (MHz)	2480
Polarization	Horizontal		

Test By :Brad Wu Temperature(°C):23 Humidity(%):64

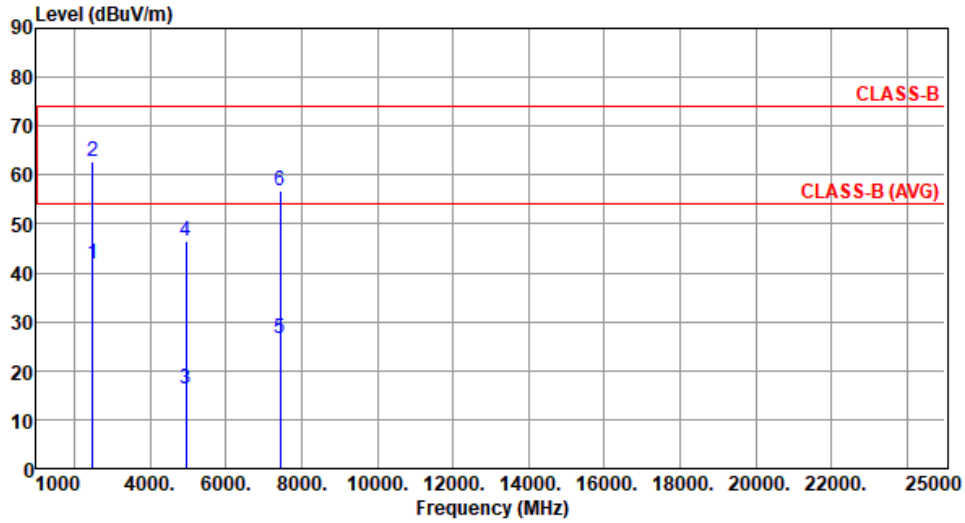

	Freq. MHz	Emission level dBuV/m	Limit dBuV/m	Margin dB	SA reading dBuV	Factor dB/m	Remark	ANT High cm	Turn Table deg
1	2483.50	41.81	54.00	-12.19	44.51	-2.70	Average	128	67
2	2483.50	62.90	74.00	-11.10	65.60	-2.70	Peak	128	67
3	4960.00	16.31	54.00	-37.69	12.28	4.03	Average	125	81
4	4960.00	46.41	74.00	-27.59	42.38	4.03	Peak	125	81
5	7440.00	26.69	54.00	-27.31	17.32	9.37	Average	106	125
6	7440.00	56.79	74.00	-17.21	47.42	9.37	Peak	106	125

Note 1: Emission Level (dBuV/m) = SA Reading (dBuV) + Factor* (dB/m)

*Factor includes antenna factor , cable loss and amplifier gain

Note 2: Margin (dB) = Emission level (dBuV/m) – Limit (dBuV/m).



Modulation	GFSK	Test Freq. (MHz)	2480
Polarization	Vertical		

Test By :Brad Wu Temperature(°C):23 Humidity(%):64

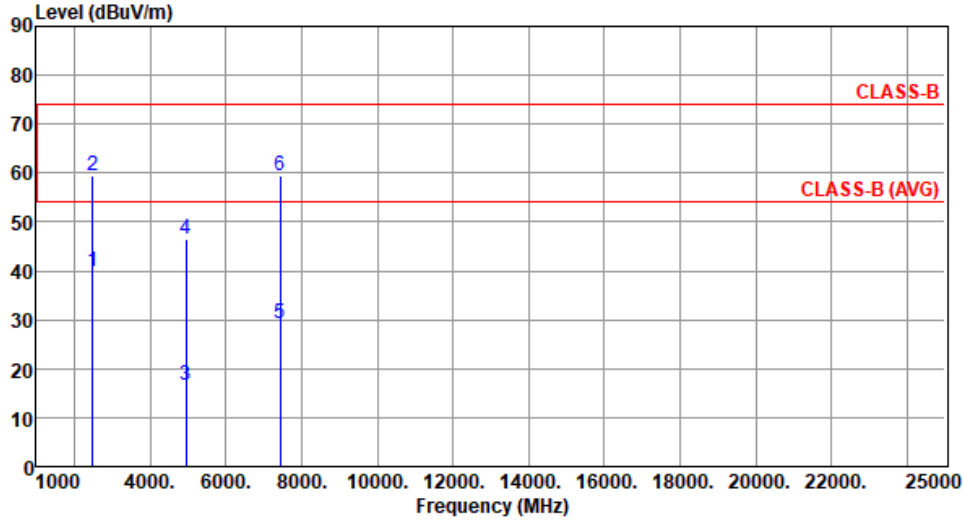

	Freq. MHz	Emission level dBuV/m	Limit dBuV/m	Margin dB	SA reading dBuV	Factor dB/m	Remark	ANT High cm	Turn Table deg
1	2483.50	39.96	54.00	-14.04	42.66	-2.70	Average	100	85
2	2483.50	59.42	74.00	-14.58	62.12	-2.70	Peak	100	85
3	4960.00	16.44	54.00	-37.56	12.41	4.03	Average	100	55
4	4960.00	46.54	74.00	-27.46	42.51	4.03	Peak	100	55
5	7440.00	29.25	54.00	-24.75	19.88	9.37	Average	100	88
6	7440.00	59.35	74.00	-14.65	49.98	9.37	Peak	100	88

Note 1: Emission Level (dBuV/m) = SA Reading (dBuV) + Factor* (dB/m)

*Factor includes antenna factor , cable loss and amplifier gain

Note 2: Margin (dB) = Emission level (dBuV/m) – Limit (dBuV/m).



Transmitter Radiated Unwanted Emissions (Above 1GHz) for 8DPSK

Modulation	8DPSK	Test Freq. (MHz)	2402
Polarization	Horizontal		

Test By :Brad Wu Temperature(°C):23 Humidity(%):64

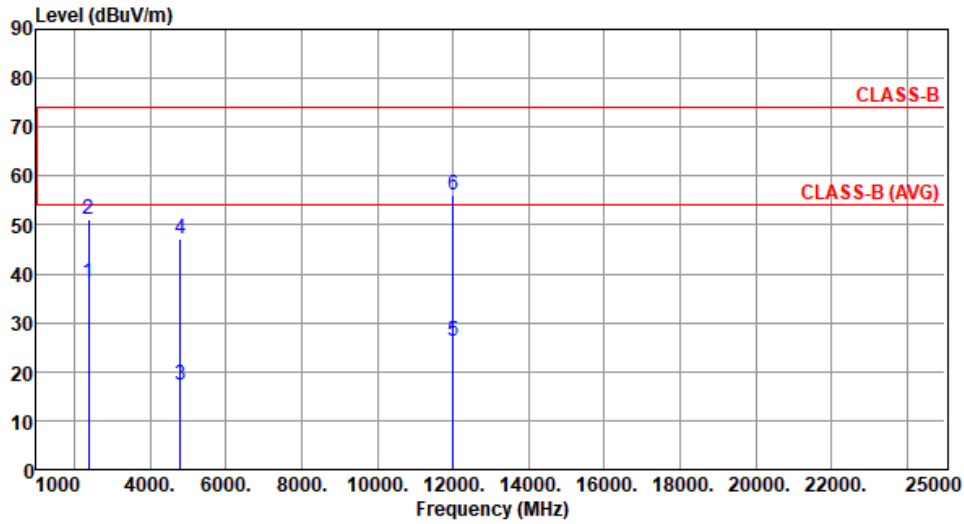

	Freq. MHz	Emission level dBuV/m	Limit dBuV/m	Margin dB	SA reading dBuV	Factor dB/m	Remark	ANT High cm	Turn Table deg
1	2390.00	38.14	54.00	-15.86	40.89	-2.75	Average	100	93
2	2390.00	51.08	74.00	-22.92	53.83	-2.75	Peak	100	93
3	4804.00	17.16	54.00	-36.84	13.03	4.13	Average	125	72
4	4804.00	47.26	74.00	-26.74	43.13	4.13	Peak	125	72
5	12010.00	26.14	54.00	-27.86	12.52	13.62	Average	100	21
6	12010.00	56.24	74.00	-17.76	42.62	13.62	Peak	100	21

Note 1: Emission Level (dBuV/m) = SA Reading (dBuV) + Factor* (dB/m)

*Factor includes antenna factor , cable loss and amplifier gain

Note 2: Margin (dB) = Emission level (dBuV/m) – Limit (dBuV/m).



Modulation	8DPSK	Test Freq. (MHz)	2402
Polarization	Vertical		

Test By :Brad Wu Temperature(°C):23 Humidity(%):64

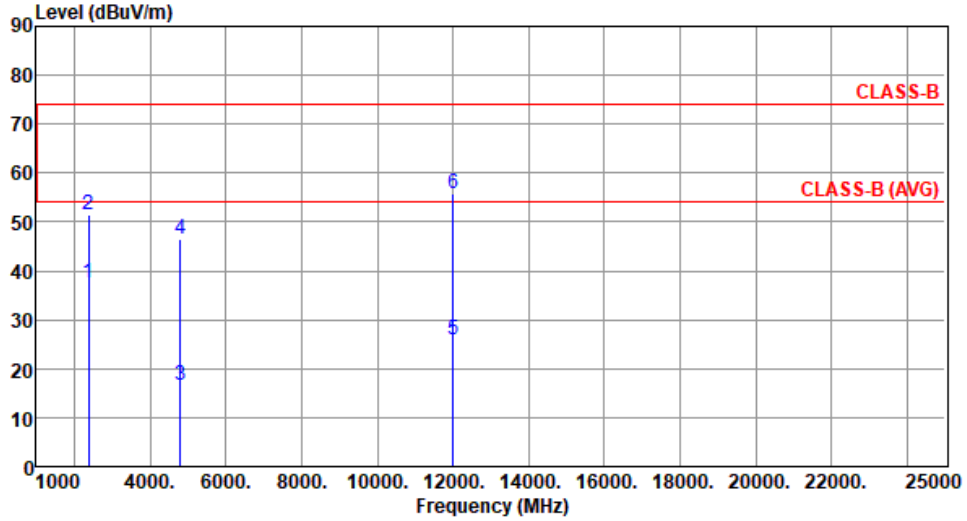

	Freq. MHz	Emission level dBuV/m	Limit dBuV/m	Margin dB	SA reading dBuV	Factor dB/m	Remark	ANT High cm	Turn Table deg
1	2390.00	37.54	54.00	-16.46	40.29	-2.75	Average	100	89
2	2390.00	51.42	74.00	-22.58	54.17	-2.75	Peak	100	89
3	4804.00	16.45	54.00	-37.55	12.32	4.13	Average	100	59
4	4804.00	46.55	74.00	-27.45	42.42	4.13	Peak	100	59
5	12010.00	25.78	54.00	-28.22	12.16	13.62	Average	100	28
6	12010.00	55.88	74.00	-18.12	42.26	13.62	Peak	100	28

Note 1: Emission Level (dBuV/m) = SA Reading (dBuV) + Factor* (dB/m)

*Factor includes antenna factor , cable loss and amplifier gain

Note 2: Margin (dB) = Emission level (dBuV/m) – Limit (dBuV/m).



Modulation	8DPSK	Test Freq. (MHz)	2441
Polarization	Horizontal		

Test By :Brad Wu Temperature(°C):23 Humidity(%):64

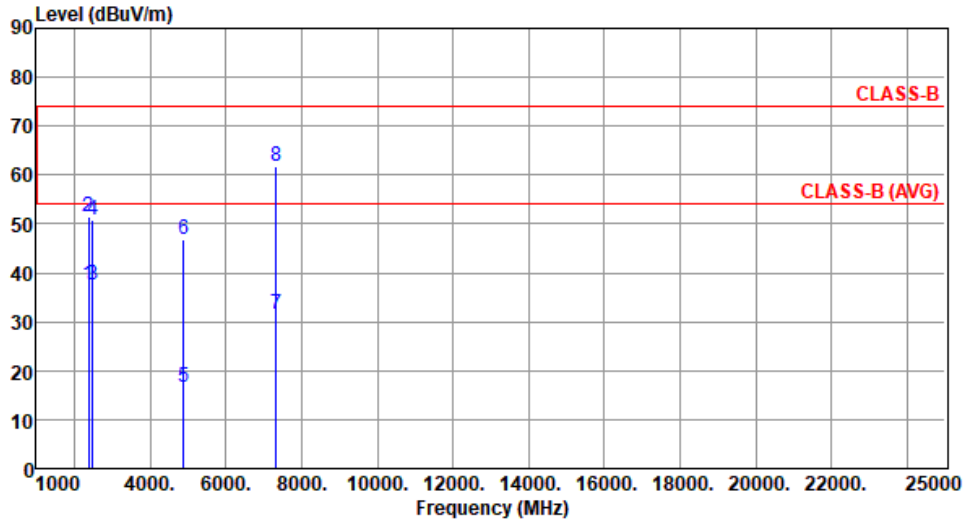

	Freq. MHz	Emission level dBuV/m	Limit dBuV/m	Margin dB	SA reading dBuV	Factor dB/m	Remark	ANT High cm	Turn Table deg
1	2390.00	37.46	54.00	-16.54	40.21	-2.75	Average	100	95
2	2390.00	51.38	74.00	-22.62	54.13	-2.75	Peak	100	95
3	2483.50	37.52	54.00	-16.48	40.22	-2.70	Average	100	95
4	2483.50	50.91	74.00	-23.09	53.61	-2.70	Peak	100	95
5	4882.00	16.71	54.00	-37.29	12.59	4.12	Average	128	79
6	4882.00	46.81	74.00	-27.19	42.69	4.12	Peak	128	79
7	7323.00	31.66	54.00	-22.34	22.39	9.27	Average	100	106
8	7323.00	61.76	74.00	-12.24	52.49	9.27	Peak	100	106

Note 1: Emission Level (dBuV/m) = SA Reading (dBuV) + Factor* (dB/m)

*Factor includes antenna factor , cable loss and amplifier gain

Note 2: Margin (dB) = Emission level (dBuV/m) – Limit (dBuV/m).



Modulation	8DPSK	Test Freq. (MHz)	2441
Polarization	Vertical		

Test By :Brad Wu Temperature(°C):23 Humidity(%):64

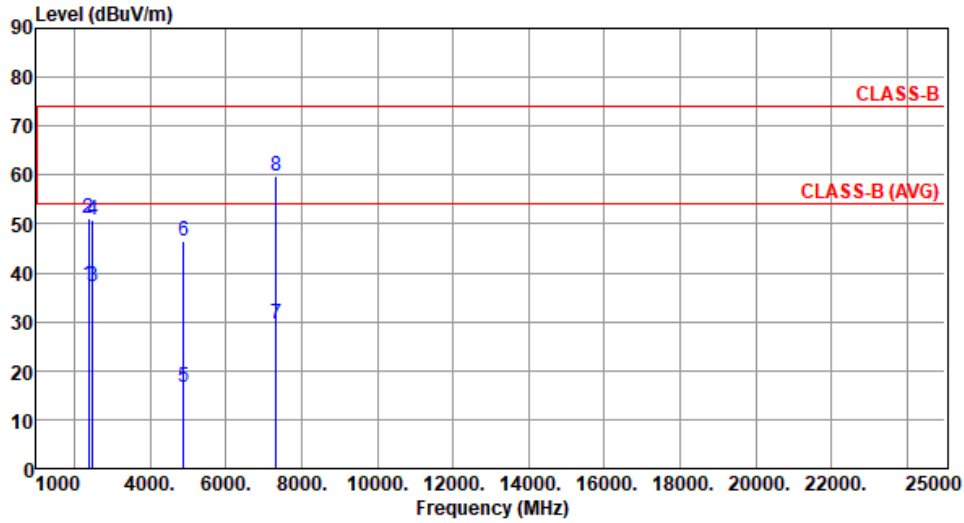

	Freq. MHz	Emission level dBUV/m	Limit dBUV/m	Margin dB	SA reading dBUV	Factor dB/m	Remark	ANT High cm	Turn Table deg
1	2390.00	37.48	54.00	-16.52	40.23	-2.75	Average	100	92
2	2390.00	51.29	74.00	-22.71	54.04	-2.75	Peak	100	92
3	2483.50	37.29	54.00	-16.71	39.99	-2.70	Average	100	92
4	2483.50	50.76	74.00	-23.24	53.46	-2.70	Peak	100	92
5	4882.00	16.45	54.00	-37.55	12.33	4.12	Average	100	58
6	4882.00	46.55	74.00	-27.45	42.43	4.12	Peak	100	58
7	7323.00	29.65	54.00	-24.35	20.38	9.27	Average	100	91
8	7323.00	59.75	74.00	-14.25	50.48	9.27	Peak	100	91

Note 1: Emission Level (dBUV/m) = SA Reading (dBUV) + Factor* (dB/m)

*Factor includes antenna factor , cable loss and amplifier gain

Note 2: Margin (dB) = Emission level (dBUV/m) – Limit (dBUV/m).



Modulation	8DPSK	Test Freq. (MHz)	2480
Polarization	Horizontal		

Test By :Brad Wu Temperature(°C):23 Humidity(%):64

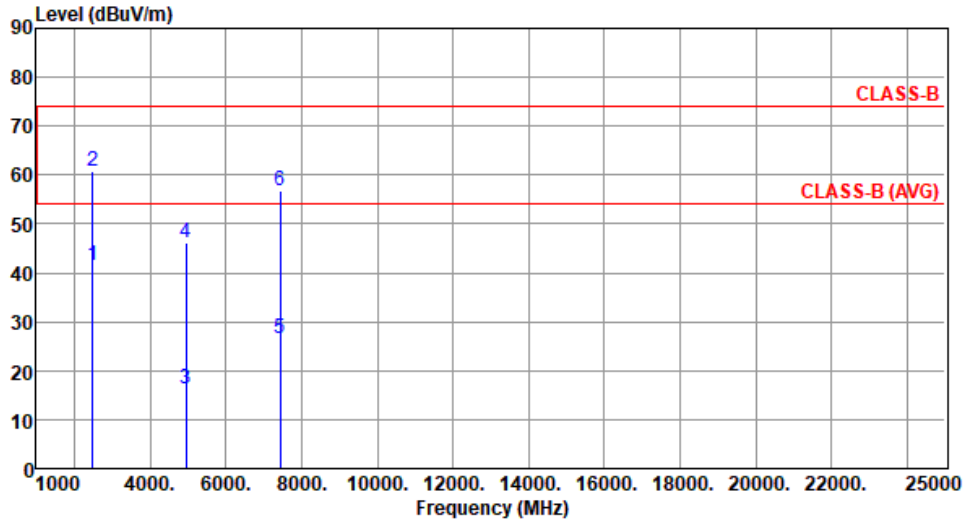

	Freq. MHz	Emission level dBUV/m	Limit dBUV/m	Margin dB	SA reading dBUV	Factor dB/m	Remark	ANT High cm	Turn Table deg
1	2483.50	41.42	54.00	-12.58	44.12	-2.70	Average	128	66
2	2483.50	60.82	74.00	-13.18	63.52	-2.70	Peak	128	66
3	4960.00	16.18	54.00	-37.82	12.15	4.03	Average	122	85
4	4960.00	46.28	74.00	-27.72	42.25	4.03	Peak	122	85
5	7440.00	26.58	54.00	-27.42	17.21	9.37	Average	105	128
6	7440.00	56.68	74.00	-17.32	47.31	9.37	Peak	105	128

Note 1: Emission Level (dBUV/m) = SA Reading (dBUV) + Factor* (dB/m)

*Factor includes antenna factor , cable loss and amplifier gain

Note 2: Margin (dB) = Emission level (dBUV/m) – Limit (dBUV/m).



Modulation	8DPSK	Test Freq. (MHz)	2480
Polarization	Vertical		

Test By :Brad Wu Temperature(°C):23 Humidity(%):64

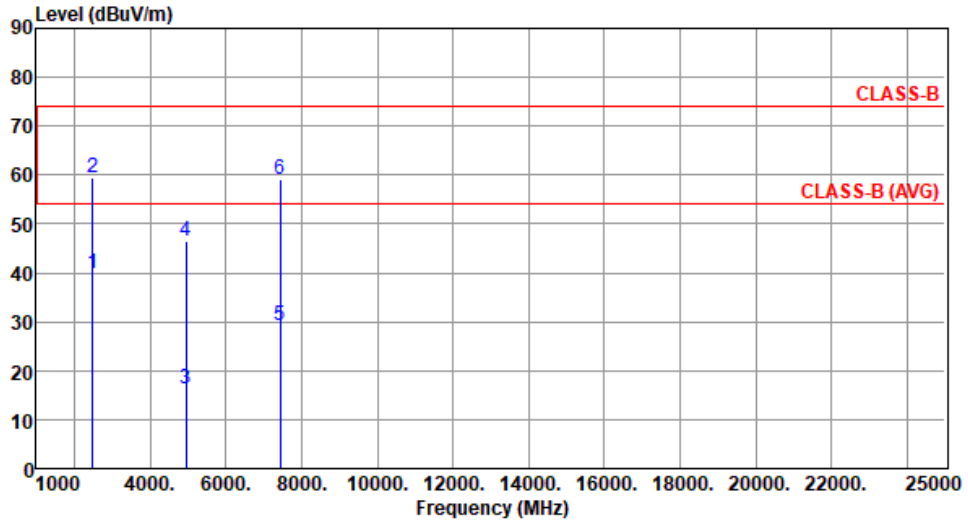

	Freq. MHz	Emission level dBuV/m	Limit dBuV/m	Margin dB	SA reading dBuV	Factor dB/m	Remark	ANT High cm	Turn Table deg
1	2483.50	39.88	54.00	-14.12	42.58	-2.70	Average	100	82
2	2483.50	59.36	74.00	-14.64	62.06	-2.70	Peak	100	82
3	4960.00	16.35	54.00	-37.65	12.32	4.03	Average	100	52
4	4960.00	46.45	74.00	-27.55	42.42	4.03	Peak	100	52
5	7440.00	29.18	54.00	-24.82	19.81	9.37	Average	100	94
6	7440.00	59.28	74.00	-14.72	49.91	9.37	Peak	100	94

Note 1: Emission Level (dBuV/m) = SA Reading (dBuV) + Factor* (dB/m)

*Factor includes antenna factor , cable loss and amplifier gain

Note 2: Margin (dB) = Emission level (dBuV/m) – Limit (dBuV/m).



Configuration 2: with USB dongle stand

Transmitter Radiated Unwanted Emissions (Below 1GHz)

Modulation	8DPSK	Test Freq. (MHz)	2441
Polarization	Horizontal		

Test By :Brad Wu Temperature(°C):23 Humidity(%):64

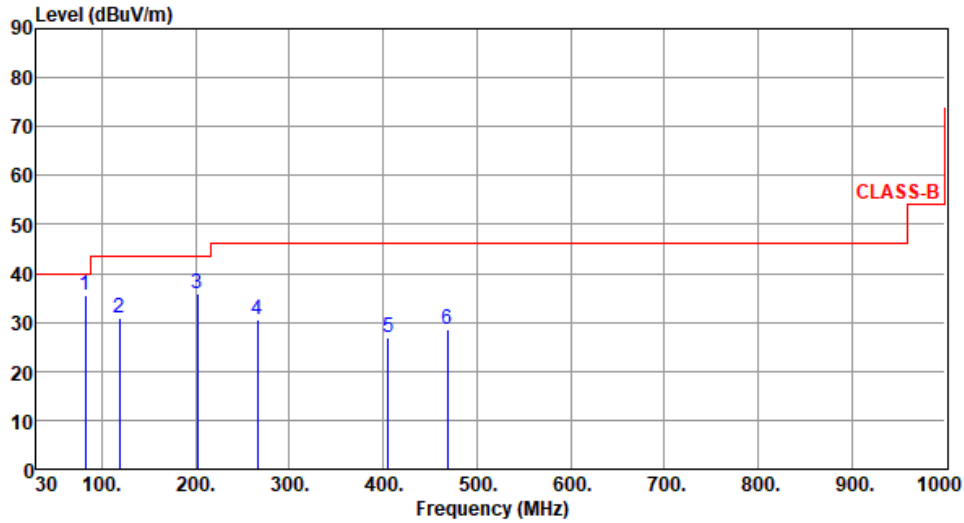

	Freq. MHz	Emission level dBuV/m	Limit dBuV/m	Margin dB	SA reading dBuV	Factor dB/m	Remark	ANT High cm	Turn Table deg
1	82.38	35.43	40.00	-4.57	49.33	-13.90	Peak	---	---
2	118.27	30.77	43.50	-12.73	41.63	-10.86	Peak	---	---
3	201.69	35.89	43.50	-7.61	47.80	-11.91	Peak	---	---
4	265.71	30.54	46.00	-15.46	39.92	-9.38	Peak	---	---
5	405.39	26.84	46.00	-19.16	32.50	-5.66	Peak	---	---
6	468.44	28.68	46.00	-17.32	32.67	-3.99	Peak	---	---

Note 1: Emission Level (dBuV/m) = SA Reading (dBuV) + Factor* (dB/m)

*Factor includes antenna factor , cable loss and amplifier gain

Note 2: Margin (dB) = Emission level (dBuV/m) – Limit (dBuV/m).

Note 3: All spurious emissions below 30MHz are more than 20 dB below the limit.



Modulation	8DPSK	Test Freq. (MHz)	2441
Polarization	Vertical		

Test By :Brad Wu Temperature(°C):23 Humidity(%):64

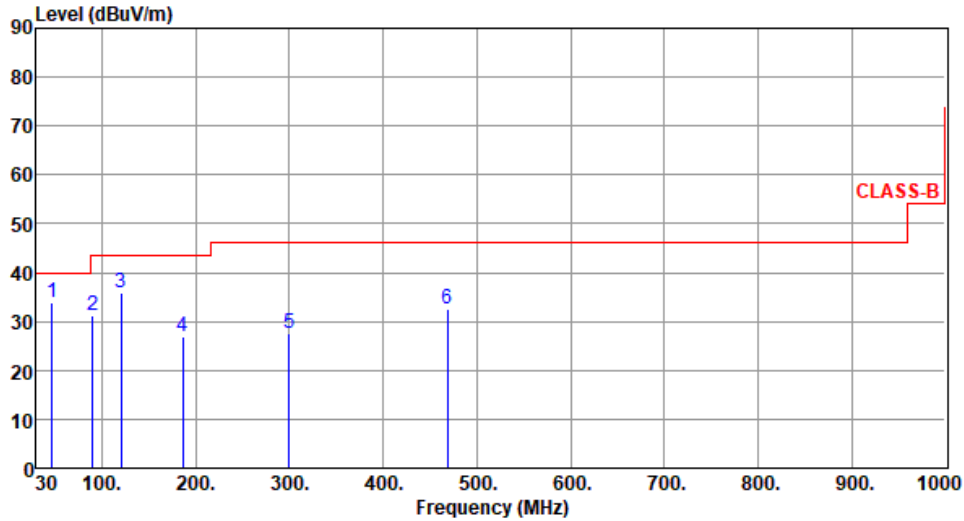

	Freq. MHz	Emission level dBUV/m	Limit dBUV/m	Margin dB	SA reading dBUV	Factor dB/m	Remark	ANT High cm	Turn Table deg
1	46.49	33.97	40.00	-6.03	42.46	-8.49	Peak	---	---
2	90.14	31.36	43.50	-12.14	46.06	-14.70	Peak	---	---
3	120.21	35.99	43.50	-7.51	46.67	-10.68	Peak	---	---
4	186.17	26.98	43.50	-16.52	37.90	-10.92	Peak	---	---
5	299.66	27.65	46.00	-18.35	35.78	-8.13	Peak	---	---
6	468.44	32.61	46.00	-13.39	36.60	-3.99	Peak	---	---

Note 1: Emission Level (dBUV/m) = SA Reading (dBUV) + Factor* (dB/m)

*Factor includes antenna factor , cable loss and amplifier gain

Note 2: Margin (dB) = Emission level (dBUV/m) – Limit (dBUV/m).

Note 3: All spurious emissions below 30MHz are more than 20 dB below the limit.

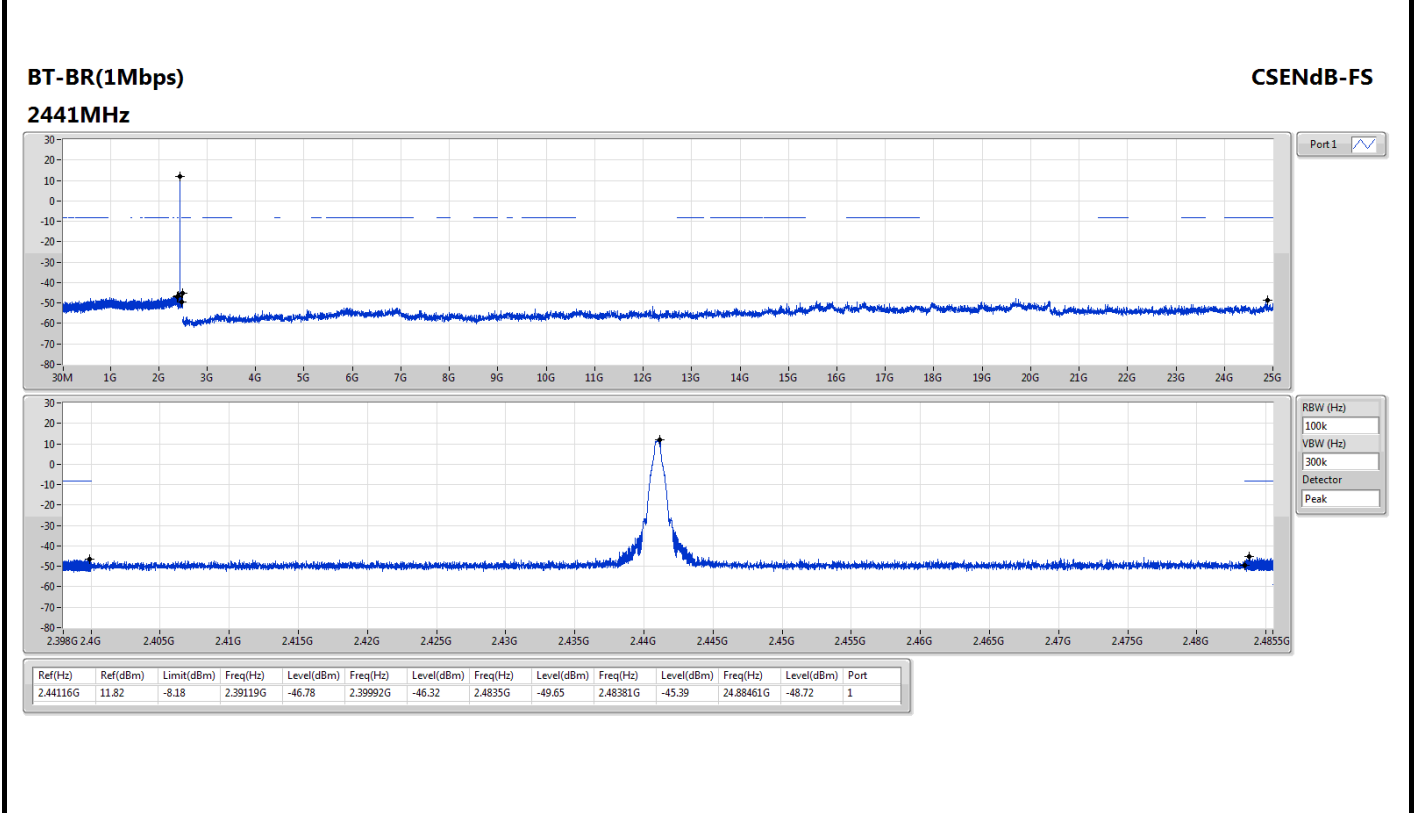
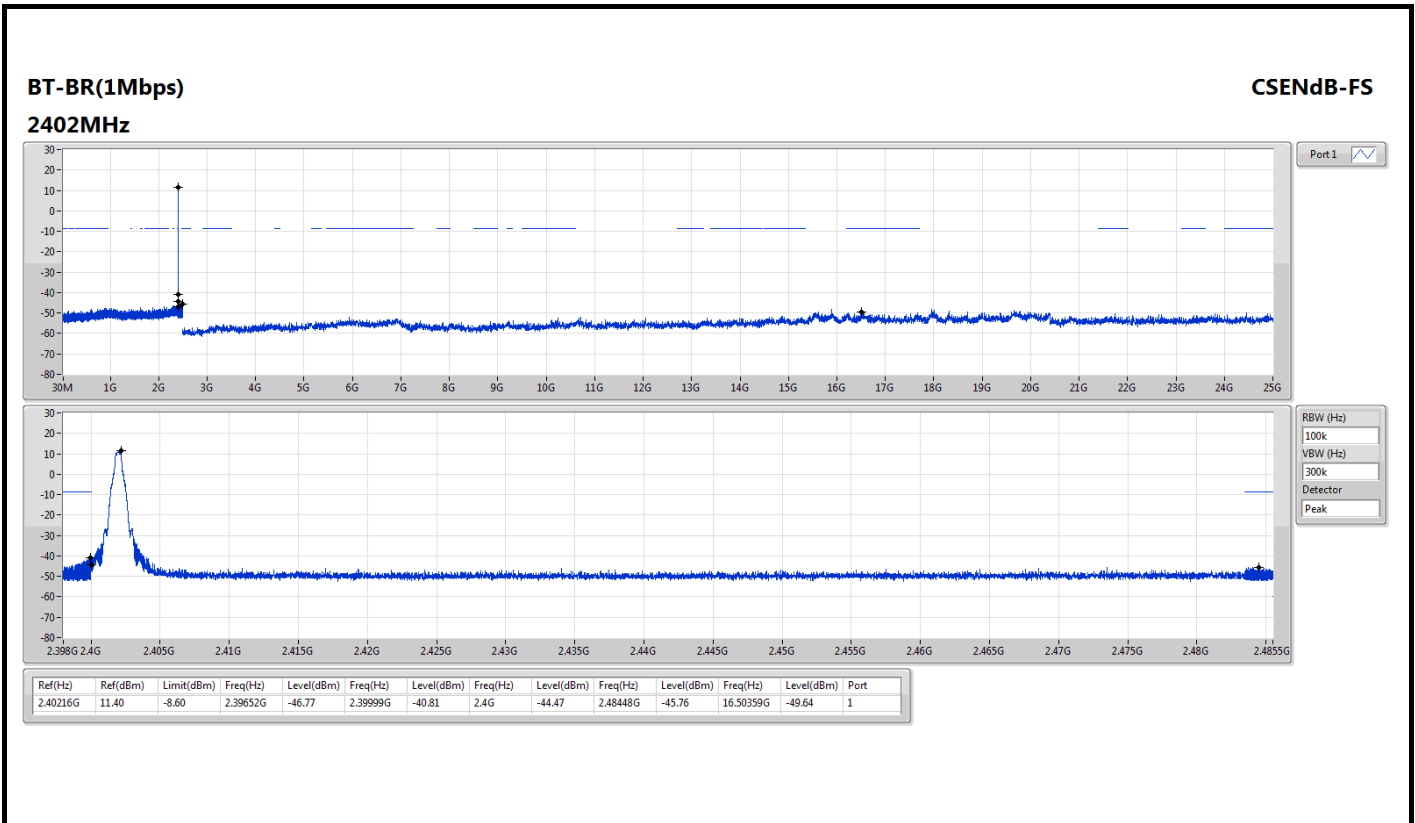

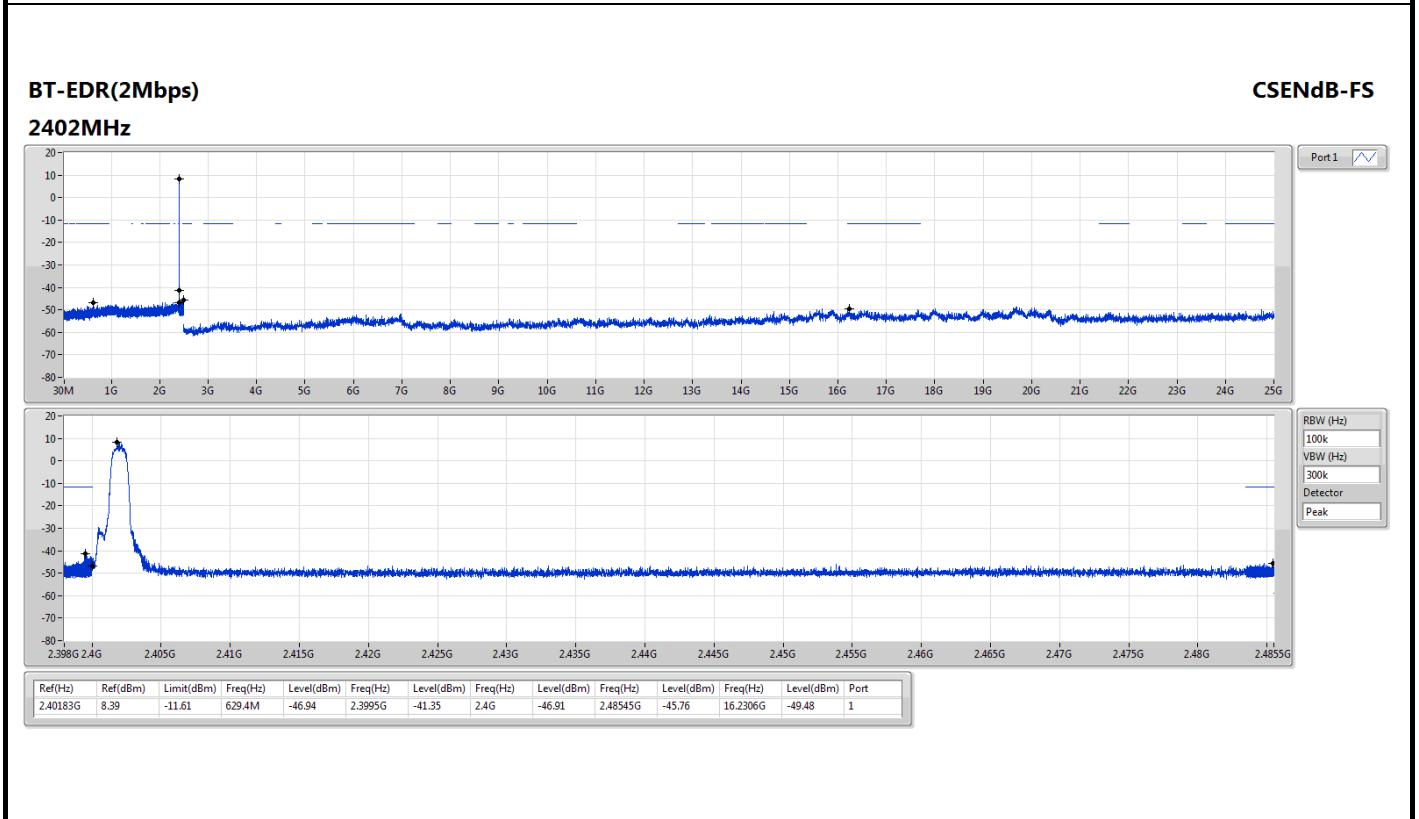
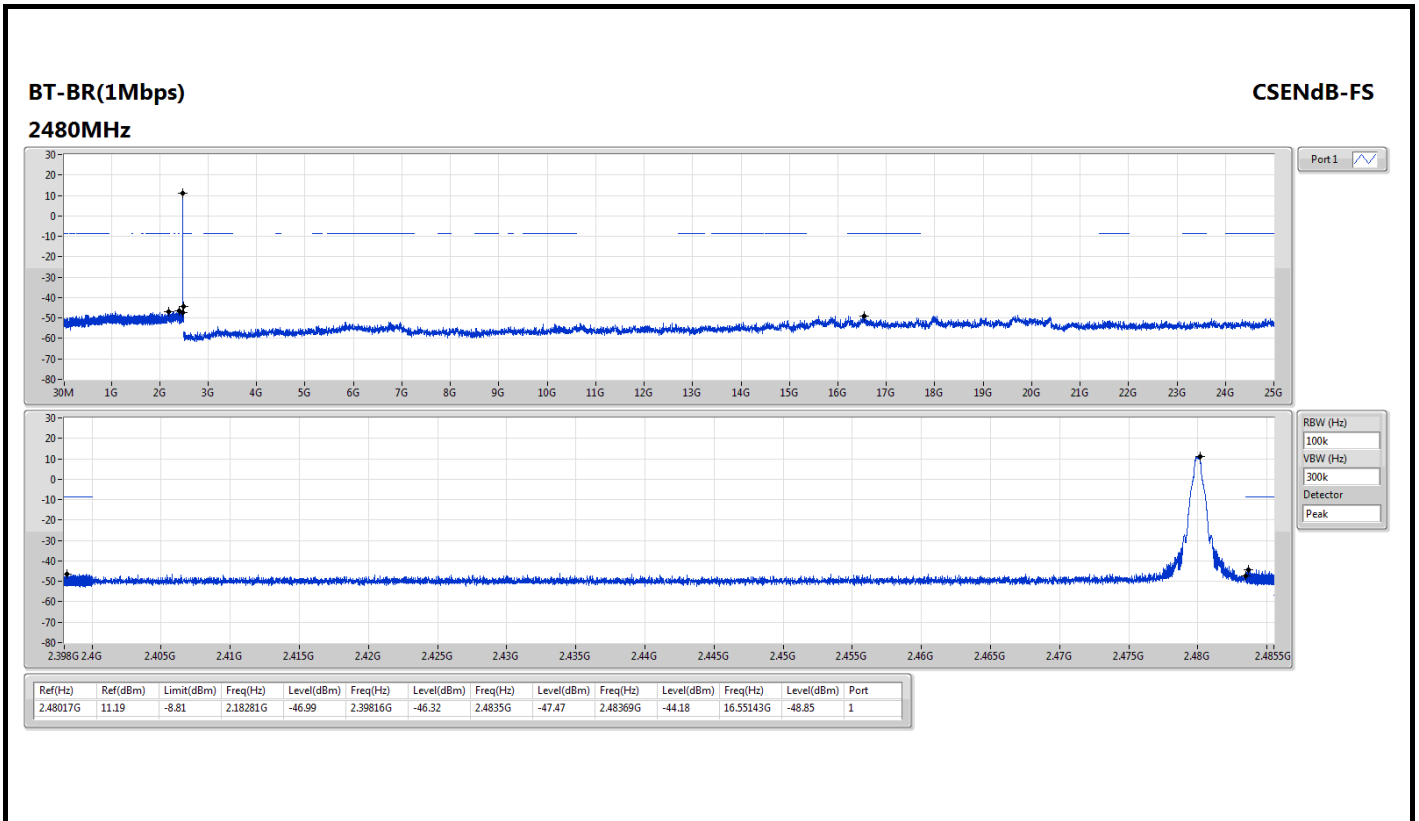

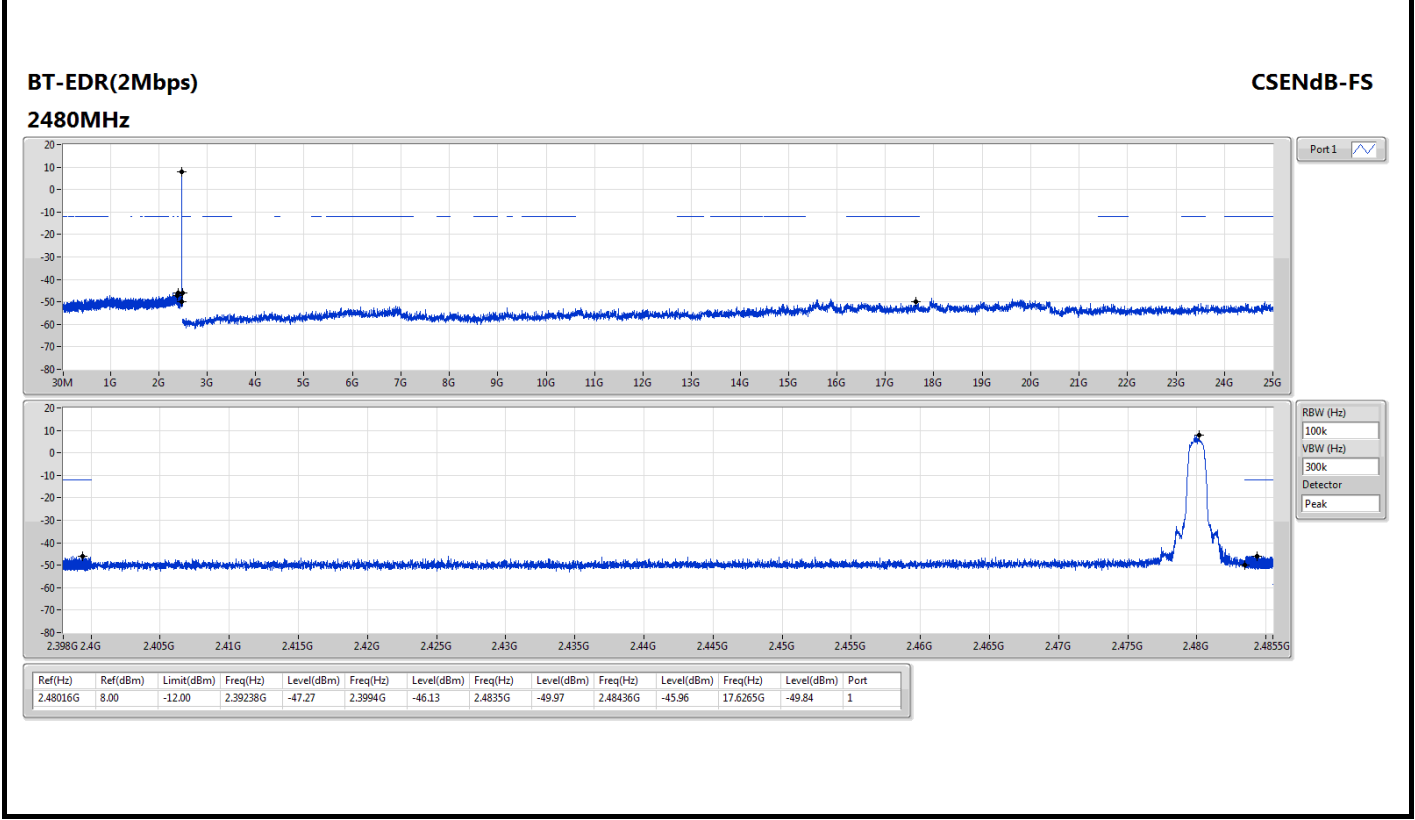
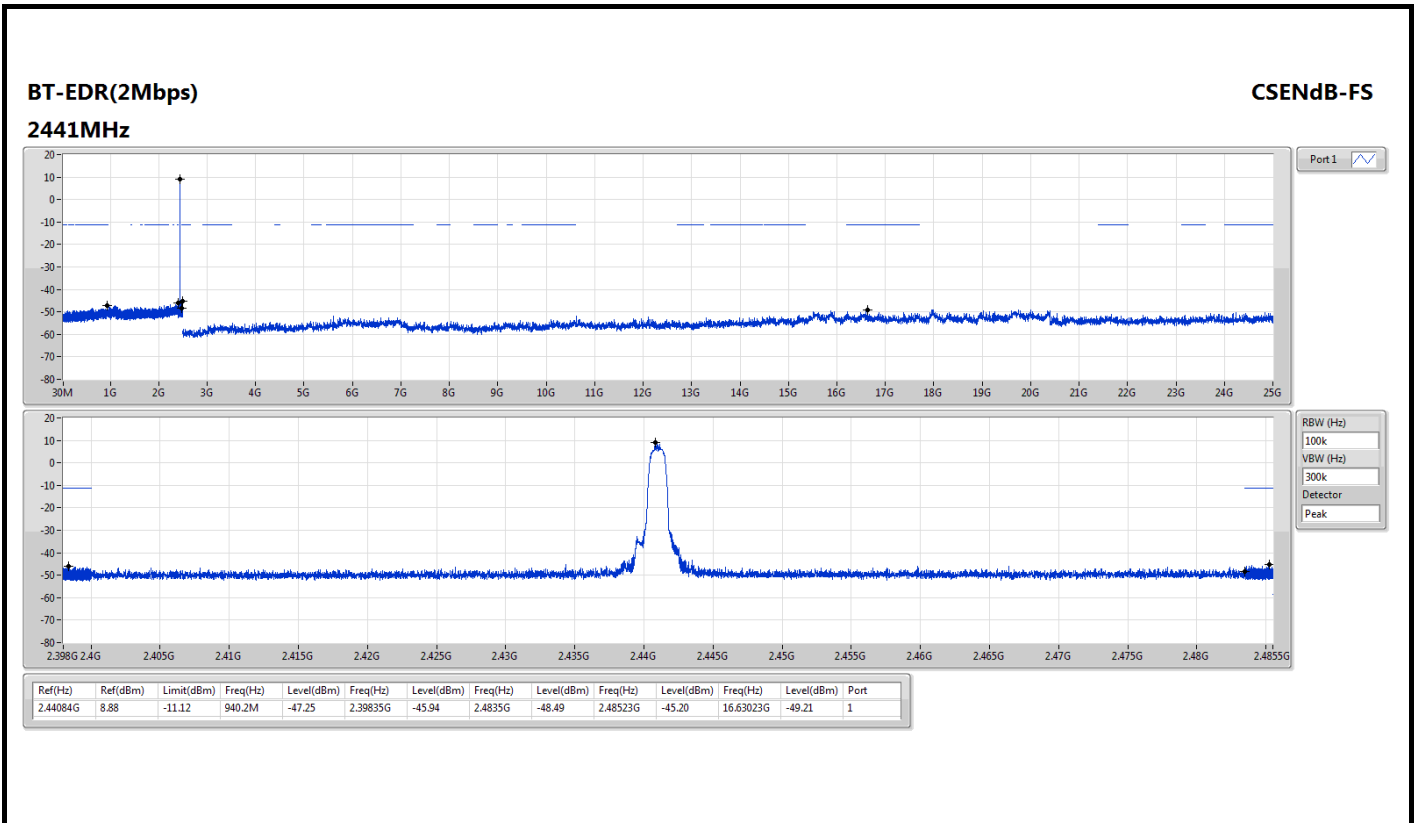

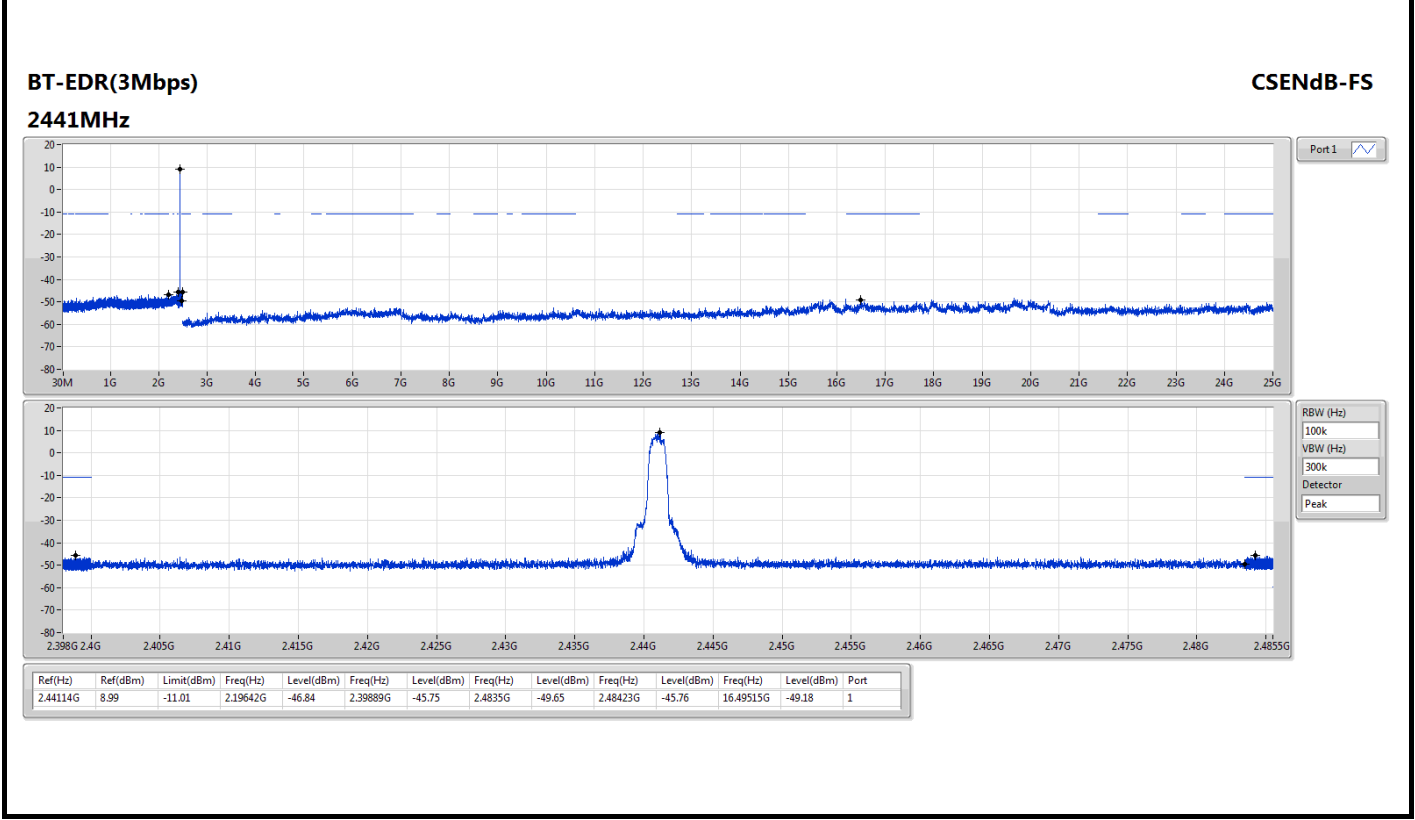
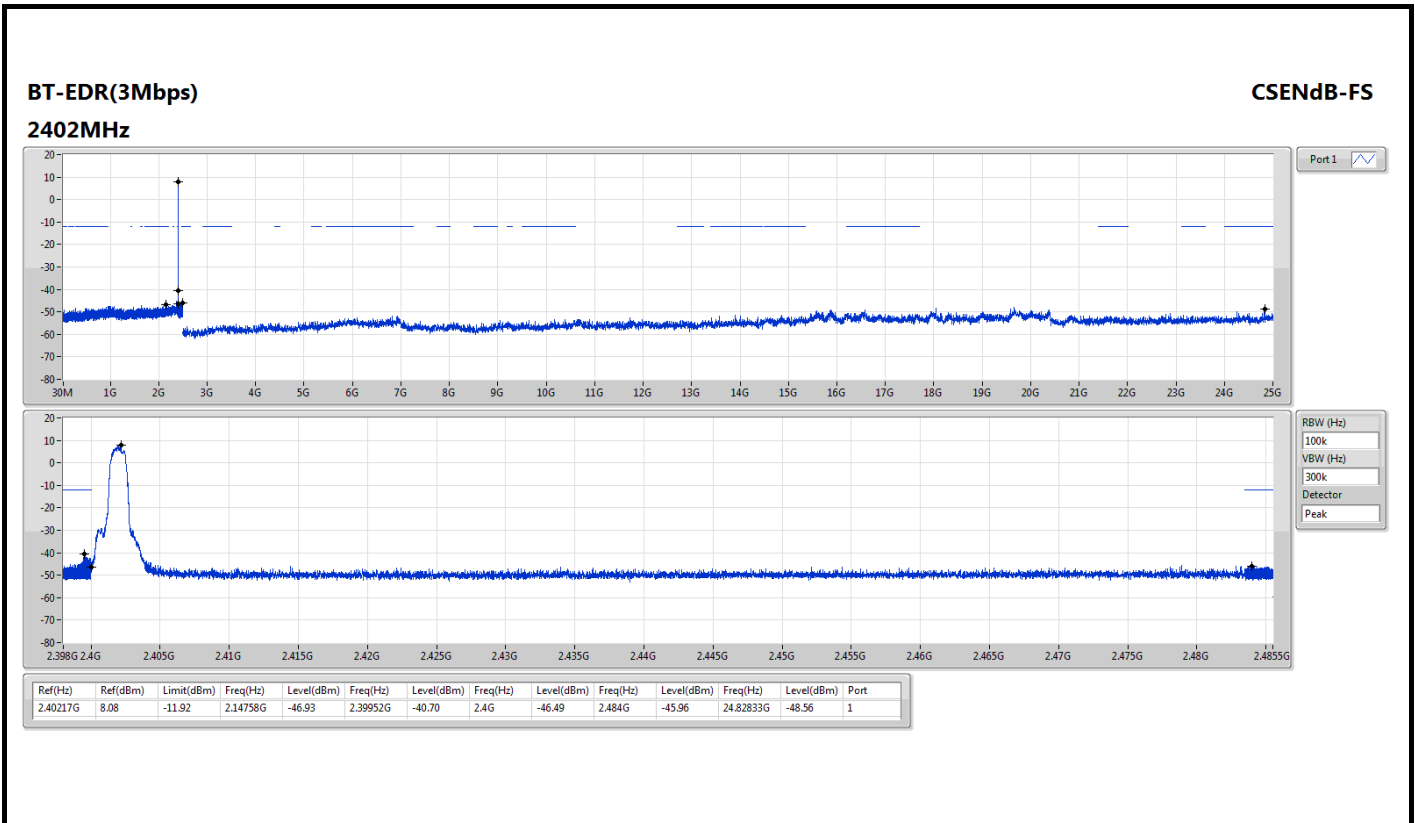

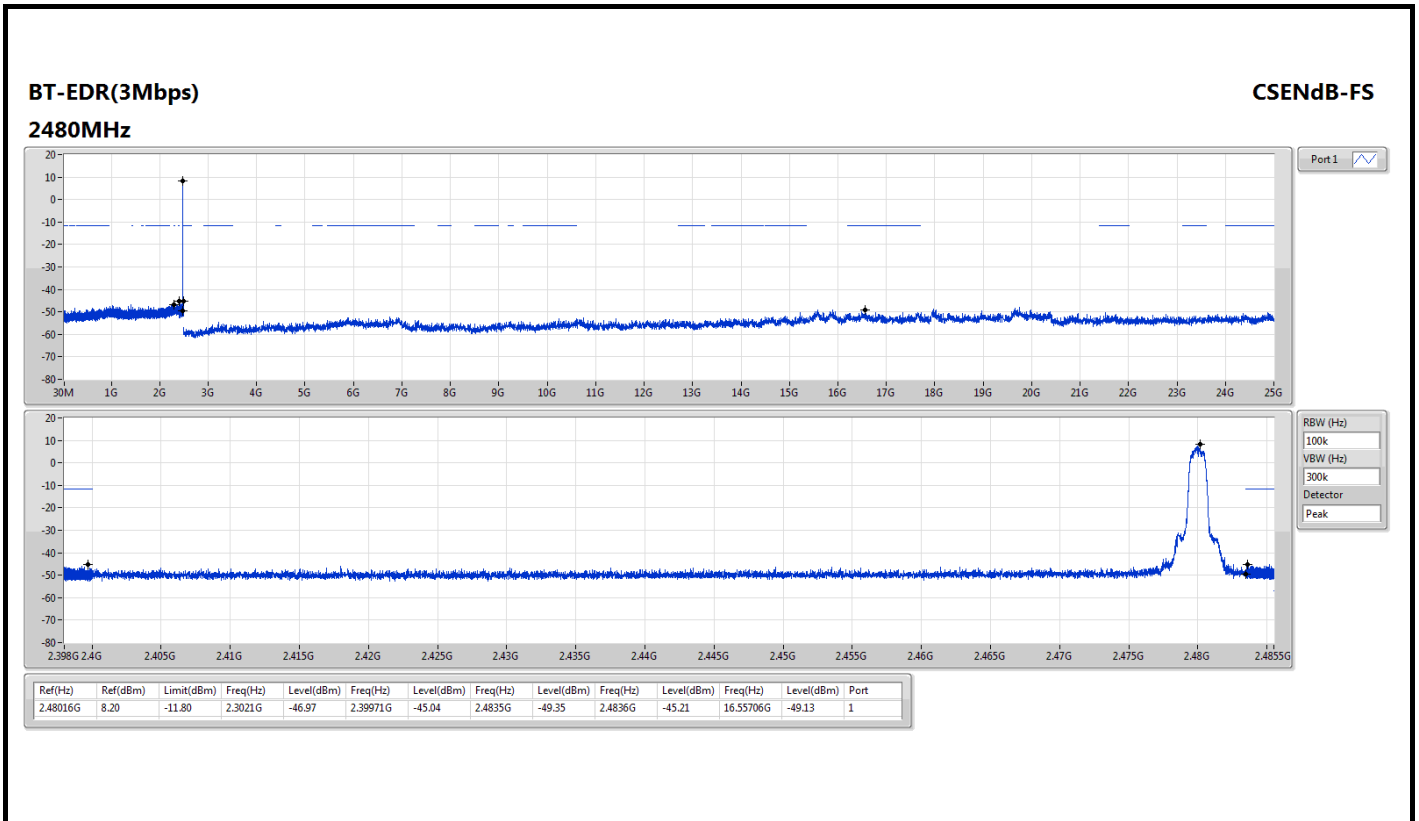

BT-BR(1Mbps)
2402MHz
Hopping Ch Bandedge (Non-restricted Band)

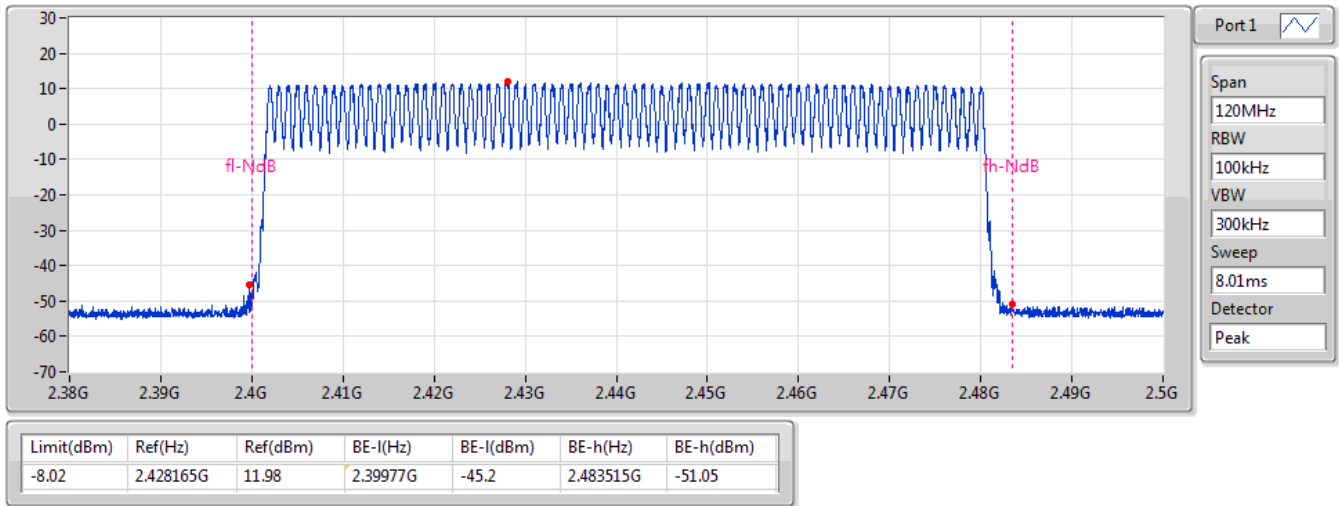

BT-EDR(2Mbps)
2402MHz
Hopping Ch Bandedge (Non-restricted Band)

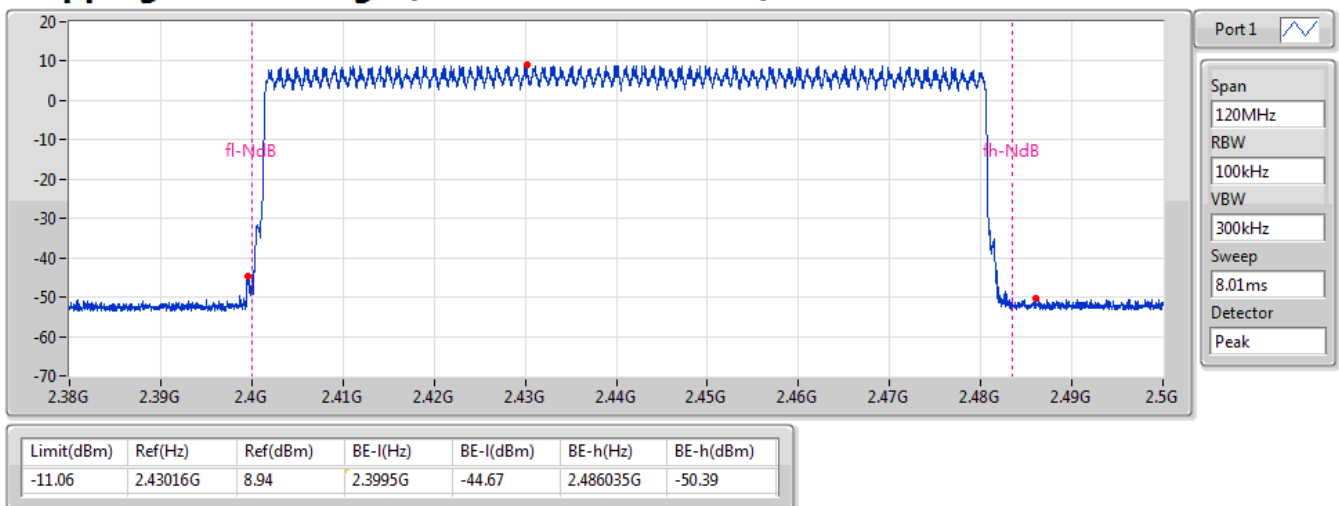

BT-EDR(3Mbps)
2402MHz
Hopping Ch Bandedge (Non-restricted Band)

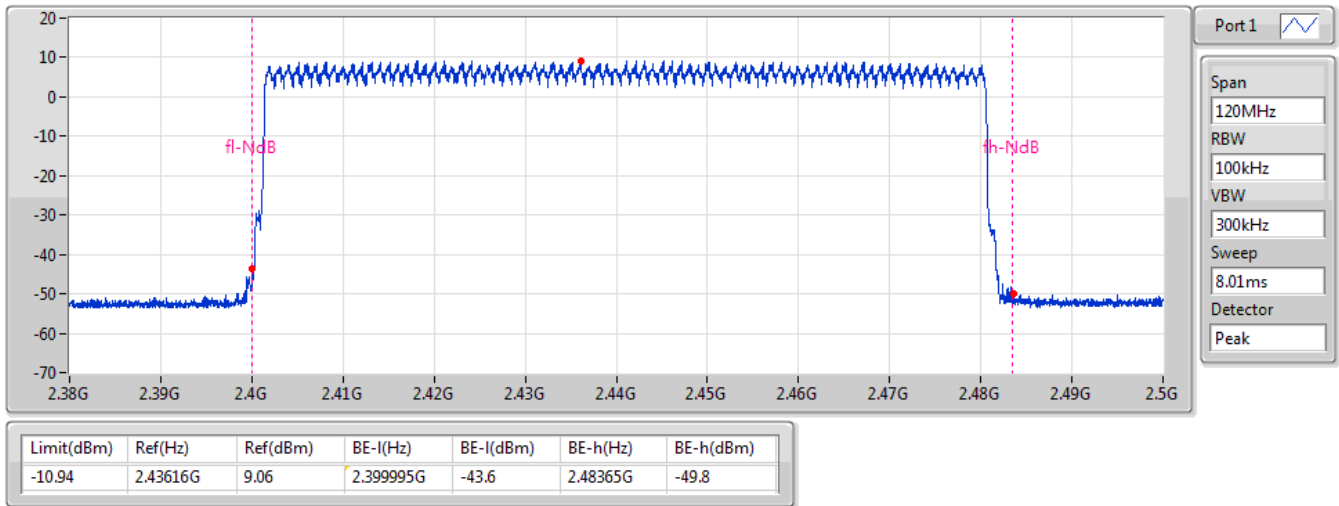



Summary

Mode	Power (dBm)	Power (W)
2.4-2.4835GHz	-	-
BT-BR(1Mbps)	12.13	0.01633
BT-EDR(2Mbps)	11.89	0.01545
BT-EDR(3Mbps)	12.33	0.01710

Result

Mode	Result	Antenna Gain (dBi)	Power (dBm)	Power Limit (dBm)
BT-BR(1Mbps)	-	-	-	-
2402MHz	Pass	-4.50	11.86	21.00
2441MHz	Pass	-4.50	12.13	21.00
2480MHz	Pass	-4.50	11.57	21.00
BT-EDR(2Mbps)	-	-	-	-
2402MHz	Pass	-4.50	11.59	21.00
2441MHz	Pass	-4.50	11.89	21.00
2480MHz	Pass	-4.50	11.26	21.00
BT-EDR(3Mbps)	-	-	-	-
2402MHz	Pass	-4.50	12.11	21.00
2441MHz	Pass	-4.50	12.33	21.00
2480MHz	Pass	-4.50	11.82	21.00



Summary

Mode	Power (dBm)	Power (W)
2.4-2.4835GHz	-	-
BT-BR(1Mbps)	12.09	0.01618
BT-EDR(2Mbps)	9.24	0.00839
BT-EDR(3Mbps)	9.25	0.00841

Result

Mode	Result	Antenna Gain (dBi)	Power (dBm)	Power Limit (dBm)
BT-BR(1Mbps)	-	-	-	-
2402MHz	Pass	-4.50	11.81	-
2441MHz	Pass	-4.50	12.09	-
2480MHz	Pass	-4.50	11.51	-
BT-EDR(2Mbps)	-	-	-	-
2402MHz	Pass	-4.50	8.82	-
2441MHz	Pass	-4.50	9.24	-
2480MHz	Pass	-4.50	8.44	-
BT-EDR(3Mbps)	-	-	-	-
2402MHz	Pass	-4.50	8.82	-
2441MHz	Pass	-4.50	9.25	-
2480MHz	Pass	-4.50	8.45	-

Note: Average power is for reference only.



Summary

Mode	Max-Hop No
2.4-2.4835GHz	-
BT-BR(1Mbps)	79
BT-EDR(2Mbps)	79
BT-EDR(3Mbps)	79

Result

Mode	Result	Hopping No	Limit
BT-BR(1Mbps)	-	-	-
2402MHz	Pass	79	15
BT-EDR(2Mbps)	-	-	-
2402MHz	Pass	79	15
BT-EDR(3Mbps)	-	-	-
2402MHz	Pass	79	15



BT-BR(1Mbps)

Hopping-FS

2402MHz

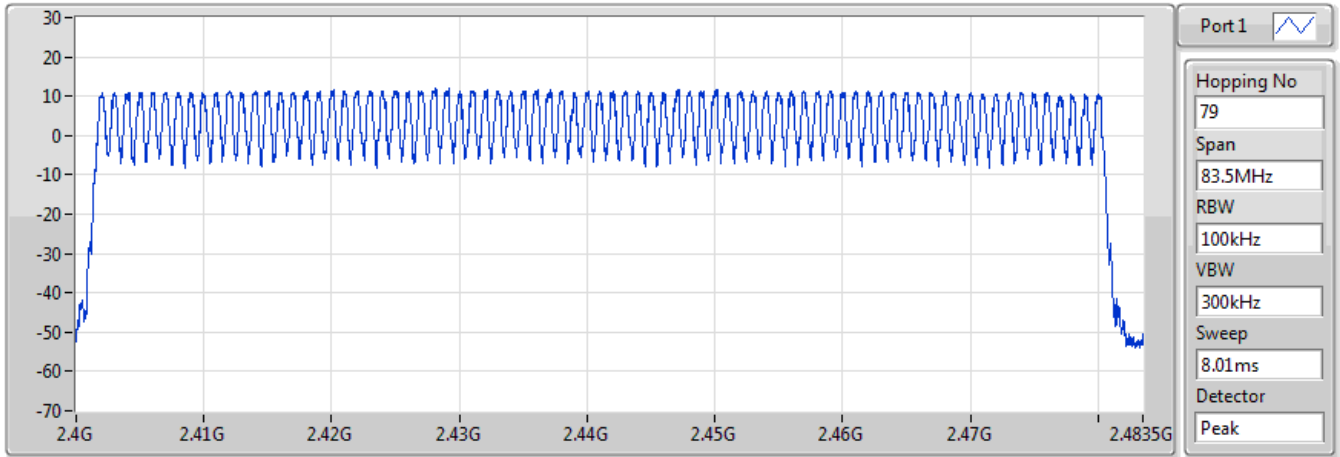

Hopping No	Limit
79	15

BT-EDR(2Mbps)

Hopping-FS

2402MHz

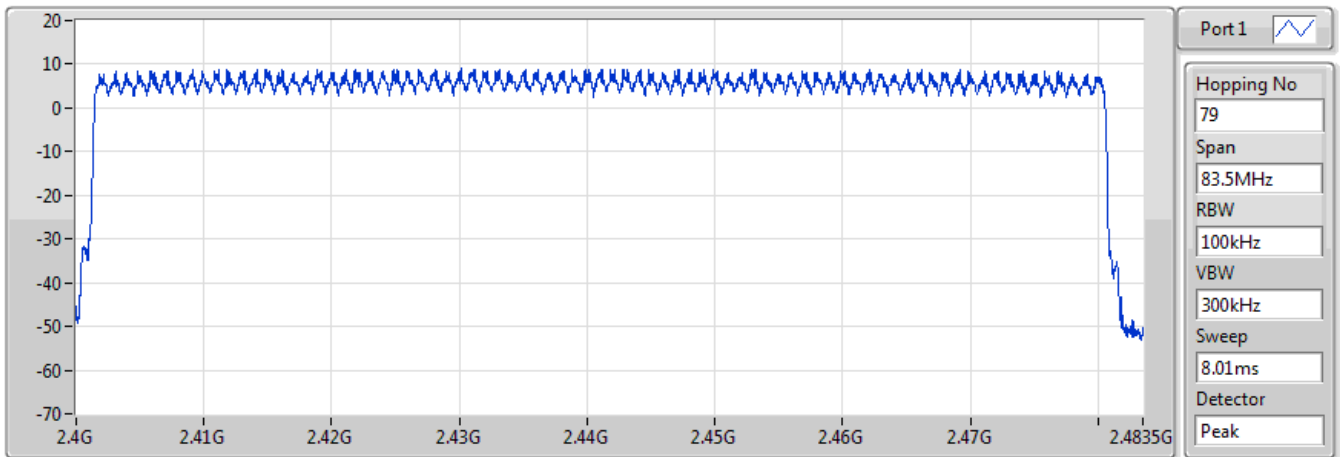

Hopping No	Limit
79	15



BT-EDR(3Mbps)
2402MHz

Hopping-FS

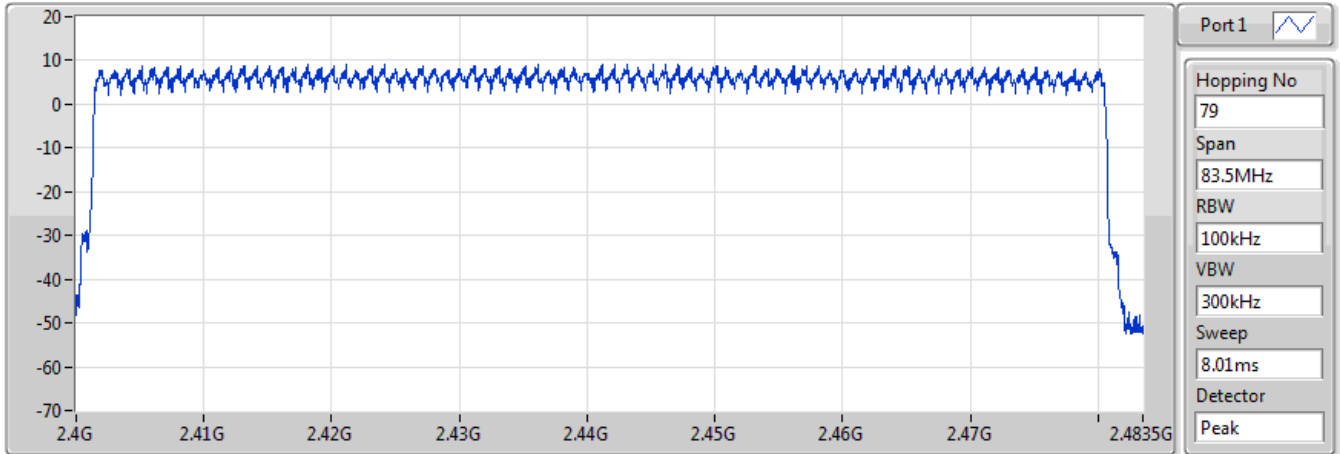

Hopping No	Limit
79	15

**Summary**

Mode	Max-N dB (Hz)	Max-OBW (Hz)	ITU-Code	Min-N dB (Hz)	Min-OBW (Hz)
2.4-2.4835GHz	-	-	-	-	-
BT-BR(1Mbps)	938.406k	879.161k	879KF1D	934.783k	871.925k
BT-EDR(2Mbps)	1.337M	1.19M	1M19G1D	1.326M	1.187M
BT-EDR(3Mbps)	1.293M	1.198M	1M20G1D	1.286M	1.183M

Max-N dB = Maximum 20dB down bandwidth; Max-OBW = Maximum 99% occupied bandwidth;
 Min-N dB = Minimum 20dB down bandwidth; Min-OBW = Minimum 99% occupied bandwidth

Result

Mode	Result	Limit (Hz)	Port 1-N dB (Hz)	Port 1-OBW (Hz)
BT-BR(1Mbps)	-	-	-	-
2402MHz	Pass	Inf	934.783k	871.925k
2441MHz	Pass	Inf	938.406k	879.161k
2480MHz	Pass	Inf	934.783k	875.543k
BT-EDR(2Mbps)	-	-	-	-
2402MHz	Pass	Inf	1.337M	1.19M
2441MHz	Pass	Inf	1.333M	1.187M
2480MHz	Pass	Inf	1.326M	1.187M
BT-EDR(3Mbps)	-	-	-	-
2402MHz	Pass	Inf	1.29M	1.19M
2441MHz	Pass	Inf	1.293M	1.198M
2480MHz	Pass	Inf	1.286M	1.183M

Port X-N dB = Port X 20dB down bandwidth;
 Port X-OBW = Port X 99% occupied bandwidth

BT-BR(1Mbps)

EBW-FS

2402MHz

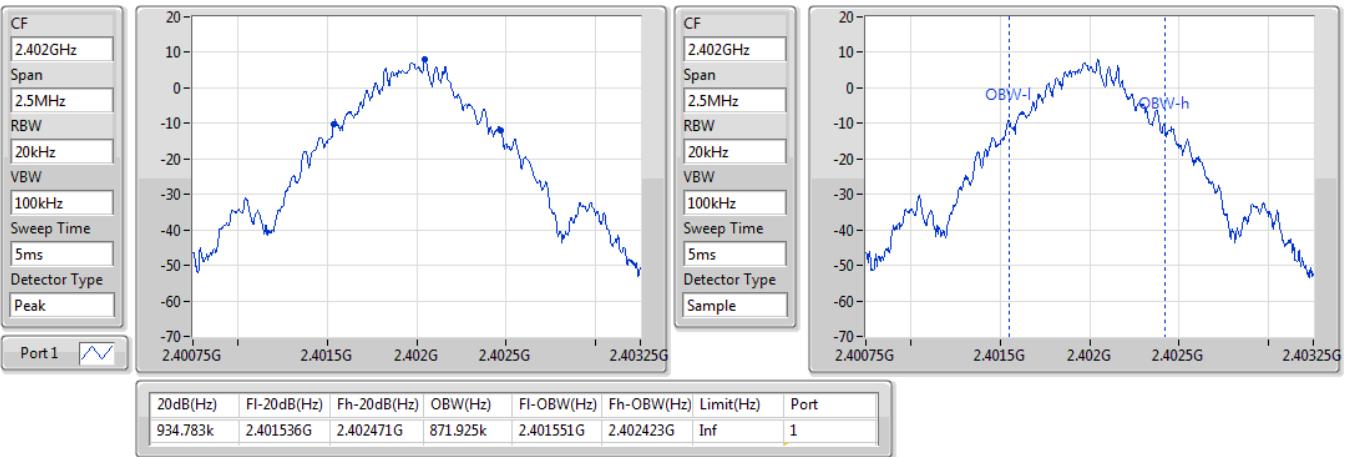

BT-BR(1Mbps)

EBW-FS

2441MHz

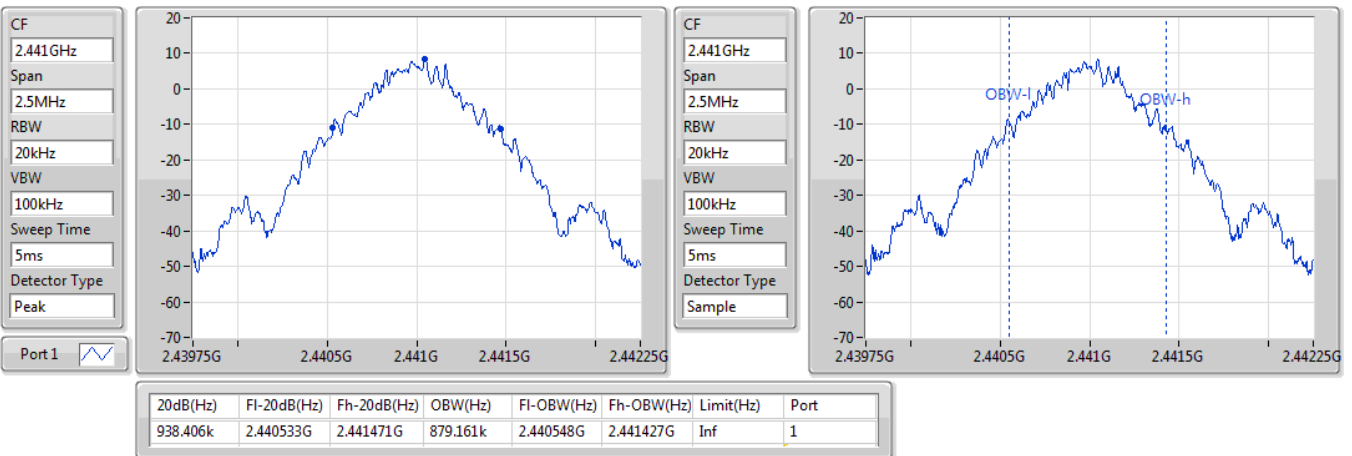

BT-BR(1Mbps)

EBW-FS

2480MHz

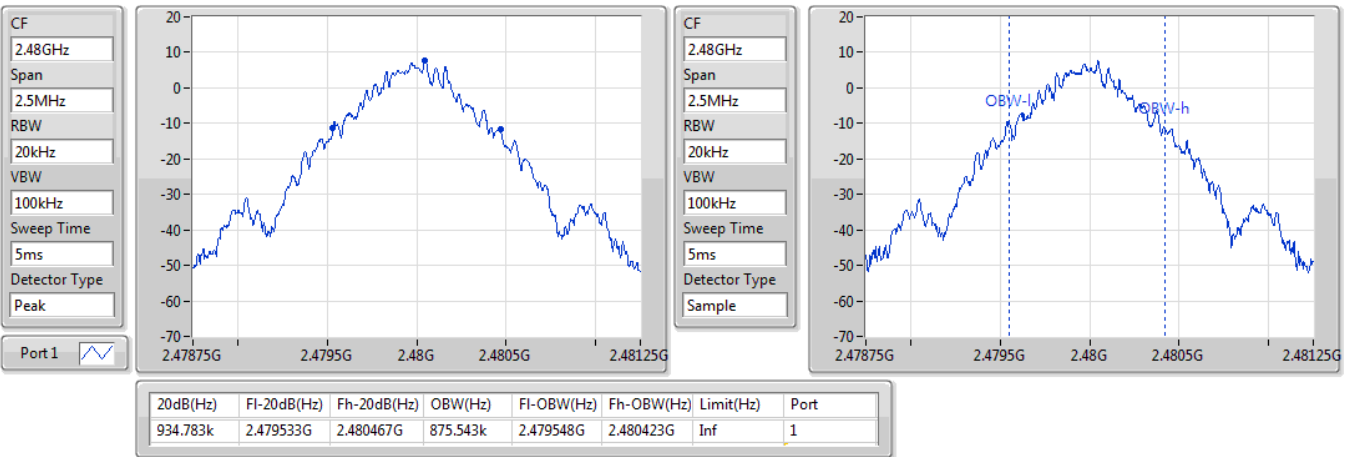

BT-EDR(2Mbps)

EBW-FS

2402MHz

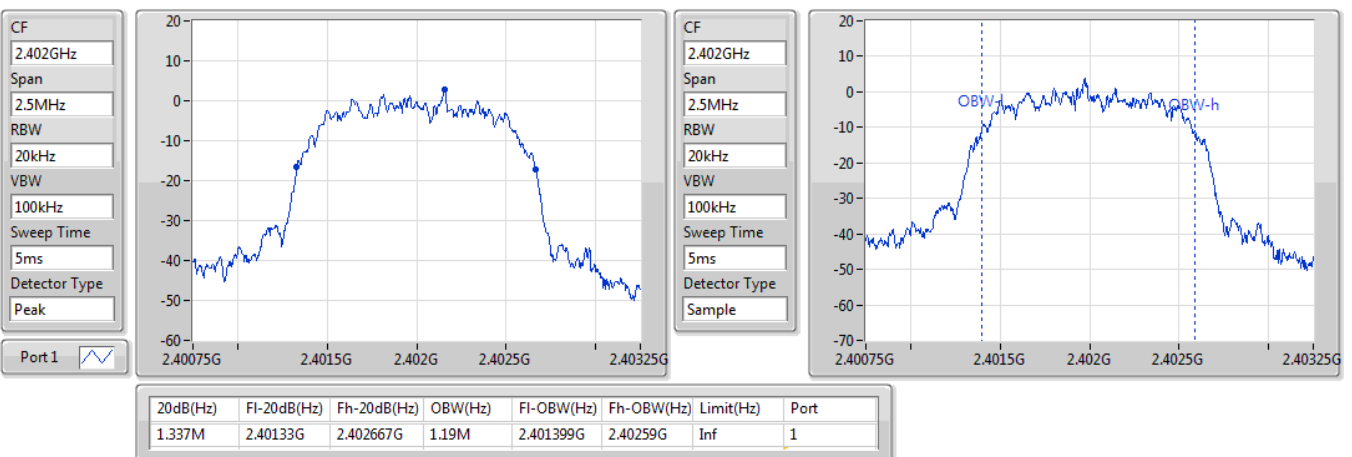

BT-EDR(2Mbps)

EBW-FS

2441MHz

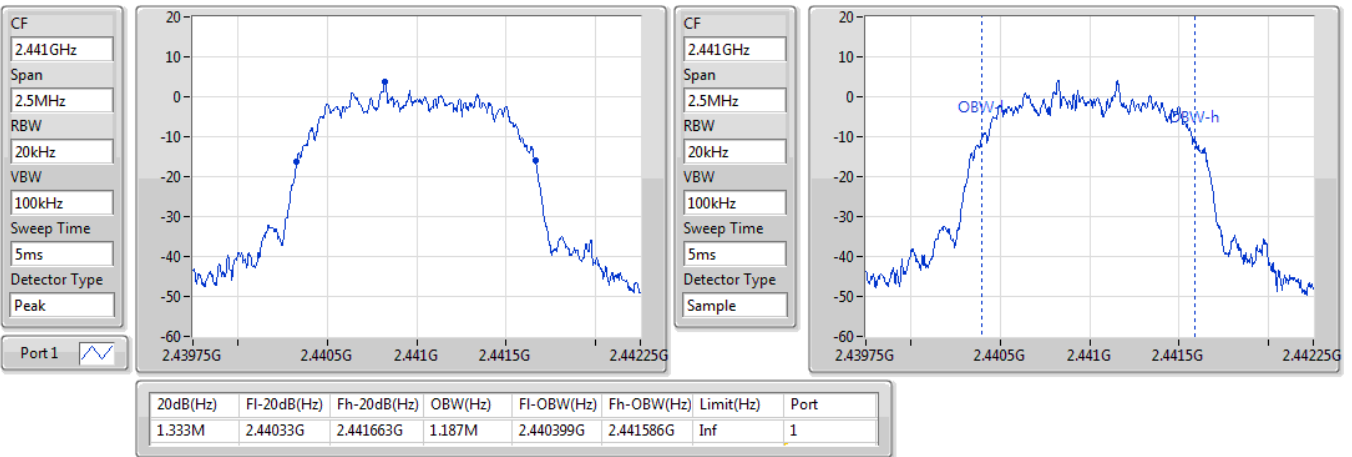

BT-EDR(2Mbps)

EBW-FS

2480MHz

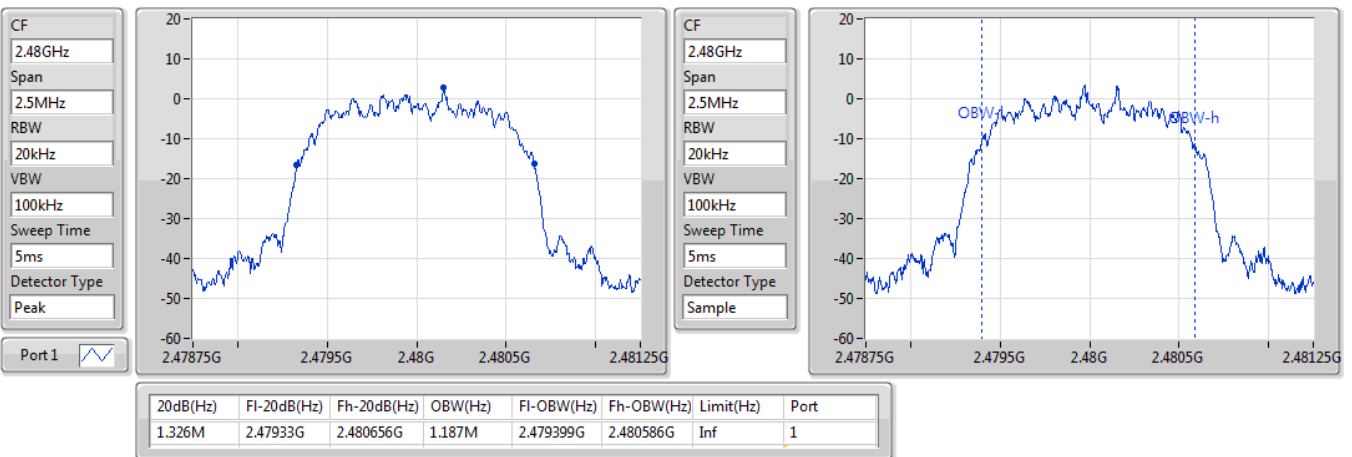

BT-EDR(3Mbps)

EBW-FS

2402MHz

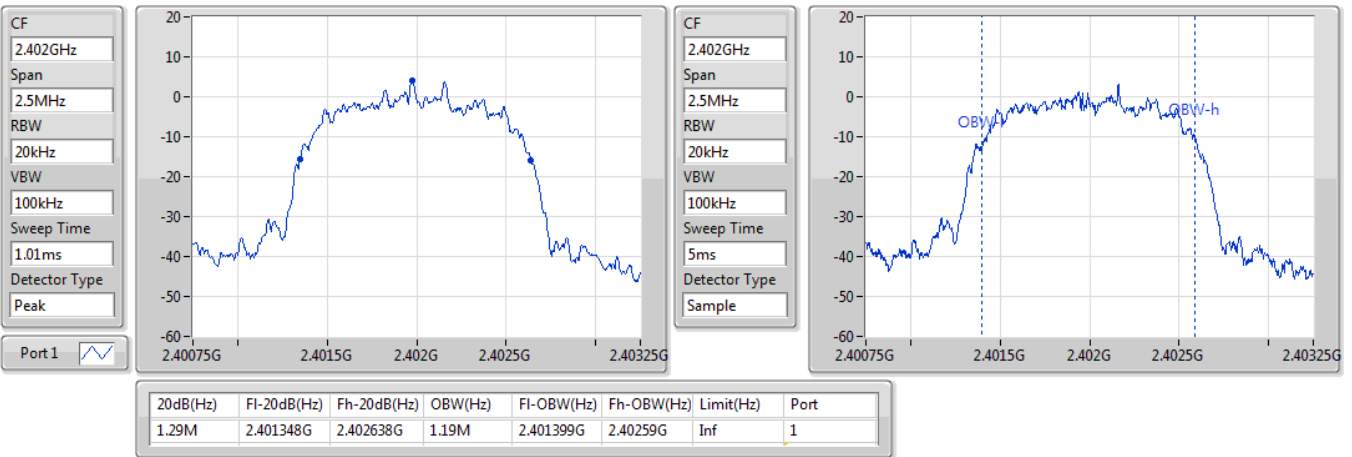

BT-EDR(3Mbps)

EBW-FS

2441MHz

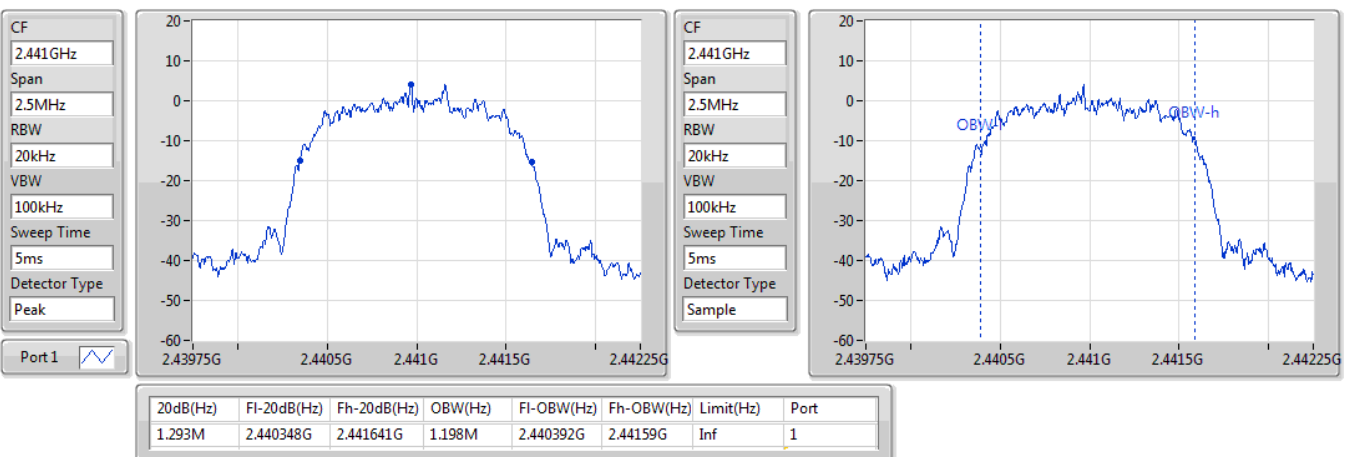

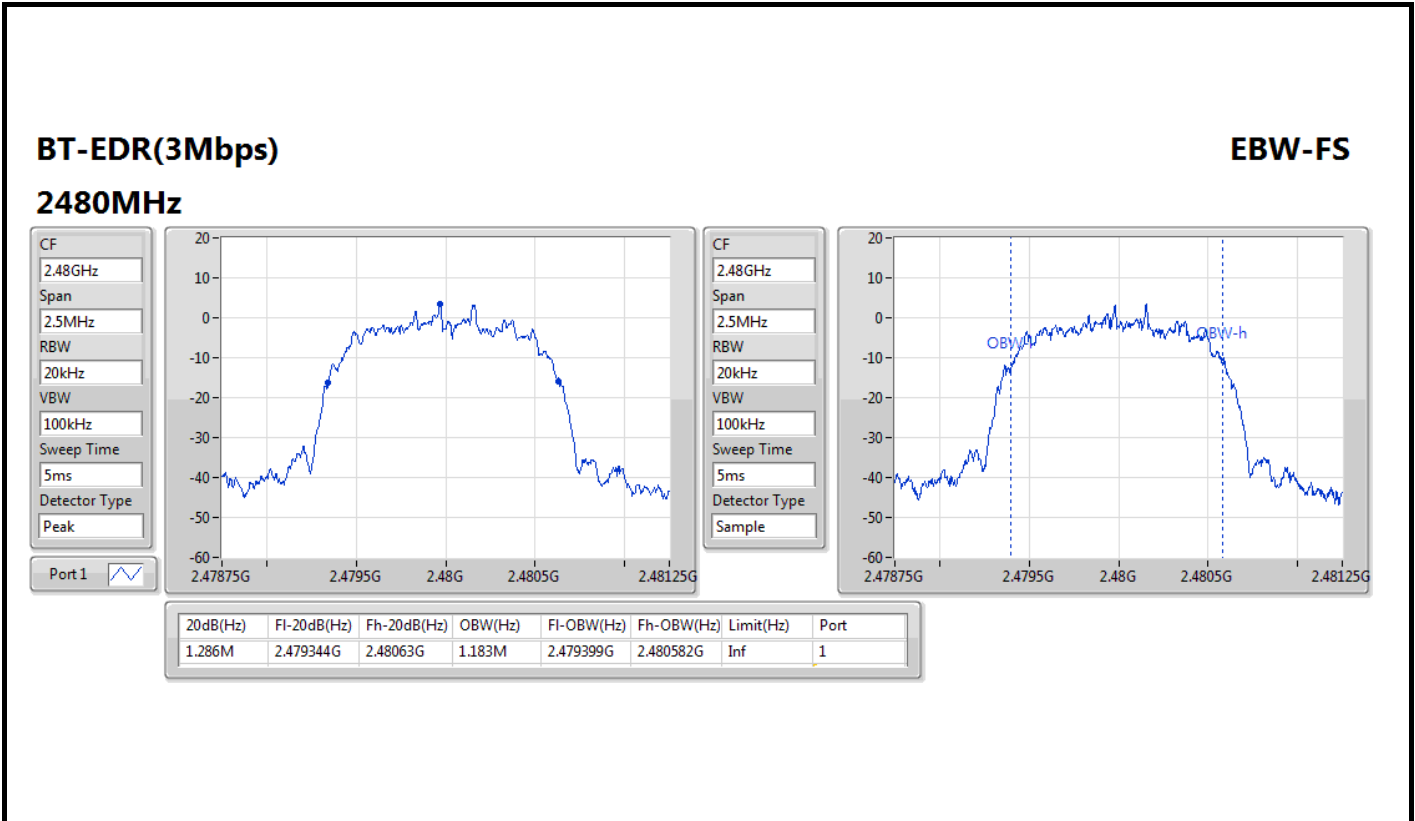

**Summary**

Mode	Max-Space (Hz)	Min-Space (Hz)
2.4-2.4835GHz	-	-
BT-BR(1Mbps)	1.004348M	1M
BT-EDR(2Mbps)	1.004348M	1M
BT-EDR(3Mbps)	1.004348M	1M

Result

Mode	Result	Fl (Hz)	Fh (Hz)	Ch.Space (Hz)	Limit (Hz)
BT-BR(1Mbps)	-	-	-	-	-
2402MHz	Pass	2.402048G	2.403048G	1M	622.565478k
2441MHz	Pass	2.441043G	2.442048G	1.004348M	624.978396k
2480MHz	Pass	2.479048G	2.480048G	1M	622.565478k
BT-EDR(2Mbps)	-	-	-	-	-
2402MHz	Pass	2.401978G	2.402983G	1.004348M	890.442k
2441MHz	Pass	2.440983G	2.441983G	1M	887.778k
2480MHz	Pass	2.478978G	2.479983G	1.004348M	883.116k
BT-EDR(3Mbps)	-	-	-	-	-
2402MHz	Pass	2.401978G	2.402978G	1M	859.14k
2441MHz	Pass	2.440978G	2.441983G	1.004348M	861.138k
2480MHz	Pass	2.478978G	2.479983G	1.004348M	856.476k



BT-BR(1Mbps)

Channel Separation-FS

2.402G/2.403GHz



BT-BR(1Mbps)

Channel Separation-FS

2.441G/2.442GHz

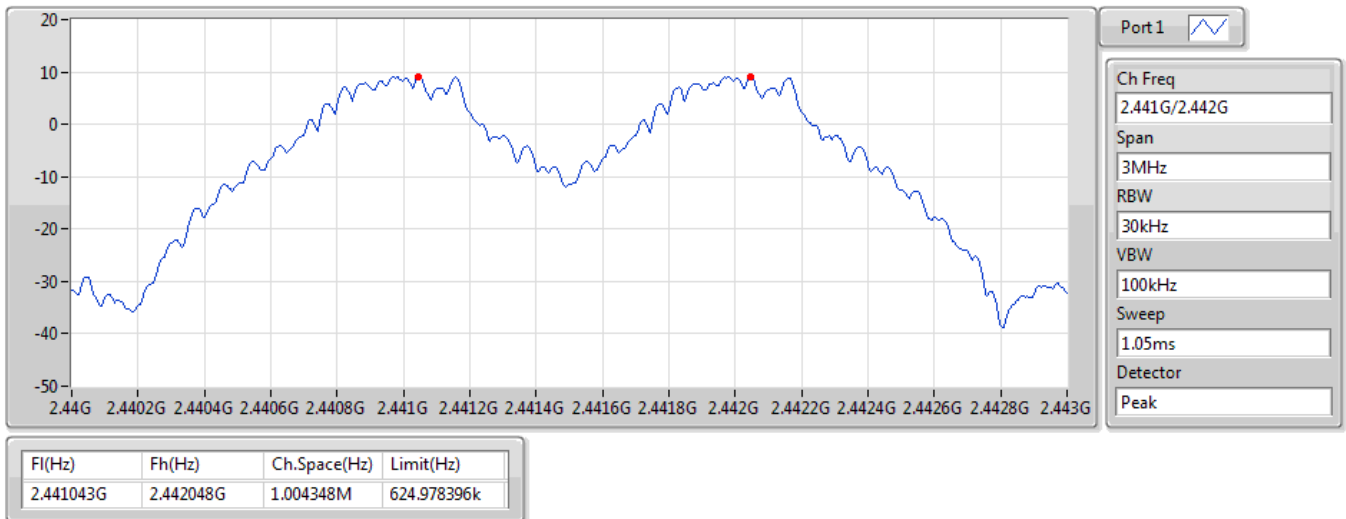



BT-BR(1Mbps)

Channel Separation-FS

2.48G/2.479GHz

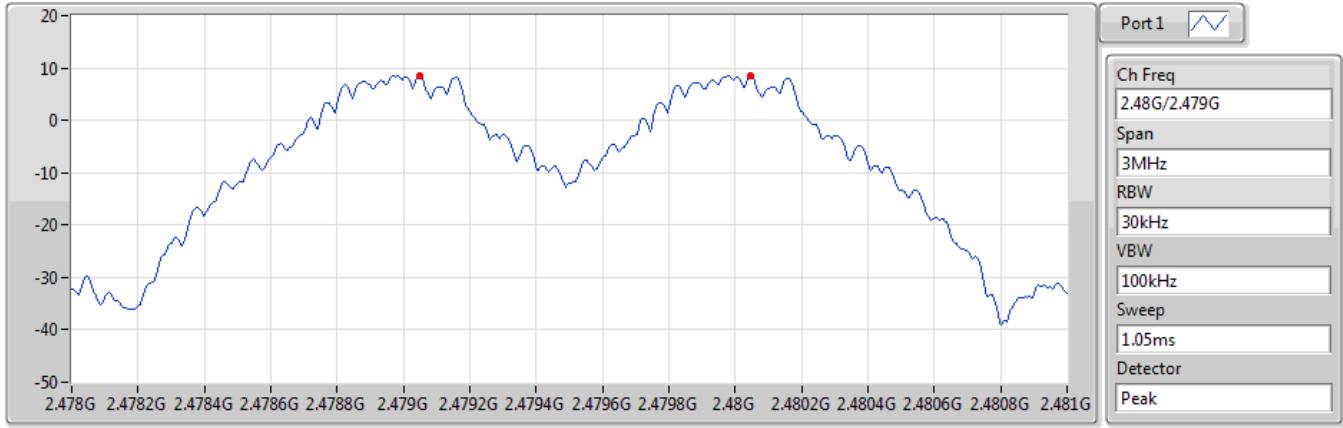

F1(Hz)	Fh(Hz)	Ch.Space(Hz)	Limit(Hz)
2.479048G	2.480048G	1M	622.565478k

BT-EDR(2Mbps)

Channel Separation-FS

2.402G/2.403GHz

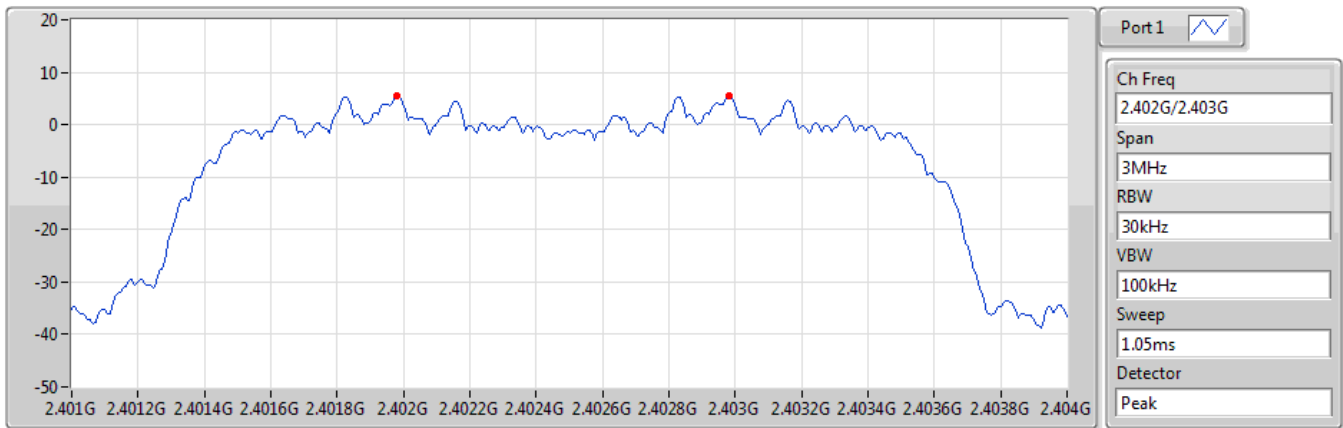

F1(Hz)	Fh(Hz)	Ch.Space(Hz)	Limit(Hz)
2.401978G	2.402983G	1.004348M	890.442k

BT-EDR(2Mbps)

Channel Separation-FS

2.441G/2.442GHz

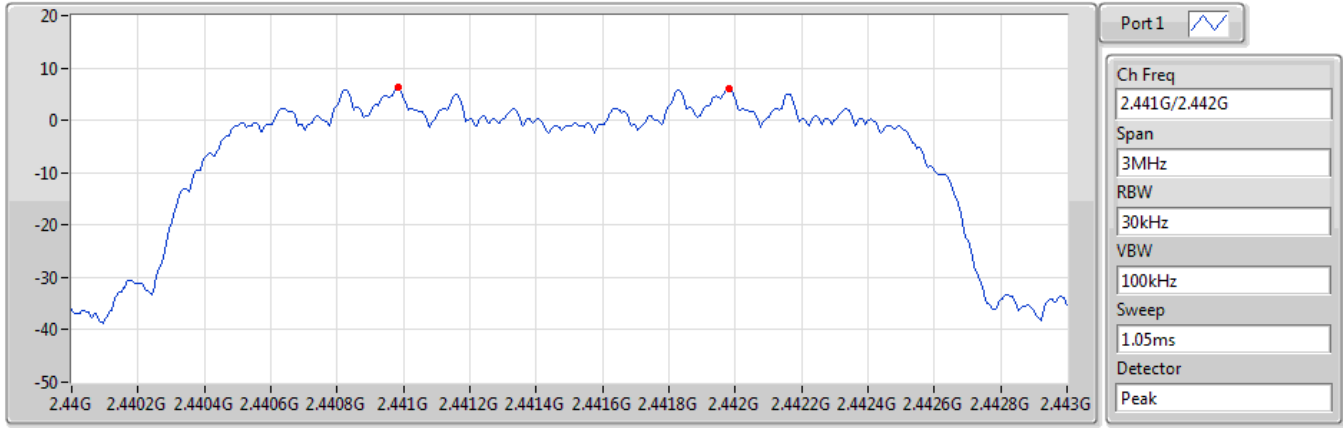

Ff(Hz)	Fh(Hz)	Ch.Space(Hz)	Limit(Hz)
2.440983G	2.441983G	1M	887.778k

BT-EDR(2Mbps)

Channel Separation-FS

2.48G/2.479GHz

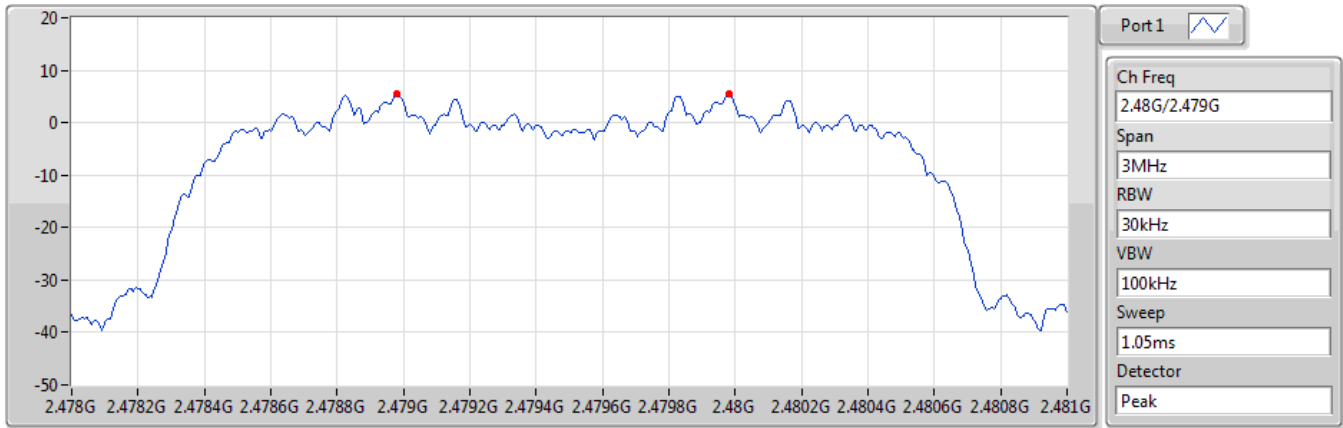

Ff(Hz)	Fh(Hz)	Ch.Space(Hz)	Limit(Hz)
2.478978G	2.479983G	1.004348M	883.116k

BT-EDR(3Mbps)

Channel Separation-FS

2.402G/2.403GHz

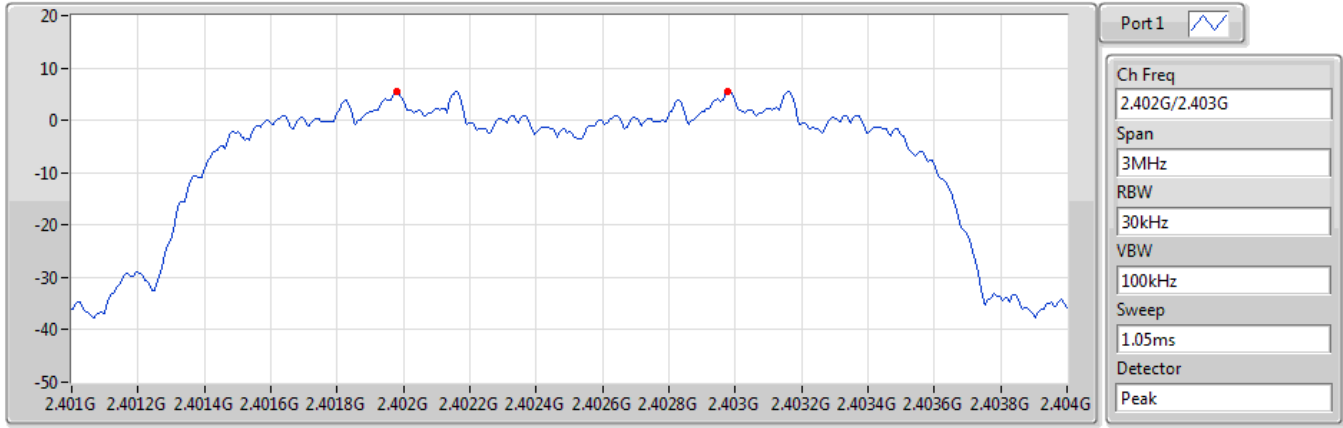

Ff(Hz)	Fh(Hz)	Ch.Space(Hz)	Limit(Hz)
2.401978G	2.402978G	1M	859.14k

BT-EDR(3Mbps)

Channel Separation-FS

2.441G/2.442GHz

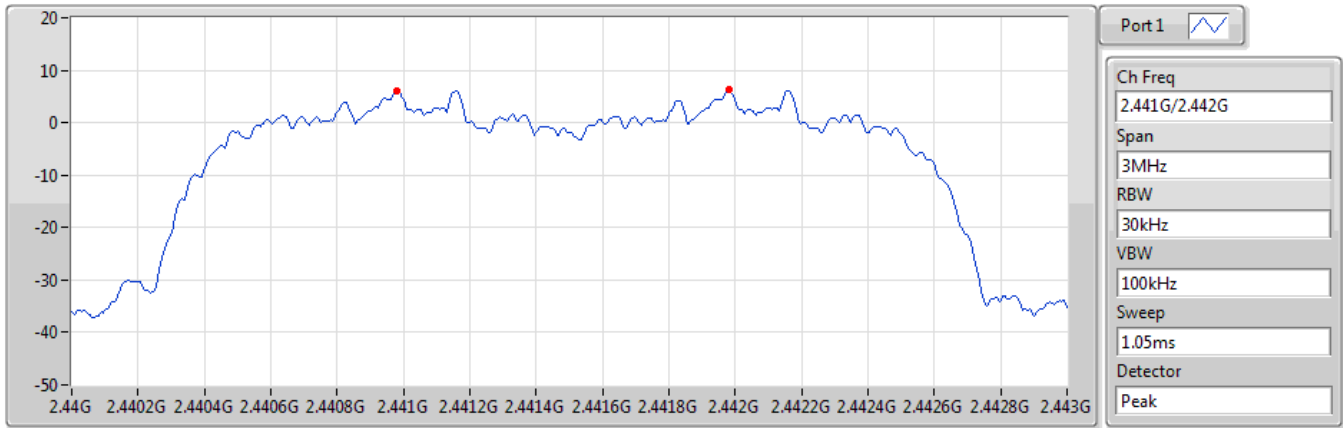

Ff(Hz)	Fh(Hz)	Ch.Space(Hz)	Limit(Hz)
2.440978G	2.441983G	1.004348M	861.138k



BT-EDR(3Mbps)

Channel Separation-FS

2.48G/2.479GHz

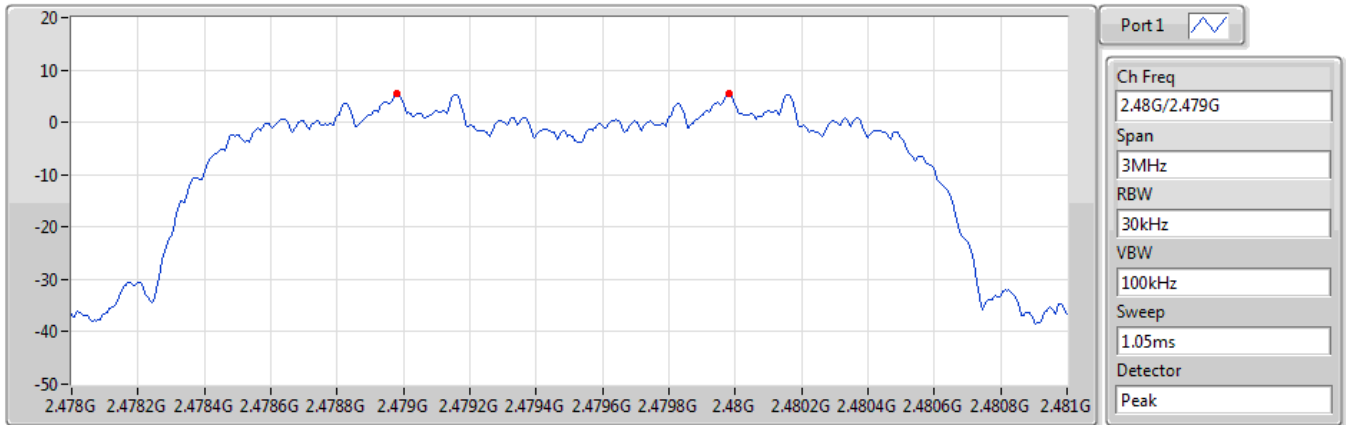

F1(Hz)	Fh(Hz)	Ch.Space(Hz)	Limit(Hz)
2.478978G	2.479983G	1.004348M	856.476k



Summary

Mode	Max-Dwell (s)
2.4-2.4835GHz	-
BT-BR(1Mbps)	330.38748m_DH5
BT-EDR(2Mbps)	311.76402m_DH5
BT-EDR(3Mbps)	312.00576m_DH5
BT-BR-AFH(1Mbps)	313.362m_DH5-AFH
BT-EDR-AFH(2Mbps)	301.756m_DH5-AFH
BT-EDR-AFH(3Mbps)	313.605m_DH5-AFH

Result/ Non AFH mode

Mode	Result	Period (s)	Dwell (s)	Limit (s)	Tx On (ms)	Number of transmission in a 5 s
BT-BR(1Mbps)	-	-	-	-	-	-
2402MHz_DH5	PASS	31.6	0.33039	0.4	2.90425	18
BT-EDR(2Mbps)	-	-	-	-	-	-
2402MHz_DH5	PASS	31.6	0.31176	0.4	2.90175	17
BT-EDR(3Mbps)	-	-	-	-	-	-
2402MHz_DH5	PASS	31.6	0.31201	0.4	2.90400	17

Note 1: Dwell time =Number of transmission in a 5 second x Tx On Time x 6.32

Note 2: DH5 was the worst mode.

Result/ AFH mode

Mode	Result	Period (s)	Dwell (s)	Limit (s)	Tx On (ms)	Number of transmission in a 2 s
BT-BR-AFH(1Mbps)	-	-	-	-	-	-
2402MHz_DH5	PASS	8	0.31336	0.4	2.90150	27
BT-EDR-AFH(2Mbps)	-	-	-	-	-	-
2402MHz_DH5	PASS	8	0.30176	0.4	2.90150	26
BT-EDR-AFH(3Mbps)	-	-	-	-	-	-
2402MHz_DH5	PASS	8	0.31361	0.4	2.90375	27

Note 1: Dwell time =Number of transmission in a 2 second x Tx On Time x 4

Note 2: DH5 was the worst mode.

