



TEST REPORT

No.I19N00570-SAR

For

Yulong Computer Telecommunication Scientific (Shenzhen) Co., Ltd

Smartphone

Model Name: cp3705AS

With

Hardware Version: P0

Software Version: 9.0.3705AS.SPRINT.190408.1D

FCC ID: R38YLCP3705AS

Issued Date: 2019-04-30

Designation Number: CN1210

Note:

The test results in this test report relate only to the devices specified in this report. This report shall not be reproduced except in full without the written approval of SAICT.

Test Laboratory:

Shenzhen Academy of Information and Communications Technology

Building G, Shenzhen International Innovation Center, No.1006 Shennan Road, Futian District, Shenzhen, Guangdong, P. R. China 518026.

Tel: +86(0)755-33322000, Fax: +86(0)755-33322001

Email: yewu@caict.ac.cn, website: www.cszit.com

REPORT HISTORY

Report Number	Revision	Issue Date	Description
I19N00570-SAR	Rev.0	2019-04-30	Initial creation of test report

TABLE OF CONTENT

1 TEST LABORATORY	5
1.1 TESTING LOCATION	5
1.2 TESTING ENVIRONMENT	5
1.3 PROJECT DATA	5
1.4 SIGNATURE	5
2 STATEMENT OF COMPLIANCE	6
3 CLIENT INFORMATION	10
3.1 APPLICANT INFORMATION.....	10
3.2 MANUFACTURER INFORMATION	10
4 EQUIPMENT UNDER TEST (EUT) AND ANCILLARY EQUIPMENT (AE)	11
4.1 ABOUT EUT	11
4.2 INTERNAL IDENTIFICATION OF EUT USED DURING THE TEST	12
4.3 INTERNAL IDENTIFICATION OF AE USED DURING THE TEST	12
5 TEST METHODOLOGY	13
5.1 APPLICABLE LIMIT REGULATIONS.....	13
5.2 APPLICABLE MEASUREMENT STANDARDS	13
6 SPECIFIC ABSORPTION RATE (SAR).....	14
6.1 INTRODUCTION.....	14
6.2 SAR DEFINITION	14
7 TISSUE SIMULATING LIQUIDS	15
7.1 TARGETS FOR TISSUE SIMULATING LIQUID	15
7.2 DIELECTRIC PERFORMANCE	15
8 SYSTEM VERIFICATION	20
8.1 SYSTEM SETUP.....	20
8.2 SYSTEM VERIFICATION	21
9 MEASUREMENT PROCEDURES	22
9.1 TESTS TO BE PERFORMED.....	22
9.2 GENERAL MEASUREMENT PROCEDURE	24
9.3 WCDMA MEASUREMENT PROCEDURES FOR SAR	25
9.4 BLUETOOTH & WI-FI MEASUREMENT PROCEDURES FOR SAR	26
9.5 SAR MEASUREMENT FOR LTE.....	26
9.6 LTE (TDD) CONSIDERATIONS.....	27
9.7 POWER DRIFT.....	28
10 AREA SCAN BASED 1-G SAR.....	29
10.1 REQUIREMENT OF KDB	29
10.2 FAST SAR ALGORITHMS.....	29
11 CONDUCTED OUTPUT POWER.....	30
11.1 GSM MEASUREMENT RESULT	30
11.3 CDMA MEASUREMENT RESULT	32

11.3 WCDMA MEASUREMENT RESULT	34
11.4 LTE MEASUREMENT RESULT	37
11.5 WI-FI AND BT MEASUREMENT RESULT	93
12 SIMULTANEOUS TX SAR CONSIDERATIONS	95
12.1 INTRODUCTION.....	95
12.2 TRANSMIT ANTENNA SEPARATION DISTANCES.....	95
12.3 SAR MEASUREMENT POSITIONS.....	96
12.4 STANDALONE SAR TEST EXCLUSION CONSIDERATIONS	96
13 EVALUATION OF SIMULTANEOUS.....	97
14 SAR TEST RESULT	98
14.1 SAR RESULTS.....	99
14.2 WLAN EVALUATION FOR 2.4G	124
14.3 WLAN EVALUATION FOR 5G.....	126
15 SAR MEASUREMENT VARIABILITY	129
16 MEASUREMENT UNCERTAINTY	131
16.1 MEASUREMENT UNCERTAINTY FOR NORMAL SAR TESTS (300MHZ~3GHZ)	131
16.2 MEASUREMENT UNCERTAINTY FOR FAST SAR TESTS (300MHZ~3GHZ)	132
16.3 MEASUREMENT UNCERTAINTY FOR NORMAL SAR TESTS (3GHZ~6GHZ)	133
16.4 MEASUREMENT UNCERTAINTY FOR FAST SAR TESTS (3GHZ~6GHZ)	134
17 MAIN TEST INSTRUMENTS.....	135
ANNEX A GRAPH RESULTS.....	136
ANNEX B SYSTEMVERIFICATION RESULTS	178
ANNEX C SAR MEASUREMENT SETUP.....	190
C.1 MEASUREMENT SET-UP	190
C.2 DASY5 E-FIELD PROBE SYSTEM	191
C.3 E-FIELD PROBE CALIBRATION.....	191
C.4 OTHER TEST EQUIPMENT.....	192
ANNEX D POSITION OF THE WIRELESS DEVICE IN RELATION TO THE PHANTOM	196
D.1 GENERAL CONSIDERATIONS	196
D.2 BODY-WORN DEVICE	197
D.3 DESKTOP DEVICE.....	197
D.4 DUT SETUP PHOTOS.....	198
ANNEX E EQUIVALENT MEDIA RECIPES.....	199
ANNEX F SYSTEM VALIDATION	200
ANNEX G LTE BAND 41 POWER CLASS 2 AND POWER CLASS 3 LINEARITY	201
ANNEX H DAE CALIBRATION CERTIFICATE.....	203
ANNEX I PROBE CALIBRATION CERTIFICATE	206
ANNEX J DIPOLE CALIBRATION CERTIFICATE.....	217
ANNEX K EXTENDED CALIBRATION SAR DIPOLE	281

1 Test Laboratory

1.1 Testing Location

Company Name:	Shenzhen Academy of Information and Communications Technology
Address:	Building G, Shenzhen International Innovation Center, No.1006 Shennan Road, Futian District, Shenzhen, Guangdong, P. R. China
Postal Code:	518026
Telephone:	+86-755-33322000
Fax:	+86-755-33322001

1.2 Testing Environment

Temperature:	18°C~25 °C
Relative humidity:	30%~ 70%
Ground system resistance:	<4Ω
Ambient noise & Reflection:	< 0.012 W/kg

1.3 Project Data

Testing Start Date:	April 02, 2019
Testing End Date:	April 22, 2019

1.4 Signature

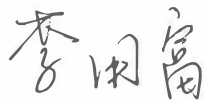

Li Yongfu

(Prepared this test report)



Zhang Yunzhan

(Reviewed this test report)



Cao Junfei

Deputy Director of the laboratory
(Approved this test report)

2 Statement of Compliance

The maximum results of Specific Absorption Rate (SAR) found during testing for Yulong Computer Telecommunication Scientific (Shenzhen) Co., Ltd Smartphone cp3705AS are as follows:

Table 2.1: Highest Reported SAR for Head (1g)

Exposure Configuration	Technology Band	Highest Reported SAR 1g(W/Kg)	Equipment Class
Head (Separation Distance 0mm)	GSM850	0.21	PCE
	PCS1900	0.12	
	CDMA BC0	0.27	
	CDMA BC1	0.18	
	CDMA BC10	0.20	
	UMTS FDD 5	0.21	
	UMTS FDD 2	0.22	
	UMTS FDD 4	0.17	
	LTE Band 2	0.17	
	LTE Band 4	0.22	
	LTE Band 5	0.18	
	LTE Band 7	0.15	
	LTE Band 12	0.13	
	LTE Band 13	0.17	
	LTE Band 25	0.16	
	LTE Band 26	0.21	
	LTE Band 41	0.08	
	LTE Band 66	0.19	
	LTE Band 71	0.03	
	WLAN 2.4GHz	0.78	DTS
WLAN 5GHz	1.37	NII	

Table 2.2: Highest Reported SAR for Hotspot (1g)

Exposure Configuration	Technology Band	Highest Reported SAR 1g(W/Kg)	Equipment Class
Hotspot (Separation Distance 10 mm)	GSM850	0.56	PCE
	PCS1900	1.27	
	CDMA BC0	0.48	
	CDMA BC1	1.37	
	CDMA BC10	0.38	
	UMTS FDD 5	0.42	
	UMTS FDD 2	1.28	
	UMTS FDD 4	1.01	
	LTE Band 2	1.40	
	LTE Band 4	1.07	
	LTE Band 5	0.59	
	LTE Band 7	1.24	
	LTE Band 12	0.31	
	LTE Band 13	0.36	
	LTE Band 25	1.19	
	LTE Band 26	0.44	
	LTE Band 41	0.79	
	LTE Band 66	1.13	
	LTE Band 71	0.09	
	WLAN 2.4GHz	0.30	DTS
WLAN 5GHz	0.54	NII	

Table 2.3: Highest Reported SAR for Body-worn (1g)

Exposure Configuration	Technology Band	Highest Reported SAR 1g(W/Kg)	Equipment Class
Body-worn (Separation Distance 15 mm)	GSM850	0.26	PCE
	PCS1900	1.18	
	CDMA BC0	0.26	
	CDMA BC1	1.18	
	CDMA BC10	0.20	
	UMTS FDD 5	0.30	
	UMTS FDD 2	0.99	
	UMTS FDD 4	0.76	
	LTE Band 2	0.90	
	LTE Band 4	0.78	
	LTE Band 5	0.26	
	LTE Band 7	0.90	
	LTE Band 12	0.15	
	LTE Band 13	0.19	
	LTE Band 25	1.13	
	LTE Band 26	0.29	
	LTE Band 41	0.61	
	LTE Band 66	1.10	
	LTE Band 71	0.05	
	WLAN 2.4GHz	0.08	DTS
WLAN 5GHz	0.31	NII	

The SAR values found for the Mobile Phone are below the maximum recommended levels of 1.6 W/Kg as averaged over any 1g tissue according to the ANSI C95.1-1992.

For body worn operation, this device has been tested and meets FCC RF exposure guidelines when used with any accessory that contains no metal and which provides a minimum separation distance from 10/15 mm between this device and the body of the user. Use of other accessories may not ensure compliance with FCC RF exposure guidelines.

The EUT battery must be fully charged and checked periodically during the test to ascertain uniform power output.

The measurement together with the test system set-up is described in annex C of this test report. A detailed description of the equipment under test can be found in chapter 4 of this test report.

The highest reported SAR value is obtained at the case of **(Table 2.1 & 2.2 & 2.3)**, and the values are: **1.40W/kg (1g)**.

Table 2.4: The sum of reported SAR values for main antenna and Wi-Fi

/	Position	Main antenna	Wi-Fi	Sum
Highest reported SAR value for Head	Left Touch	0.22	1.37	1.59
Highest reported SAR value for Hotspot	Bottom	1.40	/	1.40
Highest reported SAR value for Body-worn	Rear	1.18	0.31	1.49

Table2.5: The sum of reported SAR values for main antenna and BT

/	Position	Main antenna	BT*	Sum
Highest reported SAR value for Head	Left Touch	0.22	0.08	0.30
Highest reported SAR value for Hotspot	Bottom	1.40	0.04	1.44
Highest reported SAR value for Body-worn	Rear	1.18	0.03	1.21

BT*-Estimated SAR for Bluetooth (see the table 13.3)

According to the above tables, the highest sum of reported SAR values is **1.59W/kg (1g)**. The detail for simultaneous transmission consideration is described in chapter 13.

3 Client Information

3.1 Applicant Information

Company Name:	Yulong Computer Telecommunication Scientific (Shenzhen) Co., Ltd
Address /Post:	Building B, Boton Science Park, Chaguang Road, Xili Town, Nanshan District, Shenzhen
Contact:	Yentl Chen
Email:	chenyanting@yulong.com
Telephone:	+86 15927320221
Fax:	/

3.2 Manufacturer Information

Company Name:	Yulong Computer Telecommunication Scientific (Shenzhen) Co., Ltd
Address /Post:	Building B, Boton Science Park, Chaguang Road, Xili Town, Nanshan District, Shenzhen
Contact:	Yentl Chen
Email:	chenyanting@yulong.com
Telephone:	+86 15927320221
Fax:	/

4 Equipment under Test (EUT) and Ancillary Equipment (AE)

4.1 About EUT

Description:	Smartphone
Model Name:	cp3705AS
Operating mode(s):	GSM 850/1900, CDMA BC0/ BC1/ BC10, WCDMA 850/1700/1900, BT, Wi-Fi 2.4G/5G LTE Band 2/4/5/7/12/13/25/26/41/66/71
Condition of EUT as received	No obvious damage in appearance
Tested Tx Frequency:	825 – 848.8MHz (GSM 850)
	1850.2 – 1910MHz (GSM 1900)
	824.7 – 848.31MHz (CDMA BC0)
	1851.25 – 1908.75MHz (CDMA BC1)
	817.9 – 823.1MHz (CDMA BC10)
	826.4 – 846.6MHz (WCDMA850 Band V)
	1712.4 – 1752.6MHz (WCDMA1700 Band IV)
	1852.4 – 1907.6MHz (WCDMA1900 Band II)
	1850.7 – 1909.3MHz (LTE Band 2)
	1710.7 – 1754.3MHz (LTE Band 4)
	824.7 – 848.3MHz (LTE Band 5)
	2502.5 – 2567.5MHz (LTE Band 7)
	699.7 – 715.3MHz (LTE Band 12)
	779.5 – 784.5MHz (LTE Band 13)
	1850.7 – 1914.3MHz (LTE Band 25)
	814.7 – 848.3MHz (LTE Band 26)
	2498.5 – 2687.5MHz (LTE Band 41)
1710.7 – 1779.3MHz (LTE Band 66)	
665.5 – 695.5MHz (LTE Band 71)	
2412 – 2462MHz (Wi-Fi 2.4G)	
5150 – 5825MHz (Wi-Fi 5G)	
GPRS / EGPRS Multislot Class:	33
GPRS capability Class:	B
Test device Production information:	Production unit
Device type:	Portable device
Antenna type:	Integrated antenna
Hotspot mode:	Support

4.2 Internal Identification of EUT used during the test

EUT ID*	IMEI	HW Version	SW Version
EUT1	990013490002727	P0	9.0.3705AS.SPRINT.190408.1D
EUT2	990013490003154	P0	9.0.3705AS.SPRINT.190408.1D
EUT3	990013490006298	P0	9.0.3705AS.SPRINT.190408.1D

*EUT ID: is used to identify the test sample in the lab internally.

Note: It is performed to test SAR with the EUT 1 & EUT 2, and conducted power with the EUT 3.

4.3 Internal Identification of AE used during the test

AE ID*	Description	Type	Manufacturer
AE1	Battery	Li-ion Polymer	Tianjin Lishen
AE2	Battery	Li-ion Polymer	Zhuhai Coslight

*AE ID: is used to identify the test sample in the lab internally.

5 Test Methodology

5.1 Applicable Limit Regulations

ANSI C95.1–1992: IEEE Standard for Safety Levels with Respect to Human Exposure to Radio Frequency Electromagnetic Fields, 3 kHz to 300 GHz.

It specifies the maximum exposure limit of **1.6 W/kg** as averaged over any 1 gram of tissue for portable devices being used within 20 cm of the user in the uncontrolled environment.

5.2 Applicable Measurement Standards

IEEE 1528–2013: Recommended Practice for Determining the Peak Spatial-Average Specific Absorption Rate (SAR) in the Human Head from Wireless Communications Devices: Experimental Techniques.

KDB 447498 D01 General RF Exposure Guidance v06: Mobile and Portable Devices RF Exposure Procedures and Equipment Authorization Policies.

KDB 648474 D04 Handset SAR v01r03: SAR Evaluation Considerations for Wireless Handsets.

KDB 941225 D01 SAR test for 3G devices v03r01: SAR Measurement Procedures for 3G Devices

KDB 941225 D05 SAR for LTE Devices v02r05: SAR Evaluation Considerations for LTE Devices

KDB 941225 D06 Hot Spot SAR v02r01: SAR Evaluation Procedures for Portable Devices with Wireless Router Capabilities

KDB 248227 D01 802.11 Wi-Fi SAR v02r02: SAR Guidance for IEEE 802.11 (Wi-Fi) Transmitters.

KDB 865664 D01 SAR measurement 100 MHz to 6 GHz v01r04: SAR Measurement Requirements for 100 MHz to 6 GHz.

KDB 865664 D02 RF Exposure Reporting v01r02: RF Exposure Compliance Reporting and Documentation Considerations

KDB 941225 D05A LTE Rel.10 KDB Inquiry Sheet v01r02: REL. 10 LTE SAR TEST GUIDANCE AND KDB INQUIRIES

TCB workshop November 2017; RF Exposure Procedures (LTE UL/DL Carrier Aggregation SAR)

TCB workshop April 2019; RF Exposure Procedures (Tissue Simulating Liquids)

TCB workshop May 2017; RF Exposure Procedures (LTE Band 41 Power Class 2)

6 Specific Absorption Rate (SAR)

6.1 Introduction

SAR is related to the rate at which energy is absorbed per unit mass in an object exposed to a radio field. The SAR distribution in a biological body is complicated and is usually carried out by experimental techniques or numerical modeling. The standard recommends limits for two tiers of groups, occupational/controlled and general population/uncontrolled, based on a person's awareness and ability to exercise control over his or her exposure. In general, occupational/controlled exposure limits are higher than the limits for general population/uncontrolled.

6.2 SAR Definition

The SAR definition is the time derivative (rate) of the incremental energy (dW) absorbed by (dissipated in) an incremental mass (dm) contained in a volume element (dv) of a given density (ρ). The equation description is as below:

$$SAR = \frac{d}{dt} \left(\frac{dW}{dm} \right) = \frac{d}{dt} \left(\frac{dW}{\rho dv} \right)$$

SAR is expressed in units of Watts per kilogram (W/kg)

SAR measurement can be either related to the temperature elevation in tissue by

$$SAR = c \left(\frac{\delta T}{\delta t} \right)$$

Where: C is the specific heat capacity, δT is the temperature rise and δt is the exposure duration, or related to the electrical field in the tissue by

$$SAR = \frac{\sigma |E|^2}{\rho}$$

Where: σ is the conductivity of the tissue, ρ is the mass density of tissue and E is the RMS electrical field strength.

However for evaluating SAR of low power transmitter, electrical field measurement is typically applied.

7 Tissue Simulating Liquids

7.1 Targets for tissue simulating liquid

Table 7.1: Targets for tissue simulating liquid

Frequency (MHz)	Liquid Type	Conductivity (σ)	$\pm 5\%$ Range	Permittivity (ϵ)	$\pm 5\%$ Range
750	Head	0.89	0.85~0.93	41.94	39.8~44.0
835	Head	0.90	0.86~0.95	41.50	39.4~43.6
1750	Head	1.37	1.30~1.44	40.08	38.1~42.1
1900	Head	1.40	1.33~1.47	40.00	38.0~42.0
2450	Head	1.80	1.71~1.89	39.20	37.2~41.2
2550	Head	1.91	1.81~2.01	39.07	37.1~41.0
5300	Head	4.76	4.52~5.00	35.87	34.1~37.6
5600	Head	5.07	4.82~5.32	35.53	33.8~37.3
5800	Head	5.27	5.01~5.53	35.30	33.5~37.1

7.2 Dielectric Performance

Table 7.2: Dielectric Performance of Tissue Simulating Liquid

Measurement Date (yyyy-mm-dd)	Type	Frequency	Conductivity σ (S/m)	Drift (%)	Permittivity ϵ	Drift (%)
2019-4-16	Head	750	0.912	2.47	40.85	-2.60
2019-4-2	Head	835	0.913	1.44	40.36	-2.75
2019-4-3	Head	835	0.911	1.22	40.49	-2.43
2019-4-9	Head	1750	1.381	0.80	39.52	-1.40
2019-4-11	Head	1900	1.385	-1.07	40.68	1.70
2019-4-12	Head	1900	1.391	-0.64	40.55	1.37
2019-4-20	Head	2450	1.856	3.11	38.74	-1.17
2019-4-18	Head	2550	1.967	2.98	38.06	-2.59
2019-4-22	Head	5300	4.884	2.61	34.81	-2.96
2019-4-22	Head	5600	4.968	-2.01	36.23	1.97
2019-4-22	Head	5800	5.203	-1.27	35.79	1.39

Note: The liquid temperature is 22.0°C.

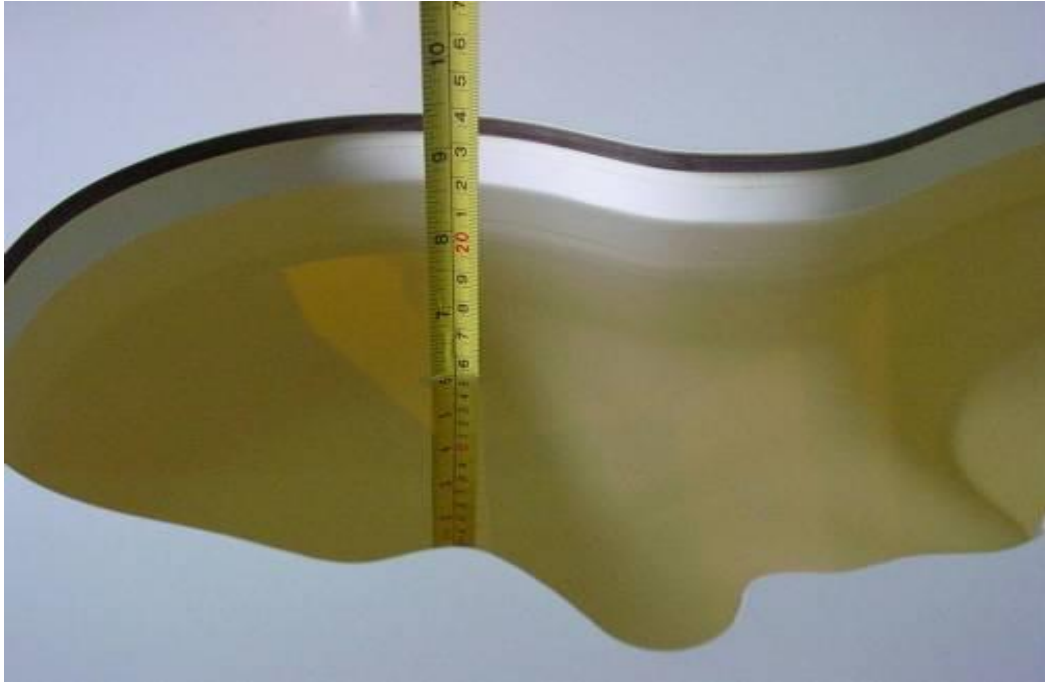

Picture 7-1: Liquid depth in the Head Phantom (750 MHz)

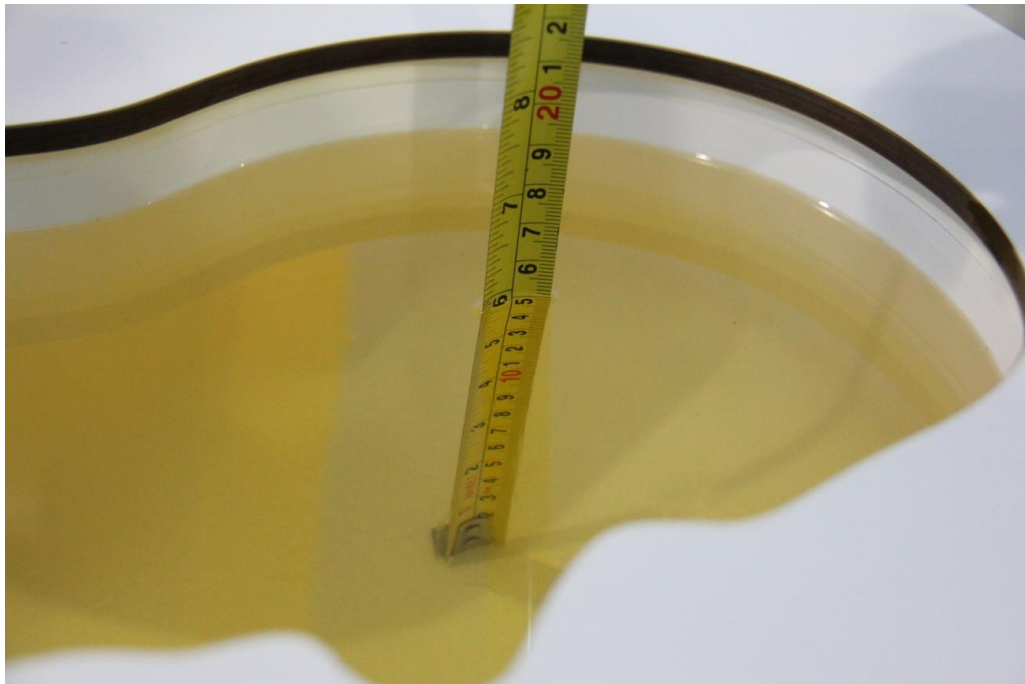

Picture 7-2: Liquid depth in the Head Phantom (835 MHz)

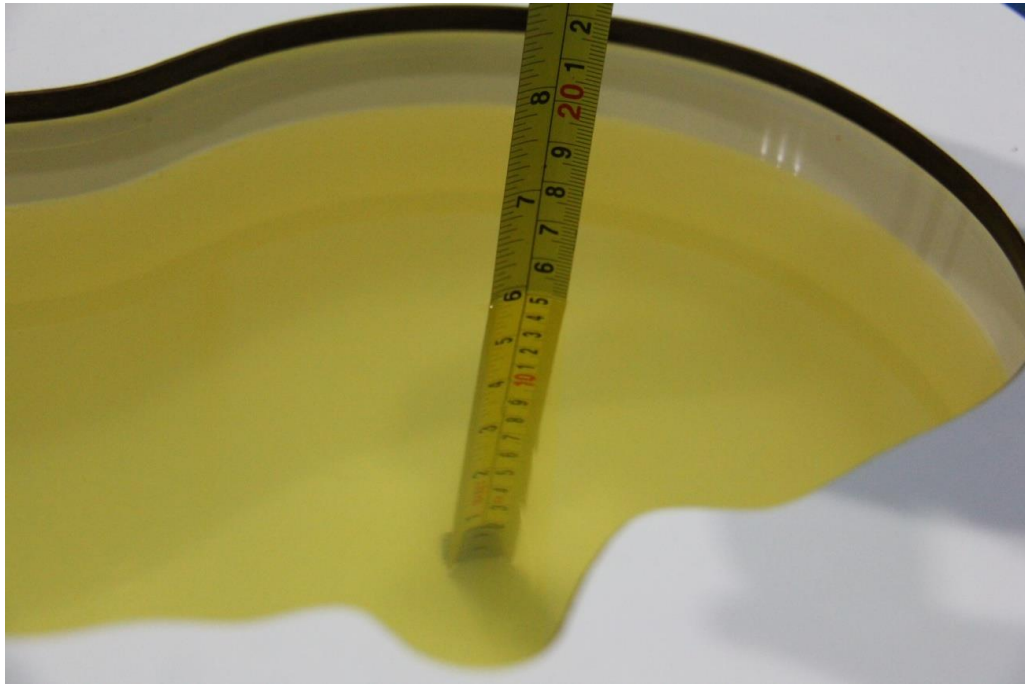

Picture 7-3: Liquid depth in the Head Phantom (1750 MHz)



Picture 7-4: Liquid depth in the Head Phantom (1900 MHz)

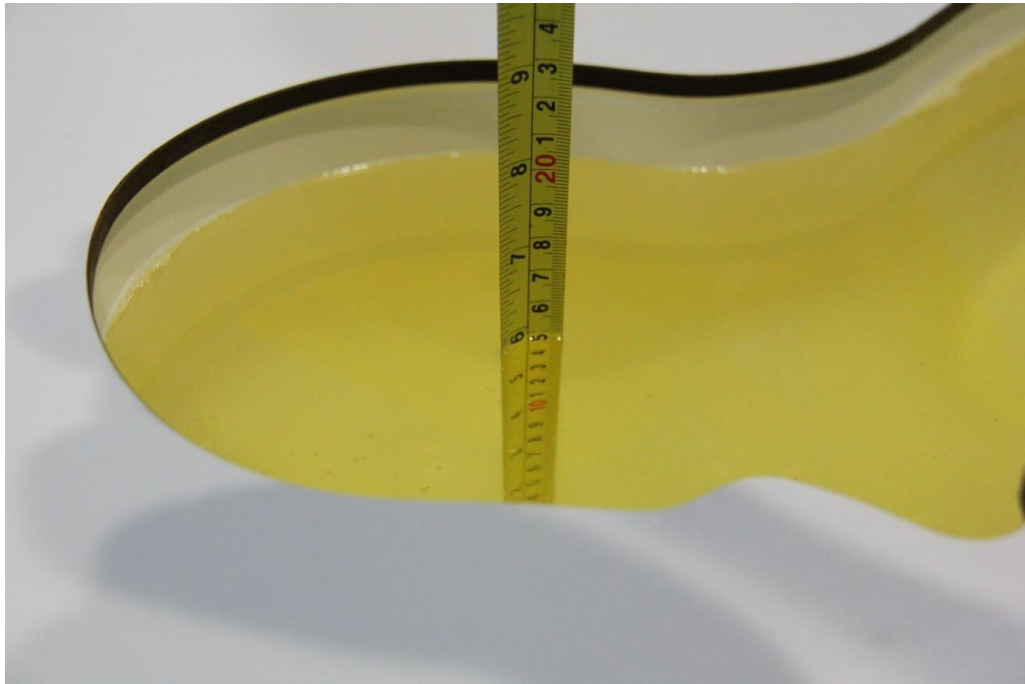

Picture 7-5: Liquid depth in the Head Phantom(2450MHz)

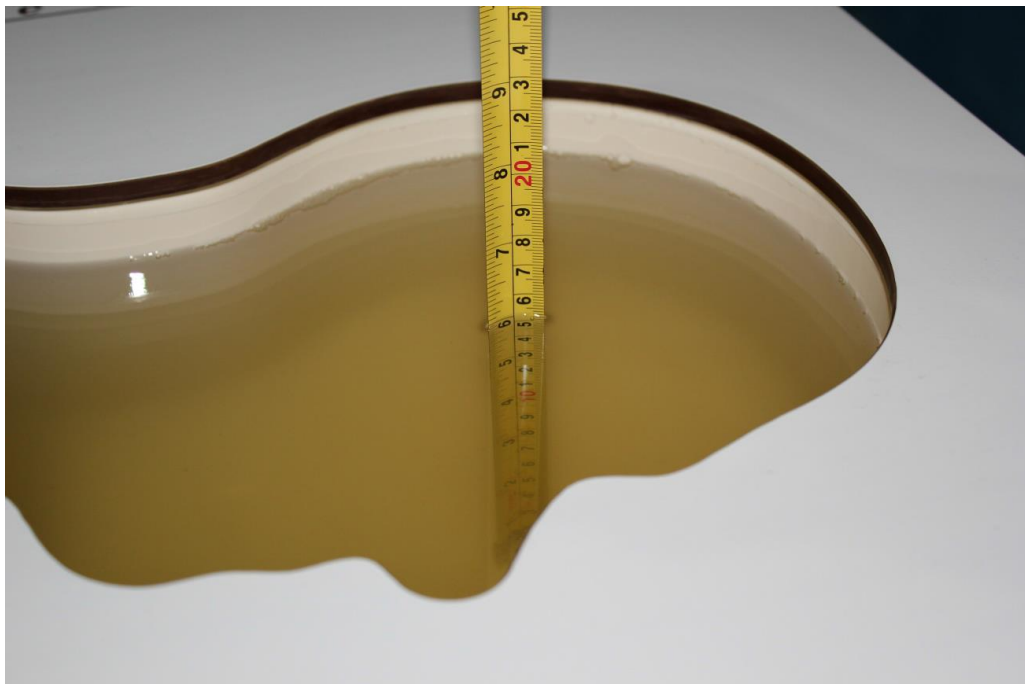

Picture 7-6: Liquid depth in the Head Phantom(2550MHz)



Picture 7-7: Liquid depth in the Head Phantom (5GHz)

8 System verification

8.1 System Setup

In the simplified setup for system evaluation, the DUT is replaced by a calibrated dipole and the power source is replaced by a continuous wave that comes from a signal generator. The calibrated dipole must be placed beneath the flat phantom section of the SAM twin phantom with the correct distance holder. The distance holder should touch the phantom surface with a light pressure at the reference marking and be oriented parallel to the long side of the phantom. The equipment setup is shown below:

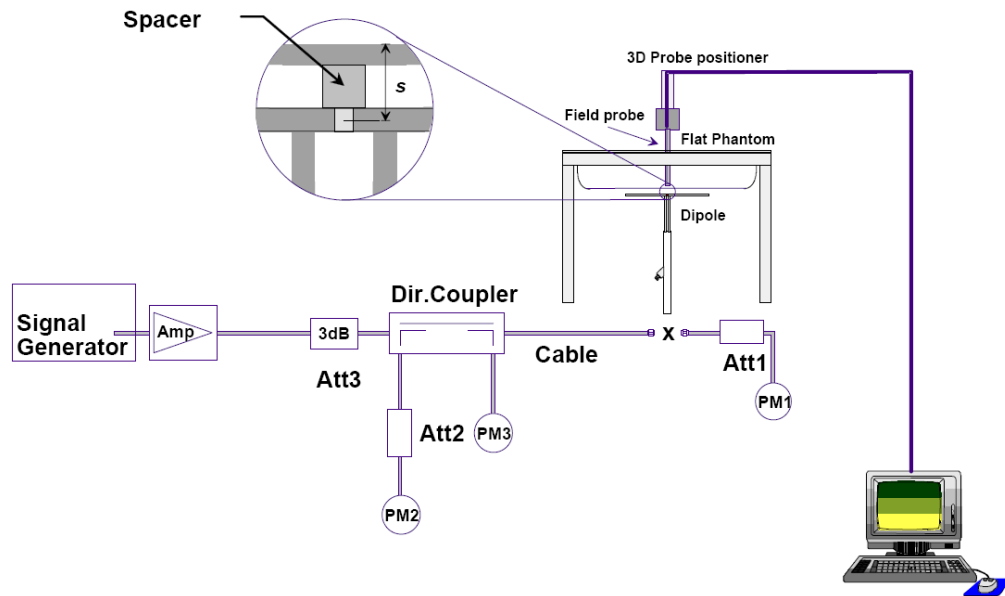

Picture 8.1 System Setup for System Evaluation



Picture 8.2 Photo of Dipole Setup

8.2 System Verification

SAR system verification is required to confirm measurement accuracy, according to the tissue dielectric media, probe calibration points and other system operating parameters required for measuring the SAR of a test device. The system verification must be performed for each frequency band and within the valid range of each probe calibration point required for testing the device.

The system verification results are required that the area scan estimated 1-g SAR is within 3% of the zoom scan 1-g SAR. The details are presented in annex B.

Table 8.1: System Verification of Head

Measurement Date (yyyy-mm-dd)	Frequency	Target value (W/kg)		Measured value (W/kg)		Deviation (%)	
		10 g Average	1 g Average	10 g Average	1 g Average	10 g Average	1 g Average
2019-4-16	750 MHz	5.43	8.26	5.52	8.56	1.66	3.63
2019-4-2	835 MHz	6.29	9.62	6.40	9.88	1.75	2.70
2019-4-3	835 MHz	6.29	9.62	6.36	9.80	1.11	1.87
2019-4-9	1750 MHz	19.40	36.60	19.64	37.52	1.24	2.51
2019-4-11	1900 MHz	21.00	40.50	20.60	39.44	-1.90	-2.62
2019-4-12	1900 MHz	21.00	40.50	20.72	39.72	-1.33	-1.93
2019-4-20	2450 MHz	24.10	52.00	24.44	53.60	1.41	3.08
2019-4-18	2550 MHz	26.50	57.80	27.12	60.40	2.34	4.50
2019-4-22	5300 MHz	23.70	83.00	24.20	85.90	2.11	3.49
2019-4-22	5600 MHz	23.60	82.90	23.10	80.20	-2.12	-3.26
2019-4-22	5800 MHz	22.30	78.80	22.00	77.10	-1.35	-2.16

9 Measurement Procedures

9.1 Tests to be performed

In order to determine the highest value of the peak spatial-average SAR of a handset, all device positions, configurations and operational modes shall be tested for each frequency band according to steps 1 to 3 below. A flowchart of the test process is shown in picture 9.1.

Step 1: The tests described in 9.2 shall be performed at the channel that is closest to the center of the transmit frequency band (f_c) for:

- a) all device positions (cheek and tilt, for both left and right sides of the SAM phantom, as described in annex D),
- b) all configurations for each device position in a), e.g., antenna extended and retracted, and
- c) all operational modes, e.g., analogue and digital, for each device position in a) and configuration in b) in each frequency band.

If more than three frequencies need to be tested according to 11.1 (i.e., $N_c > 3$), then all frequencies, configurations and modes shall be tested for all of the above test conditions.

Step 2: For the condition providing highest peak spatial-average SAR determined in Step 1, perform all tests described in 9.2 at all other test frequencies, i.e., lowest and highest frequencies. In addition, for all other conditions (device position, configuration and operational mode) where the peak spatial-average SAR value determined in Step 1 is within 3 dB of the applicable SAR limit, it is recommended that all other test frequencies shall be tested as well.

Step 3: Examine all data to determine the highest value of the peak spatial-average SAR found in Steps 1 to 2.

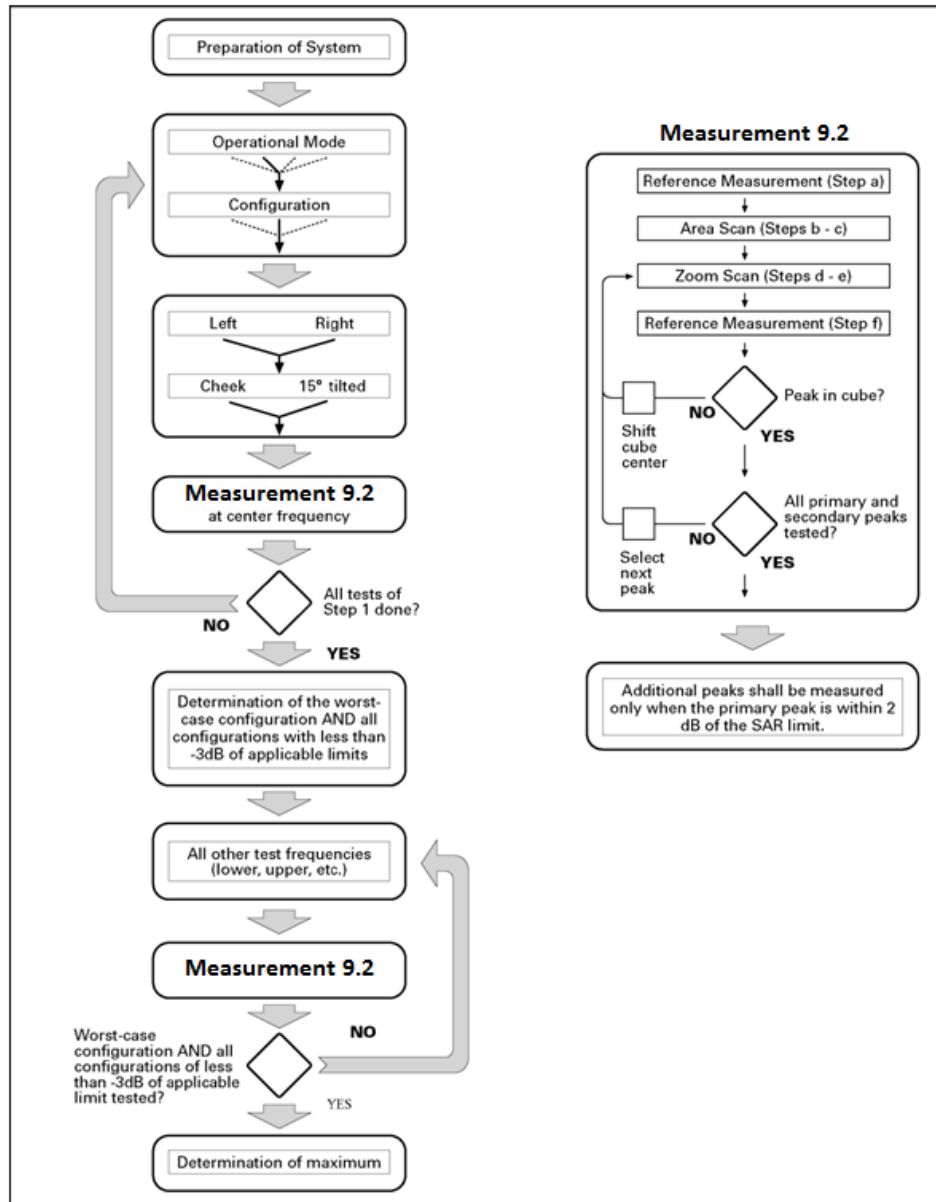

Picture 9.1 Block diagram of the tests to be performed

9.2 General Measurement Procedure

The area and zoom scan resolutions specified in the table below must be applied to the SAR measurements and fully documented in SAR reports to qualify for TCB approval. Probe boundary effect error compensation is required for measurements with the probe tip closer than half a probe tip diameter to the phantom surface. Both the probe tip diameter and sensor offset distance must satisfy measurement protocols; to ensure probe boundary effect errors are minimized and the higher fields closest to the phantom surface can be correctly measured and extrapolated to the phantom surface for computing 1-g SAR. Tolerances of the post-processing algorithms must be verified by the test laboratory for the scan resolutions used in the SAR measurements, according to the reference distribution functions specified in IEEE Std 1528-2013. The results should be documented as part of the system validation records and may be requested to support test results when all the measurement parameters in the following table are not satisfied.

		≤ 3 GHz	> 3 GHz	
Maximum distance from closest measurement point (geometric center of probe sensors) to phantom surface		5 ± 1 mm	$\frac{1}{2} \cdot \delta \cdot \ln(2) \pm 0.5$ mm	
Maximum probe angle from probe axis to phantom surface normal at the measurement location		$30^\circ \pm 1^\circ$	$20^\circ \pm 1^\circ$	
Maximum area scan spatial resolution: $\Delta x_{Area}, \Delta y_{Area}$		≤ 2 GHz: ≤ 15 mm 2 – 3 GHz: ≤ 12 mm	3 – 4 GHz: ≤ 12 mm 4 – 6 GHz: ≤ 10 mm	
		When the x or y dimension of the test device, in the measurement plane orientation, is smaller than the above, the measurement resolution must be \leq the corresponding x or y dimension of the test device with at least one measurement point on the test device.		
Maximum zoom scan spatial resolution: $\Delta x_{Zoom}, \Delta y_{Zoom}$		≤ 2 GHz: ≤ 8 mm 2 – 3 GHz: ≤ 5 mm*	3 – 4 GHz: ≤ 5 mm* 4 – 6 GHz: ≤ 4 mm*	
Maximum zoom scan spatial resolution, normal to phantom surface	uniform grid: $\Delta z_{Zoom}(n)$	≤ 5 mm	3 – 4 GHz: ≤ 4 mm 4 – 5 GHz: ≤ 3 mm 5 – 6 GHz: ≤ 2 mm	
	graded grid	$\Delta z_{Zoom}(1)$: between 1 st two points closest to phantom surface	≤ 4 mm	3 – 4 GHz: ≤ 3 mm 4 – 5 GHz: ≤ 2.5 mm 5 – 6 GHz: ≤ 2 mm
		$\Delta z_{Zoom}(n>1)$: between subsequent points	$\leq 1.5 \cdot \Delta z_{Zoom}(n-1)$	
Minimum zoom scan volume	x, y, z	≥ 30 mm	3 – 4 GHz: ≥ 28 mm 4 – 5 GHz: ≥ 25 mm 5 – 6 GHz: ≥ 22 mm	
<p>Note: δ is the penetration depth of a plane-wave at normal incidence to the tissue medium; see draft standard IEEE P1528-2011 for details.</p> <p>* When zoom scan is required and the <i>reported</i> SAR from the area scan based 1-g SAR estimation procedures of KDB 447498 is ≤ 1.4 W/kg, ≤ 8 mm, ≤ 7 mm and ≤ 5 mm zoom scan resolution may be applied, respectively, for 2 GHz to 3 GHz, 3 GHz to 4 GHz and 4 GHz to 6 GHz.</p>				

9.3 WCDMA Measurement Procedures for SAR

The following procedures are applicable to WCDMA handsets operating under 3GPP Release99, Release 5 and Release 6. The default test configuration is to measure SAR with an established radio link between the DUT and a communication test set using a 12.2kbps RMC (reference measurement channel) configured in Test Loop Mode 1. SAR is selectively confirmed for other physical channel configurations (DPCCH & DPDCH_n), HSDPA and HSPA (HSUPA/HSDPA) modes according to output power, exposure conditions and device operating capabilities. Both uplink and downlink should be configured with the same RMC or AMR, when required. SAR for Release 5 HSDPA and Release 6 HSPA are measured using the applicable FRC (fixed reference channel) and E-DCH reference channel configurations. Maximum output power is verified according to applicable versions of 3GPP TS 34.121 and SAR must be measured according to these maximum output conditions. When Maximum Power Reduction (MPR) is not implemented according to Cubic Metric (CM) requirements for Release 6 HSPA, the following procedures do not apply.

For Release 5 HSDPA Data Devices:

Sub-test	β_c	β_d	β_d (SF)	β_c / β_d	β_{hs}	CM/dB
1	2/15	15/15	64	2/15	4/15	0.0
2	12/15	15/15	64	12/15	24/25	1.0
3	15/15	8/15	64	15/8	30/15	1.5
4	15/15	4/15	64	15/4	30/15	1.5

For Release 6 HSPA Data Devices

Sub-test	β_c	β_d	β_d (SF)	β_c / β_d	β_{hs}	β_{ec}	β_{ed}	β_{ed} (SF)	β_{ed} (codes)	CM (dB)	MPR (dB)	AG Index	E-TFCI
1	11/15	15/15	64	11/15	22/15	209/225	1039/225	4	1	1.0	0.0	20	75
2	6/15	15/15	64	6/15	12/15	12/15	12/15	4	1	3.0	2.0	12	67
3	15/15	9/15	64	15/9	30/15	30/15	$\beta_{ed1}:47/15$ $\beta_{ed2}:47/15$	4	2	2.0	1.0	15	92
4	2/15	15/15	64	2/15	4/15	4/15	56/75	4	1	3.0	2.0	17	71
5	15/15	15/15	64	15/15	24/15	30/15	134/15	4	1	1.0	0.0	21	81

9.4 Bluetooth & WI-FI Measurement Procedures for SAR

Normal network operating configurations are not suitable for measuring the SAR of 802.11 transmitters in general. Unpredictable fluctuations in network traffic and antenna diversity conditions can introduce undesirable variations in SAR results. The SAR for these devices should be measured using chipset based test mode software to ensure that the results are consistent and reliable.

Chipset based test mode software is hardware dependent and generally varies among manufacturers. The device operating parameters established in a test mode for SAR measurements must be identical to those programmed in production units, including output power levels, amplifier gain settings and other RF performance tuning parameters. The test frequencies should correspond to actual channel frequencies defined for domestic use. SAR for devices with switched diversity should be measured with only one antenna transmitting at a time during each SAR measurement, according to a fixed modulation and data rate. The same data pattern should be used for all measurements.

9.5 SAR Measurement for LTE

SAR tests for LTE are performed with a base station simulator, Anristu MT8820C. Closed loop power control was used so the UE transmits with maximum output power during SAR testing. All powers were measured with the Anristu MT8820C. It is performed for conducted power and SAR based on the KDB941225 D05.

SAR is evaluated separately according to the following procedures for the different test positions in each exposure condition – head, body, body-worn accessories and other use conditions. The procedures in the following subsections are applied separately to test each LTE frequency band.

1) QPSK with 1 RB allocation

Start with the largest channel bandwidth and measure SAR for QPSK with 1 RB allocation, using the RB offset and required test channel combination with the highest maximum output power among RB offsets at the upper edge, middle and lower edge of each required test channel. When the reported SAR is ≤ 0.8 W/kg, testing of the remaining RB offset configurations and required test channels is not required for 1 RB allocation; otherwise, SAR is required for the remaining required test channels and only for the RB offset configuration with the highest output power for that channel. When the reported SAR of a required test channel is > 1.45 W/kg, SAR is required for all three RB offset configurations for that required test channel.

2) QPSK with 50% RB allocation

The procedures required for 1 RB allocation in 1) are applied to measure the SAR for QPSK with 50% RB allocation.

3) QPSK with 100% RB allocation

For QPSK with 100% RB allocation, SAR is not required when the highest maximum output power for 100 % RB allocation is less than the highest maximum output power in 50% and 1 RB allocations and the highest reported SAR for 1 RB and 50% RB allocation in 1) and 2) are ≤ 0.8 W/kg. Otherwise, SAR is measured for the highest output power channel; and if the reported SAR is > 1.45 W/kg, the remaining required test channels must also be tested.

9.6 LTE (TDD) Considerations

According to KDB 941225 D05 SAR for LTE Devices, for Time-Division Duplex (TDD) systems, SAR must be tested using a fixed periodic duty factor according to the highest transmission duty factor implemented for the device and supported by the defined 3GPP LTE TDD configurations.

SAR was tested with the highest transmission duty factor (63.33%) using Uplink-downlink configuration 0 and Special subframe configuration 7.

LTE TDD Band 41 support 3GPP TS 36.211 section 4.2 for Type 2 Frame Structure and Table 4.2-2 for uplink-downlink configurations and Table 4.2-1 for Special subframe configurations.

Special subframe configuration	Normal cyclic prefix in downlink			Extended cyclic prefix in downlink		
	DwPTS	UpPTS		DwPTS	UpPTS	
		Normal cyclic prefix in uplink	Extended cyclic prefix in uplink		Normal cyclic prefix in uplink	Extended cyclic prefix in uplink
0	$6592 \cdot T_s$	$2192 \cdot T_s$	$2560 \cdot T_s$	$7680 \cdot T_s$	$2192 \cdot T_s$	$2560 \cdot T_s$
1	$19760 \cdot T_s$			$20480 \cdot T_s$		
2	$21952 \cdot T_s$			$23040 \cdot T_s$		
3	$24144 \cdot T_s$			$25600 \cdot T_s$		
4	$26336 \cdot T_s$			$7680 \cdot T_s$		
5	$6592 \cdot T_s$	$4384 \cdot T_s$	$5120 \cdot T_s$	$20480 \cdot T_s$	$4384 \cdot T_s$	$5120 \cdot T_s$
6	$19760 \cdot T_s$			$23040 \cdot T_s$		
7	$21952 \cdot T_s$			$12800 \cdot T_s$		
8	$24144 \cdot T_s$			-		
9	$13168 \cdot T_s$			-		

Configuration of special subframe (lengths of DwPTS/GP/UpPTS)

Uplink-Downlink Configuration	Downlink-to-Uplink Switch-point Periodicity	Subframe Number										Calculated Duty Cycle (%)
		0	1	2	3	4	5	6	7	8	9	
0	5 ms	D	S	U	U	U	D	S	U	U	U	63.33
1	5 ms	D	S	U	U	D	D	S	U	U	D	43.33
2	5 ms	D	S	U	D	D	D	S	U	D	D	23.33
3	10 ms	D	S	U	U	U	D	D	D	D	D	31.67
4	10 ms	D	S	U	U	D	D	D	D	D	D	21.67
5	10 ms	D	S	U	D	D	D	D	D	D	D	11.67
6	5 ms	D	S	U	U	U	D	S	U	U	D	53.33

Calculated Duty Cycle

Calculated Duty Cycle = Extended cyclic prefix in uplink x (Ts) x # of S + # of U

Example for Calculated Duty Cycle for Uplink-Downlink Configuration 0:

Calculated Duty Cycle = $5120 \times [1/(15000 \times 2048)] \times 2 + 6 \text{ ms} = 63.33\%$

Where

$T_s = 1/(15000 \times 2048)$ seconds

Note:

1. From May 2017 TCB Workshop, HPUE does not support uplink-downlink configurations 0 and 6.
2. This device supports uplink-downlink configurations 0-6. The configuration with highest duty cycle was used for SAR Testing: configuration 0 at 63.3% (Power Class 3) and configuration 1 at 43.3% (Power Class 2) duty cycle.

9.7 Power Drift

To control the output power stability during the SAR test, DASY5 system calculates the power drift by measuring the E-field at the same location at the beginning and at the end of the measurement for each test position. These drift values can be found in Section 14 labeled as: (Power Drift [dB]). This ensures that the power drift during one measurement is within 5%.

10 Area Scan Based 1-g SAR

10.1 Requirement of KDB

According to the KDB447498 D01, when the implementation is based the specific polynomial fit algorithm as presented at the 29th Bioelectromagnetics Society meeting (2007) and the estimated 1-gSAR is ≤ 1.2 W/kg, a zoom scan measurement is not required provided it is also not needed for any other purpose; for example, if the peak SAR location required for simultaneous transmission SAR test exclusion can be determined accurately by the SAR system or manually to discriminate between distinctive peaks and scattered noisy SAR distributions from area scans.

There must not be any warning or alert messages due to various measurement concerns identified by the SAR system; for example, noise in measurements, peaks too close to scan boundary, peaks are too sharp, spatial resolution and uncertainty issues etc. The SAR system verification must also demonstrate that the area scan estimated 1-g SAR is within 3% of the zoom scan 1-g SAR (See Annex B). When all the SAR results for each exposure condition in a frequency band and wireless mode are based on estimated 1-g SAR, the 1-g SAR for the highest SAR configuration must be determined by a zoom scan.

10.2 Fast SAR Algorithms

The approach is based on the area scan measurement applying a frequency dependent attenuation parameter. This attenuation parameter was empirically determined by analyzing a large number of phones. The MOTOROLA FAST SAR was developed and validated by the MOTOROLA Research Group in Ft. Lauderdale.

In the initial study, an approximation algorithm based on Linear fit was developed. The accuracy of the algorithm has been demonstrated across a broad frequency range (136-2450 MHz) and for both 1- and 10-g averaged SAR using a sample of 264 SAR measurements from 55 wireless handsets. For the sample size studied, the root-mean-squared errors of the algorithm are 1.2% and 5.8% for 1- and 10-g averaged SAR, respectively. The paper describing the algorithm in detail is expected to be published in August 2004 within the Special Issue of Transactions on MTT.

In the second step, the same research group optimized the fitting algorithm to an Polynomial fit whereby the frequency validity was extended to cover the range 30-6000MHz. Details of this study can be found in the BEMS 2007 Proceedings.

Both algorithms are implemented in DASY software.

11 Conducted Output Power

11.1 GSM Measurement result

During the process of testing, the EUT was controlled via Agilent Digital Radio Communication tester (E5515C) to ensure the maximum power transmission and proper modulation. This result contains conducted output power for the EUT. In all cases, the measured peak output power should be greater and within 5% than EMI measurement.

Table 11.1: The conducted power measurement results for GSM

Full Power / Hotspot on				
GSM 850MHz	Tune up	Conducted Power (dBm)		
	34	Channel 251(848.8MHz)	Channel 190(836.6MHz)	Channel 128(824.2MHz)
		33.30	33.15	32.95
Full Power				
GSM 1900MHz	Tune up	Conducted Power(dBm)		
	30	Channel 810(1909.8MHz)	Channel 661(1880MHz)	Channel512(1850.2MHz)
		28.88	28.97	29.00
Hotspot on				
GSM 1900MHz	Tune up	Conducted Power(dBm)		
	24	Channel 810(1909.8MHz)	Channel 661(1880MHz)	Channel512(1850.2MHz)
		23.32	23.49	23.63

Table 11.2: The conducted power measurement results for GPRS and EGPRS

Full Power / Hotspot on								
GPRS850/ EGPRS850	Tune up	Measured Power (dBm)			calculation	Average Power (dBm)		
		251	190	128		251	190	128
1Tx-slots	34	32.29	33.14	32.94	-9.03dB	23.26	24.11	23.91
2Tx-slots	32	30.90	30.74	30.56	-6.02dB	24.88	24.72	24.54
3Tx-slots	29	28.44	28.25	28.08	-4.26dB	24.18	23.99	23.82
4Tx-slots	29	28.24	28.07	27.89	-3.01dB	25.23	25.06	24.88
EGPRS 850 (8PSK)	Tune up	Measured Power (dBm)			calculation	Measured Power (dBm)		
		251	190	128		251	190	128
1Tx-slots	27	26.67	26.60	26.55	-9.03dB	17.64	17.57	17.52
2Tx-slots	26	25.50	25.37	25.26	-6.02dB	19.48	19.35	19.24
3Tx-slots	24	23.13	23.06	22.90	-4.26dB	18.87	18.8	18.64
4Tx-slots	24	22.89	22.79	22.73	-3.01dB	19.88	19.78	19.72

Full Power								
GPRS1900/ EGPRS1900	Tune up	Measured Power (dBm)			calculation	Average Power (dBm)		
		810	661	512		810	661	512
1Tx-slots	30	28.92	29.01	29.04	-9.03dB	19.89	19.98	20.01
2Tx-slots	29	27.78	27.88	28.03	-6.02dB	21.76	21.86	22.01
3Tx-slots	27	26.53	26.72	26.85	-4.26dB	22.27	22.46	22.59
4Tx-slots	26	25.36	25.52	25.69	-3.01dB	22.35	22.51	22.68
EGPRS 1900 (8PSK)	Tune up	Measured Power (dBm)			calculation	Measured Power (dBm)		
		810	661	512		810	661	512
1Tx-slots	27	25.64	25.74	25.95	-9.03dB	16.61	16.71	16.92
2Tx-slots	26	24.63	24.44	24.66	-6.02dB	18.61	18.42	18.64
3Tx-slots	22	21.18	20.93	21.11	-4.26dB	16.92	16.67	16.85
4Tx-slots	22	20.55	20.68	20.93	-3.01dB	17.54	17.67	17.92
Hotspot on								
GPRS1900/ EGPRS1900	Tune up	Measured Power (dBm)			calculation	Average Power (dBm)		
		810	661	512		810	661	512
1Tx-slots	24	23.30	23.51	23.65	-9.03dB	14.27	14.48	14.62
2Tx-slots	24	23.21	23.38	23.54	-6.02dB	17.19	17.36	17.52
3Tx-slots	23.5	23.07	23.21	23.30	-4.26dB	18.81	18.95	19.04
4Tx-slots	23.5	22.80	23.02	23.14	-3.01dB	19.79	20.01	20.13
EGPRS 1900 (8PSK)	Tune up	Measured Power (dBm)			calculation	Measured Power (dBm)		
		810	661	512		810	661	512
1Tx-slots	23.5	22.72	22.87	23.04	-9.03dB	13.69	13.84	14.01
2Tx-slots	23.5	22.46	22.64	22.86	-6.02dB	16.44	16.62	16.84
3Tx-slots	22	20.73	20.99	21.12	-4.26dB	16.47	16.73	16.86
4Tx-slots	22	20.55	20.76	20.94	-3.01dB	17.54	17.75	17.93

NOTES:

1) Division Factors

To average the power, the division factor is as follows:

1TX-slot = 1 transmit time slot out of 8 time slots=> conducted power divided by (8/1) => -9.03dB

2TX-slots = 2 transmit time slots out of 8 time slots=> conducted power divided by (8/2) => -6.02dB

3TX-slots = 3 transmit time slots out of 8 time slots=> conducted power divided by (8/3) => -4.26dB

4TX-slots = 4 transmit time slots out of 8 time slots=> conducted power divided by (8/4) => -3.01dB

According to the conducted power as above, the body measurements are performed with 4Txslots for 850MHz and 1900MHz.

11.3 CDMA Measurement result

Table 11.3: The conducted power measurement results for CDMA

Full Power / Hotspot on				
CDMA BC0	Tune up	Conducted Power (dBm)		
		Channel 777 (848.31MHz)	Channel 384 (836.52MHz)	Channel 1013 (824.7MHz)
SO55/RC3	24.5	24.14	24.07	23.89
SO55/RC1	24.5	24.20	24.11	23.94
SO32/RC3(FCH only)	24.5	24.17	24.10	23.79
SO32/RC3(FCH+SCHn)	24.5	24.16	24.08	23.97
EVDO Rev.0	24.5	24.15	24.07	23.89
EVDO Rev.A	24.5	24.18	24.09	24.88
CDMA BC10	Tune up	Conducted Power (dBm)		
		Channel 684 (823.1MHz)	Channel 580 (820.5MHz)	Channel 476 (817.9MHz)
SO55/RC3	24.5	23.96	23.95	23.94
SO55/RC1	24.5	24.02	23.99	23.98
SO32/RC3(FCH only)	24.5	23.98	24.02	23.93
SO32/RC3(FCH+SCHn)	24.5	23.99	24.01	23.95
EVDO Rev.0	24.5	23.97	23.98	23.94
EVDO Rev.A	24.5	24.01	24.01	23.96

Full Power				
CDMA BC1	Tune up	Conducted Power (dBm)		
		Channel 1175 (1908.75MHz)	Channel 600 (1880MHz)	Channel 25 (1851.25MHz)
SO55/RC3	24.5	23.63	23.71	23.84
SO55/RC1	24.5	23.66	23.76	23.87
SO32/RC3(FCH only)	24.5	23.65	23.71	23.85
SO32/RC3(FCH+SCHn)	24.5	23.64	23.73	23.86
EVDO Rev.0	24.5	23.59	23.75	23.84
EVDO Rev.A	24.5	23.61	23.72	23.82
Hotspot on				
CDMA BC1	Tune up	Conducted Power (dBm)		
		Channel 1175 (1908.75MHz)	Channel 600 (1880MHz)	Channel 25 (1851.25MHz)
SO55/RC3	20	19.16	19.19	19.35
SO55/RC1	20	19.17	19.21	19.37
SO32/RC3(FCH only)	20	19.15	19.19	19.34
SO32/RC3(FCH+SCHn)	20	19.16	19.20	19.36
EVDO Rev.0	20	19.18	19.17	19.35
EVDO Rev.A	20	19.16	19.20	19.32

11.3 WCDMA Measurement result

Table 11.4: T The conducted power measurement results WCDMA

Full Power / Hotspot on					
Item	band	FDD Band 5 result			
	ARFCN	Tune up	4233 (846.6MHz)	4182 (836.4MHz)	4132 (826.4MHz)
WCDMA	\	24	23.3	23.5	23.2
HSUPA	1	23	22.3	22.6	22.1
	2	21	20.3	20.5	20.2
	3	22	21.3	21.6	21.1
	4	21	20.3	20.5	20.1
	5	23	22.3	22.5	22.1
HSDPA	1	23	22.3	22.5	22.1
	2	23	22.4	22.6	22.1
	3	23	21.9	22.1	21.6
	4	23	21.9	22.1	21.6
DC-HSDPA	1	23	22.1	22.3	22.0
	2	23	22.2	22.4	22.1
	3	23	21.8	22.0	21.4
	4	23	21.7	22.0	21.5

Full Power					
Item	band	FDD Band 2 result			
	ARFCN	Tune up	9538 (1907.6MHz)	9400 (1880MHz)	9262 (1852.4MHz)
WCDMA	\	23.5	22.6	22.6	22.8
HSDPA	1	22.5	21.7	21.7	21.8
	2	20.5	19.8	19.7	19.8
	3	21.5	20.7	20.7	20.8
	4	20.5	19.7	19.7	19.8
	5	22.5	21.8	21.8	21.8
HSDPA	1	22.5	21.6	21.7	21.8
	2	22.5	21.7	21.7	21.8
	3	22.5	21.2	21.2	21.4
	4	22.5	21.1	21.2	21.4
DC-HSDPA	1	22.5	21.4	21.5	21.6
	2	22.5	21.6	21.6	21.7
	3	22.5	21.1	21.1	21.2
	4	22.5	21.1	21.2	21.2
Item	band	FDD Band 4 result			
	ARFCN	Tune up	1513 (1752.6MHz)	1413 (1732.6MHz)	1312 (1712.4MHz)
WCDMA	\	24.5	23.8	23.7	23.9
HSDPA	1	23.5	22.8	22.7	22.9
	2	21.5	20.8	20.7	20.9
	3	22.5	21.8	21.7	21.9
	4	21.5	20.7	20.7	20.9
	5	23.5	22.7	22.6	22.9
HSDPA	1	23.5	22.7	22.7	22.8
	2	23.5	22.6	22.7	22.8
	3	23.5	22.1	22.2	22.3
	4	23.5	22.2	22.2	22.3
DC-HSDPA	1	23.5	22.5	22.6	22.7
	2	23.5	22.5	22.5	22.6
	3	23.5	22.0	22.1	22.1
	4	23.5	22.1	22.1	22.2

Hotspot on					
Item	band	FDD Band 2 result			
	ARFCN	Tune up	9538 (1907.6MHz)	9400 (1880MHz)	9262 (1852.4MHz)
WCDMA	\	19.5	18.5	18.6	18.7
HSUPA	1	18.5	17.6	17.6	17.6
	2	16.5	15.7	15.6	15.7
	3	17.5	16.6	16.5	16.7
	4	16.5	15.6	15.5	15.6
	5	18.5	17.6	17.7	17.9
HSDPA	1	18.5	17.5	17.5	17.8
	2	18.5	17.5	17.5	17.8
	3	18.5	17.0	17.0	17.2
	4	18.5	17.0	17.0	17.2
DC-HSDPA	1	18.5	17.4	17.4	17.6
	2	18.5	17.3	17.4	17.6
	3	18.5	16.9	17.0	17.1
	4	18.5	17.0	16.9	17.1
Item	band	FDD Band 4 result			
	ARFCN	Tune up	1513 (1752.6MHz)	1413 (1732.6MHz)	1312 (1712.4MHz)
WCDMA	\	20.5	19.6	19.6	19.7
HSUPA	1	19.5	18.6	18.6	18.6
	2	17.5	16.6	16.6	16.7
	3	18.5	17.6	17.5	17.8
	4	17.5	16.6	16.5	16.8
	5	19.5	18.8	18.6	18.7
HSDPA	1	19.5	18.6	18.6	18.7
	2	19.5	18.6	18.5	18.7
	3	19.5	18.1	18.0	18.2
	4	19.5	18.1	18.0	18.2
DC-HSDPA	1	19.5	18.5	18.2	18.6
	2	19.5	18.5	18.4	18.6
	3	19.5	18.0	17.9	18.1
	4	19.5	18.0	18.0	18.1

11.4 LTE Measurement result

Table 11.5: The conducted Power for LTE
<Full Power>

LTE-FDD Band 2				Actual output Power (dBm)			Tune up
Band-width	RB allocation	RB offset	Modulation	High	Middle	Low	
1.4 MHz				1909.3MHz	1880MHz	1850.7MHz	
	1RB	High	QPSK	22.39	22.21	22.37	23.5
			16QAM	21.73	21.48	21.73	22.5
		Middle	QPSK	22.52	22.24	22.36	23.5
			16QAM	21.77	21.58	21.76	22.5
		Low	QPSK	22.38	22.31	22.35	23.5
			16QAM	21.75	21.57	21.74	22.5
	3RB	High	QPSK	22.30	22.28	22.35	23.5
			16QAM	21.37	21.25	21.32	22.5
		Middle	QPSK	22.38	22.32	22.41	23.5
			16QAM	21.44	21.36	21.42	22.5
		Low	QPSK	22.36	22.29	22.34	23.5
			16QAM	21.37	21.29	21.36	22.5
	6RB	/	QPSK	21.44	21.27	21.35	22.5
16QAM			20.41	20.33	20.42	21.5	
3 MHz				1908.5MHz	1880MHz	1851.5MHz	/
	1RB	High	QPSK	22.39	22.21	22.38	23.5
			16QAM	21.73	21.54	21.70	22.5
		Middle	QPSK	22.46	22.31	22.37	23.5
			16QAM	21.93	21.76	21.85	22.5
		Low	QPSK	22.42	22.28	22.37	23.5
			16QAM	21.74	21.64	21.76	22.5
	8RB	High	QPSK	21.39	21.26	21.38	22.5
			16QAM	20.43	20.31	20.45	21.5
		Middle	QPSK	21.40	21.33	21.45	22.5
			16QAM	20.47	20.38	20.50	21.5
		Low	QPSK	21.40	21.37	21.40	22.5
			16QAM	20.45	20.43	20.46	21.5
	15RB	/	QPSK	21.39	21.27	21.41	22.5
16QAM			20.41	20.36	20.43	21.5	

<Full Power>

LTE-FDD Band 2				Actual output Power (dBm)			Tune up
Band-width	RB allocation	RB offset	Modulation	High	Middle	Low	
5 MHz				1907.5MHz	1880MHz	1852.5MHz	
	1RB	High	QPSK	22.47	22.29	22.35	23.5
			16QAM	21.73	21.58	21.62	22.5
		Middle	QPSK	22.42	22.26	22.32	23.5
			16QAM	21.79	21.61	21.68	22.5
		Low	QPSK	22.51	22.39	22.51	23.5
			16QAM	21.66	21.64	21.81	22.5
	12RB	High	QPSK	21.44	21.32	21.44	22.5
			16QAM	20.45	20.32	20.47	21.5
		Middle	QPSK	21.42	21.32	21.41	22.5
			16QAM	20.47	20.37	20.43	21.5
		Low	QPSK	21.53	21.34	21.45	22.5
			16QAM	20.55	20.36	20.52	21.5
	25RB	/	QPSK	21.41	21.28	21.43	22.5
16QAM			20.44	20.37	20.43	21.5	
10 MHz				1905MHz	1880MHz	1855MHz	/
	1RB	High	QPSK	22.59	22.38	22.52	23.5
			16QAM	21.75	21.63	21.75	22.5
		Middle	QPSK	22.22	22.30	22.44	23.5
			16QAM	21.66	21.58	21.70	22.5
		Low	QPSK	22.59	22.38	22.49	23.5
			16QAM	21.89	21.56	21.74	22.5
	25RB	High	QPSK	21.39	21.23	21.40	22.5
			16QAM	20.42	20.27	20.44	21.5
		Middle	QPSK	21.28	21.28	21.39	22.5
			16QAM	20.31	20.33	20.43	21.5
		Low	QPSK	21.34	21.29	21.52	22.5
			16QAM	20.29	20.27	20.40	21.5
	50RB	/	QPSK	21.45	21.27	21.39	22.5
16QAM			20.40	20.24	20.44	21.5	

<Full Power>

LTE-FDD Band 2				Actual output Power (dBm)			Tune up
Band-width	RB allocation	RB offset	Modulation	High	Middle	Low	
15 MHz				1902.5MHz	1880MHz	1857.5MHz	
	1RB	High	QPSK	22.54	22.47	22.44	23.5
			16QAM	21.76	21.78	21.63	22.5
		Middle	QPSK	22.42	22.23	22.34	23.5
			16QAM	21.68	21.47	21.56	22.5
		Low	QPSK	22.59	22.40	22.55	23.5
			16QAM	21.80	21.63	21.81	22.5
	36RB	High	QPSK	21.40	21.21	21.25	22.5
			16QAM	20.33	20.21	20.30	21.5
		Middle	QPSK	21.38	21.28	21.45	22.5
			16QAM	20.40	20.29	20.47	21.5
		Low	QPSK	21.45	21.26	21.45	22.5
			16QAM	20.43	20.25	20.45	21.5
	75RB	/	QPSK	21.28	21.27	21.37	22.5
16QAM			20.35	20.35	20.46	21.5	
20 MHz				1900MHz	1880MHz	1860MHz	/
	1RB	High	QPSK	22.13	22.03	22.06	23.5
			16QAM	21.32	21.27	21.31	22.5
		Middle	QPSK	22.44	22.23	22.27	23.5
			16QAM	21.66	21.48	21.46	22.5
		Low	QPSK	22.40	22.24	22.45	23.5
			16QAM	21.70	21.46	21.67	22.5
	50RB	High	QPSK	21.27	21.26	21.23	22.5
			16QAM	20.29	20.27	20.26	21.5
		Middle	QPSK	21.36	21.29	21.46	22.5
			16QAM	20.40	20.36	20.52	21.5
		Low	QPSK	21.38	21.35	21.41	22.5
			16QAM	20.45	20.38	20.46	21.5
	100RB	/	QPSK	21.37	21.37	21.38	22.5
16QAM			20.29	20.24	20.39	21.5	

<Full Power>

LTE-FDD Band 4				Actual output Power (dBm)			Tune up
Band-width	RB allocation	RB offset	Modulation	High	Middle	Low	
1.4 MHz				1754.3MHz	1732.5MHz	1710.7MHz	
	1RB	High	QPSK	23.35	23.11	23.09	25
			16QAM	22.66	22.33	22.34	24
		Middle	QPSK	23.53	23.22	23.13	25
			16QAM	22.71	22.48	22.42	24
		Low	QPSK	23.42	23.13	23.15	25
			16QAM	22.72	22.45	22.37	24
	3RB	High	QPSK	23.34	23.28	23.23	25
			16QAM	22.48	22.51	22.39	24
		Middle	QPSK	23.37	23.36	23.39	25
			16QAM	22.62	22.62	22.59	24
		Low	QPSK	23.36	23.27	23.28	25
			16QAM	22.50	22.55	22.48	24
	6RB	/	QPSK	22.38	22.30	22.28	24
16QAM			21.37	21.30	21.34	23	
3 MHz				1753.5MHz	1732.5MHz	1711.5MHz	/
	1RB	High	QPSK	23.35	23.14	23.06	25
			16QAM	22.68	22.27	22.38	24
		Middle	QPSK	23.66	23.32	23.29	25
			16QAM	22.59	22.42	22.28	24
		Low	QPSK	23.49	23.19	23.23	25
			16QAM	22.70	22.40	22.54	24
	8RB	High	QPSK	22.38	22.31	22.31	24
			16QAM	21.57	21.49	21.54	23
		Middle	QPSK	22.44	22.37	22.32	24
			16QAM	21.55	21.50	21.49	23
		Low	QPSK	22.39	22.41	22.31	24
			16QAM	21.53	21.55	21.46	23
	15RB	/	QPSK	22.43	22.33	22.29	24
16QAM			21.46	21.32	21.29	23	

<Full Power>

LTE-FDD Band 4				Actual output Power (dBm)			Tune up
Band-width	RB allocation	RB offset	Modulation	High	Middle	Low	
5 MHz				1752.5MHz	1732.5MHz	1712.5MHz	
	1RB	High	QPSK	23.46	23.34	23.20	25
			16QAM	22.68	22.63	22.43	24
		Middle	QPSK	23.66	23.28	23.10	25
			16QAM	22.64	22.45	22.27	24
		Low	QPSK	23.61	23.44	23.39	25
			16QAM	22.76	22.79	22.71	24
	12RB	High	QPSK	22.48	22.36	22.35	24
			16QAM	21.50	21.41	21.41	23
		Middle	QPSK	22.47	22.41	22.31	24
			16QAM	21.49	21.47	21.39	23
		Low	QPSK	22.54	22.41	22.40	24
			16QAM	21.58	21.50	21.45	23
	25RB	/	QPSK	22.39	22.41	22.34	24
16QAM			21.35	21.37	21.25	23	
10 MHz				1750MHz	1732.5MHz	1715MHz	/
	1RB	High	QPSK	23.15	23.06	23.04	25
			16QAM	22.42	22.52	22.30	24
		Middle	QPSK	23.26	23.30	23.23	25
			16QAM	22.74	22.76	22.70	24
		Low	QPSK	23.29	23.28	23.27	25
			16QAM	22.83	22.78	22.74	24
	25RB	High	QPSK	22.26	22.26	22.12	24
			16QAM	21.23	21.26	21.09	23
		Middle	QPSK	22.36	22.40	22.30	24
			16QAM	21.28	21.32	21.23	23
		Low	QPSK	22.32	22.42	22.39	24
			16QAM	21.26	21.39	21.27	23
	50RB	/	QPSK	22.32	22.36	22.26	24
16QAM			21.32	21.31	21.24	23	

<Full Power>

LTE-FDD Band 4				Actual output Power (dBm)			Tune up
Band-width	RB allocation	RB offset	Modulation	High	Middle	Low	
15 MHz				1747.5MHz	1732.5MHz	1717.5MHz	
	1RB	High	QPSK	24.02	23.81	23.79	25
			16QAM	23.28	23.46	23.25	24
		Middle	QPSK	23.86	23.36	23.34	25
			16QAM	23.06	23.00	22.94	24
		Low	QPSK	24.70	24.20	24.11	25
			16QAM	23.87	23.71	23.70	24
	36RB	High	QPSK	22.62	22.42	22.49	24
			16QAM	21.59	21.48	21.51	23
		Middle	QPSK	22.55	22.53	22.56	24
			16QAM	21.60	21.60	21.56	23
		Low	QPSK	22.83	22.79	22.74	24
			16QAM	21.90	21.82	21.78	23
	75RB	/	QPSK	22.71	22.61	22.66	24
16QAM			21.76	21.66	21.70	23	
20 MHz				1745MHz	1732.5MHz	1720MHz	/
	1RB	High	QPSK	23.75	23.77	23.90	25
			16QAM	23.08	22.91	23.22	24
		Middle	QPSK	23.32	23.25	23.28	25
			16QAM	22.73	22.67	22.69	24
		Low	QPSK	24.62	24.53	24.39	25
			16QAM	23.81	23.86	23.81	24
	50RB	High	QPSK	22.40	22.42	22.54	24
			16QAM	21.36	21.37	21.48	23
		Middle	QPSK	22.35	22.42	22.43	24
			16QAM	21.27	21.39	21.36	23
		Low	QPSK	22.70	22.74	22.76	24
			16QAM	21.64	21.70	21.68	23
	100RB	/	QPSK	22.63	22.69	22.65	24
16QAM			21.54	21.56	21.63	23	

<Full Power> / < Hotspot on >

LTE-FDD Band 5				Actual output Power (dBm)			Tune up
Band-width	RB allocation	RB offset	Modulation	High	Middle	Low	
1.4 MHz				848.3MHz	836.5MHz	824.7MHz	
	1RB	High	QPSK	23.10	23.23	22.87	24
			16QAM	22.86	22.79	22.31	23
		Middle	QPSK	23.20	23.32	22.94	24
			16QAM	22.93	22.89	22.30	23
		Low	QPSK	23.11	23.27	22.85	24
			16QAM	22.94	22.87	22.28	23
	3RB	High	QPSK	23.20	23.20	22.86	24
			16QAM	22.13	22.15	21.84	23
		Middle	QPSK	23.16	23.19	22.95	24
			16QAM	22.19	22.16	21.99	23
		Low	QPSK	23.13	23.16	22.95	24
			16QAM	22.12	22.14	21.99	23
	6RB	/	QPSK	22.16	22.14	21.90	23
16QAM			21.24	21.24	21.00	22	
3 MHz				847.5MHz	836.5MHz	825.5MHz	/
	1RB	High	QPSK	23.13	23.22	22.96	24
			16QAM	22.98	22.88	22.30	23
		Middle	QPSK	23.17	23.17	22.93	24
			16QAM	23.18	23.04	22.52	23
		Low	QPSK	23.18	23.23	22.90	24
			16QAM	23.06	22.85	22.37	23
	8RB	High	QPSK	22.20	22.23	21.95	23
			16QAM	21.23	21.25	21.05	22
		Middle	QPSK	22.22	22.30	21.98	23
			16QAM	21.27	21.32	21.05	22
		Low	QPSK	22.18	22.17	22.01	23
			16QAM	21.24	21.20	21.08	22
	15RB	/	QPSK	22.26	22.21	21.93	23
16QAM			21.32	21.23	20.99	22	

<Full Power> / < Hotspot on >

LTE-FDD Band 5				Actual output Power (dBm)			Tune up
Band-width	RB allocation	RB offset	Modulation	High	Middle	Low	
5 MHz				846.5MHz	836.5MHz	826.5MHz	
	1RB	High	QPSK	23.45	23.30	22.88	24
			16QAM	22.71	22.62	22.21	23
		Middle	QPSK	23.29	23.11	22.86	24
			16QAM	22.61	22.55	22.20	23
		Low	QPSK	23.46	23.27	23.07	24
			16QAM	22.75	22.59	22.35	23
	12RB	High	QPSK	22.34	22.23	21.98	23
			16QAM	21.31	21.23	20.99	22
		Middle	QPSK	22.41	22.24	21.97	23
			16QAM	21.34	21.27	20.97	22
		Low	QPSK	22.38	22.22	22.07	23
			16QAM	21.37	21.24	21.08	22
	25RB	/	QPSK	22.38	22.25	22.03	23
16QAM			21.43	21.26	20.92	22	
10 MHz				844MHz	836.5MHz	829MHz	/
	1RB	High	QPSK	23.73	23.60	23.46	24
			16QAM	22.96	22.85	22.51	23
		Middle	QPSK	23.44	23.21	22.98	24
			16QAM	22.61	22.42	22.08	23
		Low	QPSK	23.57	23.37	23.10	24
			16QAM	22.85	22.55	22.46	23
	25RB	High	QPSK	22.52	22.35	22.02	23
			16QAM	21.60	21.34	21.06	22
		Middle	QPSK	22.50	22.30	22.09	23
			16QAM	21.50	21.33	21.01	22
		Low	QPSK	22.59	22.27	22.16	23
			16QAM	21.49	21.34	21.06	22
	50RB	/	QPSK	22.58	22.34	22.02	23
16QAM			21.55	21.33	21.09	22	

<Full Power>

LTE-FDD Band 7				Actual output Power (dBm)			Tune up
Band-width	RB allocation	RB offset	Modulation	High	Middle	Low	
5 MHz				2567.4MHz	2535MHz	2502.5MHz	
	1RB	High	QPSK	23.02	22.90	23.15	24.5
			16QAM	22.23	22.19	22.43	23.5
		Middle	QPSK	22.85	22.84	23.18	24.5
			16QAM	21.98	22.11	22.44	23.5
		Low	QPSK	23.10	22.99	23.38	24.5
			16QAM	22.24	22.31	22.71	23.5
	12RB	High	QPSK	21.96	22.03	22.27	23.5
			16QAM	21.04	21.07	21.27	22.5
		Middle	QPSK	21.96	22.01	22.19	23.5
			16QAM	21.08	21.05	21.18	22.5
		Low	QPSK	21.96	22.07	22.34	23.5
			16QAM	21.07	21.12	21.38	22.5
	25RB	/	QPSK	21.97	22.02	22.34	23.5
16QAM			20.93	20.94	21.27	22.5	
10 MHz				2565MHz	2535MHz	2505MHz	/
	1RB	High	QPSK	22.51	22.55	22.70	24.5
			16QAM	21.96	21.85	21.91	23.5
		Middle	QPSK	22.79	22.87	23.11	24.5
			16QAM	22.31	22.27	22.40	23.5
		Low	QPSK	22.56	22.73	23.02	24.5
			16QAM	21.98	22.11	22.30	23.5
	25RB	High	QPSK	21.82	21.91	21.94	23.5
			16QAM	20.77	20.86	20.90	22.5
		Middle	QPSK	21.93	22.02	22.26	23.5
			16QAM	20.87	20.95	21.22	22.5
		Low	QPSK	21.84	22.11	22.32	23.5
			16QAM	20.76	20.99	21.19	22.5
	50RB	/	QPSK	21.88	21.88	22.10	23.5
16QAM			20.79	20.87	21.12	22.5	

<Full Power>

LTE-FDD Band 7				Actual output Power (dBm)			Tune up
Band-width	RB allocation	RB offset	Modulation	High	Middle	Low	
15 MHz				2562.5MHz	2535MHz	2507.5MHz	
	1RB	High	QPSK	23.40	23.17	23.38	24.5
			16QAM	22.86	22.71	22.70	23.5
		Middle	QPSK	23.09	23.00	23.25	24.5
			16QAM	22.52	22.59	22.55	23.5
		Low	QPSK	23.57	23.51	23.72	24.5
			16QAM	22.94	23.07	23.03	23.5
	36RB	High	QPSK	22.03	22.17	22.32	23.5
			16QAM	21.17	21.17	21.29	22.5
		Middle	QPSK	21.99	22.15	22.44	23.5
			16QAM	21.08	21.16	21.39	22.5
		Low	QPSK	22.27	22.36	22.65	23.5
			16QAM	21.32	21.38	21.59	22.5
	75RB	/	QPSK	22.19	22.25	22.41	23.5
16QAM			21.24	21.20	21.39	22.5	
20 MHz				2560MHz	2535MHz	2510MHz	/
	1RB	High	QPSK	23.58	23.36	23.58	24.5
			16QAM	23.10	22.88	23.02	23.5
		Middle	QPSK	22.84	22.96	23.16	24.5
			16QAM	22.45	22.61	22.49	23.5
		Low	QPSK	23.71	23.76	24.07	24.5
			16QAM	23.20	23.32	23.41	23.5
	50RB	High	QPSK	22.13	22.21	22.34	23.5
			16QAM	21.20	21.24	21.33	22.5
		Middle	QPSK	21.99	22.11	22.28	23.5
			16QAM	21.08	21.15	21.30	22.5
		Low	QPSK	22.30	22.37	22.66	23.5
			16QAM	21.33	21.38	21.60	22.5
	100RB	/	QPSK	22.32	22.30	22.48	23.5
16QAM			21.25	21.28	21.47	22.5	

<Full Power> / < Hotspot on >

LTE-FDD Band 12				Actual output Power (dBm)			Tune up
Band-width	RB allocation	RB offset	Modulation	High	Middle	Low	
1.4 MHz				715.3MHz	707.5MHz	699.7MHz	
	1RB	High	QPSK	22.94	22.72	23.01	24
			16QAM	22.24	22.00	22.33	23
		Middle	QPSK	22.92	22.78	23.02	24
			16QAM	22.24	22.07	22.37	23
		Low	QPSK	22.92	22.74	22.98	24
			16QAM	22.23	21.99	22.32	23
	3RB	High	QPSK	22.89	22.79	22.91	24
			16QAM	21.91	21.87	21.79	23
		Middle	QPSK	23.03	22.85	22.95	24
			16QAM	22.03	21.95	21.89	23
		Low	QPSK	22.97	22.83	22.95	24
			16QAM	21.90	21.89	21.90	23
	6RB	/	QPSK	21.96	21.84	21.96	23
16QAM			21.08	20.94	21.04	22	
3 MHz				714.5MHz	707.5MHz	700.5MHz	/
	1RB	High	QPSK	22.94	22.70	22.83	24
			16QAM	22.26	22.02	22.29	23
		Middle	QPSK	22.97	22.79	22.89	24
			16QAM	22.35	22.11	22.20	23
		Low	QPSK	22.81	22.76	22.83	24
			16QAM	22.25	22.08	22.31	23
	8RB	High	QPSK	21.99	21.83	21.95	23
			16QAM	21.04	20.97	20.92	22
		Middle	QPSK	22.01	21.85	21.98	23
			16QAM	21.06	20.96	20.96	22
		Low	QPSK	21.83	21.95	22.06	23
			16QAM	20.93	21.11	21.02	22
	15RB	/	QPSK	22.00	21.93	22.05	23
16QAM			21.01	20.92	21.07	22	

<Full Power> / < Hotspot on >

LTE-FDD Band 12				Actual output Power (dBm)			Tune up
Band-width	RB allocation	RB offset	Modulation	High	Middle	Low	
5 MHz				713.5MHz	707.5MHz	701.5MHz	
	1RB	High	QPSK	22.99	22.93	22.93	24
			16QAM	22.19	22.16	22.25	23
		Middle	QPSK	22.85	22.79	22.83	24
			16QAM	22.16	21.98	22.08	23
		Low	QPSK	23.00	22.82	22.83	24
			16QAM	22.18	22.14	22.15	23
	12RB	High	QPSK	22.05	21.95	22.02	23
			16QAM	21.10	20.99	21.05	22
		Middle	QPSK	22.02	21.92	21.97	23
			16QAM	21.01	20.96	20.95	22
		Low	QPSK	21.95	21.95	21.98	23
			16QAM	20.94	20.98	20.96	22
	25RB	/	QPSK	21.93	22.08	22.02	23
16QAM			21.08	20.90	21.05	22	
10 MHz				711MHz	707.5MHz	704MHz	/
	1RB	High	QPSK	22.63	22.55	22.41	24
			16QAM	21.83	21.79	21.73	23
		Middle	QPSK	22.95	22.80	22.93	24
			16QAM	22.14	22.11	22.17	23
		Low	QPSK	22.42	22.48	22.56	24
			16QAM	21.79	21.63	21.69	23
	25RB	High	QPSK	21.84	21.87	21.97	23
			16QAM	20.96	20.74	20.85	22
		Middle	QPSK	22.01	22.08	21.98	23
			16QAM	20.96	20.90	21.02	22
		Low	QPSK	21.96	21.83	21.80	23
			16QAM	20.75	20.83	20.94	22
	50RB	/	QPSK	21.90	21.77	21.91	23
16QAM			20.89	20.92	20.92	22	

<Full Power> / < Hotspot on >

LTE-FDD Band 13				Actual output Power (dBm)			Tune up
Band-width	RB allocation	RB offset	Modulation	High	Middle	Low	
5 MHz				784.5MHz	782MHz	779.5MHz	
	1RB	High	QPSK	23.17	22.82	22.93	24
			16QAM	22.27	22.10	22.17	23
		Middle	QPSK	23.18	22.84	22.87	24
			16QAM	22.37	22.15	22.25	23
		Low	QPSK	23.31	22.87	22.97	24
			16QAM	22.30	22.20	22.31	23
	12RB	High	QPSK	22.16	21.99	22.04	23
			16QAM	21.24	21.08	21.17	22
		Middle	QPSK	22.15	21.99	22.07	23
			16QAM	21.19	21.09	21.15	22
		Low	QPSK	22.18	22.01	22.08	23
			16QAM	21.23	21.12	21.20	22
	25RB	/	QPSK	22.08	22.08	22.15	23
16QAM			21.01	21.01	20.99	22	
10 MHz				782MHz	782MHz	782MHz	/
	1RB	High	QPSK	23.11	23.10	23.06	24
			16QAM	22.51	22.56	22.51	23
		Middle	QPSK	22.88	22.93	22.90	24
			16QAM	22.31	22.43	22.37	23
		Low	QPSK	23.32	23.29	23.30	24
			16QAM	22.81	22.79	22.83	23
	25RB	High	QPSK	22.05	22.05	22.06	23
			16QAM	21.11	21.07	21.10	22
		Middle	QPSK	22.12	22.11	22.10	23
			16QAM	21.07	21.06	21.06	22
		Low	QPSK	22.19	22.18	22.16	23
			16QAM	21.05	21.06	21.04	22
	50RB	/	QPSK	22.09	22.07	22.08	23
16QAM			21.12	21.15	21.16	22	

<Full Power>

LTE-FDD Band 25				Actual output Power (dBm)			Tune up
Band-width	RB allocation	RB offset	Modulation	High	Middle	Low	
1.4 MHz				1914.3MHz	1882.5MHz	1850.7MHz	
	1RB	High	QPSK	22.37	22.22	22.28	23.5
			16QAM	21.65	21.44	21.60	22.5
		Middle	QPSK	22.53	22.27	22.30	23.5
			16QAM	21.85	21.61	21.65	22.5
		Low	QPSK	22.36	22.15	22.22	23.5
			16QAM	21.76	21.35	21.62	22.5
	3RB	High	QPSK	22.29	22.36	22.33	23.5
			16QAM	21.39	21.55	21.42	22.5
		Middle	QPSK	22.35	22.45	22.43	23.5
			16QAM	21.47	21.56	21.50	22.5
		Low	QPSK	22.27	22.34	22.33	23.5
			16QAM	21.39	21.50	21.45	22.5
	6RB	/	QPSK	21.40	21.37	21.35	22.5
16QAM			20.32	20.39	20.45	21.5	
3 MHz				1913.5MHz	1882.5MHz	1851.5MHz	/
	1RB	High	QPSK	22.36	22.22	22.28	23.5
			16QAM	21.66	21.46	21.60	22.5
		Middle	QPSK	22.44	22.39	22.46	23.5
			16QAM	21.79	21.78	21.72	22.5
		Low	QPSK	22.42	22.22	22.33	23.5
			16QAM	21.81	21.55	21.65	22.5
	8RB	High	QPSK	21.31	21.35	21.42	22.5
			16QAM	20.51	20.53	20.54	21.5
		Middle	QPSK	21.35	21.44	21.43	22.5
			16QAM	20.51	20.56	20.51	21.5
		Low	QPSK	21.27	21.31	21.42	22.5
			16QAM	20.54	20.48	20.56	21.5
	15RB	/	QPSK	21.36	21.43	21.45	22.5
16QAM			20.35	20.39	20.43	21.5	

<Full Power>

LTE-FDD Band 25				Actual output Power (dBm)			Tune up
Band-width	RB allocation	RB offset	Modulation	High	Middle	Low	
5 MHz				1912.5MHz	1882.5MHz	1852.5MHz	
	1RB	High	QPSK	22.34	22.34	22.41	23.5
			16QAM	21.53	21.61	21.69	22.5
		Middle	QPSK	22.61	22.29	22.38	23.5
			16QAM	21.74	21.64	21.79	22.5
		Low	QPSK	22.54	22.45	22.46	23.5
			16QAM	21.83	21.73	21.78	22.5
	12RB	High	QPSK	21.41	21.39	21.42	22.5
			16QAM	20.50	20.42	20.47	21.5
		Middle	QPSK	21.43	21.47	21.48	22.5
			16QAM	20.45	20.53	20.47	21.5
		Low	QPSK	21.42	21.41	21.51	22.5
			16QAM	20.50	20.51	20.51	21.5
	25RB	/	QPSK	21.37	21.44	21.50	22.5
16QAM			20.40	20.41	20.41	21.5	
10 MHz				1910MHz	1882.5MHz	1855MHz	/
	1RB	High	QPSK	22.10	22.61	22.63	23.5
			16QAM	21.31	21.98	21.91	22.5
		Middle	QPSK	22.27	22.40	22.38	23.5
			16QAM	21.74	21.79	21.80	22.5
		Low	QPSK	22.58	22.54	22.59	23.5
			16QAM	21.93	21.91	21.89	22.5
	25RB	High	QPSK	21.38	21.37	21.43	22.5
			16QAM	20.47	20.42	20.46	21.5
		Middle	QPSK	21.34	21.41	21.47	22.5
			16QAM	20.38	20.47	20.43	21.5
		Low	QPSK	21.35	21.40	21.59	22.5
			16QAM	20.37	20.38	20.43	21.5
	50RB	/	QPSK	21.43	21.46	21.43	22.5
16QAM			20.38	20.43	20.46	21.5	

<Full Power>

LTE-FDD Band 25				Actual output Power (dBm)			Tune up
Band-width	RB allocation	RB offset	Modulation	High	Middle	Low	
15 MHz				1907.5MHz	1882.5MHz	1857.5MHz	
	1RB	High	QPSK	22.29	22.34	22.39	23.5
			16QAM	21.65	21.85	21.74	22.5
		Middle	QPSK	22.05	22.39	22.33	23.5
			16QAM	21.74	21.85	21.79	22.5
		Low	QPSK	22.15	22.38	22.42	23.5
			16QAM	22.00	21.83	21.80	22.5
	36RB	High	QPSK	21.46	21.44	21.50	22.5
			16QAM	20.51	20.49	20.50	21.5
		Middle	QPSK	21.42	21.46	21.46	22.5
			16QAM	20.40	20.51	20.51	21.5
		Low	QPSK	21.35	21.41	21.48	22.5
			16QAM	20.38	20.41	20.49	21.5
	75RB	/	QPSK	21.51	21.45	21.48	22.5
16QAM			20.52	20.53	20.55	21.5	
20 MHz				1905MHz	1882.5MHz	1860MHz	/
	1RB	High	QPSK	22.03	22.08	22.14	23.5
			16QAM	21.52	21.56	21.55	22.5
		Middle	QPSK	22.34	22.39	22.37	23.5
			16QAM	21.87	21.86	21.67	22.5
		Low	QPSK	22.43	22.43	22.41	23.5
			16QAM	21.99	21.86	21.88	22.5
	50RB	High	QPSK	21.41	21.42	21.33	22.5
			16QAM	20.38	20.35	20.38	21.5
		Middle	QPSK	21.39	21.43	21.39	22.5
			16QAM	20.39	20.44	20.44	21.5
		Low	QPSK	21.42	21.40	21.46	22.5
			16QAM	20.38	20.43	20.45	21.5
	100RB	/	QPSK	21.57	21.48	21.43	22.5
16QAM			20.39	20.37	20.36	21.5	

<Full Power> / < Hotspot on >

LTE-FDD Band 26				Actual output Power (dBm)			Tune up
Band-width	RB allocation	RB offset	Modulation	High	Middle	Low	
1.4 MHz				848.3MHz	831.5MHz	814.7MHz	
	1RB	High	QPSK	23.48	23.03	22.83	24
			16QAM	23.30	22.45	22.22	23
		Middle	QPSK	23.55	23.14	22.92	24
			16QAM	23.32	22.62	22.32	23
		Low	QPSK	23.42	23.03	22.73	24
			16QAM	23.26	22.47	22.10	23
	3RB	High	QPSK	23.47	23.02	22.82	24
			16QAM	22.37	21.94	21.84	23
		Middle	QPSK	23.46	23.05	22.92	24
			16QAM	22.39	22.02	21.97	23
		Low	QPSK	23.41	22.91	22.86	24
			16QAM	22.34	21.95	21.90	23
	6RB	/	QPSK	22.45	22.07	21.79	23
16QAM			21.44	21.18	20.96	22	
3 MHz				847.5MHz	831.5MHz	815.5MHz	/
	1RB	High	QPSK	23.35	23.06	23.27	24
			16QAM	23.28	22.64	22.65	23
		Middle	QPSK	23.20	23.08	23.33	24
			16QAM	23.38	22.85	22.75	23
		Low	QPSK	23.25	23.09	23.30	24
			16QAM	23.12	22.55	22.74	23
	8RB	High	QPSK	22.42	21.98	22.32	23
			16QAM	21.47	21.02	21.41	22
		Middle	QPSK	22.45	22.05	22.32	23
			16QAM	21.46	21.12	21.41	22
		Low	QPSK	22.33	22.03	22.33	23
			16QAM	21.42	21.07	21.48	22
	15RB	/	QPSK	22.44	21.95	22.34	23
16QAM			21.46	21.02	21.33	22	

<Full Power> / < Hotspot on >

LTE-FDD Band 26				Actual output Power (dBm)			Tune up
Band-width	RB allocation	RB offset	Modulation	High	Middle	Low	
5 MHz				846.5MHz	831.5MHz	816.5MHz	
	1RB	High	QPSK	23.64	23.10	23.07	24
			16QAM	22.91	22.38	22.42	23
		Middle	QPSK	23.20	23.06	22.87	24
			16QAM	22.71	22.31	22.30	23
		Low	QPSK	23.49	23.01	22.96	24
			16QAM	22.87	22.24	22.23	23
	12RB	High	QPSK	22.49	22.06	21.87	23
			16QAM	21.44	21.10	20.89	22
		Middle	QPSK	22.44	21.99	21.84	23
			16QAM	21.40	21.03	20.85	22
		Low	QPSK	22.45	22.02	21.92	23
			16QAM	21.41	21.00	20.97	22
	25RB	/	QPSK	22.42	22.06	21.89	23
16QAM			21.47	21.09	20.95	22	
10 MHz				844MHz	831.5MHz	820MHz	/
	1RB	High	QPSK	23.80	23.48	23.27	24
			16QAM	22.98	22.65	22.51	23
		Middle	QPSK	23.74	23.21	22.99	24
			16QAM	22.69	22.28	22.10	23
		Low	QPSK	24.00	23.19	23.06	24
			16QAM	22.92	22.41	22.24	23
	25RB	High	QPSK	22.59	22.13	22.09	23
			16QAM	21.64	21.22	21.09	22
		Middle	QPSK	22.58	22.10	21.97	23
			16QAM	21.54	21.13	21.02	22
		Low	QPSK	22.53	22.17	21.93	23
			16QAM	21.41	21.08	21.09	22
	50RB	/	QPSK	22.64	22.15	22.12	23
16QAM			21.61	21.19	21.12	22	

<Full Power> / < Hotspot on >

LTE-FDD Band 26				Actual output Power (dBm)			Tune up
Band-width	RB allocation	RB offset	Modulation	High	Middle	Low	
15 MHz				841.5MHz	831.5MHz	822.5MHz	
	1RB	High	QPSK	23.86	23.67	23.48	24
			16QAM	23.11	22.83	22.63	23
		Middle	QPSK	23.44	23.19	22.81	24
			16QAM	22.71	22.28	22.00	23
		Low	QPSK	23.69	23.32	23.03	24
			16QAM	22.72	22.59	22.18	23
	36RB	High	QPSK	22.38	22.12	21.88	23
			16QAM	21.36	21.11	20.84	22
		Middle	QPSK	22.59	22.34	21.90	23
			16QAM	21.56	21.36	20.92	22
		Low	QPSK	22.79	22.58	22.33	23
			16QAM	21.79	21.56	21.15	22
	75RB	/	QPSK	22.67	22.28	21.97	23
16QAM			21.68	21.33	20.94	22	

<Full Power>

LTE-TDD Band 41 PC3				Actual output Power (dBm)			Tune up
Band-width	RB allocation	RB offset	Modulation	High	Middle	Low	
5 MHz				2687.5MHz	2593MHz	2498.5MHz	
	1RB	High	QPSK	23.04	22.93	23.28	23.5
			16QAM	22.15	22.12	22.14	22.5
		Middle	QPSK	23.01	22.97	23.22	23.5
			16QAM	22.19	22.20	22.57	22.5
		Low	QPSK	23.12	23.09	23.36	23.5
			16QAM	22.14	22.15	22.25	22.5
	12RB	High	QPSK	22.06	22.02	22.19	22.5
			16QAM	21.08	21.12	21.30	21.5
		Middle	QPSK	22.08	22.06	22.16	22.5
			16QAM	21.13	21.17	21.28	21.5
		Low	QPSK	22.12	22.11	22.22	22.5
			16QAM	21.11	21.20	21.30	21.5
	25RB	/	QPSK	22.09	22.02	22.14	22.5
16QAM			21.15	21.17	21.23	21.5	
10 MHz				2685MHz	2593MHz	2501MHz	/
	1RB	High	QPSK	23.12	22.93	23.23	23.5
			16QAM	22.07	22.12	22.14	22.5
		Middle	QPSK	22.97	22.98	23.28	23.5
			16QAM	22.11	22.03	22.25	22.5
		Low	QPSK	22.93	22.95	23.40	23.5
			16QAM	21.97	22.03	22.25	22.5
	25RB	High	QPSK	22.04	22.00	22.07	22.5
			16QAM	21.08	21.13	21.18	21.5
		Middle	QPSK	22.05	22.03	22.24	22.5
			16QAM	21.22	21.22	21.31	21.5
		Low	QPSK	22.06	22.03	22.25	22.5
			16QAM	21.15	21.19	21.31	21.5
	50RB	/	QPSK	22.12	22.02	22.16	22.5
16QAM			21.17	21.19	21.20	21.5	

<Full Power>

LTE-TDD Band 41 PC3				Actual output Power (dBm)			Tune up
Band-width	RB allocation	RB offset	Modulation	High	Middle	Low	
15 MHz				2682.5MHz	2593MHz	2503.5MHz	
	1RB	High	QPSK	22.34	22.25	22.33	23.5
			16QAM	21.37	21.31	21.24	22.5
		Middle	QPSK	22.74	22.75	22.70	23.5
			16QAM	21.85	21.89	21.75	22.5
		Low	QPSK	22.21	22.09	22.61	23.5
			16QAM	21.24	21.18	21.59	22.5
	36RB	High	QPSK	22.03	22.00	22.09	22.5
			16QAM	21.06	21.00	21.11	21.5
		Middle	QPSK	21.94	21.94	21.99	22.5
			16QAM	20.95	20.92	20.99	21.5
		Low	QPSK	21.74	21.80	22.04	22.5
			16QAM	20.76	20.81	21.08	21.5
	75RB	/	QPSK	21.86	21.84	21.97	22.5
16QAM			20.95	20.95	21.05	21.5	
20 MHz				2680MHz	2593MHz	2506MHz	/
	1RB	High	QPSK	22.40	22.37	22.45	23.5
			16QAM	21.44	21.41	21.42	22.5
		Middle	QPSK	22.89	22.86	22.84	23.5
			16QAM	21.93	21.93	22.01	22.5
		Low	QPSK	22.60	22.58	22.83	23.5
			16QAM	21.64	21.61	21.88	22.5
	50RB	High	QPSK	21.82	21.86	21.84	22.5
			16QAM	20.95	20.86	20.96	21.5
		Middle	QPSK	21.90	21.94	21.99	22.5
			16QAM	20.96	21.00	21.11	21.5
		Low	QPSK	21.88	21.90	22.00	22.5
			16QAM	20.95	20.89	21.08	21.5
	100RB	/	QPSK	21.84	21.88	21.94	22.5
16QAM			20.87	20.90	20.94	21.5	

<Full Power>

LTE-TDD Band 41 PC3				Actual output Power (dBm)			Tune up
Band-width	RB allocation	RB offset	Modulation	High-2	/	Low-2	
5 MHz				2640.3MHz	/	2545.8MHz	
	1RB	High	QPSK	22.81	/	22.40	23.5
			16QAM	21.54	/	21.47	22.5
		Middle	QPSK	22.92	/	22.99	23.5
			16QAM	21.86	/	22.02	22.5
		Low	QPSK	22.64	/	22.80	23.5
			16QAM	21.88	/	21.86	22.5
	12RB	High	QPSK	22.19	/	21.76	22.5
			16QAM	21.12	/	20.80	21.5
		Middle	QPSK	22.15	/	22.03	22.5
			16QAM	21.17	/	21.11	21.5
		Low	QPSK	22.14	/	21.95	22.5
			16QAM	21.18	/	20.97	21.5
	25RB	/	QPSK	22.13	/	21.90	22.5
16QAM			21.14	/	20.97	21.5	
10 MHz				2639MHz	/	2547MHz	/
	1RB	High	QPSK	22.86	/	22.34	23.5
			16QAM	21.59	/	21.41	22.5
		Middle	QPSK	22.97	/	22.93	23.5
			16QAM	21.91	/	21.96	22.5
		Low	QPSK	22.69	/	22.74	23.5
			16QAM	21.93	/	21.80	22.5
	25RB	High	QPSK	22.24	/	21.70	22.5
			16QAM	21.17	/	20.74	21.5
		Middle	QPSK	22.20	/	21.97	22.5
			16QAM	21.22	/	21.05	21.5
		Low	QPSK	22.19	/	21.89	22.5
			16QAM	21.23	/	20.91	21.5
	50RB	/	QPSK	22.18	/	21.84	22.5
16QAM			21.19	/	20.91	21.5	

<Full Power>

LTE-TDD Band 41 PC3				Actual output Power (dBm)			Tune up
Band-width	RB allocation	RB offset	Modulation	High-2	/	Low-2	
15 MHz				2637.8MHz	/	2548.3MHz	
	1RB	High	QPSK	22.83	/	22.32	23.5
			16QAM	21.56	/	21.39	22.5
		Middle	QPSK	22.94	/	22.91	23.5
			16QAM	21.88	/	21.94	22.5
		Low	QPSK	22.66	/	22.72	23.5
			16QAM	21.90	/	21.78	22.5
	36RB	High	QPSK	22.21	/	21.68	22.5
			16QAM	21.14	/	20.72	21.5
		Middle	QPSK	22.17	/	21.95	22.5
			16QAM	21.19	/	21.03	21.5
		Low	QPSK	22.16	/	21.87	22.5
			16QAM	21.20	/	20.89	21.5
	75RB	/	QPSK	22.15	/	21.82	22.5
16QAM			21.16	/	20.89	21.5	
20 MHz				2636.5MHz	/	2549.5MHz	/
	1RB	High	QPSK	22.88	/	22.38	23.5
			16QAM	21.61	/	21.45	22.5
		Middle	QPSK	22.96	/	22.97	23.5
			16QAM	21.93	/	21.81	22.5
		Low	QPSK	22.71	/	22.78	23.5
			16QAM	21.95	/	21.84	22.5
	50RB	High	QPSK	22.26	/	21.74	22.5
			16QAM	21.19	/	20.98	21.5
		Middle	QPSK	22.22	/	22.01	22.5
			16QAM	21.24	/	21.09	21.5
		Low	QPSK	22.21	/	21.93	22.5
			16QAM	21.25	/	20.95	21.5
	100RB	/	QPSK	22.20	/	21.88	22.5
16QAM			21.21	/	20.95	21.5	

<Full Power>

LTE-TDD Band 41 PC2				Actual output Power (dBm)			Tune up
Band-width	RB allocation	RB offset	Modulation	High	Middle	Low	
5 MHz				2687.5MHz	2593MHz	2498.5MHz	
	1RB	High	QPSK	25.58	25.40	25.43	26.5
			16QAM	24.86	24.68	24.88	25.5
		Middle	QPSK	25.53	25.41	25.60	26.5
			16QAM	24.96	24.73	24.98	25.5
		Low	QPSK	25.65	25.53	25.58	26.5
			16QAM	24.98	24.78	24.96	25.5
	12RB	High	QPSK	24.73	24.65	24.71	25.5
			16QAM	23.82	23.72	23.88	24.5
		Middle	QPSK	24.81	24.65	24.73	25.5
			16QAM	23.87	23.77	23.98	24.5
		Low	QPSK	24.78	24.72	24.81	25.5
			16QAM	23.86	23.76	23.99	24.5
	25RB	/	QPSK	24.79	24.69	24.72	25.5
			16QAM	23.86	23.74	23.79	24.5
	10 MHz				2685MHz	2593MHz	2501MHz
1RB		High	QPSK	25.50	25.43	25.47	26.5
			16QAM	24.83	24.72	24.86	25.5
		Middle	QPSK	25.58	25.42	25.53	26.5
			16QAM	24.86	24.68	24.82	25.5
		Low	QPSK	25.45	25.34	25.55	26.5
			16QAM	24.80	24.64	24.91	25.5
25RB		High	QPSK	24.79	24.66	24.71	25.5
			16QAM	23.85	23.72	23.85	24.5
		Middle	QPSK	24.90	24.71	24.73	25.5
			16QAM	23.91	23.79	23.82	24.5
		Low	QPSK	24.79	24.64	24.75	25.5
			16QAM	23.88	23.67	23.78	24.5
50RB		/	QPSK	24.82	24.67	24.69	25.5
			16QAM	23.89	23.67	23.78	24.5

<Full Power>

LTE-TDD Band 41 PC2				Actual output Power (dBm)			Tune up
Band-width	RB allocation	RB offset	Modulation	High	Middle	Low	
15 MHz				2682.5MHz	2593MHz	2503.5MHz	
	1RB	High	QPSK	24.96	24.89	24.77	26.5
			16QAM	24.29	24.26	24.04	25.5
		Middle	QPSK	25.40	25.38	25.39	26.5
			16QAM	24.78	24.75	24.66	25.5
		Low	QPSK	24.81	24.60	25.08	26.5
			16QAM	24.18	23.99	24.43	25.5
	36RB	High	QPSK	24.90	24.82	24.73	25.5
			16QAM	23.83	23.77	23.81	24.5
		Middle	QPSK	24.76	24.76	24.73	25.5
			16QAM	23.74	23.68	23.82	24.5
		Low	QPSK	24.55	24.56	24.59	25.5
			16QAM	23.51	23.51	23.72	24.5
	75RB	/	QPSK	24.67	24.68	24.70	25.5
16QAM			23.77	23.72	23.76	24.5	
20 MHz				2680MHz	2593MHz	2506MHz	/
	1RB	High	QPSK	24.97	24.94	24.90	26.5
			16QAM	24.34	24.32	24.18	25.5
		Middle	QPSK	25.41	25.44	25.27	26.5
			16QAM	24.78	24.81	24.74	25.5
		Low	QPSK	25.07	25.06	25.34	26.5
			16QAM	24.52	24.40	24.66	25.5
	50RB	High	QPSK	24.63	24.58	24.48	25.5
			16QAM	23.72	23.64	23.57	24.5
		Middle	QPSK	24.66	24.65	24.59	25.5
			16QAM	23.72	23.73	23.73	24.5
		Low	QPSK	24.60	24.59	24.52	25.5
			16QAM	23.67	23.63	23.59	24.5
	100RB	/	QPSK	24.58	24.64	24.54	25.5
16QAM			23.64	23.63	23.58	24.5	

<Full Power>

LTE-TDD Band 41 PC2				Actual output Power (dBm)			Tune up
Band-width	RB allocation	RB offset	Modulation	High-2	/	Low-2	
5 MHz				2640.3MHz	/	2545.8MHz	
	1RB	High	QPSK	25.54	/	25.40	26.5
			16QAM	24.84	/	24.82	25.5
		Middle	QPSK	25.50	/	25.62	26.5
			16QAM	24.88	/	24.92	25.5
		Low	QPSK	25.61	/	25.52	26.5
			16QAM	24.95	/	24.91	25.5
	12RB	High	QPSK	24.77	/	24.71	25.5
			16QAM	23.83	/	23.84	24.5
		Middle	QPSK	24.82	/	24.75	25.5
			16QAM	23.87	/	23.93	24.5
		Low	QPSK	24.78	/	24.84	25.5
			16QAM	23.81	/	23.91	24.5
	25RB	/	QPSK	24.77	/	24.74	25.5
16QAM			23.80	/	23.77	24.5	
10 MHz				2639MHz	/	2547MHz	/
	1RB	High	QPSK	25.48	/	25.44	26.5
			16QAM	24.84	/	24.80	25.5
		Middle	QPSK	25.52	/	25.51	26.5
			16QAM	24.81	/	24.84	25.5
		Low	QPSK	25.48	/	25.58	26.5
			16QAM	24.75	/	24.88	25.5
	25RB	High	QPSK	24.74	/	24.73	25.5
			16QAM	23.82	/	23.87	24.5
		Middle	QPSK	24.88	/	24.72	25.5
			16QAM	23.90	/	23.80	24.5
		Low	QPSK	24.76	/	24.72	25.5
			16QAM	23.85	/	23.72	24.5
	50RB	/	QPSK	24.84	/	24.66	25.5
16QAM			23.86	/	23.72	24.5	

<Full Power>

LTE-TDD Band 41 PC2				Actual output Power (dBm)			Tune up
Band-width	RB allocation	RB offset	Modulation	High-2	/	Low-2	
15 MHz				2637.8MHz	/	2548.3MHz	
	1RB	High	QPSK	25.08	/	24.82	26.5
			16QAM	24.39	/	24.11	25.5
		Middle	QPSK	25.50	/	25.44	26.5
			16QAM	24.88	/	24.75	25.5
		Low	QPSK	24.86	/	25.13	26.5
			16QAM	24.28	/	24.48	25.5
	36RB	High	QPSK	24.98	/	24.74	25.5
			16QAM	23.85	/	23.86	24.5
		Middle	QPSK	24.86	/	24.78	25.5
			16QAM	23.84	/	23.87	24.5
		Low	QPSK	24.65	/	24.66	25.5
			16QAM	23.61	/	23.77	24.5
	75RB	/	QPSK	24.76	/	24.78	25.5
16QAM			23.82	/	23.81	24.5	
20 MHz				2636.5MHz	/	2549.5MHz	/
	1RB	High	QPSK	24.93	/	24.81	26.5
			16QAM	24.30	/	24.12	25.5
		Middle	QPSK	25.32	/	25.22	26.5
			16QAM	24.71	/	24.62	25.5
		Low	QPSK	25.01	/	25.26	26.5
			16QAM	24.48	/	24.60	25.5
	50RB	High	QPSK	24.59	/	24.40	25.5
			16QAM	23.68	/	23.51	24.5
		Middle	QPSK	24.58	/	24.48	25.5
			16QAM	23.62	/	23.64	24.5
		Low	QPSK	24.56	/	24.46	25.5
			16QAM	23.63	/	23.51	24.5
	100RB	/	QPSK	24.54	/	24.48	25.5
16QAM			23.58	/	23.50	24.5	

<Full Power>

LTE-FDD Band 66				Actual output Power (dBm)			Tune up
Band-width	RB allocation	RB offset	Modulation	High	Middle	Low	
1.4 MHz				1779.3MHz	1745MHz	1710.7MHz	
	1RB	High	QPSK	24.53	24.37	24.45	25
			16QAM	23.87	23.77	23.81	24
		Middle	QPSK	24.49	24.42	24.47	25
			16QAM	23.92	23.94	23.91	24
		Low	QPSK	24.56	24.39	24.46	25
			16QAM	23.85	23.81	23.80	24
	3RB	High	QPSK	24.52	24.30	24.40	25
			16QAM	23.64	23.59	23.46	24
		Middle	QPSK	24.57	24.45	24.42	25
			16QAM	23.71	23.72	23.51	24
		Low	QPSK	24.49	24.41	24.40	25
			16QAM	23.65	23.62	23.49	24
	6RB	/	QPSK	23.42	23.35	24.38	24
16QAM			22.51	22.52	23.55	23	
3 MHz				1778.5MHz	1745MHz	1711.5MHz	/
	1RB	High	QPSK	24.38	24.39	24.46	25
			16QAM	23.81	23.85	23.76	24
		Middle	QPSK	24.29	24.01	24.28	25
			16QAM	23.76	23.77	23.49	24
		Low	QPSK	24.01	23.92	23.92	25
			16QAM	23.18	23.19	23.08	24
	8RB	High	QPSK	23.28	23.39	23.28	24
			16QAM	22.35	22.39	22.27	23
		Middle	QPSK	23.37	23.30	23.33	24
			16QAM	22.43	22.26	22.29	23
		Low	QPSK	23.31	23.34	23.19	24
			16QAM	22.35	22.28	22.17	23
	15RB	/	QPSK	23.46	23.38	23.28	24
16QAM			22.28	22.36	22.23	23	

<Full Power>

LTE-FDD Band 66				Actual output Power (dBm)			Tune up
Band-width	RB allocation	RB offset	Modulation	High	Middle	Low	
5 MHz				1777.5MHz	1745MHz	1712.5MHz	
	1RB	High	QPSK	24.43	24.35	24.54	25
			16QAM	23.86	23.81	23.84	24
		Middle	QPSK	24.34	23.97	24.36	25
			16QAM	23.81	23.73	23.57	24
		Low	QPSK	24.06	23.88	24.00	25
			16QAM	23.23	23.15	23.16	24
	12RB	High	QPSK	23.33	23.35	23.36	24
			16QAM	22.40	22.35	22.35	23
		Middle	QPSK	23.42	23.26	23.41	24
			16QAM	22.48	22.22	22.37	23
		Low	QPSK	23.36	23.30	23.27	24
			16QAM	22.40	22.24	22.25	23
	25RB	/	QPSK	23.51	23.34	23.36	24
16QAM			22.33	22.32	22.31	23	
10 MHz				1775MHz	1745MHz	1715MHz	/
	1RB	High	QPSK	24.46	24.38	24.49	25
			16QAM	23.89	23.84	23.79	24
		Middle	QPSK	24.37	24.00	24.31	25
			16QAM	23.84	23.76	23.52	24
		Low	QPSK	24.09	23.91	23.95	25
			16QAM	23.26	23.18	23.11	24
	25RB	High	QPSK	23.36	23.38	23.31	24
			16QAM	22.43	22.38	22.30	23
		Middle	QPSK	23.45	23.29	23.36	24
			16QAM	22.51	22.25	22.32	23
		Low	QPSK	23.39	23.33	23.22	24
			16QAM	22.43	22.27	22.20	23
	50RB	/	QPSK	23.54	23.37	23.31	24
16QAM			22.36	22.35	22.26	23	