



Add: No.51 Xueyuan Road, Haidian District, Beijing, 100191, China  
Tel: +86-10-62104633-2079 Fax: +86-10-62104633-2504  
E-mail: crtl@chinatcl.com http://www.chinatcl.cn

**Glossary:**

TSL	tissue simulating liquid
ConvF	sensitivity in TSL / NORM <sub>x,y,z</sub>
N/A	not applicable or not measured

**Calibration is Performed According to the Following Standards:**

- IEEE Std 1528-2013, "IEEE Recommended Practice for Determining the Peak Spatial-Averaged Specific Absorption Rate (SAR) in the Human Head from Wireless Communications Devices: Measurement Techniques", June 2013
- IEC 62209-1, "Procedure to measure the Specific Absorption Rate (SAR) For hand-held devices used in close proximity to the ear (frequency range of 300MHz to 3GHz)", February 2005
- IEC 62209-2, "Procedure to measure the Specific Absorption Rate (SAR) For wireless communication devices used in close proximity to the human body (frequency range of 30MHz to 6GHz)", March 2010
- KDB865664, SAR Measurement Requirements for 100 MHz to 6 GHz

**Additional Documentation:**

- DASY4/5 System Handbook

**Methods Applied and Interpretation of Parameters:**

- Measurement Conditions:** Further details are available from the Validation Report at the end of the certificate. All figures stated in the certificate are valid at the frequency indicated.
- Antenna Parameters with TSL:** The dipole is mounted with the spacer to position its feed point exactly below the center marking of the flat phantom section, with the arms oriented parallel to the body axis.
- Feed Point Impedance and Return Loss:** These parameters are measured with the dipole positioned under the liquid filled phantom. The impedance stated is transformed from the measurement at the SMA connector to the feed point. The Return Loss ensures low reflected power. No uncertainty required.
- Electrical Delay:** One-way delay between the SMA connector and the antenna feed point. No uncertainty required.
- SAR measured:** SAR measured at the stated antenna input power.
- SAR normalized:** SAR as measured, normalized to an input power of 1 W at the antenna connector.
- SAR for nominal TSL parameters:** The measured TSL parameters are used to calculate the nominal SAR result.

The reported uncertainty of measurement is stated as the standard uncertainty of Measurement multiplied by the coverage factor  $k=2$ , which for a normal distribution corresponds to a coverage probability of approximately 95%.



Add: No. 51 Xueyuan Road, Haidian District, Beijing, 100191, China  
Tel: +86-10-62304633-2079 Fax: +86-10-62304633-2504  
E-mail: cml@chinanet.com http://www.chinanet.cn

### Measurement Conditions

DASY system configuration, as far as not given on page 1.

DASY Version	DASY52	52.10.0.1448
Extrapolation	Advanced Extrapolation	
Phantom	Triple Flat Phantom 5.1C	
Distance Dipole Center - TSL	10 mm	with Spacer
Zoom Scan Resolution	dx, dy, dz = 5 mm	
Frequency	1800 MHz ± 1 MHz	

### Head TSL parameters

The following parameters and calculations were applied.

	Temperature	Permittivity	Conductivity
Nominal Head TSL parameters	22.0 °C	40.0	1.40 mho/m
Measured Head TSL parameters	(22.0 ± 0.2) °C	40.4 ± 6 %	1.42 mho/m ± 6 %
Head TSL temperature change during test	<1.0 °C	---	---

### SAR result with Head TSL

SAR averaged over 1 cm <sup>3</sup> (1 g) of Head TSL	Condition	
SAR measured	250 mW input power	9.79 mW / g
SAR for nominal Head TSL parameters	normalized to 1W	38.9 mW / g ± 18.8 % (k=2)
SAR averaged over 10 cm <sup>3</sup> (10 g) of Head TSL	Condition	
SAR measured	250 mW input power	5.12 mW / g
SAR for nominal Head TSL parameters	normalized to 1W	20.4 mW / g ± 18.7 % (k=2)

### Body TSL parameters

The following parameters and calculations were applied.

	Temperature	Permittivity	Conductivity
Nominal Body TSL parameters	22.0 °C	53.3	1.52 mho/m
Measured Body TSL parameters	(22.0 ± 0.2) °C	53.8 ± 6 %	1.50 mho/m ± 6 %
Body TSL temperature change during test	<1.0 °C	---	---

### SAR result with Body TSL

SAR averaged over 1 cm <sup>3</sup> (1 g) of Body TSL	Condition	
SAR measured	250 mW input power	9.84 mW / g
SAR for nominal Body TSL parameters	normalized to 1W	39.7 mW / g ± 18.8 % (k=2)
SAR averaged over 10 cm <sup>3</sup> (10 g) of Body TSL	Condition	
SAR measured	250 mW input power	5.18 mW / g
SAR for nominal Body TSL parameters	normalized to 1W	20.8 mW / g ± 18.7 % (k=2)



Add: No 51 Xueyuan Road, Haidian District, Beijing, 100191, China  
Tel: +86-10-62304633-2079 Fax: +86-10-62304633-2504  
E-mail: ctri@chinanet.com http://www.chinanet.cn

**Appendix (Additional assessments outside the scope of CNAS L0570)**

**Antenna Parameters with Head TSL**

Impedance, transformed to feed point	49.3Ω- 1.55jΩ
Return Loss	- 35.4dB

**Antenna Parameters with Body TSL**

Impedance, transformed to feed point	48.0Ω- 1.32jΩ
Return Loss	- 27.1dB

**General Antenna Parameters and Design**

Electrical Delay (one direction)	1.315 ns
----------------------------------	----------

After long term use with 100W radiated power, only a slight warming of the dipole near the feedpoint can be measured.

The dipole is made of standard semirigid coaxial cable. The center conductor of the feeding line is directly connected to the second arm of the dipole. The antenna is therefore short-circuited for DC-signals. On some of the dipoles, small end caps are added to the dipole arms in order to improve matching when loaded according to the position as explained in the "Measurement Conditions" paragraph. The SAR data are not affected by this change. The overall dipole length is still according to the Standard. No excessive force must be applied to the dipole arms, because they might bend or the soldered connections near the feedpoint may be damaged.

**Additional EUT Data**

Manufactured by	SPEAG
-----------------	-------



Add: No.51 Xueyuan Road, Haidian District, Beijing, 100191, China  
Tel: +86-10-62104633-2079 Fax: +86-10-62104633-2504  
E-mail: ct@china.ttl.com http://www.chinattl.cn

**DASY5 Validation Report for Head TSL**

Date: 09.15.2017

Test Laboratory: CTTL, Beijing, China

DUT: Dipole 1800 MHz; Type: D1800V2; Serial: D1800V2 - SN: 2d084

Communication System: UID 0, CW; Frequency: 1800 MHz; Duty Cycle: 1:1

Medium parameters used:  $f = 1800 \text{ MHz}$ ;  $\sigma = 1.423 \text{ S/m}$ ;  $\epsilon_r = 40.37$ ;  $\rho = 1000 \text{ kg/m}^3$

Phantom section: Left Section

Measurement Standard: DASY5 (IEEE/IEC/ANSI C63.19-2007)

DASY5 Configuration:

- Probe: EX3DV4 - SN7433; ConvF(7.97, 7.97, 7.97); Calibrated: 9/26/2016;
- Sensor-Surface: 1.4mm (Mechanical Surface Detection)
- Electronics: DAB4 Sn1331; Calibrated: 1/19/2017
- Phantom: Triple Flat Phantom 5.1C; Type: QD 000 P51 CA; Serial: 1161/1
- Measurement SW: DASY52, Version 52.10 (0); SEMCAD X Version 14.6.10 (7417)

**System Performance Check/Zoom Scan (7x7x7) (7x7x7)/Cube 0:** Measurement grid:

$dx=5\text{mm}$ ,  $dy=5\text{mm}$ ,  $dz=5\text{mm}$

Reference Value = 93.90 V/m; Power Drift = 0.01 dB

Peak SAR (extrapolated) = 18.7 W/kg

SAR(1 g) = 9.79 W/kg; SAR(10 g) = 5.12 W/kg

Maximum value of SAR (measured) = 15.5 W/kg

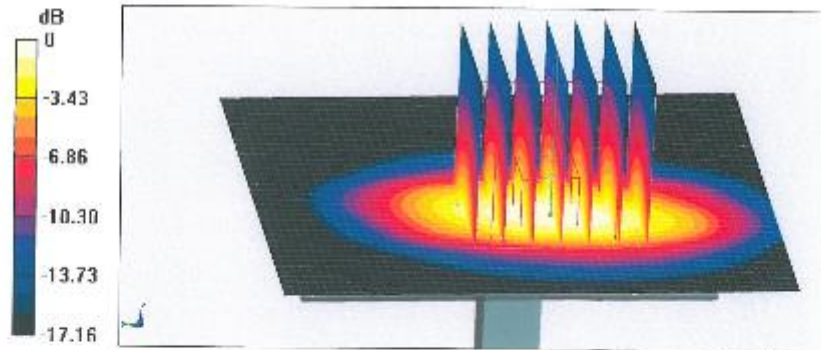

0 dB = 15.5 W/kg = 11.90 dBW/kg



Addr: No. 51 Xueyuan Road, Haidian District, Beijing, 100191, China  
Tel: +86-10-62304633-2079 Fax: +86-10-62304633-2504  
E-mail: ttl@chinart.com http://www.chinart.cn

**Impedance Measurement Plot for Head TSL**

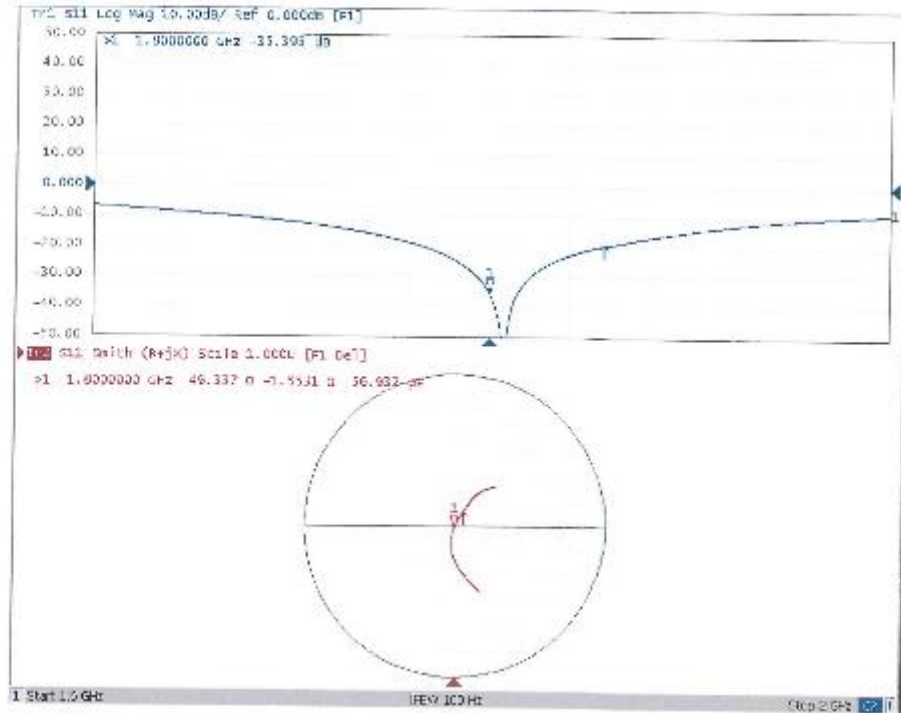



Add: No.51 Xueyuan Road, Haidian District, Beijing, 100191, China  
Tel: +86-10-62304633-2079 Fax: +86-10-62304633-2504  
E-mail: ctd@chinaatl.com http://www.chinaatl.cn

**DASY5 Validation Report for Body TSL**

Date: 09.14.2017

Test Laboratory: CTTL, Beijing, China

**DUT: Dipole 1800 MHz; Type: D1800V2; Serial: D1800V2 - SN: 2d084**

Communication System: UID 0, CW; Frequency: 1800 MHz; Duty Cycle: 1:1

Medium parameters used:  $f = 1800$  MHz;  $\sigma = 1.503$  S/m;  $\epsilon_r = 53.79$ ;  $\rho = 1000$  kg/m<sup>3</sup>

Phantom section: Center Section

Measurement Standard: DASY5 (IEFE/IEC/ANSI C63.19-2007)

DASY5 Configuration:

- Probe: EX3DV4 - SN7433; ConvF(7.75, 7.75, 7.75); Calibrated: 9/26/2016;
- Sensor-Surface: 1.4mm (Mechanical Surface Detection)
- Electronics: DAE4 Sn1331; Calibrated: 1/19/2017
- Phantom: Triple Flat Phantom S.1C; Type: QD 000 P51 CA; Serial: 1161/1
- Measurement SW: DASY52, Version 52.10 (0); SEMCAD X Version 14.6.10 (7413)

**System Performance Check/Zoom Scan (7x7x7) (7x7x7)/Cube 0: Measurement grid:**

$dx=5mm$ ,  $dy=5mm$ ,  $dz=5mm$

Reference Value = 97.57 V/m; Power Drift = -0.02 dB

Peak SAR (extrapolated) = 18.0 W/kg

SAR(1 g) = 9.84 W/kg; SAR(10 g) = 5.18 W/kg

Maximum value of SAR (measured) = 15.2 W/kg

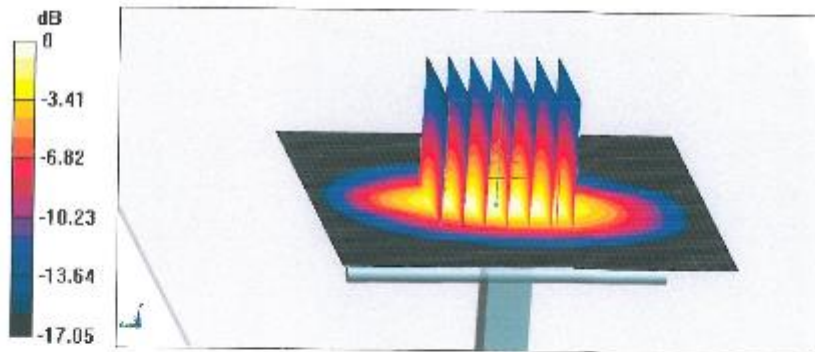

0 dB = 15.2 W/kg = 11.82 dBW/kg



Add: No. 51 Xueyuan Road, Haidian District, Beijing, 100191, China  
Tel: +86-10-62304633-2079 Fax: +86-10-62304633-2504  
E-mail: ctrl@ctmattl.com http://www.chinaetcl.com

**Impedance Measurement Plot for Body TSL**

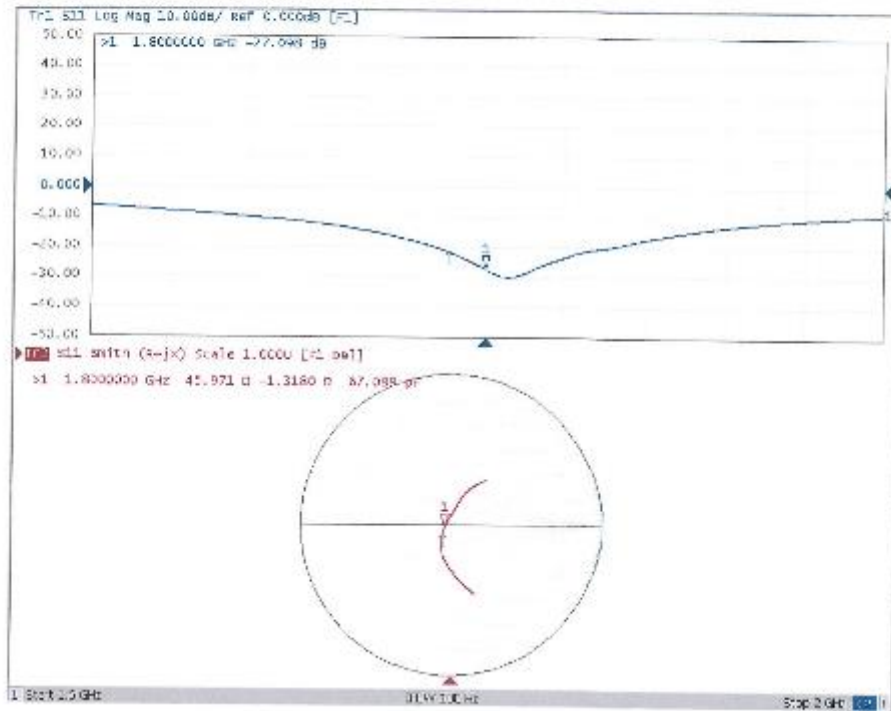

D2000V2Sn:1009



In Collaboration with  
**s p e a g**  
CALIBRATION LABORATORY



中国认可  
国际互认  
校准  
CALIBRATION  
CNAS L0570

Add: No.51 Xueyuan Road, Haidian District, Beijing, 100191, China  
Tel: +86-10-62304633-2079 Fax: +86-10-62304633-2504  
E-mail: cttj@chinattl.com http://www.chinattl.cn

Client **SRTC**

Certificate No: **Z18-97021**

CALIBRATION CERTIFICATE			
Object	D2000V2 - SN: 1009		
Calibration Procedure(s)	FF-Z11-003-01 Calibration Procedures for dipole validation kits		
Calibration date:	February 1, 2018		
<p>This calibration Certificate documents the traceability to national standards, which realize the physical units of measurements(SI). The measurements and the uncertainties with confidence probability are given on the following pages and are part of the certificate.</p> <p>All calibrations have been conducted in the closed laboratory facility: environment temperature(22±3)℃ and humidity&lt;70%.</p> <p>Calibration Equipment used (M&amp;TE critical for calibration)</p>			
Primary Standards	ID #	Cal Date(Calibrated by, Certificate No.)	Scheduled Calibration
Power Meter NRVD	102198	02-Mar-17 (CTTL, No.J17X01254)	Mar-18
Power sensor NRV-Z5	100598	02-Mar-17 (CTTL, No.J17X01254)	Mar-18
Reference Probe EX3DV4	SN 7464	12-Sep-17(SPEAG.No.EX3-7464_Sep17)	Sep-18
DAE4	SN 1525	02-Oct-17(SPEAG.No.DAE4-1525_Oct17)	Oct-18
Secondary Standards	ID #	Cal Date(Calibrated by, Certificate No.)	Scheduled Calibration
Signal Generator E4438C	MY49071430	23-Jan-18 (CTTL, No.J18X00560)	Jan-19
Network Analyzer E5071C	MY46110873	24-Jan-18 (CTTL, No.J18X00561)	Jan-19
Calibrated by:	Name Zhao Jing	Function SAR Test Engineer	Signature 
Reviewed by:	Name Lin Hao	Function SAR Test Engineer	Signature 
Approved by:	Name Qi Dianyuan	Function SAR Project Leader	Signature 
Issued: February 4, 2018			
This calibration certificate shall not be reproduced except in full without written approval of the laboratory.			

Certificate No: Z18-97021

Page 1 of 8





Add: No.51 Xueyuan Road, Huidian District, Beijing, 100191, China  
Tel: +86-10-62304633-2079 Fax: +86-10-62304633-2504  
E-mail: cttl@chinattl.com http://www.chinattl.cn

**Glossary:**

TSL	tissue simulating liquid
ConvF	sensitivity in TSL / NORM <sub>x,y,z</sub>
N/A	not applicable or not measured

**Calibration is Performed According to the Following Standards:**

- IEEE Std 1528-2013, "IEEE Recommended Practice for Determining the Peak Spatial-Averaged Specific Absorption Rate (SAR) in the Human Head from Wireless Communications Devices: Measurement Techniques", June 2013
- IEC 62209-1, "Measurement procedure for assessment of specific absorption rate of human exposure to radio frequency fields from hand-held and body-mounted wireless communication devices- Part 1: Device used next to the ear (Frequency range of 300MHz to 6GHz)", July 2016
- IEC 62209-2, "Procedure to measure the Specific Absorption Rate (SAR) For wireless communication devices used in close proximity to the human body (frequency range of 30MHz to 6GHz)", March 2010
- KDB865664, SAR Measurement Requirements for 100 MHz to 6 GHz

**Additional Documentation:**

- DASY4/5 System Handbook

**Methods Applied and Interpretation of Parameters:**

- Measurement Conditions:** Further details are available from the Validation Report at the end of the certificate. All figures stated in the certificate are valid at the frequency indicated.
- Antenna Parameters with TSL:** The dipole is mounted with the spacer to position its feed point exactly below the center marking of the flat phantom section, with the arms oriented parallel to the body axis.
- Feed Point Impedance and Return Loss:** These parameters are measured with the dipole positioned under the liquid filled phantom. The impedance stated is transformed from the measurement at the SMA connector to the feed point. The Return Loss ensures low reflected power. No uncertainty required.
- Electrical Delay:** One-way delay between the SMA connector and the antenna feed point. No uncertainty required.
- SAR measured:** SAR measured at the stated antenna input power.
- SAR normalized:** SAR as measured, normalized to an input power of 1 W at the antenna connector.
- SAR for nominal TSL parameters:** The measured TSL parameters are used to calculate the nominal SAR result.

The reported uncertainty of measurement is stated as the standard uncertainty of Measurement multiplied by the coverage factor  $k=2$ , which for a normal distribution Corresponds to a coverage probability of approximately 95%.



Add: No.51 Xueyuan Road, Haidian District, Beijing, 100191, China  
Tel: +86-10-62304633-2079 Fax: +86-10-62304633-2504  
E-mail: cttl@chinattl.com http://www.chinattl.cn

### Measurement Conditions

DASY system configuration, as far as not given on page 1.

DASY Version	DASY52	52.10.0.1446
Extrapolation	Advanced Extrapolation	
Phantom	Triple Flat Phantom 5.1C	
Distance Dipole Center - TSL	10 mm	with Spacer
Zoom Scan Resolution	dx, dy, dz = 5 mm	
Frequency	2000 MHz ± 1 MHz	

### Head TSL parameters

The following parameters and calculations were applied.

	Temperature	Permittivity	Conductivity
Nominal Head TSL parameters	22.0 °C	40.0	1.40 mho/m
Measured Head TSL parameters	(22.0 ± 0.2) °C	38.9 ± 6 %	1.42 mho/m ± 6 %
Head TSL temperature change during test	<1.0 °C	---	---

### SAR result with Head TSL

SAR averaged over 1 cm <sup>3</sup> (1 g) of Head TSL	Condition	
SAR measured	250 mW input power	10.2 mW / g
SAR for nominal Head TSL parameters	normalized to 1W	<b>40.3 mW /g ± 18.8 % (k=2)</b>
SAR averaged over 10 cm <sup>3</sup> (10 g) of Head TSL	Condition	
SAR measured	250 mW input power	5.17 mW / g
SAR for nominal Head TSL parameters	normalized to 1W	<b>20.5 mW /g ± 18.7 % (k=2)</b>

### Body TSL parameters

The following parameters and calculations were applied.

	Temperature	Permittivity	Conductivity
Nominal Body TSL parameters	22.0 °C	53.3	1.52 mho/m
Measured Body TSL parameters	(22.0 ± 0.2) °C	51.8 ± 6 %	1.56 mho/m ± 6 %
Body TSL temperature change during test	<1.0 °C	---	---

### SAR result with Body TSL

SAR averaged over 1 cm <sup>3</sup> (1 g) of Body TSL	Condition	
SAR measured	250 mW input power	10.3 mW / g
SAR for nominal Body TSL parameters	normalized to 1W	<b>40.3 mW /g ± 18.8 % (k=2)</b>
SAR averaged over 10 cm <sup>3</sup> (10 g) of Body TSL	Condition	
SAR measured	250 mW input power	5.18 mW / g
SAR for nominal Body TSL parameters	normalized to 1W	<b>20.4 mW /g ± 18.7 % (k=2)</b>



Add: No.51 Xueyuan Road, Haidian District, Beijing, 100191, China  
Tel: +86-10-62304633-2079 Fax: +86-10-62304633-2504  
E-mail: etl@chinatll.com http://www.chinatll.cn

**Appendix (Additional assessments outside the scope of CNAS L0570)**

**Antenna Parameters with Head TSL**

Impedance, transformed to feed point	49.8Ω- 2.08jΩ
Return Loss	- 33.6dB

**Antenna Parameters with Body TSL**

Impedance, transformed to feed point	46.3Ω- 1.63jΩ
Return Loss	- 27.6dB

**General Antenna Parameters and Design**

Electrical Delay (one direction)	1.047 ns
----------------------------------	----------

After long term use with 100W radiated power, only a slight warming of the dipole near the feedpoint can be measured.

The dipole is made of standard semirigid coaxial cable. The center conductor of the feeding line is directly connected to the second arm of the dipole. The antenna is therefore short-circuited for DC-signals. On some of the dipoles, small end caps are added to the dipole arms in order to improve matching when loaded according to the position as explained in the "Measurement Conditions" paragraph. The SAR data are not affected by this change. The overall dipole length is still according to the Standard. No excessive force must be applied to the dipole arms, because they might bend or the soldered connections near the feedpoint may be damaged.

**Additional EUT Data**

Manufactured by	SPEAG
-----------------	-------



Add: No.51 Xueyuan Road, Haidian District, Beijing, 100191, China  
Tel: +86-10-62304633-2079 Fax: +86-10-62304633-2504  
E-mail: cttl@chinattl.com http://www.chinattl.cn

**DASY5 Validation Report for Head TSL**

Date: 02.01.2018

Test Laboratory: CTTL, Beijing, China

**DUT: Dipole 2000 MHz; Type: D2000V2; Serial: D2000V2 - SN: 1009**

Communication System: UID 0, CW; Frequency: 2000 MHz; Duty Cycle: 1:1

Medium parameters used:  $f = 2000$  MHz;  $\sigma = 1.416$  S/m;  $\epsilon_r = 38.89$ ;  $\rho = 1000$  kg/m<sup>3</sup>

Phantom section: Left Section

Measurement Standard: DASY5 (IEEE/IEC/ANSI C63.19-2007)

DASY5 Configuration:

- Probe: EX3DV4 - SN7464; ConvF(8.39, 8.39, 8.39); Calibrated: 9/12/2017,
- Sensor-Surface: 1.4mm (Mechanical Surface Detection)
- Electronics: DAE4 Sn1525; Calibrated: 10/2/2017
- Phantom: Triple Flat Phantom 5.1C; Type: QD 000 P51 CA; Serial: 1161/1
- Measurement SW: DASY52, Version 52.10 (0); SEMCAD X Version 14.6.10 (7417)

**System Performance Check/Zoom Scan (7x7x7) (7x7x7)/Cube 0: Measurement grid:**

dx=5mm, dy=5mm, dz=5mm

Reference Value = 95.98 V/m; Power Drift = -0.03 dB

Peak SAR (extrapolated) = 19.7 W/kg

**SAR(1 g) = 10.2 W/kg; SAR(10 g) = 5.17 W/kg**

Maximum value of SAR (measured) = 16.2 W/kg

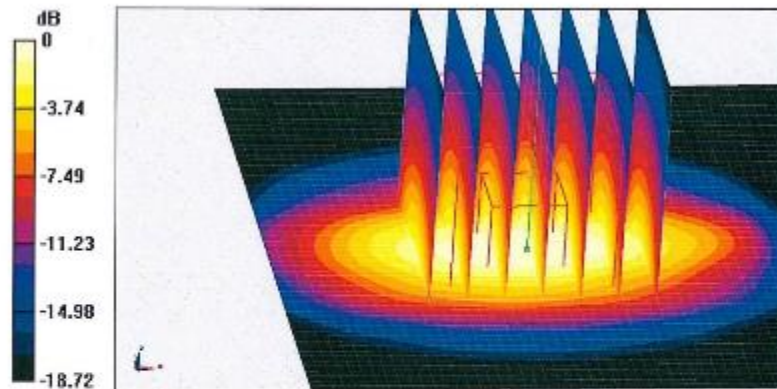

0 dB = 16.2 W/kg = 12.10 dBW/kg



Add: No.51 Xueyuan Road, Haidian District, Beijing, 100191, China  
Tel: +86-10-62304633-2079 Fax: +86-10-62304633-2504  
E-mail: cttl@chinattl.com http://www.chinattl.cn

**Impedance Measurement Plot for Head TSL**

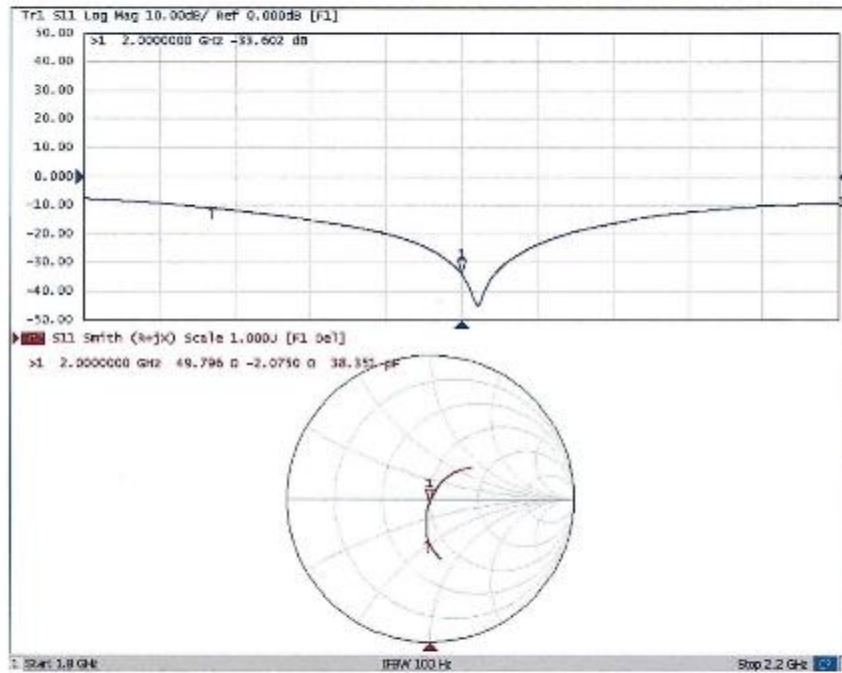



Add: No.51 Xueyuan Road, Haidian District, Beijing, 100191, China  
Tel: +86-10-62304633-2079 Fax: +86-10-62304633-2504  
E-mail: ettl@chinuttl.com http://www.chinuttl.cn

**DASY5 Validation Report for Body TSL**

Date: 02.01.2018

Test Laboratory: CTTL, Beijing, China

**DUT: Dipole 2000 MHz; Type: D2000V2; Serial: D2000V2 - SN: 1009**

Communication System: UID 0, CW; Frequency: 2000 MHz; Duty Cycle: 1:1

Medium parameters used:  $f = 2000$  MHz;  $\sigma = 1.564$  S/m;  $\epsilon_r = 51.83$ ;  $\rho = 1000$  kg/m<sup>3</sup>

Phantom section: Center Section

Measurement Standard: DASY5 (IEEE/IEC/ANSI C63.19-2007)

DASY5 Configuration:

- Probe: EX3DV4 - SN7464; ConvF(8.24,8.24,8.24); Calibrated: 9/12/2017,
- Sensor-Surface: 1.4mm (Mechanical Surface Detection)
- Electronics: DAE4 Sn1525; Calibrated: 10/2/2017
- Phantom: Triple Flat Phantom 5.1C; Type: QD 000 P51 CA; Serial: 1161/1
- Measurement SW: DASY52, Version 52.10 (0); SEMCAD X Version 14.6.10 (7417)

**System Performance Check/Zoom Scan (7x7x7) (7x7x7)/Cube 0: Measurement grid:**

$dx=5$ mm,  $dy=5$ mm,  $dz=5$ mm

Reference Value = 93.84 V/m; Power Drift = 0.02 dB

Peak SAR (extrapolated) = 19.7 W/kg

**SAR(1 g) = 10.3 W/kg; SAR(10 g) = 5.18 W/kg**

Maximum value of SAR (measured) = 16.3 W/kg

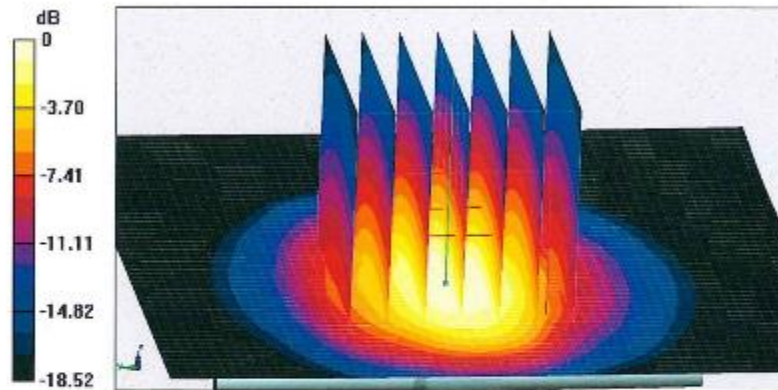

**0 dB = 16.3 W/kg = 12.12 dBW/kg**



In Collaboration with  
**speag**  
**CALIBRATION LABORATORY**  
 Add: No.51 Xueyuan Road, Haidian District, Beijing, 100191, China  
 Tel: +86-10-62304633-2079 Fax: +86-10-62304633-2504  
 E-mail: ttl@chinantl.com http://www.chinantl.cn

**Impedance Measurement Plot for Body TSL**

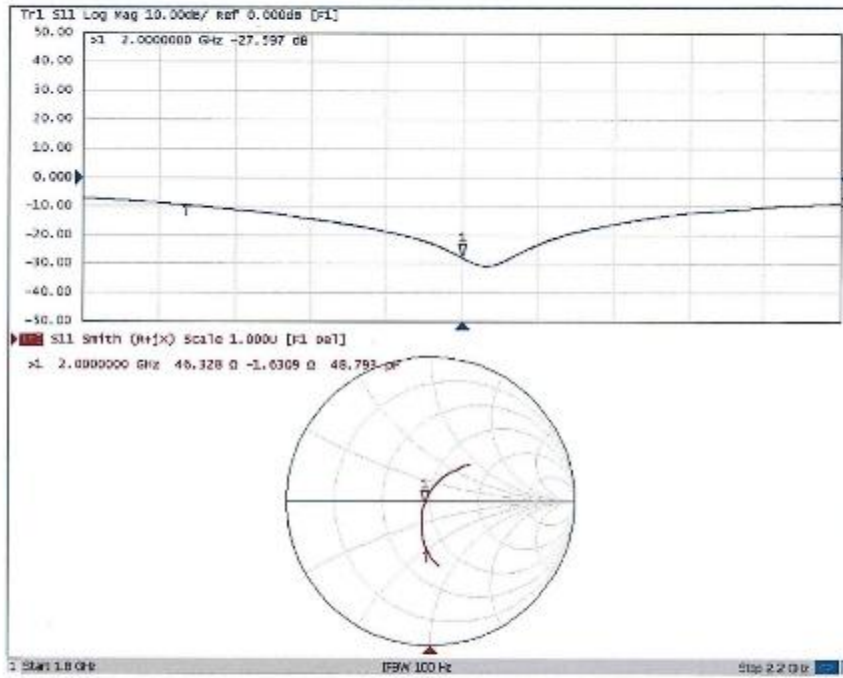

D2450V2Sn:738



In Collaboration with  
**s p e a g**  
CALIBRATION LABORATORY



中国认可  
国际互认  
校准  
CALIBRATION  
CNAS L0570

Add: No.51 Xueyuan Road, Haidian District, Beijing, 100191, China  
Tel: +86-10-62304633-2099 Fax: +86-10-62304633-2504  
E-mail: cctl@china.ttl.com http://www.chinatrll.cn

Client **SRTC**

Certificate No: **Z17-97140**

**CALIBRATION CERTIFICATE**

Object: D2450V2 - SN: 738  
Calibration Procedure(s): FF-Z11-003-01  
Calibration Procedures for dipole validation kits  
Calibration date: September 18, 2017

This calibration Certificate documents the traceability to national standards, which realize the physical units of measurements(SI). The measurements and the uncertainties with confidence probability are given on the following pages and are part of the certificate.

All calibrations have been conducted in the closed laboratory facility: environment temperature(22±3)℃ and humidity<70%.

Calibration Equipment used (M&TE critical for calibration)

Primary Standards	ID #	Cal Date(Calibrated by, Certificate No.)	Scheduled Calibration
Power Meter NRVD	102196	02-Mar-17 (CTTL, No.J17X01254)	Mar-18
Power sensor NRV-Z5	100596	02-Mar-17 (CTTL, No.J17X01254)	Mar-18
Reference Probe EX3DV4	SN 7433	26-Sep-16(SPEAG, No. EX3-7433_Sep16)	Sep-17
DAE4	SN 1331	19-Jan-17(CTTL-SPEAG No.Z17-97015)	Jan-18
Secondary Standards	ID #	Cal Date(Calibrated by, Certificate No.)	Scheduled Calibration
Signal Generator E4438C	MY49071430	13-Jan-17 (CTTL, No.J17X00286)	Jan-18
Network Analyzer E5071C	MY46110673	13-Jan-17 (CTTL, No.J17X00285)	Jan-18

	Name	Function	Signature
Calibrated by:	Zhao Jing	SAR Test Engineer	
Reviewed by:	Yu Zongying	SAR Test Engineer	
Approved by:	Qi Dianyuan	SAR Project Leader	

Issued: September 21, 2017

This calibration certificate shall not be reproduced except in full without written approval of the laboratory.





In Collaboration with  
**s p e a g**  
CALIBRATION LABORATORY

Add: No.51 Xueyuan Road, Haidian District, Beijing, 100191, China  
Tel: +86-10-62304633-2079 Fax: +86-10-62304633-2594  
E-mail: ccl@chinatl.com http://www.chinatl.cn

**Glossary:**

TSL	tissue simulating liquid
ConvF	sensitivity in TSL / NORM <sub>x,y,z</sub>
N/A	not applicable or not measured

**Calibration is Performed According to the Following Standards:**

- IEEE Std 1528-2013, "IEEE Recommended Practice for Determining the Peak Spatial-Averaged Specific Absorption Rate (SAR) in the Human Head from Wireless Communications Devices: Measurement Techniques", June 2013
- IEC 62209-1, "Measurement procedure for assessment of specific absorption rate of human exposure to radio frequency fields from hand-held and body-mounted wireless communication devices- Part 1: Device used next to the ear (Frequency range of 300MHz to 6GHz)", July 2016
- IEC 62209-2, "Procedure to measure the Specific Absorption Rate (SAR) For wireless communication devices used in close proximity to the human body (frequency range of 30MHz to 6GHz)", March 2010
- KDB865864, SAR Measurement Requirements for 100 MHz to 6 GHz

**Additional Documentation:**

- DASY4/5 System Handbook

**Methods Applied and Interpretation of Parameters:**

- Measurement Conditions:** Further details are available from the Validation Report at the end of the certificate. All figures stated in the certificate are valid at the frequency indicated.
- Antenna Parameters with TSL:** The dipole is mounted with the spacer to position its feed point exactly below the center marking of the flat phantom section, with the arms oriented parallel to the body axis.
- Feed Point Impedance and Return Loss:** These parameters are measured with the dipole positioned under the liquid filled phantom. The impedance stated is transformed from the measurement at the SMA connector to the feed point. The Return Loss ensures low reflected power. No uncertainty required.
- Electrical Delay:** One-way delay between the SMA connector and the antenna feed point. No uncertainty required.
- SAR measured:** SAR measured at the stated antenna input power.
- SAR normalized:** SAR as measured, normalized to an input power of 1 W at the antenna connector.
- SAR for nominal TSL parameters:** The measured TSL parameters are used to calculate the nominal SAR result.

The reported uncertainty of measurement is stated as the standard uncertainty of Measurement multiplied by the coverage factor  $k=2$ , which for a normal distribution corresponds to a coverage probability of approximately 95%.



In Collaboration with  
**s p e a g**  
CALIBRATION LABORATORY

Add: No.51 Xueyuan Road, Haiclan District, Beijing, 100191, China.  
Tel: 186-10-62304633-2079 Fax: 186-10-62304633-3504  
E-mail: cctb@china.ttl.com http://www.cchina.ttl.cn

**Measurement Conditions**

DASY system configuration, as far as not given on page 1.

DASY Version	DASY52	52.10.0.1448
Extrapolation	Advanced Extrapolation	
Phantom	Triple Flat Phantom 5 1C	
Distance Dipole Center - TSL	10 mm	with Spacer
Zoom Scan Resolution	dx, dy, dz = 5 mm	
Frequency	2450 MHz ± 1 MHz	

**Head TSL parameters**

The following parameters and calculations were applied.

	Temperature	Permittivity	Conductivity
Nominal Head TSL parameters	22.0 °C	39.2	1.80 mho/m
Measured Head TSL parameters	(22.0 ± 0.2) °C	38.7 ± 6 %	1.79 mho/m ± 6 %
Head TSL temperature change during test	<1.0 °C	---	---

**SAR result with Head TSL**

SAR averaged over 1 cm <sup>3</sup> (1 g) of Head TSL	Condition	
SAR measured	250 mW input power	13.1 mW / g
SAR for nominal Head TSL parameters	normalized to 1W	52.4 mW /g ± 18.8 % (k=2)
SAR averaged over 10 cm <sup>3</sup> (10 g) of Head TSL	Condition	
SAR measured	250 mW input power	6.10 mW / g
SAR for nominal Head TSL parameters	normalized to 1W	24.4 mW /g ± 18.7 % (k=2)

**Body TSL parameters**

The following parameters and calculations were applied.

	Temperature	Permittivity	Conductivity
Nominal Body TSL parameters	22.0 °C	52.7	1.95 mho/m
Measured Body TSL parameters	(22.0 ± 0.2) °C	52.5 ± 6 %	1.98 mho/m ± 6 %
Body TSL temperature change during test	<1.0 °C	---	---

**SAR result with Body TSL**

SAR averaged over 1 cm <sup>3</sup> (1 g) of Body TSL	Condition	
SAR measured	250 mW input power	13.2 mW / g
SAR for nominal Body TSL parameters	normalized to 1W	52.3 mW /g ± 18.8 % (k=2)
SAR averaged over 10 cm <sup>3</sup> (10 g) of Body TSL	Condition	
SAR measured	250 mW input power	6.10 mW / g
SAR for nominal Body TSL parameters	normalized to 1W	24.3 mW /g ± 18.7 % (k=2)



In Collaboration with  
**s p e a g**  
CALIBRATION LABORATORY

Addr: No.51 Xueyuan Road, Haidian District, Beijing, 100191, China  
Tel: +86-10-62504633-2079 Fax: +86-10-62504633-2504  
E-mail: ctri@chinaatl.com http://www.chinaatl.cn

**Appendix (Additional assessments outside the scope of CNAS L0570)**

**Antenna Parameters with Head TSL**

Impedance, transformed to feed point	51.3Ω+ 5.92jΩ
Return Loss	- 24.5dB

**Antenna Parameters with Body TSL**

Impedance, transformed to feed point	47.6Ω+ 6.39jΩ
Return Loss	- 23.1dB

**General Antenna Parameters and Design**

Electrical Delay (one direction)	1.268 ns
----------------------------------	----------

After long term use with 100W radiated power, only a slight warming of the dipole near the feedpoint can be measured.

The dipole is made of standard semirigid coaxial cable. The center conductor of the feeding line is directly connected to the second arm of the dipole. The antenna is therefore short-circuited for DC-signals. On some of the dipoles, small end caps are added to the dipole arms in order to improve matching when loaded according to the position as explained in the "Measurement Conditions" paragraph. The SAR data are not affected by this change. The overall dipole length is still according to the Standard. No excessive force must be applied to the dipole arms, because they might bend or the soldered connections near the feedpoint may be damaged.

**Additional EUT Data**

Manufactured by	SPEAG
-----------------	-------



In Collaboration with  
**s p e a g**  
CALIBRATION LABORATORY

Addr: No.31 Xueyuan Road, Haidian, District, Beijing, 100191, China  
Tel: +86-10-62304633-2079 Fax: +86-10-62304633-2504  
E-mail: crli@chinattl.com http://www.chinattl.com

**DASY5 Validation Report for Head TSL**

Date: 09.18.2017

Test Laboratory: CTTI, Beijing, China

**DUT: Dipole 2450 MHz; Type: D2450V2; Serial: D2450V2 - SN: 738**

Communication System: UTD 0, CW; Frequency: 2450 MHz; Duty Cycle: 1:1

Medium parameters used:  $f = 2450$  MHz;  $\sigma = 1.788$  S/m;  $\epsilon_r = 38.67$ ;  $\rho = 1000$  kg/m<sup>3</sup>

Phantom section: Left Section

Measurement Standard: DASY5 (IEEE/IRC/ANSI C63.19-2007)

DASY5 Configuration:

- Probe: EX3DV4 - SN7433; ConvF(7.45, 7.45, 7.45); Calibrated; 9/26/2016;
- Sensor-Surface: 1.4mm (Mechanical Surface Detection)
- Electronics: DAE4 Sn1331; Calibrated; 1/19/2017
- Phantom: Triple Flat Phantom 5.1C; Type: QD 000 P51 CA; Serial: 1161/1
- Measurement SW: DASY52, Version 52.10 (0); SEMCAD X Version 14.6.10 (7417)

**Dipole Calibration/Zoom Scan (7x7x7) (7x7x7):Cube 0: Measurement grid: dx=5mm, dy=5mm, dz=5mm**

Reference Value = 102.1 V/m; Power Drift = -0.01 dB

Peak SAR (extrapolated) = 27.8 W/kg

**SAR(1 g) = 13.1 W/kg; SAR(10 g) = 6.1 W/kg**

Maximum value of SAR (measured) = 22.0 W/kg

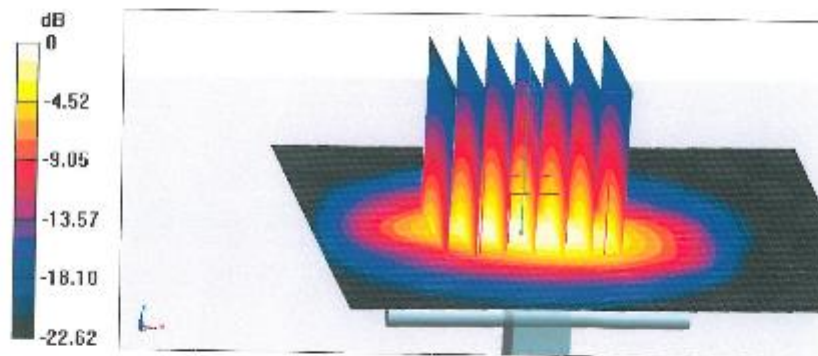

0 dB = 22.0 W/kg = 13.42 dBW/kg



In Collaboration with  
**s p e a g**  
CALIBRATION LABORATORY

Add: No.51 Xueyuan Road, Haidian District, Beijing, 100191, China  
Tel: +86-10-62304633-2079 Fax: +86-10-62304633-2504  
E-mail: ttl@chinatl.com http://www.chinatl.cn

**Impedance Measurement Plot for Head TSL**

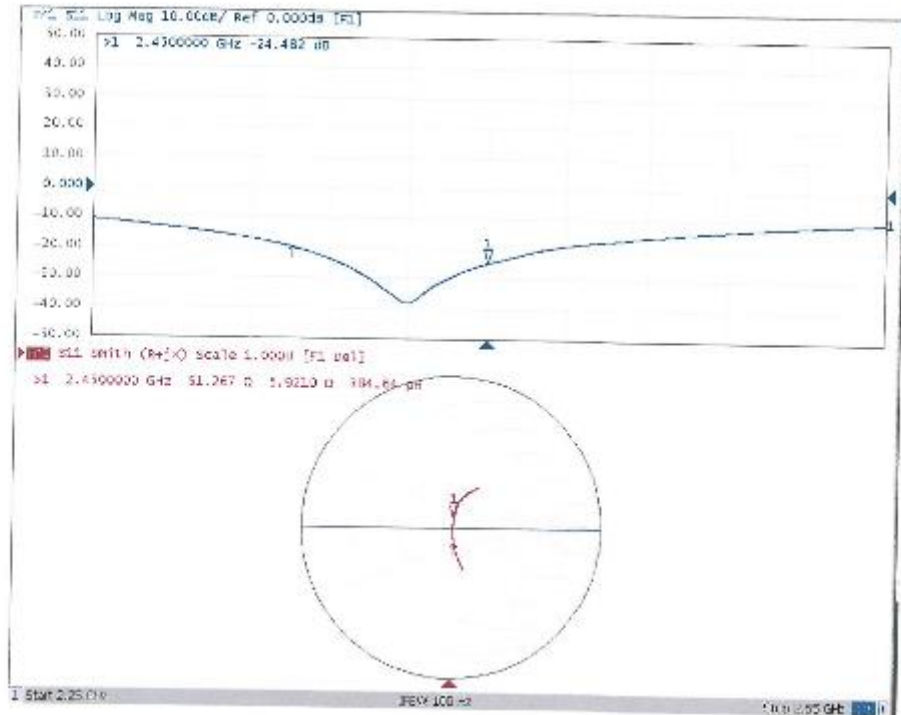



In Collaboration with  
**s p e a g**  
CALIBRATION LABORATORY

Addr: No 51 Xueyuan Road, Haidian District, Beijing, 100191, China  
Tel: +86-10-62304633-2079 Fax: +86-10-62304633-2504  
E-mail: ctcl@chinattl.com http://www.chinattl.cn

**DASYS Validation Report for Body TSL**

Date: 09.18.2017

Test Laboratory: CTTL, Beijing, China

**DUT: Dipole 2450 MHz; Type: D2450V2; Serial: D2450V2 - SN: 738**

Communication System: UID 0, CW; Frequency: 2450 MHz; Duty Cycle: 1:1

Medium parameters used:  $f = 2450$  MHz;  $\sigma = 1.983$  S/m;  $\epsilon_r = 52.51$ ;  $\rho = 1000$  kg/m<sup>3</sup>

Phantom section: Center Section

Measurement Standard: DASYS (IEEE/IEC/ANSI C63.19-2007)

**DASYS Configuration:**

- Probe: FX3DV4 - SN7433; ConvF(7.46, 7.46, 7.46); Calibrated: 9/26/2016;
- Sensor-Surface: 1.4mm (Mechanical Surface Detection)
- Electronics: DAE4 Sn1331; Calibrated: 1/19/2017
- Phantom: Triple Flat Phantom 5.1C; Type: QD 000 P51 CA; Serial: 1161/1
- Measurement SW: DASYS2, Version 52.10 (0); SFMCAD X Version 14.6.10 (7417)

**Dipole Calibration:** Zoom Scan (7x7x7) (7x7x7)/Cube 0; Measurement grid: dx=5mm, dy=5mm, dz=5mm

Reference Value = 96.41 V/m; Power Drift = -0.03 dB

Peak SAR (extrapolated) = 27.8 W/kg

**SAR(1 g) = 13.2 W/kg; SAR(10 g) = 6.1 W/kg**

Maximum value of SAR (measured) = 22.3 W/kg

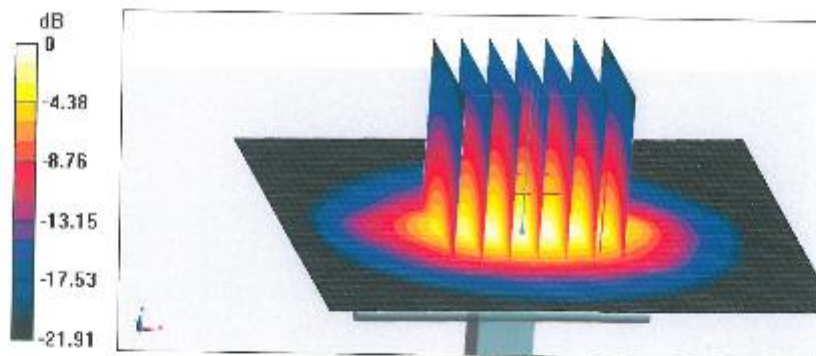

0 dB = 22.3 W/kg = 13.48 dBW/kg



In Collaboration with  
**s p e a g**  
CALIBRATION LABORATORY

Add: No.51 Xueyuan Road, Haidian District, Beijing, 100191, China  
Tel: +86-10-62304633-2079 Fax: +86-10-62304633-2504  
E-mail: ctdl@china.ttl.com http://www.china.ttl.cn

**Impedance Measurement Plot for Body TSL**

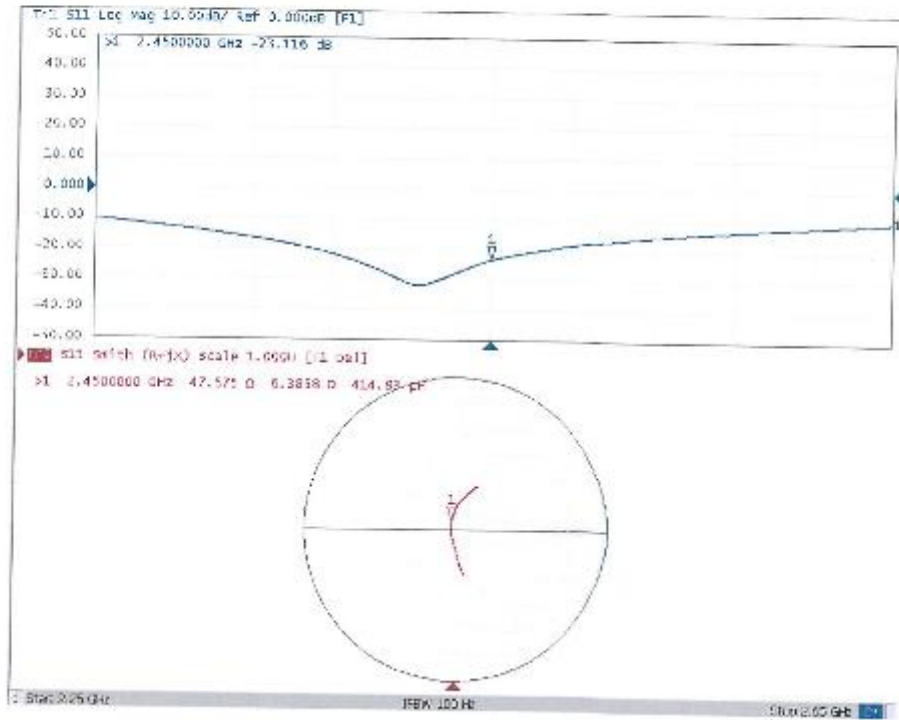

D2600V2 Sn:1166

**Calibration Laboratory of  
Schmid & Partner  
Engineering AG**  
Zeughausstrasse 43, 8004 Zurich, Switzerland



**S** Schweizerischer Kalibrierdienst  
**C** Service suisse d'étalonnage  
**S** Servizio svizzero di taratura  
**S** Swiss Calibration Service

Accredited by the Swiss Accreditation Service (SAS)  
The Swiss Accreditation Service is one of the signatories to the EA  
Multilateral Agreement for the recognition of calibration certificates

Accreditation No.: **SCS 0108**

Client **SRTC-BJ (Auden)**

Certificate No: **D2600V2-1166\_Nov19**

**CALIBRATION CERTIFICATE**

Object: **D2600V2 - SN:1166**

Calibration procedure(s): **QA CAL-05.v11  
Calibration Procedure for SAR Validation Sources between 0.7-3 GHz**

Calibration date: **November 08, 2019**

This calibration certificate documents the traceability to national standards, which realize the physical units of measurements (SI).  
The measurements and the uncertainties with confidence probability are given on the following pages and are part of the certificate.

All calibrations have been conducted in the closed laboratory facility: environment temperature (22 ± 3)°C and humidity < 70%.

Calibration Equipment used (M&TE critical for calibration)

Primary Standards	ID #	Cal Date (Certificate No.)	Scheduled Calibration
Power meter NRP	SN: 104778	03-Apr-19 (No. 217-02892/02893)	Apr-20
Power sensor NRP-Z91	SN: 103244	03-Apr-19 (No. 217-02892)	Apr-20
Power sensor NRP-Z91	SN: 103245	03-Apr-19 (No. 217-02893)	Apr-20
Reference 20 dB Attenuator	SN: 5058 (20k)	04-Apr-19 (No. 217-02894)	Apr-20
Type-N mismatch combination	SN: 5047.2 / 05327	04-Apr-19 (No. 217-02895)	Apr-20
Reference Probe EX3DV4	SN: 7349	29-May-19 (No. EX3-7349_May19)	May-20
DAE4	SN: 601	30-Apr-19 (No. DAE4-601_Apr19)	Apr-20
Secondary Standards	ID #	Check Date (in house)	Scheduled Check
Power meter E4419B	SN: GB39512475	30-Oct-14 (in house check Feb-19)	In house check: Oct-20
Power sensor HP 8481A	SN: US37292783	07-Oct-15 (in house check Oct-18)	In house check: Oct-20
Power sensor HP 8481A	SN: MY41092317	07-Oct-15 (in house check Oct-18)	In house check: Oct-20
RF generator R&S SMT-06	SN: 100972	15-Jun-15 (in house check Oct-18)	In house check: Oct-20
Network Analyzer Agilent E8358A	SN: US41060477	31-Mar-14 (in house check Oct-19)	In house check: Oct-20

Calibrated by: **Claudio Leubler** (Name) / **Laboratory Technician** (Function) / *[Signature]* (Signature)

Approved by: **Katja Pokovic** (Name) / **Technical Manager** (Function) / *[Signature]* (Signature)

Issued: November 12, 2019

This calibration certificate shall not be reproduced except in full without written approval of the laboratory.



**Calibration Laboratory of  
Schmid & Partner  
Engineering AG**  
Zeughausstrasse 43, 8004 Zurich, Switzerland



**S** Schweizerischer Kalibrierdienst  
**C** Service suisse d'étalonnage  
**S** Servizio svizzero di taratura  
**S** Swiss Calibration Service

Accredited by the Swiss Accreditation Service (SAS)  
The Swiss Accreditation Service is one of the signatories to the EA  
Multilateral Agreement for the recognition of calibration certificates

Accreditation No.: **SCS 0108**

**Glossary:**

TSL	tissue simulating liquid
ConvF	sensitivity in TSL / NORM x,y,z
N/A	not applicable or not measured

**Calibration is Performed According to the Following Standards:**

- IEEE Std 1528-2013, "IEEE Recommended Practice for Determining the Peak Spatial-Averaged Specific Absorption Rate (SAR) in the Human Head from Wireless Communications Devices: Measurement Techniques", June 2013
- IEC 62209-1, "Measurement procedure for the assessment of Specific Absorption Rate (SAR) from hand-held and body-mounted devices used next to the ear (frequency range of 300 MHz to 6 GHz)", July 2016
- IEC 62209-2, "Procedure to determine the Specific Absorption Rate (SAR) for wireless communication devices used in close proximity to the human body (frequency range of 30 MHz to 6 GHz)", March 2010
- KDB 865664, "SAR Measurement Requirements for 100 MHz to 6 GHz"

**Additional Documentation:**

- DASY4/5 System Handbook

**Methods Applied and Interpretation of Parameters:**

- Measurement Conditions:** Further details are available from the Validation Report at the end of the certificate. All figures stated in the certificate are valid at the frequency indicated.
- Antenna Parameters with TSL:** The dipole is mounted with the spacer to position its feed point exactly below the center marking of the flat phantom section, with the arms oriented parallel to the body axis.
- Feed Point Impedance and Return Loss:** These parameters are measured with the dipole positioned under the liquid filled phantom. The impedance stated is transformed from the measurement at the SMA connector to the feed point. The Return Loss ensures low reflected power. No uncertainty required.
- Electrical Delay:** One-way delay between the SMA connector and the antenna feed point. No uncertainty required.
- SAR measured:** SAR measured at the stated antenna input power.
- SAR normalized:** SAR as measured, normalized to an input power of 1 W at the antenna connector.
- SAR for nominal TSL parameters:** The measured TSL parameters are used to calculate the nominal SAR result.

The reported uncertainty of measurement is stated as the standard uncertainty of measurement multiplied by the coverage factor  $k=2$ , which for a normal distribution corresponds to a coverage probability of approximately 95%.

DASY system configuration, as far as not given on page 1.

DASY Version	DASY5	V52.10.3
Extrapolation	Advanced Extrapolation	
Phantom	Modular Flat Phantom	
Distance Dipole Center - TSL	10 mm	with Spacer
Zoom Scan Resolution	dx, dy, dz = 5 mm	
Frequency	2600 MHz ± 1 MHz	

### Head TSL parameters

The following parameters and calculations were applied.

	Temperature	Permittivity	Conductivity
Nominal Head TSL parameters	22.0 °C	39.0	1.96 mho/m
Measured Head TSL parameters	(22.0 ± 0.2) °C	37.7 ± 6 %	2.01 mho/m ± 6 %
Head TSL temperature change during test	< 0.5 °C	----	----

### SAR result with Head TSL

SAR averaged over 1 cm <sup>3</sup> (1 g) of Head TSL	Condition	
SAR measured	250 mW input power	14.4 W/kg
SAR for nominal Head TSL parameters	normalized to 1W	56.5 W/kg ± 17.0 % (k=2)

SAR averaged over 10 cm <sup>3</sup> (10 g) of Head TSL	condition	
SAR measured	250 mW input power	6.43 W/kg
SAR for nominal Head TSL parameters	normalized to 1W	25.4 W/kg ± 16.5 % (k=2)

**Appendix (Additional assessments outside the scope of SCS 0108)**

**Antenna Parameters with Head TSL**

Impedance, transformed to feed point	47.9 $\Omega$ - 7.8 j $\Omega$
Return Loss	- 21.7 dB

**General Antenna Parameters and Design**

Electrical Delay (one direction)	1.148 ns
----------------------------------	----------

After long term use with 100W radiated power, only a slight warming of the dipole near the feedpoint can be measured.

The dipole is made of standard semirigid coaxial cable. The center conductor of the feeding line is directly connected to the second arm of the dipole. The antenna is therefore short-circuited for DC-signals. On some of the dipoles, small end caps are added to the dipole arms in order to improve matching when loaded according to the position as explained in the "Measurement Conditions" paragraph. The SAR data are not affected by this change. The overall dipole length is still according to the Standard.

No excessive force must be applied to the dipole arms, because they might bend or the soldered connections near the feedpoint may be damaged.

**Additional EUT Data**

Manufactured by	SPEAG
-----------------	-------

## DASY5 Validation Report for Head TSL

Date: 08.11.2019

Test Laboratory: SPEAG, Zurich, Switzerland

**DUT: Dipole 2600 MHz; Type: D2600V2; Serial: D2600V2 - SN:1166**

Communication System: UID 0 - CW; Frequency: 2600 MHz

Medium parameters used:  $f = 2600$  MHz;  $\sigma = 2.01$  S/m;  $\epsilon_r = 37.7$ ;  $\rho = 1000$  kg/m<sup>3</sup>

Phantom section: Flat Section

Measurement Standard: DASY5 (IEEE/IEC/ANSI C63.19-2011)

DASY52 Configuration:

- Probe: EX3DV4 - SN7349; ConvF(7.69, 7.69, 7.69) @ 2600 MHz; Calibrated: 29.05.2019
- Sensor-Surface: 1.4mm (Mechanical Surface Detection)
- Electronics: DAE4 Sn601; Calibrated: 30.04.2019
- Phantom: Flat Phantom 5.0 (front); Type: QD 000 P50 AA; Serial: 1001
- DASY52 52.10.3(1513); SEMCAD X 14.6.13(7474)

### Dipole Calibration for Head Tissue/Pin=250 mW, d=10mm/Zoom Scan (7x7x7)/Cube 0:

Measurement grid: dx=5mm, dy=5mm, dz=5mm

Reference Value = 118.5 V/m; Power Drift = 0.06 dB

Peak SAR (extrapolated) = 28.7 W/kg

**SAR(1 g) = 14.4 W/kg; SAR(10 g) = 6.43 W/kg**

Smallest distance from peaks to all points 3 dB below = 9 mm

Ratio of SAR at M2 to SAR at M1 = 50.2%

Maximum value of SAR (measured) = 23.8 W/kg

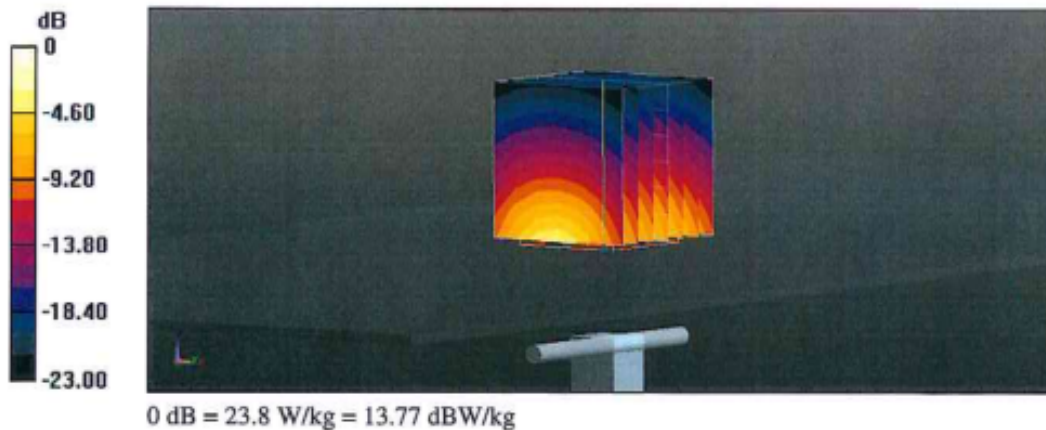

**Impedance Measurement Plot for Head TSL**

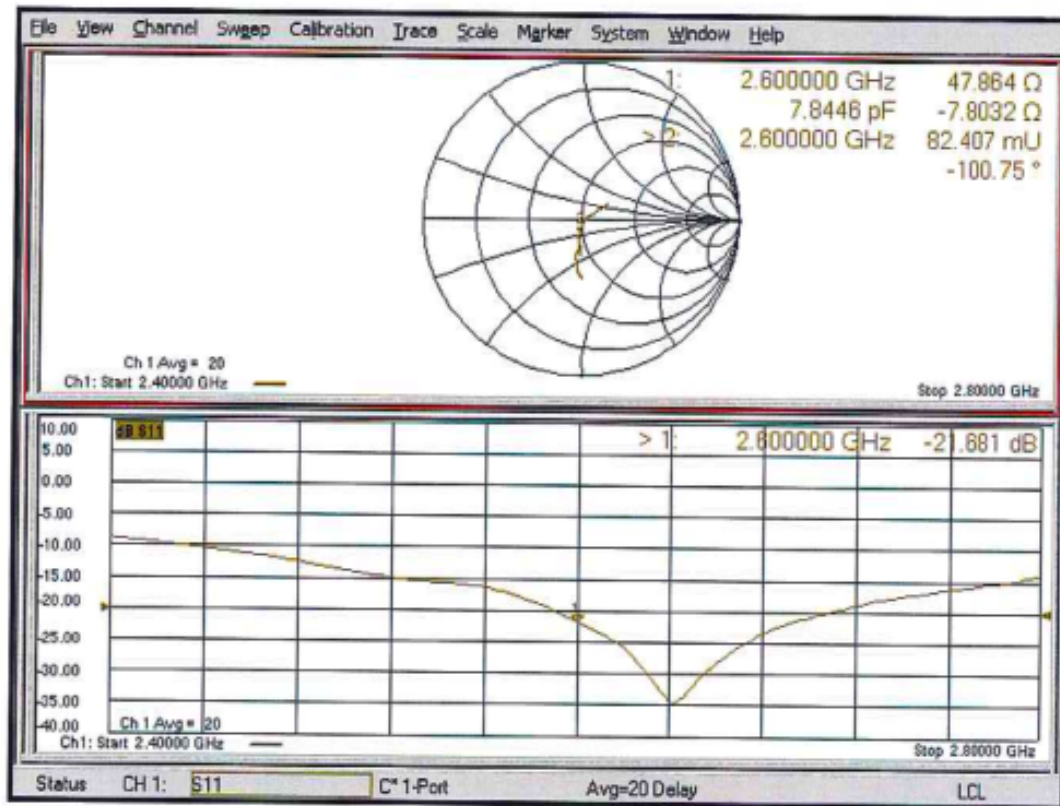

D5GHzV2-SN1079



In Collaboration with  
Add: No.51 Xueyuan Road, Haidian District, Beijing, 100191, China  
Tel: +86-10-62304633-2079 Fax: +86-10-62304633-2504  
E-mail: cttl@chinattl.com http://www.chinattl.cn



中国认可  
国际互认  
校准  
CALIBRATION  
CNAS L0570

Client **SRTC**

Certificate No: **Z17-97133**

**CALIBRATION CERTIFICATE**

Object: D5GHzV2 - SN: 1079  
Calibration Procedure(s): FF-Z11-003-01  
Calibration Procedures for dipole validation kits  
Calibration date: September 25, 2017

This calibration Certificate documents the traceability to national standards, which realize the physical units of measurements(SI). The measurements and the uncertainties with confidence probability are given on the following pages and are part of the certificate.

All calibrations have been conducted in the closed laboratory facility: environment temperature(22±3)°C and humidity<70%.

Calibration Equipment used (M&TE critical for calibration)

Primary Standards	ID #	Cal Date(Calibrated by, Certificate No.)	Scheduled Calibration
Power Meter NRP2	102196	02-Mar-17 (CTTL, No.J17X01254)	Mar-18
Power sensor NRP-Z91	100596	02-Mar-17 (CTTL, No.J17X01254)	Mar-18
ReferenceProbe EX3DV4	SN 3846	13-Jan-17(CTTL-SPEAG,No.Z16-97251)	Jan-18
DAE4	SN 1331	19-Jan-17(CTTL-SPEAG,No.Z17-97015)	Jan-18
Secondary Standards	ID #	Cal Date(Calibrated by, Certificate No.)	Scheduled Calibration
Signal Generator E4438C	MY49071430	13-Jan-17 (CTTL, No.J17X00286)	Jan-18
NetworkAnalyzer E5071C	MY46110673	13-Jan-17 (CTTL, No.J17X00285)	Jan-18

	Name	Function	Signature
Calibrated by:	Zhao Jing	SAR Test Engineer	
Reviewed by:	Yu Zongying	SAR Test Engineer	
Approved by:	Qi Dianyuan	SAR Project Leader	

Issued: September 28, 2017

This calibration certificate shall not be reproduced except in full without written approval of the laboratory.



Add: No.51 Xueyuan Road, Haidian District, Beijing, 100191, China  
Tel: +86-10-62304633-2079 Fax: +86-10-62304633-2504  
E-mail: cttl@chinattl.com http://www.chinattl.cn

**Glossary:**

TSL	tissue simulating liquid
ConvF	sensitivity in TSL / NORM <sub>x,y,z</sub>
N/A	not applicable or not measured

**Calibration is Performed According to the Following Standards:**

- IEEE Std 1528-2013, "IEEE Recommended Practice for Determining the Peak Spatial-Averaged Specific Absorption Rate (SAR) in the Human Head from Wireless Communications Devices: Measurement Techniques", June 2013
- IEC 62209-1, "Measurement procedure for assessment of specific absorption rate of human exposure to radio frequency fields from hand-held and body-mounted wireless communication devices- Part 1: Device used next to the ear (Frequency range of 300MHz to 6GHz)", July 2016
- IEC 62209-2, "Procedure to measure the Specific Absorption Rate (SAR) For wireless communication devices used in close proximity to the human body (frequency range of 30MHz to 6GHz)", March 2010
- KDB865664, SAR Measurement Requirements for 100 MHz to 6 GHz

**Additional Documentation:**

- DASY4/5 System Handbook

**Methods Applied and Interpretation of Parameters:**

- Measurement Conditions:* Further details are available from the Validation Report at the end of the certificate. All figures stated in the certificate are valid at the frequency indicated.
- Antenna Parameters with TSL:* The dipole is mounted with the spacer to position its feed point exactly below the center marking of the flat phantom section, with the arms oriented parallel to the body axis.
- Feed Point Impedance and Return Loss:* These parameters are measured with the dipole positioned under the liquid filled phantom. The impedance stated is transformed from the measurement at the SMA connector to the feed point. The Return Loss ensures low reflected power. No uncertainty required.
- Electrical Delay:* One-way delay between the SMA connector and the antenna feed point. No uncertainty required.
- SAR measured:* SAR measured at the stated antenna input power.
- SAR normalized:* SAR as measured, normalized to an input power of 1 W at the antenna connector.
- SAR for nominal TSL parameters:* The measured TSL parameters are used to calculate the nominal SAR result.

The reported uncertainty of measurement is stated as the standard uncertainty of Measurement multiplied by the coverage factor  $k=2$ , which for a normal distribution Corresponds to a coverage probability of approximately 95%.



Add: No.51 Xueyuan Road, Haidian District, Beijing, 100191, China  
Tel: +86-10-62304633-2079 Fax: +86-10-62304633-2504  
E-mail: cttl@chinattl.com http://www.chinattl.cn

**Measurement Conditions**

DASY system configuration, as far as not given on page 1.

DASY Version	DASY52	52.10.0.1446
Extrapolation	Advanced Extrapolation	
Phantom	Triple Flat Phantom 5.1C	
Distance Dipole Center - TSL	10 mm	with Spacer
Zoom Scan Resolution	dx, dy = 4 mm, dz = 1.4 mm	Graded Ratio = 1.4 (Z direction)
Frequency	5200 MHz ± 1 MHz 5300 MHz ± 1 MHz 5500 MHz ± 1 MHz 5600 MHz ± 1 MHz 5800 MHz ± 1 MHz	

**Head TSL parameters at 5200 MHz**

The following parameters and calculations were applied.

	Temperature	Permittivity	Conductivity
Nominal Head TSL parameters	22.0 °C	36.0	4.66 mho/m
Measured Head TSL parameters	(22.0 ± 0.2) °C	35.7 ± 6 %	4.62 mho/m ± 6 %
Head TSL temperature change during test	<1.0 °C	----	----

**SAR result with Head TSL at 5200 MHz**

SAR averaged over 1 cm <sup>3</sup> (1 g) of Head TSL	Condition	
SAR measured	100 mW input power	7.77 mW / g
SAR for nominal Head TSL parameters	normalized to 1W	77.6 mW / g ± 24.4 % (k=2)
SAR averaged over 10 cm <sup>3</sup> (10 g) of Head TSL	Condition	
SAR measured	100 mW input power	2.24 mW / g
SAR for nominal Head TSL parameters	normalized to 1W	22.3 mW / g ± 24.2 % (k=2)





Add: No.51 Xueyuan Road, Haidian District, Beijing, 100191, China  
Tel: +86-10-62304633-2079 Fax: +86-10-62304633-2504  
E-mail: cttl@chinattl.com http://www.chinattl.cn

**Head TSL parameters at 5300 MHz**

The following parameters and calculations were applied.

	Temperature	Permittivity	Conductivity
Nominal Head TSL parameters	22.0 °C	35.9	4.76 mho/m
Measured Head TSL parameters	(22.0 ± 0.2) °C	36.1 ± 6 %	4.67 mho/m ± 6 %
Head TSL temperature change during test	<1.0 °C	----	----

**SAR result with Head TSL at 5300 MHz**

SAR averaged over 1 cm <sup>3</sup> (1 g) of Head TSL	Condition	
SAR measured	100 mW input power	8.13 mW / g
SAR for nominal Head TSL parameters	normalized to 1W	81.3 mW /g ± 24.4 % (k=2)
SAR averaged over 10 cm <sup>3</sup> (10 g) of Head TSL	Condition	
SAR measured	100 mW input power	2.32 mW / g
SAR for nominal Head TSL parameters	normalized to 1W	23.2 mW /g ± 24.2 % (k=2)

**Head TSL parameters at 5500 MHz**

The following parameters and calculations were applied.

	Temperature	Permittivity	Conductivity
Nominal Head TSL parameters	22.0 °C	35.6	4.96 mho/m
Measured Head TSL parameters	(22.0 ± 0.2) °C	35.9 ± 6 %	4.93 mho/m ± 6 %
Head TSL temperature change during test	<1.0 °C	----	----

**SAR result with Head TSL at 5500 MHz**

SAR averaged over 1 cm <sup>3</sup> (1 g) of Head TSL	Condition	
SAR measured	100 mW input power	8.24 mW / g
SAR for nominal Head TSL parameters	normalized to 1W	82.5 mW /g ± 24.4 % (k=2)
SAR averaged over 10 cm <sup>3</sup> (10 g) of Head TSL	Condition	
SAR measured	100 mW input power	2.37 mW / g
SAR for nominal Head TSL parameters	normalized to 1W	23.8 mW /g ± 24.2 % (k=2)



Add: No.51 Xueyuan Road, Haidian District, Beijing, 100191, China  
Tel: +86-10-62304633-2079 Fax: +86-10-62304633-2504  
E-mail: cttl@chinattl.com http://www.chinattl.cn

#### Head TSL parameters at 5600 MHz

The following parameters and calculations were applied.

	Temperature	Permittivity	Conductivity
Nominal Head TSL parameters	22.0 °C	35.5	5.07 mho/m
Measured Head TSL parameters	(22.0 ± 0.2) °C	35.7 ± 6 %	4.98 mho/m ± 6 %
Head TSL temperature change during test	<1.0 °C	----	----

#### SAR result with Head TSL at 5600 MHz

SAR averaged over 1 cm <sup>3</sup> (1 g) of Head TSL	Condition	
SAR measured	100 mW input power	8.16 mW / g
SAR for nominal Head TSL parameters	normalized to 1W	81.6 mW /g ± 24.4 % (k=2)
SAR averaged over 10 cm <sup>3</sup> (10 g) of Head TSL	Condition	
SAR measured	100 mW input power	2.34 mW / g
SAR for nominal Head TSL parameters	normalized to 1W	23.4 mW /g ± 24.2 % (k=2)

#### Head TSL parameters at 5800 MHz

The following parameters and calculations were applied.

	Temperature	Permittivity	Conductivity
Nominal Head TSL parameters	22.0 °C	35.3	5.27 mho/m
Measured Head TSL parameters	(22.0 ± 0.2) °C	35.8 ± 6 %	5.16 mho/m ± 6 %
Head TSL temperature change during test	<1.0 °C	----	----

#### SAR result with Head TSL at 5800 MHz

SAR averaged over 1 cm <sup>3</sup> (1 g) of Head TSL	Condition	
SAR measured	100 mW input power	7.85 mW / g
SAR for nominal Head TSL parameters	normalized to 1W	78.7 mW /g ± 24.4 % (k=2)
SAR averaged over 10 cm <sup>3</sup> (10 g) of Head TSL	Condition	
SAR measured	100 mW input power	2.25 mW / g
SAR for nominal Head TSL parameters	normalized to 1W	22.6 mW /g ± 24.2 % (k=2)



Add: No.51 Xueyuan Road, Haidian District, Beijing, 100191, China  
Tel: +86-10-62304633-2079 Fax: +86-10-62304633-2504  
E-mail: cttl@chinattl.com http://www.chinattl.cn

**Body TSL parameters at 5200 MHz**

The following parameters and calculations were applied.

	Temperature	Permittivity	Conductivity
Nominal Body TSL parameters	22.0 °C	49.0	5.30 mho/m
Measured Body TSL parameters	(22.0 ± 0.2) °C	49.5 ± 6 %	5.38 mho/m ± 6 %
Body TSL temperature change during test	<1.0 °C	----	----

**SAR result with Body TSL at 5200 MHz**

SAR averaged over 1 cm <sup>3</sup> (1 g) of Body TSL	Condition	
SAR measured	100 mW input power	7.52 mW / g
SAR for nominal Body TSL parameters	normalized to 1W	75.4 mW /g ± 24.4 % (k=2)
SAR averaged over 10 cm <sup>3</sup> (10 g) of Body TSL	Condition	
SAR measured	100 mW input power	2.12 mW / g
SAR for nominal Body TSL parameters	normalized to 1W	21.3 mW /g ± 24.2 % (k=2)

**Body TSL parameters at 5300 MHz**

The following parameters and calculations were applied.

	Temperature	Permittivity	Conductivity
Nominal Body TSL parameters	22.0 °C	48.9	5.42 mho/m
Measured Body TSL parameters	(22.0 ± 0.2) °C	49.2 ± 6 %	5.50 mho/m ± 6 %
Body TSL temperature change during test	<1.0 °C	----	----

**SAR result with Body TSL at 5300 MHz**

SAR averaged over 1 cm <sup>3</sup> (1 g) of Body TSL	Condition	
SAR measured	100 mW input power	7.68 mW / g
SAR for nominal Body TSL parameters	normalized to 1W	76.9 mW /g ± 24.4 % (k=2)
SAR averaged over 10 cm <sup>3</sup> (10 g) of Body TSL	Condition	
SAR measured	100 mW input power	2.18 mW / g
SAR for nominal Body TSL parameters	normalized to 1W	21.9 mW /g ± 24.2 % (k=2)



Add: No.51 Xueyuan Road, Haidian District, Beijing, 100191, China  
Tel: +86-10-62304633-2079 Fax: +86-10-62304633-2504  
E-mail: cttl@chinattl.com http://www.chinattl.cn

**Body TSL parameters at 5500 MHz**

The following parameters and calculations were applied.

	Temperature	Permittivity	Conductivity
Nominal Body TSL parameters	22.0 °C	48.6	5.65 mho/m
Measured Body TSL parameters	(22.0 ± 0.2) °C	49.0 ± 6 %	5.72 mho/m ± 6 %
Body TSL temperature change during test	<1.0 °C	----	----

**SAR result with Body TSL at 5500 MHz**

SAR averaged over 1 cm <sup>3</sup> (1 g) of Body TSL	Condition	
SAR measured	100 mW input power	8.22 mW / g
SAR for nominal Body TSL parameters	normalized to 1W	82.4 mW /g ± 24.4 % (k=2)
SAR averaged over 10 cm <sup>3</sup> (10 g) of Body TSL	Condition	
SAR measured	100 mW input power	2.35 mW / g
SAR for nominal Body TSL parameters	normalized to 1W	23.6 mW /g ± 24.2 % (k=2)

**Body TSL parameters at 5600 MHz**

The following parameters and calculations were applied.

	Temperature	Permittivity	Conductivity
Nominal Body TSL parameters	22.0 °C	48.5	5.77 mho/m
Measured Body TSL parameters	(22.0 ± 0.2) °C	48.4 ± 6 %	5.73 mho/m ± 6 %
Body TSL temperature change during test	<1.0 °C	----	----

**SAR result with Body TSL at 5600 MHz**

SAR averaged over 1 cm <sup>3</sup> (1 g) of Body TSL	Condition	
SAR measured	100 mW input power	8.08 mW / g
SAR for nominal Body TSL parameters	normalized to 1W	80.7 mW /g ± 24.4 % (k=2)
SAR averaged over 10 cm <sup>3</sup> (10 g) of Body TSL	Condition	
SAR measured	100 mW input power	2.30 mW / g
SAR for nominal Body TSL parameters	normalized to 1W	23.0 mW /g ± 24.2 % (k=2)



Add: No.51 Xueyuan Road, Haidian District, Beijing, 100191, China  
Tel: +86-10-62304633-2079 Fax: +86-10-62304633-2504  
E-mail: cttl@chinattl.com http://www.chinattl.cn

**Body TSL parameters at 5800 MHz**

The following parameters and calculations were applied.

	Temperature	Permittivity	Conductivity
Nominal Body TSL parameters	22.0 °C	48.2	6.00 mho/m
Measured Body TSL parameters	(22.0 ± 0.2) °C	49.0 ± 6 %	5.94 mho/m ± 6 %
Body TSL temperature change during test	<1.0 °C	----	----

**SAR result with Body TSL at 5800 MHz**

SAR averaged over 1 cm <sup>3</sup> (1 g) of Body TSL	Condition	
SAR measured	100 mW input power	7.73 mW / g
SAR for nominal Body TSL parameters	normalized to 1W	77.5 mW /g ± 24.4 % (k=2)
SAR averaged over 10 cm <sup>3</sup> (10 g) of Body TSL	Condition	
SAR measured	100 mW input power	2.17 mW / g
SAR for nominal Body TSL parameters	normalized to 1W	21.8 mW /g ± 24.2 % (k=2)



Add: No.51 Xueyuan Road, Haidian District, Beijing, 100191, China  
Tel: +86-10-62304633-2079 Fax: +86-10-62304633-2504  
E-mail: cttl@chinattl.com http://www.chinattl.cn

**Appendix (Additional assessments outside the scope of CNAS L0570)**

**Antenna Parameters with Head TSL at 5200 MHz**

Impedance, transformed to feed point	47.6Ω - 8.77jΩ
Return Loss	- 20.7dB

**Antenna Parameters with Head TSL at 5300 MHz**

Impedance, transformed to feed point	45.5Ω - 6.82jΩ
Return Loss	- 21.4dB

**Antenna Parameters with Head TSL at 5500 MHz**

Impedance, transformed to feed point	50.7Ω - 7.14jΩ
Return Loss	- 23.0dB

**Antenna Parameters with Head TSL at 5600 MHz**

Impedance, transformed to feed point	55.2Ω - 4.00jΩ
Return Loss	- 24.1dB

**Antenna Parameters with Head TSL at 5800 MHz**

Impedance, transformed to feed point	52.2Ω - 8.20jΩ
Return Loss	- 21.6dB

**Antenna Parameters with Body TSL at 5200 MHz**

Impedance, transformed to feed point	50.8Ω - 10.1jΩ
Return Loss	- 20.0dB

**Antenna Parameters with Body TSL at 5300 MHz**

Impedance, transformed to feed point	48.5Ω - 8.56jΩ
Return Loss	- 21.1dB



Add: No.51 Xueyuan Road, Haidian District, Beijing, 100191, China  
Tel: +86-10-62304633-2079 Fax: +86-10-62304633-2504  
E-mail: cttl@chinattl.com http://www.chinattl.cn

**Antenna Parameters with Body TSL at 5500 MHz**

Impedance, transformed to feed point	54.9Ω - 6.85jΩ
Return Loss	- 21.9dB

**Antenna Parameters with Body TSL at 5600 MHz**

Impedance, transformed to feed point	56.6Ω - 2.29jΩ
Return Loss	- 23.7dB

**Antenna Parameters with Body TSL at 5800 MHz**

Impedance, transformed to feed point	56.7Ω - 8.10jΩ
Return Loss	- 20.2dB

**General Antenna Parameters and Design**

Electrical Delay (one direction)	1.313 ns
----------------------------------	----------

After long term use with 100W radiated power, only a slight warming of the dipole near the feedpoint can be measured.

The dipole is made of standard semirigid coaxial cable. The center conductor of the feeding line is directly connected to the second arm of the dipole. The antenna is therefore short-circuited for DC-signals. On some of the dipoles, small end caps are added to the dipole arms in order to improve matching when loaded according to the position as explained in the "Measurement Conditions" paragraph. The SAR data are not affected by this change. The overall dipole length is still according to the Standard. No excessive force must be applied to the dipole arms, because they might bend or the soldered connections near the feedpoint may be damaged.

**Additional EUT Data**

Manufactured by	SPEAG
-----------------	-------



Add: No.51 Xueyuan Road, Haidian District, Beijing, 100191, China  
Tel: +86-10-62304633-2079 Fax: +86-10-62304633-2504  
E-mail: cttl@chinattl.com http://www.chinattl.cn

**Antenna Parameters with Body TSL at 5500 MHz**

Impedance, transformed to feed point	54.9Ω - 6.85jΩ
Return Loss	- 21.9dB

**Antenna Parameters with Body TSL at 5600 MHz**

Impedance, transformed to feed point	56.6Ω - 2.29jΩ
Return Loss	- 23.7dB

**Antenna Parameters with Body TSL at 5800 MHz**

Impedance, transformed to feed point	56.7Ω - 8.10jΩ
Return Loss	- 20.2dB

**General Antenna Parameters and Design**

Electrical Delay (one direction)	1.313 ns
----------------------------------	----------

After long term use with 100W radiated power, only a slight warming of the dipole near the feedpoint can be measured.

The dipole is made of standard semirigid coaxial cable. The center conductor of the feeding line is directly connected to the second arm of the dipole. The antenna is therefore short-circuited for DC-signals. On some of the dipoles, small end caps are added to the dipole arms in order to improve matching when loaded according to the position as explained in the "Measurement Conditions" paragraph. The SAR data are not affected by this change. The overall dipole length is still according to the Standard. No excessive force must be applied to the dipole arms, because they might bend or the soldered connections near the feedpoint may be damaged.

**Additional EUT Data**

Manufactured by	SPEAG
-----------------	-------





Add: No.51 Xueyuan Road, Haidian District, Beijing, 100191, China  
Tel: +86-10-62304633-2079 Fax: +86-10-62304633-2504  
E-mail: cttl@chinattl.com http://www.chinattl.cn

**Dipole Calibration /Pin=100mW, d=10mm, f=5500 MHz/Zoom Scan,**  
**dist=1.4mm (8x8x7)/Cube 0:** Measurement grid: dx=4mm, dy=4mm, dz=1.4mm  
Reference Value = 57.80 V/m; Power Drift = 0.02 dB  
Peak SAR (extrapolated) = 34.3 W/kg  
**SAR(1 g) = 8.24 W/kg; SAR(10 g) = 2.37 W/kg**  
Maximum value of SAR (measured) = 19.6 W/kg

**Dipole Calibration /Pin=100mW, d=10mm, f=5600 MHz/Zoom Scan,**  
**dist=1.4mm (8x8x7)/Cube 0:** Measurement grid: dx=4mm, dy=4mm, dz=1.4mm  
Reference Value = 57.89 V/m; Power Drift = 0.04 dB  
Peak SAR (extrapolated) = 35.7 W/kg  
**SAR(1 g) = 8.16 W/kg; SAR(10 g) = 2.34 W/kg**  
Maximum value of SAR (measured) = 20.0 W/kg

**Dipole Calibration /Pin=100mW, d=10mm, f=5800 MHz/Zoom Scan,**  
**dist=1.4mm (8x8x7)/Cube 0:** Measurement grid: dx=4mm, dy=4mm, dz=1.4mm  
Reference Value = 53.56 V/m; Power Drift = -0.06 dB  
Peak SAR (extrapolated) = 35.0 W/kg  
**SAR(1 g) = 7.85 W/kg; SAR(10 g) = 2.25 W/kg**  
Maximum value of SAR (measured) = 19.7 W/kg

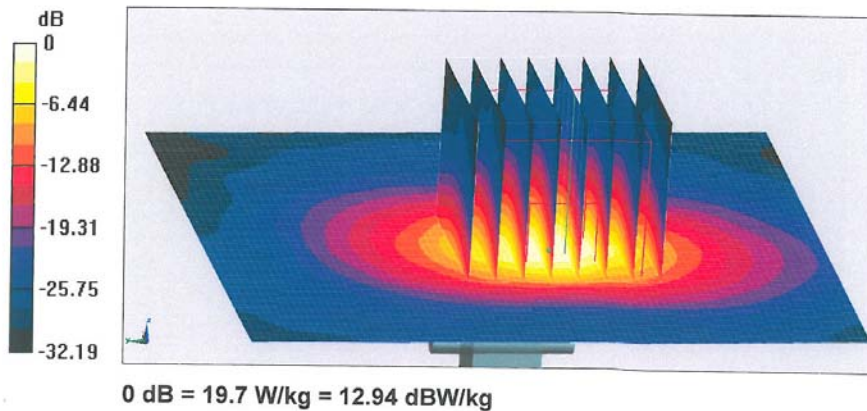



Add: No.51 Xueyuan Road, Haidian District, Beijing, 100191, China  
Tel: +86-10-62304633-2079 Fax: +86-10-62304633-2504  
E-mail: cttl@chinattl.com http://www.chinattl.cn

**Impedance Measurement Plot for Head TSL**

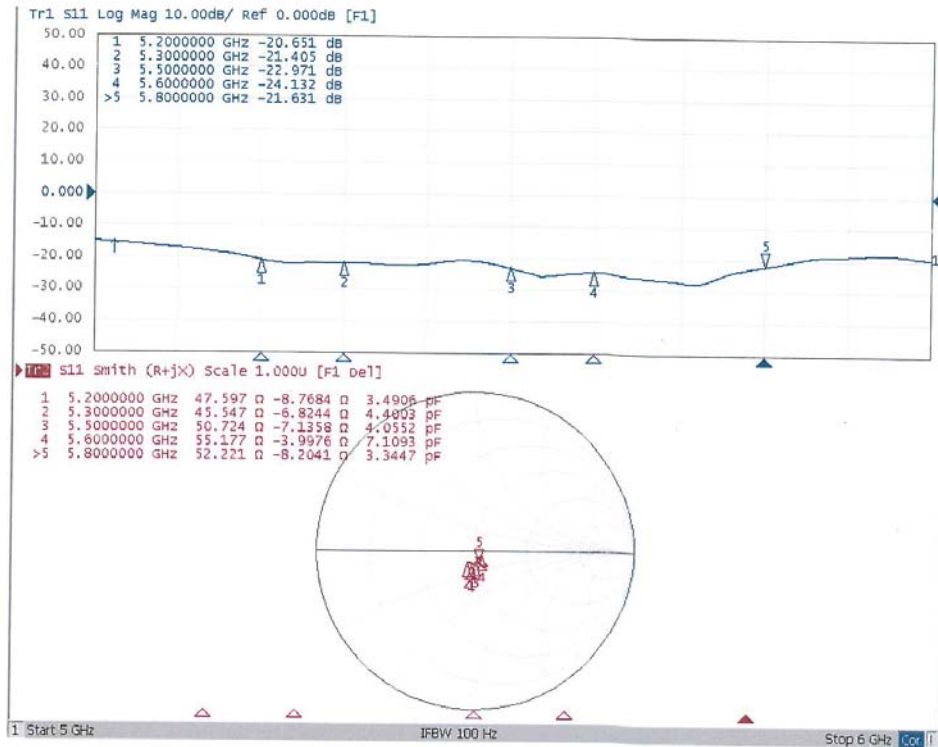



Add: No.51 Xueyuan Road, Haidian District, Beijing, 100191, China  
Tel: +86-10-62304633-2079 Fax: +86-10-62304633-2504  
E-mail: cttl@chinattl.com http://www.chinattl.cn

**DASY5 Validation Report for Body TSL**

Date: 09.25.2017

Test Laboratory: CTTL, Beijing, China

**DUT: Dipole 5GHz; Type: D5GHzV2; Serial: D5GHzV2 - SN: 1079**

Communication System: CW; Frequency: 5200 MHz, Frequency: 5300 MHz,  
Frequency: 5500 MHz, Frequency: 5600 MHz, Frequency: 5800 MHz,  
Medium parameters used: f = 5200 MHz;  $\sigma = 5.382$  mho/m;  $\epsilon_r = 49.47$ ;  $\rho = 1000$   
kg/m<sup>3</sup>, Medium parameters used: f = 5300 MHz;  $\sigma = 5.498$  mho/m;  $\epsilon_r = 49.21$ ;  $\rho =$   
1000 kg/m<sup>3</sup>, Medium parameters used: f = 5500 MHz;  $\sigma = 5.722$  mho/m;  $\epsilon_r = 49.03$ ;  
 $\rho = 1000$  kg/m<sup>3</sup>, Medium parameters used: f = 5600 MHz;  $\sigma = 5.733$  mho/m;  $\epsilon_r =$   
48.37;  $\rho = 1000$  kg/m<sup>3</sup>, Medium parameters used: f = 5800 MHz;  $\sigma = 5.935$  mho/m;  
 $\epsilon_r = 48.99$ ;  $\rho = 1000$  kg/m<sup>3</sup>,

Phantom section: Center Section

Measurement Standard: DASY5 (IEEE/IEC/ANSI C63.19-2007)

DASY5 Configuration:

- Probe: EX3DV4 - SN3846; ConvF(4.95,4.95,4.95); Calibrated: 1/13/2017,  
ConvF(4.95,4.95,4.95); Calibrated: 1/13/2017,ConvF(4.18,4.18,4.18);  
Calibrated: 1/13/2017, ConvF(4.18,4.18,4.18); Calibrated: 1/13/2017,  
ConvF(4.53,4.53,4.53); Calibrated: 1/13/2017,
- Sensor-Surface: 1.4mm (Mechanical Surface Detection)
- Electronics: DAE4 Sn1331; Calibrated: 2017/1/19
- Phantom: Triple Flat Phantom 5.1C; Type: QD 000 P51 CA; Serial: 1161/3
- Measurement SW: DASY52, Version 52.10 (0); SEMCAD X Version 14.6.10  
(7417)

**Dipole Calibration /Pin=100mW, d=10mm, f=5200 MHz/Zoom Scan,**  
**dist=1.4mm (8x8x7)/Cube 0:** Measurement grid: dx=4mm, dy=4mm, dz=1.4mm  
Reference Value = 55.18 V/m; Power Drift = 0.01 dB  
Peak SAR (extrapolated) = 30.0 W/kg  
**SAR(1 g) = 7.52 W/kg; SAR(10 g) = 2.12 W/kg**  
Maximum value of SAR (measured) = 18.2 W/kg

**Dipole Calibration /Pin=100mW, d=10mm, f=5300 MHz/Zoom Scan,**  
**dist=1.4mm (8x8x7)/Cube 0:** Measurement grid: dx=4mm, dy=4mm, dz=1.4mm  
Reference Value = 53.94 V/m; Power Drift = 0.01 dB  
Peak SAR (extrapolated) = 31.9 W/kg  
**SAR(1 g) = 7.68 W/kg; SAR(10 g) = 2.18 W/kg**  
Maximum value of SAR (measured) = 18.3 W/kg



Add: No.51 Xueyuan Road, Haidian District, Beijing, 100191, China  
Tel: +86-10-62304633-2079 Fax: +86-10-62304633-2504  
E-mail: cttl@chinattl.com http://www.chinattl.cn

**Dipole Calibration /Pin=100mW, d=10mm, f=5500 MHz/Zoom Scan,**  
**dist=1.4mm (8x8x7)/Cube 0:** Measurement grid: dx=4mm, dy=4mm, dz=1.4mm  
Reference Value = 66.70 V/m; Power Drift = -0.03 dB  
Peak SAR (extrapolated) = 33.7 W/kg  
**SAR(1 g) = 8.22 W/kg; SAR(10 g) = 2.35 W/kg**  
Maximum value of SAR (measured) = 19.8 W/kg

**Dipole Calibration /Pin=100mW, d=10mm, f=5600 MHz/Zoom Scan,**  
**dist=1.4mm (8x8x7)/Cube 0:** Measurement grid: dx=4mm, dy=4mm, dz=1.4mm  
Reference Value = 67.75 V/m; Power Drift = 0.01 dB  
Peak SAR (extrapolated) = 34.2 W/kg  
**SAR(1 g) = 8.08 W/kg; SAR(10 g) = 2.3 W/kg**  
Maximum value of SAR (measured) = 19.3 W/kg

**Dipole Calibration /Pin=100mW, d=10mm, f=5800 MHz/Zoom Scan,**  
**dist=1.4mm (8x8x7)/Cube 0:** Measurement grid: dx=4mm, dy=4mm, dz=1.4mm  
Reference Value = 68.20 V/m; Power Drift = 0.05 dB  
Peak SAR (extrapolated) = 33.3 W/kg  
**SAR(1 g) = 7.73 W/kg; SAR(10 g) = 2.17 W/kg**  
Maximum value of SAR (measured) = 18.3 W/kg

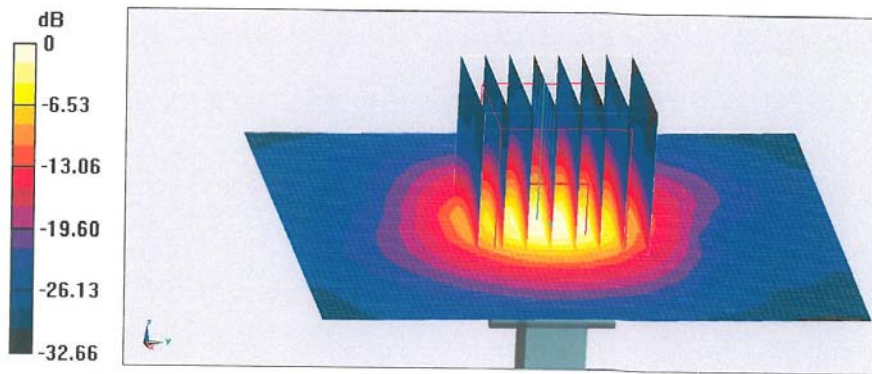

0 dB = 18.3 W/kg = 12.62 dBW/kg

-----End of the test report-----