



CFR 47 FCC PART 15 SUBPART E

TEST REPORT

For

MODEL NUMBER: CP3667AT

FCC ID: R38YLCP3667AT

REPORT NUMBER: 4789517523-4

ISSUE DATE: July 16, 2020

Prepared for

**Yulong Computer Telecommunication Scientific (Shenzhen) Co., Ltd
Building B, Boton Science Park, Chaguang Road, Xili Town, Nanshan District,
Shenzhen**

Prepared by

**UL Verification Services (Guangzhou) Co., Ltd, Song Shan Lake Branch
Building 10, Innovation Technology Park, No. 1, Li Bin Road, Song Shan Lake
Hi-Tech Development Zone Dongguan, People's Republic of China**

Tel: +86 769 22038881

Fax: +86 769 33244054

Website: www.ul.com



Revision History

<u>Rev.</u>	<u>Issue Date</u>	<u>Revisions</u>	<u>Revised By</u>
V0	06/30/2020	Initial Issue	Kebo.zhang
V1	07/16/2020	Revised report to address TCB's questions	Kebo.zhang



Summary of Test Results			
Clause	Test Items	FCC Rules	Test Results
1	6dB/26dB Bandwidth	FCC 15.407 (a)&(e)	PASS
2	99% Occupied Bandwidth	RSS-Gen Clause 6.6	PASS
3	Maximum Conducted Output Power	FCC 15.407 (a)	PASS
4	Power Spectral Density	FCC 15.407 (a)	PASS
5	Radiated Bandedge and Spurious Emission	FCC 15.407 (b) FCC 15.209 FCC 15.205	PASS
6	Conducted Emission Test For AC Power Port	FCC 15.207	PASS
7	Frequency Stability	FCC 15.407 (g)	PASS
8	Dynamic Frequency Selection	FCC 15.407 (h)	PASS
9	Antenna Requirement	FCC 15.203	PASS
<p>Note:</p> <p>1. This test report is only published to and used by the applicant, and it is not for evidence purpose in China.</p> <p>2. The measurement result for the sample received is <Pass> according to < CFR 47 FCC PART 15 SUBPART E >> ISED RSS-247 > when <Accuracy Method> decision rule is applied.</p>			



TABLE OF CONTENTS

1. ATTESTATION OF TEST RESULTS	6
2. TEST METHODOLOGY	7
3. FACILITIES AND ACCREDITATION	7
4. CALIBRATION AND UNCERTAINTY	8
4.1. <i>MEASURING INSTRUMENT CALIBRATION</i>	8
4.2. <i>MEASUREMENT UNCERTAINTY</i>	8
5. EQUIPMENT UNDER TEST	9
5.1. <i>DESCRIPTION OF EUT</i>	9
5.2. <i>MAXIMUM AV POWER</i>	10
5.3. <i>CHANNEL LIST</i>	11
5.4. <i>THE WORSE CASE POWER SETTING PARAMETER</i>	13
5.5. <i>THE WORSE CASE CONFIGURATIONS</i>	14
5.6. <i>DESCRIPTION OF AVAILABLE ANTENNAS</i>	15
5.7. <i>DESCRIPTION OF TEST SETUP</i>	16
6. MEASURING INSTRUMENT AND SOFTWARE USED	17
7. ANTENNA PORT TEST RESULTS	19
7.1. <i>ON TIME AND DUTY CYCLE</i>	19
7.2. <i>6/26/99% dB BANDWIDTH</i>	20
7.3. <i>MAXIMUM CONDUCTED OUTPUT POWER</i>	22
7.4. <i>POWER SPECTRAL DENSITY</i>	24
8. RADIATED TEST RESULTS	26
8.1. <i>802.11a 20 MODE</i>	32
8.1.1. <i>UNII-1 BAND</i>	32
8.1.2. <i>UNII-2A BAND</i>	48
8.1.3. <i>UNII-2C BAND</i>	64
8.1.4. <i>UNII-3 BAND</i>	82
8.2. <i>802.11ac VHT20 MODE</i>	98
8.2.1. <i>UNII-1 BAND</i>	98
8.2.2. <i>UNII-2A BAND</i>	114
8.2.3. <i>UNII-2C BAND</i>	130
8.2.4. <i>UNII-3 BAND</i>	148
8.3. <i>802.11ac VHT40 MODE</i>	164
8.3.1. <i>UNII-1 BAND</i>	164
8.3.2. <i>UNII-2A BAND</i>	176
8.3.3. <i>UNII-2C BAND</i>	188



8.3.1.	UNII-3 BAND	206
8.4.	802.11ac VHT80 MODE.....	218
8.4.1.	UNII-1 BAND	218
8.4.2.	UNII-2A BAND.....	226
8.4.3.	UNII-2C BAND	234
8.4.4.	UNII-3 BAND	248
8.5.	SPURIOUS EMISSIONS 18~26GHz.....	254
8.5.1.	802.11a 20 MOD	254
8.6.	SPURIOUS EMISSIONS 26~40GHz.....	256
8.6.1.	802.11a 20 MODE.....	256
8.7.	SPURIOUS EMISSIONS 30M ~ 1 GHz.....	258
8.7.1.	802.11a 20 MODE.....	258
8.8.	SPURIOUS EMISSIONS BELOW 30M.....	260
8.8.1.	802.11a 20 MODE.....	260
9.	AC POWER LINE CONDUCTED EMISSIONS	263
9.1.	802.11n 20 MODE.....	264
10.	FREQUENCY STABILITY	266
11.	DYNAMIC FREQUENCY SELECTION	268
12.	ANTENNA REQUIREMENTS.....	272
12.1.	Appendix A1: Emission Bandwidth	273
12.1.1.	Test Result.....	273
12.1.2.	Test Graphs	275
12.2.	Appendix A2: Occupied channel bandwidth	305
12.2.1.	Test Result.....	305
12.2.2.	Test Graphs	307
12.3.	Appendix A3: Min emission bandwidth	337
12.3.1.	Test Result.....	337
12.3.2.	Test Graphs	338
12.4.	Appendix B: Maximum conducted output power.....	343
12.4.1.	Test Result.....	343
12.5.	Appendix C: Maximum power spectral density	345
12.5.1.	Test Result.....	345
12.5.2.	Test Graphs	346
12.6.	Appendix D: Duty Cycle	365
12.6.1.	Test Result.....	365
12.6.2.	Test Graphs	366
12.7.	Appendix E: Frequency Stability	368
12.7.1.	Test Result.....	368
12.8.	Appendix F: Dynamic Frequency Selection	370
12.8.1.	Test Result.....	370



1. ATTESTATION OF TEST RESULTS

Applicant Information

Company Name: Yulong Computer Telecommunication Scientific (Shenzhen) Co., Ltd
Address: Building B, Boton Science Park, Chaguang Road, Xili Town, Nanshan District, Shenzhen

Manufacturer Information

Company Name: Yulong Computer Telecommunication Scientific (Shenzhen) Co., Ltd
Address: Building B, Boton Science Park, Chaguang Road, Xili Town, Nanshan District, Shenzhen

EUT Information

EUT Name: Tablet
Model: CP3667AT
Sample Received Date: June 12, 2020
Sample Status: Normal
Sample ID: 3120775
Date of Tested: June 12, 2020 ~ July 16, 2020

APPLICABLE STANDARDS	
STANDARD	TEST RESULTS
CFR 47 FCC PART 15 SUBPART E	PASS

Prepared By:

Kebo Zhang
Project Engineer

Checked By:

Shawn Wen
Laboratory Leader

Approved By:

Stephen Guo
Laboratory Manager



2. TEST METHODOLOGY

The tests documented in this report were performed in accordance with ANSI C63.10-2013, CFR 47 FCC Part 2, CFR 47 FCC Part 15, KDB 789033 D02 v02r01, KDB414788 D01 Radiated Test Site v01, KDB 905462 D02 UNII DFS Compliance Procedures New Rules v02 and KDB 905462 D03 UNII clients without radar detection New Rules v01r02. KDB 905462 D04 Operational Modes for DFS Testing New Rules v01

3. FACILITIES AND ACCREDITATION

Accreditation Certificate	<p>A2LA (Certificate No.: 4102.01) UL Verification Services (Guangzhou) Co., Ltd. Song Shan Lake Branch. has been assessed and proved to be in compliance with A2LA.</p> <p>FCC (FCC Designation No.: CN1187) UL Verification Services (Guangzhou) Co., Ltd. Song Shan Lake Branch. Has been recognized to perform compliance testing on equipment subject to the Commission's Declaration of Conformity (DoC) and Certification rules</p> <p>ISED(Company No.: 21320) UL Verification Services (Guangzhou) Co., Ltd. Song Shan Lake Branch. has been registered and fully described in a report filed with ISED. The Company Number is 21320.</p> <p>VCCI (Registration No.: G-20019, R-20004, C-20012 and T-20011) UL Verification Services (Guangzhou) Co., Ltd. Song Shan Lake Branch. has been assessed and proved to be in compliance with VCCI, the Membership No. is 3793. Facility Name: Chamber D, the VCCI registration No. is G-20019 and R-20004 Shielding Room B , the VCCI registration No. is C-20012 and T-20011</p>
---------------------------	---

Note 1: All tests measurement facilities use to collect the measurement data are located at Building 10, Innovation Technology Park, Song Shan Lake Hi tech Development Zone, Dongguan, 523808, China

Note 2: The test anechoic chamber in UL Verification Services (Guangzhou) Co., Ltd. Song Shan Lake Branch had been calibrated and compared to the open field sites and the test anechoic chamber is shown to be equivalent to or worst case from the open field site.

Note 3: For below 30MHz, lab had performed measurements at test anechoic chamber and comparing to measurements obtained on an open field site. And these measurements below 30MHz had been correlated to measurements performed on an OFS.



4. CALIBRATION AND UNCERTAINTY

4.1. MEASURING INSTRUMENT CALIBRATION

The measuring equipment utilized to perform the tests documented in this report has been calibrated in accordance with the manufacturer's recommendations, and is traceable to recognize national standards.

4.2. MEASUREMENT UNCERTAINTY

Where relevant, the following measurement uncertainty levels have been estimated for tests performed on the apparatus:

Test Item	Uncertainty
Uncertainty for Conduction emission test	3.62dB
Uncertainty for Radiation Emission test(include Fundamental emission) (9KHz-30MHz)	2.2dB
Uncertainty for Radiation Emission test(include Fundamental emission) (30MHz-1GHz)	4.00dB
Uncertainty for Radiation Emission test (1GHz to 40GHz)(include Fundamental emission)	5.78dB (1GHz-18GHz)
	5.23dB (18GHz-26GHz)
	5.64dB (26GHz-40GHz)
Note: This uncertainty represents an expanded uncertainty expressed at approximately the 95% confidence level using a coverage factor of k=2.	



5. EQUIPMENT UNDER TEST

5.1. DESCRIPTION OF EUT

EUT Name	Tablet		
Model	CP3667AT		
Radio Technology	IEEE802.11a 20 IEEE802.11n HT20/n HT40 IEEE802.11ac VHT20/VHT40/VHT80		
Operation frequency	UNII-1/UNII-2A/UNII-2C/UNII-3		
Modulation	OFDM(BPSK,QPSK,16QAM,64QAM, 256QAM only for 11 ac mode)		
Power Supply	Power Adapter	Input	AC100-240V, 50/60Hz, 0.5A Max
		Output	5Vdc--- 3A, 9Vdc--- 2A, 12Vdc--- 1.5A
	Battery	3.82Vdc	



5.2. MAXIMUM AV POWER

UNII-1 BAND

IEE Std.	Frequency (MHz)	Max Power (dBm)
802.11a 20	5150-5250	14.65
802.11n HT20	5150-5250	14.31
802.11n HT40	5150-5250	13.34
802.11ac VHT20	5150-5250	14.23
802.11ac VHT40	5150-5250	13.37
802.11ac VHT80	5150-5250	12.43

UNII-2A BAND

IEE Std.	Frequency (MHz)	Max Power (dBm)
802.11a 20	5250-5350	14.76
802.11n HT20	5250-5350	14.41
802.11n HT40	5250-5350	13.46
802.11ac VHT20	5250-5350	14.36
802.11ac VHT40	5250-5350	13.42
802.11ac VHT80	5250-5350	12.33

UNII-2C BAND

IEE Std.	Frequency (MHz)	Max Power (dBm)
802.11a 20	5470-5725	14.73
802.11n HT20	5470-5725	14.33
802.11n HT40	5470-5725	13.35
802.11ac VHT20	5470-5725	14.40
802.11ac VHT40	5470-5725	13.25
802.11ac VHT80	5470-5725	12.33

UNII-3 BAND

IEE Std. 802.11	Frequency (MHz)	Max Power (dBm)
802.11a 20	5725-5850	14.85
802.11n HT20	5725-5850	14.42
802.11n HT40	5725-5850	13.40
802.11ac VHT20	5725-5850	14.35
802.11ac VHT40	5725-5850	13.40
802.11ac VHT80	5725-5850	12.14



5.3. CHANNEL LIST

20 MHz Bandwidth Channel frequencies		
Band	Channel	Frequency (MHz)
UNII-1	36	5180
	40	5200
	44	5220
	48	5240
UNII-2A	52	5260
	56	5280
	60	5300
	64	5320
UNII-2C	100	5500
	104	5520
	108	5540
	112	5560
	116	5580
	132	5660
	136	5680
	140	5700
UNII-3	149	5745
	153	5765
	157	5785
	161	5805
	165	5825

40 MHz Bandwidth Channel frequencies		
Band	Channel	Frequency (MHz)
UNII-1	38	5190
	46	5230
UNII-2	54	5270
	62	5310
UNII-2C	102	5510
	110	5550
	134	5670
UNII-3	151	5755
	159	5795



80 MHz Bandwidth Channel frequencies		
Band	Channel	Frequency (MHz)
UNII-1	42	5210
UNII-2A	58	5290
UNII-2C	106	5530
	122	5610
UNII-3	155	5775



5.4. THE WORSE CASE POWER SETTING PARAMETER

The Worse Case Power Setting Parameter	
Test Software	QRCT

Mode	Freq	Rate	power setting
a	5180	6M	12.5
	5200	6M	13.0
	5240	6M	13.5
	5260	6M	14.0
	5280	6M	14.5
	5320	6M	14.0
	5500	6M	14.0
	5600	6M	18.0
	5700	6M	10.0
	5745	6M	16.5
	5785	6M	17.0
	5825	6M	16.5
n20	5180	MCS0	12.0
	5200	MCS0	12.5
	5240	MCS0	13.0
	5260	MCS0	13.5
	5280	MCS0	14.0
	5320	MCS0	13.5
	5500	MCS0	14.5
	5600	MCS0	17.5
	5700	MCS0	9.5
	5745	MCS0	16.0
	5785	MCS0	16.5
	5825	MCS0	16.0
ac20	5180	MCS0	12.0
	5200	MCS0	12.5
	5240	MCS0	13.0
	5260	MCS0	13.5
	5280	MCS0	14.0
	5320	MCS0	13.5
	5500	MCS0	14.5
	5600	MCS0	17.5
	5700	MCS0	9.5
	5745	MCS0	16.0
	5785	MCS0	16.5
	5825	MCS0	16.0



n40	5190	MCS0	10.5
	5230	MCS0	11.5
	5270	MCS0	12.5
	5310	MCS0	12.5
	5510	MCS0	11.5
	5590	MCS0	17.0
	5670	MCS0	12.0
	5755	MCS0	15.0
	5795	MCS0	15.0
ac40	5190	MCS0	10.5
	5230	MCS0	11.5
	5270	MCS0	12.5
	5310	MCS0	12.5
	5510	MCS0	11.5
	5590	MCS0	17.0
	5670	MCS0	12.0
	5755	MCS0	15.0
	5795	MCS0	15.0
ac80	5210	MCS0	10.0
	5290	MCS0	11.5
	5530	MCS0	13.0
	5610	MCS0	15.5
	5775	MCS0	14.0

5.5. THE WORSE CASE CONFIGURATIONS

Worst-case data rates as provided by the client were:

802.11a mode: 6 Mbps

802.11n HT20 mode: MCS0

802.11n HT40 mode: MCS0

802.11ac VHT20 mode: MCS0

802.11ac VHT40 mode: MCS0

802.11ac VHT80 mode: MCS0

802.11ac VHT20 and VHT40 mode are different from 802.11nHT20 and HT40 only in control messages, so for these 4 modes, only 802.11ac VHT20 and 802.11ac VHT40 worst case power modes data are recorded in the report .



5.6. DESCRIPTION OF AVAILABLE ANTENNAS

Antenna No.	Frequency Band	Antenna Type	Max Antenna Gain (dBi)
2	UNII1	PIFA	1.2

IEE Std. 802.11	Transmit and Receive Mode	Description
802.11a	<input checked="" type="checkbox"/> 1TX, 1RX	ANT 2 can be used as transmitting/receiving antenna.
802.11n HT20	<input checked="" type="checkbox"/> 1TX, 1RX	ANT 2 can be used as transmitting/receiving antenna.
802.11n HT40	<input checked="" type="checkbox"/> 1TX, 1RX	ANT 2 can be used as transmitting/receiving antenna.
802.11ac VHT20	<input checked="" type="checkbox"/> 1TX, 1RX	ANT 2 can be used as transmitting/receiving antenna.
802.11ac VHT40	<input checked="" type="checkbox"/> 1TX, 1RX	ANT 2 can be used as transmitting/receiving antenna.
802.11ac VHT80	<input checked="" type="checkbox"/> 1TX, 1RX	ANT 2 can be used as transmitting/receiving antenna.

Note:

1. BT&WLAN 2.4G&WLAN 5G cannot transmit simultaneously. (declared by client)

Note:

1. The value of the antenna gain was declared by customer.
2. The EUT have two antenna, antenna 1 only support BT and WIFI2.4G, antenna 2 only support WIFI5G.



5.7. DESCRIPTION OF TEST SETUP

SUPPORT EQUIPMENT

Item	Equipment	Brand Name	Model Name	Remarks
1	Laptop	ThinkPad	E42-80	/

I/O CABLES

Item	Port	Connector Type	Cable Type	Cable Length(m)	Remarks
1	USB	Type-C	NA	0.6	/

ACCESSORIES

Item	Accessory	Brand Name	Model Name	Description
1	TRAVEL CHARGER	N/A	Q3W18-1U-A	Input: AC 100~240V, 50/60Hz, 0.5A Max Output: 5Vdc--- 3A, 9Vdc--- 2A, 12Vdc--- 1.5A,

TEST SETUP

The EUT can work in engineering mode with a software through a Laptop.

SETUP DIAGRAM FOR TESTS

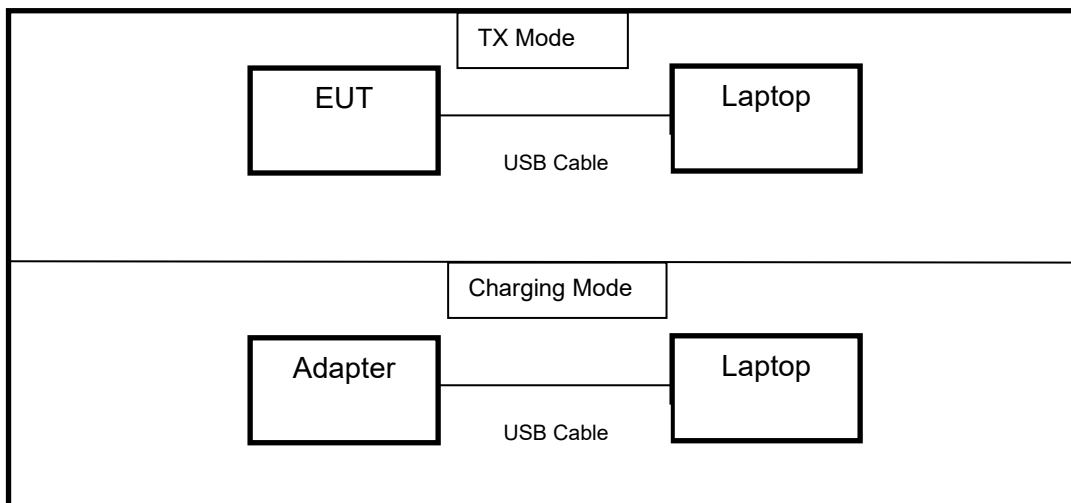



6. MEASURING INSTRUMENT AND SOFTWARE USED

Conducted Emissions						
Instrument						
Used	Equipment	Manufacturer	Model No.	Serial No.	Last Cal.	Next Cal.
<input checked="" type="checkbox"/>	EMI Test Receiver	R&S	ESR3	101961	Dec.05,2019	Dec.05,2020
<input checked="" type="checkbox"/>	Two-Line V-Network	R&S	ENV216	101983	Dec.05,2019	Dec.05,2020
<input checked="" type="checkbox"/>	Artificial Mains Networks	Schwarzbeck	NSLK 8126	8126465	Dec.05,2019	Dec.05,2020
Software						
Used	Description	Manufacturer	Name	Version		
<input checked="" type="checkbox"/>	Test Software for Conducted disturbance	Farad	EZ-EMC	Ver. UL-3A1		
Radiated Emissions						
Instrument						
Used	Equipment	Manufacturer	Model No.	Serial No.	Last Cal.	Next Cal.
<input checked="" type="checkbox"/>	MXE EMI Receiver	KESIGHT	N9038A	MY56400036	Dec.06,2019	Dec.06,2020
<input checked="" type="checkbox"/>	Hybrid Log Periodic Antenna	TDK	HLP-3003C	130960	Sep.17, 2018	Sep.17, 2021
<input checked="" type="checkbox"/>	Preamplifier	HP	8447D	2944A09099	Dec.05,2019	Dec.05,2020
<input checked="" type="checkbox"/>	EMI Measurement Receiver	R&S	ESR26	101377	Dec.05,2019	Dec.05,2020
<input checked="" type="checkbox"/>	Horn Antenna	TDK	HRN-0118	130939	Sep.17, 2018	Sep.17, 2021
<input checked="" type="checkbox"/>	High Gain Horn Antenna	Schwarzbeck	BBHA-9170	691	Aug.11, 2018	Aug.11, 2021
<input checked="" type="checkbox"/>	Preamplifier	TDK	PA-02-0118	TRS-305-00066	Dec.05,2019	Dec.05,2020
<input checked="" type="checkbox"/>	Preamplifier	TDK	PA-02-2	TRS-307-00003	Dec.05,2019	Dec.05,2020
<input checked="" type="checkbox"/>	Preamplifier	TDK	PA-02-3	TRS-308-00002	Dec.05,2019	Dec.05,2020
<input checked="" type="checkbox"/>	Loop antenna	Schwarzbeck	1519B	00008	Jan.07, 2019	Jan.07, 2022
<input checked="" type="checkbox"/>	Band Reject Filter	Wainwright	WRCJV12-5695-5725-5850-5880-40SS	4	Dec.05,2019	Dec.05,2020
<input checked="" type="checkbox"/>	Band Reject Filter	Wainwright	WRCJV20-5120-5150-5350-5380-60SS	2	Dec.05,2019	Dec.05,2020
<input checked="" type="checkbox"/>	Band Reject Filter	Wainwright	WRCJV20-5440-5470-5725-5755-	1	Dec.05,2019	Dec.05,2020



			60SS			
<input checked="" type="checkbox"/>	High Pass Filter	Wainwright	WHKX10-5850-6500-1800-40SS	4	Dec.05,2019	Dec.05,2020
Software						
Used	Description	Manufacturer	Name	Version		
<input checked="" type="checkbox"/>	Test Software for Radiated disturbance	Farad	EZ-EMC	Ver. UL-3A1		
Other instruments						
Used	Equipment	Manufacturer	Model No.	Serial No.	Last Cal.	Next Cal.
<input checked="" type="checkbox"/>	Spectrum Analyzer	Keysight	N9030A	MY55410512	Dec.06,2019	Dec.06,2020
<input checked="" type="checkbox"/>	Power sensor, Power Meter	R&S	OSP120	100921	Dec.06,2019	Dec.06,2020



7. ANTENNA PORT TEST RESULTS

7.1. ON TIME AND DUTY CYCLE

LIMITS

None; for reporting purposes only

TEST SETUP

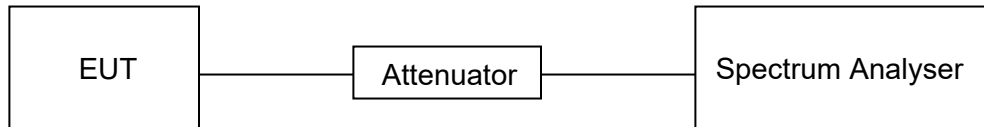

TEST ENVIRONMENT

Temperature	25.5°C	Relative Humidity	59%
Atmosphere Pressure	101kPa	Test Voltage	DC 3.82V

RESULTS

Please refer to Appendix D.



7.2. 6/26/99% dB BANDWIDTH

LIMITS

CFR 47 FCC Part15, Subpart E		
Test Item	Limit	Frequency Range (MHz)
Bandwidth	26 dB Bandwidth	5150-5250
	26 dB Bandwidth	5250-5350
	26 dB Bandwidth	5470-5725
	Minimum 500kHz 6dB Bandwidth	5725-5850

ISED RSS-247		
RSS-Gen Clause 6.6	99% Bandwidth	For reporting purposes only.

TEST PROCEDURE

Connect the UUT to the spectrum analyser and use the following settings:

Center Frequency	The center frequency of the channel under test
Detector	Peak
RBW	For 6dB Bandwidth: RBW=100kHz For 26dB Bandwidth: approximately 1% of the emission bandwidth. For 99dB Bandwidth: approximately 1%~5% of the emission bandwidth.
VBW	For 6dB Bandwidth : VBW=300kHz For 26dB Bandwidth : >3RBW For 99%dB Bandwidth : >3RBW
Trace	Max hold
Sweep	Auto couple

Allow the trace to stabilize and measure the maximum width of the emission that is constrained by the frequencies associated with the two outermost amplitude points (upper and lower frequencies) that are attenuated by 6dB/26dB&99% Occupied Bandwidth relative to the maximum level measured in the fundamental emission.



TEST SETUP

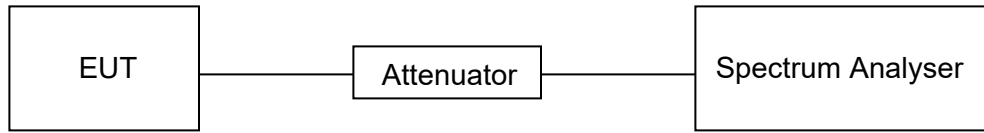

TEST ENVIRONMENT

Temperature	26.5°C	Relative Humidity	63%
Atmosphere Pressure	101kPa	Test Voltage	DC 3.82V

RESULTS

Please refer to Appendix A1&A2&A3.



7.3. MAXIMUM CONDUCTED OUTPUT POWER

LIMITS

CFR 47 FCC Part15, Subpart E		
Test Item	Limit	Frequency Range (MHz)
Conducted Output Power	For FCC client devices:250mW (24dBm)	5150-5250
	Not exceed the lesser of 250 mW or 11 dBm + 10 log B whichever is less where B is the 26 dB emission bandwidth in megahertz	5250-5350
	Not exceed the lesser of 250 mW or 11 dBm + 10 log B whichever is less where B is the 26 dB emission bandwidth in megahertz	5470-5725
	1 Watt (30dBm)	5725-5850

Note: If transmitting antennas of directional gain greater than 6 dBi are used, the maximum conducted output power shall be reduced by the amount in dB that the directional gain of the antenna exceeds 6dBi.



TEST PROCEDURE

Refer to KDB 789033 D02 General UNII Test Procedures New Rules v02r01

Connect the EUT to the a broadband average RF power meter, the power meter shall have a video bandwidth that is greater than or equal to the bandwidth and shall utilize a fast-responding diode detector.

TEST SETUP

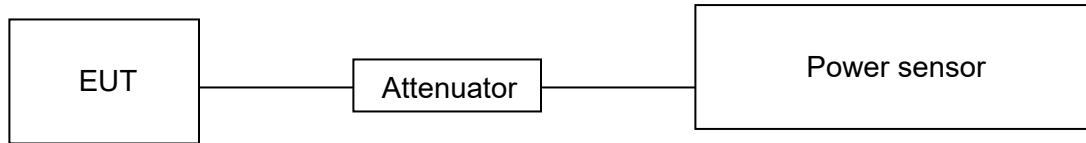

TEST ENVIRONMENT

Temperature	24°C	Relative Humidity	62%
Atmosphere Pressure	101kPa	Test Voltage	DC 3.82V

RESULTS

Please refer to Appendix B.



7.4. POWER SPECTRAL DENSITY

LIMITS

CFR 47 FCC Part15, Subpart E		
Test Item	Limit	Frequency Range (MHz)
Power Spectral Density	For FCC: Other than Mobile and portable:17dBm/MHz Mobile and portable:11dBm/MHz	5150-5250
	11dBm/MHz	5250-5350
	11dBm/MHz	5470-5725
	30dBm/500kHz	5725-5850
Note: 1. If transmitting antennas of directional gain greater than 6 dBi are used, both the maximum conducted output power and the maximum power spectral density shall be reduced by the amount in dB that the directional gain of the antenna exceeds 6dBi.		

TEST PROCEDURE

Connect the UUT to the spectrum analyser and use the following settings:

For U-NII-1, U-NII-2A and U-NII-2C band:

Center Frequency	The center frequency of the channel under test
Detector	RMS
RBW	1MHz
VBW	$\geq 3 \times \text{RBW}$
Span	Encompass the entire emissions bandwidth (EBW) of the signal
Trace	Max hold
Sweep time	Auto

For U-NII-3:

Center Frequency	The center frequency of the channel under test
Detector	RMS
RBW	500kHz
VBW	$\geq 3 \times \text{RBW}$
Span	Encompass the entire emissions bandwidth (EBW) of the signal
Trace	Max hold
Sweep time	Auto

Allow trace to fully stabilize and use the peak marker function to determine the maximum amplitude level within the RBW.



TEST SETUP

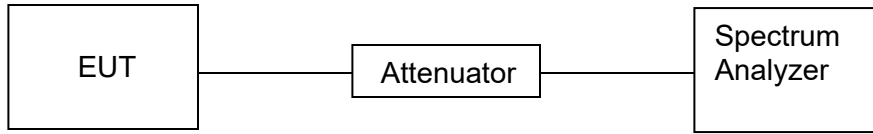

TEST ENVIRONMENT

Temperature	23.5°C	Relative Humidity	63%
Atmosphere Pressure	101kPa	Test Voltage	DC 3.82V

RESULTS

Please refer to Appendix C.



7.4.1.

8. RADIATED TEST RESULTS

LIMITS

Please refer to CFR 47 FCC §15.205, §15.209 and §15.407(b) (4)

Please refer to ISED RSS-GEN Clause 8.9

Radiation Disturbance Test Limit for FCC (Class B)(9kHz-1GHz)

Frequency (MHz)	Field Strength (microvolts/meter)	Measurement Distance (meters)
0.009~0.490	2400/F(kHz)	300
0.490~1.705	24000/F(kHz)	30
1.705~30.0	30	30
30~88	100	3
88~216	150	3
216~960	200	3
960~1000	500	3

Note: 1) At frequencies at or above 30 MHz, measurements may be performed at a distance other than what is specified provided: measurements are not made in the near field except where it can be shown that near field measurements are appropriate due to the characteristics of the device; and it can be demonstrated that the signal levels needed to be measured at the distance employed can be detected by the measurement equipment. Measurements shall not be performed at a distance greater than 30 meters unless it can be further demonstrated that measurements at a distance of 30 meters or less are impractical. When performing measurements at a distance other than that specified, the results shall be extrapolated to the specified distance using an extrapolation factor of 20 dB/decade (inverse linear-distance for field strength measurements; inverse-linear-distance-squared for power density measurements).

(2) At frequencies below 30 MHz, measurements may be performed at a distance closer than that specified in the regulations; however, an attempt should be made to avoid making measurements in the near field. Pending the development of an appropriate measurement procedure for measurements performed below 30 MHz, when performing measurements at a closer distance than specified, the results shall be extrapolated to the specified distance by either making measurements at a minimum of two distances on at least one radial to determine the proper extrapolation factor or by using the square of an inverse linear distance extrapolation factor (40 dB/decade). This paragraph (f) shall not apply to Access BPL devices operating below 30 MHz.



ISED General field strength limits at frequencies below 30 MHz

Table 6 – General field strength limits at frequencies below 30 MHz		
Frequency	Magnetic field strength (H-Field) (µA/m)	Measurement distance (m)
9 - 490 kHz ^{Note 1}	6.37/F (F in kHz)	300
490 - 1705 kHz	63.7/F (F in kHz)	30
1.705 - 30 MHz	0.08	30

Note 1: The emission limits for the ranges 9-90 kHz and 110-490 kHz are based on measurements employing a linear average detector.

IC Restricted bands please refer to ISED RSS-GEN Clause 8.10.
FCC Restricted bands please refer to CFR 47 FCC 15.209.

Radiated emissions which fall in the restricted bands must comply with the radiated emission limits specified as below table.

LIMITS OF RADIATED EMISSION MEASUREMENT (Below 1GHz)			
Frequency Range (MHz)	Field Strength Limit (uV/m) at 3 m	Field Strength Limit (dBuV/m) at 3 m	
		Quasi-Peak	
30 - 88	100	40	
88 - 216	150	43.5	
216 - 960	200	46	
Above 960	500	54	
Above 1000	500	Peak	Average
		74	54

Limits of unwanted emission out of the restricted bands

LIMITS OF RADIATED EMISSION MEASUREMENT (Above 1GHz)		
Frequency Range (MHz)	EIRP Limit	Field Strength Limit (dBuV/m) at 3 m
5150~5250 MHz	PK:-27 (dBm/MHz)	PK:68.2(dBµV/m)
5250~5350 MHz		
5470~5725 MHz		
5725~5850 MHz	PK:-27 (dBm/MHz) *1 PK:10 (dBm/MHz) *2 PK:15.6 (dBm/MHz) *3 PK:27 (dBm/MHz) *4	PK: 68.2(dBµV/m) *1 PK:105.2 (dBµV/m) *2 PK: 110.8(dBµV/m) *3 PK:122.2 (dBµV/m) *4

Note:
*1 beyond 75 MHz or more above of the band edge.
*2 below the band edge increasing linearly to 10 dBm/MHz at 25 MHz above.
*3 below the band edge increasing linearly to a level of 15.6 dBm/MHz at 5 MHz above.
*4 from 5 MHz above or below the band edge increasing linearly to a level of 27 dBm/MHz at the band edge.

TEST SETUP AND PROCEDURE

Below 30MHz

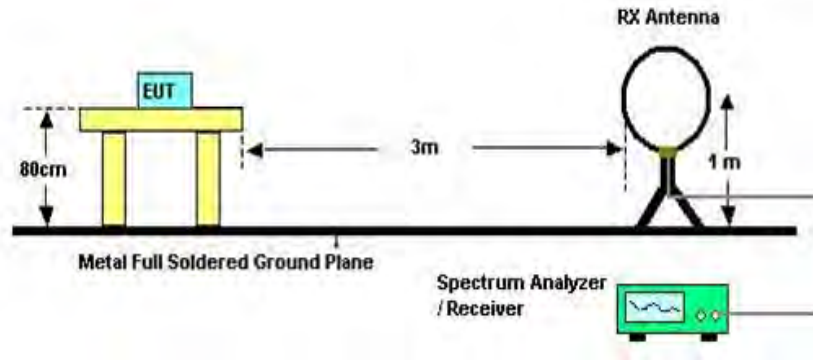

The setting of the spectrum analyser

RBW	200Hz (From 9kHz to 0.15MHz)/ 9kHz (From 0.15MHz to 30MHz)
VBW	200Hz (From 9kHz to 0.15MHz)/ 9kHz (From 0.15MHz to 30MHz)
Sweep	Auto
Detector	Peak/QP/ Average
Trace	Max hold

1. The testing follows the guidelines in ANSI C63.10-2013
2. The EUT was arranged to its worst case and then turntable (from 0 degree to 360 degrees) to find the maximum reading. A pre-amp and a high pass filter are used for the test in order to get better signal level. Both Horizontal, Face-on and Face-off polarizations of the antenna are set to make the measurement.
3. The EUT was placed on a turntable with 0.8 meter above ground.
4. The EUT was set 3 meters from the interference receiving antenna, which was mounted on the top of a variable height antenna tower.
5. For measurement below 1GHz, the initial step in collecting conducted emission data is a spectrum analyzer peak detector mode pre-scanning the measurement frequency range. Significant peaks are then marked and then Quasi Peak detector mode re-measured. If the emission level of the EUT measured by the peak detector is 3 dB lower than the applicable limit, the peak emission level will be reported. Otherwise, the emission measurement will be repeated using the quasi-peak detector and reported.
6. Although these tests were performed other than open field site, adequate comparison measurements were confirmed against 30m open field site. Therefore sufficient tests were made to demonstrate that the alternative site produces results that correlate with the ones of tests made in an open field site based on KDB 414788.

Below 1G

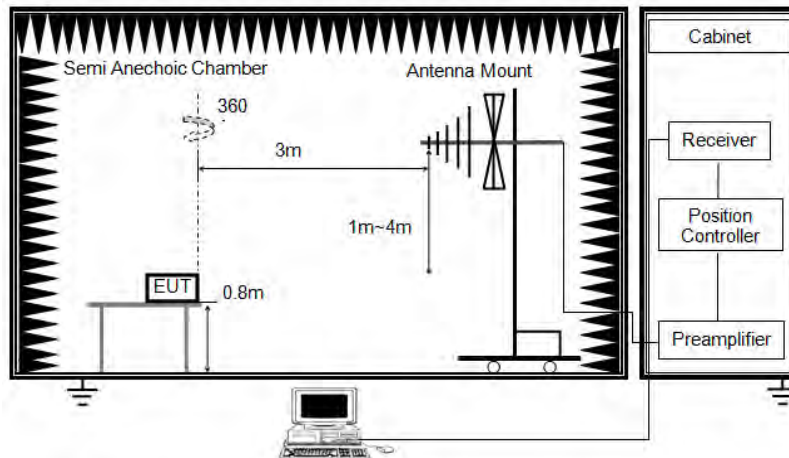

The setting of the spectrum analyser

RBW	120kHz
VBW	300kHz
Sweep	Auto
Detector	Peak/QP
Trace	Max hold

1. The testing follows the guidelines in ANSI C63.10-2013.
2. The EUT was arranged to its worst case and then tune the antenna tower (from 1 m to 4 m) and turntable (from 0 degree to 360 degrees) to find the maximum reading. A pre-amp and a high pass filter are used for the test in order to get better signal level. Both horizontal and vertical polarizations of the antenna are set to make the measurement.
3. The EUT was placed on a turntable with 0.8 meter above ground.
4. The EUT was set 3 meters from the interference receiving antenna, which was mounted on the top of a variable height antenna tower.
5. For measurement below 1GHz, the initial step in collecting conducted emission data is a spectrum analyzer peak detector mode pre-scanning the measurement frequency range. Significant peaks are then marked and then Quasi Peak detector mode re-measured. If the emission level of the EUT measured by the peak detector is 3 dB lower than the applicable limit, the peak emission level will be reported. Otherwise, the emission measurement will be repeated using the quasi-peak detector and reported.

Above 1G

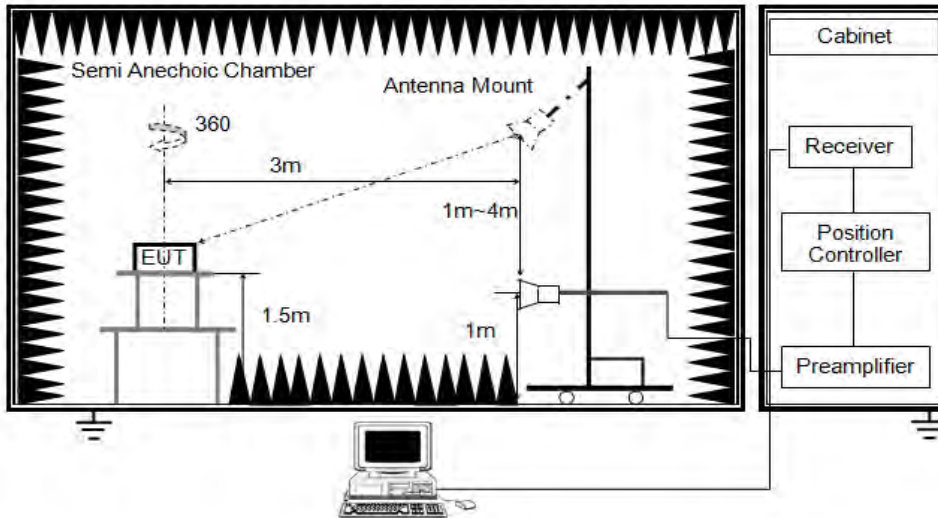

The setting of the spectrum analyser

RBW	1MHz
VBW	PEAK: 3MHz AVG: see note 6
Sweep	Auto
Detector	Peak
Trace	Max hold

1. The testing follows the guidelines in ANSI C63.10-2013.
2. The EUT was arranged to its worst case and then tune the antenna tower (from 1 m to 4 m) and turntable (from 0 degree to 360 degrees) to find the maximum reading. A pre-amp and a high pass filter are used for the test in order to get better signal level. Both horizontal and vertical polarizations of the antenna are set to make the measurement.
3. The EUT was placed on a turntable with 1.5m above ground.
4. The EUT was set 3 meters from the interference receiving antenna, which was mounted on the top of a variable height antenna tower.
5. For measurement above 1GHz, the emission measurement will be measured by the peak detector. This peak level, once corrected, must comply with the limit specified in Section 15.209.
6. For measurements above 1 GHz the resolution bandwidth is set to 1 MHz, then the video bandwidth is set to 3 MHz for peak measurements and 1 MHz resolution bandwidth with 1/T video bandwidth with peak detector for average measurements. For the Duty Cycle please refer to clause 7.1.ON TIME AND DUTY CYCLE.

X axis, Y axis, Z axis positions:

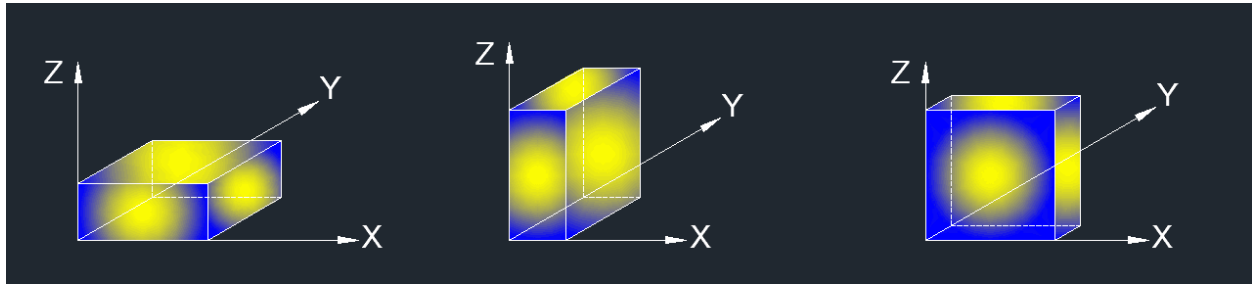

Note 1: For all radiated test, EUT in each of three orthogonal axis emissions had been tested, but only the worst case (X axis) data recorded in the report.

TEST ENVIRONMENT

Temperature	24.7°C	Relative Humidity	61%
Atmosphere Pressure	101kPa	Test Voltage	DC 3.82V



8.1. 802.11a 20 MODE

8.1.1. UNII-1 BAND WORST CASE FOR ANT2

RESTRICTED BANDEDGE LOW CHANNEL

HORIZONTAL RESULTS PEAK

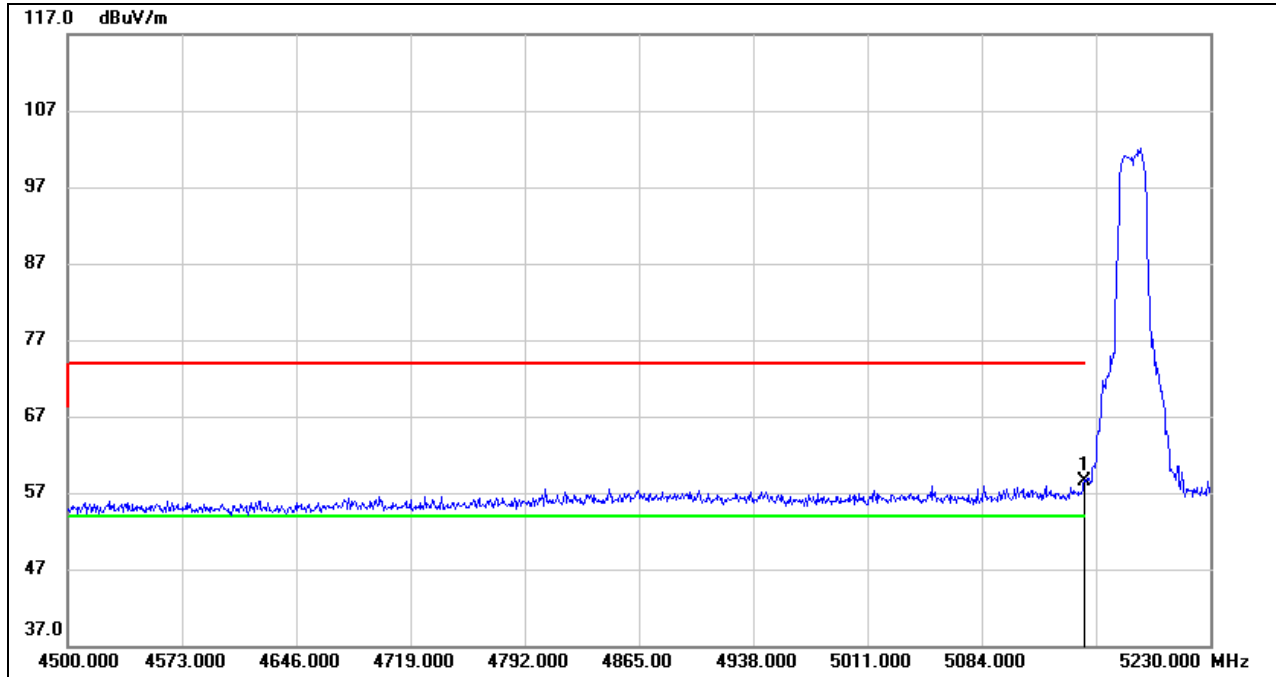

No.	Frequency (MHz)	Reading (dBuV)	Correct (dB/m)	Result (dBuV/m)	Limit (dBuV/m)	Margin (dB)	Remark
1	5150.000	17.97	40.46	58.43	74.00	-15.57	peak

- Note: 1. Measurement = Reading Level + Correct Factor.
 2. If Peak Result complies with AV limit, AV Result is deemed to comply with AV limit.
 3. Peak: Peak detector.
 4. Only the worst case emission will be recorder, if it complies with the limit, the other emissions deemed to comply with the limit.



AVG

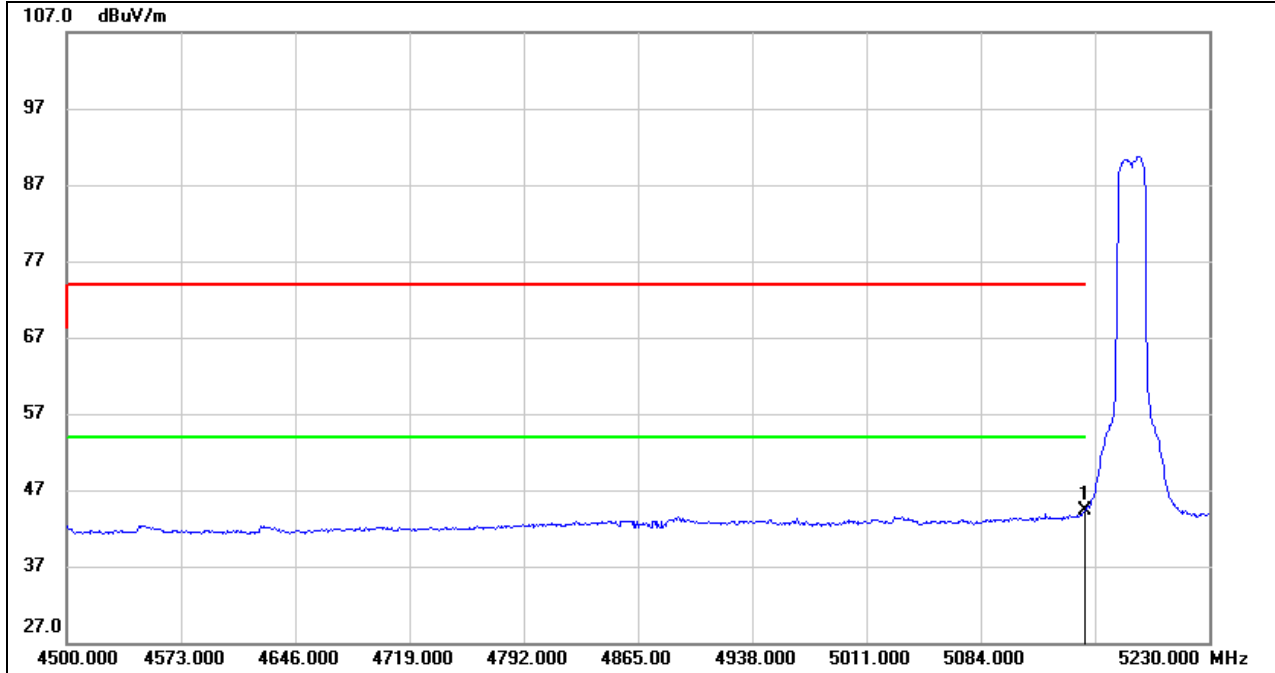

No.	Frequency (MHz)	Reading (dBuV)	Correct (dB/m)	Result (dBuV/m)	Limit (dBuV/m)	Margin (dB)	Remark
1	5150.000	3.93	40.46	44.39	54.00	-9.61	AVG

- Note:
1. Measurement = Reading Level + Correct Factor.
 2. AVG: VBW=1/Ton where: ton is transmit duration.
 3. For duty cycle, please refer to clause 7.1.
 4. Only the worst case emission will be recorder, if it complies with the limit, the other emissions deemed to comply with the limit.



VERTICAL RESULTS
PEAK

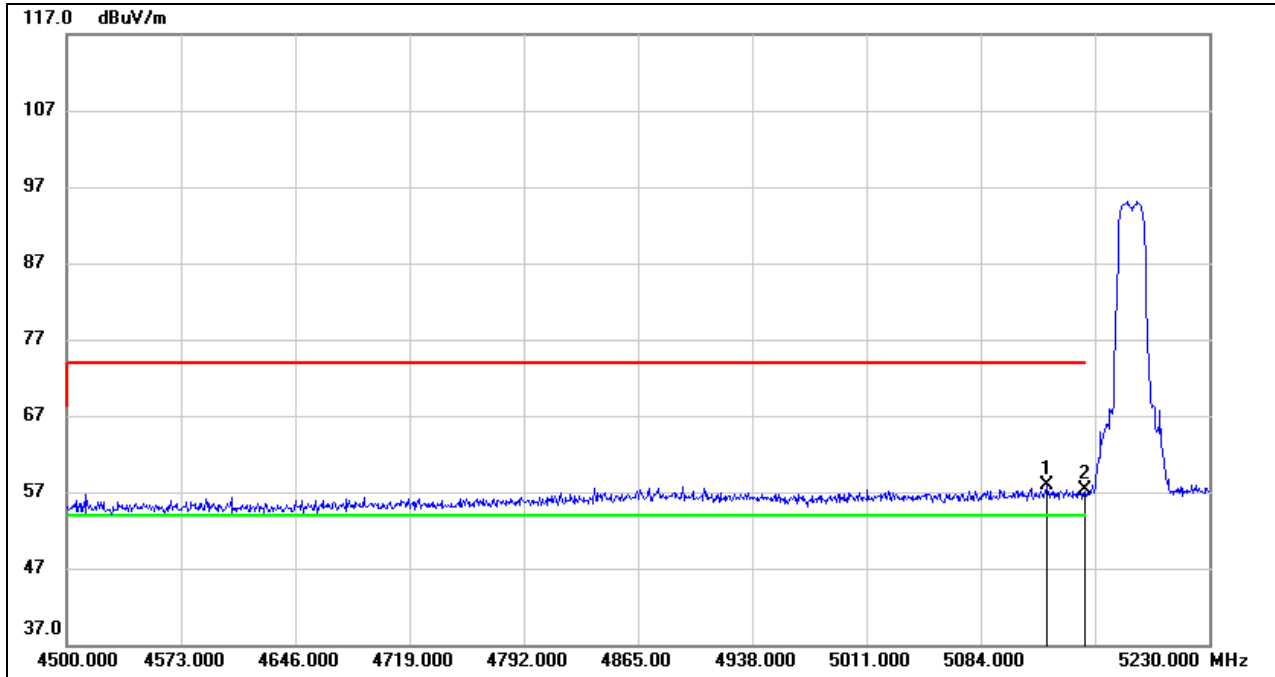

No.	Frequency (MHz)	Reading (dBuV)	Correct (dB/m)	Result (dBuV/m)	Limit (dBuV/m)	Margin (dB)	Remark
1	5126.340	17.55	40.33	57.88	74.00	-16.12	peak
2	5150.000	16.74	40.46	57.20	74.00	-16.80	peak

- Note: 1. Measurement = Reading Level + Correct Factor.
 2. If Peak Result complies with AV limit, AV Result is deemed to comply with AV limit.
 3. Peak: Peak detector.
 4. Only the worst case emission will be recorder, if it complies with the limit, the other emissions deemed to comply with the limit.



AVG

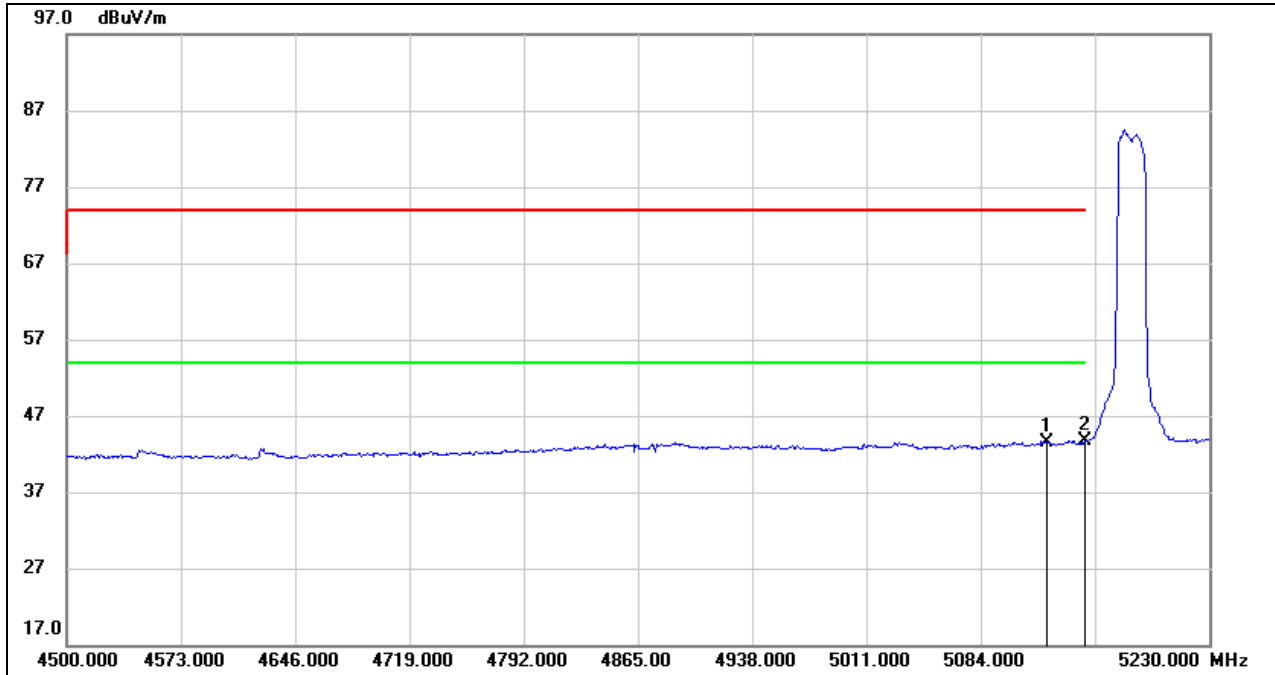

No.	Frequency (MHz)	Reading (dBuV)	Correct (dB/m)	Result (dBuV/m)	Limit (dBuV/m)	Margin (dB)	Remark
1	5126.340	3.19	40.33	43.52	54.00	-10.48	AVG
2	5150.000	3.16	40.46	43.62	54.00	-10.38	AVG

- Note: 1. Measurement = Reading Level + Correct Factor.
 2. AVG: VBW=1/Ton where: ton is transmit duration.
 3. For duty cycle, please refer to clause 7.1.
 4. Only the worst case emission will be recorder, if it complies with the limit, the other emissions deemed to comply with the limit.



HARMONICS AND SPURIOUS EMISSIONS LOW CHANNEL

HORIZONTAL RESULTS
1-7GHz

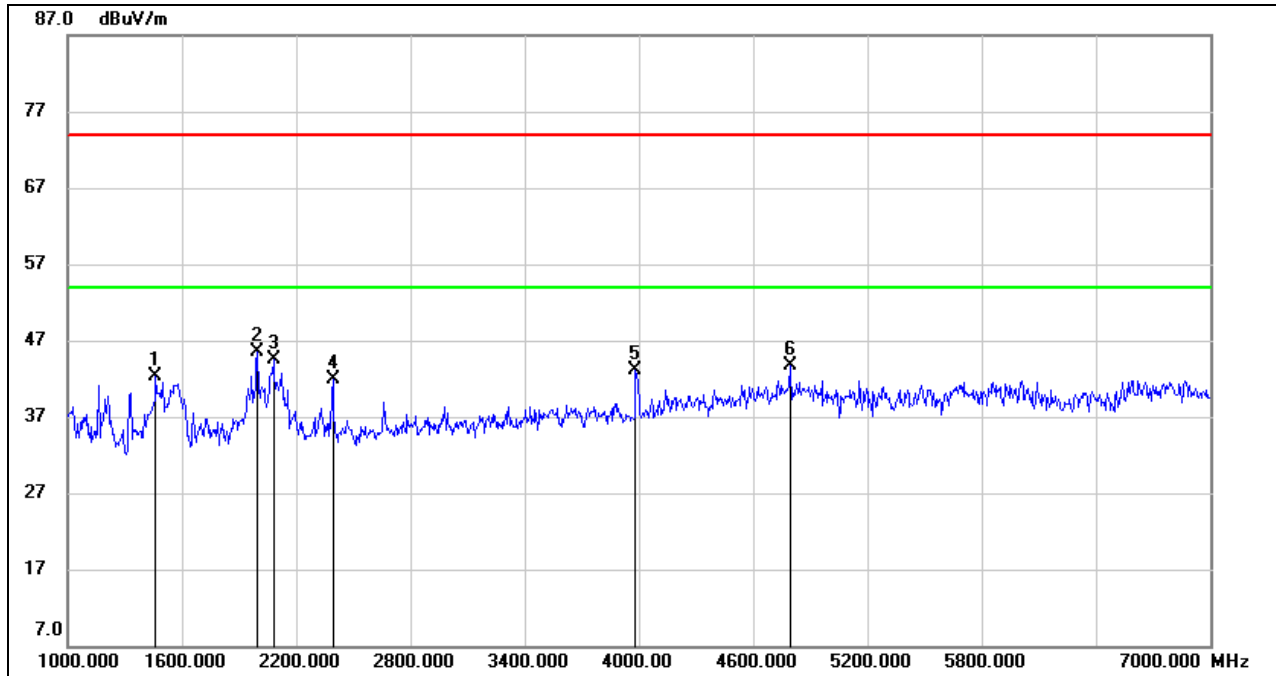

No.	Frequency (MHz)	Reading (dBuV)	Correct (dB/m)	Result (dBuV/m)	Limit (dBuV/m)	Margin (dB)	Remark
1	1462.000	54.71	-12.47	42.24	74.00	-31.76	peak
2	1996.000	55.80	-10.24	45.56	74.00	-28.44	peak
3	2080.000	54.37	-9.82	44.55	74.00	-29.45	peak
4	2392.000	50.55	-8.63	41.92	74.00	-32.08	peak
5	3982.000	46.81	-3.71	43.10	74.00	-30.90	peak
6	4792.000	43.23	0.47	43.70	74.00	-30.30	peak

- Note: 1. Measurement = Reading Level + Correct Factor.
 2. If Peak Result complies with AV limit, AV Result is deemed to comply with AV limit.
 3. Peak: Peak detector.
 4. Filter losses were only considered in the spurious frequency bands and the authorized band was not corrected for Band reject filter losses.
 5. Proper operation of the transmitter prior to adding the filter to the measurement chain.
 6. Owing to the highest peak level of unwanted emission out of the restricted bands complies with the lowest limit(54dBuV/m), so all the test point was deemed to comply with the limits list in the standard.



7-18GHz

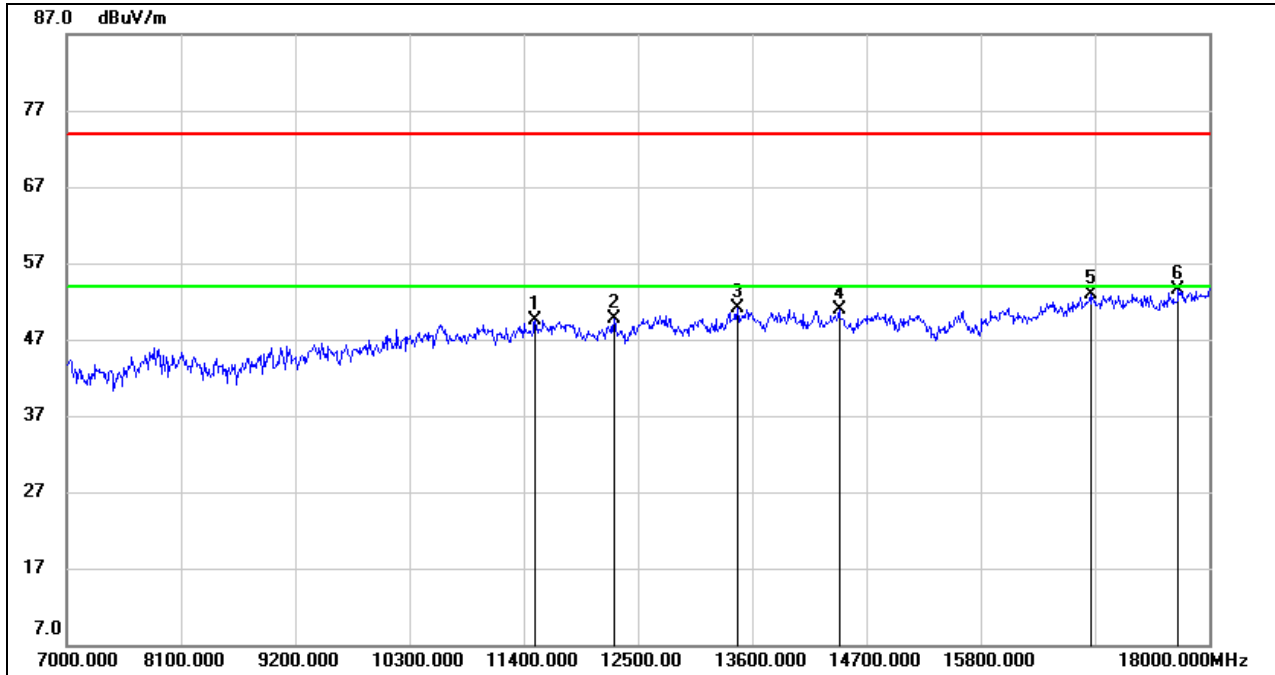

No.	Frequency (MHz)	Reading (dBuV)	Correct (dB/m)	Result (dBuV/m)	Limit (dBuV/m)	Margin (dB)	Remark
1	11510.000	36.20	13.39	49.59	74.00	-24.41	peak
2	12269.000	35.51	14.15	49.66	74.00	-24.34	peak
3	13457.000	35.04	16.02	51.06	74.00	-22.94	peak
4	14436.000	34.36	16.64	51.00	74.00	-23.00	peak
5	16856.000	32.77	20.13	52.90	74.00	-21.10	peak
6	17703.000	30.95	22.52	53.47	74.00	-20.53	peak

Note: 1. Measurement = Reading Level + Correct Factor.
 2. If Peak Result complies with AV limit, AV Result is deemed to comply with AV limit.
 3. Peak: Peak detector.
 4. Filter losses were only considered in the spurious frequency bands and the authorized band was not corrected for HPF losses.
 5. Proper operation of the transmitter prior to adding the filter to the measurement chain.
 6. Owing to the highest peak level of unwanted emission out of the restricted bands complies with the lowest limit(54dBuV/m), so all the test point was deemed to comply with the limits list in the standard.



VERTICAL RESULTS
1-7GHz

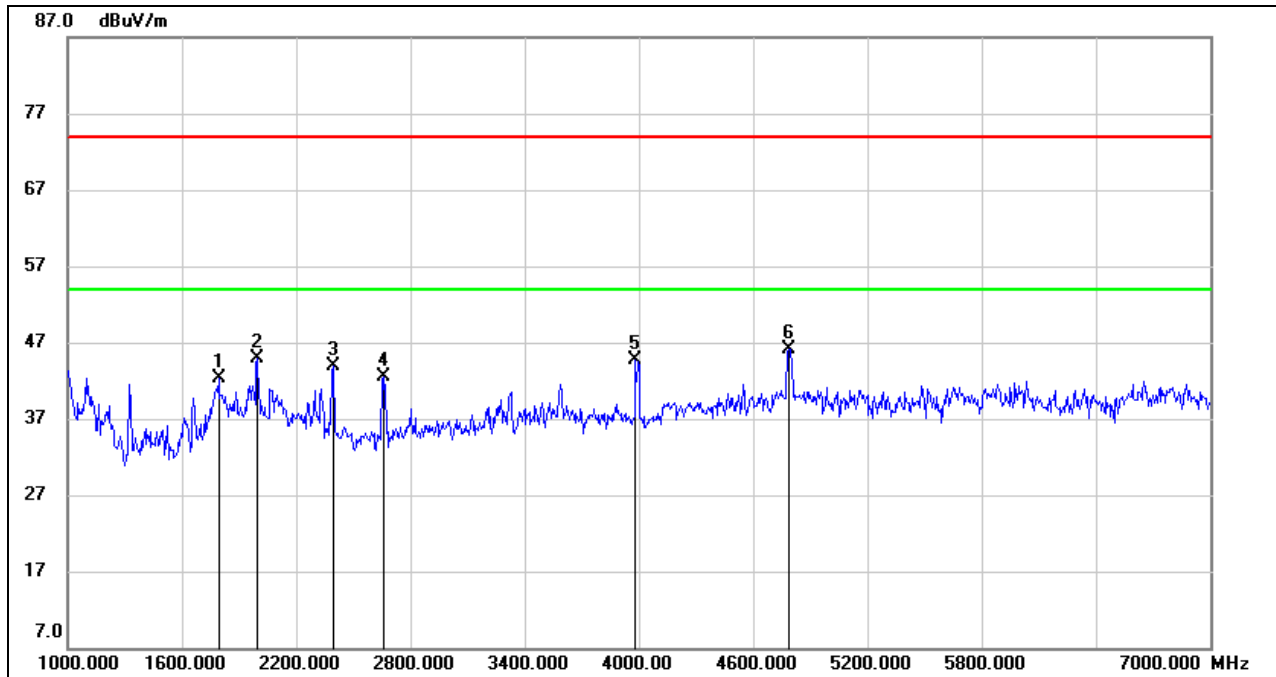

No.	Frequency (MHz)	Reading (dBuV)	Correct (dB/m)	Result (dBuV/m)	Limit (dBuV/m)	Margin (dB)	Remark
1	1792.000	52.50	-10.16	42.34	74.00	-31.66	peak
2	1996.000	55.09	-10.24	44.85	74.00	-29.15	peak
3	2398.000	52.58	-8.62	43.96	74.00	-30.04	peak
4	2656.000	50.42	-7.83	42.59	74.00	-31.41	peak
5	3982.000	48.44	-3.71	44.73	74.00	-29.27	peak
6	4786.000	45.70	0.44	46.14	74.00	-27.86	peak

Note: 1. Measurement = Reading Level + Correct Factor.
 2. If Peak Result complies with AV limit, AV Result is deemed to comply with AV limit.
 3. Peak: Peak detector.
 4. Filter losses were only considered in the spurious frequency bands and the authorized band was not corrected for Band reject filter losses.
 5. Proper operation of the transmitter prior to adding the filter to the measurement chain.
 6. Owing to the highest peak level of unwanted emission out of the restricted bands complies with the lowest limit(54dBuV/m), so all the test point was deemed to comply with the limits list in the standard.



7-18GHz

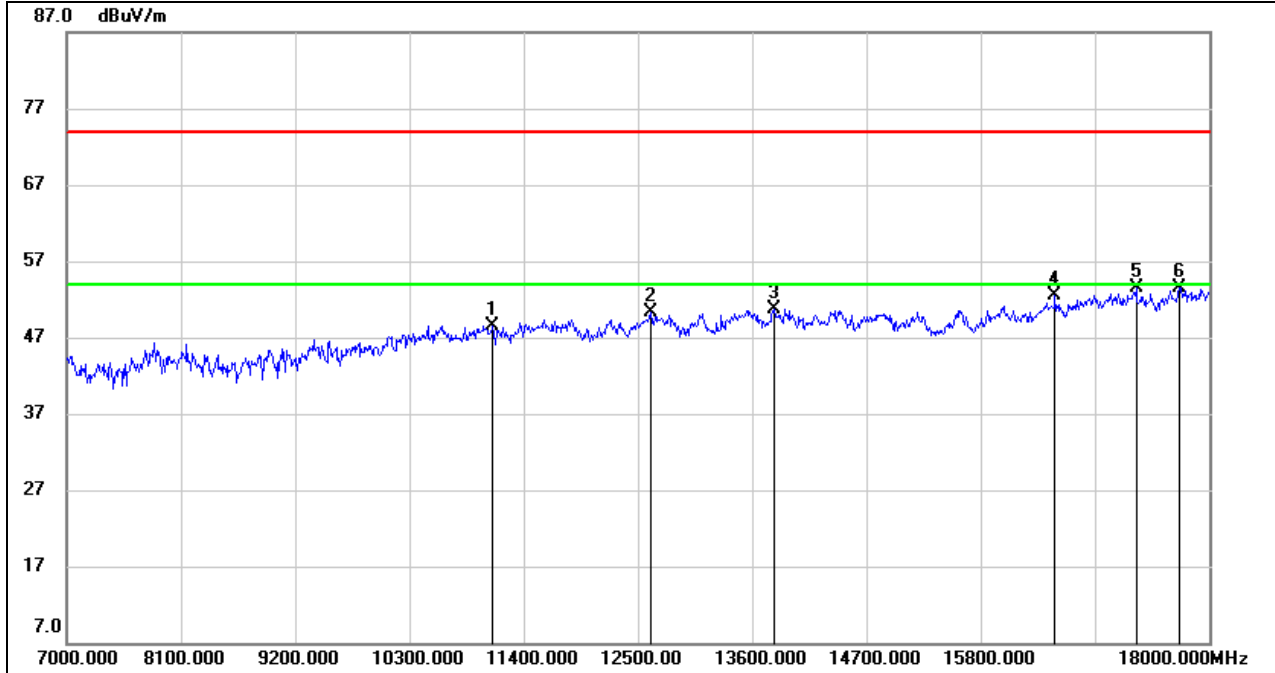

No.	Frequency (MHz)	Reading (dBuV)	Correct (dB/m)	Result (dBuV/m)	Limit (dBuV/m)	Margin (dB)	Remark
1	11103.000	35.94	12.66	48.60	74.00	-25.40	peak
2	12621.000	35.96	14.25	50.21	74.00	-23.79	peak
3	13809.000	33.67	16.99	50.66	74.00	-23.34	peak
4	16515.000	32.80	19.61	52.41	74.00	-21.59	peak
5	17296.000	31.55	21.86	53.41	74.00	-20.59	peak
6	17714.000	30.93	22.62	53.55	74.00	-20.45	peak

Note: 1. Measurement = Reading Level + Correct Factor.
 2. If Peak Result complies with AV limit, AV Result is deemed to comply with AV limit.
 3. Peak: Peak detector.
 4. Filter losses were only considered in the spurious frequency bands and the authorized band was not corrected for HPF losses.
 5. Proper operation of the transmitter prior to adding the filter to the measurement chain.
 6. Owing to the highest peak level of unwanted emission out of the restricted bands complies with the lowest limit(54dBuV/m), so all the test point was deemed to comply with the limits list in the standard.



HARMONICS AND SPURIOUS EMISSIONS MID CHANNEL

HORIZONTAL RESULTS
1-7GHz

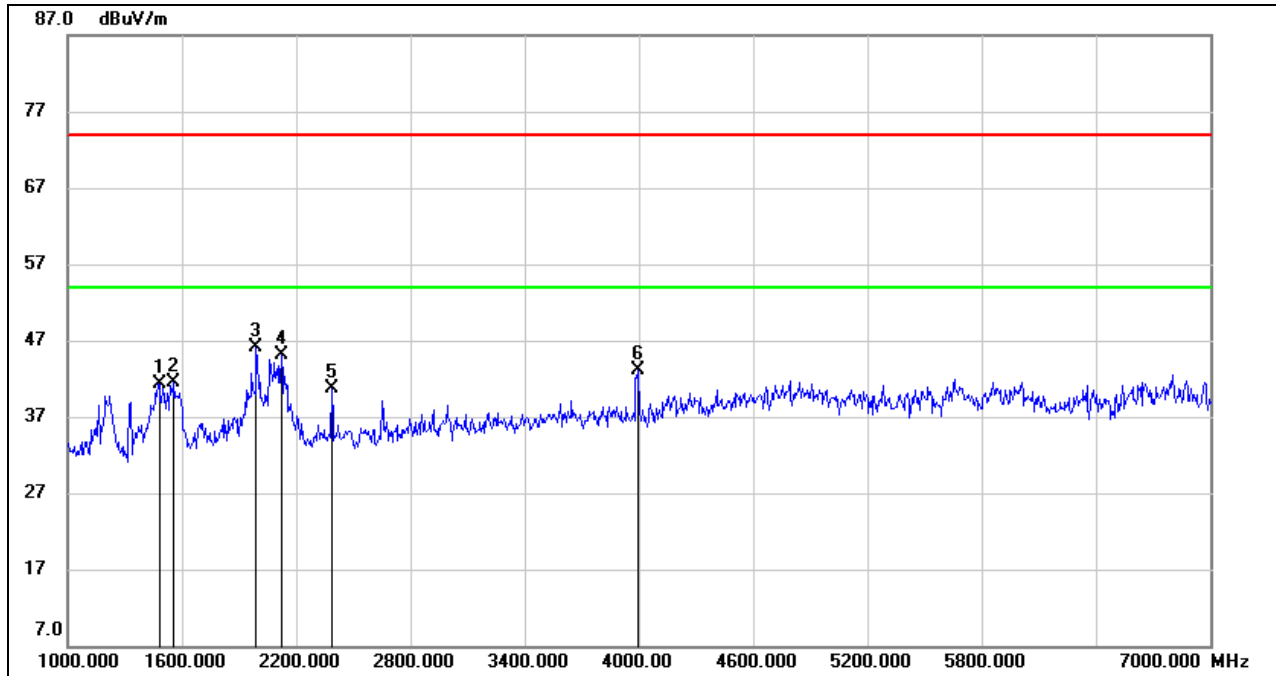

No.	Frequency (MHz)	Reading (dBuV)	Correct (dB/m)	Result (dBuV/m)	Limit (dBuV/m)	Margin (dB)	Remark
1	1480.000	53.74	-12.40	41.34	74.00	-32.66	peak
2	1558.000	53.38	-11.90	41.48	74.00	-32.52	peak
3	1990.000	56.43	-10.24	46.19	74.00	-27.81	peak
4	2122.000	54.70	-9.60	45.10	74.00	-28.90	peak
5	2386.000	49.32	-8.67	40.65	74.00	-33.35	peak
6	3994.000	46.87	-3.73	43.14	74.00	-30.86	peak

- Note: 1. Measurement = Reading Level + Correct Factor.
 2. If Peak Result complies with AV limit, AV Result is deemed to comply with AV limit.
 3. Peak: Peak detector.
 4. Filter losses were only considered in the spurious frequency bands and the authorized band was not corrected for Band reject filter losses.
 5. Proper operation of the transmitter prior to adding the filter to the measurement chain.
 6. Owing to the highest peak level of unwanted emission out of the restricted bands complies with the lowest limit(54dBuV/m), so all the test point was deemed to comply with the limits list in the standard.



7-18GHz

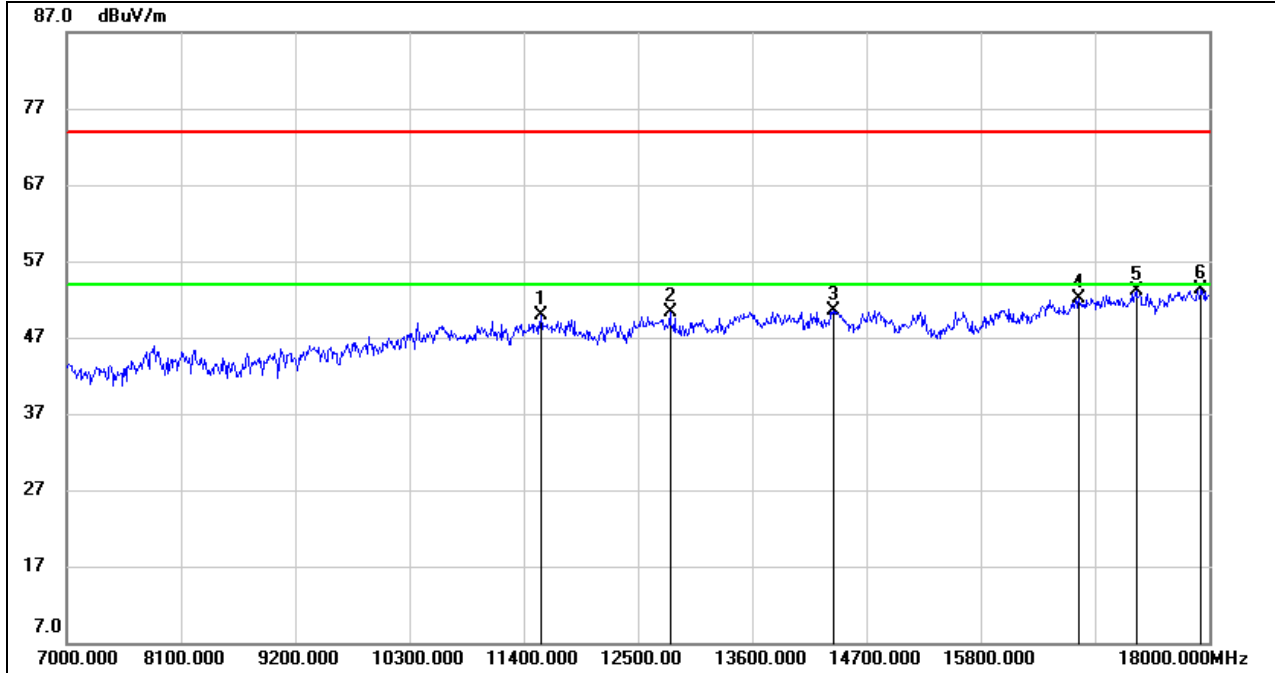

No.	Frequency (MHz)	Reading (dBuV)	Correct (dB/m)	Result (dBuV/m)	Limit (dBuV/m)	Margin (dB)	Remark
1	11565.000	36.35	13.47	49.82	74.00	-24.18	peak
2	12808.000	34.18	16.09	50.27	74.00	-23.73	peak
3	14381.000	33.93	16.62	50.55	74.00	-23.45	peak
4	16746.000	31.95	20.11	52.06	74.00	-21.94	peak
5	17296.000	31.33	21.86	53.19	74.00	-20.81	peak
6	17923.000	29.81	23.42	53.23	74.00	-20.77	peak

Note: 1. Measurement = Reading Level + Correct Factor.
 2. If Peak Result complies with AV limit, AV Result is deemed to comply with AV limit.
 3. Peak: Peak detector.
 4. Filter losses were only considered in the spurious frequency bands and the authorized band was not corrected for HPF losses.
 5. Proper operation of the transmitter prior to adding the filter to the measurement chain.
 6. Owing to the highest peak level of unwanted emission out of the restricted bands complies with the lowest limit(54dBuV/m), so all the test point was deemed to comply with the limits list in the standard.



VERTICAL RESULTS
1-7GHz

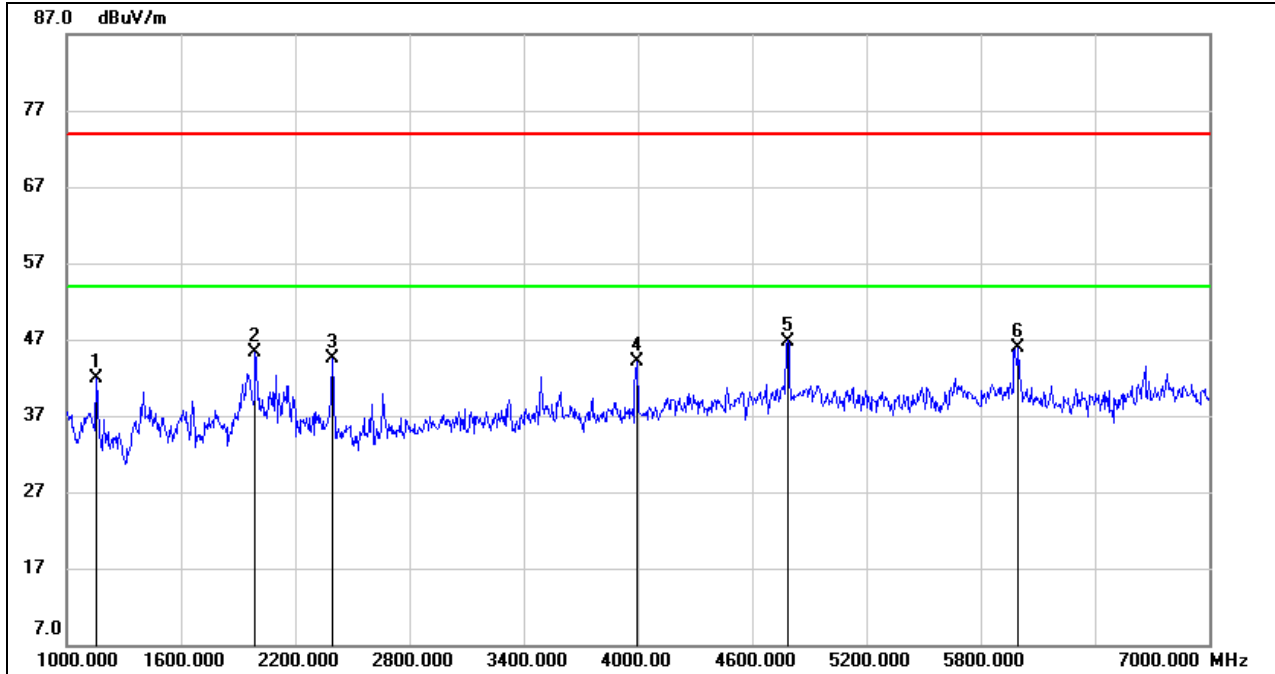

No.	Frequency (MHz)	Reading (dBuV)	Correct (dB/m)	Result (dBuV/m)	Limit (dBuV/m)	Margin (dB)	Remark
1	1156.000	55.28	-13.29	41.99	74.00	-32.01	peak
2	1990.000	55.57	-10.24	45.33	74.00	-28.67	peak
3	2398.000	53.20	-8.62	44.58	74.00	-29.42	peak
4	3994.000	47.88	-3.73	44.15	74.00	-29.85	peak
5	4786.000	46.36	0.44	46.80	74.00	-27.20	peak
6	5998.000	43.30	2.61	45.91	74.00	-28.09	peak

Note: 1. Measurement = Reading Level + Correct Factor.
 2. If Peak Result complies with AV limit, AV Result is deemed to comply with AV limit.
 3. Peak: Peak detector.
 4. Filter losses were only considered in the spurious frequency bands and the authorized band was not corrected for Band reject filter losses.
 5. Proper operation of the transmitter prior to adding the filter to the measurement chain.
 6. Owing to the highest peak level of unwanted emission out of the restricted bands complies with the lowest limit(54dBuV/m), so all the test point was deemed to comply with the limits list in the standard.



7-18GHz

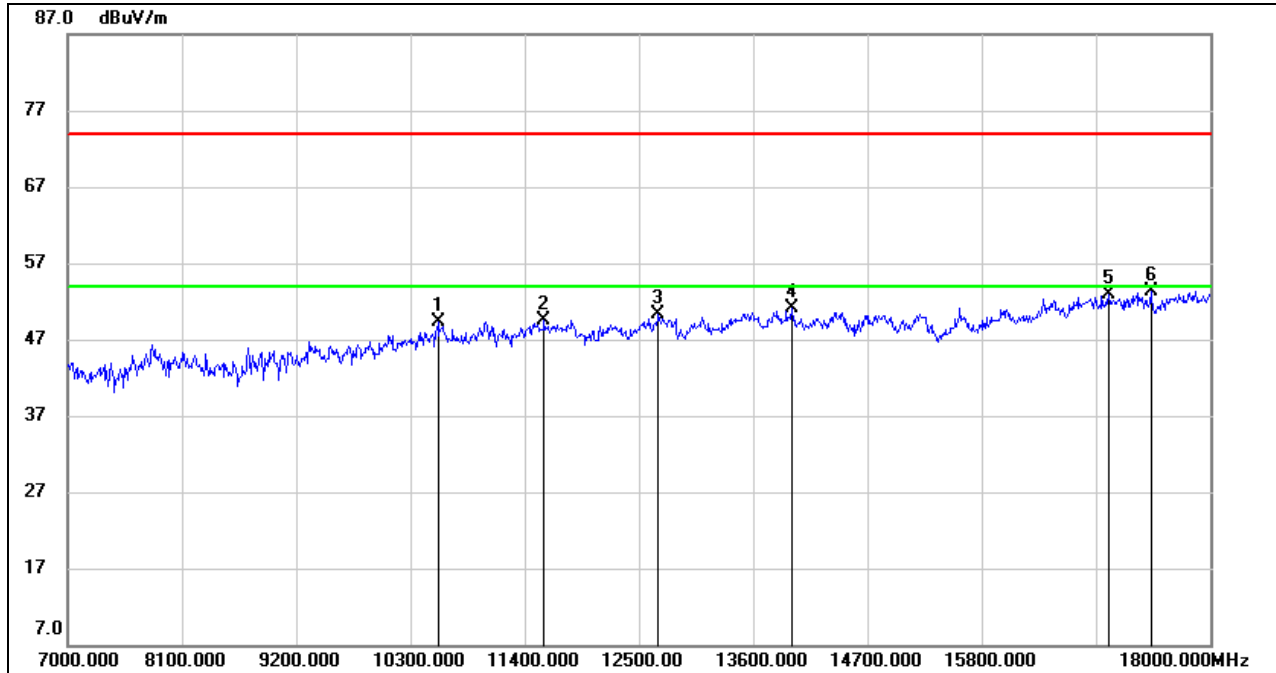

No.	Frequency (MHz)	Reading (dBuV)	Correct (dB/m)	Result (dBuV/m)	Limit (dBuV/m)	Margin (dB)	Remark
1	10564.000	37.18	12.06	49.24	74.00	-24.76	peak
2	11587.000	35.92	13.52	49.44	74.00	-24.56	peak
3	12687.000	35.95	14.40	50.35	74.00	-23.65	peak
4	13974.000	34.98	16.16	51.14	74.00	-22.86	peak
5	17021.000	32.22	20.69	52.91	74.00	-21.09	peak
6	17428.000	31.77	21.50	53.27	74.00	-20.73	peak

Note: 1. Measurement = Reading Level + Correct Factor.
 2. If Peak Result complies with AV limit, AV Result is deemed to comply with AV limit.
 3. Peak: Peak detector.
 4. Filter losses were only considered in the spurious frequency bands and the authorized band was not corrected for HPF losses.
 5. Proper operation of the transmitter prior to adding the filter to the measurement chain.
 6. Owing to the highest peak level of unwanted emission out of the restricted bands complies with the lowest limit(54dBuV/m), so all the test point was deemed to comply with the limits list in the standard.



HARMONICS AND SPURIOUS EMISSIONS HIGH CHANNEL

HORIZONTAL RESULTS
1-7GHz

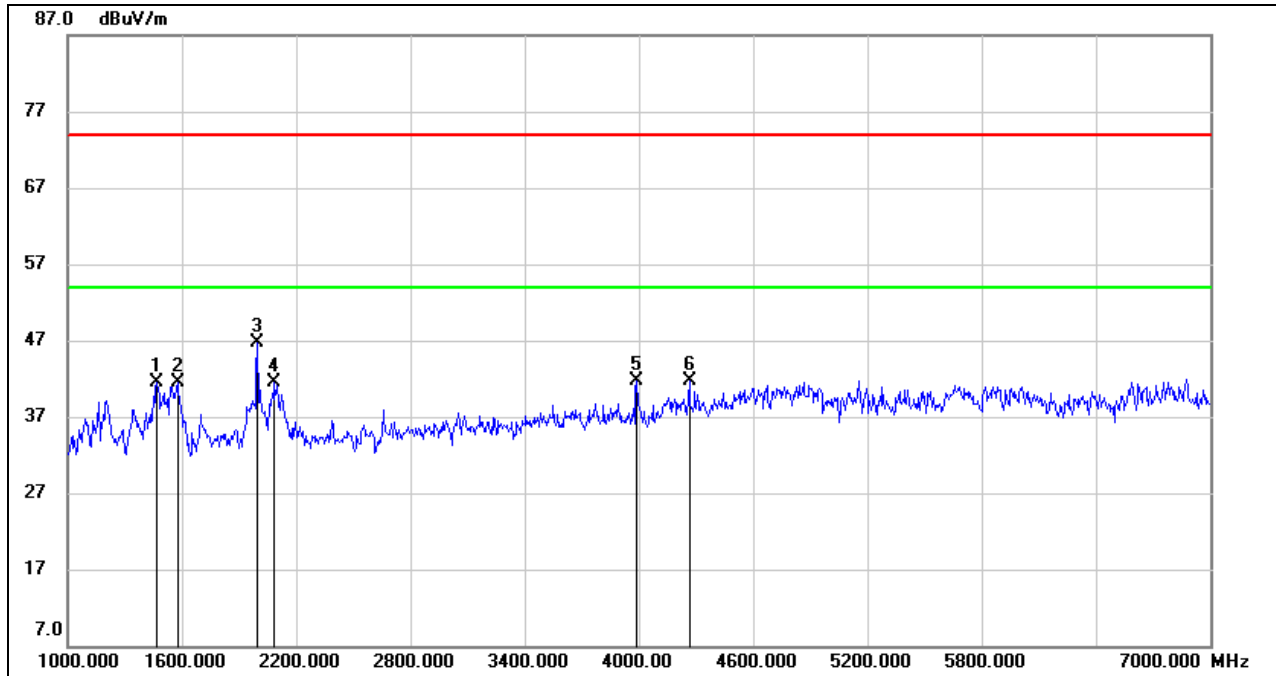

No.	Frequency (MHz)	Reading (dBuV)	Correct (dB/m)	Result (dBuV/m)	Limit (dBuV/m)	Margin (dB)	Remark
1	1468.000	54.02	-12.45	41.57	74.00	-32.43	peak
2	1576.000	53.19	-11.78	41.41	74.00	-32.59	peak
3	1996.000	57.01	-10.24	46.77	74.00	-27.23	peak
4	2086.000	51.30	-9.79	41.51	74.00	-32.49	peak
5	3988.000	45.40	-3.72	41.68	74.00	-32.32	peak
6	4264.000	43.56	-1.84	41.72	74.00	-32.28	peak

Note: 1. Measurement = Reading Level + Correct Factor.
 2. If Peak Result complies with AV limit, AV Result is deemed to comply with AV limit.
 3. Peak: Peak detector.
 4. Filter losses were only considered in the spurious frequency bands and the authorized band was not corrected for Band reject filter losses.
 5. Proper operation of the transmitter prior to adding the filter to the measurement chain.
 6. Owing to the highest peak level of unwanted emission out of the restricted bands complies with the lowest limit(54dBuV/m), so all the test point was deemed to comply with the limits list in the standard.



7-18GHz

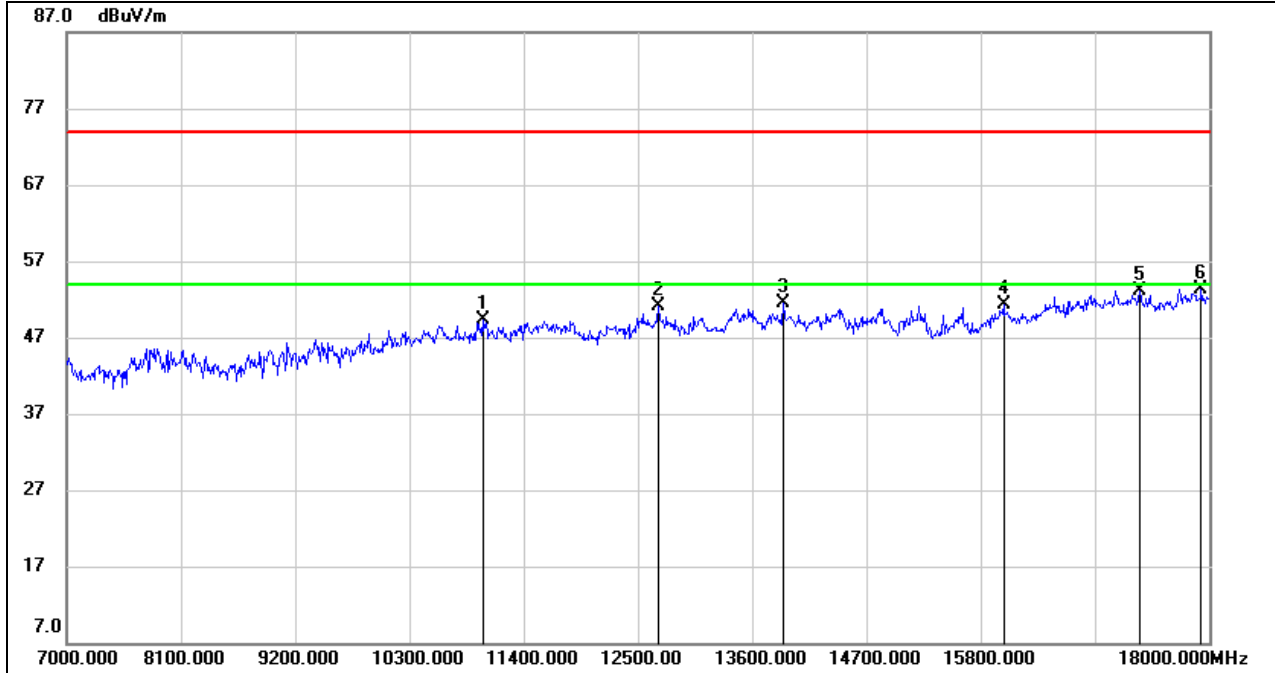

No.	Frequency (MHz)	Reading (dBuV)	Correct (dB/m)	Result (dBuV/m)	Limit (dBuV/m)	Margin (dB)	Remark
1	11004.000	36.64	12.63	49.27	74.00	-24.73	peak
2	12698.000	36.69	14.44	51.13	74.00	-22.87	peak
3	13897.000	35.37	16.20	51.57	74.00	-22.43	peak
4	16020.000	33.46	17.91	51.37	74.00	-22.63	peak
5	17329.000	31.39	21.78	53.17	74.00	-20.83	peak
6	17923.000	29.87	23.42	53.29	74.00	-20.71	peak

Note: 1. Measurement = Reading Level + Correct Factor.
 2. If Peak Result complies with AV limit, AV Result is deemed to comply with AV limit.
 3. Peak: Peak detector.
 4. Filter losses were only considered in the spurious frequency bands and the authorized band was not corrected for HPF losses.
 5. Proper operation of the transmitter prior to adding the filter to the measurement chain.
 6. Owing to the highest peak level of unwanted emission out of the restricted bands complies with the lowest limit(54dBuV/m), so all the test point was deemed to comply with the limits list in the standard.



VERTICAL RESULTS
1-7GHz

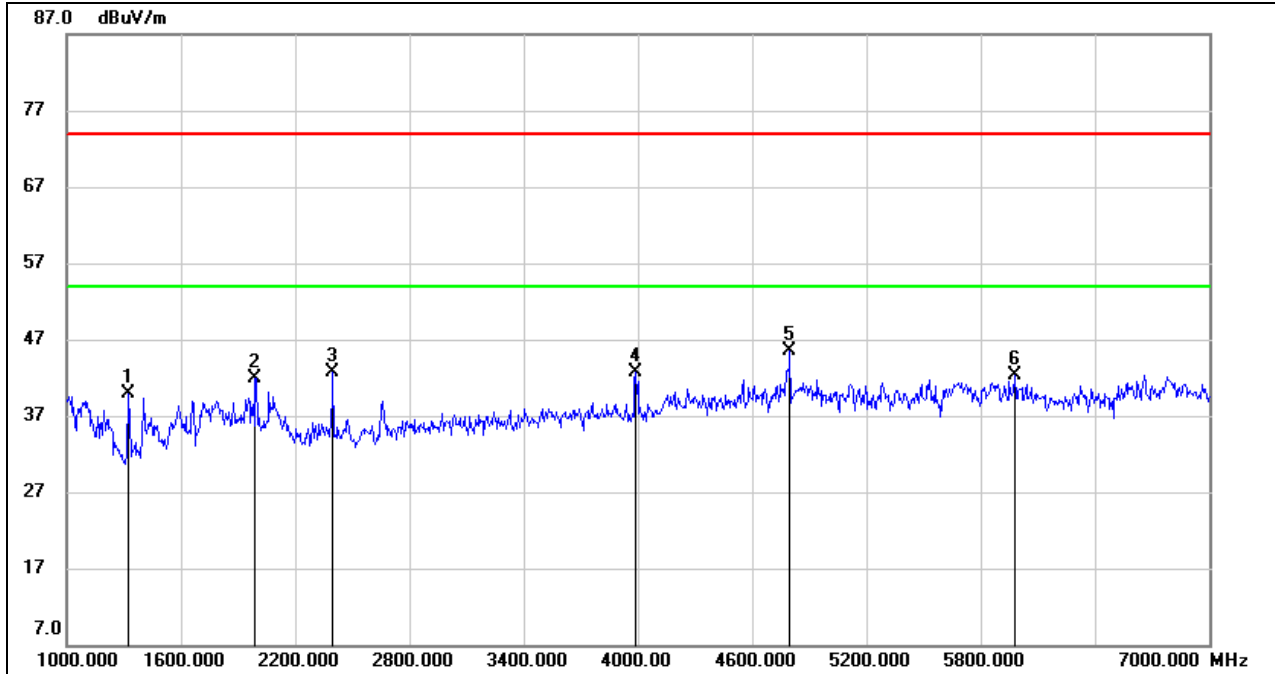

No.	Frequency (MHz)	Reading (dBuV)	Correct (dB/m)	Result (dBuV/m)	Limit (dBuV/m)	Margin (dB)	Remark
1	1324.000	52.72	-12.89	39.83	74.00	-34.17	peak
2	1990.000	52.13	-10.24	41.89	74.00	-32.11	peak
3	2398.000	51.33	-8.62	42.71	74.00	-31.29	peak
4	3988.000	46.45	-3.72	42.73	74.00	-31.27	peak
5	4798.000	44.97	0.52	45.49	74.00	-28.51	peak
6	5980.000	39.68	2.55	42.23	74.00	-31.77	peak

Note: 1. Measurement = Reading Level + Correct Factor.
 2. If Peak Result complies with AV limit, AV Result is deemed to comply with AV limit.
 3. Peak: Peak detector.
 4. Filter losses were only considered in the spurious frequency bands and the authorized band was not corrected for Band reject filter losses.
 5. Proper operation of the transmitter prior to adding the filter to the measurement chain.
 6. Owing to the highest peak level of unwanted emission out of the restricted bands complies with the lowest limit(54dBuV/m), so all the test point was deemed to comply with the limits list in the standard.



7-18GHz

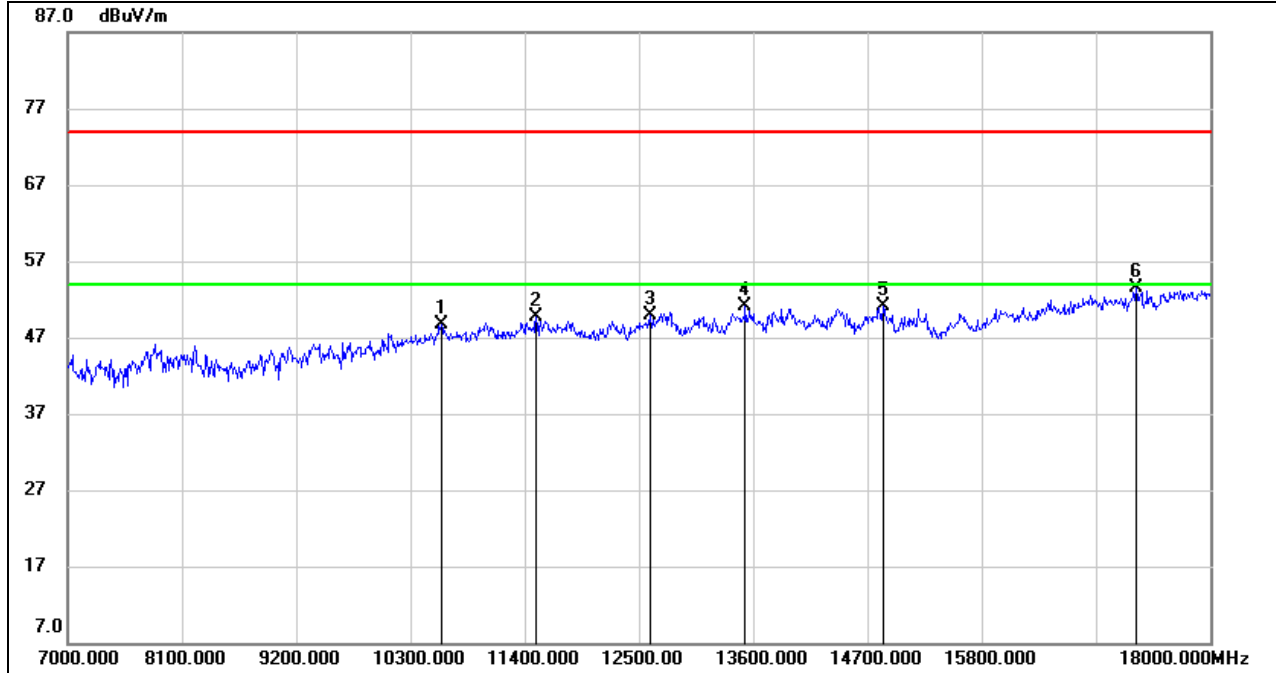

No.	Frequency (MHz)	Reading (dBuV)	Correct (dB/m)	Result (dBuV/m)	Limit (dBuV/m)	Margin (dB)	Remark
1	10597.000	36.19	12.43	48.62	74.00	-25.38	peak
2	11510.000	36.26	13.39	49.65	74.00	-24.35	peak
3	12610.000	35.65	14.21	49.86	74.00	-24.14	peak
4	13523.000	35.13	15.94	51.07	74.00	-22.93	peak
5	14854.000	34.97	16.13	51.10	74.00	-22.90	peak
6	17285.000	31.76	21.79	53.55	74.00	-20.45	peak

Note: 1. Measurement = Reading Level + Correct Factor.
 2. If Peak Result complies with AV limit, AV Result is deemed to comply with AV limit.
 3. Peak: Peak detector.
 4. Filter losses were only considered in the spurious frequency bands and the authorized band was not corrected for HPF losses.
 5. Proper operation of the transmitter prior to adding the filter to the measurement chain.
 6. Owing to the highest peak level of unwanted emission out of the restricted bands complies with the lowest limit(54dBuV/m), so all the test point was deemed to comply with the limits list in the standard.



**8.1.2. UNII-2A BAND
WORST CASE FOR ANT2**

RESTRICTED BANDEDGE HIGH CHANNEL

HORIZONTAL RESULTS
PEAK

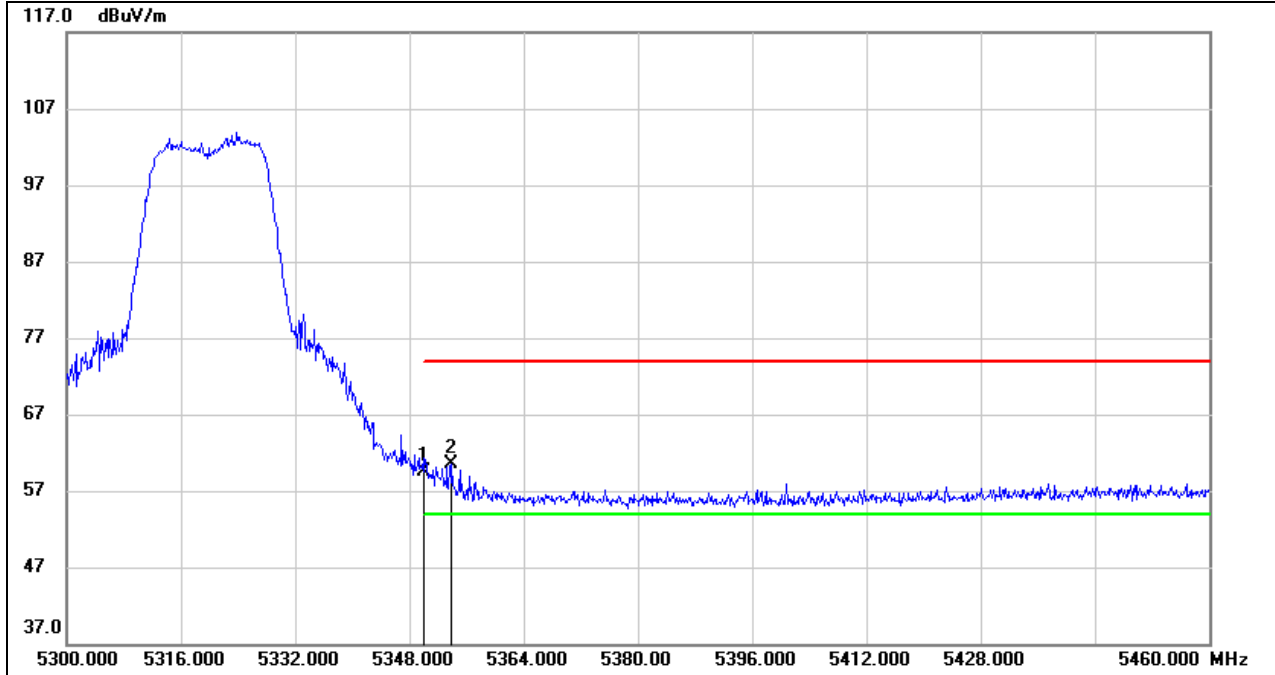

No.	Frequency (MHz)	Reading (dBuV)	Correct (dB/m)	Result (dBuV/m)	Limit (dBuV/m)	Margin (dB)	Remark
1	5350.000	18.84	40.64	59.48	74.00	-14.52	peak
2	5353.920	19.97	40.63	60.60	74.00	-13.40	peak

Note: 1. Measurement = Reading Level + Correct Factor.
 2. If Peak Result complies with AV limit, AV Result is deemed to comply with AV limit.
 3. Peak: Peak detector.
 4. Only the worst case emission will be recorder, if it complies with the limit, the other emissions deemed to comply with the limit.



AVG

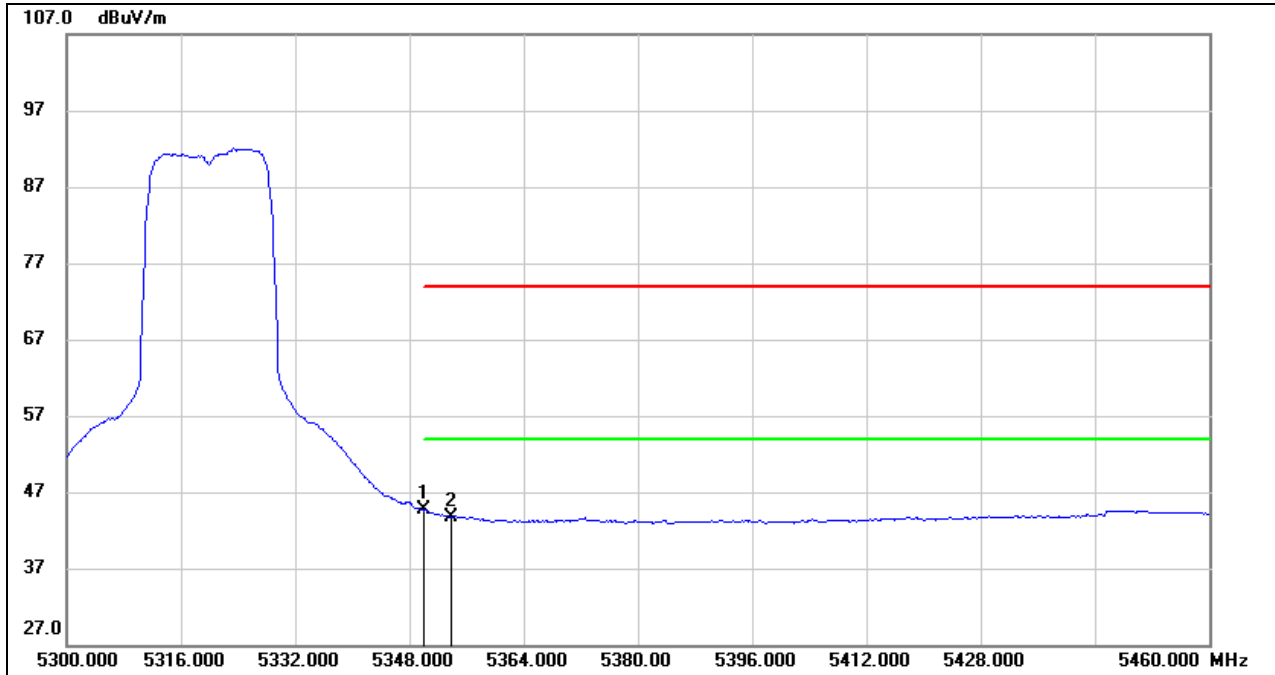

No.	Frequency (MHz)	Reading (dBuV)	Correct (dB/m)	Result (dBuV/m)	Limit (dBuV/m)	Margin (dB)	Remark
1	5350.000	4.03	40.64	44.67	54.00	-9.33	AVG
2	5353.920	3.08	40.63	43.71	54.00	-10.29	AVG

- Note: 1. Measurement = Reading Level + Correct Factor.
 2. AVG: VBW=1/Ton where: ton is transmit duration.
 3. For duty cycle, please refer to clause 7.1.
 4. Only the worst case emission will be recorder, if it complies with the limit, the other emissions deemed to comply with the limit.



VERTICAL RESULTS
PEAK

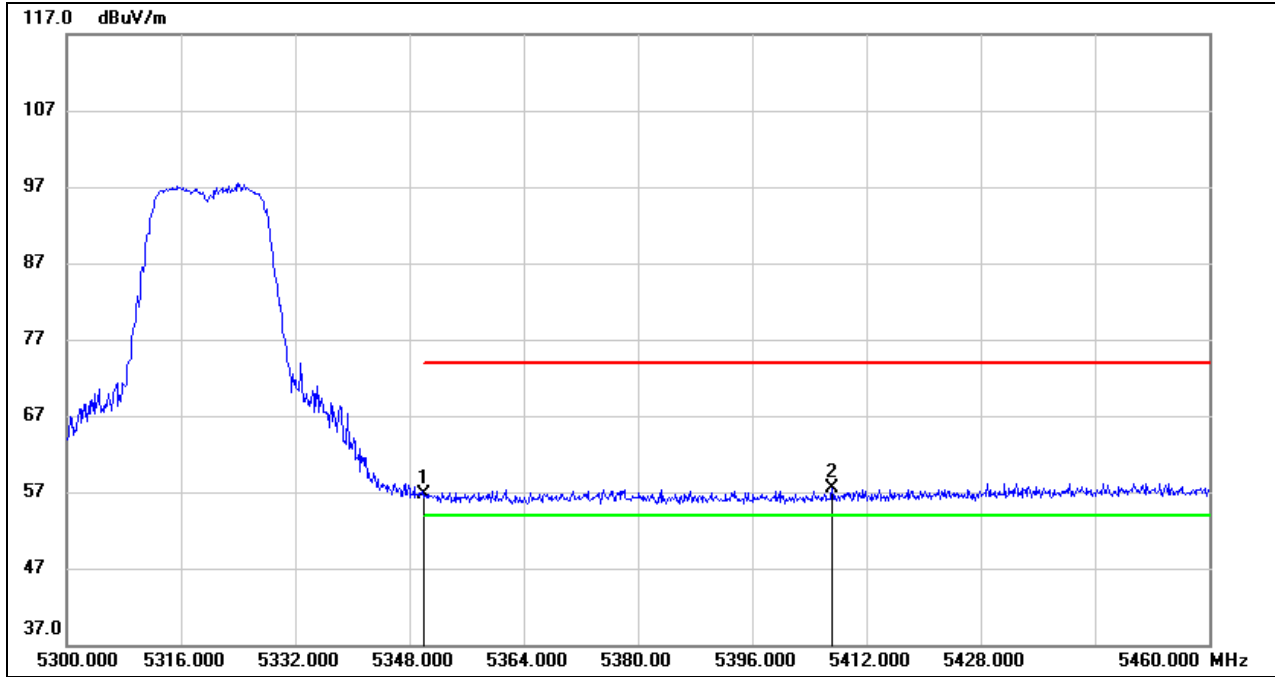

No.	Frequency (MHz)	Reading (dBuV)	Correct (dB/m)	Result (dBuV/m)	Limit (dBuV/m)	Margin (dB)	Remark
1	5350.000	16.06	40.64	56.70	74.00	-17.30	peak
2	5407.200	16.87	40.60	57.47	74.00	-16.53	peak

- Note: 1. Measurement = Reading Level + Correct Factor.
 2. If Peak Result complies with AV limit, AV Result is deemed to comply with AV limit.
 3. Peak: Peak detector.
 4. Only the worst case emission will be recorder, if it complies with the limit, the other emissions deemed to comply with the limit.



AVG

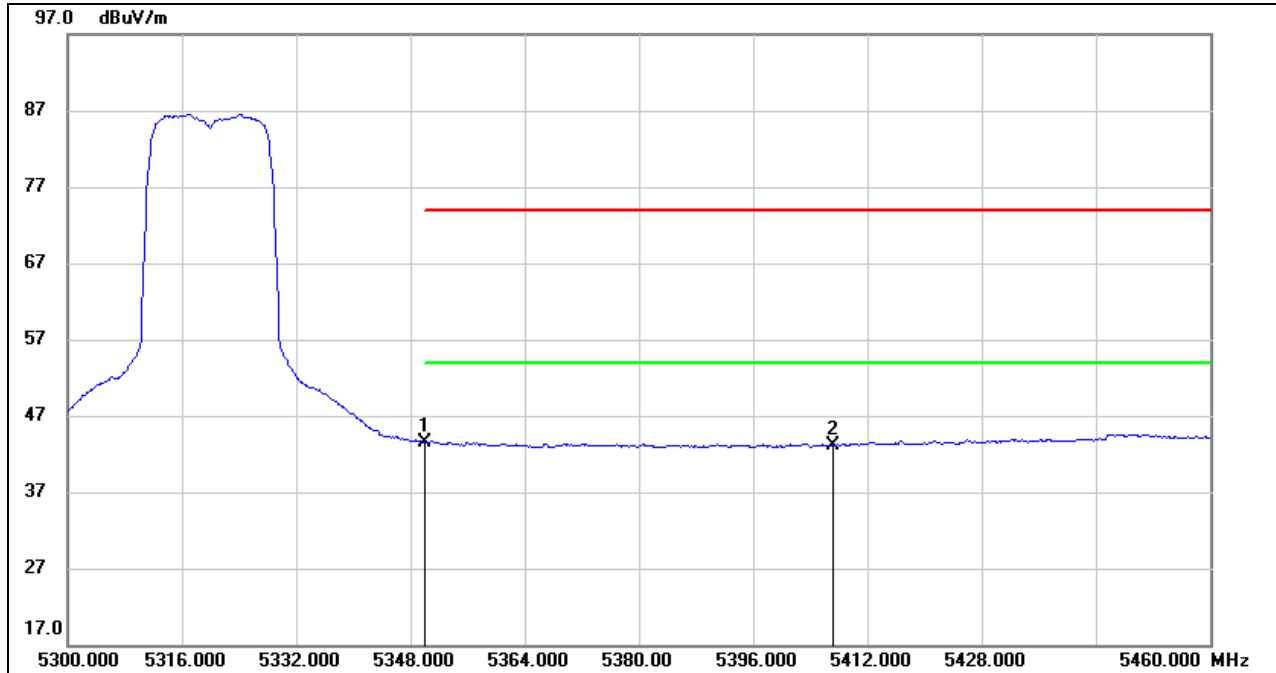

No.	Frequency (MHz)	Reading (dBuV)	Correct (dB/m)	Result (dBuV/m)	Limit (dBuV/m)	Margin (dB)	Remark
1	5350.000	2.94	40.64	43.58	54.00	-10.42	AVG
2	5407.200	2.57	40.60	43.17	54.00	-10.83	AVG

- Note: 1. Measurement = Reading Level + Correct Factor.
 2. AVG: VBW=1/Ton where: ton is transmit duration.
 3. For duty cycle, please refer to clause 7.1.
 4. Only the worst case emission will be recorder, if it complies with the limit, the other emissions deemed to comply with the limit.



HARMONICS AND SPURIOUS EMISSIONS LOW CHANNEL

HORIZONTAL RESULTS
1-7GHz

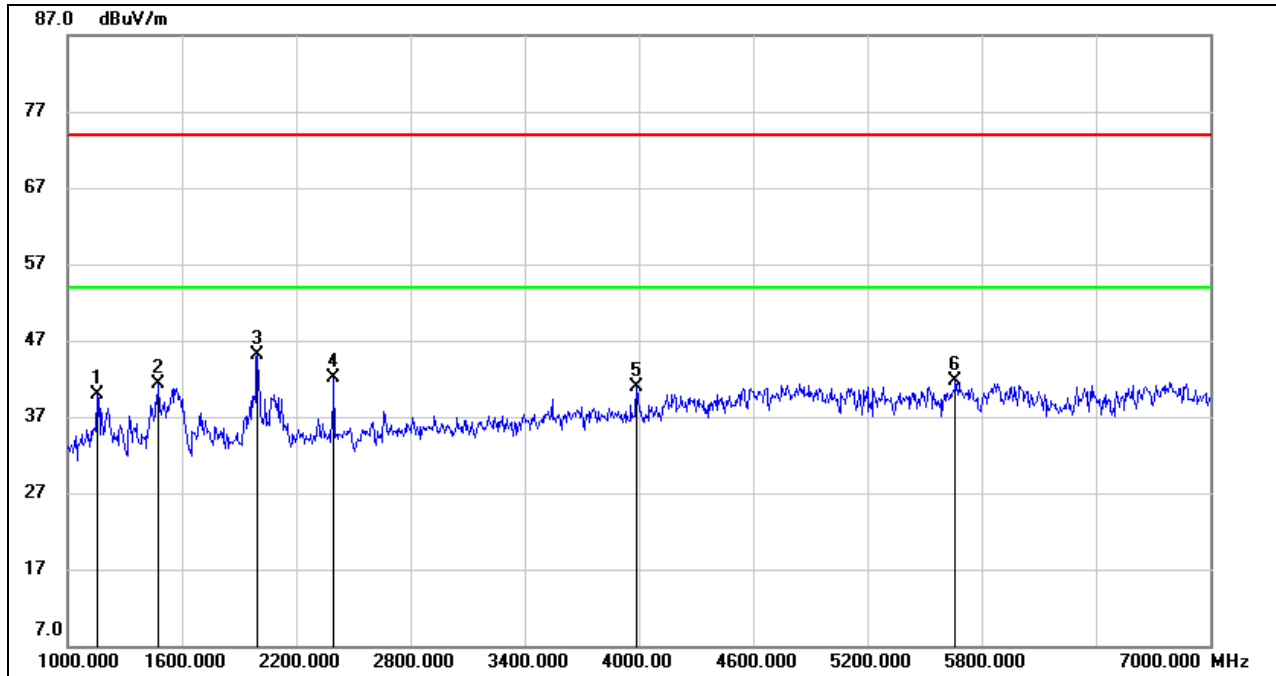

No.	Frequency (MHz)	Reading (dBuV)	Correct (dB/m)	Result (dBuV/m)	Limit (dBuV/m)	Margin (dB)	Remark
1	1156.000	53.27	-13.29	39.98	74.00	-34.02	peak
2	1474.000	53.70	-12.43	41.27	74.00	-32.73	peak
3	1996.000	55.44	-10.24	45.20	74.00	-28.80	peak
4	2398.000	50.81	-8.62	42.19	74.00	-31.81	peak
5	3988.000	44.69	-3.72	40.97	74.00	-33.03	peak
6	5662.000	39.81	1.99	41.80	74.00	-32.20	peak

- Note: 1. Measurement = Reading Level + Correct Factor.
 2. If Peak Result complies with AV limit, AV Result is deemed to comply with AV limit.
 3. Peak: Peak detector.
 4. Filter losses were only considered in the spurious frequency bands and the authorized band was not corrected for Band reject filter losses.
 5. Proper operation of the transmitter prior to adding the filter to the measurement chain.
 6. Owing to the highest peak level of unwanted emission out of the restricted bands complies with the lowest limit(54dBuV/m), so all the test point was deemed to comply with the limits list in the standard.



7-18GHz

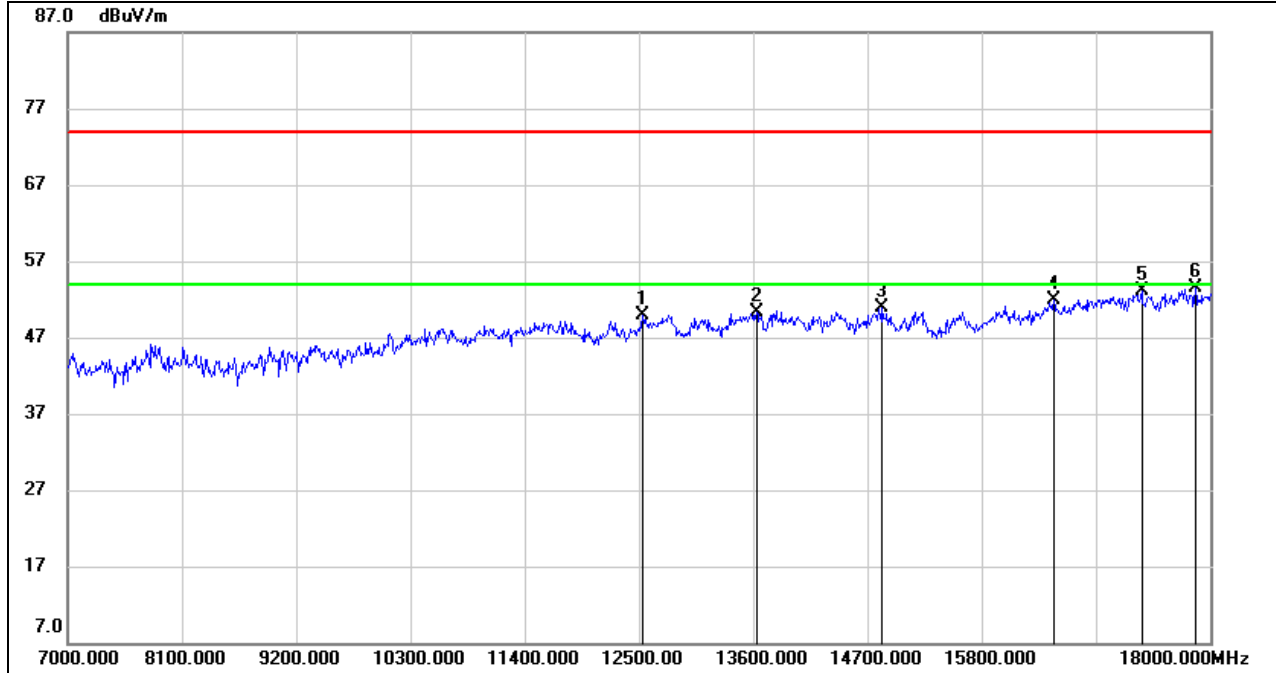

No.	Frequency (MHz)	Reading (dBuV)	Correct (dB/m)	Result (dBuV/m)	Limit (dBuV/m)	Margin (dB)	Remark
1	12533.000	35.35	14.65	50.00	74.00	-24.00	peak
2	13633.000	34.20	16.09	50.29	74.00	-23.71	peak
3	14843.000	34.82	16.11	50.93	74.00	-23.07	peak
4	16493.000	32.32	19.59	51.91	74.00	-22.09	peak
5	17340.000	31.41	21.74	53.15	74.00	-20.85	peak
6	17857.000	30.14	23.41	53.55	74.00	-20.45	peak

Note: 1. Measurement = Reading Level + Correct Factor.
 2. If Peak Result complies with AV limit, AV Result is deemed to comply with AV limit.
 3. Peak: Peak detector.
 4. Filter losses were only considered in the spurious frequency bands and the authorized band was not corrected for HPF losses.
 5. Proper operation of the transmitter prior to adding the filter to the measurement chain.
 6. Owing to the highest peak level of unwanted emission out of the restricted bands complies with the lowest limit(54dBuV/m), so all the test point was deemed to comply with the limits list in the standard.



VERTICAL RESULTS
1-7GHz

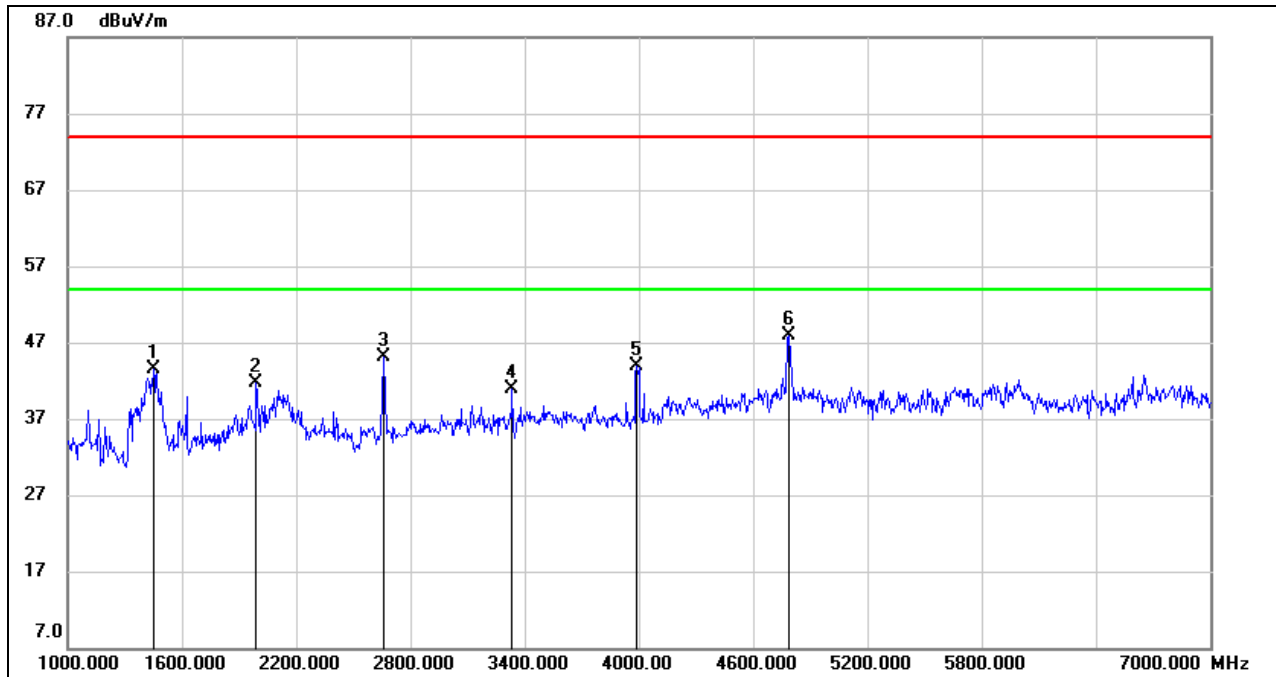

No.	Frequency (MHz)	Reading (dBuV)	Correct (dB/m)	Result (dBuV/m)	Limit (dBuV/m)	Margin (dB)	Remark
1	1450.000	56.08	-12.53	43.55	74.00	-30.45	peak
2	1990.000	51.93	-10.24	41.69	74.00	-32.31	peak
3	2656.000	52.90	-7.83	45.07	74.00	-28.93	peak
4	3334.000	46.49	-5.52	40.97	74.00	-33.03	peak
5	3988.000	47.70	-3.72	43.98	74.00	-30.02	peak
6	4786.000	47.56	0.44	48.00	74.00	-26.00	peak

Note: 1. Measurement = Reading Level + Correct Factor.
 2. If Peak Result complies with AV limit, AV Result is deemed to comply with AV limit.
 3. Peak: Peak detector.
 4. Filter losses were only considered in the spurious frequency bands and the authorized band was not corrected for Band reject filter losses.
 5. Proper operation of the transmitter prior to adding the filter to the measurement chain.
 6. Owing to the highest peak level of unwanted emission out of the restricted bands complies with the lowest limit(54dBuV/m), so all the test point was deemed to comply with the limits list in the standard.



7-18GHz

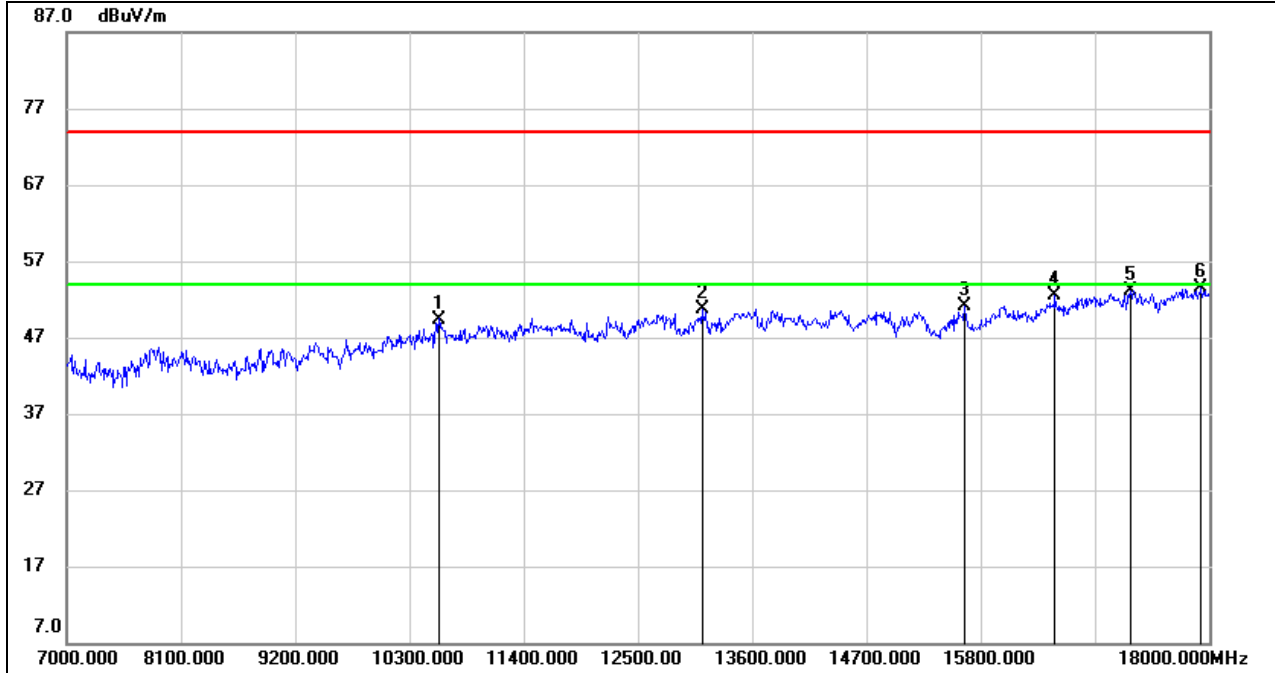

No.	Frequency (MHz)	Reading (dBuV)	Correct (dB/m)	Result (dBuV/m)	Limit (dBuV/m)	Margin (dB)	Remark
1	10586.000	37.10	12.30	49.40	74.00	-24.60	peak
2	13116.000	35.35	15.41	50.76	74.00	-23.24	peak
3	15646.000	34.05	16.97	51.02	74.00	-22.98	peak
4	16515.000	32.88	19.61	52.49	74.00	-21.51	peak
5	17241.000	31.67	21.48	53.15	74.00	-20.85	peak
6	17923.000	29.99	23.42	53.41	74.00	-20.59	peak

Note: 1. Measurement = Reading Level + Correct Factor.
 2. If Peak Result complies with AV limit, AV Result is deemed to comply with AV limit.
 3. Peak: Peak detector.
 4. Filter losses were only considered in the spurious frequency bands and the authorized band was not corrected for HPF losses.
 5. Proper operation of the transmitter prior to adding the filter to the measurement chain.
 6. Owing to the highest peak level of unwanted emission out of the restricted bands complies with the lowest limit(54dBuV/m), so all the test point was deemed to comply with the limits list in the standard.



HARMONICS AND SPURIOUS EMISSIONS MID CHANNEL

HORIZONTAL RESULTS
1-7GHz

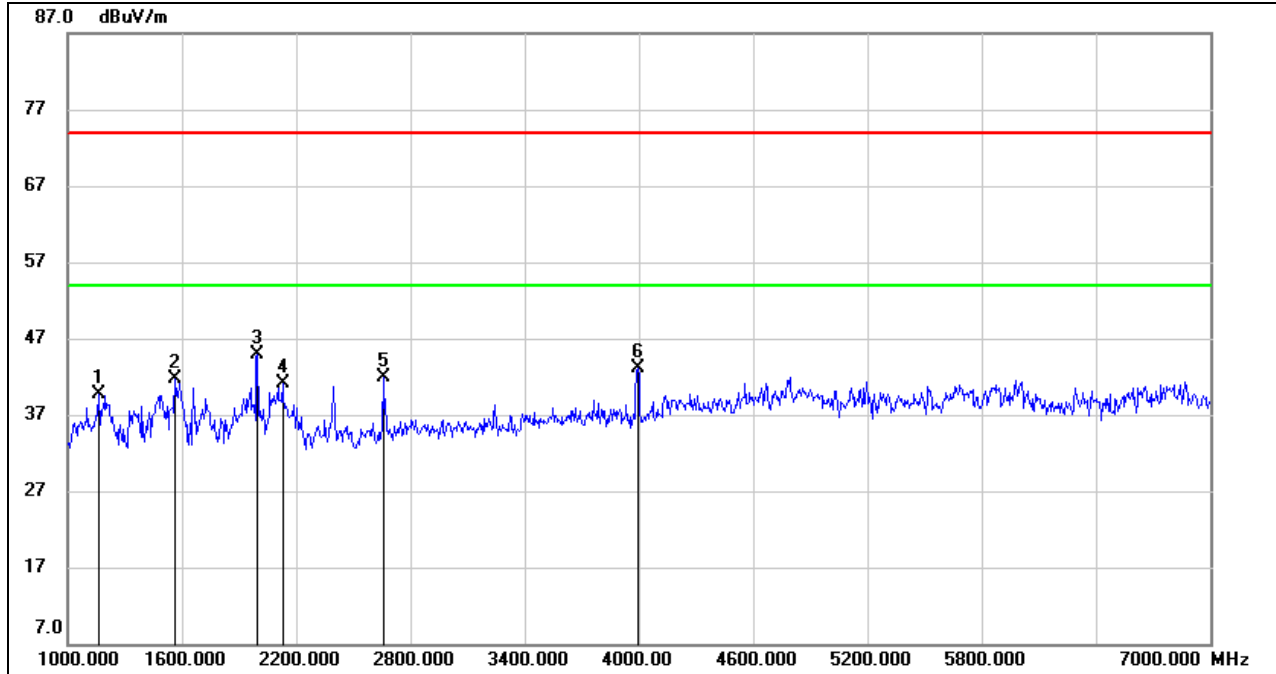

No.	Frequency (MHz)	Reading (dBuV)	Correct (dB/m)	Result (dBuV/m)	Limit (dBuV/m)	Margin (dB)	Remark
1	1162.000	52.95	-13.26	39.69	74.00	-34.31	peak
2	1564.000	53.51	-11.86	41.65	74.00	-32.35	peak
3	1996.000	55.22	-10.24	44.98	74.00	-29.02	peak
4	2128.000	50.74	-9.56	41.18	74.00	-32.82	peak
5	2656.000	49.70	-7.83	41.87	74.00	-32.13	peak
6	3994.000	46.77	-3.73	43.04	74.00	-30.96	peak

Note: 1. Measurement = Reading Level + Correct Factor.
 2. If Peak Result complies with AV limit, AV Result is deemed to comply with AV limit.
 3. Peak: Peak detector.
 4. Filter losses were only considered in the spurious frequency bands and the authorized band was not corrected for Band reject filter losses.
 5. Proper operation of the transmitter prior to adding the filter to the measurement chain.
 6. Owing to the highest peak level of unwanted emission out of the restricted bands complies with the lowest limit(54dBuV/m), so all the test point was deemed to comply with the limits list in the standard.



7-18GHz

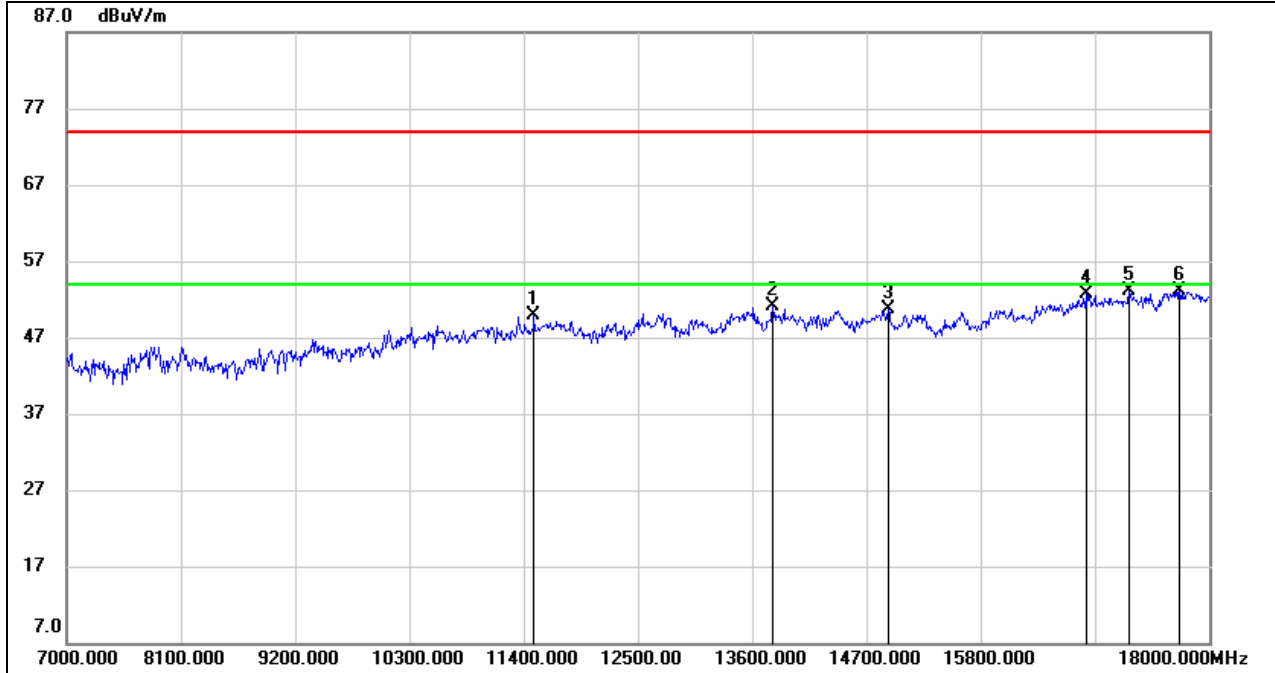

No.	Frequency (MHz)	Reading (dBuV)	Correct (dB/m)	Result (dBuV/m)	Limit (dBuV/m)	Margin (dB)	Remark
1	11499.000	36.56	13.35	49.91	74.00	-24.09	peak
2	13798.000	33.96	17.05	51.01	74.00	-22.99	peak
3	14909.000	34.52	16.17	50.69	74.00	-23.31	peak
4	16812.000	32.51	20.18	52.69	74.00	-21.31	peak
5	17230.000	31.73	21.41	53.14	74.00	-20.86	peak
6	17714.000	30.54	22.62	53.16	74.00	-20.84	peak

Note: 1. Measurement = Reading Level + Correct Factor.
 2. If Peak Result complies with AV limit, AV Result is deemed to comply with AV limit.
 3. Peak: Peak detector.
 4. Filter losses were only considered in the spurious frequency bands and the authorized band was not corrected for HPF losses.
 5. Proper operation of the transmitter prior to adding the filter to the measurement chain.
 6. Owing to the highest peak level of unwanted emission out of the restricted bands complies with the lowest limit(54dBuV/m), so all the test point was deemed to comply with the limits list in the standard.



VERTICAL RESULTS
1-7GHz

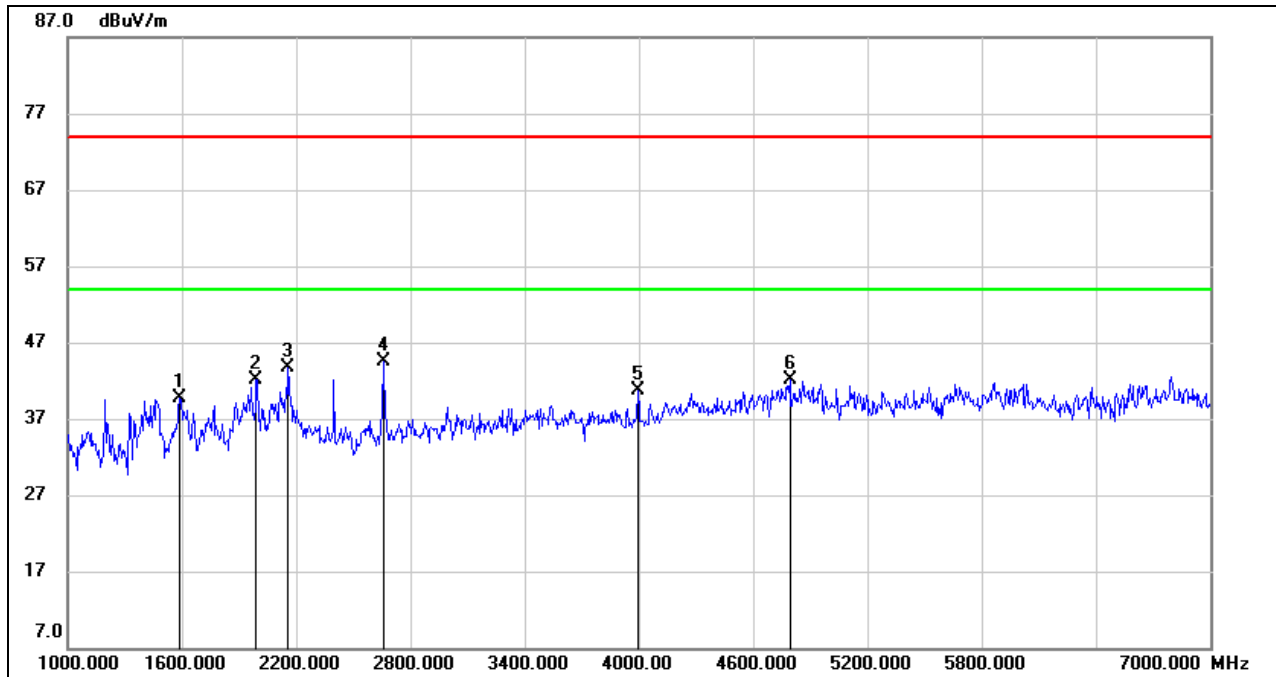

No.	Frequency (MHz)	Reading (dBuV)	Correct (dB/m)	Result (dBuV/m)	Limit (dBuV/m)	Margin (dB)	Remark
1	1588.000	51.49	-11.71	39.78	74.00	-34.22	peak
2	1990.000	52.41	-10.24	42.17	74.00	-31.83	peak
3	2158.000	53.18	-9.41	43.77	74.00	-30.23	peak
4	2656.000	52.25	-7.83	44.42	74.00	-29.58	peak
5	3994.000	44.36	-3.73	40.63	74.00	-33.37	peak
6	4792.000	41.54	0.47	42.01	74.00	-31.99	peak

Note: 1. Measurement = Reading Level + Correct Factor.
 2. If Peak Result complies with AV limit, AV Result is deemed to comply with AV limit.
 3. Peak: Peak detector.
 4. Filter losses were only considered in the spurious frequency bands and the authorized band was not corrected for Band reject filter losses.
 5. Proper operation of the transmitter prior to adding the filter to the measurement chain.
 6. Owing to the highest peak level of unwanted emission out of the restricted bands complies with the lowest limit(54dBuV/m), so all the test point was deemed to comply with the limits list in the standard.



7-18GHz

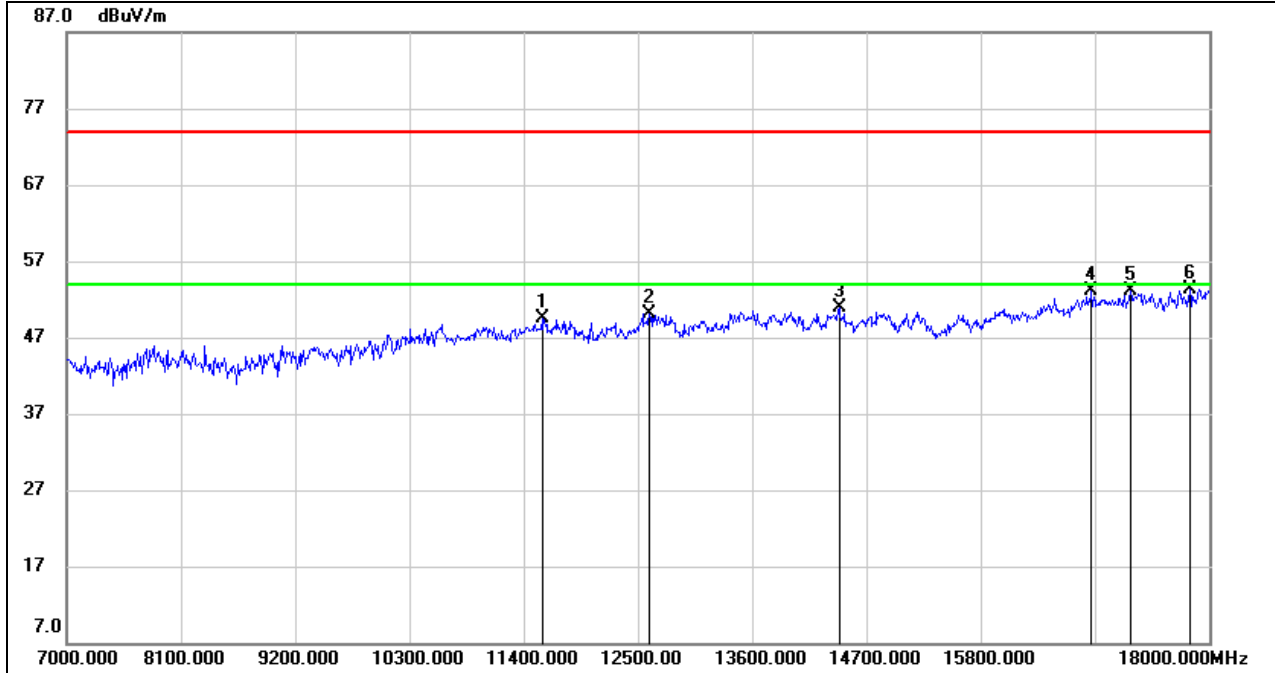

No.	Frequency (MHz)	Reading (dBuV)	Correct (dB/m)	Result (dBuV/m)	Limit (dBuV/m)	Margin (dB)	Remark
1	11576.000	35.91	13.51	49.42	74.00	-24.58	peak
2	12610.000	35.85	14.21	50.06	74.00	-23.94	peak
3	14436.000	34.22	16.64	50.86	74.00	-23.14	peak
4	16867.000	32.90	20.13	53.03	74.00	-20.97	peak
5	17241.000	31.58	21.48	53.06	74.00	-20.94	peak
6	17813.000	29.87	23.41	53.28	74.00	-20.72	peak

Note: 1. Measurement = Reading Level + Correct Factor.
 2. If Peak Result complies with AV limit, AV Result is deemed to comply with AV limit.
 3. Peak: Peak detector.
 4. Filter losses were only considered in the spurious frequency bands and the authorized band was not corrected for HPF losses.
 5. Proper operation of the transmitter prior to adding the filter to the measurement chain.
 6. Owing to the highest peak level of unwanted emission out of the restricted bands complies with the lowest limit(54dBuV/m), so all the test point was deemed to comply with the limits list in the standard.



HARMONICS AND SPURIOUS EMISSIONS HIGH CHANNEL

HORIZONTAL RESULTS
1-7GHz

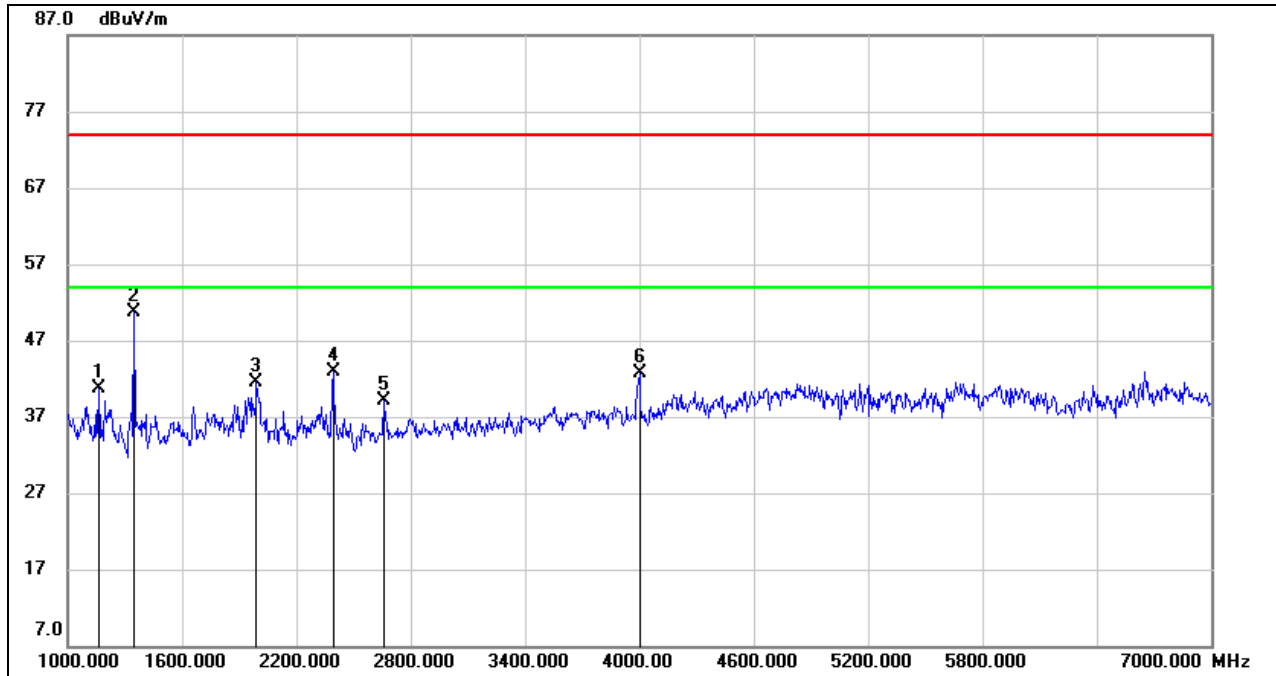

No.	Frequency (MHz)	Reading (dBuV)	Correct (dB/m)	Result (dBuV/m)	Limit (dBuV/m)	Margin (dB)	Remark
1	1162.000	53.95	-13.26	40.69	74.00	-33.31	peak
2	1348.000	63.47	-12.84	50.63	74.00	-23.37	peak
3	1990.000	51.72	-10.24	41.48	74.00	-32.52	peak
4	2392.000	51.58	-8.63	42.95	74.00	-31.05	peak
5	2656.000	46.93	-7.83	39.10	74.00	-34.90	peak
6	4000.000	46.35	-3.74	42.61	74.00	-31.39	peak

Note: 1. Measurement = Reading Level + Correct Factor.
 2. If Peak Result complies with AV limit, AV Result is deemed to comply with AV limit.
 3. Peak: Peak detector.
 4. Filter losses were only considered in the spurious frequency bands and the authorized band was not corrected for Band reject filter losses.
 5. Proper operation of the transmitter prior to adding the filter to the measurement chain.
 6. Owing to the highest peak level of unwanted emission out of the restricted bands complies with the lowest limit(54dBuV/m), so all the test point was deemed to comply with the limits list in the standard.



7-18GHz

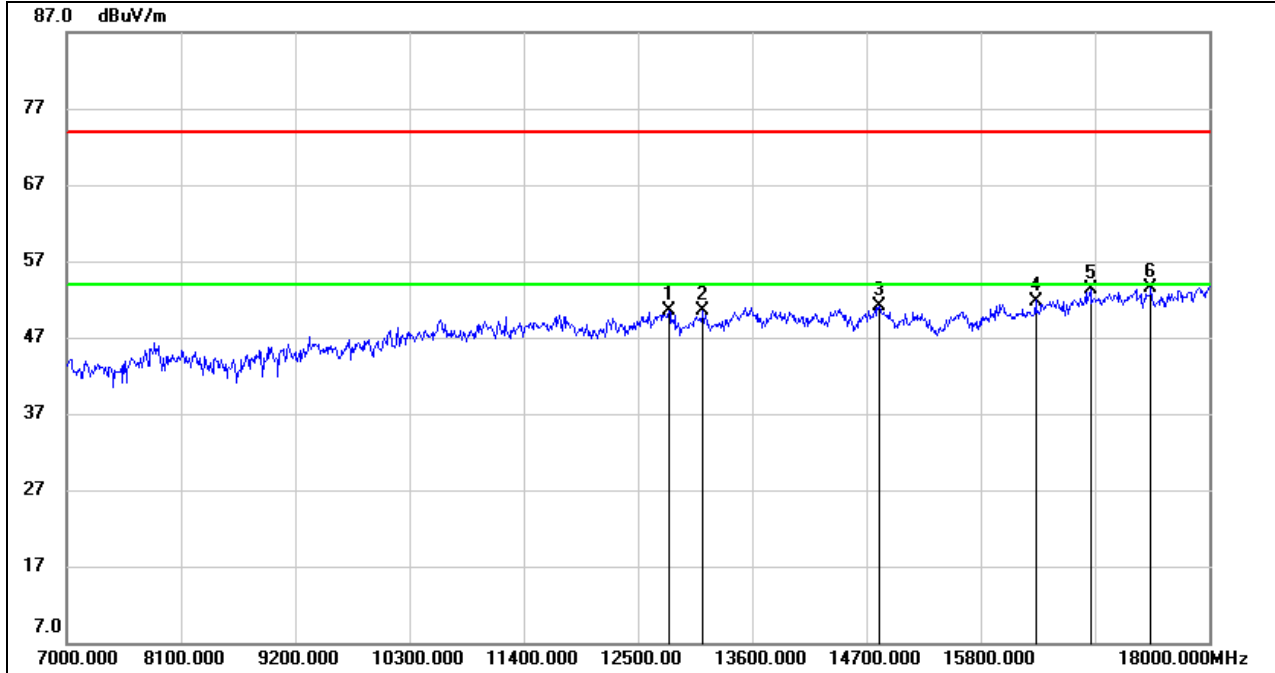

No.	Frequency (MHz)	Reading (dBuV)	Correct (dB/m)	Result (dBuV/m)	Limit (dBuV/m)	Margin (dB)	Remark
1	12797.000	34.32	16.12	50.44	74.00	-23.56	peak
2	13127.000	35.17	15.42	50.59	74.00	-23.41	peak
3	14821.000	34.94	16.09	51.03	74.00	-22.97	peak
4	16328.000	33.13	18.67	51.80	74.00	-22.20	peak
5	16856.000	33.22	20.13	53.35	74.00	-20.65	peak
6	17439.000	32.01	21.49	53.50	74.00	-20.50	peak

Note: 1. Measurement = Reading Level + Correct Factor.
 2. If Peak Result complies with AV limit, AV Result is deemed to comply with AV limit.
 3. Peak: Peak detector.
 4. Filter losses were only considered in the spurious frequency bands and the authorized band was not corrected for HPF losses.
 5. Proper operation of the transmitter prior to adding the filter to the measurement chain.
 6. Owing to the highest peak level of unwanted emission out of the restricted bands complies with the lowest limit(54dBuV/m), so all the test point was deemed to comply with the limits list in the standard.



VERTICAL RESULTS
1-7GHz

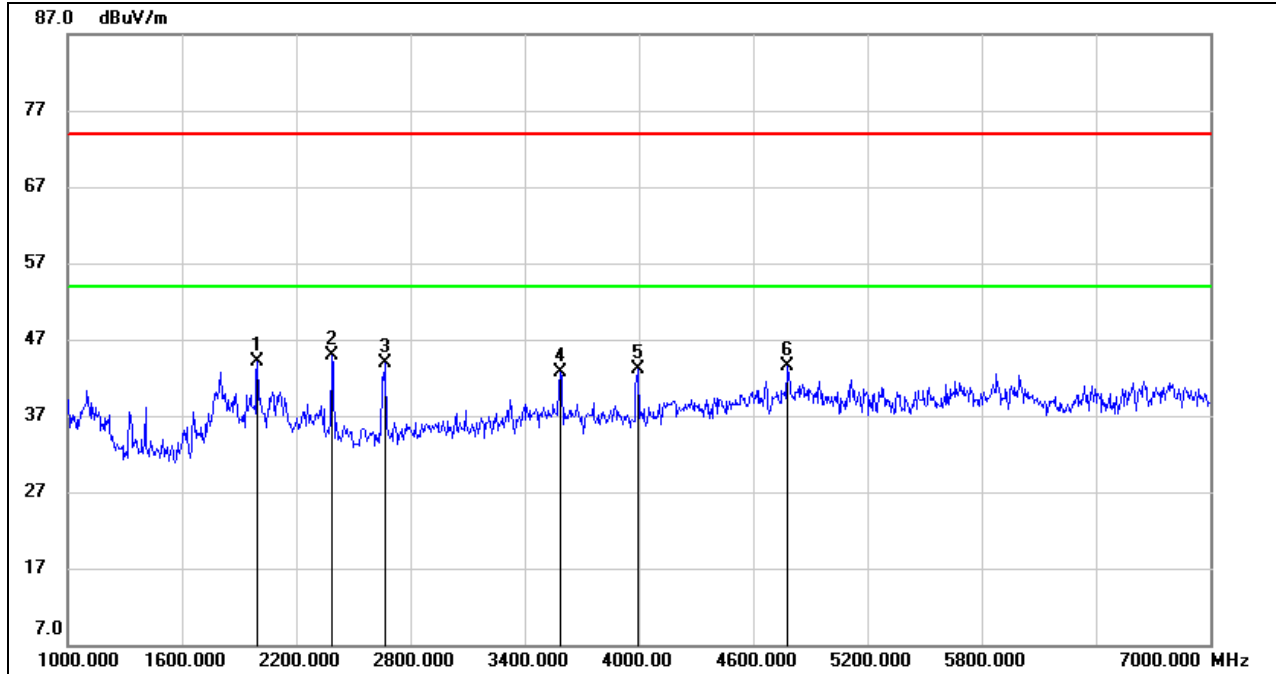

No.	Frequency (MHz)	Reading (dBuV)	Correct (dB/m)	Result (dBuV/m)	Limit (dBuV/m)	Margin (dB)	Remark
1	1996.000	54.34	-10.24	44.10	74.00	-29.90	peak
2	2386.000	53.56	-8.67	44.89	74.00	-29.11	peak
3	2668.000	51.61	-7.76	43.85	74.00	-30.15	peak
4	3586.000	47.29	-4.55	42.74	74.00	-31.26	peak
5	3994.000	46.88	-3.73	43.15	74.00	-30.85	peak
6	4780.000	43.00	0.41	43.41	74.00	-30.59	peak

Note: 1. Measurement = Reading Level + Correct Factor.
 2. If Peak Result complies with AV limit, AV Result is deemed to comply with AV limit.
 3. Peak: Peak detector.
 4. Filter losses were only considered in the spurious frequency bands and the authorized band was not corrected for Band reject filter losses.
 5. Proper operation of the transmitter prior to adding the filter to the measurement chain.
 6. Owing to the highest peak level of unwanted emission out of the restricted bands complies with the lowest limit(54dBuV/m), so all the test point was deemed to comply with the limits list in the standard.



7-18GHz

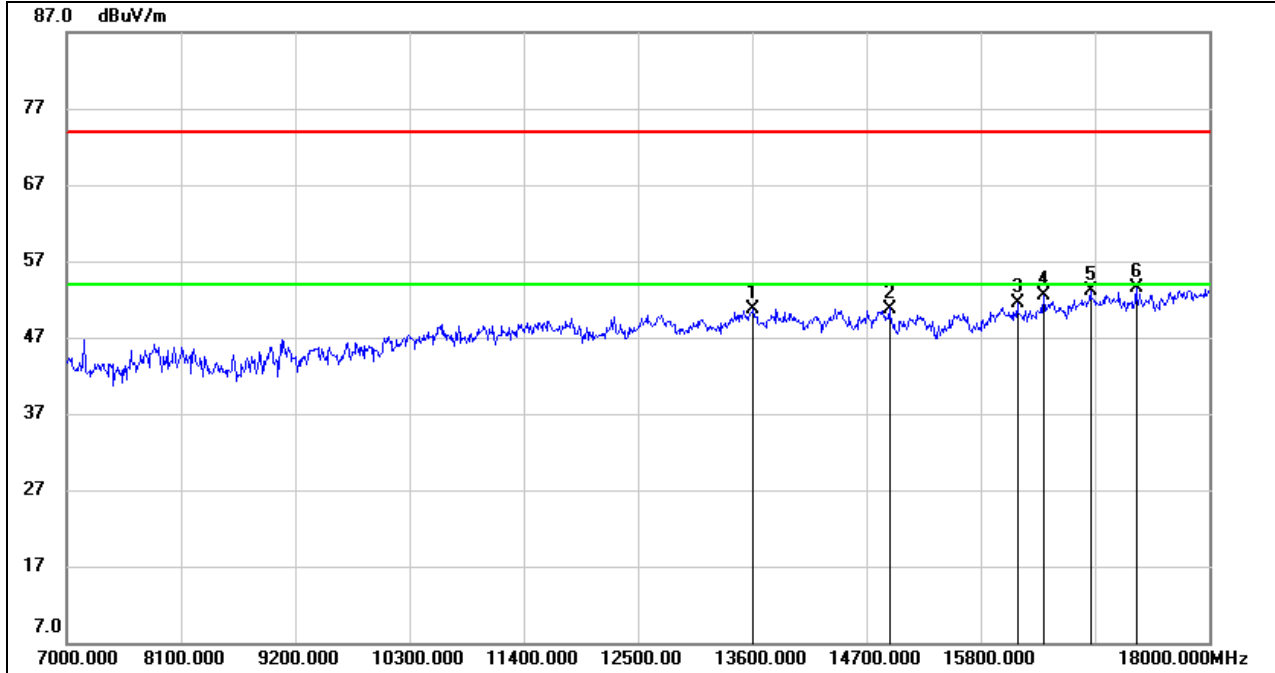

No.	Frequency (MHz)	Reading (dBuV)	Correct (dB/m)	Result (dBuV/m)	Limit (dBuV/m)	Margin (dB)	Remark
1	13611.000	34.56	16.10	50.66	74.00	-23.34	peak
2	14920.000	34.65	16.15	50.80	74.00	-23.20	peak
3	16152.000	32.97	18.50	51.47	74.00	-22.53	peak
4	16405.000	33.25	19.29	52.54	74.00	-21.46	peak
5	16856.000	32.89	20.13	53.02	74.00	-20.98	peak
6	17296.000	31.66	21.86	53.52	74.00	-20.48	peak

Note: 1. Measurement = Reading Level + Correct Factor.
 2. If Peak Result complies with AV limit, AV Result is deemed to comply with AV limit.
 3. Peak: Peak detector.
 4. Filter losses were only considered in the spurious frequency bands and the authorized band was not corrected for HPF losses.
 5. Proper operation of the transmitter prior to adding the filter to the measurement chain.
 6. Owing to the highest peak level of unwanted emission out of the restricted bands complies with the lowest limit(54dBuV/m), so all the test point was deemed to comply with the limits list in the standard.



**8.1.3. UNII-2C BAND
WORST CASE FOR ANT2**

RESTRICTED BANDEDGE LOW CHANNEL

**HORIZONTAL RESULTS
PEAK**

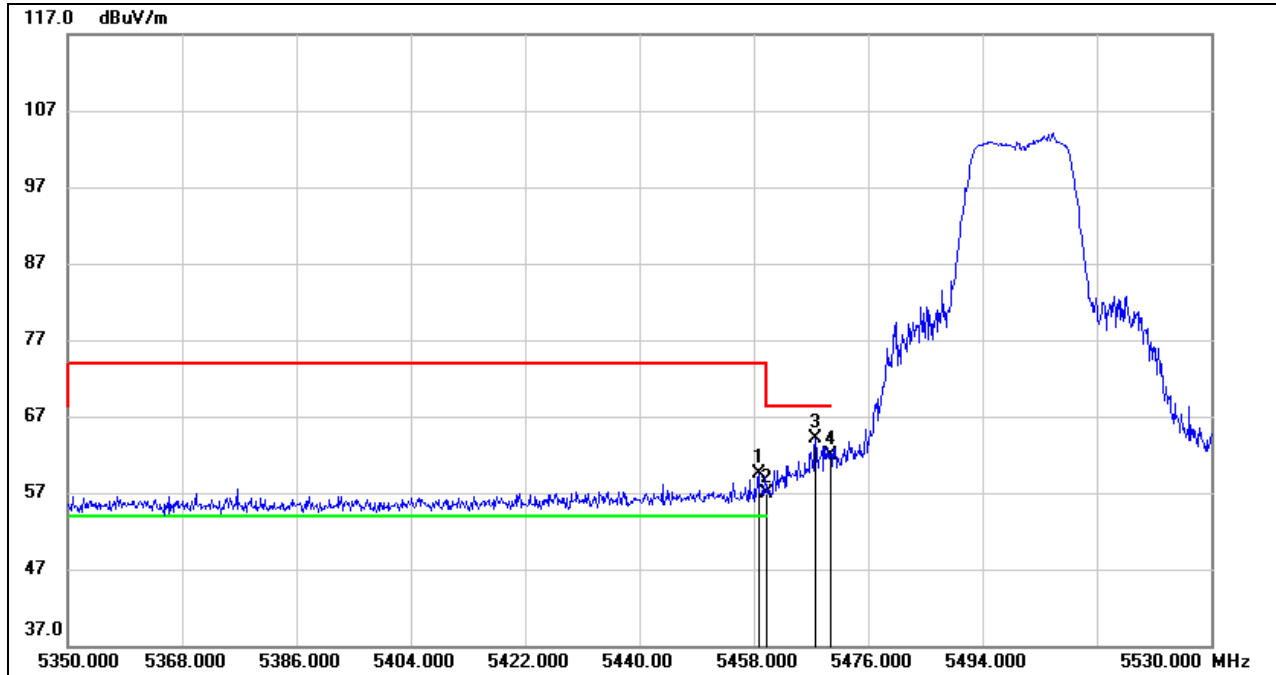

No.	Frequency (MHz)	Reading (dBuV)	Correct (dB/m)	Result (dBuV/m)	Limit (dBuV/m)	Margin (dB)	Remark
1	5458.720	18.18	41.27	59.45	74.00	-14.55	peak
2	5460.000	15.70	41.28	56.98	68.20	-11.22	peak
3	5467.720	22.63	41.38	64.01	68.20	-4.19	peak
4	5470.000	20.45	41.41	61.86	68.20	-6.34	peak

Note: 1. Measurement = Reading Level + Correct Factor.
 2. If Peak Result complies with AV limit, AV Result is deemed to comply with AV limit.
 3. Peak: Peak detector.
 4.*indicates frequency out of the restricted bands
 5. Only the worst case emission will be recorder, if it complies with the limit, the other emissions deemed to comply with the limit.



AVG

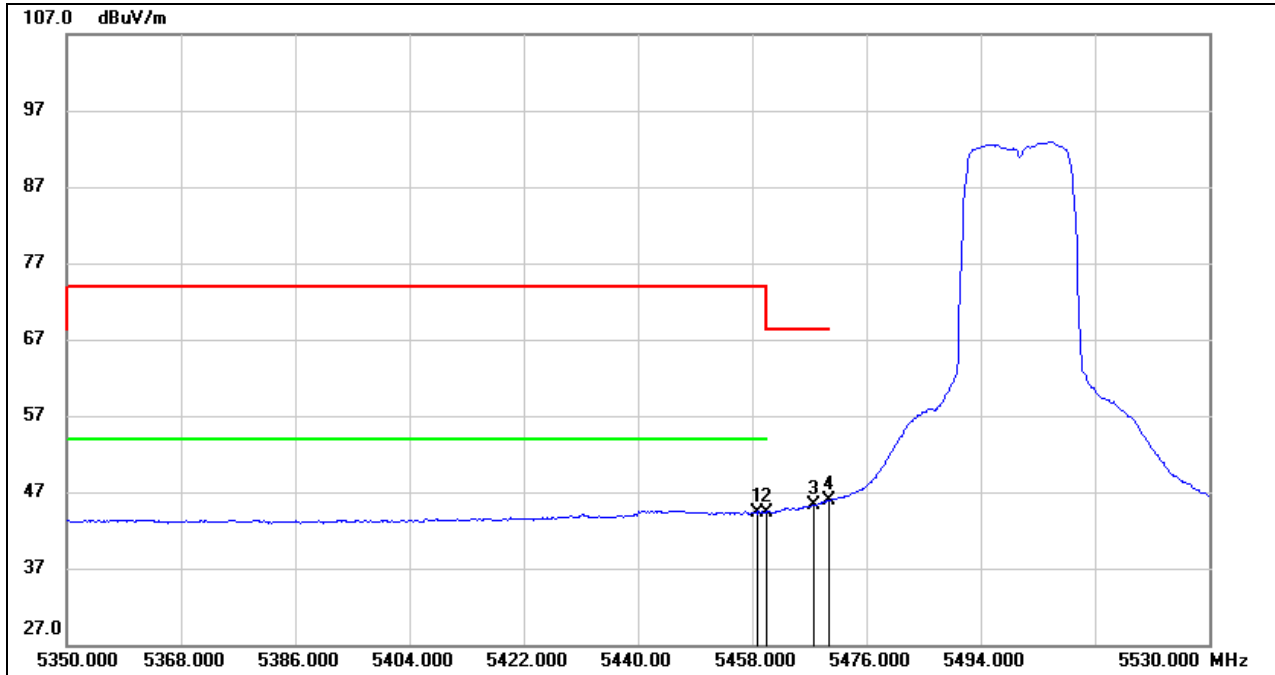

No.	Frequency (MHz)	Reading (dBuV)	Correct (dB/m)	Result (dBuV/m)	Limit (dBuV/m)	Margin (dB)	Remark
1	5458.720	2.93	41.27	44.20	54.00	-9.80	AVG
2	5460.000	3.08	41.28	44.36	54.00	-9.64	AVG
3	5467.720	3.95	41.38	45.33	68.20	-22.87	AVG
4	5470.000	4.55	41.41	45.96	68.20	-22.24	AVG

- Note:
1. Measurement = Reading Level + Correct Factor.
 2. AVG: $VBW=1/T_{on}$ where: t_{on} is transmit duration.
 3. For duty cycle, please refer to clause 7.1.
 4. Only the worst case emission will be recorder, if it complies with the limit, the other emissions deemed to comply with the limit.



VERTICAL RESULTS
PEAK

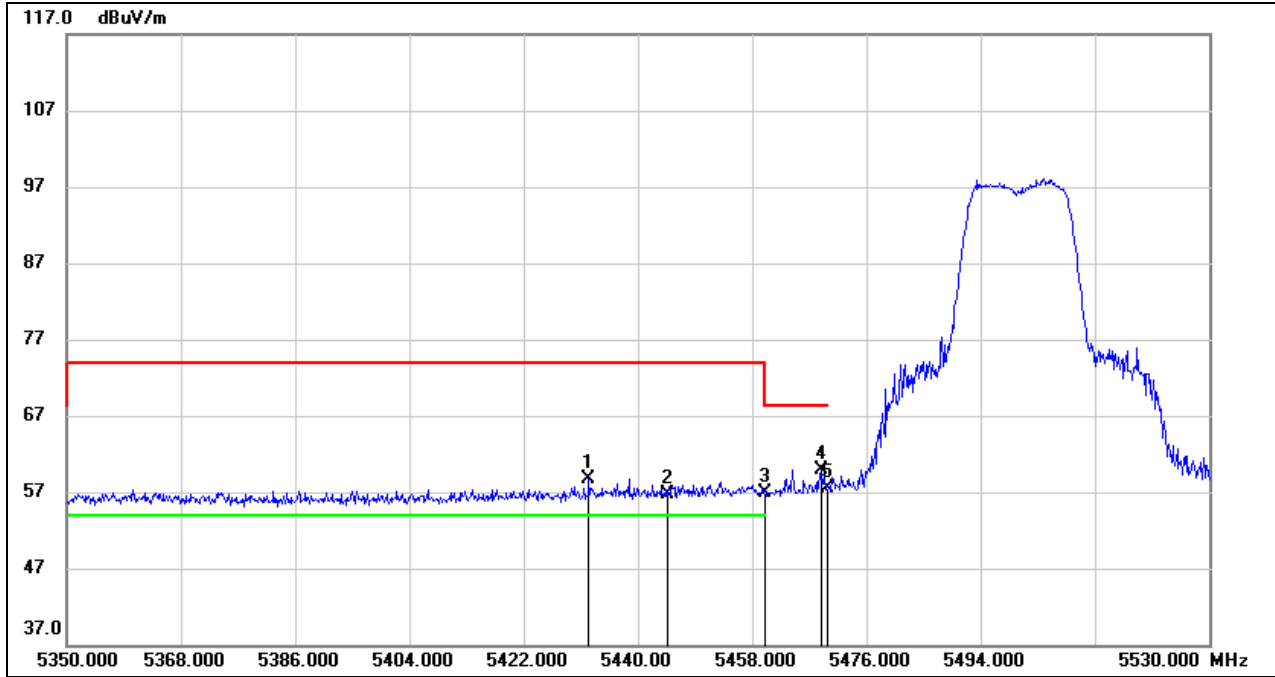

No.	Frequency (MHz)	Reading (dBuV)	Correct (dB/m)	Result (dBuV/m)	Limit (dBuV/m)	Margin (dB)	Remark
1	5432.260	17.70	40.93	58.63	74.00	-15.37	peak
2	5444.680	15.62	41.08	56.70	74.00	-17.30	peak
3	5460.000	15.60	41.28	56.88	68.20	-11.32	peak
4	5468.800	18.54	41.39	59.93	68.20	-8.27	peak
5	5470.000	16.15	41.41	57.56	68.20	-10.64	peak

Note: 1. Measurement = Reading Level + Correct Factor.
 2. If Peak Result complies with AV limit, AV Result is deemed to comply with AV limit.
 3. Peak: Peak detector.
 4.*indicates frequency out of the restricted bands
 5. Only the worst case emission will be recorder, if it complies with the limit, the other emissions deemed to comply with the limit.



AVG

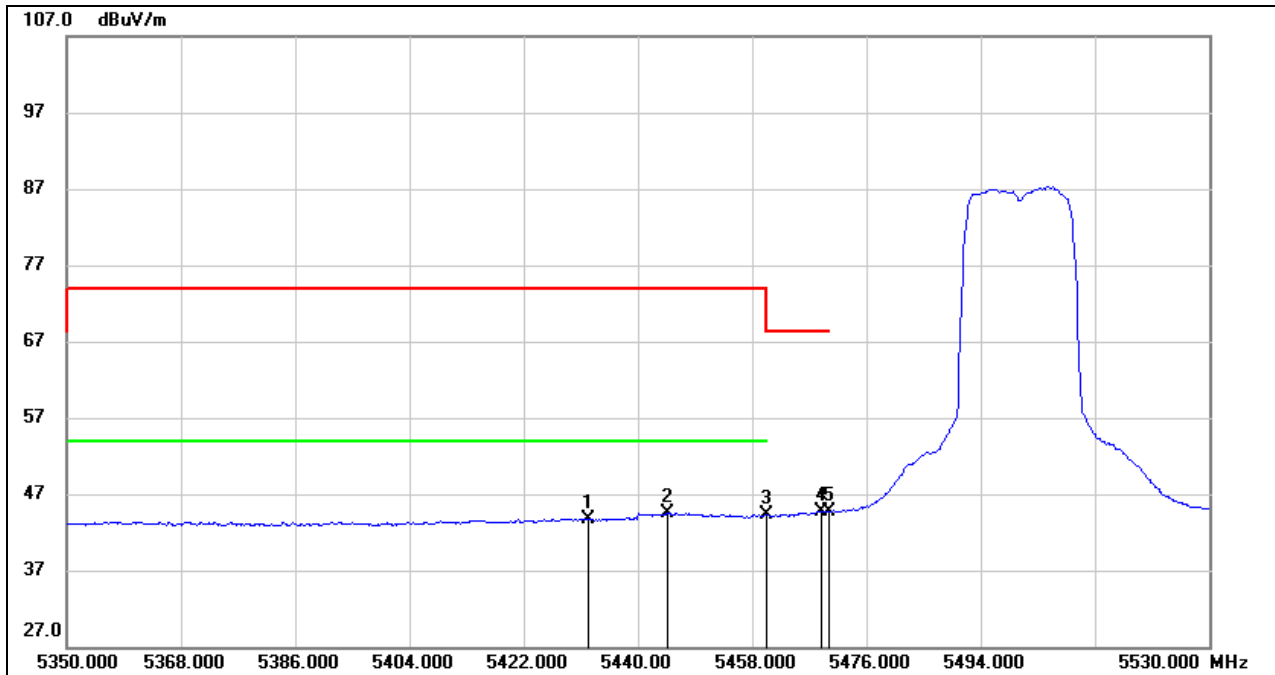

No.	Frequency (MHz)	Reading (dBuV)	Correct (dB/m)	Result (dBuV/m)	Limit (dBuV/m)	Margin (dB)	Remark
1	5432.260	2.71	40.93	43.64	54.00	-10.36	AVG
2	5444.680	3.41	41.08	44.49	54.00	-9.51	AVG
3	5460.000	3.00	41.28	44.28	54.00	-9.72	AVG
4	5468.800	3.31	41.39	44.70	68.20	-23.50	AVG
5	5470.000	3.24	41.41	44.65	68.20	-23.55	AVG

- Note:
1. Measurement = Reading Level + Correct Factor.
 2. AVG: $VBW=1/Ton$ where: ton is transmit duration.
 3. For duty cycle, please refer to clause 7.1.
 4. Only the worst case emission will be recorder, if it complies with the limit, the other emissions deemed to comply with the limit.



RESTRICTED BANDEGE HIGH CHANNEL

HORIZONTAL RESULTS
PEAK

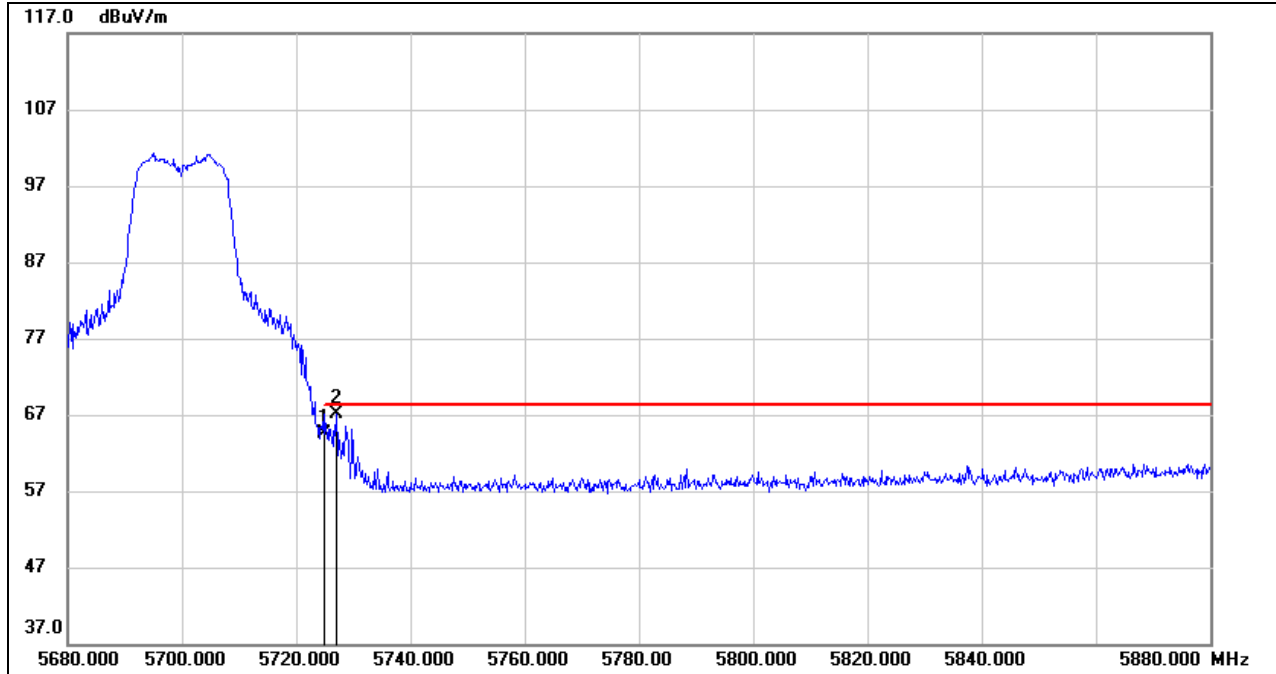

No.	Frequency (MHz)	Reading (dBuV)	Correct (dB/m)	Result (dBuV/m)	Limit (dBuV/m)	Margin (dB)	Remark
1	5725.000	22.98	41.61	64.59	68.20	-3.61	peak
2	5727.000	25.47	41.61	67.08	68.20	-1.12	peak

- Note: 1. Measurement = Reading Level + Correct Factor.
 2. If Peak Result complies with AV limit, AV Result is deemed to comply with AV limit.
 3. Peak: Peak detector.
 4. Only the worst case emission will be recorder, if it complies with the limit, the other emissions deemed to comply with the limit.



VERTICAL RESULTS
PEAK

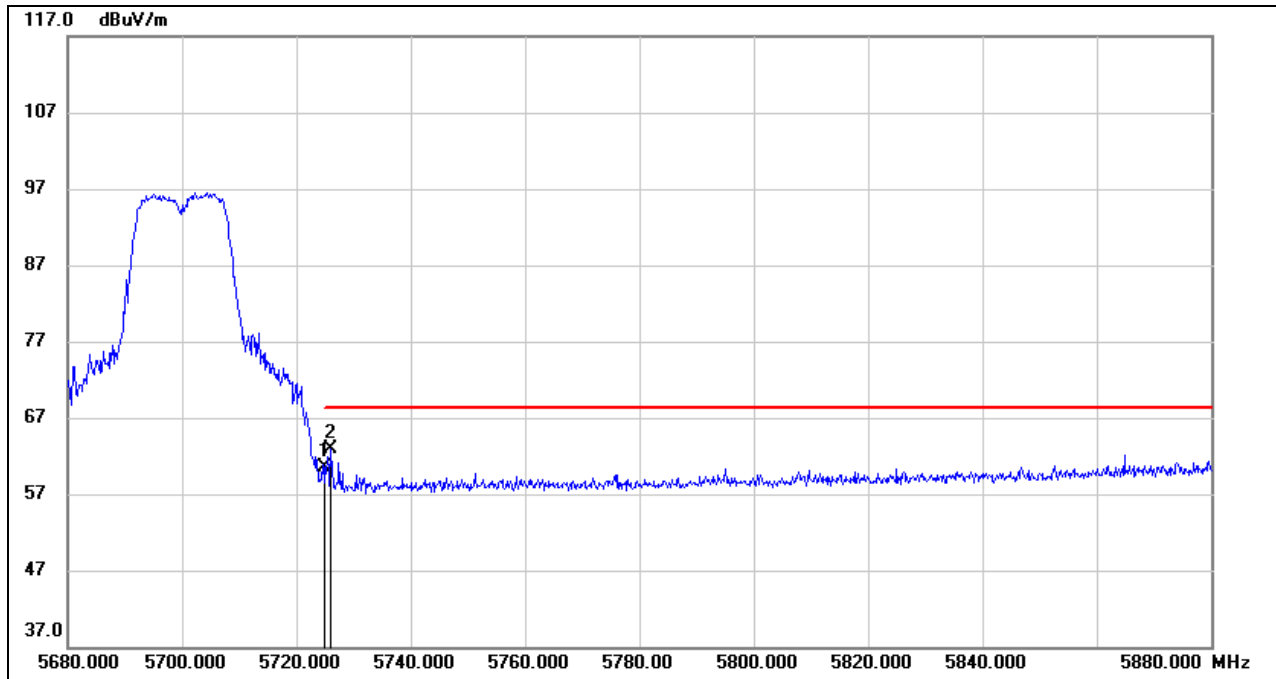

No.	Frequency (MHz)	Reading (dBuV)	Correct (dB/m)	Result (dBuV/m)	Limit (dBuV/m)	Margin (dB)	Remark
1	5725.000	18.98	41.61	60.59	68.20	-7.61	peak
2	5726.000	21.24	41.61	62.85	68.20	-5.35	peak

- Note: 1. Measurement = Reading Level + Correct Factor.
 2. If Peak Result complies with AV limit, AV Result is deemed to comply with AV limit.
 3. Peak: Peak detector.
 4. Only the worst case emission will be recorder, if it complies with the limit, the other emissions deemed to comply with the limit.



HARMONICS AND SPURIOUS EMISSIONS LOW CHANNEL

HORIZONTAL RESULTS
1-7GHz

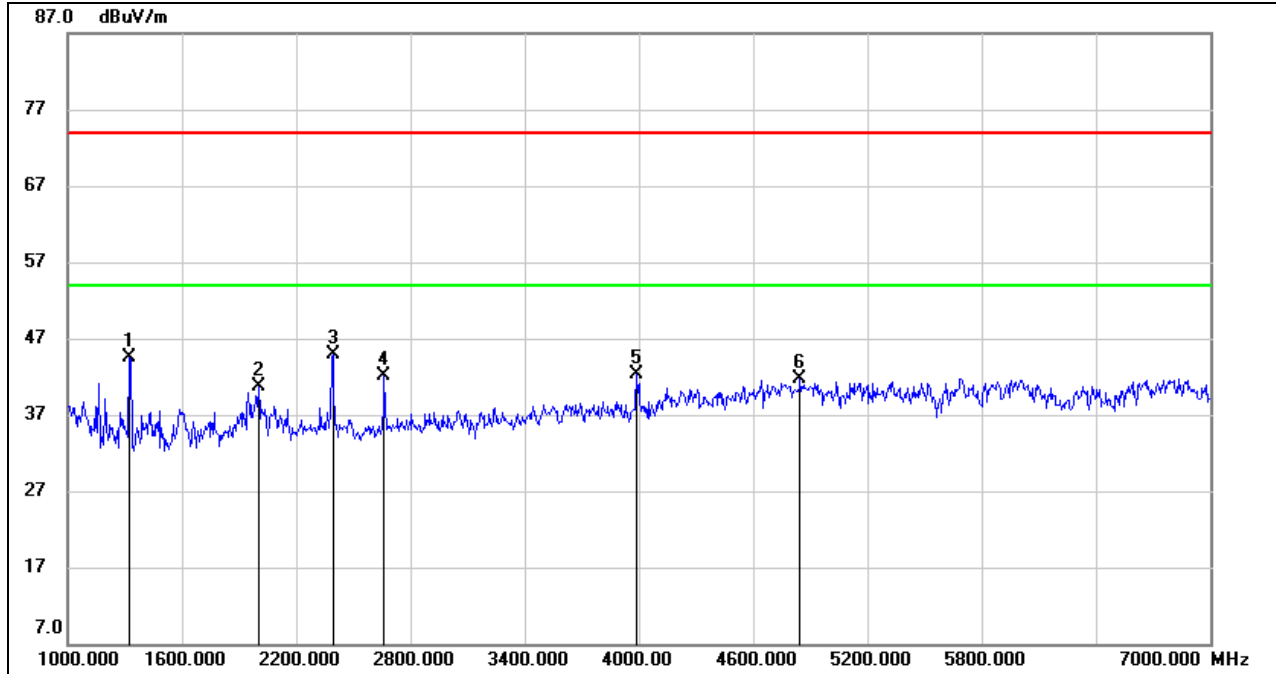

No.	Frequency (MHz)	Reading (dBuV)	Correct (dB/m)	Result (dBuV/m)	Limit (dBuV/m)	Margin (dB)	Remark
1	1324.000	57.45	-12.89	44.56	74.00	-29.44	peak
2	2002.000	50.88	-10.23	40.65	74.00	-33.35	peak
3	2392.000	53.56	-8.63	44.93	74.00	-29.07	peak
4	2662.000	49.94	-7.80	42.14	74.00	-31.86	peak
5	3988.000	46.03	-3.72	42.31	74.00	-31.69	peak
6	4846.000	41.07	0.60	41.67	74.00	-32.33	peak

- Note: 1. Measurement = Reading Level + Correct Factor.
 2. If Peak Result complies with AV limit, AV Result is deemed to comply with AV limit.
 3. Peak: Peak detector.
 4. Filter losses were only considered in the spurious frequency bands and the authorized band was not corrected for Band reject filter losses.
 5. Proper operation of the transmitter prior to adding the filter to the measurement chain.
 6. Owing to the highest peak level of unwanted emission out of the restricted bands complies with the lowest limit(54dBuV/m), so all the test point was deemed to comply with the limits list in the standard.



HORIZONTAL RESULTS
7-18GHz

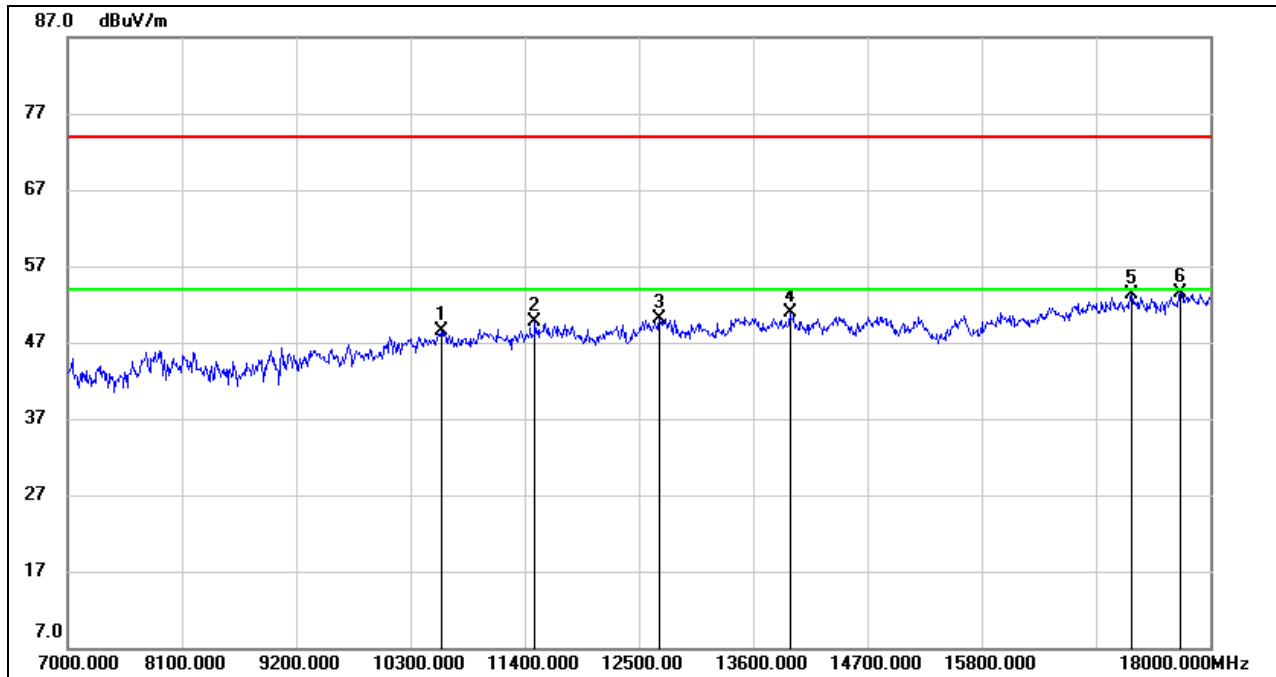

No.	Frequency (MHz)	Reading (dBuV)	Correct (dB/m)	Result (dBuV/m)	Limit (dBuV/m)	Margin (dB)	Remark
1	10597.000	36.03	12.43	48.46	74.00	-25.54	peak
2	11499.000	36.34	13.35	49.69	74.00	-24.31	peak
3	12698.000	35.58	14.44	50.02	74.00	-23.98	peak
4	13952.000	34.71	16.16	50.87	74.00	-23.13	peak
5	17241.000	31.89	21.48	53.37	74.00	-20.63	peak
6	17714.000	30.98	22.62	53.60	74.00	-20.40	peak

Note: 1. Measurement = Reading Level + Correct Factor.
 2. If Peak Result complies with AV limit, AV Result is deemed to comply with AV limit.
 3. Peak: Peak detector.
 4. Filter losses were only considered in the spurious frequency bands and the authorized band was not corrected for HPF losses.
 5. Proper operation of the transmitter prior to adding the filter to the measurement chain.
 6. Owing to the highest peak level of unwanted emission out of the restricted bands complies with the lowest limit(54dBuV/m), so all the test point was deemed to comply with the limits list in the standard.



VERTICAL RESULTS
1-7GHz

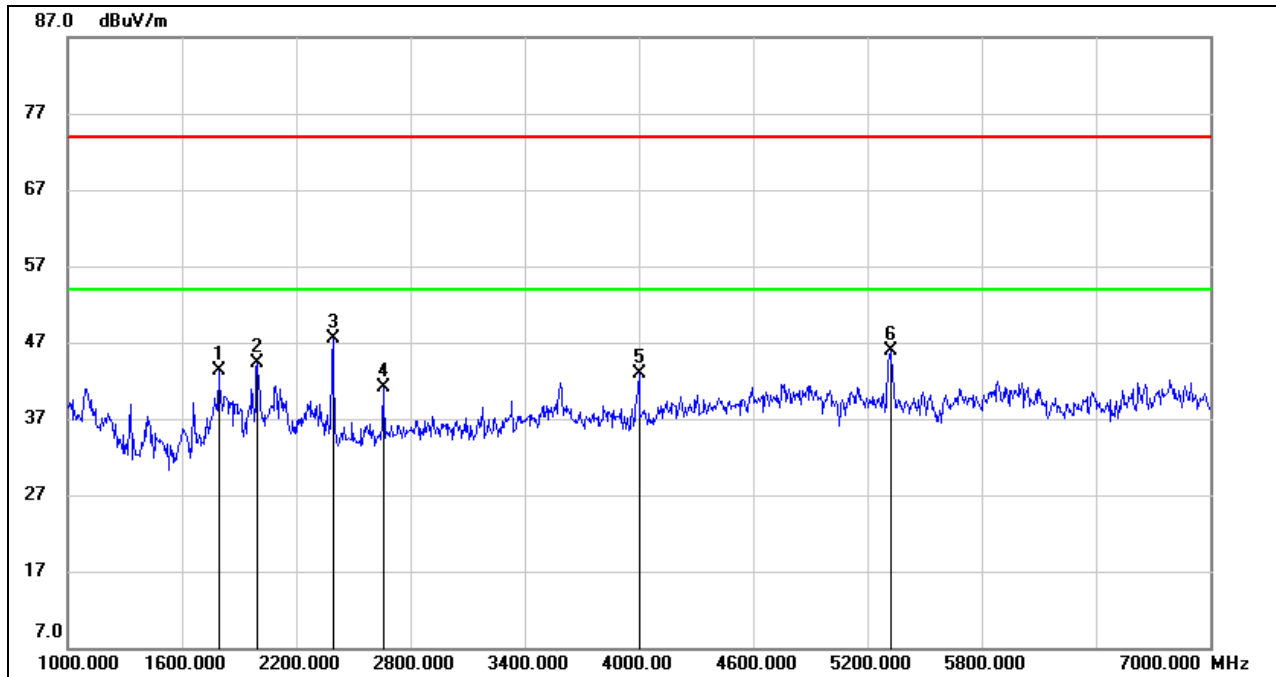

No.	Frequency (MHz)	Reading (dBuV)	Correct (dB/m)	Result (dBuV/m)	Limit (dBuV/m)	Margin (dB)	Remark
1	1792.000	53.42	-10.16	43.26	74.00	-30.74	peak
2	1996.000	54.56	-10.24	44.32	74.00	-29.68	peak
3	2392.000	56.09	-8.63	47.46	74.00	-26.54	peak
4	2656.000	48.89	-7.83	41.06	74.00	-32.94	peak
5	4000.000	46.71	-3.74	42.97	74.00	-31.03	peak
6	5320.000	44.24	1.70	45.94	74.00	-28.06	peak

Note: 1. Measurement = Reading Level + Correct Factor.
 2. If Peak Result complies with AV limit, AV Result is deemed to comply with AV limit.
 3. Peak: Peak detector.
 4. Filter losses were only considered in the spurious frequency bands and the authorized band was not corrected for Band reject filter losses.
 5. Proper operation of the transmitter prior to adding the filter to the measurement chain.
 6. Owing to the highest peak level of unwanted emission out of the restricted bands complies with the lowest limit(54dBuV/m), so all the test point was deemed to comply with the limits list in the standard.



7-18GHz

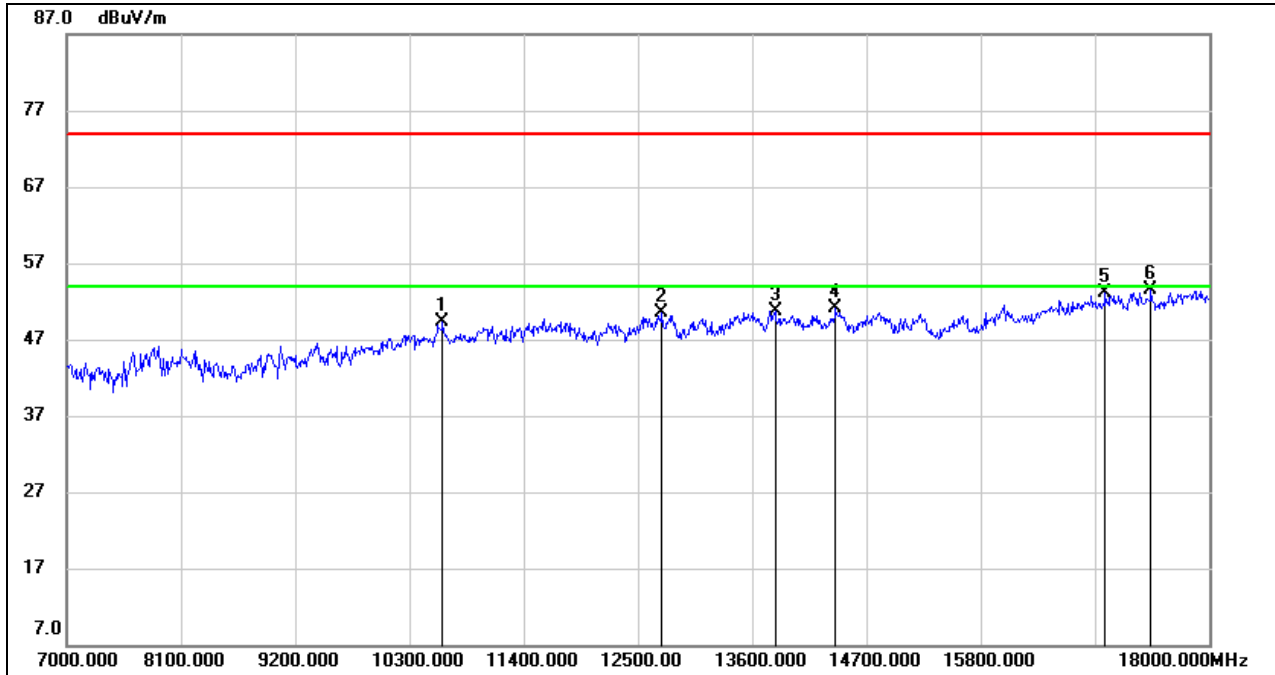

No.	Frequency (MHz)	Reading (dBuV)	Correct (dB/m)	Result (dBuV/m)	Limit (dBuV/m)	Margin (dB)	Remark
1	10619.000	36.90	12.32	49.22	74.00	-24.78	peak
2	12731.000	35.44	14.97	50.41	74.00	-23.59	peak
3	13820.000	33.81	16.89	50.70	74.00	-23.30	peak
4	14403.000	34.47	16.68	51.15	74.00	-22.85	peak
5	16999.000	32.46	20.64	53.10	74.00	-20.90	peak
6	17439.000	31.93	21.49	53.42	74.00	-20.58	peak

Note: 1. Measurement = Reading Level + Correct Factor.
 2. If Peak Result complies with AV limit, AV Result is deemed to comply with AV limit.
 3. Peak: Peak detector.
 4. Filter losses were only considered in the spurious frequency bands and the authorized band was not corrected for HPF losses.
 5. Proper operation of the transmitter prior to adding the filter to the measurement chain.
 6. Owing to the highest peak level of unwanted emission out of the restricted bands complies with the lowest limit(54dBuV/m), so all the test point was deemed to comply with the limits list in the standard.



HARMONICS AND SPURIOUS EMISSIONS MID CHANNEL

HORIZONTAL RESULTS
1-7GHz

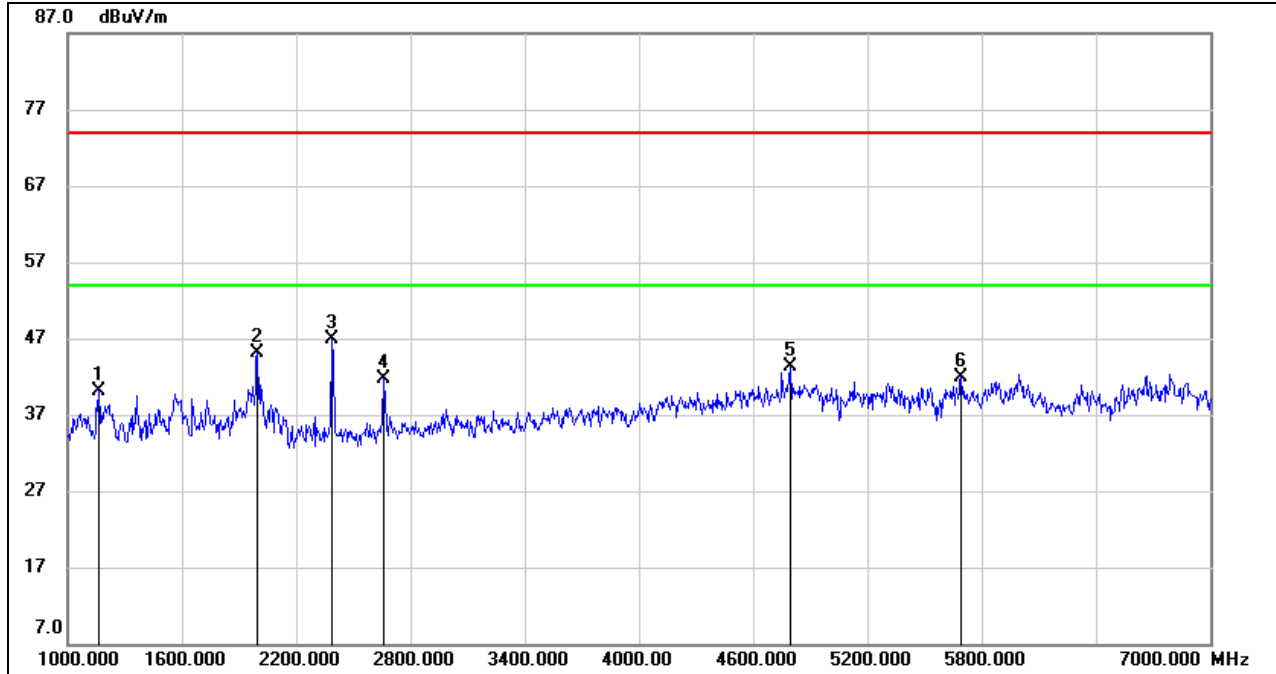

No.	Frequency (MHz)	Reading (dBuV)	Correct (dB/m)	Result (dBuV/m)	Limit (dBuV/m)	Margin (dB)	Remark
1	1162.000	53.46	-13.26	40.20	74.00	-33.80	peak
2	1996.000	55.34	-10.24	45.10	74.00	-28.90	peak
3	2386.000	55.65	-8.67	46.98	74.00	-27.02	peak
4	2656.000	49.55	-7.83	41.72	74.00	-32.28	peak
5	4792.000	42.89	0.47	43.36	74.00	-30.64	peak
6	5692.000	39.92	1.98	41.90	74.00	-32.10	peak

- Note: 1. Measurement = Reading Level + Correct Factor.
 2. If Peak Result complies with AV limit, AV Result is deemed to comply with AV limit.
 3. Peak: Peak detector.
 4. Filter losses were only considered in the spurious frequency bands and the authorized band was not corrected for Band reject filter losses.
 5. Proper operation of the transmitter prior to adding the filter to the measurement chain.
 6. Owing to the highest peak level of unwanted emission out of the restricted bands complies with the lowest limit(54dBuV/m), so all the test point was deemed to comply with the limits list in the standard.



HORIZONTAL RESULTS
7-18GHz

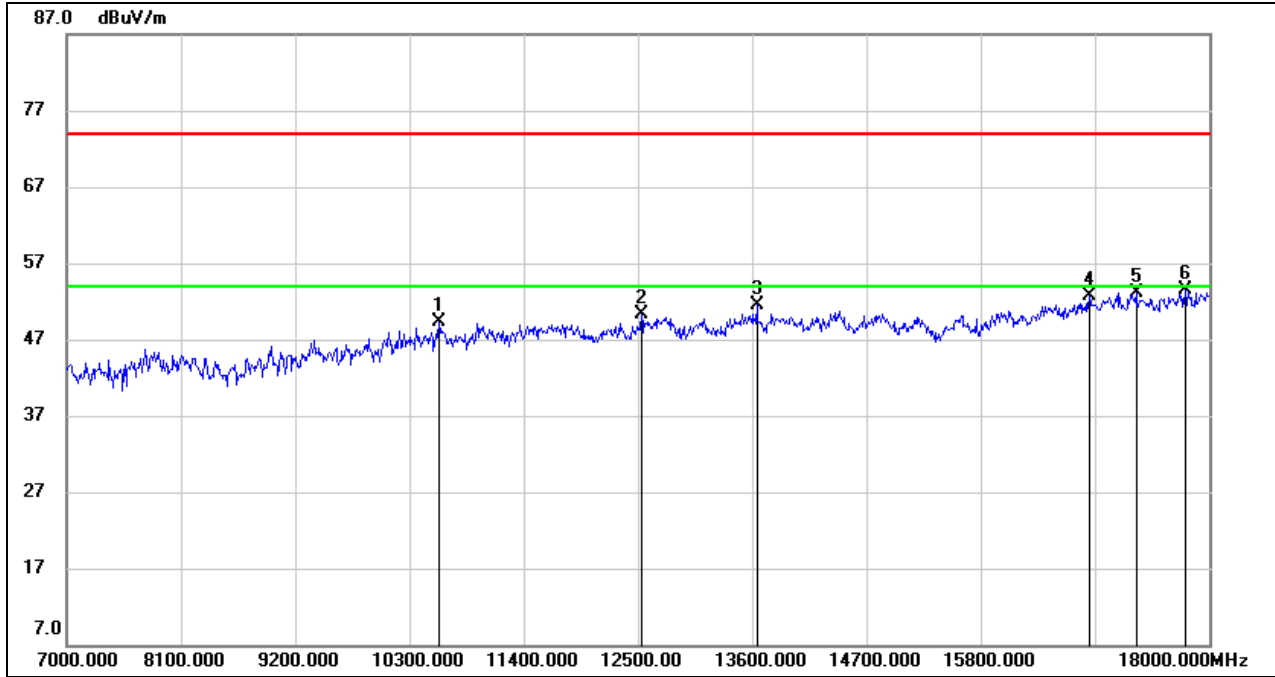

No.	Frequency (MHz)	Reading (dBuV)	Correct (dB/m)	Result (dBuV/m)	Limit (dBuV/m)	Margin (dB)	Remark
1	10586.000	36.99	12.30	49.29	74.00	-24.71	peak
2	12533.000	35.73	14.65	50.38	74.00	-23.62	peak
3	13644.000	35.38	16.08	51.46	74.00	-22.54	peak
4	16845.000	32.50	20.15	52.65	74.00	-21.35	peak
5	17296.000	31.23	21.86	53.09	74.00	-20.91	peak
6	17769.000	30.35	23.12	53.47	74.00	-20.53	peak

Note: 1. Measurement = Reading Level + Correct Factor.
 2. If Peak Result complies with AV limit, AV Result is deemed to comply with AV limit.
 3. Peak: Peak detector.
 4. Filter losses were only considered in the spurious frequency bands and the authorized band was not corrected for HPF losses.
 5. Proper operation of the transmitter prior to adding the filter to the measurement chain.
 6. Owing to the highest peak level of unwanted emission out of the restricted bands complies with the lowest limit(54dBuV/m), so all the test point was deemed to comply with the limits list in the standard.



VERTICAL RESULTS
1-7GHz

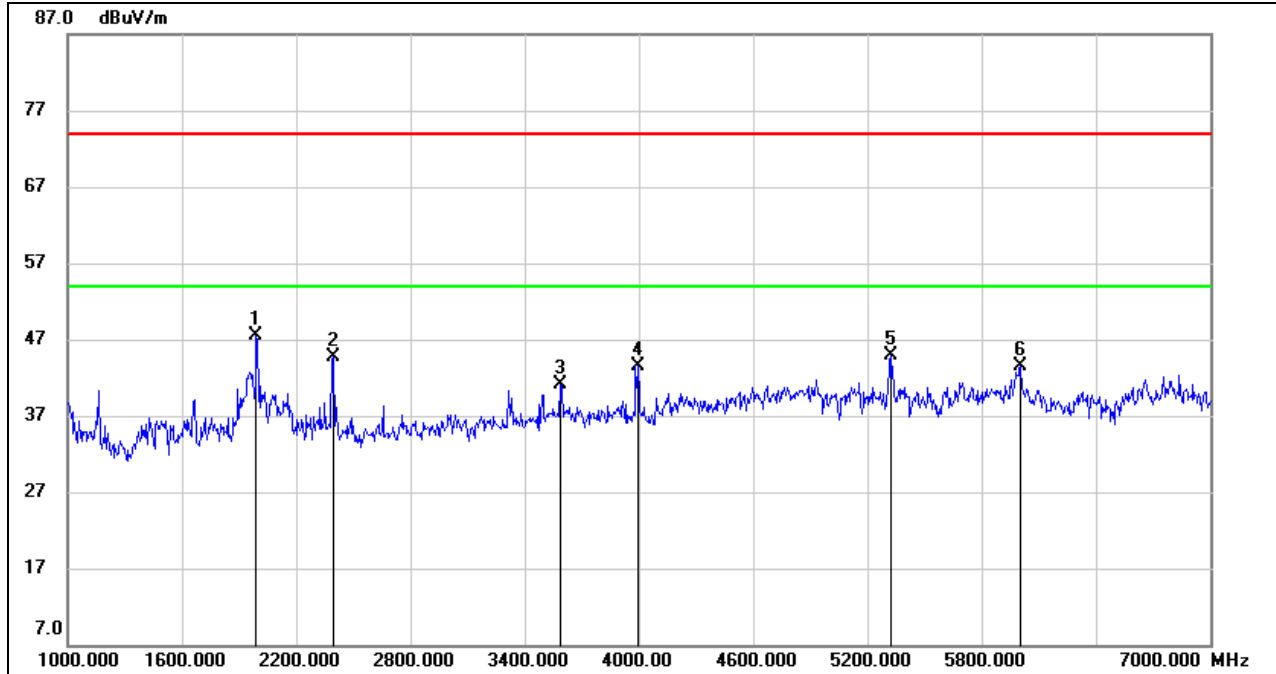

No.	Frequency (MHz)	Reading (dBuV)	Correct (dB/m)	Result (dBuV/m)	Limit (dBuV/m)	Margin (dB)	Remark
1	1990.000	57.65	-10.24	47.41	74.00	-26.59	peak
2	2392.000	53.30	-8.63	44.67	74.00	-29.33	peak
3	3586.000	45.74	-4.55	41.19	74.00	-32.81	peak
4	3994.000	47.21	-3.73	43.48	74.00	-30.52	peak
5	5320.000	43.23	1.70	44.93	74.00	-29.07	peak
6	6004.000	40.88	2.61	43.49	74.00	-30.51	peak

Note: 1. Measurement = Reading Level + Correct Factor.
 2. If Peak Result complies with AV limit, AV Result is deemed to comply with AV limit.
 3. Peak: Peak detector.
 4. Filter losses were only considered in the spurious frequency bands and the authorized band was not corrected for Band reject filter losses.
 5. Proper operation of the transmitter prior to adding the filter to the measurement chain.
 6. Owing to the highest peak level of unwanted emission out of the restricted bands complies with the lowest limit(54dBuV/m), so all the test point was deemed to comply with the limits list in the standard.



7-18GHz

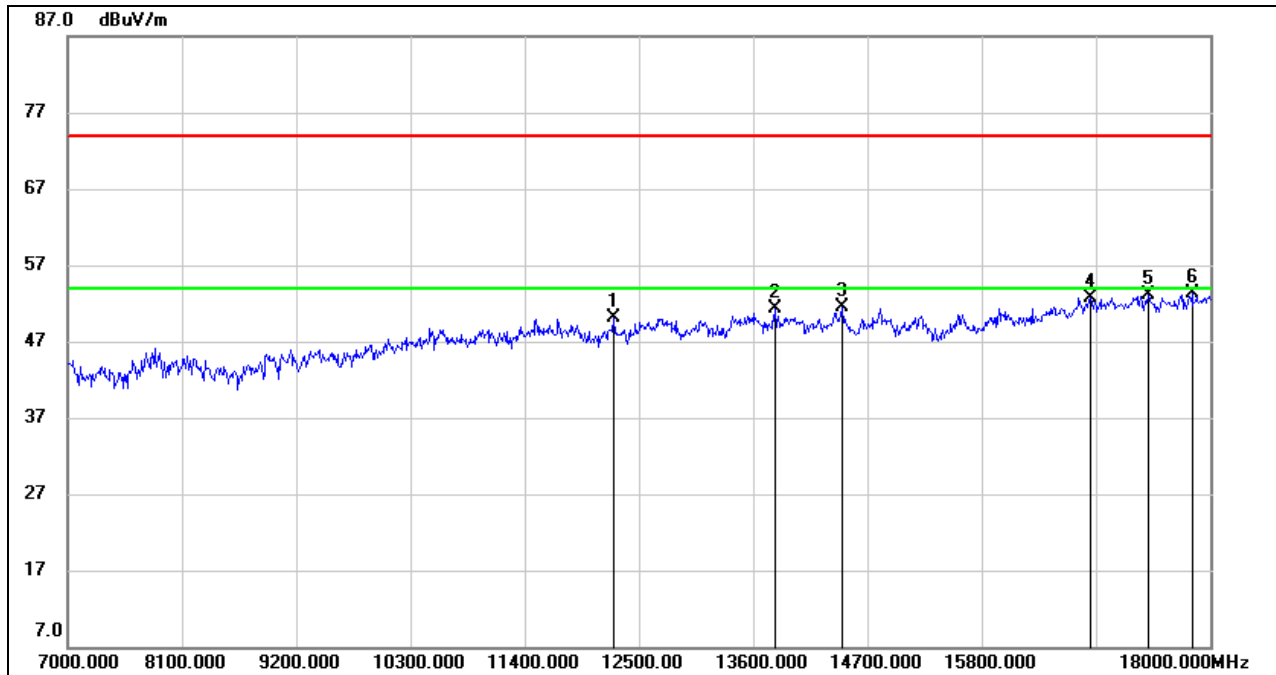

No.	Frequency (MHz)	Reading (dBuV)	Correct (dB/m)	Result (dBuV/m)	Limit (dBuV/m)	Margin (dB)	Remark
1	12258.000	36.02	14.14	50.16	74.00	-23.84	peak
2	13809.000	34.23	16.99	51.22	74.00	-22.78	peak
3	14458.000	34.81	16.62	51.43	74.00	-22.57	peak
4	16845.000	32.48	20.15	52.63	74.00	-21.37	peak
5	17406.000	31.57	21.53	53.10	74.00	-20.90	peak
6	17824.000	29.81	23.42	53.23	74.00	-20.77	peak

Note: 1. Measurement = Reading Level + Correct Factor.
 2. If Peak Result complies with AV limit, AV Result is deemed to comply with AV limit.
 3. Peak: Peak detector.
 4. Filter losses were only considered in the spurious frequency bands and the authorized band was not corrected for HPF losses.
 5. Proper operation of the transmitter prior to adding the filter to the measurement chain.
 6. Owing to the highest peak level of unwanted emission out of the restricted bands complies with the lowest limit(54dBuV/m), so all the test point was deemed to comply with the limits list in the standard.



HARMONICS AND SPURIOUS EMISSIONS HIGH CHANNEL

HORIZONTAL RESULTS
1-7GHz

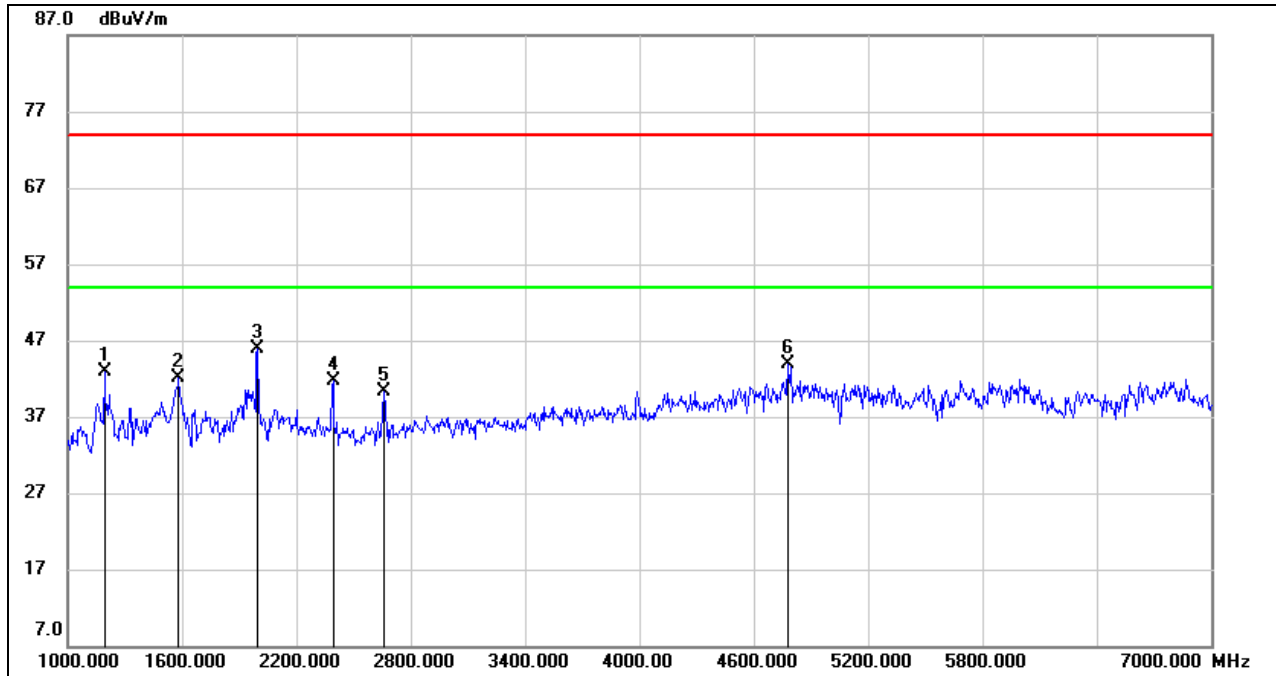

No.	Frequency (MHz)	Reading (dBuV)	Correct (dB/m)	Result (dBuV/m)	Limit (dBuV/m)	Margin (dB)	Remark
1	1192.000	56.02	-13.10	42.92	74.00	-31.08	peak
2	1582.000	53.89	-11.74	42.15	74.00	-31.85	peak
3	1996.000	56.12	-10.24	45.88	74.00	-28.12	peak
4	2392.000	50.37	-8.63	41.74	74.00	-32.26	peak
5	2656.000	48.18	-7.83	40.35	74.00	-33.65	peak
6	4780.000	43.45	0.41	43.86	74.00	-30.14	peak

Note: 1. Measurement = Reading Level + Correct Factor.
 2. If Peak Result complies with AV limit, AV Result is deemed to comply with AV limit.
 3. Peak: Peak detector.
 4. Filter losses were only considered in the spurious frequency bands and the authorized band was not corrected for Band reject filter losses.
 5. Proper operation of the transmitter prior to adding the filter to the measurement chain.
 6. Owing to the highest peak level of unwanted emission out of the restricted bands complies with the lowest limit(54dBuV/m), so all the test point was deemed to comply with the limits list in the standard.



HORIZONTAL RESULTS
7-18GHz

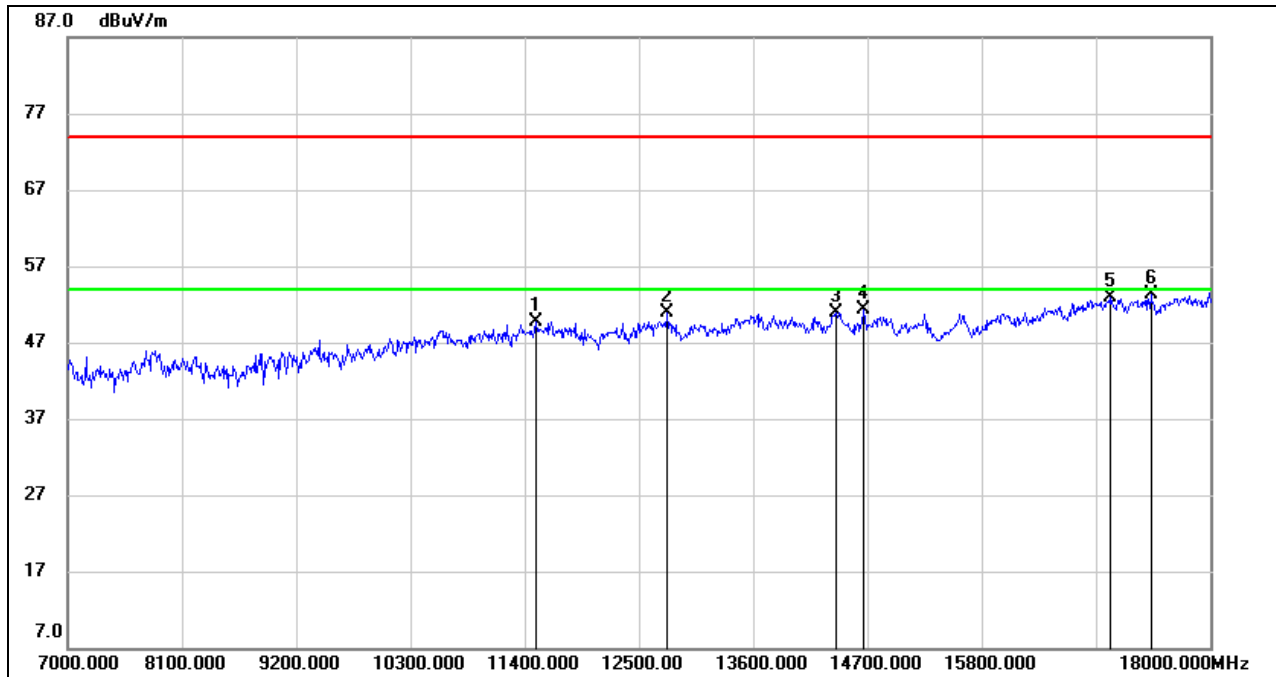

No.	Frequency (MHz)	Reading (dBuV)	Correct (dB/m)	Result (dBuV/m)	Limit (dBuV/m)	Margin (dB)	Remark
1	11510.000	36.35	13.39	49.74	74.00	-24.26	peak
2	12775.000	35.19	15.74	50.93	74.00	-23.07	peak
3	14392.000	34.29	16.65	50.94	74.00	-23.06	peak
4	14667.000	35.16	16.16	51.32	74.00	-22.68	peak
5	17043.000	32.24	20.74	52.98	74.00	-21.02	peak
6	17428.000	31.82	21.50	53.32	74.00	-20.68	peak

Note: 1. Measurement = Reading Level + Correct Factor.
 2. If Peak Result complies with AV limit, AV Result is deemed to comply with AV limit.
 3. Peak: Peak detector.
 4. Filter losses were only considered in the spurious frequency bands and the authorized band was not corrected for HPF losses.
 5. Proper operation of the transmitter prior to adding the filter to the measurement chain.
 6. Owing to the highest peak level of unwanted emission out of the restricted bands complies with the lowest limit(54dBuV/m), so all the test point was deemed to comply with the limits list in the standard.



VERTICAL RESULTS
1-7GHz

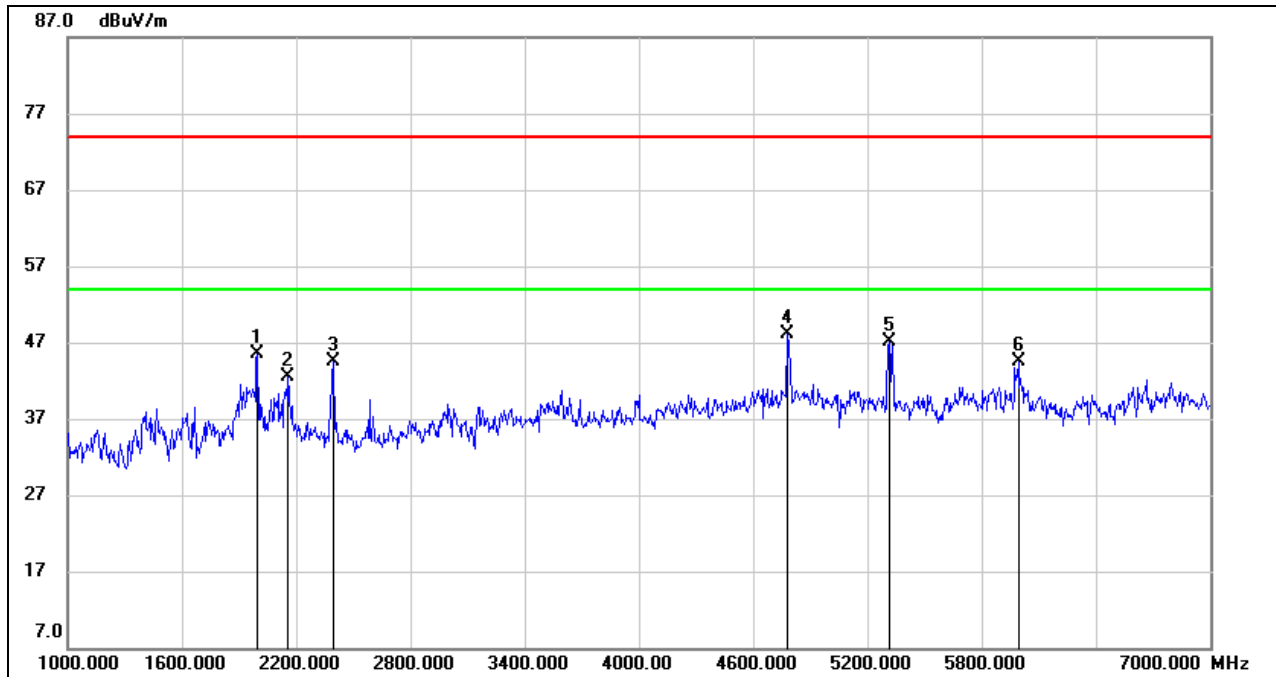

No.	Frequency (MHz)	Reading (dBuV)	Correct (dB/m)	Result (dBuV/m)	Limit (dBuV/m)	Margin (dB)	Remark
1	1996.000	55.84	-10.24	45.60	74.00	-28.40	peak
2	2158.000	51.86	-9.41	42.45	74.00	-31.55	peak
3	2398.000	53.07	-8.62	44.45	74.00	-29.55	peak
4	4780.000	47.76	0.41	48.17	74.00	-25.83	peak
5	5314.000	45.47	1.73	47.20	74.00	-26.80	peak
6	5992.000	41.92	2.58	44.50	74.00	-29.50	peak

Note: 1. Measurement = Reading Level + Correct Factor.
 2. If Peak Result complies with AV limit, AV Result is deemed to comply with AV limit.
 3. Peak: Peak detector.
 4. Filter losses were only considered in the spurious frequency bands and the authorized band was not corrected for Band reject filter losses.
 5. Proper operation of the transmitter prior to adding the filter to the measurement chain.
 6. Owing to the highest peak level of unwanted emission out of the restricted bands complies with the lowest limit(54dBuV/m), so all the test point was deemed to comply with the limits list in the standard.



7-18GHz

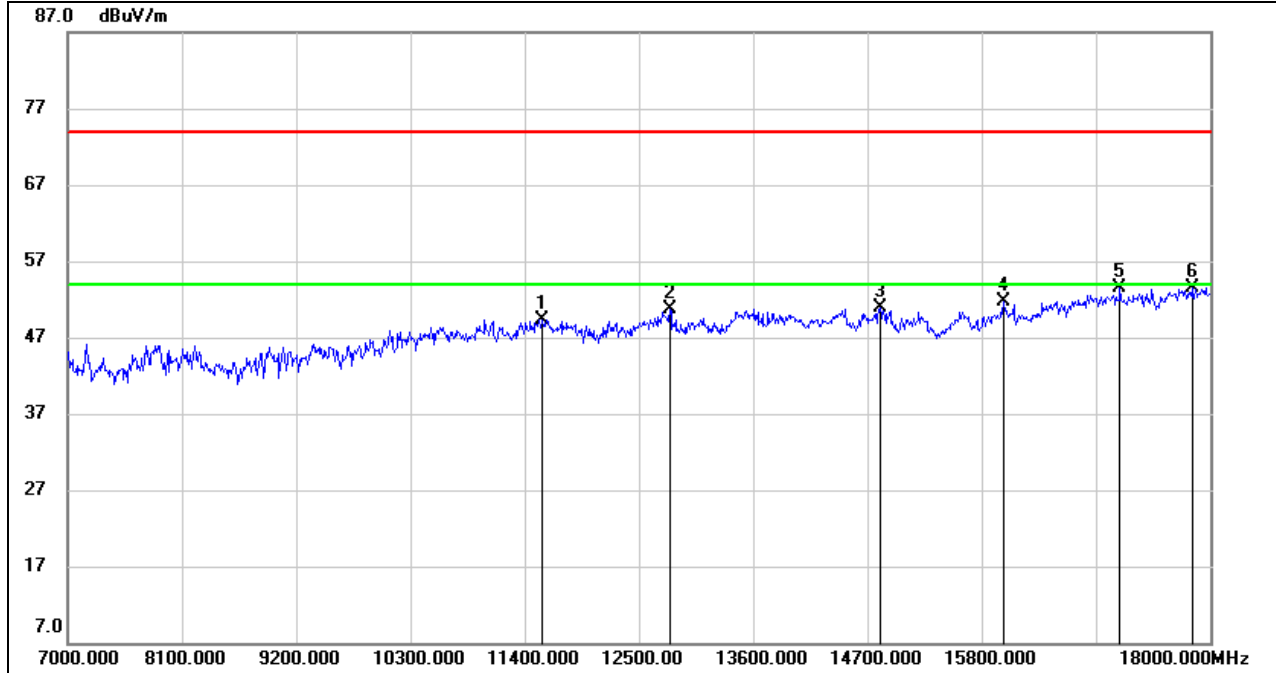

No.	Frequency (MHz)	Reading (dBuV)	Correct (dB/m)	Result (dBuV/m)	Limit (dBuV/m)	Margin (dB)	Remark
1	11565.000	35.86	13.47	49.33	74.00	-24.67	peak
2	12797.000	34.50	16.12	50.62	74.00	-23.38	peak
3	14821.000	34.79	16.09	50.88	74.00	-23.12	peak
4	16009.000	33.92	17.85	51.77	74.00	-22.23	peak
5	17131.000	32.50	20.98	53.48	74.00	-20.52	peak
6	17824.000	30.08	23.42	53.50	74.00	-20.50	peak

Note: 1. Measurement = Reading Level + Correct Factor.
 2. If Peak Result complies with AV limit, AV Result is deemed to comply with AV limit.
 3. Peak: Peak detector.
 4. Filter losses were only considered in the spurious frequency bands and the authorized band was not corrected for HPF losses.
 5. Proper operation of the transmitter prior to adding the filter to the measurement chain.
 6. Owing to the highest peak level of unwanted emission out of the restricted bands complies with the lowest limit(54dBuV/m), so all the test point was deemed to comply with the limits list in the standard.



8.1.4. UNII-3 BAND
WORST CASE FOR ANT2

RESTRICTED BANDEDGE LOW CHANNEL

HORIZONTAL RESULTS
PEAK

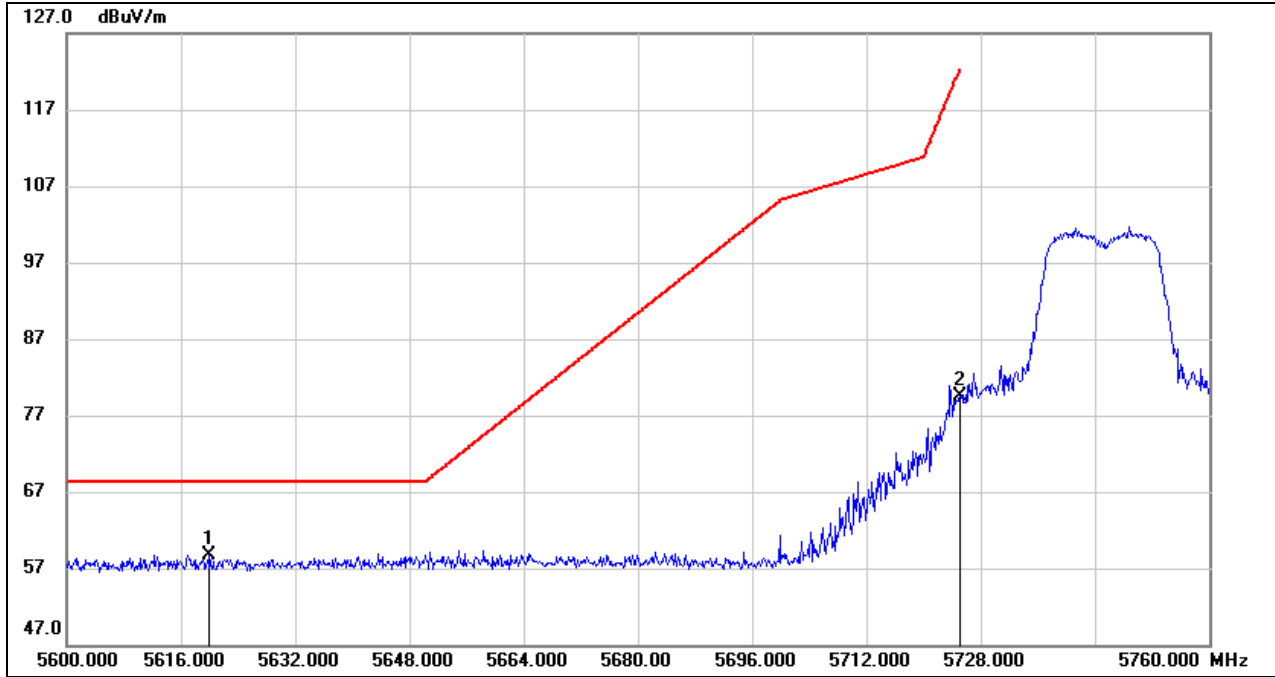

No.	Frequency (MHz)	Reading (dBuV)	Correct (dB/m)	Result (dBuV/m)	Limit (dBuV/m)	Margin (dB)	Remark
1	5620.000	17.32	41.46	58.78	68.20	-9.42	peak
2	5725.000	37.93	41.61	79.54	122.20	-42.66	peak

Note: 1. Measurement = Reading Level + Correct Factor.



VERTICAL RESULTS
PEAK

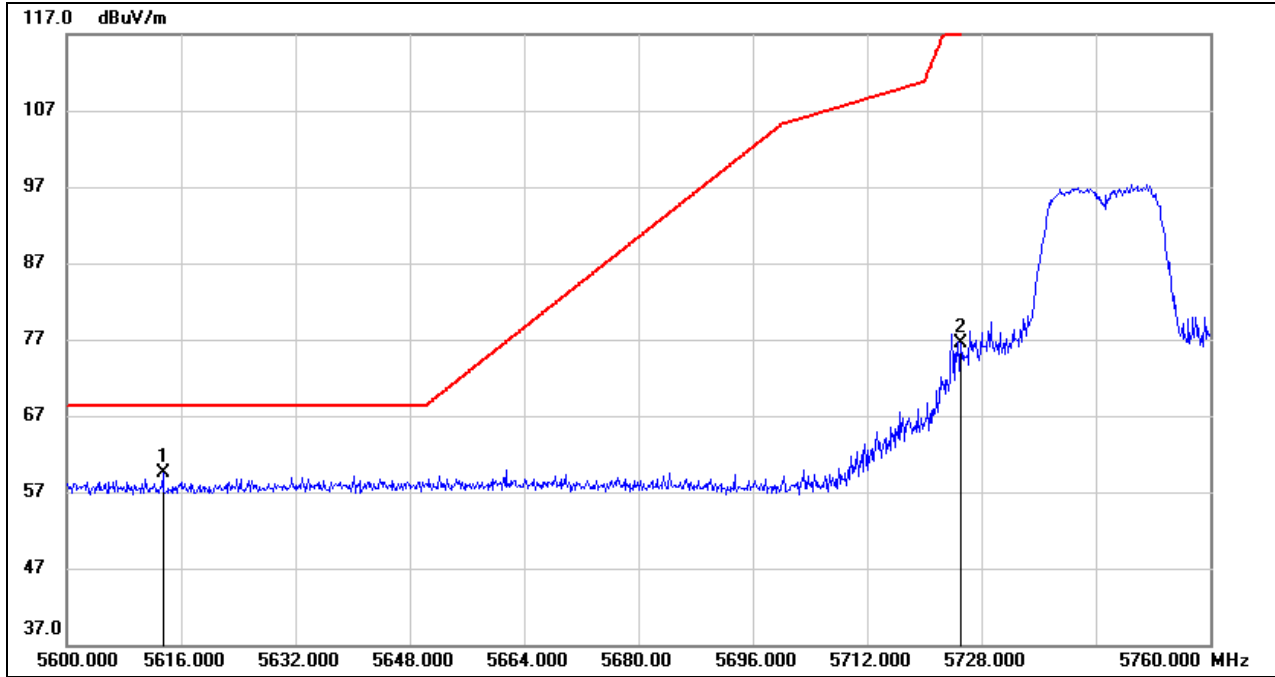

No.	Frequency (MHz)	Reading (dBuV)	Correct (dB/m)	Result (dBuV/m)	Limit (dBuV/m)	Margin (dB)	Remark
1	5613.440	17.98	41.47	59.45	68.20	-8.75	peak
2	5725.000	34.86	41.61	76.47	122.20	-45.73	peak

Note: 1. Measurement = Reading Level + Correct Factor.



RESTRICTED BANDEDGE HIGH CHANNEL

HORIZONTAL RESULTS
PEAK

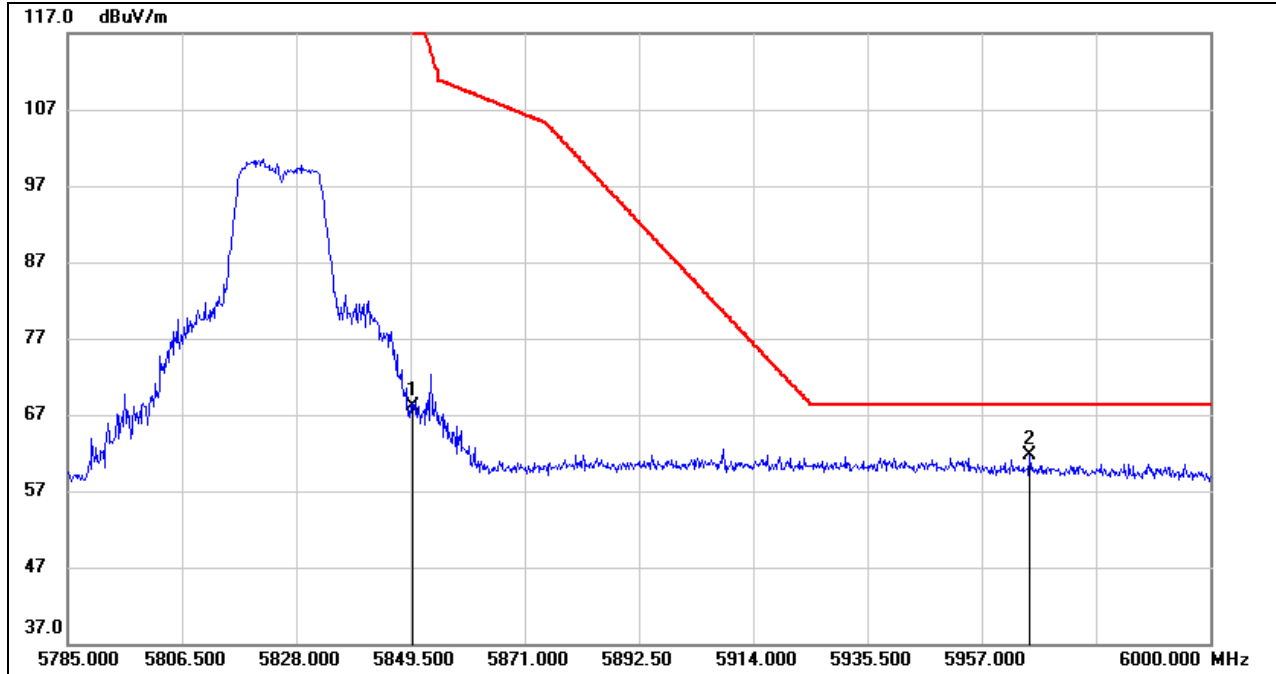

No.	Frequency (MHz)	Reading (dBuV)	Correct (dB/m)	Result (dBuV/m)	Limit (dBuV/m)	Margin (dB)	Remark
1	5850.000	25.17	42.89	68.06	122.20	-54.14	peak
2	5966.030	18.97	42.72	61.69	68.20	-6.51	peak

Note: 1. Measurement = Reading Level + Correct Factor.



VERTICAL RESULTS
PEAK

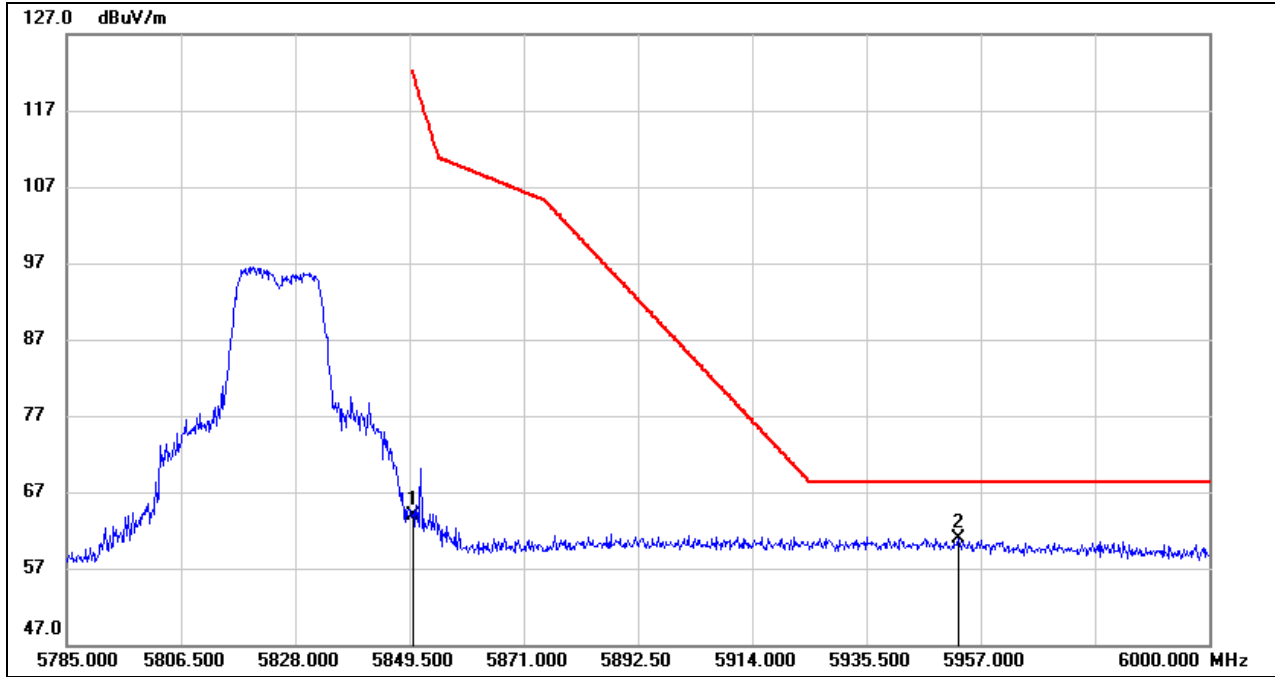

No.	Frequency (MHz)	Reading (dBuV)	Correct (dB/m)	Result (dBuV/m)	Limit (dBuV/m)	Margin (dB)	Remark
1	5850.000	21.06	42.89	63.95	122.20	-58.25	peak
2	5952.700	18.04	42.95	60.99	68.20	-7.21	peak

Note: 1. Measurement = Reading Level + Correct Factor.



HARMONICS AND SPURIOUS EMISSIONS LOW CHANNEL

HORIZONTAL RESULTS
1-7GHz

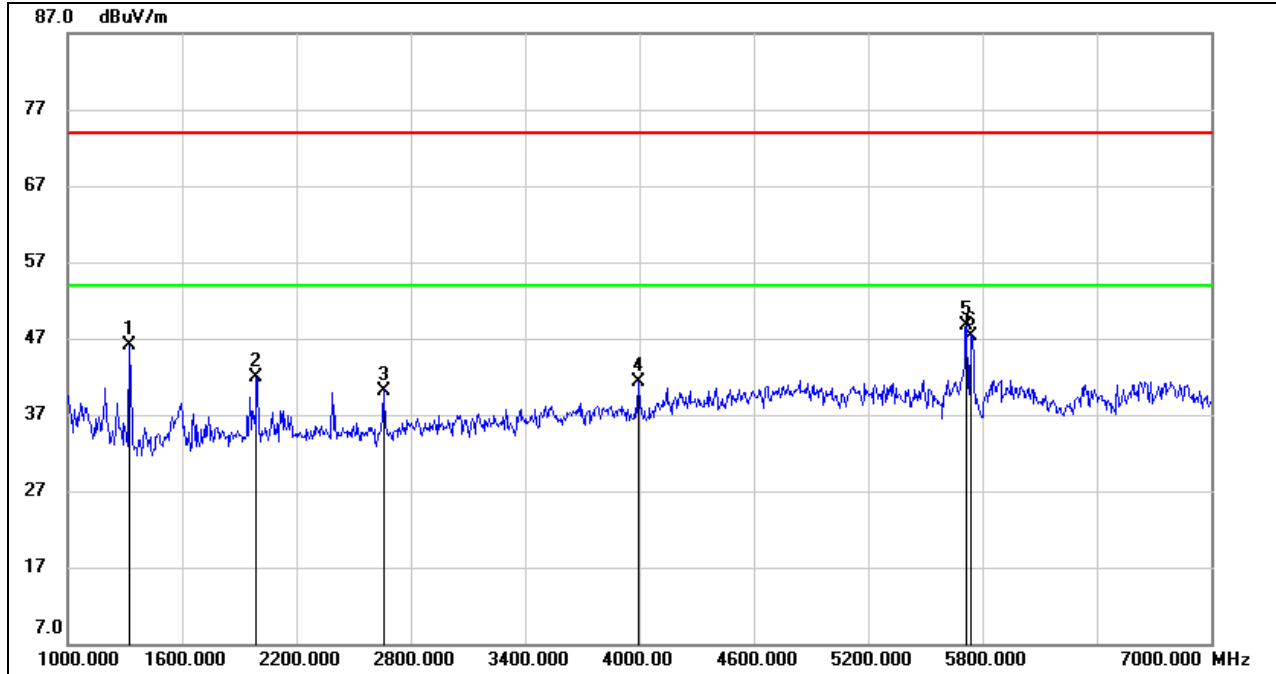

No.	Frequency (MHz)	Reading (dBuV)	Correct (dB/m)	Result (dBuV/m)	Limit (dBuV/m)	Margin (dB)	Remark
1	1324.000	58.94	-12.89	46.05	74.00	-27.95	peak
2	1990.000	52.08	-10.24	41.84	74.00	-32.16	peak
3	2656.000	48.03	-7.83	40.20	74.00	-33.80	peak
4	3994.000	44.94	-3.73	41.21	74.00	-32.79	peak
5	5716.000	46.66	1.97	48.63	74.00	-25.37	peak
6	5745.000	45.38	1.96	47.34	74.00	-26.66	peak

Note: 1. Measurement = Reading Level + Correct Factor.
 2. If Peak Result complies with AV limit, AV Result is deemed to comply with AV limit.
 3. Peak: Peak detector.
 4. Filter losses were only considered in the spurious frequency bands and the authorized band was not corrected for Band reject filter losses.
 5. Proper operation of the transmitter prior to adding the filter to the measurement chain.
 6. Owing to the highest peak level of unwanted emission out of the restricted bands complies with the lowest limit(54dBuV/m), so all the test point was deemed to comply with the limits list in the standard.



HORIZONTAL RESULTS
7-18GHz

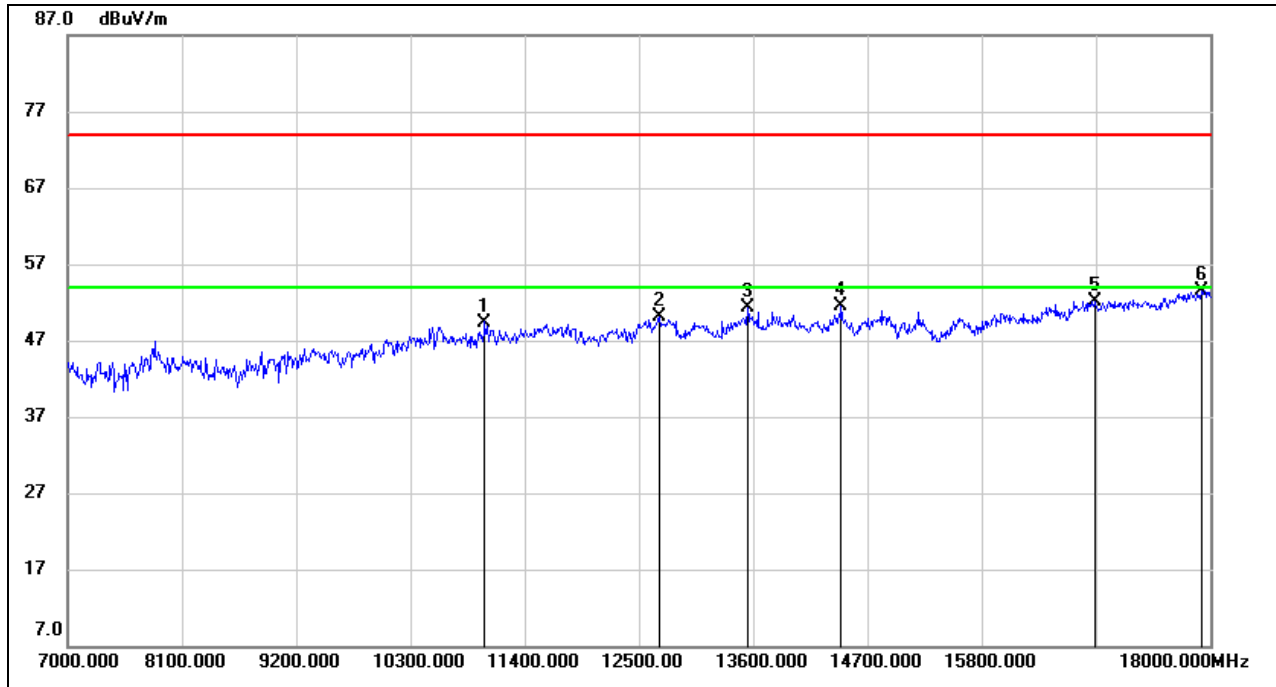

No.	Frequency (MHz)	Reading (dBuV)	Correct (dB/m)	Result (dBuV/m)	Limit (dBuV/m)	Margin (dB)	Remark
1	11015.000	36.77	12.63	49.40	74.00	-24.60	peak
2	12698.000	35.75	14.44	50.19	74.00	-23.81	peak
3	13545.000	35.29	15.98	51.27	74.00	-22.73	peak
4	14447.000	34.85	16.63	51.48	74.00	-22.52	peak
5	16889.000	32.08	20.11	52.19	74.00	-21.81	peak
6	17912.000	30.13	23.42	53.55	74.00	-20.45	peak

Note: 1. Measurement = Reading Level + Correct Factor.
 2. If Peak Result complies with AV limit, AV Result is deemed to comply with AV limit.
 3. Peak: Peak detector.
 4. Filter losses were only considered in the spurious frequency bands and the authorized band was not corrected for HPF losses.
 5. Proper operation of the transmitter prior to adding the filter to the measurement chain.
 6. Owing to the highest peak level of unwanted emission out of the restricted bands complies with the lowest limit(54dBuV/m), so all the test point was deemed to comply with the limits list in the standard.



VERTICAL RESULTS
1-7GHz

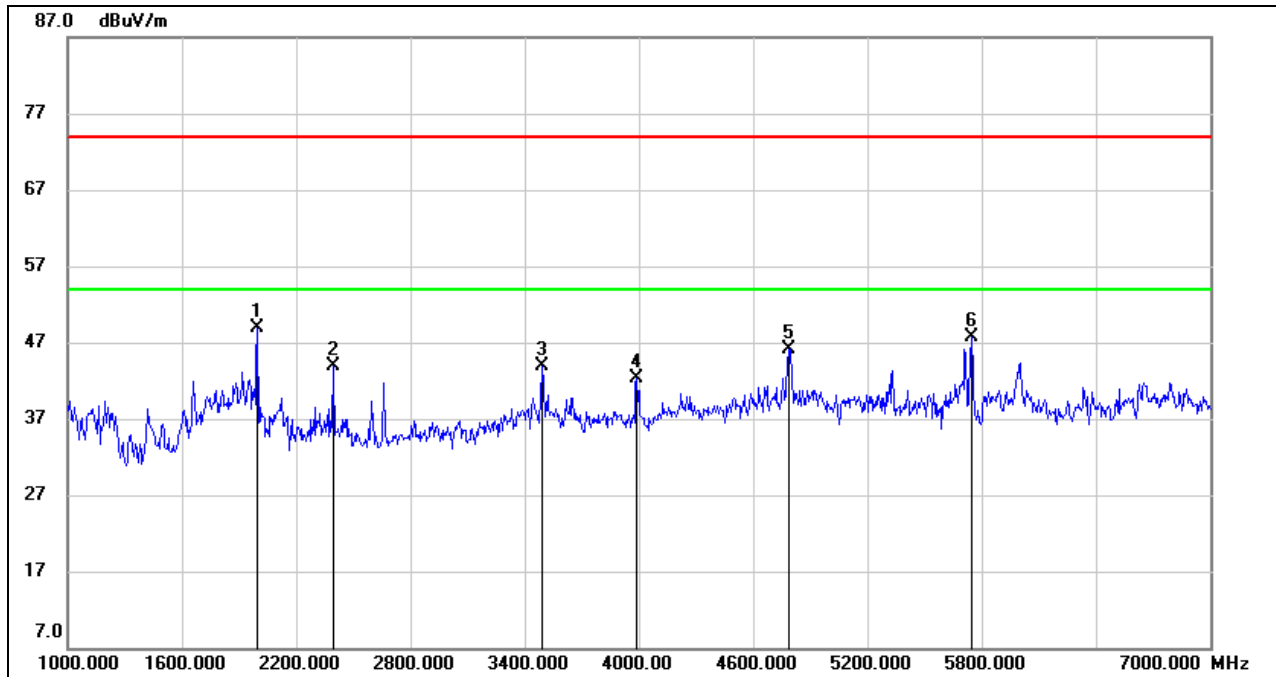

No.	Frequency (MHz)	Reading (dBuV)	Correct (dB/m)	Result (dBuV/m)	Limit (dBuV/m)	Margin (dB)	Remark
1	1996.000	59.11	-10.24	48.87	74.00	-25.13	peak
2	2392.000	52.51	-8.63	43.88	74.00	-30.12	peak
3	3490.000	48.87	-5.06	43.81	74.00	-30.19	peak
4	3988.000	46.02	-3.72	42.30	74.00	-31.70	peak
5	4786.000	45.75	0.44	46.19	74.00	-27.81	peak
6	5745.000	45.70	1.96	47.66	74.00	-26.34	peak

Note: 1. Measurement = Reading Level + Correct Factor.
 2. If Peak Result complies with AV limit, AV Result is deemed to comply with AV limit.
 3. Peak: Peak detector.
 4. Filter losses were only considered in the spurious frequency bands and the authorized band was not corrected for Band reject filter losses.
 5. Proper operation of the transmitter prior to adding the filter to the measurement chain.
 6. Owing to the highest peak level of unwanted emission out of the restricted bands complies with the lowest limit(54dBuV/m), so all the test point was deemed to comply with the limits list in the standard.



7-18GHz

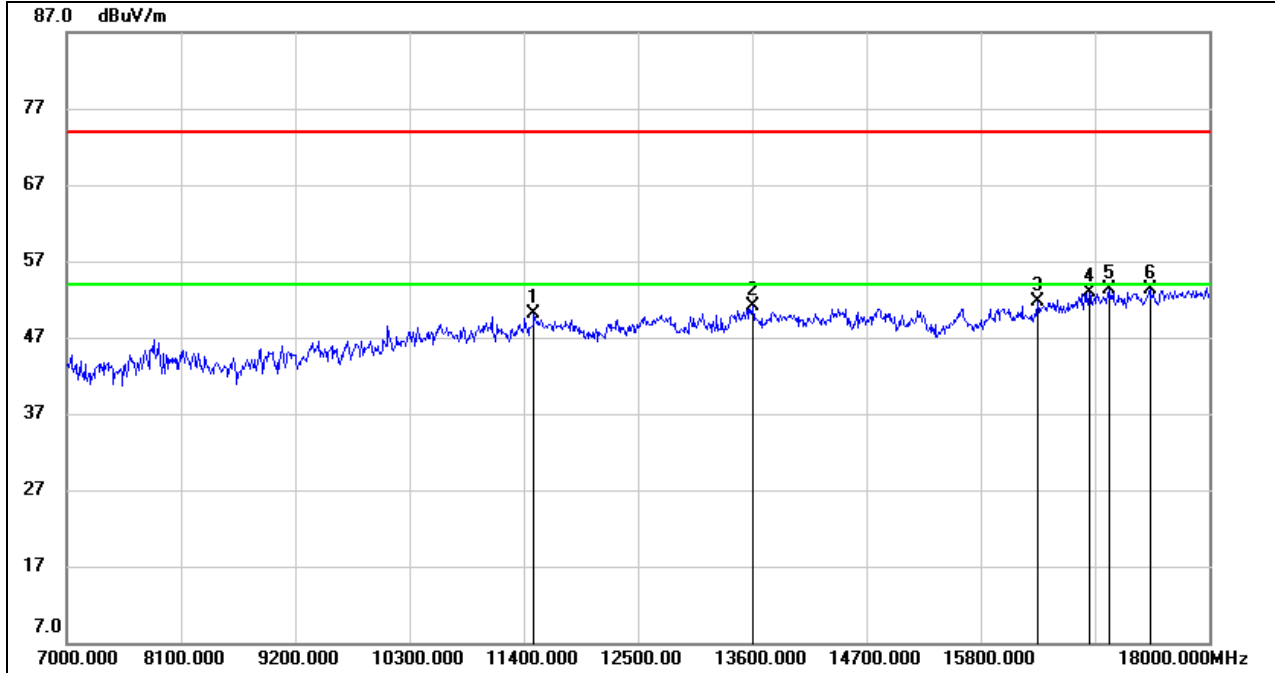

No.	Frequency (MHz)	Reading (dBuV)	Correct (dB/m)	Result (dBuV/m)	Limit (dBuV/m)	Margin (dB)	Remark
1	11499.000	36.80	13.35	50.15	74.00	-23.85	peak
2	13611.000	35.04	16.10	51.14	74.00	-22.86	peak
3	16350.000	32.86	18.86	51.72	74.00	-22.28	peak
4	16845.000	32.79	20.15	52.94	74.00	-21.06	peak
5	17043.000	32.58	20.74	53.32	74.00	-20.68	peak
6	17428.000	31.73	21.50	53.23	74.00	-20.77	peak

Note: 1. Measurement = Reading Level + Correct Factor.
 2. If Peak Result complies with AV limit, AV Result is deemed to comply with AV limit.
 3. Peak: Peak detector.
 4. Filter losses were only considered in the spurious frequency bands and the authorized band was not corrected for HPF losses.
 5. Proper operation of the transmitter prior to adding the filter to the measurement chain.
 6. Owing to the highest peak level of unwanted emission out of the restricted bands complies with the lowest limit(54dBuV/m), so all the test point was deemed to comply with the limits list in the standard.



HARMONICS AND SPURIOUS EMISSIONS MID CHANNEL

HORIZONTAL RESULTS
1-7GHz

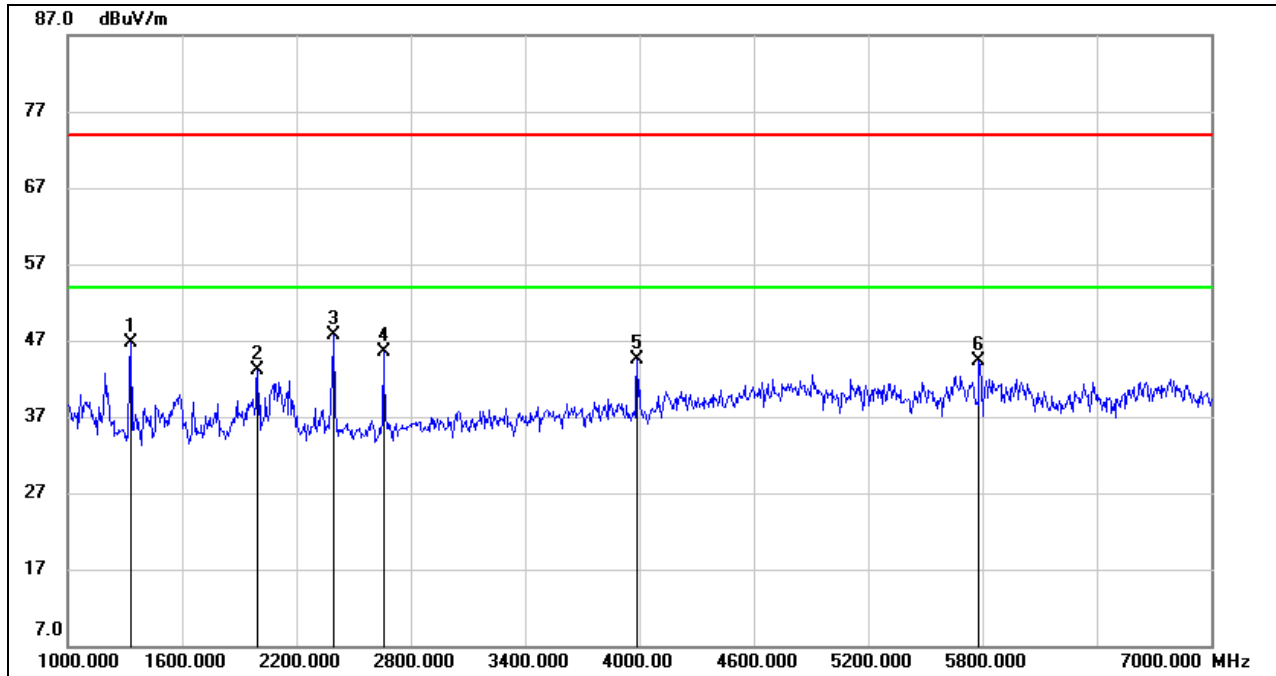

No.	Frequency (MHz)	Reading (dBuV)	Correct (dB/m)	Result (dBuV/m)	Limit (dBuV/m)	Margin (dB)	Remark
1	1330.000	59.64	-12.88	46.76	74.00	-27.24	peak
2	1996.000	53.28	-10.24	43.04	74.00	-30.96	peak
3	2398.000	56.26	-8.62	47.64	74.00	-26.36	peak
4	2656.000	53.27	-7.83	45.44	74.00	-28.56	peak
5	3988.000	48.19	-3.72	44.47	74.00	-29.53	peak
6	5785.000	42.34	1.95	44.29	74.00	-29.71	peak

- Note: 1. Measurement = Reading Level + Correct Factor.
 2. If Peak Result complies with AV limit, AV Result is deemed to comply with AV limit.
 3. Peak: Peak detector.
 4. Filter losses were only considered in the spurious frequency bands and the authorized band was not corrected for Band reject filter losses.
 5. Proper operation of the transmitter prior to adding the filter to the measurement chain.
 6. Owing to the highest peak level of unwanted emission out of the restricted bands complies with the lowest limit(54dBuV/m), so all the test point was deemed to comply with the limits list in the standard.



HORIZONTAL RESULTS
7-18GHz

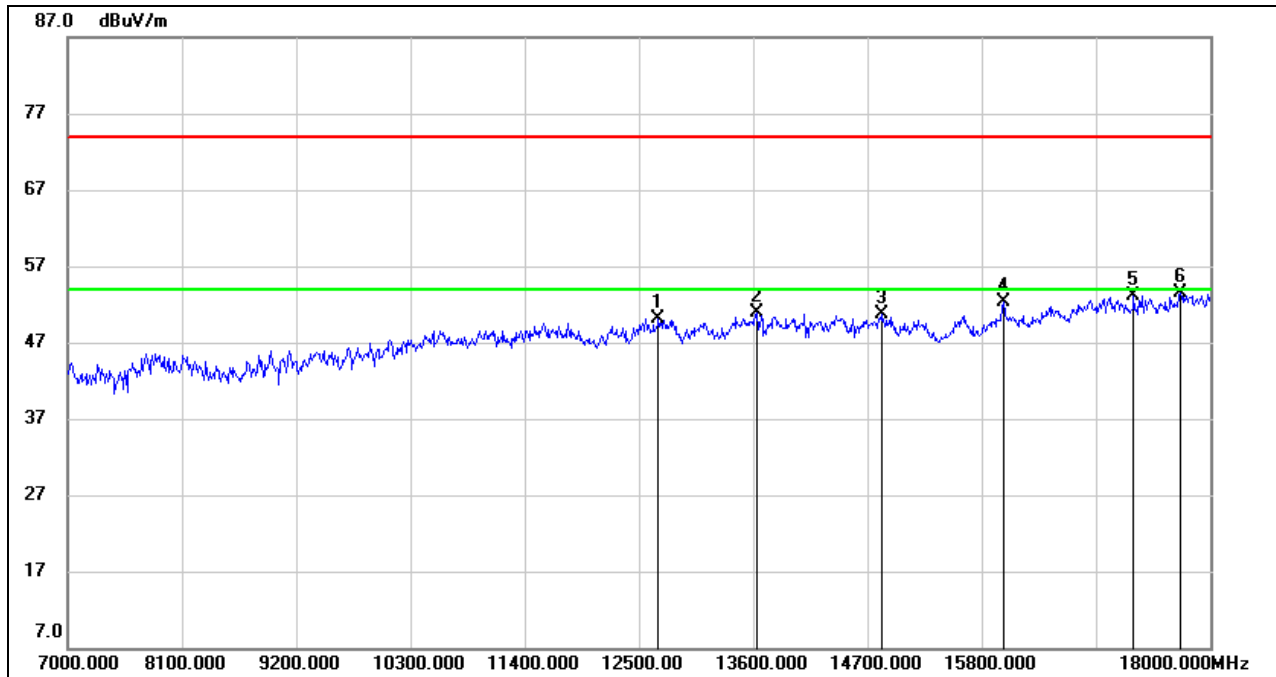

No.	Frequency (MHz)	Reading (dBuV)	Correct (dB/m)	Result (dBuV/m)	Limit (dBuV/m)	Margin (dB)	Remark
1	12687.000	35.68	14.40	50.08	74.00	-23.92	peak
2	13633.000	34.89	16.09	50.98	74.00	-23.02	peak
3	14832.000	34.63	16.10	50.73	74.00	-23.27	peak
4	16009.000	34.50	17.85	52.35	74.00	-21.65	peak
5	17263.000	31.56	21.64	53.20	74.00	-20.80	peak
6	17714.000	30.83	22.62	53.45	74.00	-20.55	peak

Note: 1. Measurement = Reading Level + Correct Factor.
 2. If Peak Result complies with AV limit, AV Result is deemed to comply with AV limit.
 3. Peak: Peak detector.
 4. Filter losses were only considered in the spurious frequency bands and the authorized band was not corrected for HPF losses.
 5. Proper operation of the transmitter prior to adding the filter to the measurement chain.
 6. Owing to the highest peak level of unwanted emission out of the restricted bands complies with the lowest limit(54dBuV/m), so all the test point was deemed to comply with the limits list in the standard.



VERTICAL RESULTS
1-7GHz

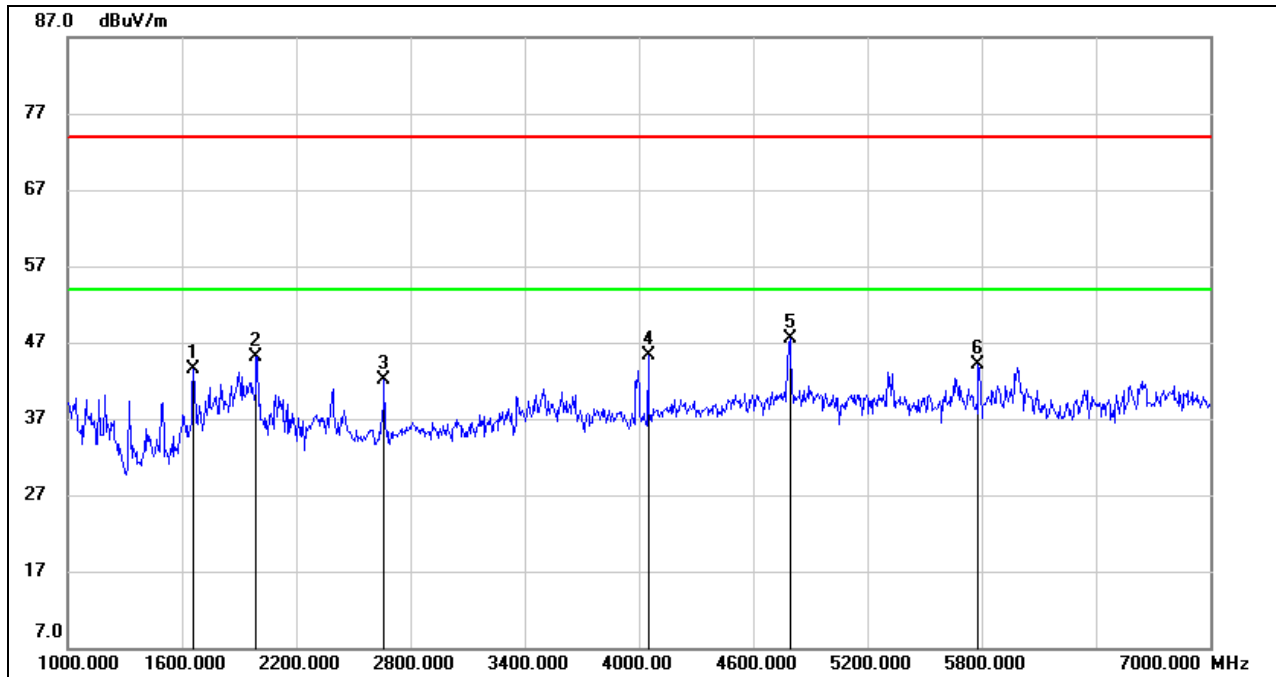

No.	Frequency (MHz)	Reading (dBuV)	Correct (dB/m)	Result (dBuV/m)	Limit (dBuV/m)	Margin (dB)	Remark
1	1660.000	54.63	-11.16	43.47	74.00	-30.53	peak
2	1990.000	55.36	-10.24	45.12	74.00	-28.88	peak
3	2662.000	49.82	-7.80	42.02	74.00	-31.98	peak
4	4048.000	48.57	-3.27	45.30	74.00	-28.70	peak
5	4792.000	47.05	0.47	47.52	74.00	-26.48	peak
6	5785.000	42.19	1.95	44.14	74.00	-29.86	peak

Note: 1. Measurement = Reading Level + Correct Factor.
 2. If Peak Result complies with AV limit, AV Result is deemed to comply with AV limit.
 3. Peak: Peak detector.
 4. Filter losses were only considered in the spurious frequency bands and the authorized band was not corrected for Band reject filter losses.
 5. Proper operation of the transmitter prior to adding the filter to the measurement chain.
 6. Owing to the highest peak level of unwanted emission out of the restricted bands complies with the lowest limit(54dBuV/m), so all the test point was deemed to comply with the limits list in the standard.



7-18GHz

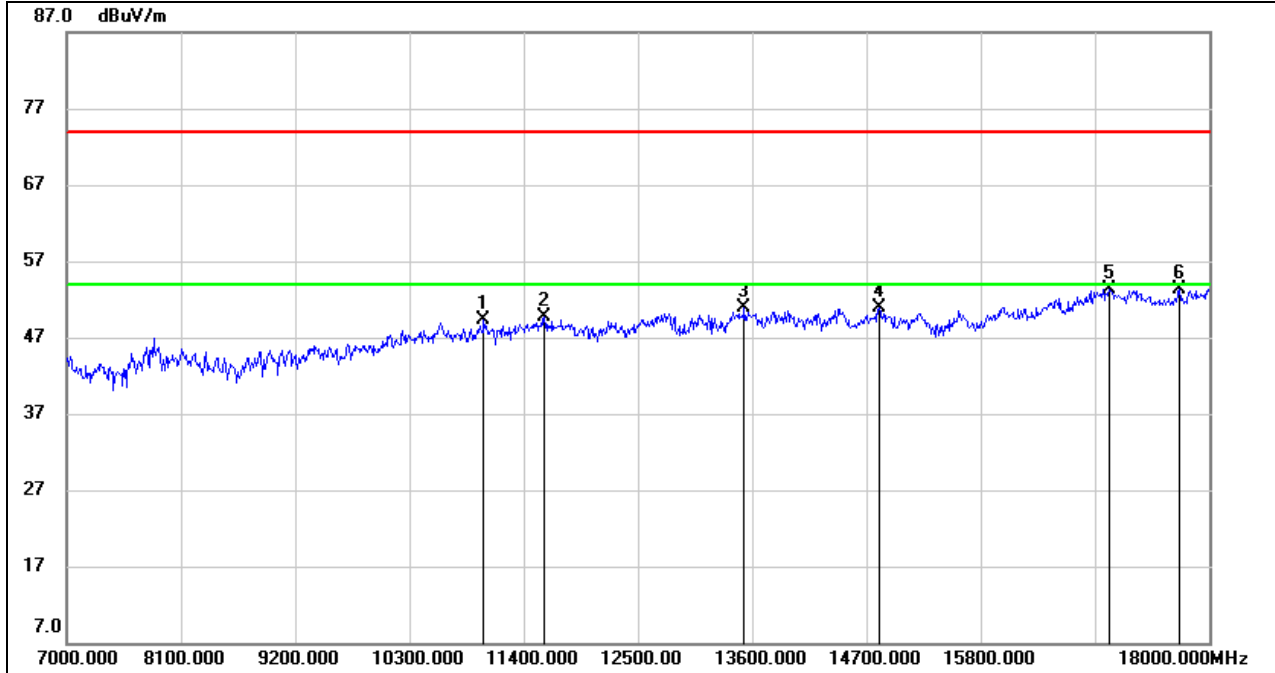

No.	Frequency (MHz)	Reading (dBuV)	Correct (dB/m)	Result (dBuV/m)	Limit (dBuV/m)	Margin (dB)	Remark
1	11015.000	36.60	12.63	49.23	74.00	-24.77	peak
2	11598.000	36.21	13.54	49.75	74.00	-24.25	peak
3	13523.000	34.94	15.94	50.88	74.00	-23.12	peak
4	14821.000	34.73	16.09	50.82	74.00	-23.18	peak
5	17032.000	32.54	20.72	53.26	74.00	-20.74	peak
6	17714.000	30.61	22.62	53.23	74.00	-20.77	peak

Note: 1. Measurement = Reading Level + Correct Factor.
 2. If Peak Result complies with AV limit, AV Result is deemed to comply with AV limit.
 3. Peak: Peak detector.
 4. Filter losses were only considered in the spurious frequency bands and the authorized band was not corrected for HPF losses.
 5. Proper operation of the transmitter prior to adding the filter to the measurement chain.
 6. Owing to the highest peak level of unwanted emission out of the restricted bands complies with the lowest limit(54dBuV/m), so all the test point was deemed to comply with the limits list in the standard.



HARMONICS AND SPURIOUS EMISSIONS HIGH CHANNEL

HORIZONTAL RESULTS
1-7GHz

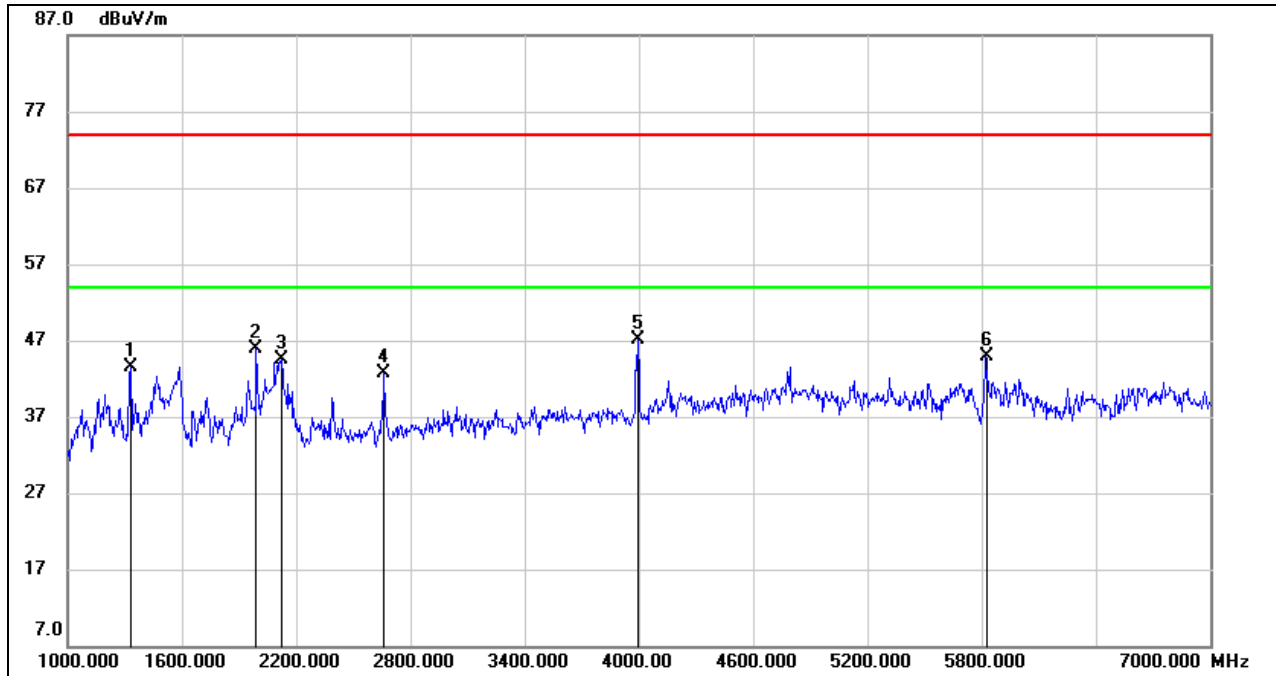

No.	Frequency (MHz)	Reading (dBuV)	Correct (dB/m)	Result (dBuV/m)	Limit (dBuV/m)	Margin (dB)	Remark
1	1330.000	56.41	-12.88	43.53	74.00	-30.47	peak
2	1990.000	56.13	-10.24	45.89	74.00	-28.11	peak
3	2122.000	54.12	-9.60	44.52	74.00	-29.48	peak
4	2662.000	50.56	-7.80	42.76	74.00	-31.24	peak
5	3994.000	50.92	-3.73	47.19	74.00	-26.81	peak
6	5825.000	42.83	2.03	44.86	74.00	-29.14	peak

Note: 1. Measurement = Reading Level + Correct Factor.
 2. If Peak Result complies with AV limit, AV Result is deemed to comply with AV limit.
 3. Peak: Peak detector.
 4. Filter losses were only considered in the spurious frequency bands and the authorized band was not corrected for Band reject filter losses.
 5. Proper operation of the transmitter prior to adding the filter to the measurement chain.
 6. Owing to the highest peak level of unwanted emission out of the restricted bands complies with the lowest limit(54dBuV/m), so all the test point was deemed to comply with the limits list in the standard.



HORIZONTAL RESULTS
7-18GHz

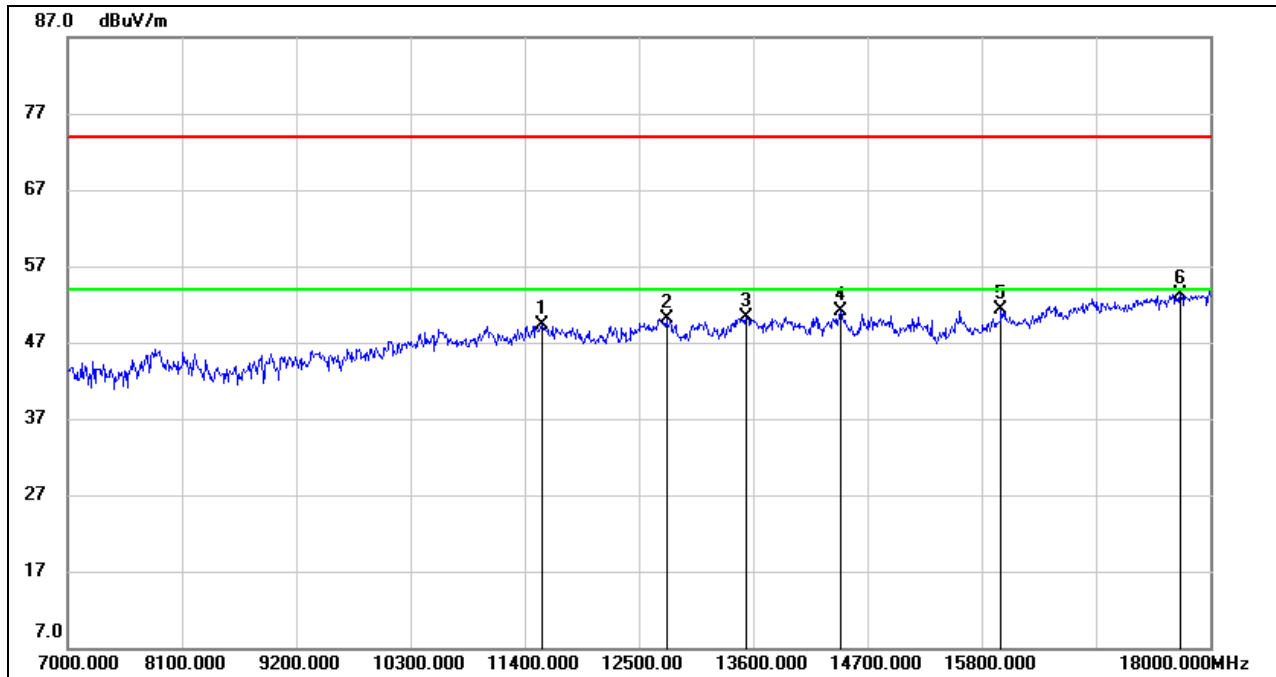

No.	Frequency (MHz)	Reading (dBuV)	Correct (dB/m)	Result (dBuV/m)	Limit (dBuV/m)	Margin (dB)	Remark
1	11565.000	35.78	13.47	49.25	74.00	-24.75	peak
2	12764.000	34.65	15.54	50.19	74.00	-23.81	peak
3	13534.000	34.35	15.97	50.32	74.00	-23.68	peak
4	14447.000	34.49	16.63	51.12	74.00	-22.88	peak
5	15987.000	33.48	17.79	51.27	74.00	-22.73	peak
6	17714.000	30.67	22.62	53.29	74.00	-20.71	peak

Note: 1. Measurement = Reading Level + Correct Factor.
 2. If Peak Result complies with AV limit, AV Result is deemed to comply with AV limit.
 3. Peak: Peak detector.
 4. Filter losses were only considered in the spurious frequency bands and the authorized band was not corrected for HPF losses.
 5. Proper operation of the transmitter prior to adding the filter to the measurement chain.
 6. Owing to the highest peak level of unwanted emission out of the restricted bands complies with the lowest limit(54dBuV/m), so all the test point was deemed to comply with the limits list in the standard.



VERTICAL RESULTS
1-7GHz

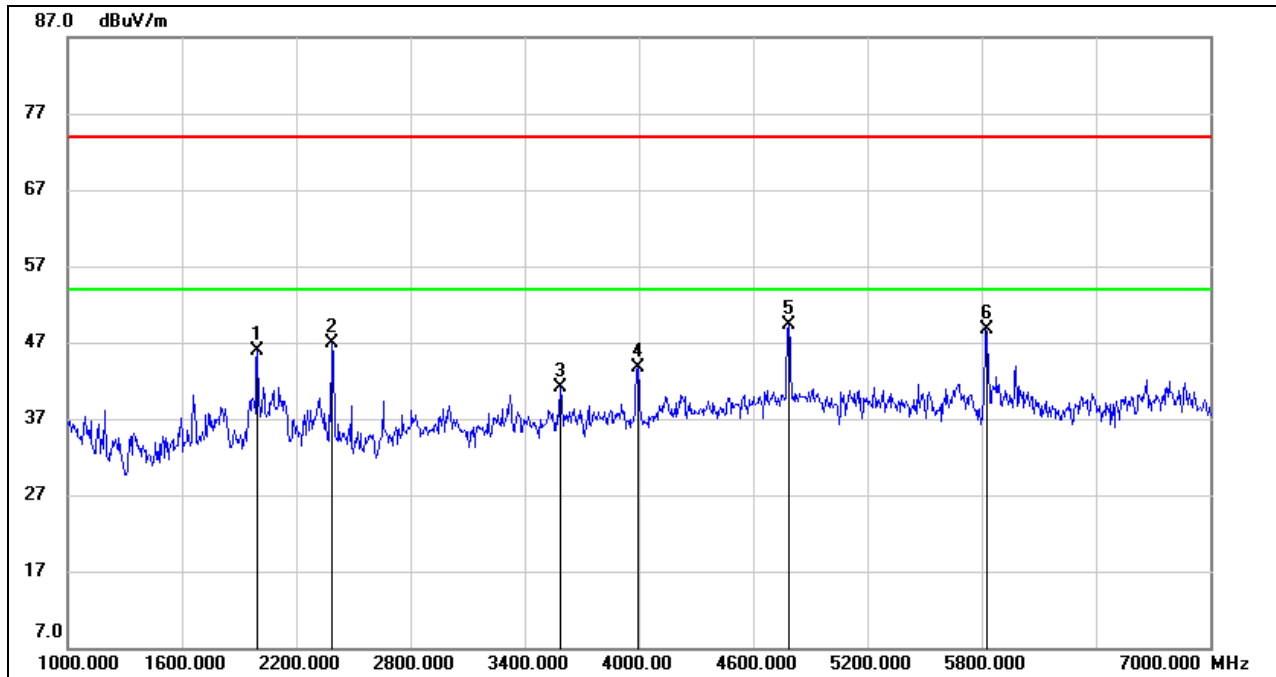

No.	Frequency (MHz)	Reading (dBuV)	Correct (dB/m)	Result (dBuV/m)	Limit (dBuV/m)	Margin (dB)	Remark
1	1996.000	56.22	-10.24	45.98	74.00	-28.02	peak
2	2386.000	55.52	-8.67	46.85	74.00	-27.15	peak
3	3586.000	45.72	-4.55	41.17	74.00	-32.83	peak
4	3994.000	47.48	-3.73	43.75	74.00	-30.25	peak
5	4786.000	48.87	0.44	49.31	74.00	-24.69	peak
6	5825.000	46.63	2.03	48.66	74.00	-25.34	peak

Note: 1. Measurement = Reading Level + Correct Factor.
 2. If Peak Result complies with AV limit, AV Result is deemed to comply with AV limit.
 3. Peak: Peak detector.
 4. Filter losses were only considered in the spurious frequency bands and the authorized band was not corrected for Band reject filter losses.
 5. Proper operation of the transmitter prior to adding the filter to the measurement chain.
 6. Owing to the highest peak level of unwanted emission out of the restricted bands complies with the lowest limit(54dBuV/m), so all the test point was deemed to comply with the limits list in the standard.



7-18GHz

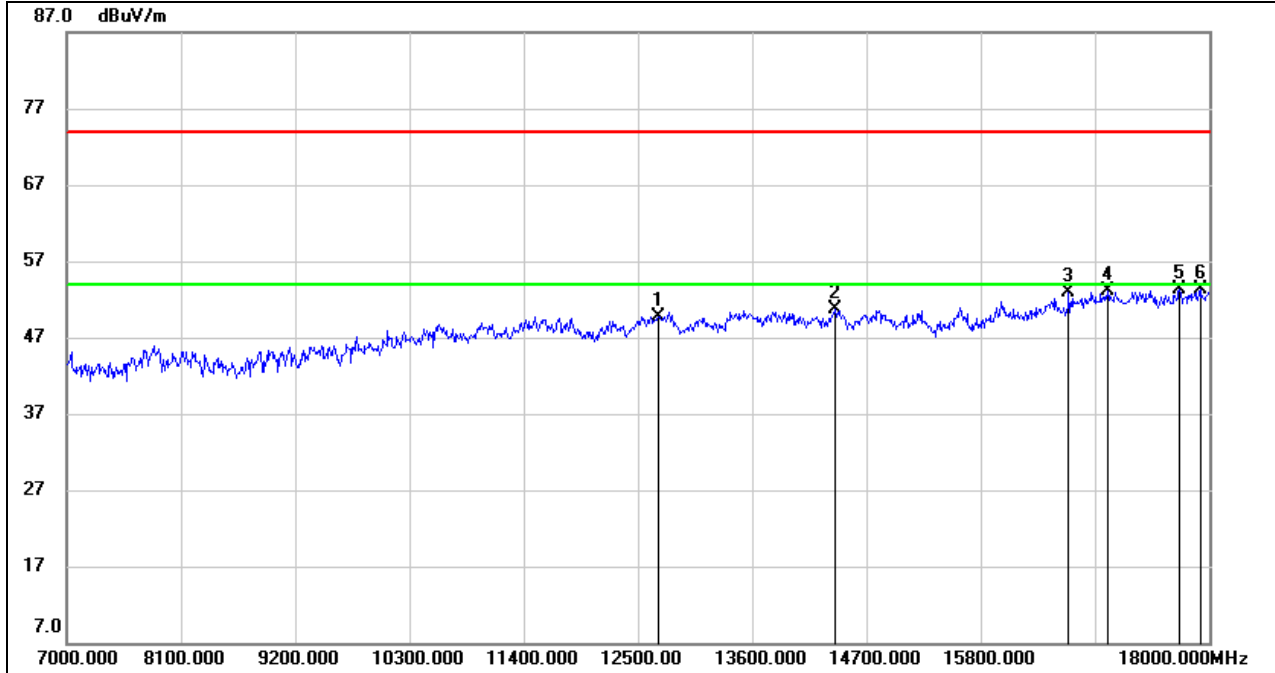

No.	Frequency (MHz)	Reading (dBuV)	Correct (dB/m)	Result (dBuV/m)	Limit (dBuV/m)	Margin (dB)	Remark
1	12698.000	35.27	14.44	49.71	74.00	-24.29	peak
2	14403.000	33.96	16.68	50.64	74.00	-23.36	peak
3	16647.000	33.19	19.80	52.99	74.00	-21.01	peak
4	17021.000	32.37	20.69	53.06	74.00	-20.94	peak
5	17714.000	30.65	22.62	53.27	74.00	-20.73	peak
6	17912.000	29.95	23.42	53.37	74.00	-20.63	peak

Note: 1. Measurement = Reading Level + Correct Factor.
 2. If Peak Result complies with AV limit, AV Result is deemed to comply with AV limit.
 3. Peak: Peak detector.
 4. Filter losses were only considered in the spurious frequency bands and the authorized band was not corrected for HPF losses.
 5. Proper operation of the transmitter prior to adding the filter to the measurement chain.
 6. Owing to the highest peak level of unwanted emission out of the restricted bands complies with the lowest limit(54dBuV/m), so all the test point was deemed to comply with the limits list in the standard.



8.2. 802.11ac VHT20 MODE

8.2.1. UNII-1 BAND

RESTRICTED BANDEDGE LOW CHANNEL

HORIZONTAL RESULTS PEAK

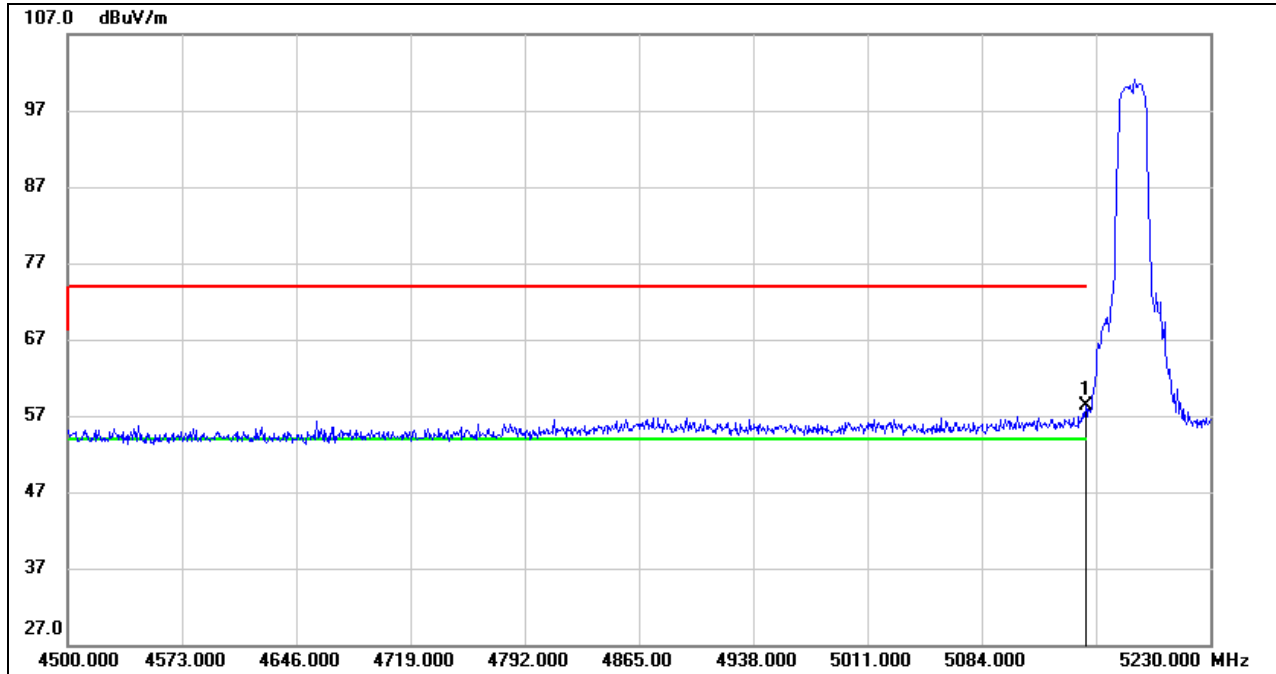

No.	Frequency (MHz)	Reading (dBuV)	Correct (dB/m)	Result (dBuV/m)	Limit (dBuV/m)	Margin (dB)	Remark
1	5150.000	17.84	40.46	58.30	74.00	-15.70	peak

- Note: 1. Measurement = Reading Level + Correct Factor.
 2. If Peak Result complies with AV limit, AV Result is deemed to comply with AV limit.
 3. Peak: Peak detector.
 4. Only the worst case emission will be recorder, if it complies with the limit, the other emissions deemed to comply with the limit.



AVG

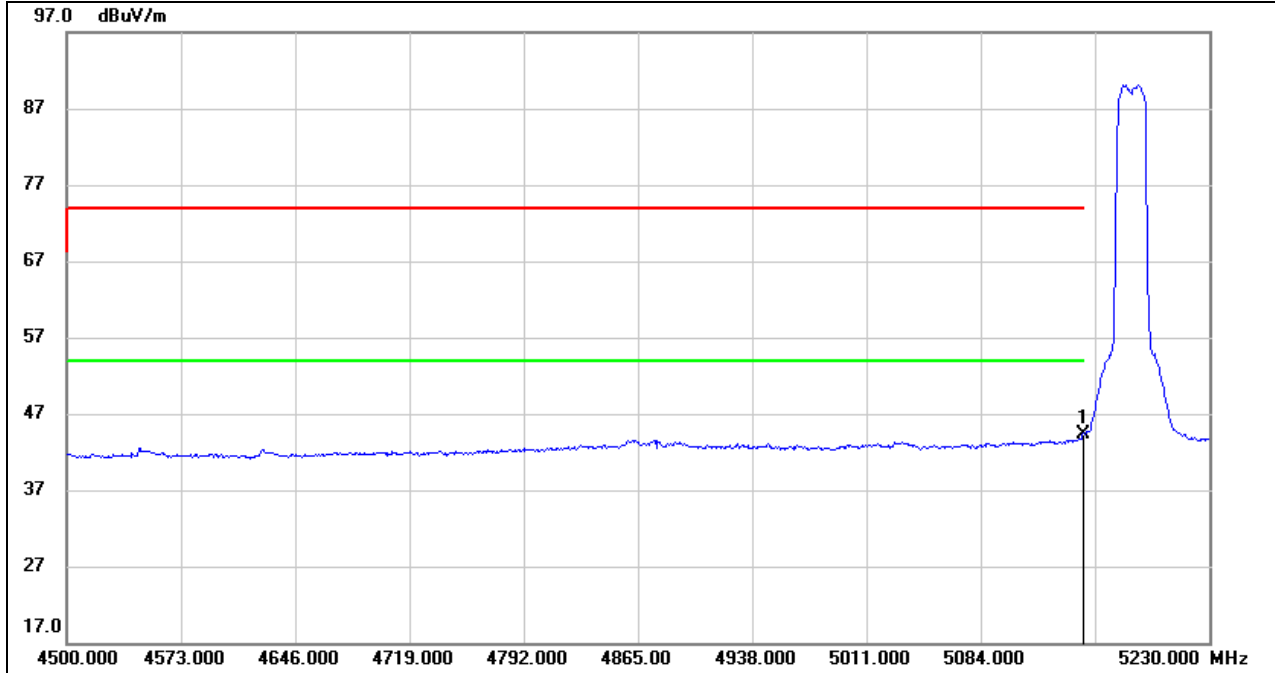

No.	Frequency (MHz)	Reading (dBuV)	Correct (dB/m)	Result (dBuV/m)	Limit (dBuV/m)	Margin (dB)	Remark
1	5150.000	3.93	40.46	44.39	54.00	-9.61	AVG

- Note:
1. Measurement = Reading Level + Correct Factor.
 2. AVG: VBW=1/Ton where: ton is transmit duration.
 3. For duty cycle, please refer to clause 7.1.
 4. Only the worst case emission will be recorder, if it complies with the limit, the other emissions deemed to comply with the limit.



VERTICAL RESULTS
PEAK

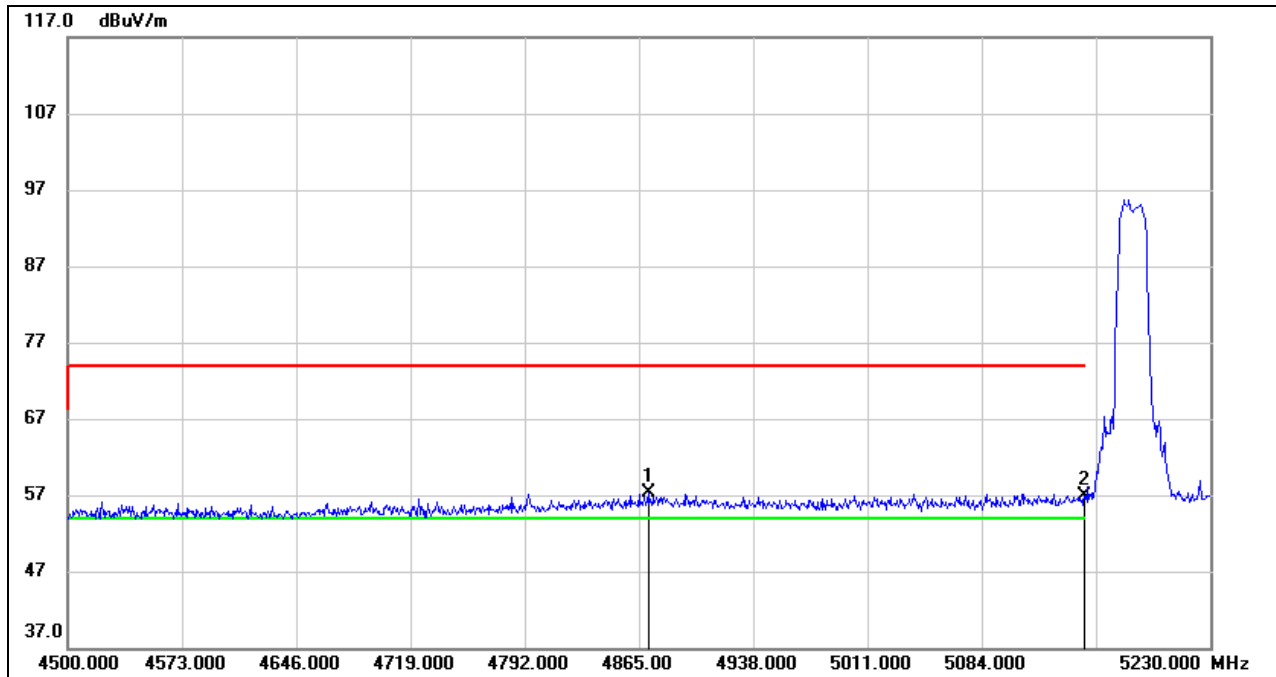

No.	Frequency (MHz)	Reading (dBuV)	Correct (dB/m)	Result (dBuV/m)	Limit (dBuV/m)	Margin (dB)	Remark
1	4870.840	17.80	39.44	57.24	74.00	-16.76	peak
2	5150.000	16.37	40.46	56.83	74.00	-17.17	peak

- Note: 1. Measurement = Reading Level + Correct Factor.
 2. If Peak Result complies with AV limit, AV Result is deemed to comply with AV limit.
 3. Peak: Peak detector.
 4. Only the worst case emission will be recorder, if it complies with the limit, the other emissions deemed to comply with the limit.



AVG

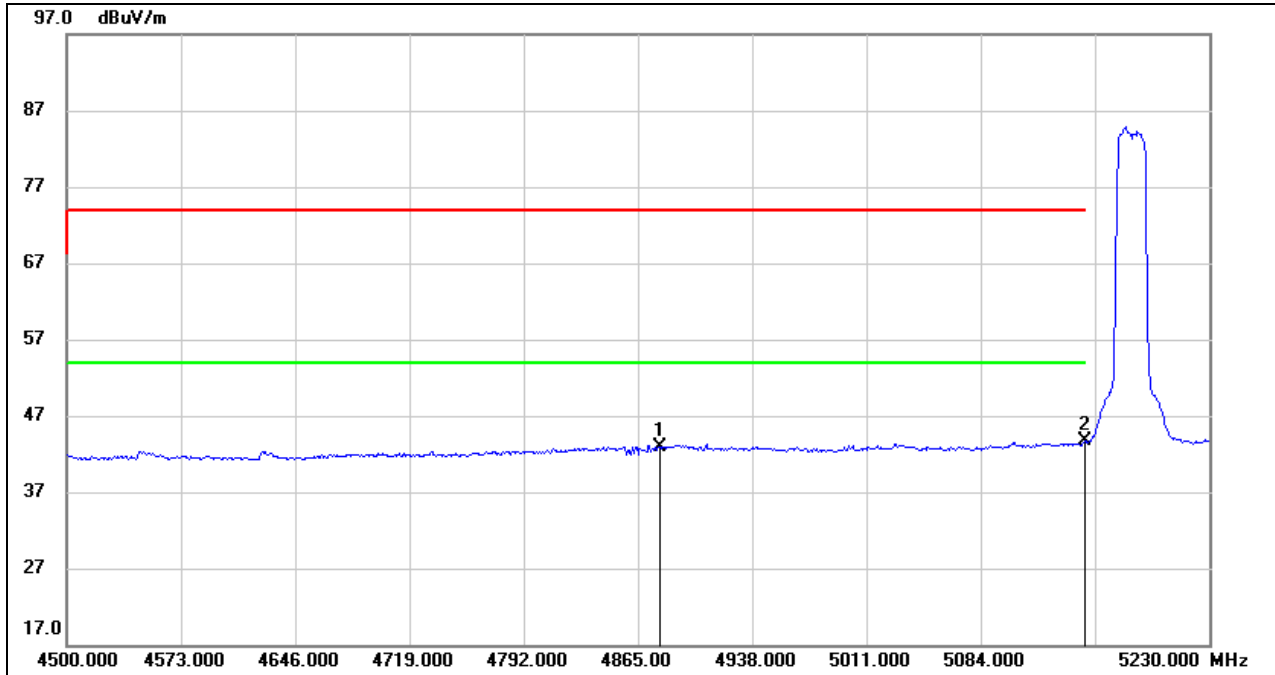

No.	Frequency (MHz)	Reading (dBuV)	Correct (dB/m)	Result (dBuV/m)	Limit (dBuV/m)	Margin (dB)	Remark
1	4878.840	3.43	39.44	42.87	54.00	-11.13	AVG
2	5150.000	3.17	40.46	43.63	54.00	-10.37	AVG

- Note: 1. Measurement = Reading Level + Correct Factor.
 2. AVG: VBW=1/Ton where: ton is transmit duration.
 3. For duty cycle, please refer to clause 7.1.
 4. Only the worst case emission will be recorder, if it complies with the limit, the other emissions deemed to comply with the limit.



HARMONICS AND SPURIOUS EMISSIONS LOW CHANNEL

HORIZONTAL RESULTS
1-7GHz

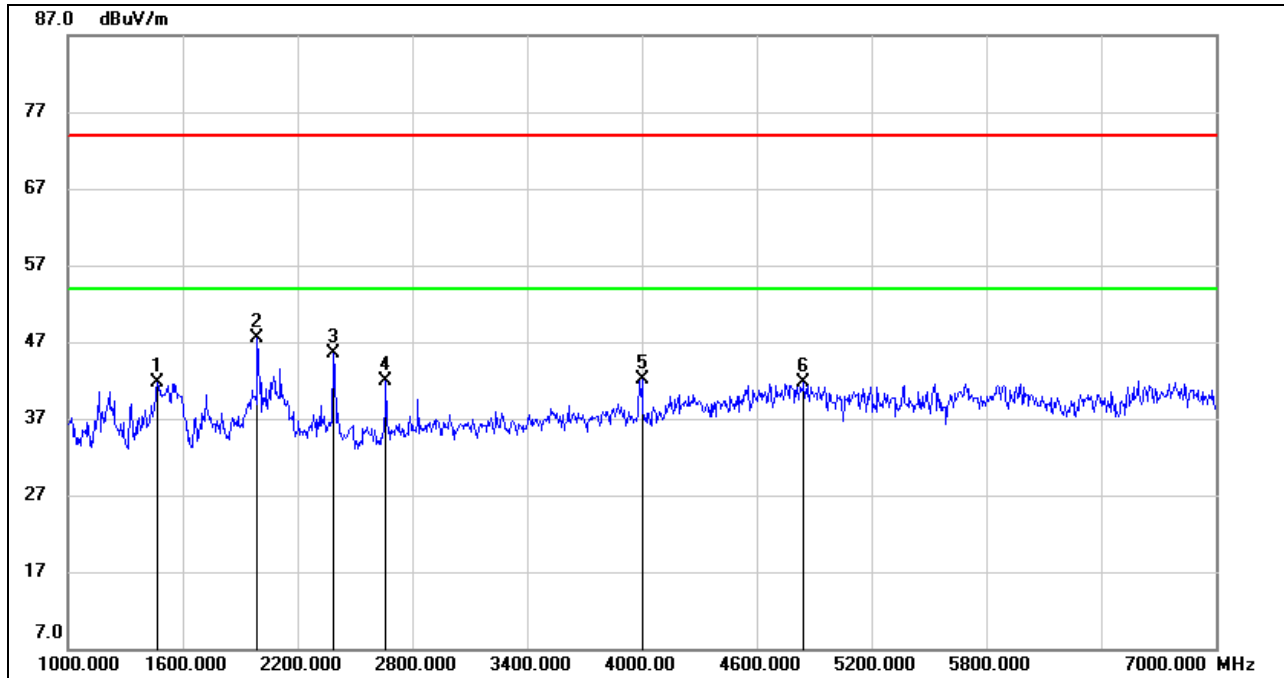

No.	Frequency (MHz)	Reading (dBuV)	Correct (dB/m)	Result (dBuV/m)	Limit (dBuV/m)	Margin (dB)	Remark
1	1468.000	54.24	-12.45	41.79	74.00	-32.21	peak
2	1990.000	57.68	-10.24	47.44	74.00	-26.56	peak
3	2386.000	54.21	-8.67	45.54	74.00	-28.46	peak
4	2662.000	49.73	-7.80	41.93	74.00	-32.07	peak
5	4000.000	45.81	-3.74	42.07	74.00	-31.93	peak
6	4846.000	41.16	0.60	41.76	74.00	-32.24	peak

Note: 1. Measurement = Reading Level + Correct Factor.
 2. If Peak Result complies with AV limit, AV Result is deemed to comply with AV limit.
 3. Peak: Peak detector.
 4. Filter losses were only considered in the spurious frequency bands and the authorized band was not corrected for Band reject filter losses.
 5. Proper operation of the transmitter prior to adding the filter to the measurement chain.
 6. Owing to the highest peak level of unwanted emission out of the restricted bands complies with the lowest limit(54dBuV/m), so all the test point was deemed to comply with the limits list in the standard.



HORIZONTAL RESULTS
7-18GHz

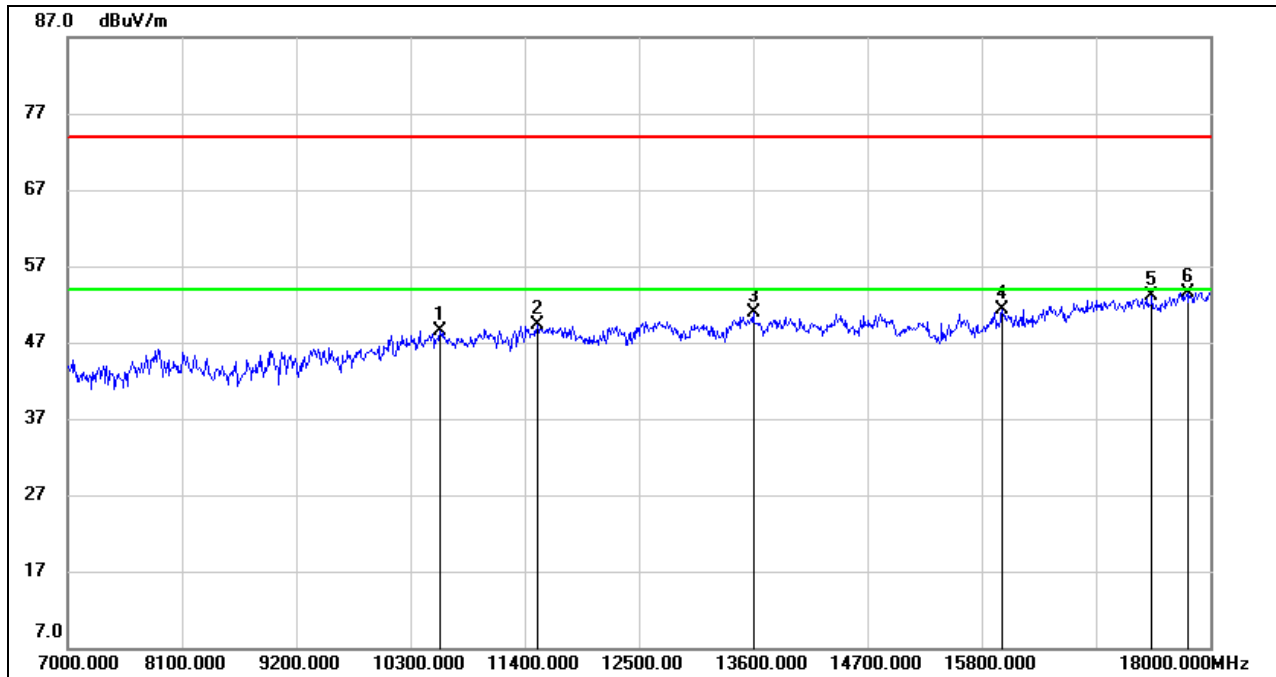

No.	Frequency (MHz)	Reading (dBuV)	Correct (dB/m)	Result (dBuV/m)	Limit (dBuV/m)	Margin (dB)	Remark
1	10586.000	36.14	12.30	48.44	74.00	-25.56	peak
2	11521.000	35.86	13.40	49.26	74.00	-24.74	peak
3	13600.000	34.81	16.10	50.91	74.00	-23.09	peak
4	15998.000	33.57	17.80	51.37	74.00	-22.63	peak
5	17439.000	31.62	21.49	53.11	74.00	-20.89	peak
6	17780.000	30.32	23.23	53.55	74.00	-20.45	peak

Note: 1. Measurement = Reading Level + Correct Factor.
 2. If Peak Result complies with AV limit, AV Result is deemed to comply with AV limit.
 3. Peak: Peak detector.
 4. Filter losses were only considered in the spurious frequency bands and the authorized band was not corrected for HPF losses.
 5. Proper operation of the transmitter prior to adding the filter to the measurement chain.
 6. Owing to the highest peak level of unwanted emission out of the restricted bands complies with the lowest limit(54dBuV/m), so all the test point was deemed to comply with the limits list in the standard.



VERTICAL RESULTS
1-7GHz

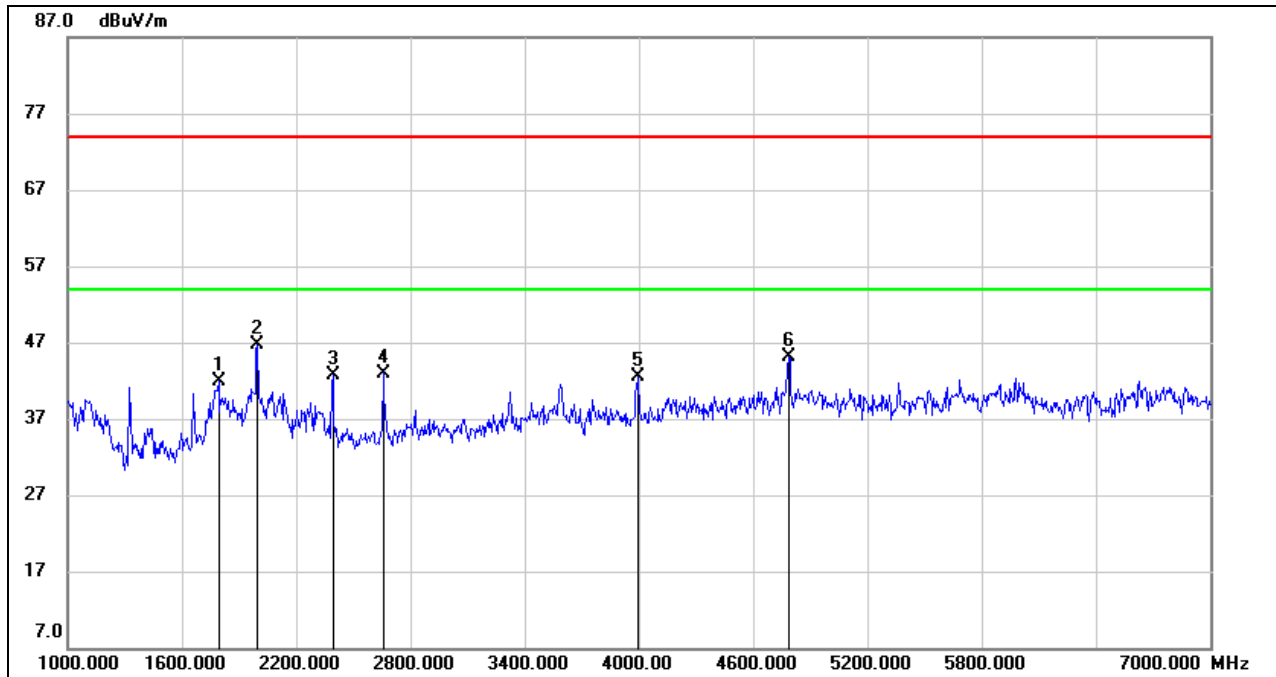

No.	Frequency (MHz)	Reading (dBuV)	Correct (dB/m)	Result (dBuV/m)	Limit (dBuV/m)	Margin (dB)	Remark
1	1792.000	52.10	-10.16	41.94	74.00	-32.06	peak
2	1996.000	56.86	-10.24	46.62	74.00	-27.38	peak
3	2392.000	51.31	-8.63	42.68	74.00	-31.32	peak
4	2656.000	50.83	-7.83	43.00	74.00	-31.00	peak
5	3994.000	46.17	-3.73	42.44	74.00	-31.56	peak
6	4786.000	44.76	0.44	45.20	74.00	-28.80	peak

Note: 1. Measurement = Reading Level + Correct Factor.
 2. If Peak Result complies with AV limit, AV Result is deemed to comply with AV limit.
 3. Peak: Peak detector.
 4. Filter losses were only considered in the spurious frequency bands and the authorized band was not corrected for Band reject filter losses.
 5. Proper operation of the transmitter prior to adding the filter to the measurement chain.
 6. Owing to the highest peak level of unwanted emission out of the restricted bands complies with the lowest limit(54dBuV/m), so all the test point was deemed to comply with the limits list in the standard.



7-18GHz

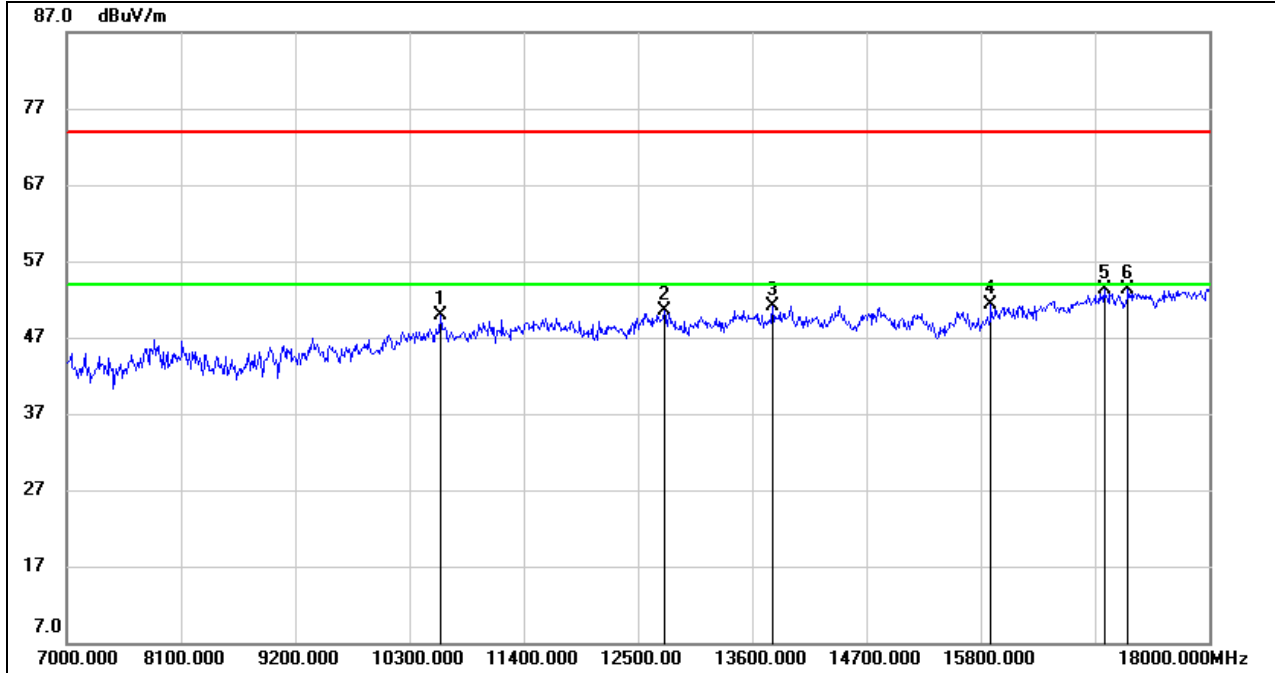

No.	Frequency (MHz)	Reading (dBuV)	Correct (dB/m)	Result (dBuV/m)	Limit (dBuV/m)	Margin (dB)	Remark
1	10597.000	37.43	12.43	49.86	74.00	-24.14	peak
2	12753.000	35.11	15.36	50.47	74.00	-23.53	peak
3	13798.000	34.15	17.05	51.20	74.00	-22.80	peak
4	15899.000	33.52	17.69	51.21	74.00	-22.79	peak
5	16988.000	32.66	20.57	53.23	74.00	-20.77	peak
6	17219.000	32.01	21.34	53.35	74.00	-20.65	peak

Note: 1. Measurement = Reading Level + Correct Factor.
 2. If Peak Result complies with AV limit, AV Result is deemed to comply with AV limit.
 3. Peak: Peak detector.
 4. Filter losses were only considered in the spurious frequency bands and the authorized band was not corrected for HPF losses.
 5. Proper operation of the transmitter prior to adding the filter to the measurement chain.
 6. Owing to the highest peak level of unwanted emission out of the restricted bands complies with the lowest limit(54dBuV/m), so all the test point was deemed to comply with the limits list in the standard.



HARMONICS AND SPURIOUS EMISSIONS MID CHANNEL

HORIZONTAL RESULTS
1-7GHz

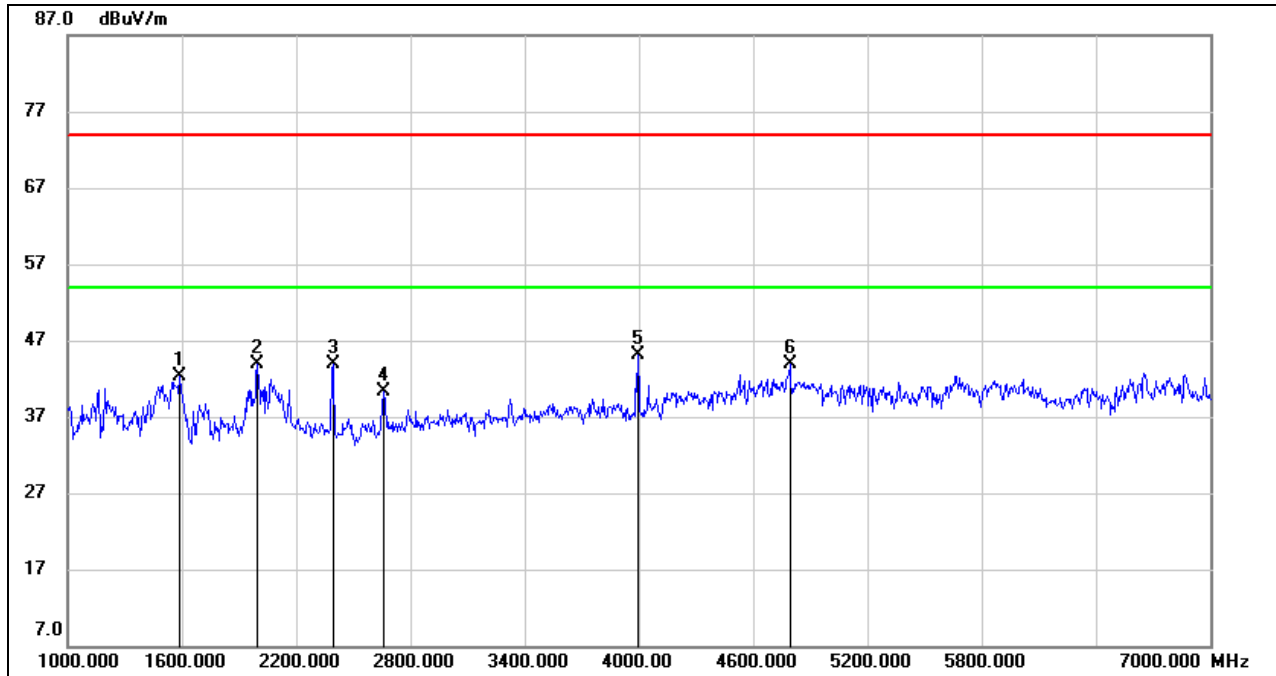

No.	Frequency (MHz)	Reading (dBuV)	Correct (dB/m)	Result (dBuV/m)	Limit (dBuV/m)	Margin (dB)	Remark
1	1588.000	54.03	-11.71	42.32	74.00	-31.68	peak
2	1996.000	54.14	-10.24	43.90	74.00	-30.10	peak
3	2392.000	52.58	-8.63	43.95	74.00	-30.05	peak
4	2662.000	48.17	-7.80	40.37	74.00	-33.63	peak
5	3994.000	48.79	-3.73	45.06	74.00	-28.94	peak
6	4792.000	43.43	0.47	43.90	74.00	-30.10	peak

Note: 1. Measurement = Reading Level + Correct Factor.
 2. If Peak Result complies with AV limit, AV Result is deemed to comply with AV limit.
 3. Peak: Peak detector.
 4. Filter losses were only considered in the spurious frequency bands and the authorized band was not corrected for Band reject filter losses.
 5. Proper operation of the transmitter prior to adding the filter to the measurement chain.
 6. Owing to the highest peak level of unwanted emission out of the restricted bands complies with the lowest limit(54dBuV/m), so all the test point was deemed to comply with the limits list in the standard.



HORIZONTAL RESULTS
7-18GHz

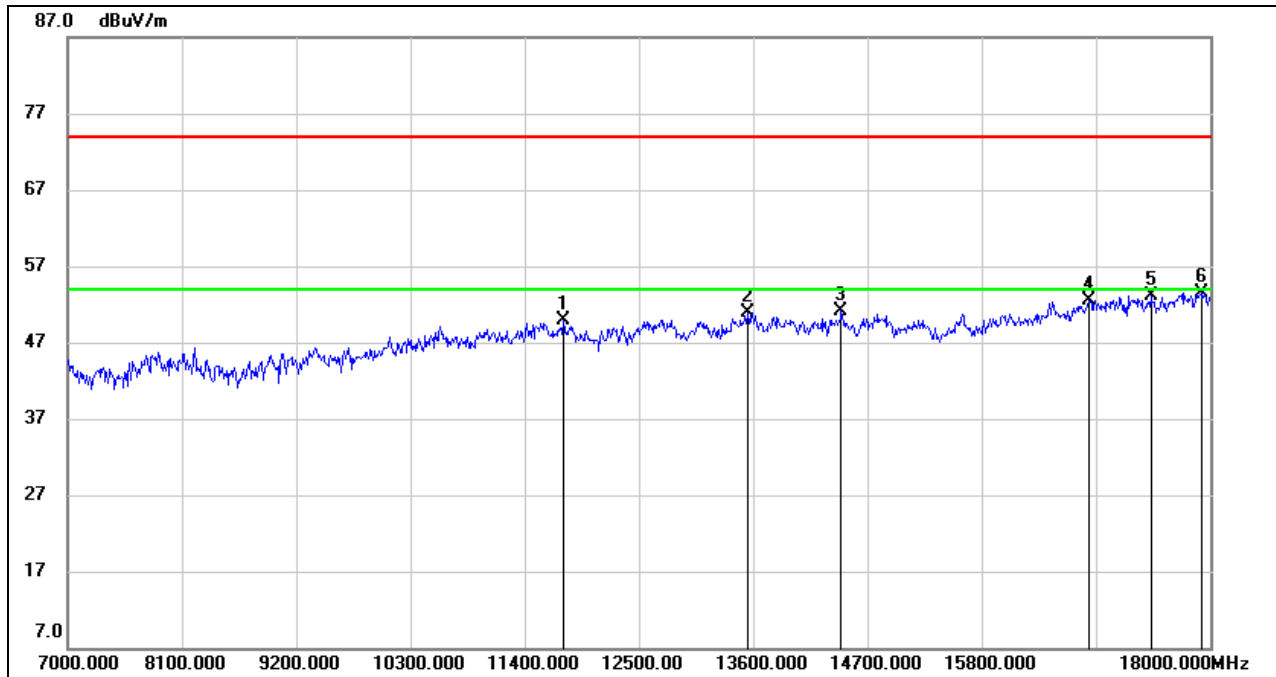

No.	Frequency (MHz)	Reading (dBuV)	Correct (dB/m)	Result (dBuV/m)	Limit (dBuV/m)	Margin (dB)	Remark
1	11774.000	36.73	13.20	49.93	74.00	-24.07	peak
2	13545.000	34.99	15.98	50.97	74.00	-23.03	peak
3	14447.000	34.41	16.63	51.04	74.00	-22.96	peak
4	16834.000	32.40	20.15	52.55	74.00	-21.45	peak
5	17428.000	31.52	21.50	53.02	74.00	-20.98	peak
6	17912.000	30.07	23.42	53.49	74.00	-20.51	peak

Note: 1. Measurement = Reading Level + Correct Factor.
 2. If Peak Result complies with AV limit, AV Result is deemed to comply with AV limit.
 3. Peak: Peak detector.
 4. Filter losses were only considered in the spurious frequency bands and the authorized band was not corrected for HPF losses.
 5. Proper operation of the transmitter prior to adding the filter to the measurement chain.
 6. Owing to the highest peak level of unwanted emission out of the restricted bands complies with the lowest limit(54dBuV/m), so all the test point was deemed to comply with the limits list in the standard.



VERTICAL RESULTS
1-7GHz

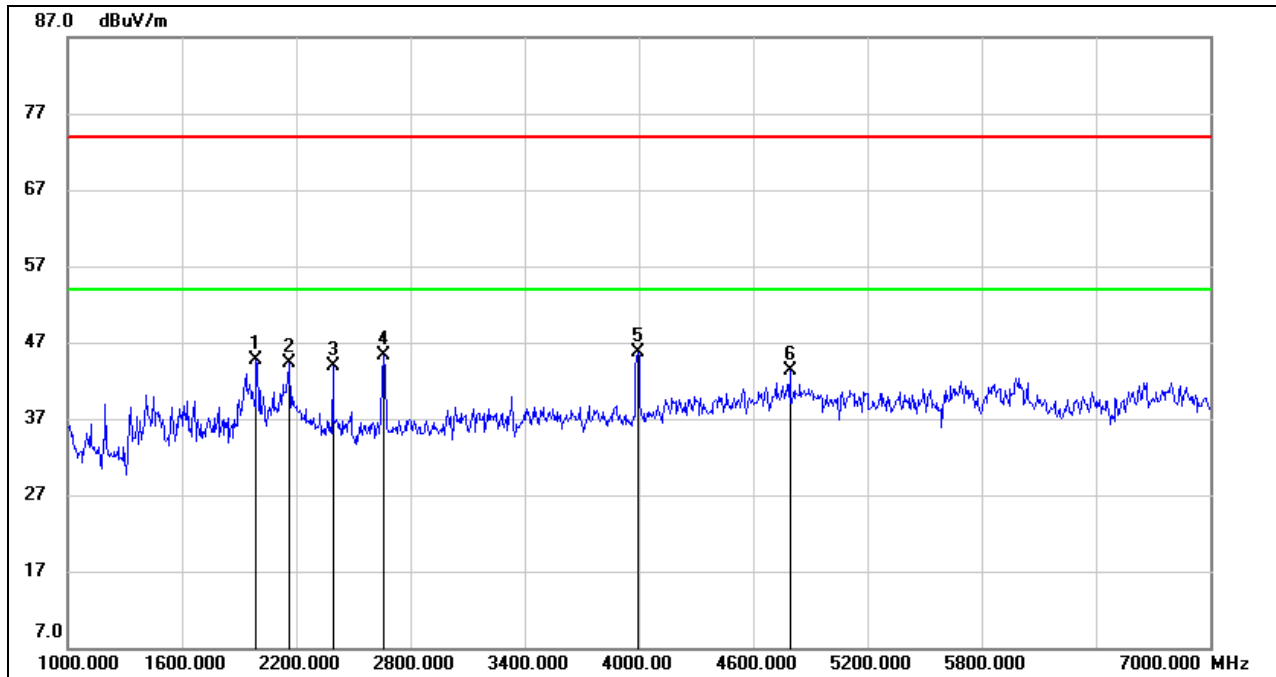

No.	Frequency (MHz)	Reading (dBuV)	Correct (dB/m)	Result (dBuV/m)	Limit (dBuV/m)	Margin (dB)	Remark
1	1990.000	54.87	-10.24	44.63	74.00	-29.37	peak
2	2164.000	53.64	-9.37	44.27	74.00	-29.73	peak
3	2392.000	52.55	-8.63	43.92	74.00	-30.08	peak
4	2656.000	53.12	-7.83	45.29	74.00	-28.71	peak
5	3994.000	49.53	-3.73	45.80	74.00	-28.20	peak
6	4792.000	42.81	0.47	43.28	74.00	-30.72	peak

Note: 1. Measurement = Reading Level + Correct Factor.
 2. If Peak Result complies with AV limit, AV Result is deemed to comply with AV limit.
 3. Peak: Peak detector.
 4. Filter losses were only considered in the spurious frequency bands and the authorized band was not corrected for Band reject filter losses.
 5. Proper operation of the transmitter prior to adding the filter to the measurement chain.
 6. Owing to the highest peak level of unwanted emission out of the restricted bands complies with the lowest limit(54dBuV/m), so all the test point was deemed to comply with the limits list in the standard.



7-18GHz

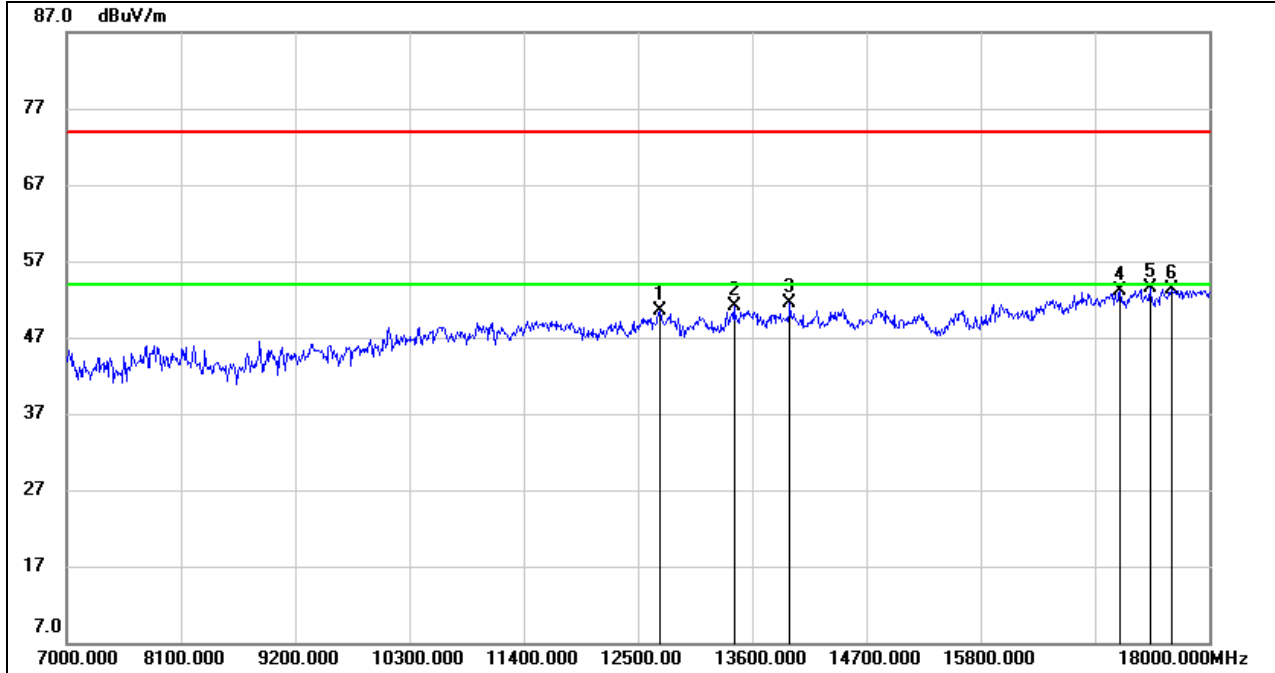

No.	Frequency (MHz)	Reading (dBuV)	Correct (dB/m)	Result (dBuV/m)	Limit (dBuV/m)	Margin (dB)	Remark
1	12709.000	35.92	14.59	50.51	74.00	-23.49	peak
2	13424.000	35.04	16.11	51.15	74.00	-22.85	peak
3	13963.000	35.28	16.16	51.44	74.00	-22.56	peak
4	17142.000	32.12	21.01	53.13	74.00	-20.87	peak
5	17428.000	32.03	21.50	53.53	74.00	-20.47	peak
6	17637.000	31.14	22.10	53.24	74.00	-20.76	peak

Note: 1. Measurement = Reading Level + Correct Factor.
 2. If Peak Result complies with AV limit, AV Result is deemed to comply with AV limit.
 3. Peak: Peak detector.
 4. Filter losses were only considered in the spurious frequency bands and the authorized band was not corrected for HPF losses.
 5. Proper operation of the transmitter prior to adding the filter to the measurement chain.
 6. Owing to the highest peak level of unwanted emission out of the restricted bands complies with the lowest limit(54dBuV/m), so all the test point was deemed to comply with the limits list in the standard.



HARMONICS AND SPURIOUS EMISSIONS HIGH CHANNEL

HORIZONTAL RESULTS
1-7GHz

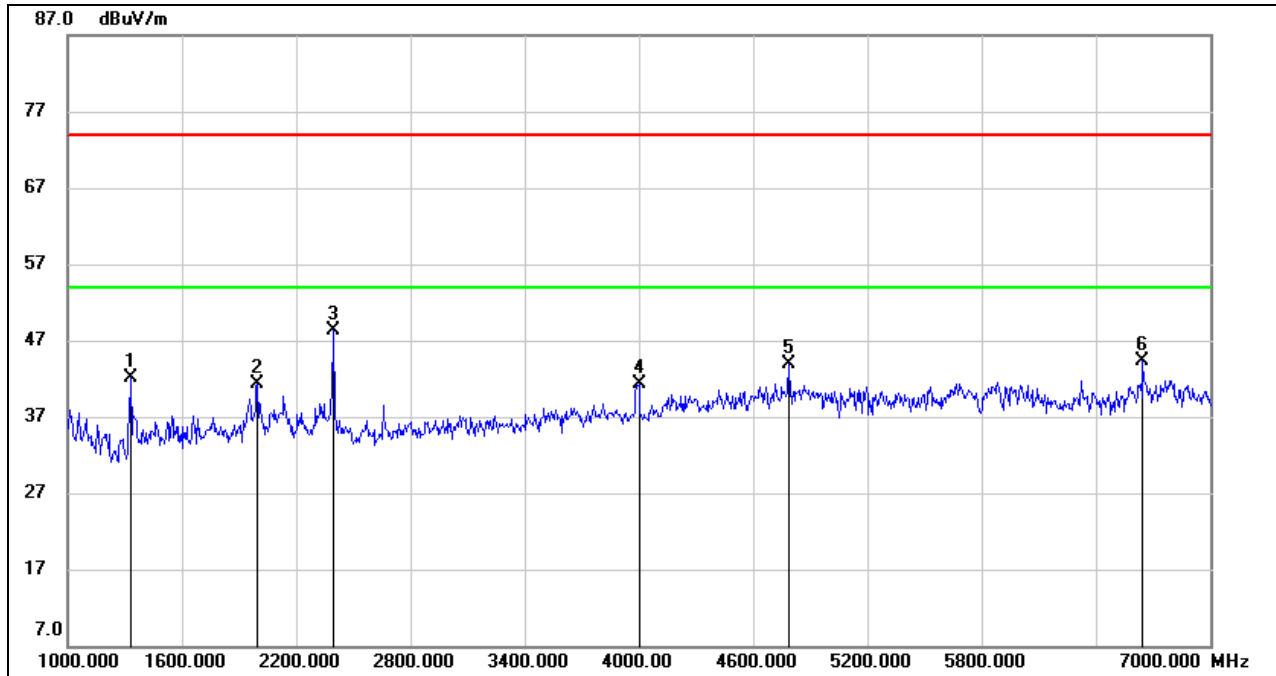

No.	Frequency (MHz)	Reading (dBuV)	Correct (dB/m)	Result (dBuV/m)	Limit (dBuV/m)	Margin (dB)	Remark
1	1330.000	54.91	-12.88	42.03	74.00	-31.97	peak
2	1996.000	51.58	-10.24	41.34	74.00	-32.66	peak
3	2398.000	56.98	-8.62	48.36	74.00	-25.64	peak
4	4000.000	44.96	-3.74	41.22	74.00	-32.78	peak
5	4786.000	43.47	0.44	43.91	74.00	-30.09	peak
6	6646.000	39.74	4.47	44.21	74.00	-29.79	peak

Note: 1. Measurement = Reading Level + Correct Factor.
 2. If Peak Result complies with AV limit, AV Result is deemed to comply with AV limit.
 3. Peak: Peak detector.
 4. Filter losses were only considered in the spurious frequency bands and the authorized band was not corrected for Band reject filter losses.
 5. Proper operation of the transmitter prior to adding the filter to the measurement chain.
 6. Owing to the highest peak level of unwanted emission out of the restricted bands complies with the lowest limit(54dBuV/m), so all the test point was deemed to comply with the limits list in the standard.



HORIZONTAL RESULTS
7-18GHz

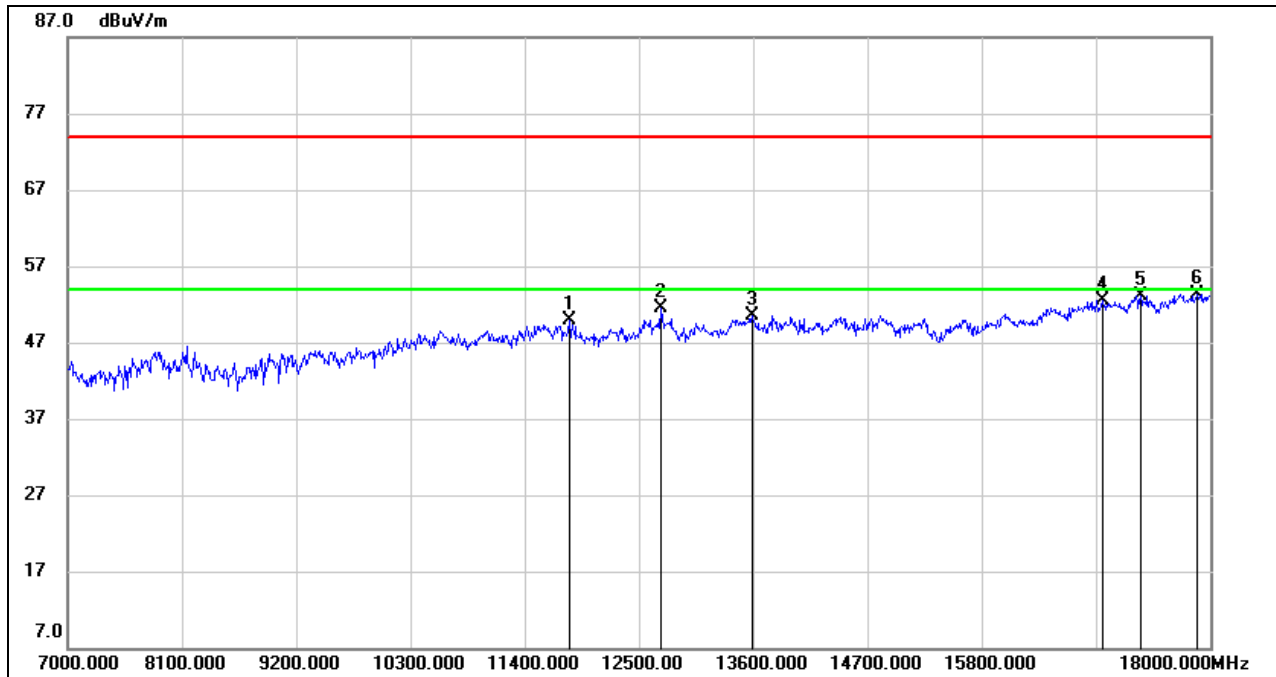

No.	Frequency (MHz)	Reading (dBuV)	Correct (dB/m)	Result (dBuV/m)	Limit (dBuV/m)	Margin (dB)	Remark
1	11829.000	36.56	13.30	49.86	74.00	-24.14	peak
2	12709.000	36.96	14.59	51.55	74.00	-22.45	peak
3	13589.000	34.42	16.08	50.50	74.00	-23.50	peak
4	16966.000	31.99	20.45	52.44	74.00	-21.56	peak
5	17329.000	31.33	21.78	53.11	74.00	-20.89	peak
6	17879.000	29.97	23.40	53.37	74.00	-20.63	peak

Note: 1. Measurement = Reading Level + Correct Factor.
 2. If Peak Result complies with AV limit, AV Result is deemed to comply with AV limit.
 3. Peak: Peak detector.
 4. Filter losses were only considered in the spurious frequency bands and the authorized band was not corrected for HPF losses.
 5. Proper operation of the transmitter prior to adding the filter to the measurement chain.
 6. Owing to the highest peak level of unwanted emission out of the restricted bands complies with the lowest limit(54dBuV/m), so all the test point was deemed to comply with the limits list in the standard.



VERTICAL RESULTS
1-7GHz

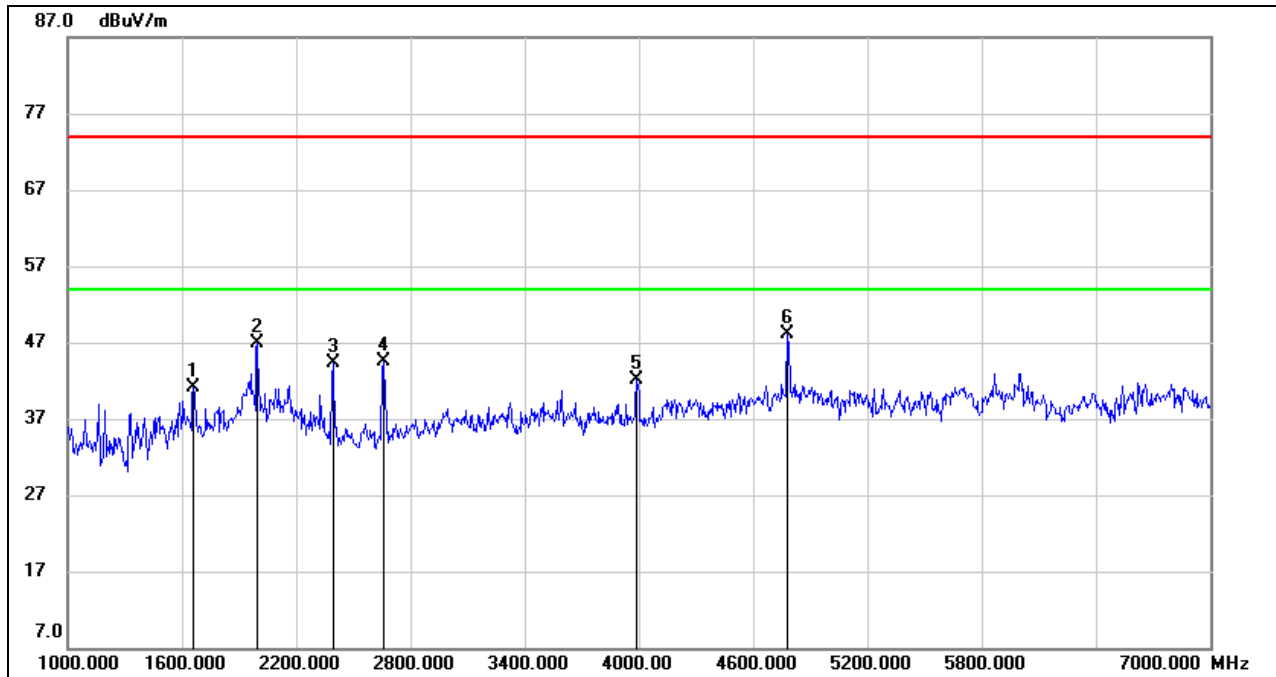

No.	Frequency (MHz)	Reading (dBuV)	Correct (dB/m)	Result (dBuV/m)	Limit (dBuV/m)	Margin (dB)	Remark
1	1660.000	52.36	-11.16	41.20	74.00	-32.80	peak
2	1996.000	57.14	-10.24	46.90	74.00	-27.10	peak
3	2392.000	52.84	-8.63	44.21	74.00	-29.79	peak
4	2656.000	52.40	-7.83	44.57	74.00	-29.43	peak
5	3988.000	45.87	-3.72	42.15	74.00	-31.85	peak
6	4780.000	47.75	0.41	48.16	74.00	-25.84	peak

Note: 1. Measurement = Reading Level + Correct Factor.
 2. If Peak Result complies with AV limit, AV Result is deemed to comply with AV limit.
 3. Peak: Peak detector.
 4. Filter losses were only considered in the spurious frequency bands and the authorized band was not corrected for Band reject filter losses.
 5. Proper operation of the transmitter prior to adding the filter to the measurement chain.
 6. Owing to the highest peak level of unwanted emission out of the restricted bands complies with the lowest limit(54dBuV/m), so all the test point was deemed to comply with the limits list in the standard.



7-18GHz

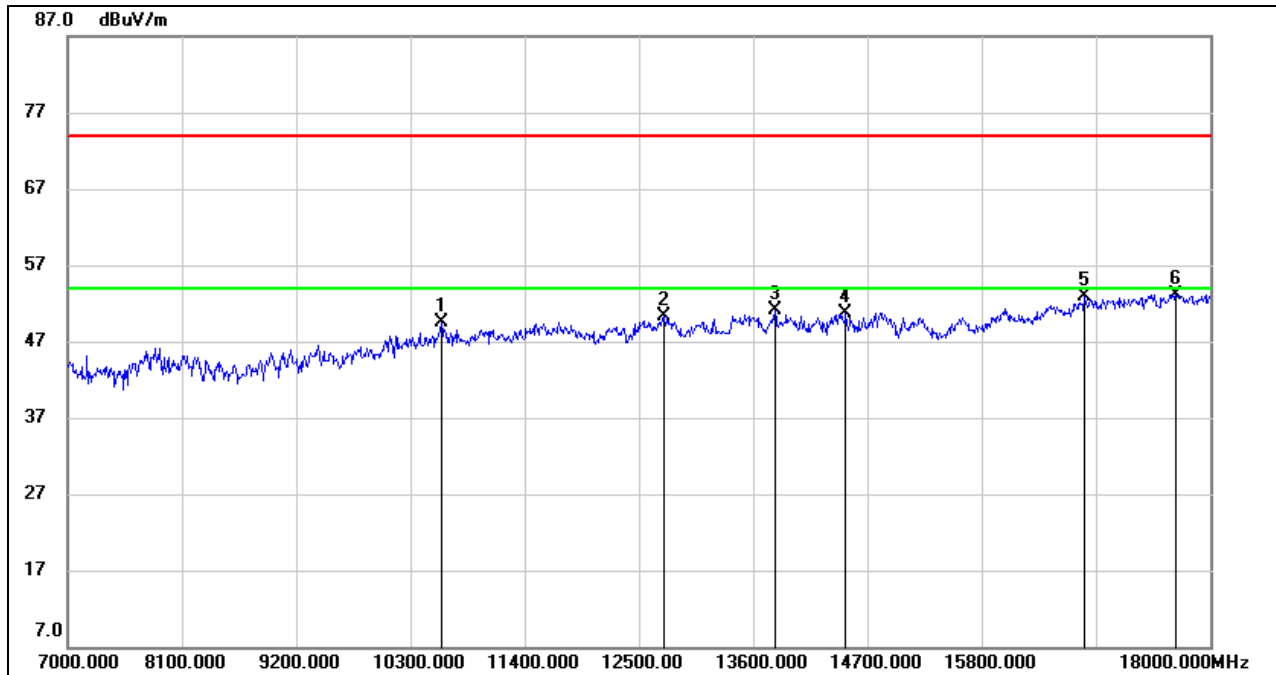

No.	Frequency (MHz)	Reading (dBuV)	Correct (dB/m)	Result (dBuV/m)	Limit (dBuV/m)	Margin (dB)	Remark
1	10597.000	37.08	12.43	49.51	74.00	-24.49	peak
2	12742.000	35.20	15.16	50.36	74.00	-23.64	peak
3	13809.000	34.07	16.99	51.06	74.00	-22.94	peak
4	14491.000	34.14	16.58	50.72	74.00	-23.28	peak
5	16790.000	32.68	20.18	52.86	74.00	-21.14	peak
6	17670.000	30.89	22.30	53.19	74.00	-20.81	peak

Note: 1. Measurement = Reading Level + Correct Factor.
 2. If Peak Result complies with AV limit, AV Result is deemed to comply with AV limit.
 3. Peak: Peak detector.
 4. Filter losses were only considered in the spurious frequency bands and the authorized band was not corrected for HPF losses.
 5. Proper operation of the transmitter prior to adding the filter to the measurement chain.
 6. Owing to the highest peak level of unwanted emission out of the restricted bands complies with the lowest limit(54dBuV/m), so all the test point was deemed to comply with the limits list in the standard.



8.2.2. UNII-2A BAND

RESTRICTED BANDEDGE HIGH CHANNEL

HORIZONTAL RESULTS
PEAK

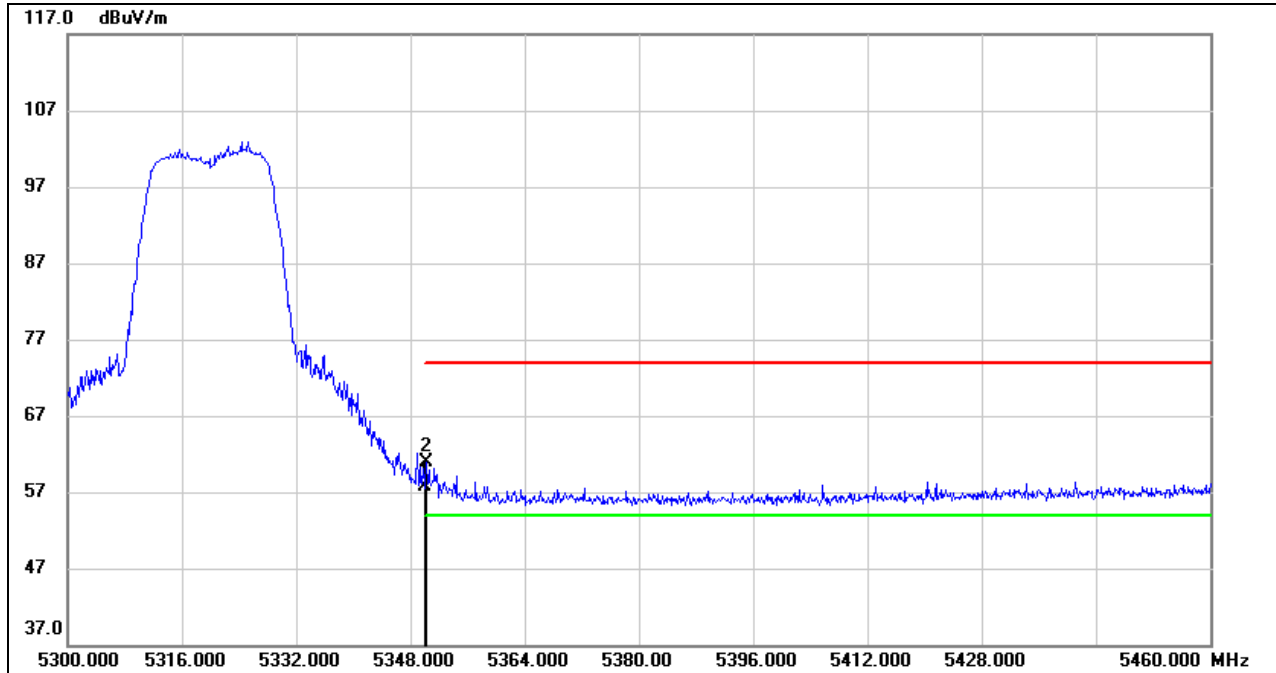

No.	Frequency (MHz)	Reading (dBuV)	Correct (dB/m)	Result (dBuV/m)	Limit (dBuV/m)	Margin (dB)	Remark
1	5350.000	17.14	40.64	57.78	74.00	-16.22	peak
2	5350.240	20.35	40.64	60.99	74.00	-13.01	peak

- Note: 1. Measurement = Reading Level + Correct Factor.
 2. If Peak Result complies with AV limit, AV Result is deemed to comply with AV limit.
 3. Peak: Peak detector.
 4. Only the worst case emission will be recorder, if it complies with the limit, the other emissions deemed to comply with the limit.



AVG

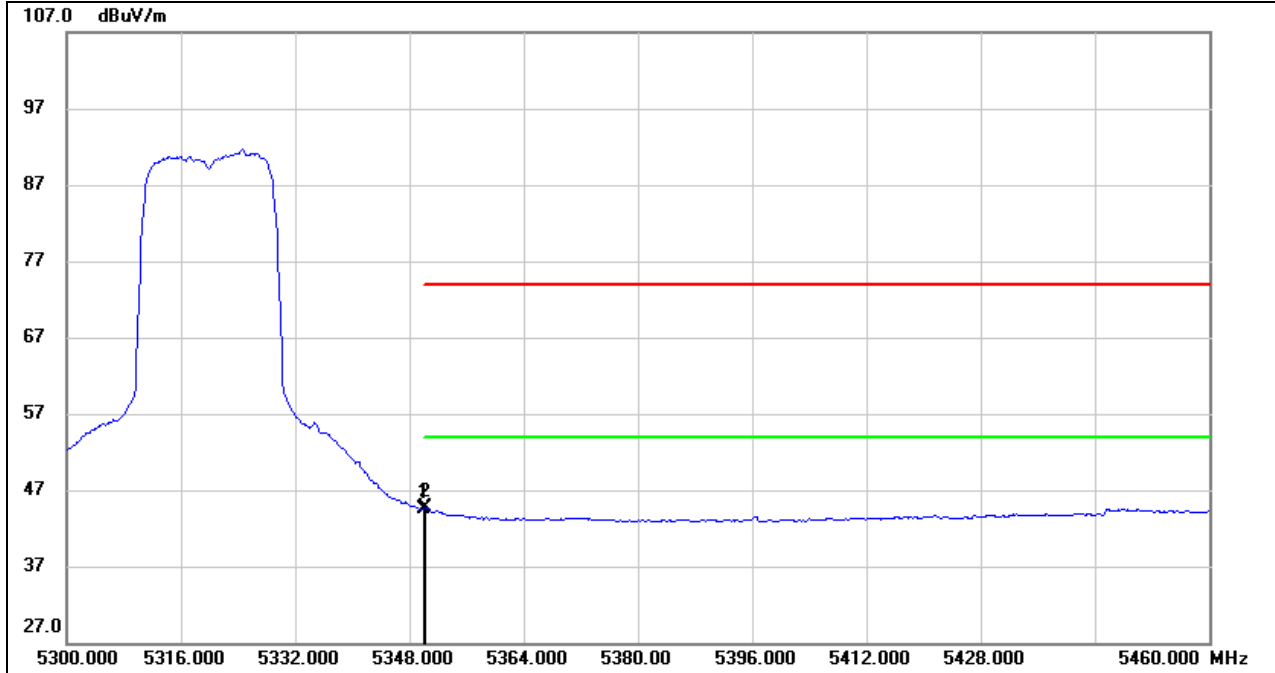

No.	Frequency (MHz)	Reading (dBuV)	Correct (dB/m)	Result (dBuV/m)	Limit (dBuV/m)	Margin (dB)	Remark
1	5350.000	3.90	40.64	44.54	54.00	-9.46	AVG
2	5350.240	4.10	40.64	44.74	54.00	-9.26	AVG

- Note: 1. Measurement = Reading Level + Correct Factor.
 2. AVG: VBW=1/Ton where: ton is transmit duration.
 3. For duty cycle, please refer to clause 7.1.
 4. Only the worst case emission will be recorder, if it complies with the limit, the other emissions deemed to comply with the limit.



VERTICAL RESULTS
PEAK

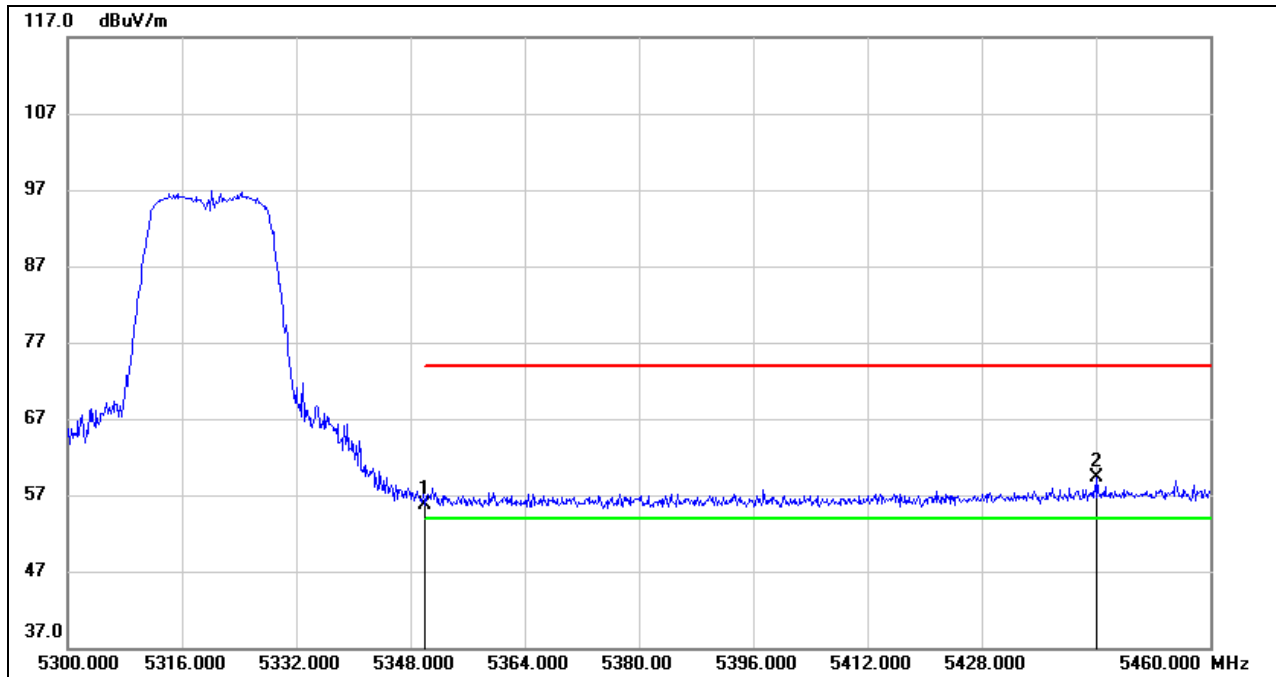

No.	Frequency (MHz)	Reading (dBuV)	Correct (dB/m)	Result (dBuV/m)	Limit (dBuV/m)	Margin (dB)	Remark
1	5350.000	15.11	40.64	55.75	74.00	-18.25	peak
2	5444.160	18.24	41.08	59.32	74.00	-14.68	peak

- Note: 1. Measurement = Reading Level + Correct Factor.
 2. If Peak Result complies with AV limit, AV Result is deemed to comply with AV limit.
 3. Peak: Peak detector.
 4. Only the worst case emission will be recorder, if it complies with the limit, the other emissions deemed to comply with the limit.



AVG

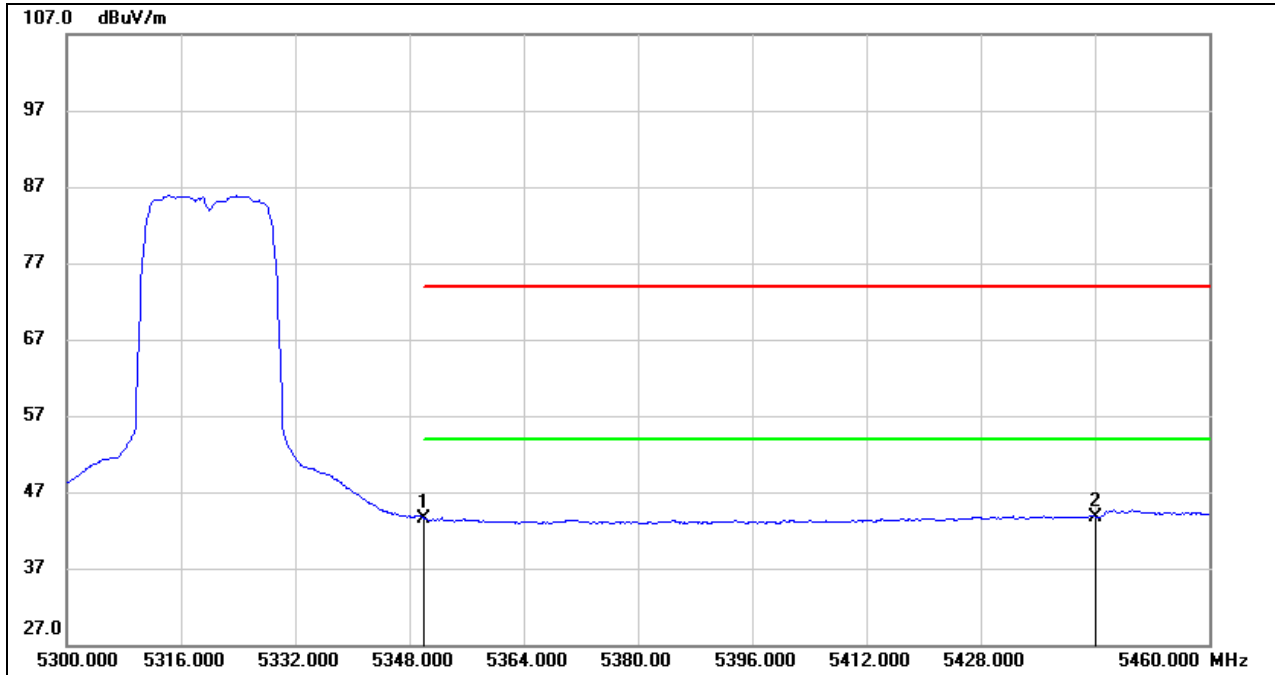

No.	Frequency (MHz)	Reading (dBuV)	Correct (dB/m)	Result (dBuV/m)	Limit (dBuV/m)	Margin (dB)	Remark
1	5350.000	2.94	40.64	43.58	54.00	-10.42	AVG
2	5444.160	2.69	41.08	43.77	54.00	-10.23	AVG

- Note: 1. Measurement = Reading Level + Correct Factor.
 2. AVG: VBW=1/Ton where: ton is transmit duration.
 3. For duty cycle, please refer to clause 7.1.
 4. Only the worst case emission will be recorder, if it complies with the limit, the other emissions deemed to comply with the limit.



HARMONICS AND SPURIOUS EMISSIONS LOW CHANNEL

HORIZONTAL RESULTS
1-7GHz

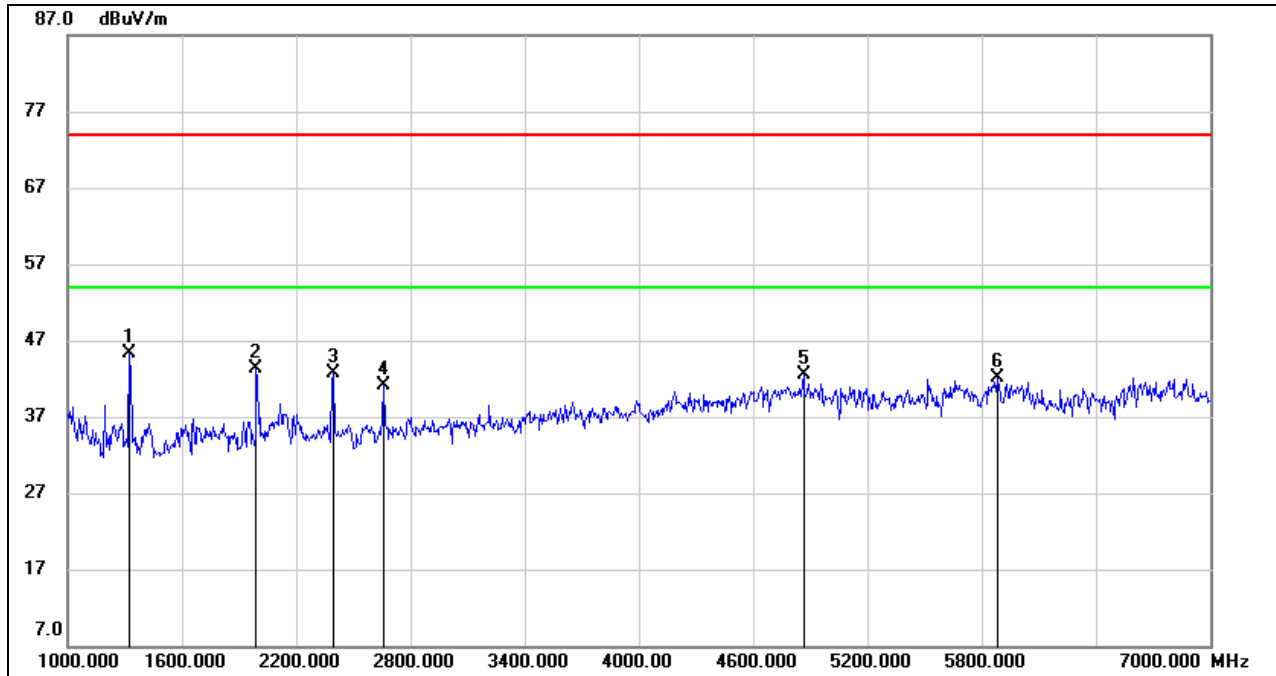

No.	Frequency (MHz)	Reading (dBuV)	Correct (dB/m)	Result (dBuV/m)	Limit (dBuV/m)	Margin (dB)	Remark
1	1324.000	58.15	-12.89	45.26	74.00	-28.74	peak
2	1990.000	53.48	-10.24	43.24	74.00	-30.76	peak
3	2392.000	51.36	-8.63	42.73	74.00	-31.27	peak
4	2656.000	48.99	-7.83	41.16	74.00	-32.84	peak
5	4864.000	41.88	0.62	42.50	74.00	-31.50	peak
6	5884.000	39.86	2.23	42.09	74.00	-31.91	peak

Note: 1. Measurement = Reading Level + Correct Factor.
 2. If Peak Result complies with AV limit, AV Result is deemed to comply with AV limit.
 3. Peak: Peak detector.
 4. Filter losses were only considered in the spurious frequency bands and the authorized band was not corrected for Band reject filter losses.
 5. Proper operation of the transmitter prior to adding the filter to the measurement chain.
 6. Owing to the highest peak level of unwanted emission out of the restricted bands complies with the lowest limit(54dBuV/m), so all the test point was deemed to comply with the limits list in the standard.



HORIZONTAL RESULTS
7-18GHz

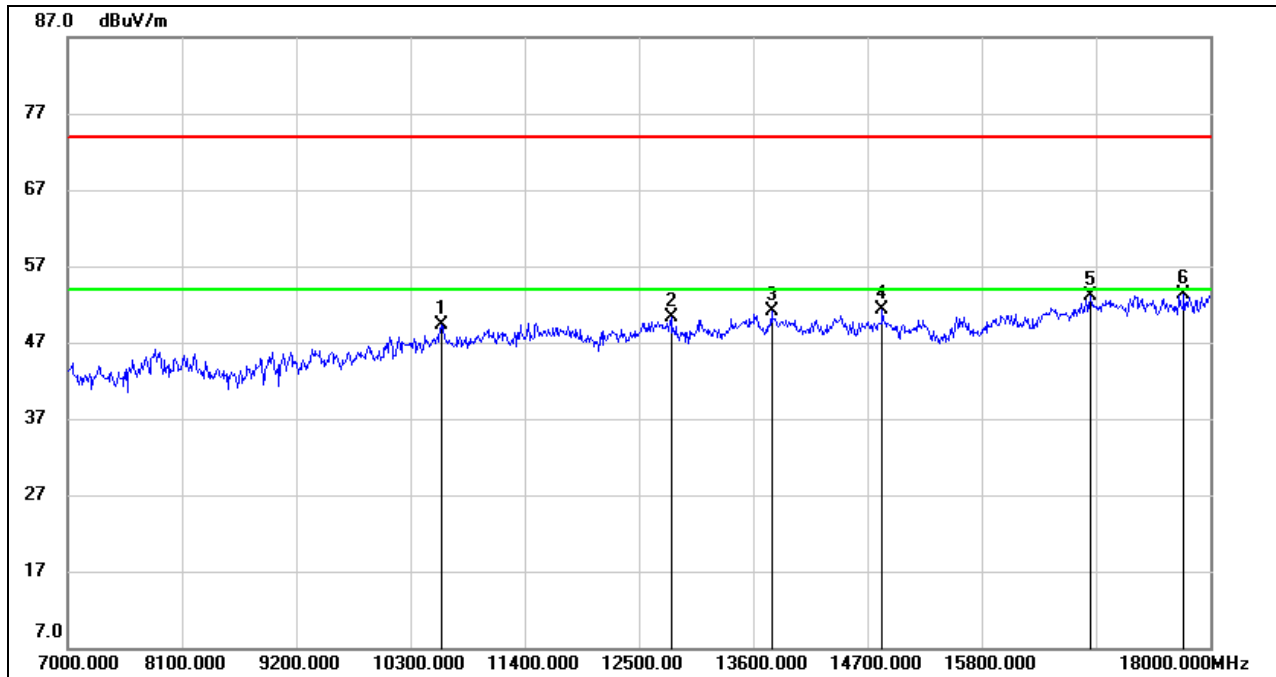

No.	Frequency (MHz)	Reading (dBuV)	Correct (dB/m)	Result (dBuV/m)	Limit (dBuV/m)	Margin (dB)	Remark
1	10597.000	36.78	12.43	49.21	74.00	-24.79	peak
2	12808.000	34.25	16.09	50.34	74.00	-23.66	peak
3	13776.000	34.34	16.84	51.18	74.00	-22.82	peak
4	14843.000	35.24	16.11	51.35	74.00	-22.65	peak
5	16845.000	33.02	20.15	53.17	74.00	-20.83	peak
6	17747.000	30.47	22.92	53.39	74.00	-20.61	peak

Note: 1. Measurement = Reading Level + Correct Factor.
 2. If Peak Result complies with AV limit, AV Result is deemed to comply with AV limit.
 3. Peak: Peak detector.
 4. Filter losses were only considered in the spurious frequency bands and the authorized band was not corrected for HPF losses.
 5. Proper operation of the transmitter prior to adding the filter to the measurement chain.
 6. Owing to the highest peak level of unwanted emission out of the restricted bands complies with the lowest limit(54dBuV/m), so all the test point was deemed to comply with the limits list in the standard.



VERTICAL RESULTS
1-7GHz

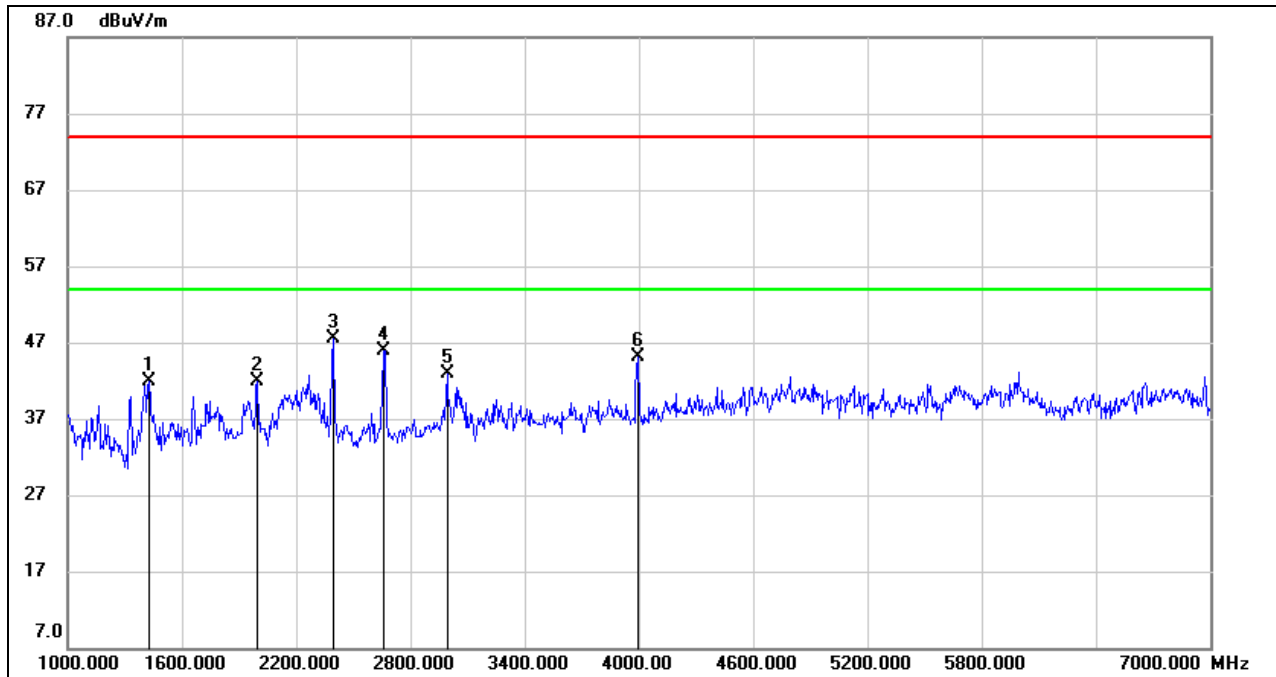

No.	Frequency (MHz)	Reading (dBuV)	Correct (dB/m)	Result (dBuV/m)	Limit (dBuV/m)	Margin (dB)	Remark
1	1426.000	54.61	-12.65	41.96	74.00	-32.04	peak
2	1996.000	52.16	-10.24	41.92	74.00	-32.08	peak
3	2398.000	56.14	-8.62	47.52	74.00	-26.48	peak
4	2662.000	53.61	-7.80	45.81	74.00	-28.19	peak
5	2992.000	48.97	-6.10	42.87	74.00	-31.13	peak
6	3994.000	48.85	-3.73	45.12	74.00	-28.88	peak

Note: 1. Measurement = Reading Level + Correct Factor.
 2. If Peak Result complies with AV limit, AV Result is deemed to comply with AV limit.
 3. Peak: Peak detector.
 4. Filter losses were only considered in the spurious frequency bands and the authorized band was not corrected for Band reject filter losses.
 5. Proper operation of the transmitter prior to adding the filter to the measurement chain.
 6. Owing to the highest peak level of unwanted emission out of the restricted bands complies with the lowest limit(54dBuV/m), so all the test point was deemed to comply with the limits list in the standard.



7-18GHz

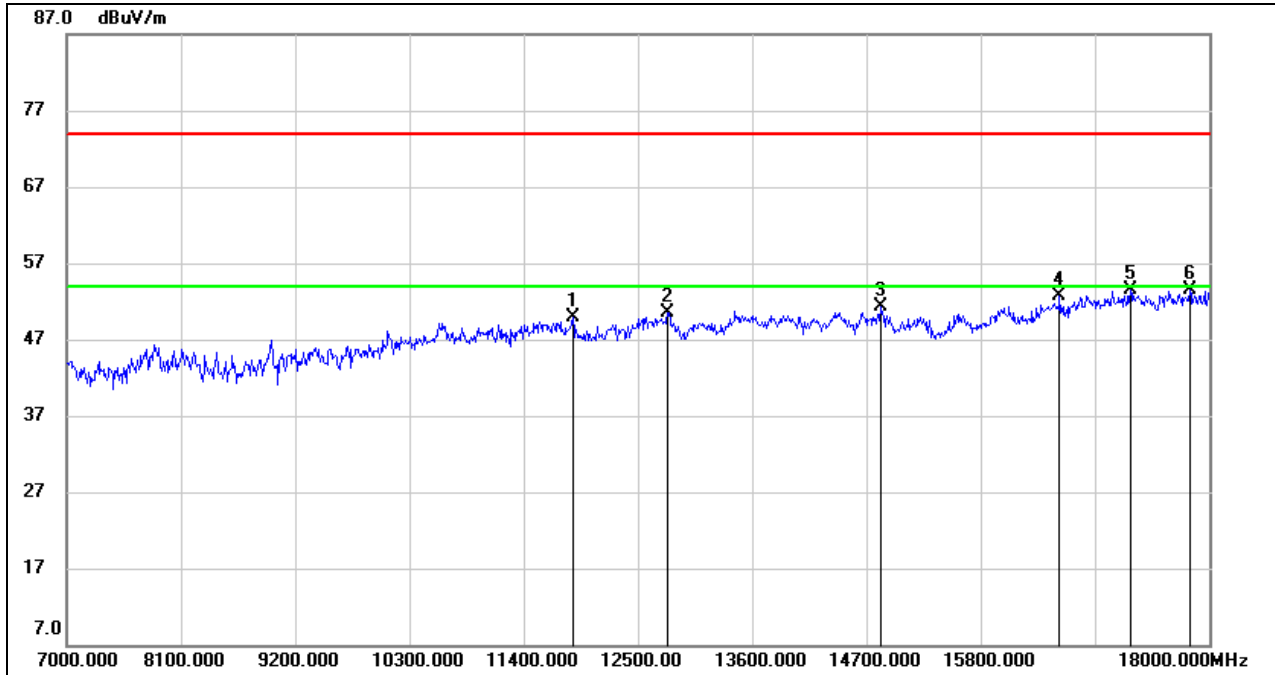

No.	Frequency (MHz)	Reading (dBuV)	Correct (dB/m)	Result (dBuV/m)	Limit (dBuV/m)	Margin (dB)	Remark
1	11873.000	36.50	13.37	49.87	74.00	-24.13	peak
2	12786.000	34.64	15.93	50.57	74.00	-23.43	peak
3	14832.000	35.23	16.10	51.33	74.00	-22.67	peak
4	16559.000	33.02	19.60	52.62	74.00	-21.38	peak
5	17241.000	31.97	21.48	53.45	74.00	-20.55	peak
6	17813.000	30.06	23.41	53.47	74.00	-20.53	peak

Note: 1. Measurement = Reading Level + Correct Factor.
 2. If Peak Result complies with AV limit, AV Result is deemed to comply with AV limit.
 3. Peak: Peak detector.
 4. Filter losses were only considered in the spurious frequency bands and the authorized band was not corrected for HPF losses.
 5. Proper operation of the transmitter prior to adding the filter to the measurement chain.
 6. Owing to the highest peak level of unwanted emission out of the restricted bands complies with the lowest limit(54dBuV/m), so all the test point was deemed to comply with the limits list in the standard.



HARMONICS AND SPURIOUS EMISSIONS MID CHANNEL

HORIZONTAL RESULTS
1-7GHz

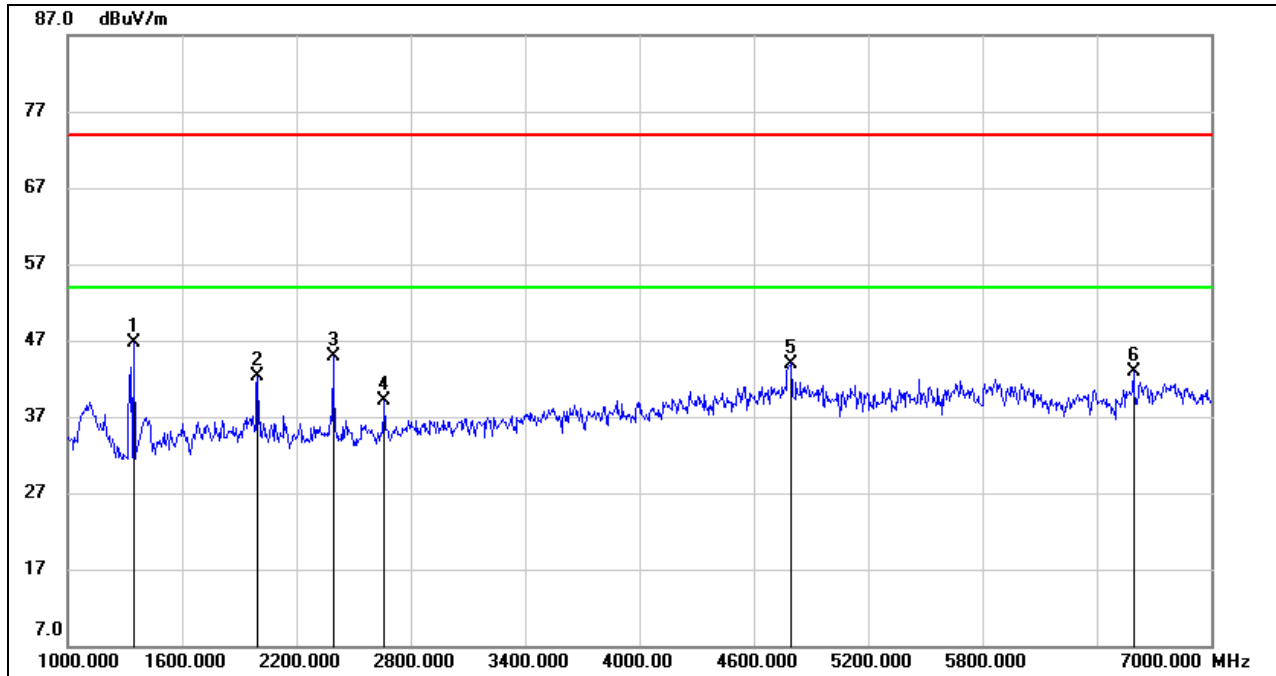

No.	Frequency (MHz)	Reading (dBuV)	Correct (dB/m)	Result (dBuV/m)	Limit (dBuV/m)	Margin (dB)	Remark
1	1348.000	59.49	-12.84	46.65	74.00	-27.35	peak
2	1996.000	52.45	-10.24	42.21	74.00	-31.79	peak
3	2392.000	53.45	-8.63	44.82	74.00	-29.18	peak
4	2662.000	46.81	-7.80	39.01	74.00	-34.99	peak
5	4798.000	43.48	0.52	44.00	74.00	-30.00	peak
6	6592.000	38.48	4.44	42.92	74.00	-31.08	peak

Note: 1. Measurement = Reading Level + Correct Factor.
 2. If Peak Result complies with AV limit, AV Result is deemed to comply with AV limit.
 3. Peak: Peak detector.
 4. Filter losses were only considered in the spurious frequency bands and the authorized band was not corrected for Band reject filter losses.
 5. Proper operation of the transmitter prior to adding the filter to the measurement chain.
 6. Owing to the highest peak level of unwanted emission out of the restricted bands complies with the lowest limit(54dBuV/m), so all the test point was deemed to comply with the limits list in the standard.



HORIZONTAL RESULTS
7-18GHz

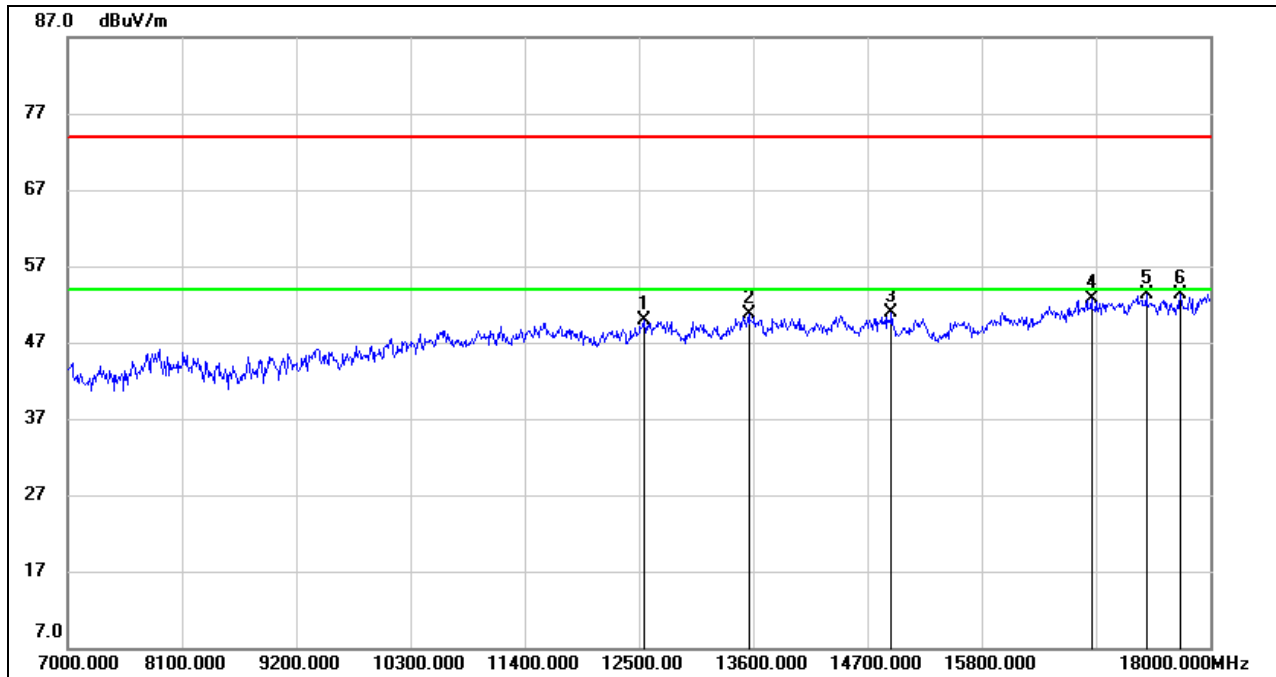

No.	Frequency (MHz)	Reading (dBuV)	Correct (dB/m)	Result (dBuV/m)	Limit (dBuV/m)	Margin (dB)	Remark
1	12544.000	35.38	14.57	49.95	74.00	-24.05	peak
2	13556.000	34.76	16.01	50.77	74.00	-23.23	peak
3	14931.000	34.75	16.13	50.88	74.00	-23.12	peak
4	16856.000	32.58	20.13	52.71	74.00	-21.29	peak
5	17384.000	31.70	21.60	53.30	74.00	-20.70	peak
6	17714.000	30.61	22.62	53.23	74.00	-20.77	peak

Note: 1. Measurement = Reading Level + Correct Factor.
 2. If Peak Result complies with AV limit, AV Result is deemed to comply with AV limit.
 3. Peak: Peak detector.
 4. Filter losses were only considered in the spurious frequency bands and the authorized band was not corrected for HPF losses.
 5. Proper operation of the transmitter prior to adding the filter to the measurement chain.
 6. Owing to the highest peak level of unwanted emission out of the restricted bands complies with the lowest limit(54dBuV/m), so all the test point was deemed to comply with the limits list in the standard.



VERTICAL RESULTS
1-7GHz

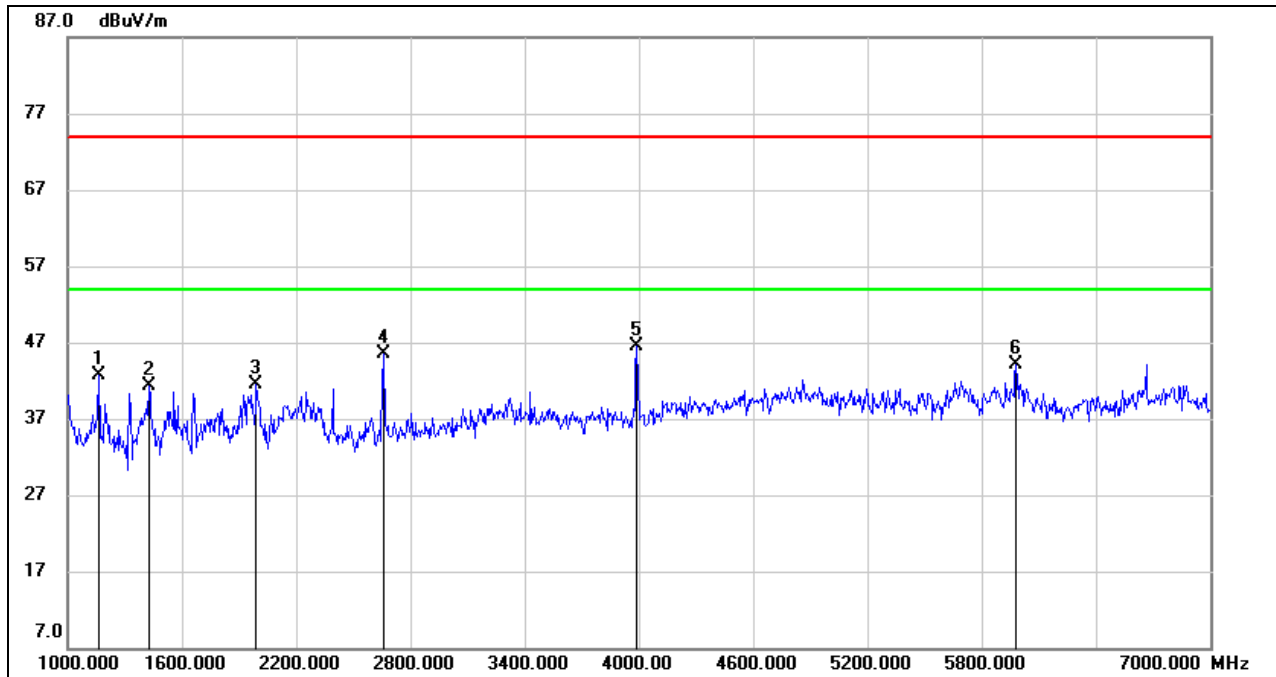

No.	Frequency (MHz)	Reading (dBuV)	Correct (dB/m)	Result (dBuV/m)	Limit (dBuV/m)	Margin (dB)	Remark
1	1162.000	55.99	-13.26	42.73	74.00	-31.27	peak
2	1426.000	53.89	-12.65	41.24	74.00	-32.76	peak
3	1990.000	51.77	-10.24	41.53	74.00	-32.47	peak
4	2662.000	53.23	-7.80	45.43	74.00	-28.57	peak
5	3988.000	50.21	-3.72	46.49	74.00	-27.51	peak
6	5980.000	41.53	2.55	44.08	74.00	-29.92	peak

Note: 1. Measurement = Reading Level + Correct Factor.
 2. If Peak Result complies with AV limit, AV Result is deemed to comply with AV limit.
 3. Peak: Peak detector.
 4. Filter losses were only considered in the spurious frequency bands and the authorized band was not corrected for Band reject filter losses.
 5. Proper operation of the transmitter prior to adding the filter to the measurement chain.
 6. Owing to the highest peak level of unwanted emission out of the restricted bands complies with the lowest limit(54dBuV/m), so all the test point was deemed to comply with the limits list in the standard.



7-18GHz

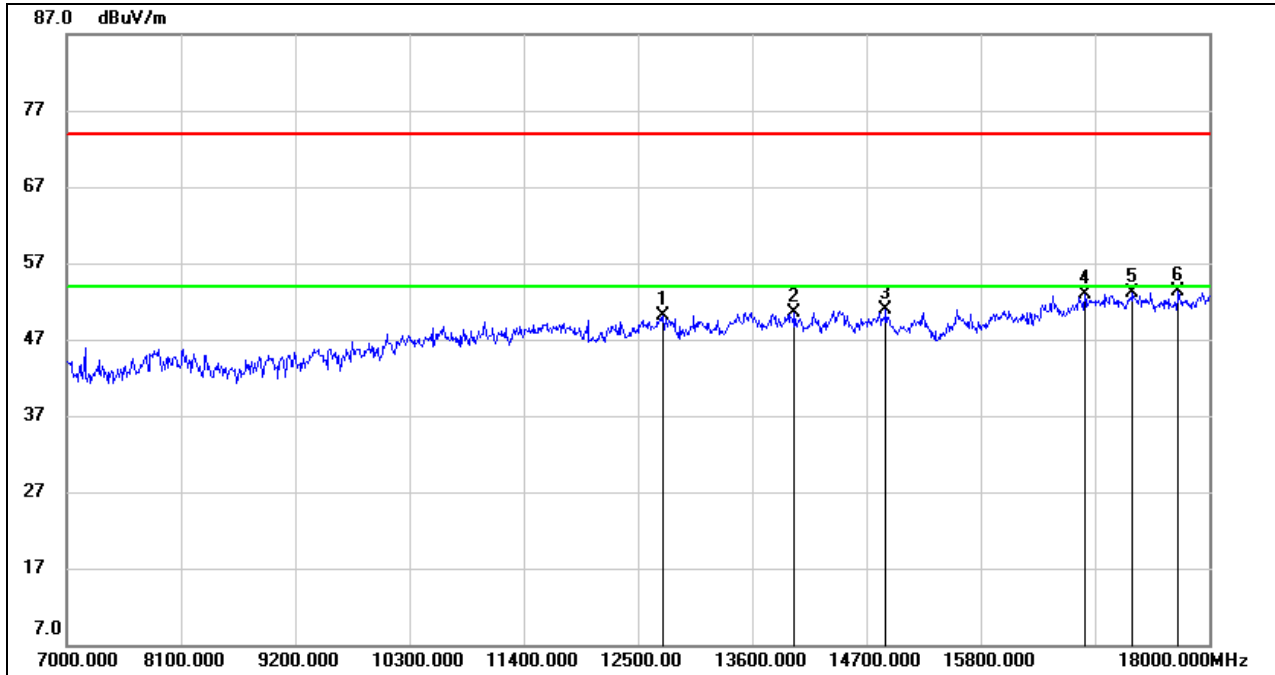

No.	Frequency (MHz)	Reading (dBuV)	Correct (dB/m)	Result (dBuV/m)	Limit (dBuV/m)	Margin (dB)	Remark
1	12742.000	34.97	15.16	50.13	74.00	-23.87	peak
2	14007.000	34.42	16.17	50.59	74.00	-23.41	peak
3	14887.000	34.74	16.16	50.90	74.00	-23.10	peak
4	16801.000	32.81	20.19	53.00	74.00	-21.00	peak
5	17263.000	31.37	21.64	53.01	74.00	-20.99	peak
6	17703.000	30.78	22.52	53.30	74.00	-20.70	peak

Note: 1. Measurement = Reading Level + Correct Factor.
 2. If Peak Result complies with AV limit, AV Result is deemed to comply with AV limit.
 3. Peak: Peak detector.
 4. Filter losses were only considered in the spurious frequency bands and the authorized band was not corrected for HPF losses.
 5. Proper operation of the transmitter prior to adding the filter to the measurement chain.
 6. Owing to the highest peak level of unwanted emission out of the restricted bands complies with the lowest limit(54dBuV/m), so all the test point was deemed to comply with the limits list in the standard.



HARMONICS AND SPURIOUS EMISSIONS HIGH CHANNEL

HORIZONTAL RESULTS
1-7GHz

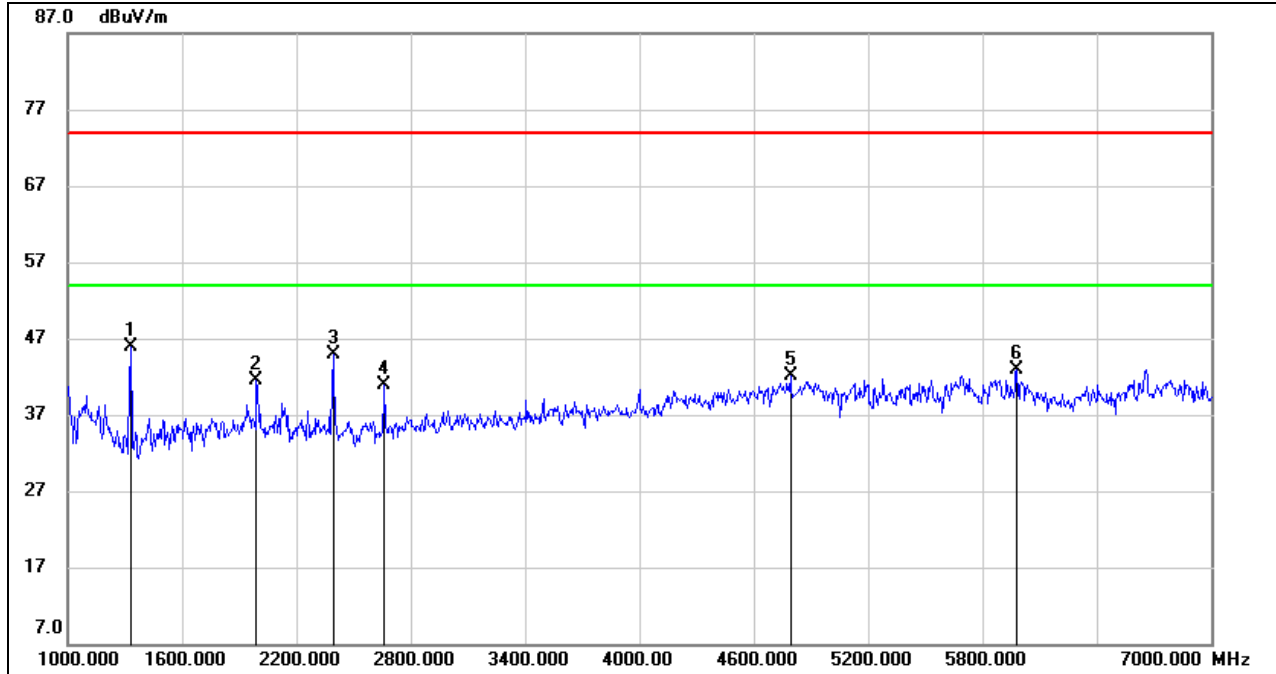

No.	Frequency (MHz)	Reading (dBuV)	Correct (dB/m)	Result (dBuV/m)	Limit (dBuV/m)	Margin (dB)	Remark
1	1330.000	58.76	-12.88	45.88	74.00	-28.12	peak
2	1990.000	51.78	-10.24	41.54	74.00	-32.46	peak
3	2392.000	53.62	-8.63	44.99	74.00	-29.01	peak
4	2662.000	48.79	-7.80	40.99	74.00	-33.01	peak
5	4792.000	41.54	0.47	42.01	74.00	-31.99	peak
6	5980.000	40.31	2.55	42.86	74.00	-31.14	peak

Note: 1. Measurement = Reading Level + Correct Factor.
 2. If Peak Result complies with AV limit, AV Result is deemed to comply with AV limit.
 3. Peak: Peak detector.
 4. Filter losses were only considered in the spurious frequency bands and the authorized band was not corrected for Band reject filter losses.
 5. Proper operation of the transmitter prior to adding the filter to the measurement chain.
 6. Owing to the highest peak level of unwanted emission out of the restricted bands complies with the lowest limit(54dBuV/m), so all the test point was deemed to comply with the limits list in the standard.



HORIZONTAL RESULTS
7-18GHz

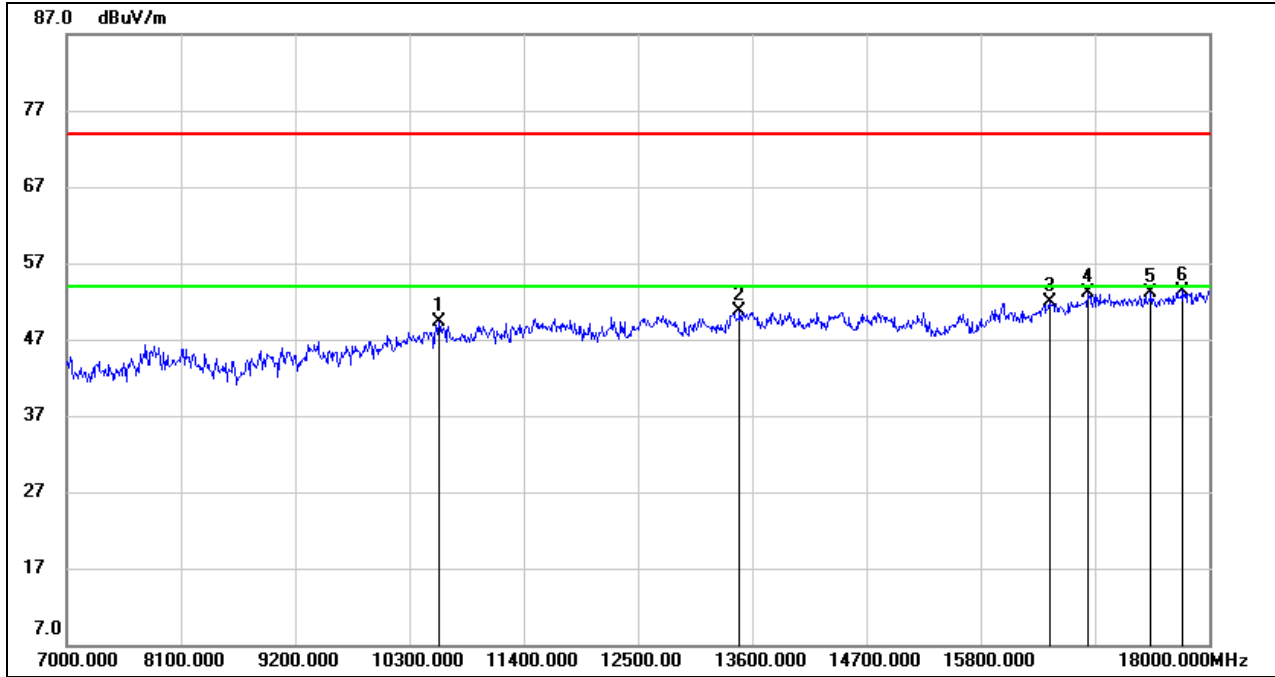

No.	Frequency (MHz)	Reading (dBuV)	Correct (dB/m)	Result (dBuV/m)	Limit (dBuV/m)	Margin (dB)	Remark
1	10586.000	37.03	12.30	49.33	74.00	-24.67	peak
2	13479.000	34.83	15.95	50.78	74.00	-23.22	peak
3	16460.000	32.35	19.49	51.84	74.00	-22.16	peak
4	16834.000	32.87	20.15	53.02	74.00	-20.98	peak
5	17439.000	31.70	21.49	53.19	74.00	-20.81	peak
6	17747.000	30.48	22.92	53.40	74.00	-20.60	peak

Note: 1. Measurement = Reading Level + Correct Factor.
 2. If Peak Result complies with AV limit, AV Result is deemed to comply with AV limit.
 3. Peak: Peak detector.
 4. Filter losses were only considered in the spurious frequency bands and the authorized band was not corrected for HPF losses.
 5. Proper operation of the transmitter prior to adding the filter to the measurement chain.
 6. Owing to the highest peak level of unwanted emission out of the restricted bands complies with the lowest limit(54dBuV/m), so all the test point was deemed to comply with the limits list in the standard.



VERTICAL RESULTS
1-7GHz

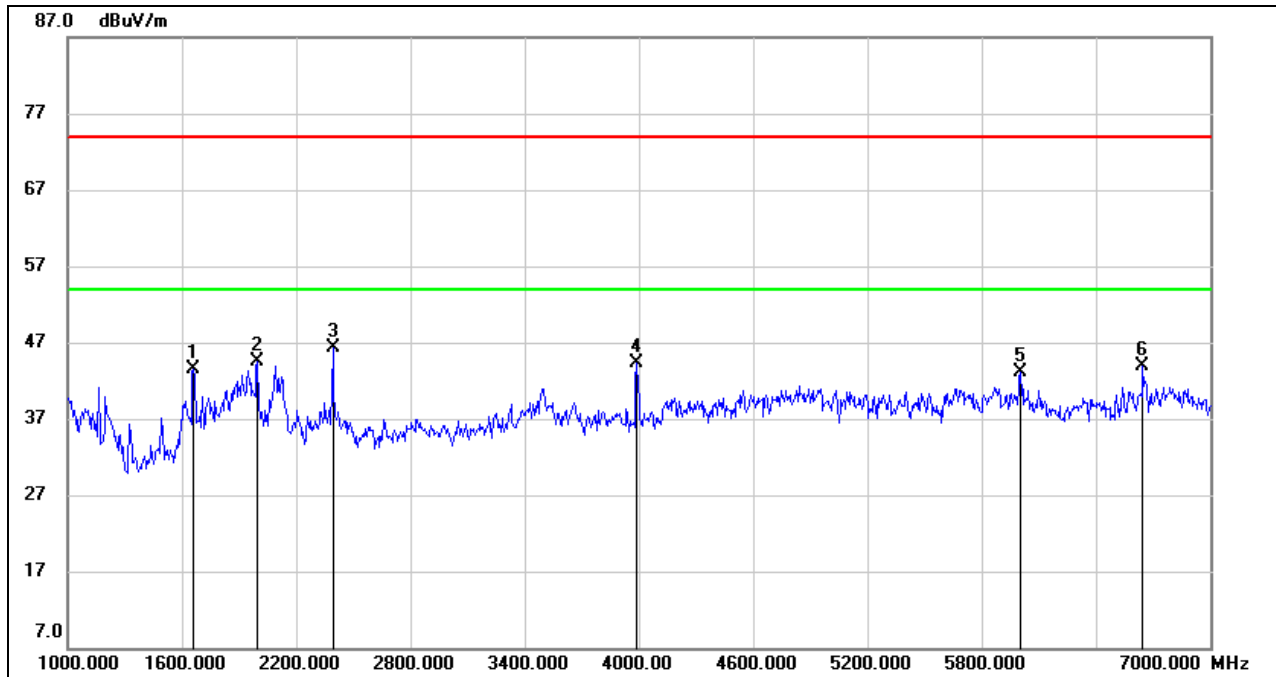

No.	Frequency (MHz)	Reading (dBuV)	Correct (dB/m)	Result (dBuV/m)	Limit (dBuV/m)	Margin (dB)	Remark
1	1660.000	54.66	-11.16	43.50	74.00	-30.50	peak
2	1996.000	54.71	-10.24	44.47	74.00	-29.53	peak
3	2392.000	54.93	-8.63	46.30	74.00	-27.70	peak
4	3988.000	48.02	-3.72	44.30	74.00	-29.70	peak
5	6004.000	40.40	2.61	43.01	74.00	-30.99	peak
6	6646.000	39.45	4.47	43.92	74.00	-30.08	peak

Note: 1. Measurement = Reading Level + Correct Factor.
 2. If Peak Result complies with AV limit, AV Result is deemed to comply with AV limit.
 3. Peak: Peak detector.
 4. Filter losses were only considered in the spurious frequency bands and the authorized band was not corrected for Band reject filter losses.
 5. Proper operation of the transmitter prior to adding the filter to the measurement chain.
 6. Owing to the highest peak level of unwanted emission out of the restricted bands complies with the lowest limit(54dBuV/m), so all the test point was deemed to comply with the limits list in the standard.



7-18GHz

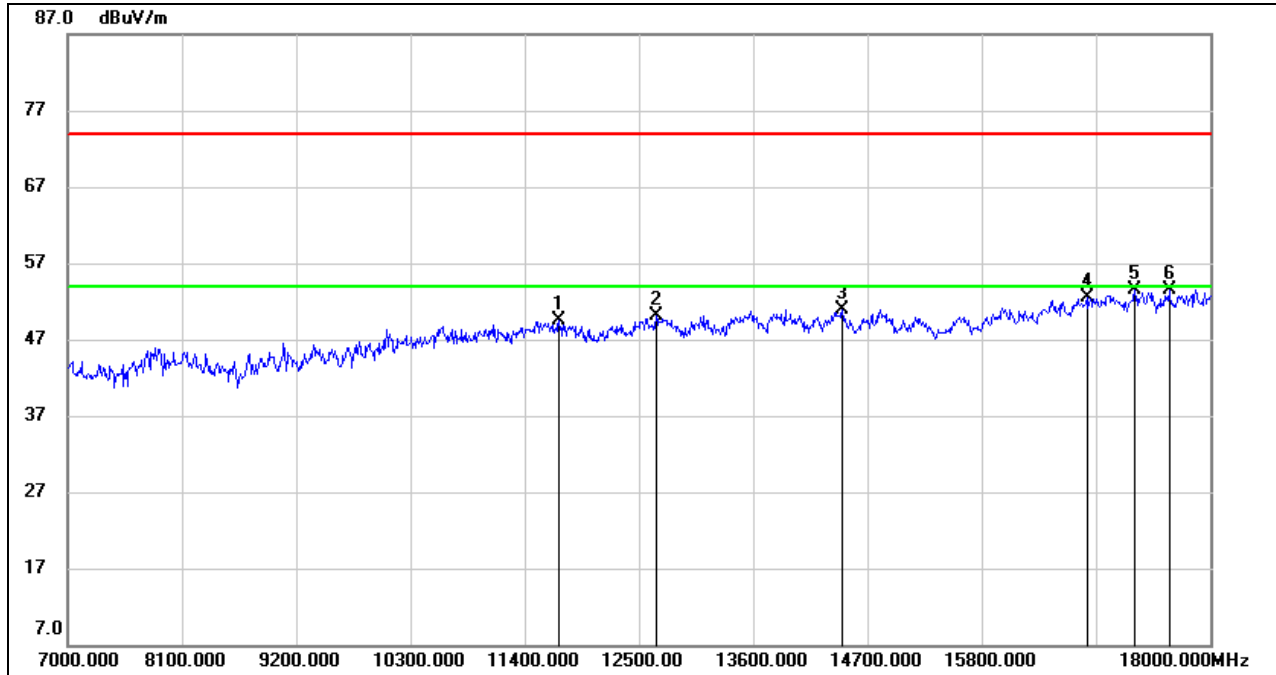

No.	Frequency (MHz)	Reading (dBuV)	Correct (dB/m)	Result (dBuV/m)	Limit (dBuV/m)	Margin (dB)	Remark
1	11730.000	36.41	13.11	49.52	74.00	-24.48	peak
2	12665.000	35.71	14.35	50.06	74.00	-23.94	peak
3	14458.000	34.33	16.62	50.95	74.00	-23.05	peak
4	16812.000	32.36	20.18	52.54	74.00	-21.46	peak
5	17274.000	31.79	21.71	53.50	74.00	-20.50	peak
6	17604.000	31.70	21.89	53.59	74.00	-20.41	peak

Note: 1. Measurement = Reading Level + Correct Factor.
 2. If Peak Result complies with AV limit, AV Result is deemed to comply with AV limit.
 3. Peak: Peak detector.
 4. Filter losses were only considered in the spurious frequency bands and the authorized band was not corrected for HPF losses.
 5. Proper operation of the transmitter prior to adding the filter to the measurement chain.
 6. Owing to the highest peak level of unwanted emission out of the restricted bands complies with the lowest limit(54dBuV/m), so all the test point was deemed to comply with the limits list in the standard.



8.2.3. UNII-2C BAND
RESTRICTED BANDEDGE LOW CHANNEL

HORIZONTAL RESULTS
PEAK

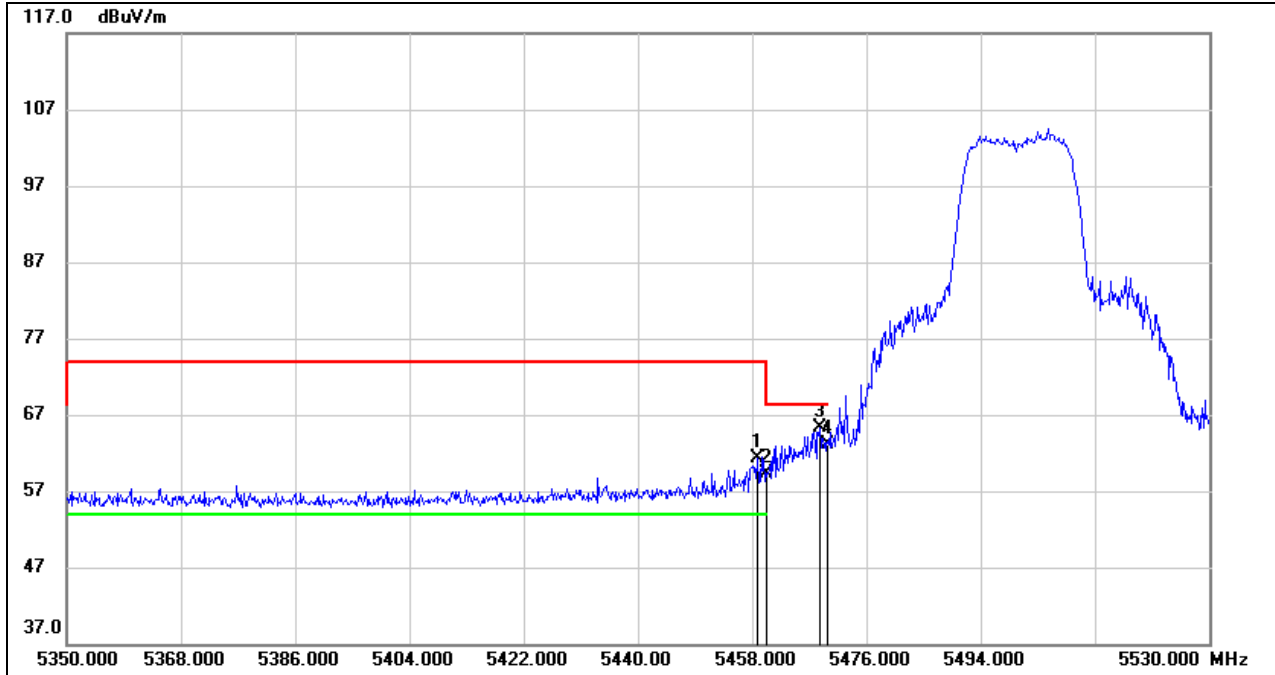

No.	Frequency (MHz)	Reading (dBuV)	Correct (dB/m)	Result (dBuV/m)	Limit (dBuV/m)	Margin (dB)	Remark
1	5458.720	19.96	41.27	61.23	74.00	-12.77	peak
2	5460.000	18.09	41.28	59.37	68.20	-8.83	peak
3	5468.620	23.85	41.39	65.24	68.20	-2.96	peak
4	5470.000	21.61	41.41	63.02	68.20	-5.18	peak

Note: 1. Measurement = Reading Level + Correct Factor.
 2. If Peak Result complies with AV limit, AV Result is deemed to comply with AV limit.
 3. Peak: Peak detector.
 4.*indicates frequency out of the restricted bands
 5. Only the worst case emission will be recorder, if it complies with the limit, the other emissions deemed to comply with the limit.



AVG

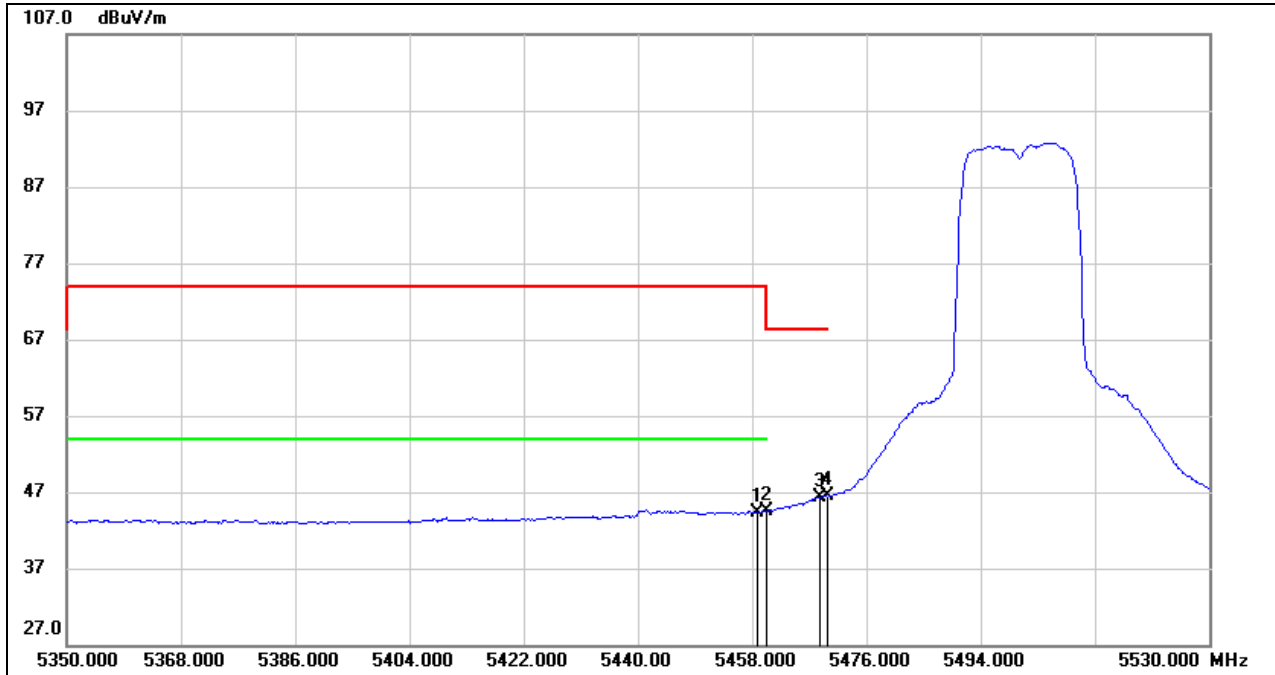

No.	Frequency (MHz)	Reading (dBuV)	Correct (dB/m)	Result (dBuV/m)	Limit (dBuV/m)	Margin (dB)	Remark
1	5458.720	3.03	41.27	44.30	54.00	-9.70	AVG
2	5460.000	3.26	41.28	44.54	54.00	-9.46	AVG
3	5468.620	4.83	41.39	46.22	68.20	-21.98	AVG
4	5470.000	5.14	41.41	46.55	68.20	-21.65	AVG

- Note:
1. Measurement = Reading Level + Correct Factor.
 2. AVG: VBW=1/Ton where: ton is transmit duration.
 3. For duty cycle, please refer to clause 7.1.
 4. Only the worst case emission will be recorder, if it complies with the limit, the other emissions deemed to comply with the limit.



VERTICAL RESULTS
PEAK

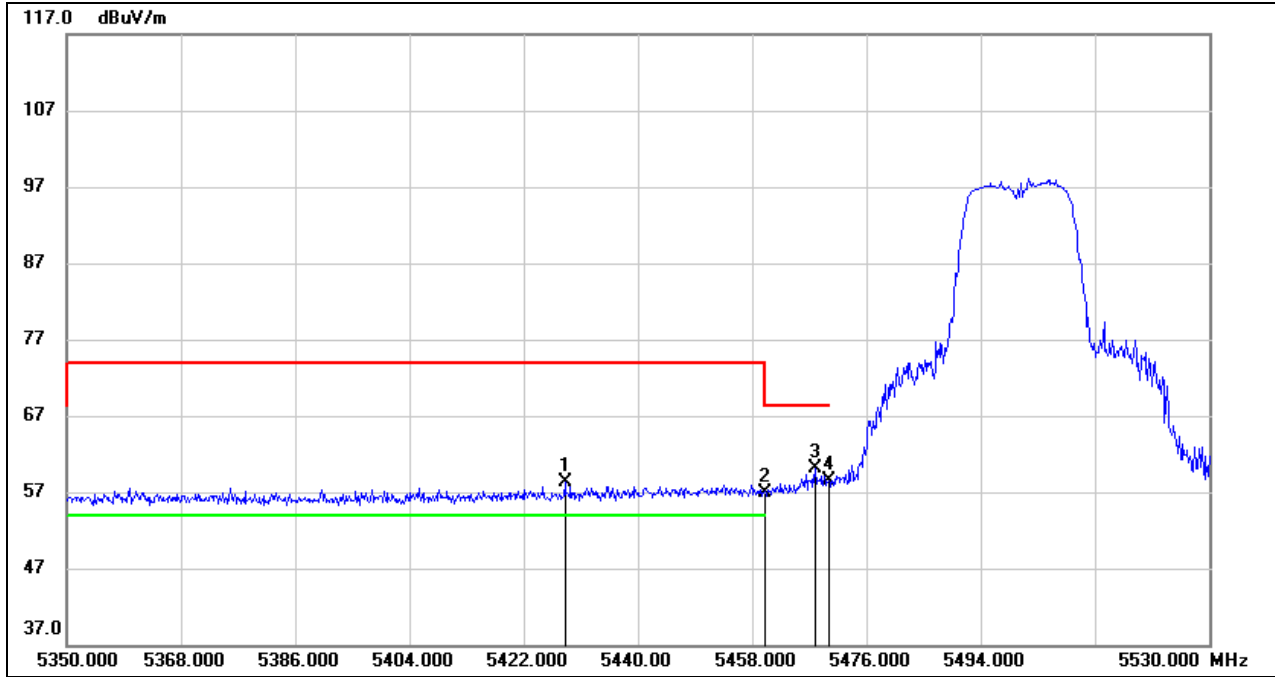

No.	Frequency (MHz)	Reading (dBuV)	Correct (dB/m)	Result (dBuV/m)	Limit (dBuV/m)	Margin (dB)	Remark
1	5428.480	17.41	40.87	58.28	74.00	-15.72	peak
2	5460.000	15.68	41.28	56.96	68.20	-11.24	peak
3	5467.900	18.63	41.38	60.01	68.20	-8.19	peak
4	5470.000	17.00	41.41	58.41	68.20	-9.79	peak

Note: 1. Measurement = Reading Level + Correct Factor.
 2. If Peak Result complies with AV limit, AV Result is deemed to comply with AV limit.
 3. Peak: Peak detector.
 4.*indicates frequency out of the restricted bands
 5. Only the worst case emission will be recorder, if it complies with the limit, the other emissions deemed to comply with the limit.



AVG

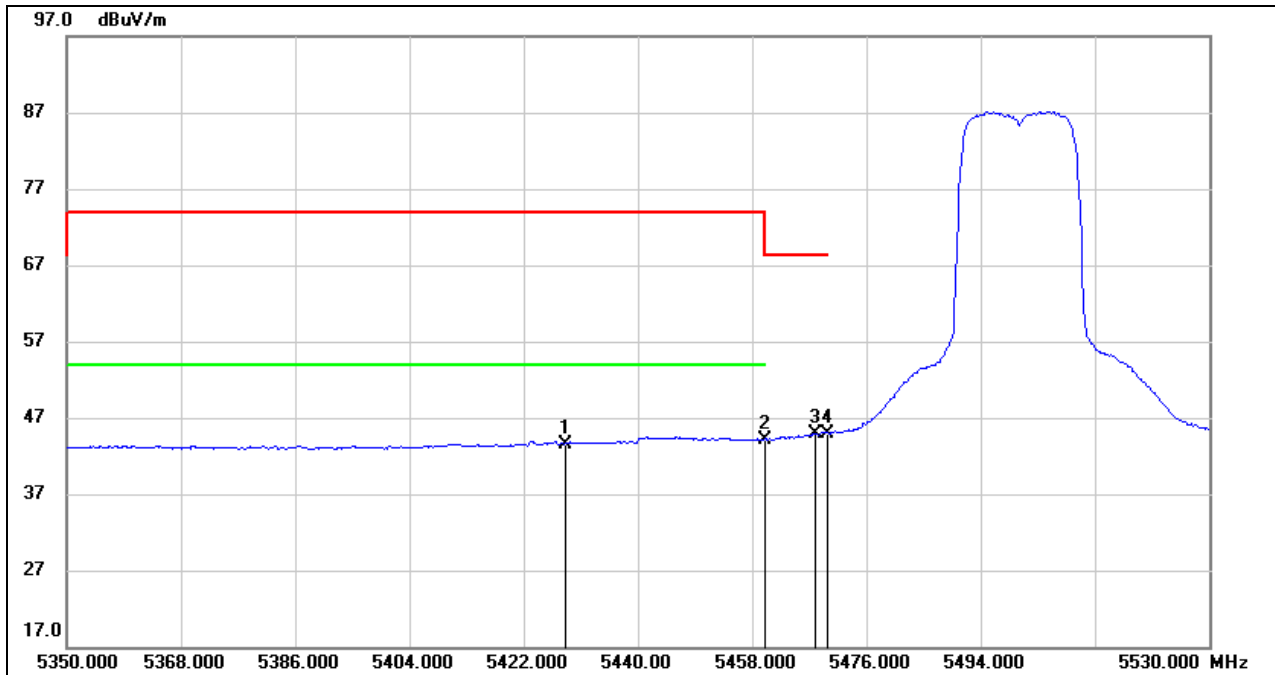

No.	Frequency (MHz)	Reading (dBuV)	Correct (dB/m)	Result (dBuV/m)	Limit (dBuV/m)	Margin (dB)	Remark
1	5428.480	2.73	40.87	43.60	54.00	-10.40	AVG
2	5460.000	2.91	41.28	44.19	54.00	-9.81	AVG
3	5467.900	3.56	41.38	44.94	68.20	-23.26	AVG
4	5470.000	3.58	41.41	44.99	68.20	-23.21	AVG

- Note:
1. Measurement = Reading Level + Correct Factor.
 2. AVG: $VBW=1/T_{on}$ where: t_{on} is transmit duration.
 3. For duty cycle, please refer to clause 7.1.
 4. Only the worst case emission will be recorder, if it complies with the limit, the other emissions deemed to comply with the limit.



RESTRICTED BANDEDGE HIGH CHANNEL

HORIZONTAL RESULTS
PEAK

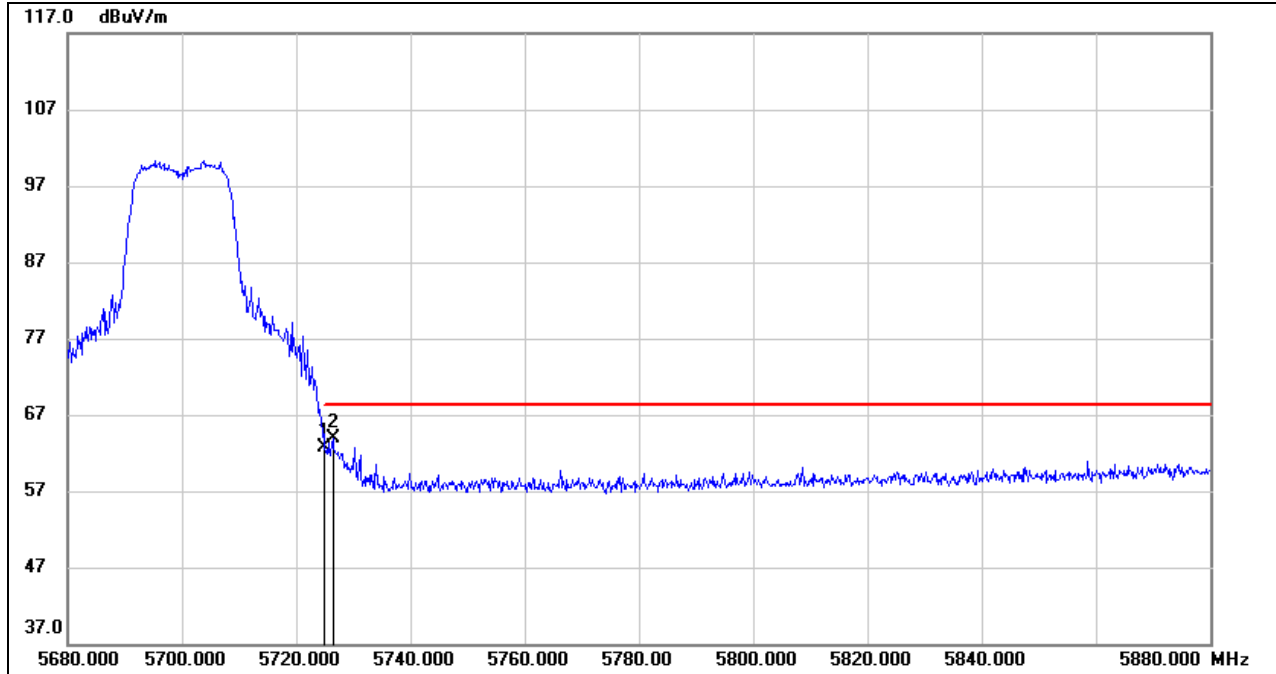

No.	Frequency (MHz)	Reading (dBuV)	Correct (dB/m)	Result (dBuV/m)	Limit (dBuV/m)	Margin (dB)	Remark
1	5725.000	21.11	41.61	62.72	68.20	-5.48	peak
2	5726.400	22.32	41.61	63.93	68.20	-4.27	peak

- Note:
1. Measurement = Reading Level + Correct Factor.
 2. If Peak Result complies with AV limit, AV Result is deemed to comply with AV limit.
 3. Peak: Peak detector.
 - 4.*indicates frequency out of the restricted bands
 5. Only the worst case emission will be recorder, if it complies with the limit, the other emissions deemed to comply with the limit.



VERTICAL RESULTS
PEAK

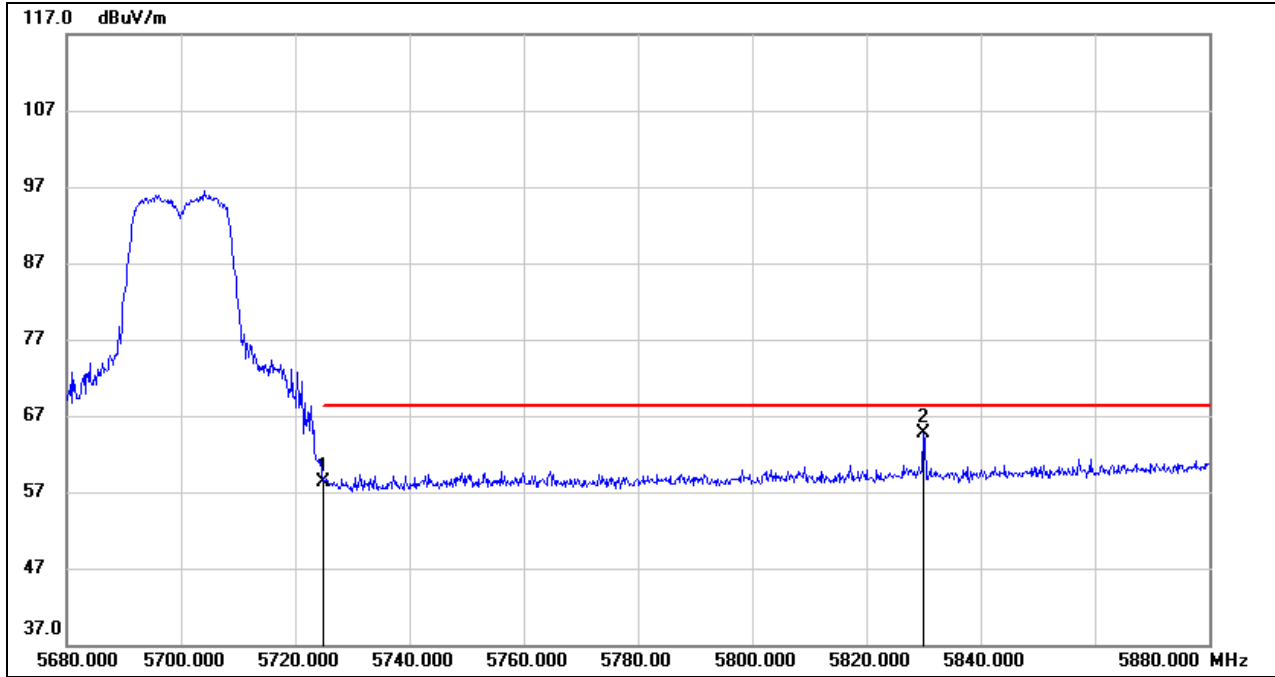

No.	Frequency (MHz)	Reading (dBuV)	Correct (dB/m)	Result (dBuV/m)	Limit (dBuV/m)	Margin (dB)	Remark
1	5725.000	16.75	41.61	58.36	68.20	-9.84	peak
2	5830.000	22.27	42.51	64.78	68.20	-3.42	peak

- Note: 1. Measurement = Reading Level + Correct Factor.
 2. If Peak Result complies with AV limit, AV Result is deemed to comply with AV limit.
 3. Peak: Peak detector.
 4.*indicates frequency out of the restricted bands
 5. Only the worst case emission will be recorder, if it complies with the limit, the other emissions deemed to comply with the limit.



HARMONICS AND SPURIOUS EMISSIONS LOW CHANNEL

HORIZONTAL RESULTS
1-7GHz

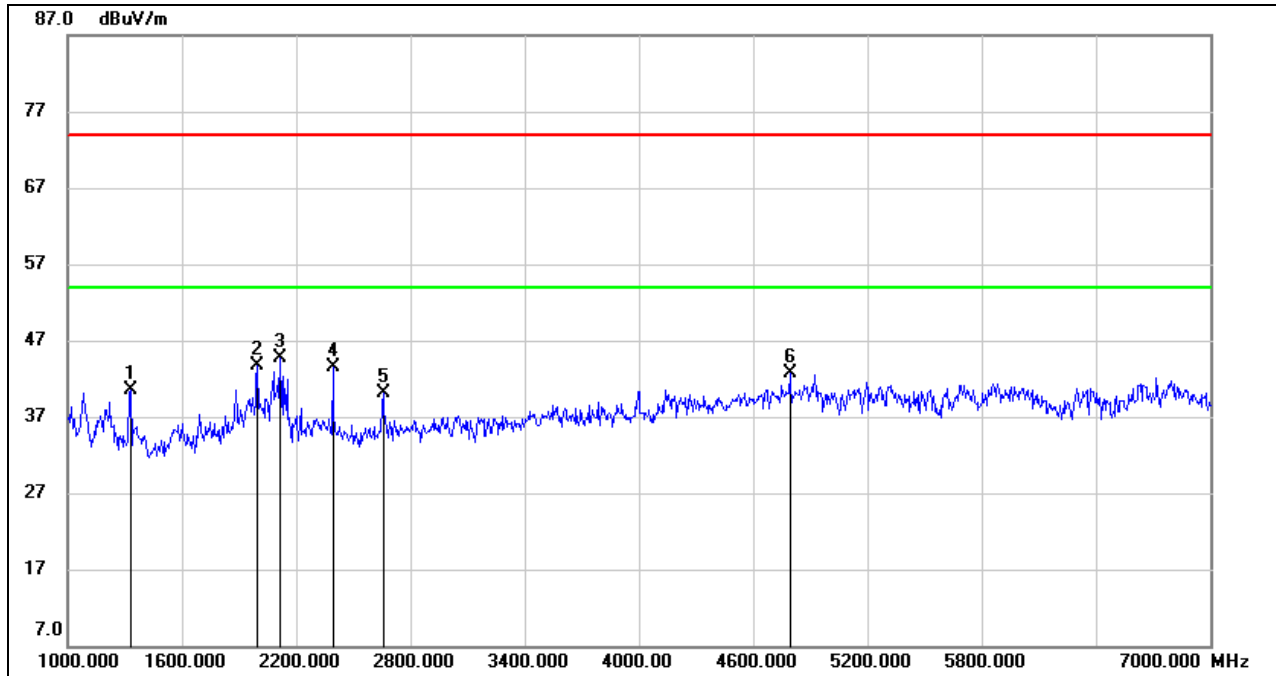

No.	Frequency (MHz)	Reading (dBuV)	Correct (dB/m)	Result (dBuV/m)	Limit (dBuV/m)	Margin (dB)	Remark
1	1330.000	53.42	-12.88	40.54	74.00	-33.46	peak
2	1996.000	54.01	-10.24	43.77	74.00	-30.23	peak
3	2116.000	54.40	-9.63	44.77	74.00	-29.23	peak
4	2392.000	52.11	-8.63	43.48	74.00	-30.52	peak
5	2656.000	47.87	-7.83	40.04	74.00	-33.96	peak
6	4792.000	42.19	0.47	42.66	74.00	-31.34	peak

- Note: 1. Measurement = Reading Level + Correct Factor.
 2. If Peak Result complies with AV limit, AV Result is deemed to comply with AV limit.
 3. Peak: Peak detector.
 4. Filter losses were only considered in the spurious frequency bands and the authorized band was not corrected for Band reject filter losses.
 5. Proper operation of the transmitter prior to adding the filter to the measurement chain.
 6. Owing to the highest peak level of unwanted emission out of the restricted bands complies with the lowest limit(54dBuV/m), so all the test point was deemed to comply with the limits list in the standard.



HORIZONTAL RESULTS
7-18GHz

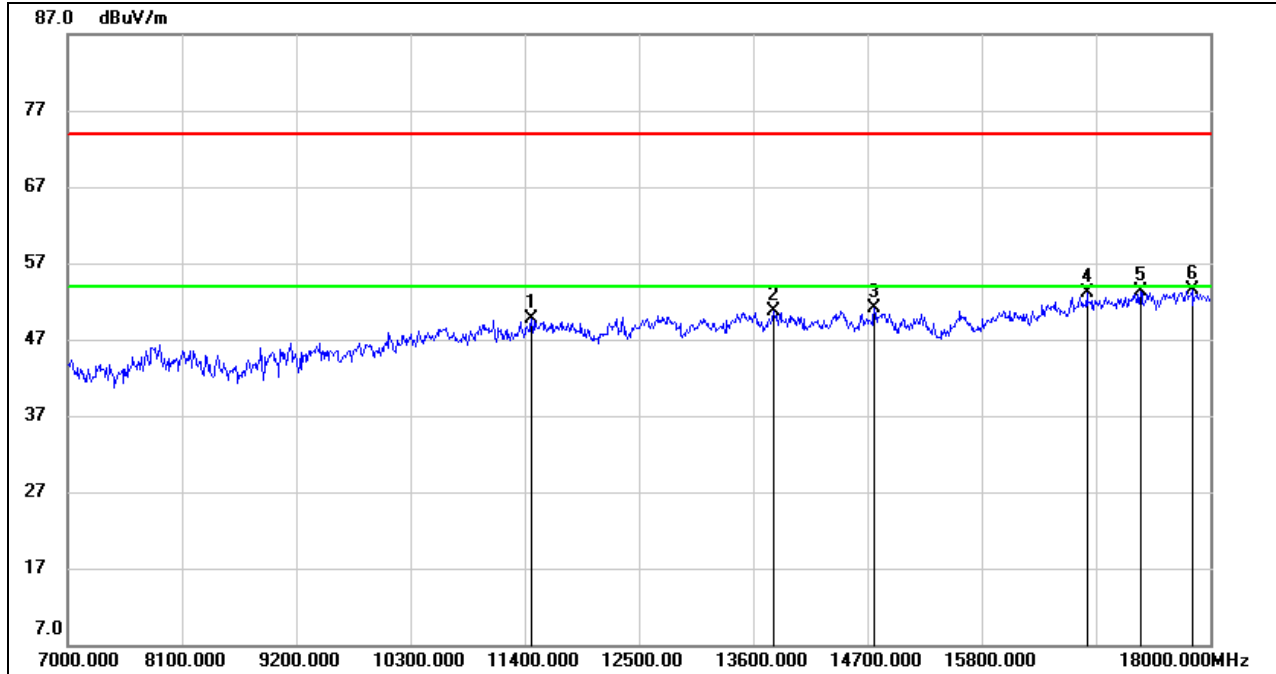

No.	Frequency (MHz)	Reading (dBuV)	Correct (dB/m)	Result (dBuV/m)	Limit (dBuV/m)	Margin (dB)	Remark
1	11466.000	36.52	13.15	49.67	74.00	-24.33	peak
2	13798.000	33.59	17.05	50.64	74.00	-23.36	peak
3	14766.000	34.98	16.11	51.09	74.00	-22.91	peak
4	16812.000	32.91	20.18	53.09	74.00	-20.91	peak
5	17329.000	31.59	21.78	53.37	74.00	-20.63	peak
6	17824.000	30.16	23.42	53.58	74.00	-20.42	peak

Note: 1. Measurement = Reading Level + Correct Factor.
 2. If Peak Result complies with AV limit, AV Result is deemed to comply with AV limit.
 3. Peak: Peak detector.
 4. Filter losses were only considered in the spurious frequency bands and the authorized band was not corrected for HPF losses.
 5. Proper operation of the transmitter prior to adding the filter to the measurement chain.
 6. Owing to the highest peak level of unwanted emission out of the restricted bands complies with the lowest limit(54dBuV/m), so all the test point was deemed to comply with the limits list in the standard.



VERTICAL RESULTS
1-7GHz

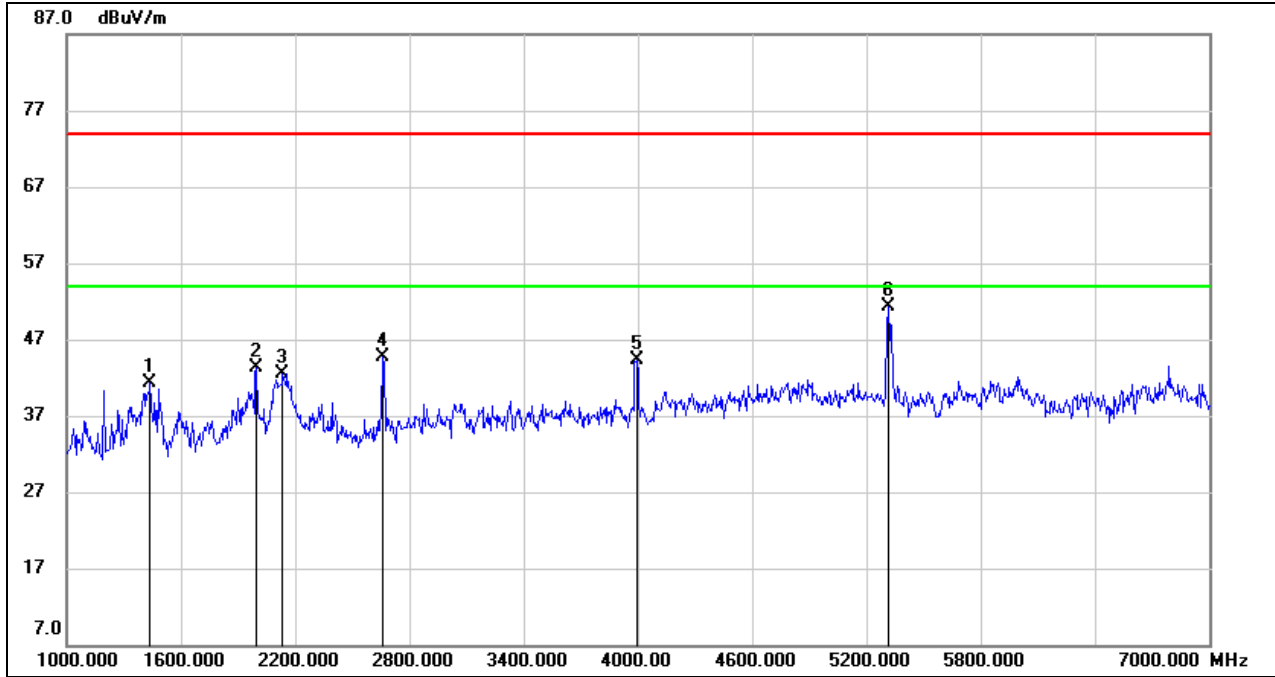

No.	Frequency (MHz)	Reading (dBuV)	Correct (dB/m)	Result (dBuV/m)	Limit (dBuV/m)	Margin (dB)	Remark
1	1438.000	53.80	-12.59	41.21	74.00	-32.79	peak
2	1996.000	53.54	-10.24	43.30	74.00	-30.70	peak
3	2134.000	51.94	-9.53	42.41	74.00	-31.59	peak
4	2662.000	52.56	-7.80	44.76	74.00	-29.24	peak
5	3994.000	48.10	-3.73	44.37	74.00	-29.63	peak
6	5314.000	49.61	1.73	51.34	74.00	-22.66	peak

Note: 1. Measurement = Reading Level + Correct Factor.
 2. If Peak Result complies with AV limit, AV Result is deemed to comply with AV limit.
 3. Peak: Peak detector.
 4. Filter losses were only considered in the spurious frequency bands and the authorized band was not corrected for Band reject filter losses.
 5. Proper operation of the transmitter prior to adding the filter to the measurement chain.
 6. Owing to the highest peak level of unwanted emission out of the restricted bands complies with the lowest limit(54dBuV/m), so all the test point was deemed to comply with the limits list in the standard.



VERTICAL RESULTS
7-18GHz

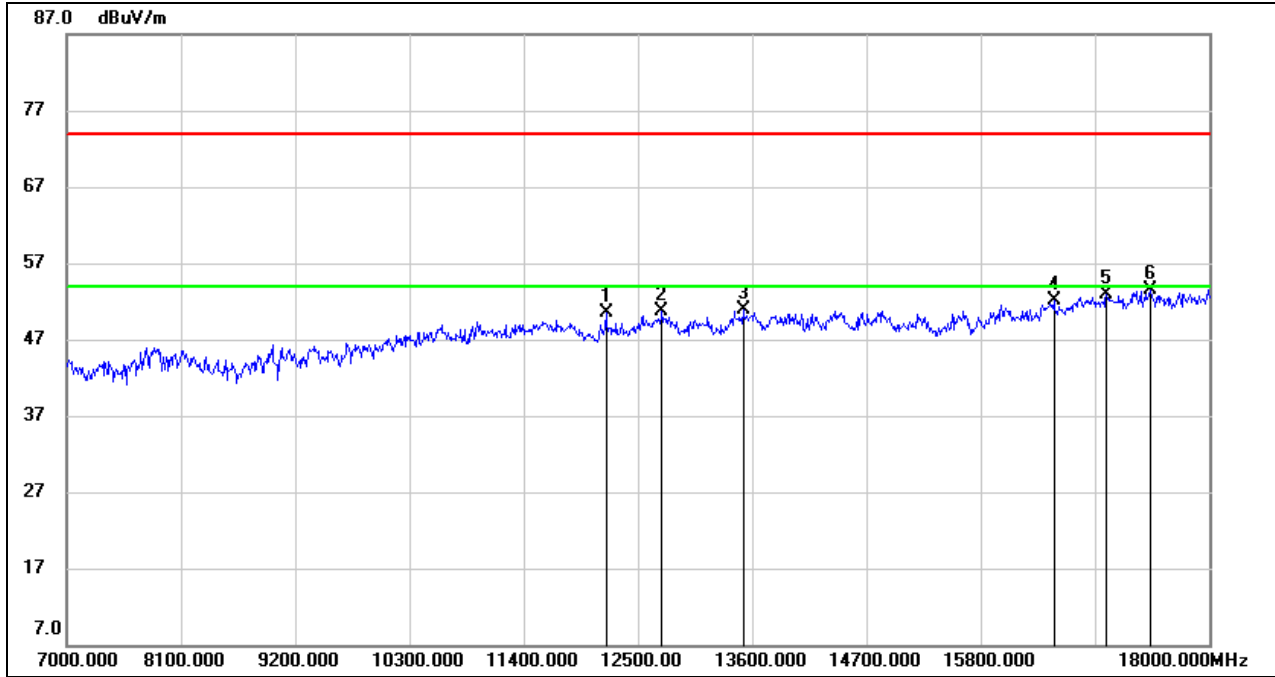

No.	Frequency (MHz)	Reading (dBuV)	Correct (dB/m)	Result (dBuV/m)	Limit (dBuV/m)	Margin (dB)	Remark
1	12192.000	36.48	14.09	50.57	74.00	-23.43	peak
2	12731.000	35.64	14.97	50.61	74.00	-23.39	peak
3	13512.000	34.90	15.92	50.82	74.00	-23.18	peak
4	16504.000	32.52	19.61	52.13	74.00	-21.87	peak
5	17010.000	32.14	20.67	52.81	74.00	-21.19	peak
6	17428.000	32.09	21.50	53.59	74.00	-20.41	peak

Note: 1. Measurement = Reading Level + Correct Factor.
 2. If Peak Result complies with AV limit, AV Result is deemed to comply with AV limit.
 3. Peak: Peak detector.
 4. Filter losses were only considered in the spurious frequency bands and the authorized band was not corrected for HPF losses.
 5. Proper operation of the transmitter prior to adding the filter to the measurement chain.
 6. Owing to the highest peak level of unwanted emission out of the restricted bands complies with the lowest limit(54dBuV/m), so all the test point was deemed to comply with the limits list in the standard.



HARMONICS AND SPURIOUS EMISSIONS MID CHANNEL

HORIZONTAL RESULTS
1-7GHz

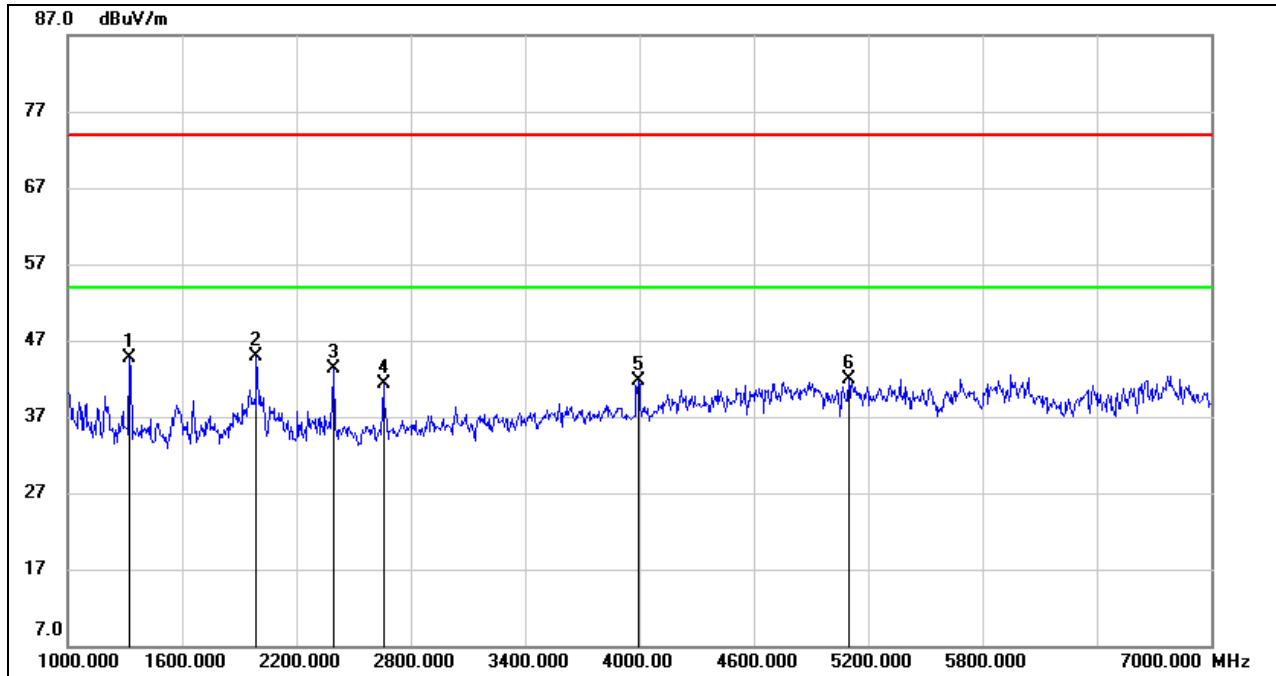

No.	Frequency (MHz)	Reading (dBuV)	Correct (dB/m)	Result (dBuV/m)	Limit (dBuV/m)	Margin (dB)	Remark
1	1324.000	57.68	-12.89	44.79	74.00	-29.21	peak
2	1990.000	55.19	-10.24	44.95	74.00	-29.05	peak
3	2398.000	52.00	-8.62	43.38	74.00	-30.62	peak
4	2656.000	49.11	-7.83	41.28	74.00	-32.72	peak
5	3994.000	45.53	-3.73	41.80	74.00	-32.20	peak
6	5098.000	40.60	1.38	41.98	74.00	-32.02	peak

Note: 1. Measurement = Reading Level + Correct Factor.
 2. If Peak Result complies with AV limit, AV Result is deemed to comply with AV limit.
 3. Peak: Peak detector.
 4. Filter losses were only considered in the spurious frequency bands and the authorized band was not corrected for Band reject filter losses.
 5. Proper operation of the transmitter prior to adding the filter to the measurement chain.
 6. Owing to the highest peak level of unwanted emission out of the restricted bands complies with the lowest limit(54dBuV/m), so all the test point was deemed to comply with the limits list in the standard.



HORIZONTAL RESULTS
7-18GHz

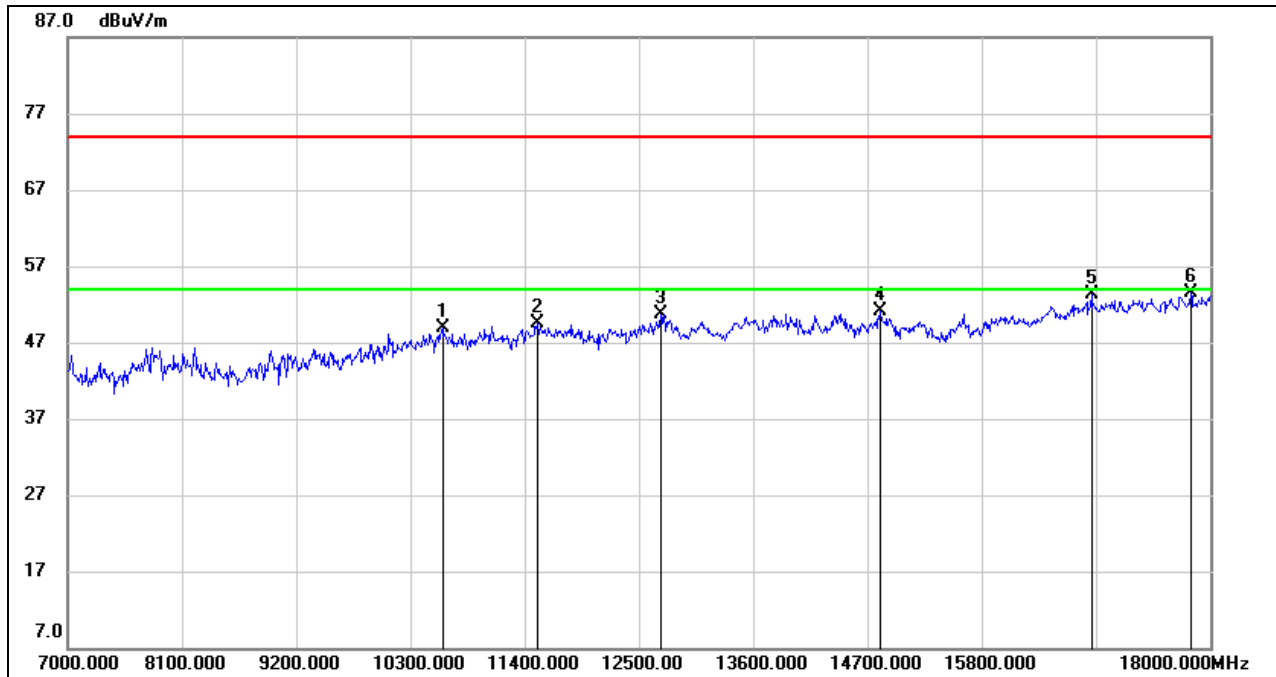

No.	Frequency (MHz)	Reading (dBuV)	Correct (dB/m)	Result (dBuV/m)	Limit (dBuV/m)	Margin (dB)	Remark
1	10608.000	36.45	12.39	48.84	74.00	-25.16	peak
2	11521.000	36.06	13.40	49.46	74.00	-24.54	peak
3	12709.000	36.06	14.59	50.65	74.00	-23.35	peak
4	14821.000	34.93	16.09	51.02	74.00	-22.98	peak
5	16856.000	33.16	20.13	53.29	74.00	-20.71	peak
6	17813.000	30.04	23.41	53.45	74.00	-20.55	peak

Note: 1. Measurement = Reading Level + Correct Factor.
 2. If Peak Result complies with AV limit, AV Result is deemed to comply with AV limit.
 3. Peak: Peak detector.
 4. Filter losses were only considered in the spurious frequency bands and the authorized band was not corrected for HPF losses.
 5. Proper operation of the transmitter prior to adding the filter to the measurement chain.
 6. Owing to the highest peak level of unwanted emission out of the restricted bands complies with the lowest limit(54dBuV/m), so all the test point was deemed to comply with the limits list in the standard.



VERTICAL RESULTS
1-7GHz

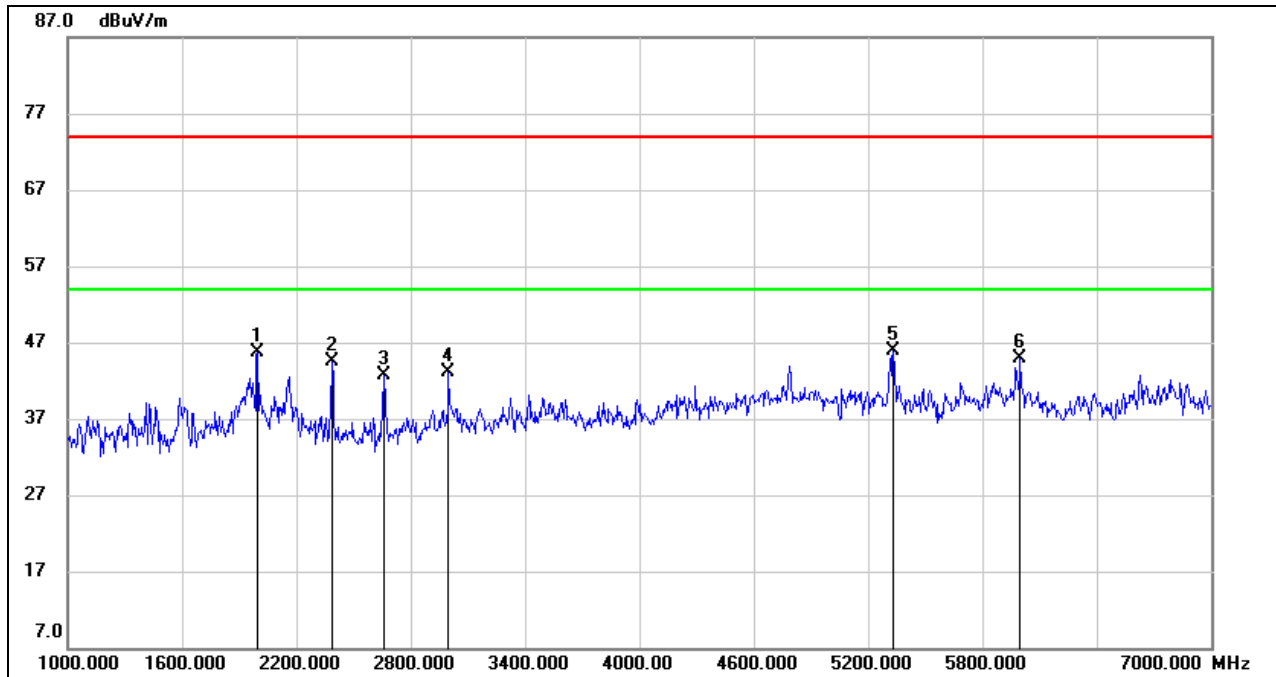

No.	Frequency (MHz)	Reading (dBuV)	Correct (dB/m)	Result (dBuV/m)	Limit (dBuV/m)	Margin (dB)	Remark
1	1996.000	55.96	-10.24	45.72	74.00	-28.28	peak
2	2386.000	53.18	-8.67	44.51	74.00	-29.49	peak
3	2662.000	50.53	-7.80	42.73	74.00	-31.27	peak
4	2998.000	49.25	-6.08	43.17	74.00	-30.83	peak
5	5332.000	44.25	1.69	45.94	74.00	-28.06	peak
6	5998.000	42.26	2.61	44.87	74.00	-29.13	peak

Note: 1. Measurement = Reading Level + Correct Factor.
 2. If Peak Result complies with AV limit, AV Result is deemed to comply with AV limit.
 3. Peak: Peak detector.
 4. Filter losses were only considered in the spurious frequency bands and the authorized band was not corrected for Band reject filter losses.
 5. Proper operation of the transmitter prior to adding the filter to the measurement chain.
 6. Owing to the highest peak level of unwanted emission out of the restricted bands complies with the lowest limit(54dBuV/m), so all the test point was deemed to comply with the limits list in the standard.



7-18GHz

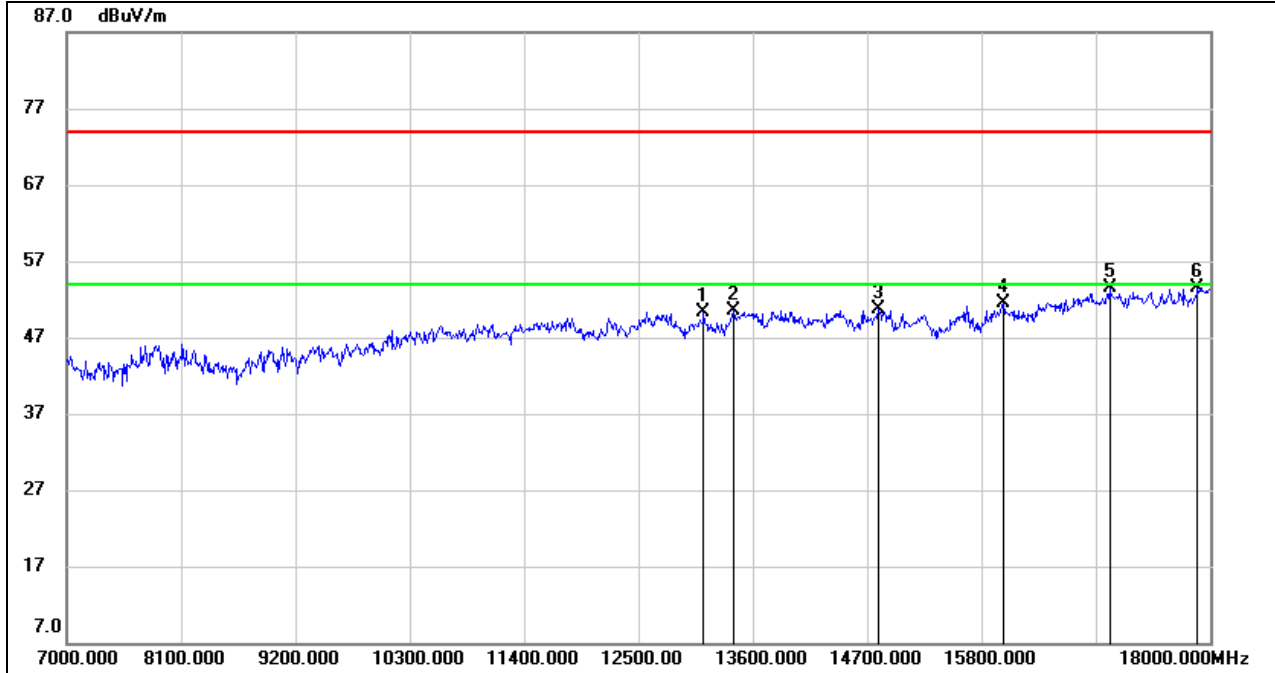

No.	Frequency (MHz)	Reading (dBuV)	Correct (dB/m)	Result (dBuV/m)	Limit (dBuV/m)	Margin (dB)	Remark
1	13127.000	34.93	15.42	50.35	74.00	-23.65	peak
2	13413.000	34.27	16.15	50.42	74.00	-23.58	peak
3	14810.000	34.61	16.07	50.68	74.00	-23.32	peak
4	16009.000	33.68	17.85	51.53	74.00	-22.47	peak
5	17032.000	32.85	20.72	53.57	74.00	-20.43	peak
6	17879.000	30.16	23.40	53.56	74.00	-20.44	peak

Note: 1. Measurement = Reading Level + Correct Factor.
 2. If Peak Result complies with AV limit, AV Result is deemed to comply with AV limit.
 3. Peak: Peak detector.
 4. Filter losses were only considered in the spurious frequency bands and the authorized band was not corrected for HPF losses.
 5. Proper operation of the transmitter prior to adding the filter to the measurement chain.
 6. Owing to the highest peak level of unwanted emission out of the restricted bands complies with the lowest limit(54dBuV/m), so all the test point was deemed to comply with the limits list in the standard.



HARMONICS AND SPURIOUS EMISSIONS HIGH CHANNEL

HORIZONTAL RESULTS
1-7GHz

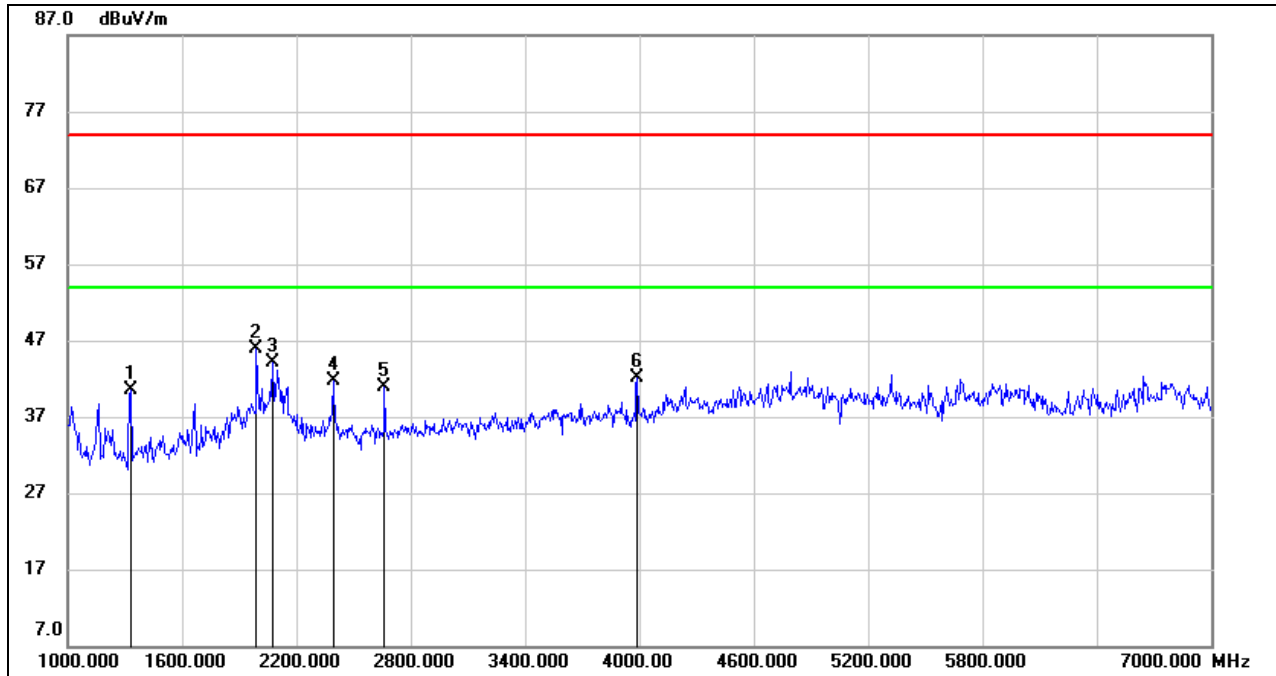

No.	Frequency (MHz)	Reading (dBuV)	Correct (dB/m)	Result (dBuV/m)	Limit (dBuV/m)	Margin (dB)	Remark
1	1330.000	53.31	-12.88	40.43	74.00	-33.57	peak
2	1990.000	56.07	-10.24	45.83	74.00	-28.17	peak
3	2074.000	53.93	-9.85	44.08	74.00	-29.92	peak
4	2392.000	50.28	-8.63	41.65	74.00	-32.35	peak
5	2662.000	48.66	-7.80	40.86	74.00	-33.14	peak
6	3988.000	45.89	-3.72	42.17	74.00	-31.83	peak

Note: 1. Measurement = Reading Level + Correct Factor.
 2. If Peak Result complies with AV limit, AV Result is deemed to comply with AV limit.
 3. Peak: Peak detector.
 4. Filter losses were only considered in the spurious frequency bands and the authorized band was not corrected for Band reject filter losses.
 5. Proper operation of the transmitter prior to adding the filter to the measurement chain.
 6. Owing to the highest peak level of unwanted emission out of the restricted bands complies with the lowest limit(54dBuV/m), so all the test point was deemed to comply with the limits list in the standard.



HORIZONTAL RESULTS
7-18GHz

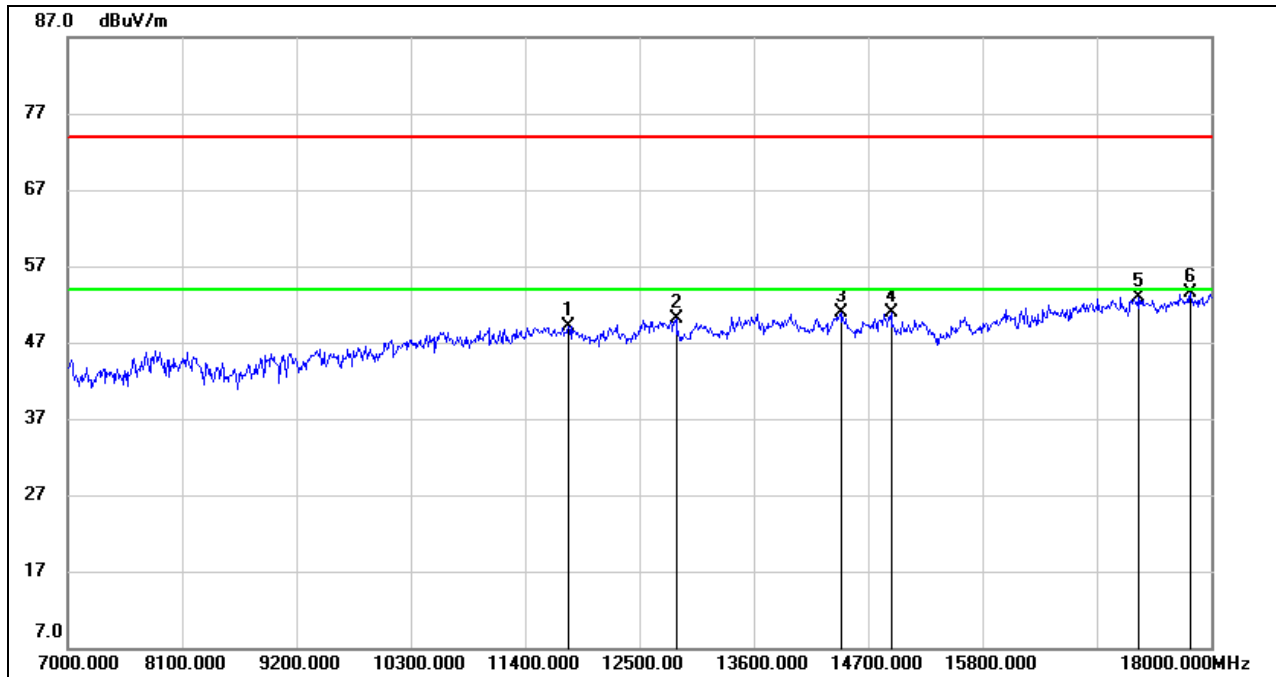

No.	Frequency (MHz)	Reading (dBuV)	Correct (dB/m)	Result (dBuV/m)	Limit (dBuV/m)	Margin (dB)	Remark
1	11818.000	35.90	13.29	49.19	74.00	-24.81	peak
2	12852.000	34.42	15.61	50.03	74.00	-23.97	peak
3	14436.000	34.23	16.64	50.87	74.00	-23.13	peak
4	14920.000	34.81	16.15	50.96	74.00	-23.04	peak
5	17296.000	31.10	21.86	52.96	74.00	-21.04	peak
6	17802.000	30.03	23.41	53.44	74.00	-20.56	peak

Note: 1. Measurement = Reading Level + Correct Factor.
 2. If Peak Result complies with AV limit, AV Result is deemed to comply with AV limit.
 3. Peak: Peak detector.
 4. Filter losses were only considered in the spurious frequency bands and the authorized band was not corrected for HPF losses.
 5. Proper operation of the transmitter prior to adding the filter to the measurement chain.
 6. Owing to the highest peak level of unwanted emission out of the restricted bands complies with the lowest limit(54dBuV/m), so all the test point was deemed to comply with the limits list in the standard.



VERTICAL RESULTS
1-7GHz

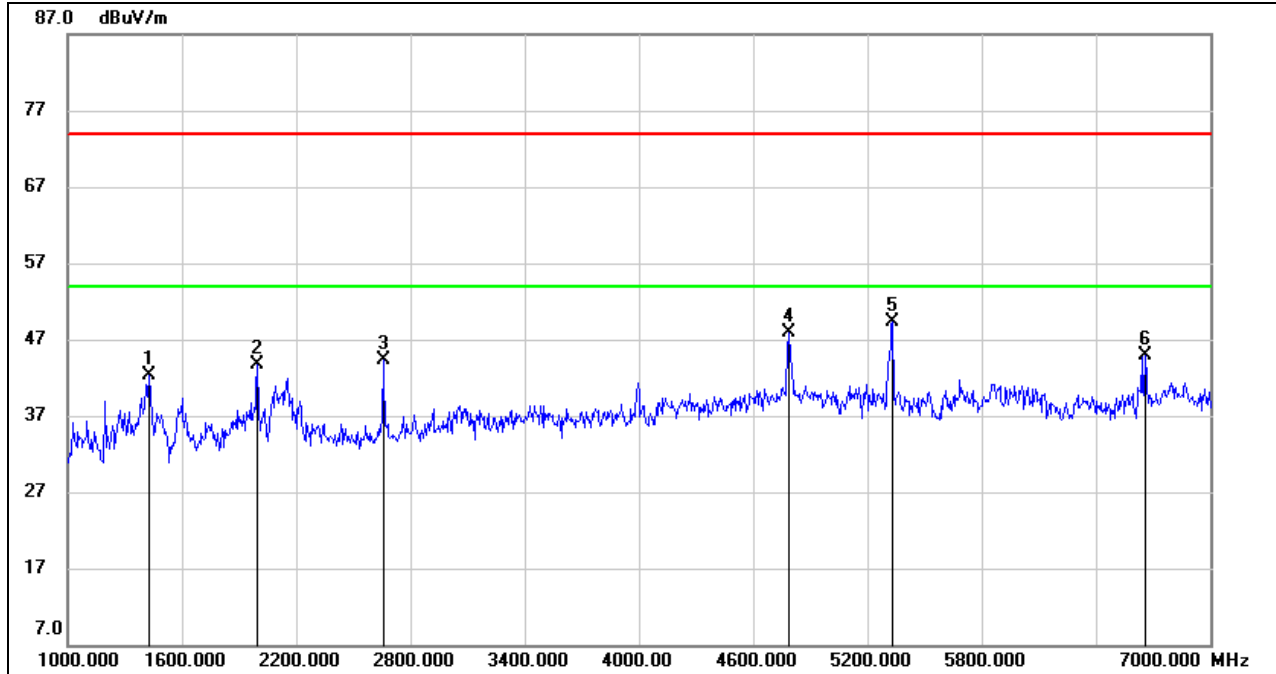

No.	Frequency (MHz)	Reading (dBuV)	Correct (dB/m)	Result (dBuV/m)	Limit (dBuV/m)	Margin (dB)	Remark
1	1426.000	55.03	-12.65	42.38	74.00	-31.62	peak
2	1996.000	53.87	-10.24	43.63	74.00	-30.37	peak
3	2656.000	52.04	-7.83	44.21	74.00	-29.79	peak
4	4786.000	47.50	0.44	47.94	74.00	-26.06	peak
5	5332.000	47.62	1.69	49.31	74.00	-24.69	peak
6	6658.000	40.40	4.46	44.86	74.00	-29.14	peak

Note: 1. Measurement = Reading Level + Correct Factor.
 2. If Peak Result complies with AV limit, AV Result is deemed to comply with AV limit.
 3. Peak: Peak detector.
 4. Filter losses were only considered in the spurious frequency bands and the authorized band was not corrected for Band reject filter losses.
 5. Proper operation of the transmitter prior to adding the filter to the measurement chain.
 6. Owing to the highest peak level of unwanted emission out of the restricted bands complies with the lowest limit(54dBuV/m), so all the test point was deemed to comply with the limits list in the standard.



7-18GHz

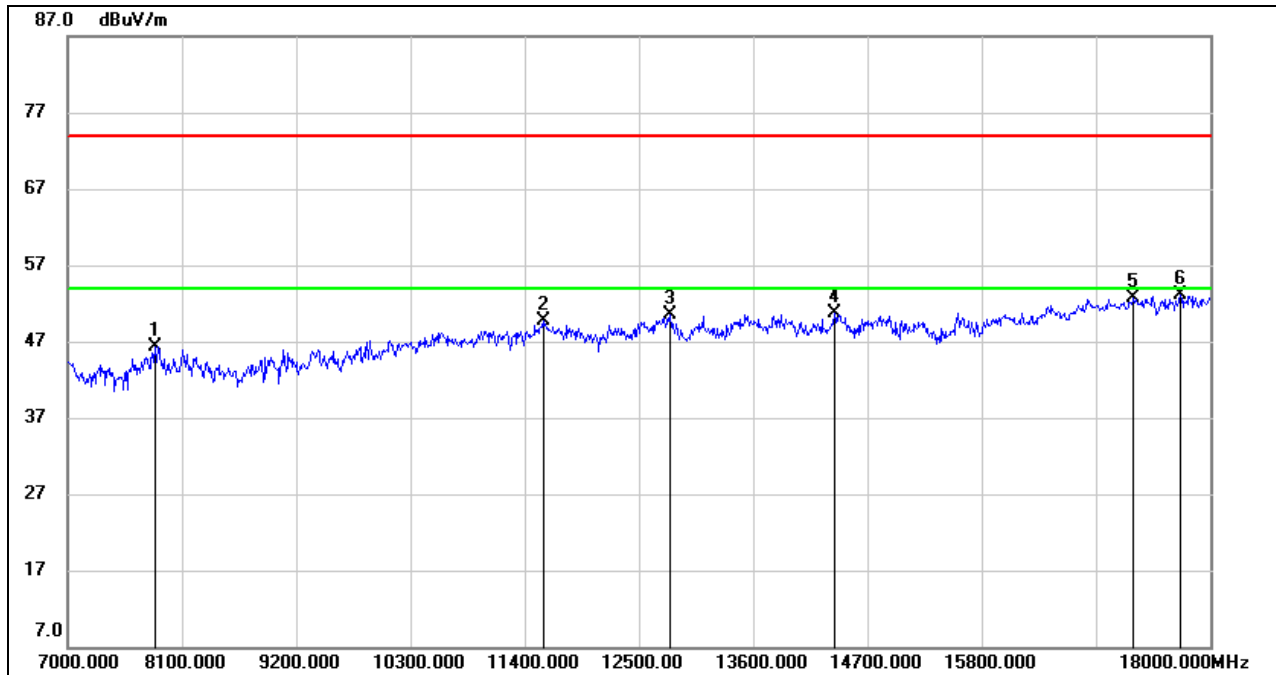

No.	Frequency (MHz)	Reading (dBuV)	Correct (dB/m)	Result (dBuV/m)	Limit (dBuV/m)	Margin (dB)	Remark
1	7836.000	38.32	7.96	46.28	74.00	-27.72	peak
2	11576.000	36.18	13.51	49.69	74.00	-24.31	peak
3	12797.000	34.37	16.12	50.49	74.00	-23.51	peak
4	14381.000	34.03	16.62	50.65	74.00	-23.35	peak
5	17263.000	30.99	21.64	52.63	74.00	-21.37	peak
6	17714.000	30.48	22.62	53.10	74.00	-20.90	peak

Note: 1. Measurement = Reading Level + Correct Factor.
 2. If Peak Result complies with AV limit, AV Result is deemed to comply with AV limit.
 3. Peak: Peak detector.
 4. Filter losses were only considered in the spurious frequency bands and the authorized band was not corrected for HPF losses.
 5. Proper operation of the transmitter prior to adding the filter to the measurement chain.
 6. Owing to the highest peak level of unwanted emission out of the restricted bands complies with the lowest limit(54dBuV/m), so all the test point was deemed to comply with the limits list in the standard.



8.2.4. UNII-3 BAND

RESTRICTED BANDEDGE LOW CHANNEL

HORIZONTAL RESULTS

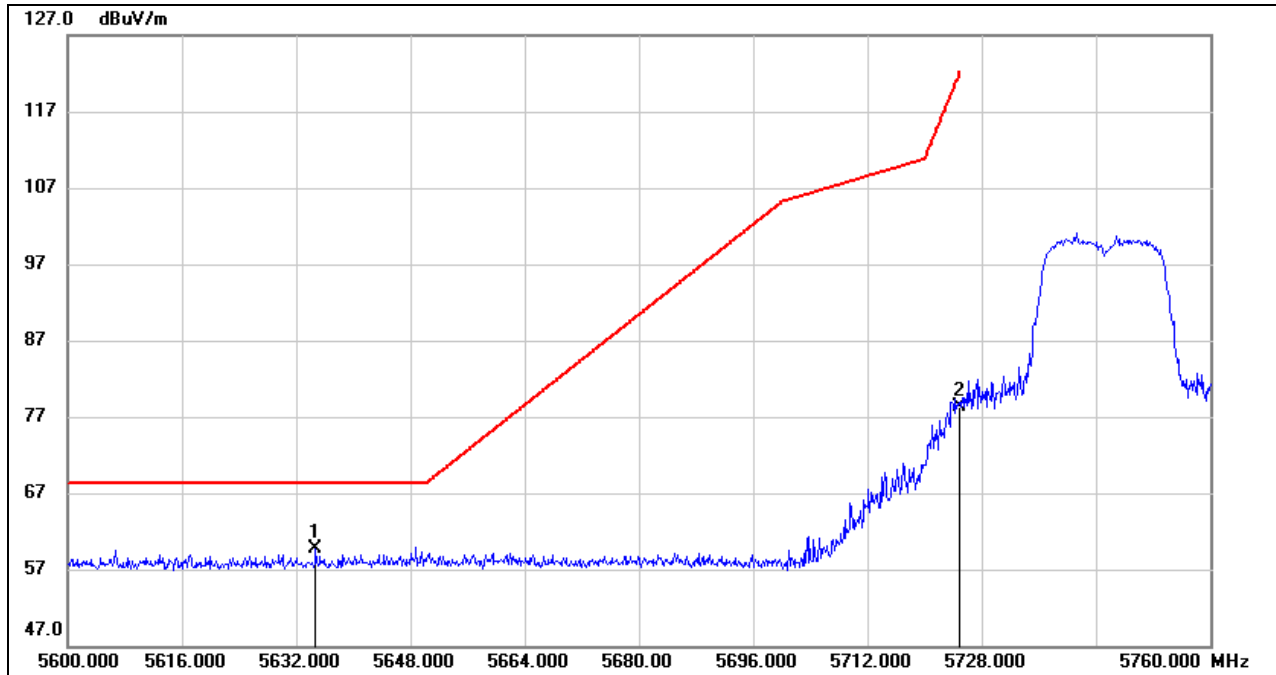

No.	Frequency (MHz)	Reading (dBuV)	Correct (dB/m)	Result (dBuV/m)	Limit (dBuV/m)	Margin (dB)	Remark
1	5634.720	18.24	41.47	59.71	68.20	-8.49	peak
2	5725.000	36.78	41.61	78.39	122.20	-43.81	peak

Note: 1. Measurement = Reading Level + Correct Factor.



VERTICAL RESULTS

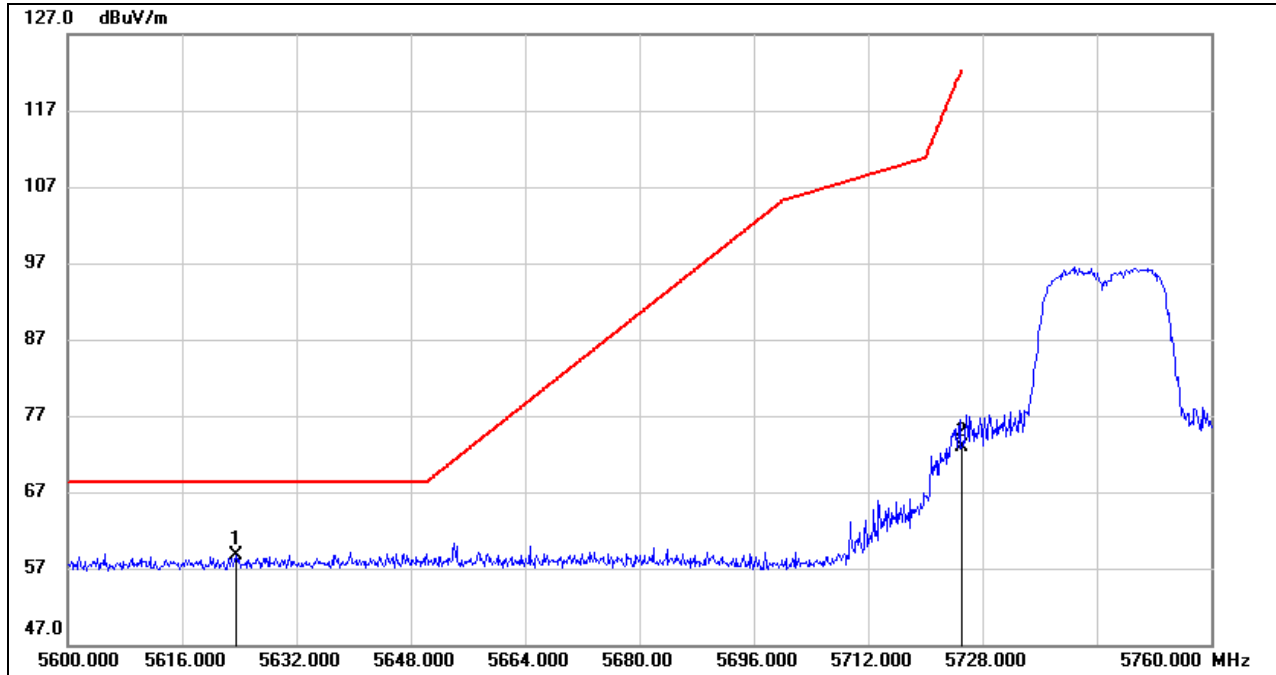

No.	Frequency (MHz)	Reading (dBuV)	Correct (dB/m)	Result (dBuV/m)	Limit (dBuV/m)	Margin (dB)	Remark
1	5623.520	17.32	41.47	58.79	68.20	-9.41	peak
2	5725.000	31.26	41.61	72.87	122.20	-49.33	peak

Note: 1. Measurement = Reading Level + Correct Factor.



RESTRICTED BANDEDGE HIGH CHANNEL

HORIZONTAL RESULTS

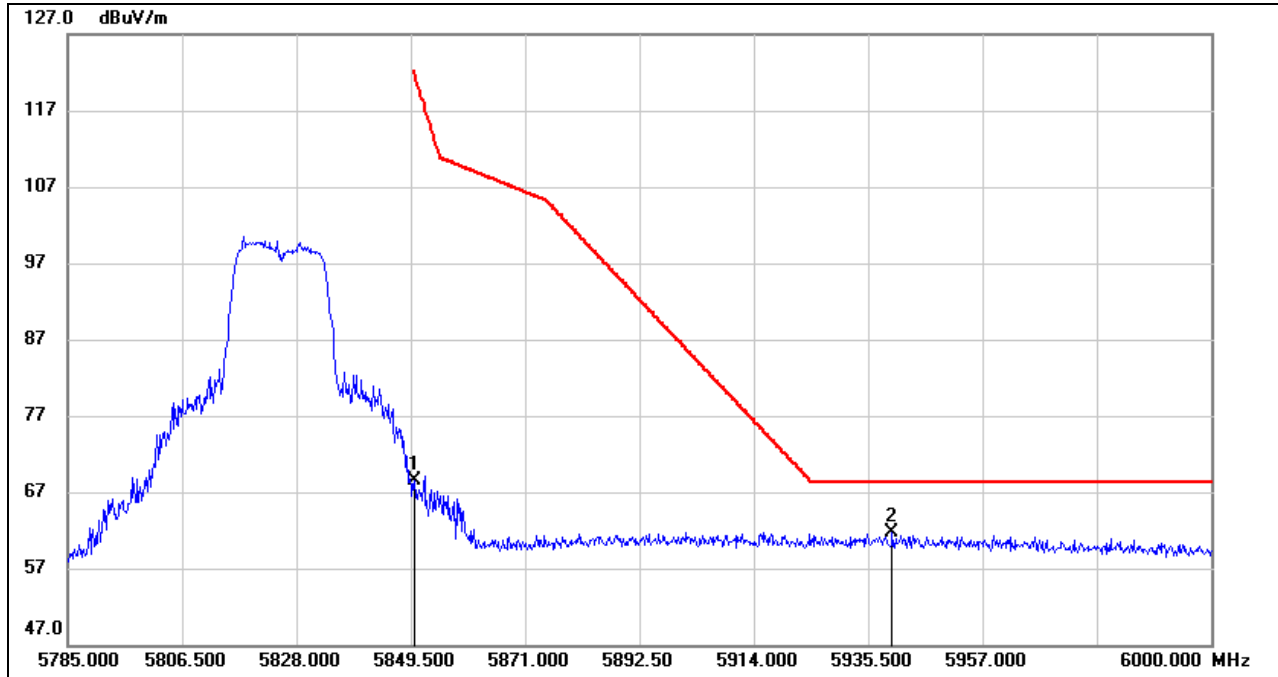

No.	Frequency (MHz)	Reading (dBuV)	Correct (dB/m)	Result (dBuV/m)	Limit (dBuV/m)	Margin (dB)	Remark
1	5850.000	25.60	42.89	68.49	122.20	-53.71	peak
2	5940.015	18.44	43.17	61.61	68.20	-6.59	peak

Note: 1. Measurement = Reading Level + Correct Factor.



VERTICAL RESULTS

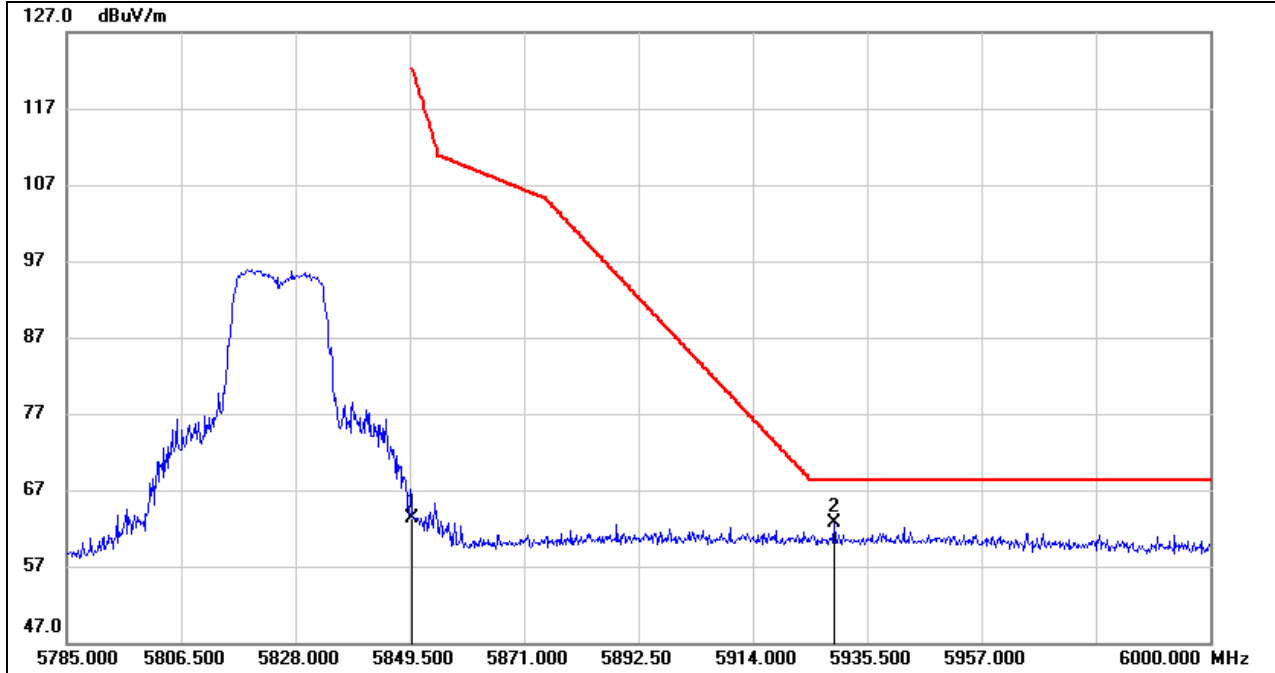

No.	Frequency (MHz)	Reading (dBuV)	Correct (dB/m)	Result (dBuV/m)	Limit (dBuV/m)	Margin (dB)	Remark
1	5850.000	20.37	42.89	63.26	122.20	-58.94	peak
2	5929.265	19.36	43.35	62.71	68.20	-5.49	peak

Note: 1. Measurement = Reading Level + Correct Factor.



HARMONICS AND SPURIOUS EMISSIONS LOW CHANNEL

HORIZONTAL RESULTS
1-7GHz

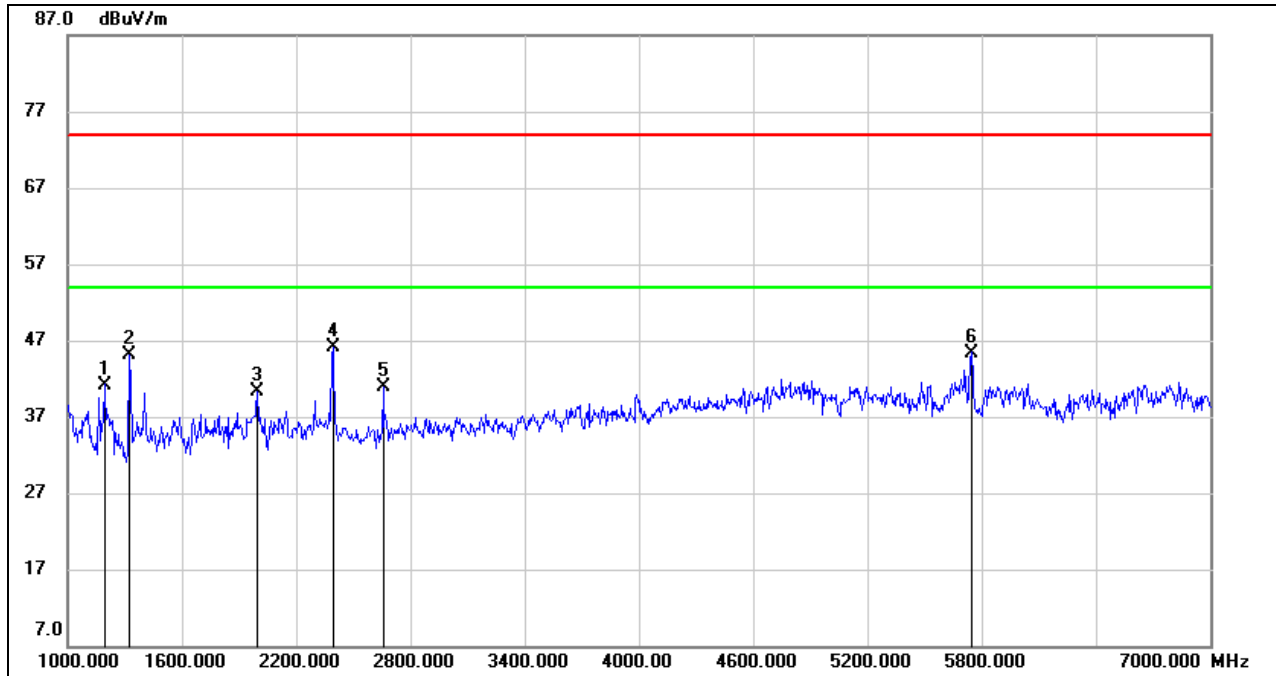

No.	Frequency (MHz)	Reading (dBuV)	Correct (dB/m)	Result (dBuV/m)	Limit (dBuV/m)	Margin (dB)	Remark
1	1192.000	54.30	-13.10	41.20	74.00	-32.80	peak
2	1324.000	57.90	-12.89	45.01	74.00	-28.99	peak
3	1996.000	50.46	-10.24	40.22	74.00	-33.78	peak
4	2392.000	54.73	-8.63	46.10	74.00	-27.90	peak
5	2656.000	48.66	-7.83	40.83	74.00	-33.17	peak
6	5745.000	43.44	1.96	45.40	74.00	-28.60	peak

- Note: 1. Measurement = Reading Level + Correct Factor.
 2. If Peak Result complies with AV limit, AV Result is deemed to comply with AV limit.
 3. Peak: Peak detector.
 4. Filter losses were only considered in the spurious frequency bands and the authorized band was not corrected for Band reject filter losses.
 5. Proper operation of the transmitter prior to adding the filter to the measurement chain.
 6. Owing to the highest peak level of unwanted emission out of the restricted bands complies with the lowest limit(54dBuV/m), so all the test point was deemed to comply with the limits list in the standard.



HORIZONTAL RESULTS
7-18GHz

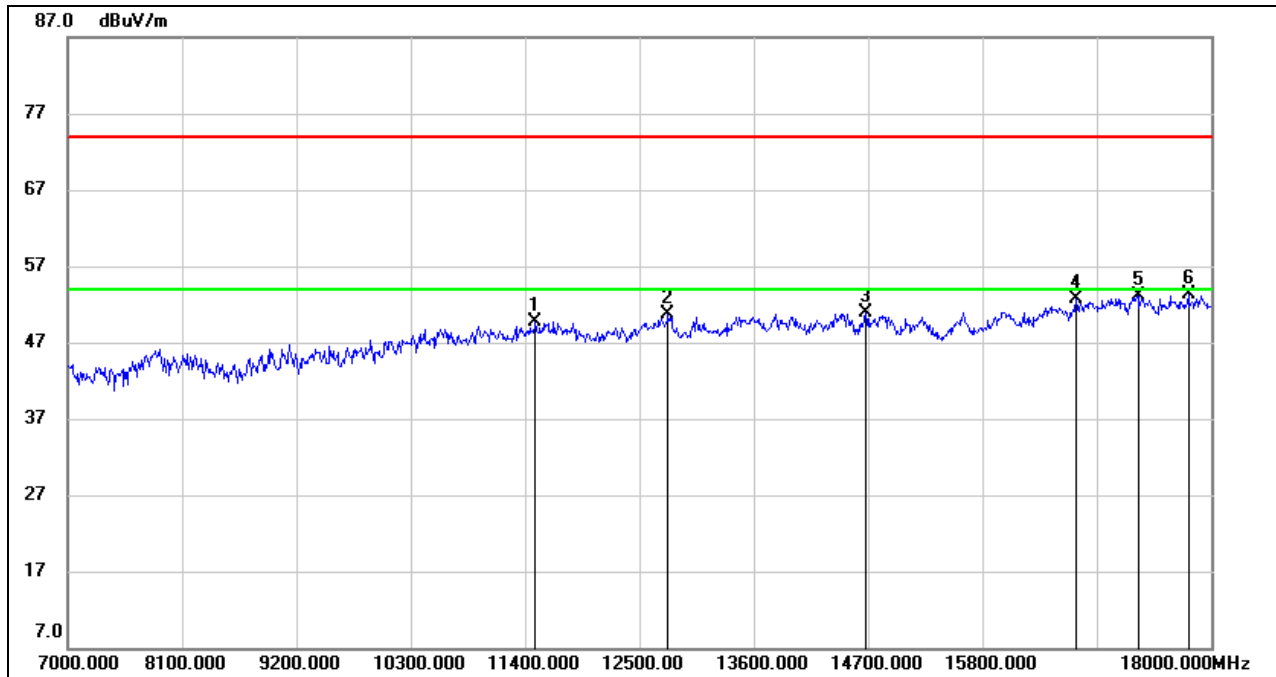

No.	Frequency (MHz)	Reading (dBuV)	Correct (dB/m)	Result (dBuV/m)	Limit (dBuV/m)	Margin (dB)	Remark
1	11499.000	36.29	13.35	49.64	74.00	-24.36	peak
2	12775.000	34.99	15.74	50.73	74.00	-23.27	peak
3	14678.000	34.80	16.18	50.98	74.00	-23.02	peak
4	16702.000	32.63	20.06	52.69	74.00	-21.31	peak
5	17296.000	31.24	21.86	53.10	74.00	-20.90	peak
6	17780.000	30.16	23.23	53.39	74.00	-20.61	peak

Note: 1. Measurement = Reading Level + Correct Factor.
 2. If Peak Result complies with AV limit, AV Result is deemed to comply with AV limit.
 3. Peak: Peak detector.
 4. Filter losses were only considered in the spurious frequency bands and the authorized band was not corrected for HPF losses.
 5. Proper operation of the transmitter prior to adding the filter to the measurement chain.
 6. Owing to the highest peak level of unwanted emission out of the restricted bands complies with the lowest limit(54dBuV/m), so all the test point was deemed to comply with the limits list in the standard.



VERTICAL RESULTS
1-7GHz

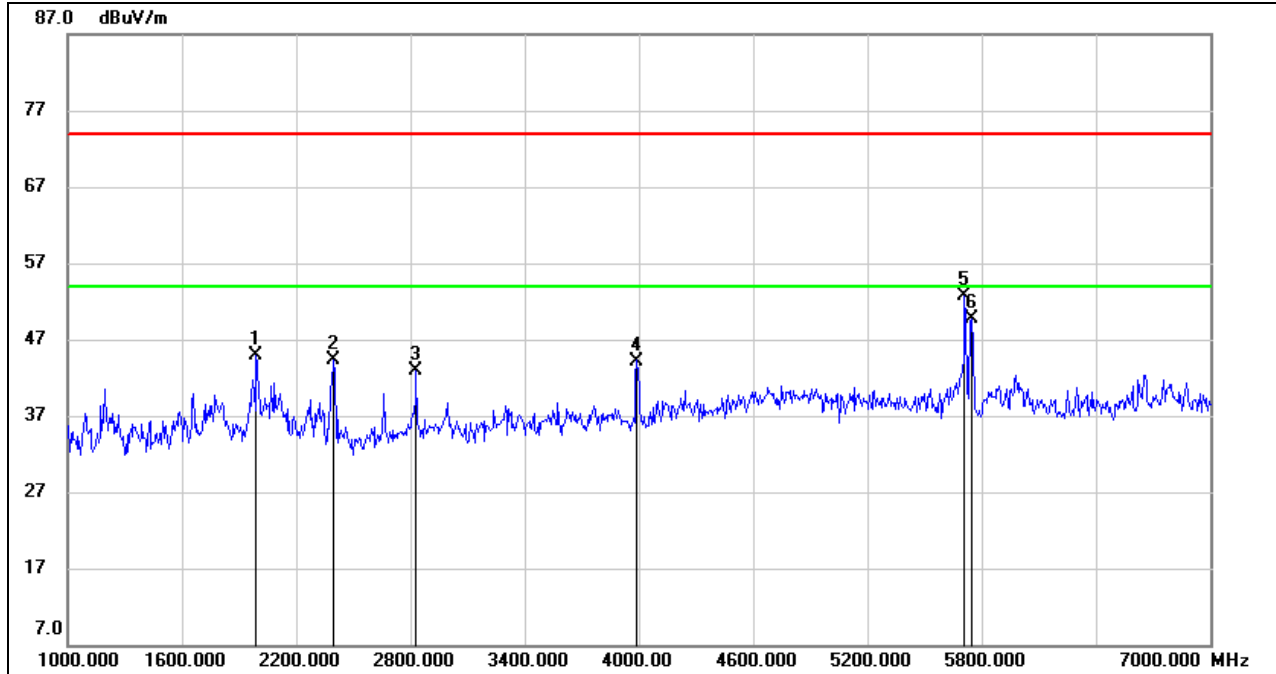

No.	Frequency (MHz)	Reading (dBuV)	Correct (dB/m)	Result (dBuV/m)	Limit (dBuV/m)	Margin (dB)	Remark
1	1990.000	55.13	-10.24	44.89	74.00	-29.11	peak
2	2398.000	52.94	-8.62	44.32	74.00	-29.68	peak
3	2830.000	49.75	-6.81	42.94	74.00	-31.06	peak
4	3988.000	47.92	-3.72	44.20	74.00	-29.80	peak
5	5710.000	50.71	1.98	52.69	74.00	-21.31	peak
6	5745.000	47.79	1.96	49.75	74.00	-24.25	peak

Note: 1. Measurement = Reading Level + Correct Factor.
 2. If Peak Result complies with AV limit, AV Result is deemed to comply with AV limit.
 3. Peak: Peak detector.
 4. Filter losses were only considered in the spurious frequency bands and the authorized band was not corrected for Band reject filter losses.
 5. Proper operation of the transmitter prior to adding the filter to the measurement chain.
 6. Owing to the highest peak level of unwanted emission out of the restricted bands complies with the lowest limit(54dBuV/m), so all the test point was deemed to comply with the limits list in the standard.



VERTICAL RESULTS
7-18GHz

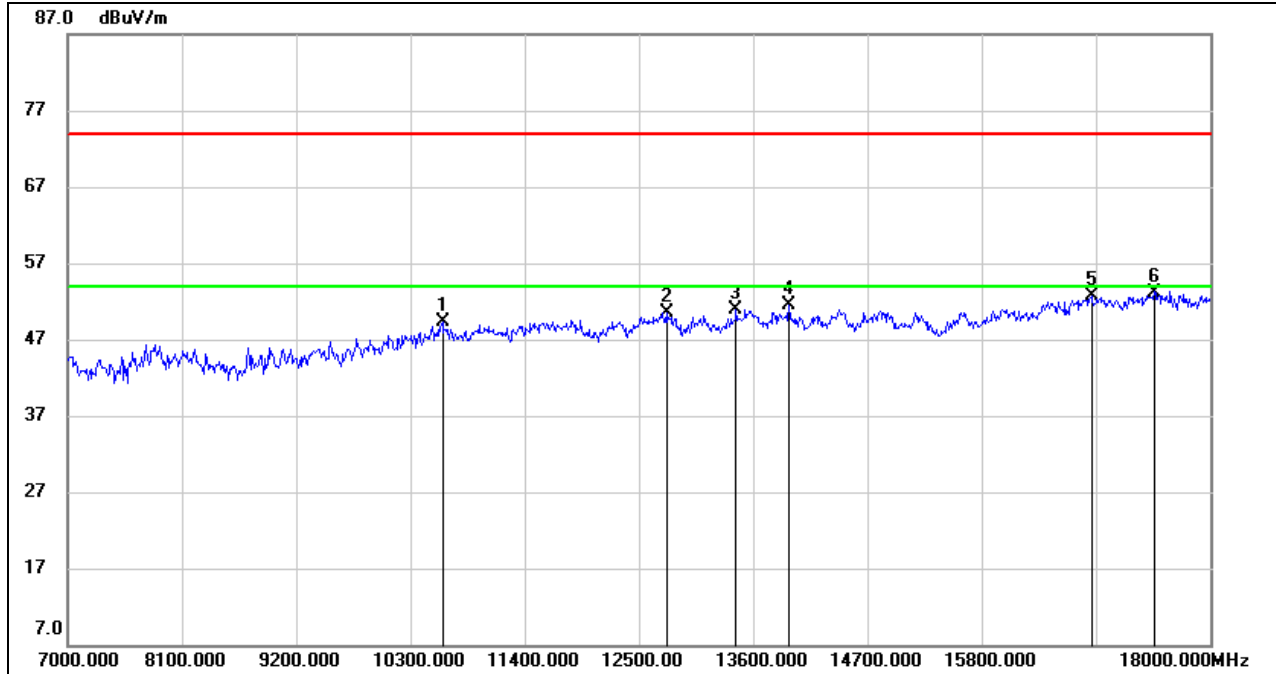

No.	Frequency (MHz)	Reading (dBuV)	Correct (dB/m)	Result (dBuV/m)	Limit (dBuV/m)	Margin (dB)	Remark
1	10608.000	36.99	12.39	49.38	74.00	-24.62	peak
2	12764.000	34.96	15.54	50.50	74.00	-23.50	peak
3	13435.000	34.85	16.08	50.93	74.00	-23.07	peak
4	13941.000	35.35	16.16	51.51	74.00	-22.49	peak
5	16856.000	32.52	20.13	52.65	74.00	-21.35	peak
6	17461.000	31.73	21.47	53.20	74.00	-20.80	peak

Note: 1. Measurement = Reading Level + Correct Factor.
 2. If Peak Result complies with AV limit, AV Result is deemed to comply with AV limit.
 3. Peak: Peak detector.
 4. Filter losses were only considered in the spurious frequency bands and the authorized band was not corrected for HPF losses.
 5. Proper operation of the transmitter prior to adding the filter to the measurement chain.
 6. Owing to the highest peak level of unwanted emission out of the restricted bands complies with the lowest limit(54dBuV/m), so all the test point was deemed to comply with the limits list in the standard.



HARMONICS AND SPURIOUS EMISSIONS MID CHANNEL

HORIZONTAL RESULTS
1-7GHz

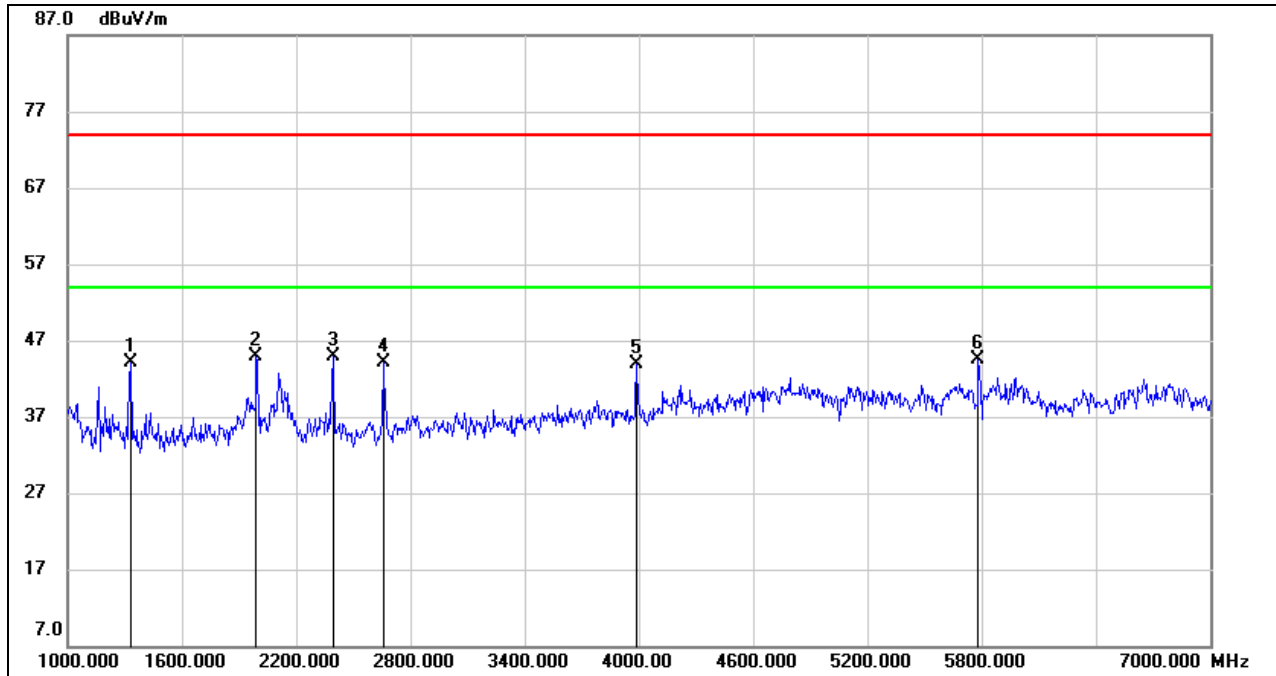

No.	Frequency (MHz)	Reading (dBuV)	Correct (dB/m)	Result (dBuV/m)	Limit (dBuV/m)	Margin (dB)	Remark
1	1330.000	57.08	-12.88	44.20	74.00	-29.80	peak
2	1990.000	55.08	-10.24	44.84	74.00	-29.16	peak
3	2392.000	53.56	-8.63	44.93	74.00	-29.07	peak
4	2656.000	51.99	-7.83	44.16	74.00	-29.84	peak
5	3988.000	47.55	-3.72	43.83	74.00	-30.17	peak
6	5785.000	42.61	1.95	44.56	74.00	-29.44	peak

- Note: 1. Measurement = Reading Level + Correct Factor.
 2. If Peak Result complies with AV limit, AV Result is deemed to comply with AV limit.
 3. Peak: Peak detector.
 4. Filter losses were only considered in the spurious frequency bands and the authorized band was not corrected for Band reject filter losses.
 5. Proper operation of the transmitter prior to adding the filter to the measurement chain.
 6. Owing to the highest peak level of unwanted emission out of the restricted bands complies with the lowest limit(54dBuV/m), so all the test point was deemed to comply with the limits list in the standard.



HORIZONTAL RESULTS
7-18GHz

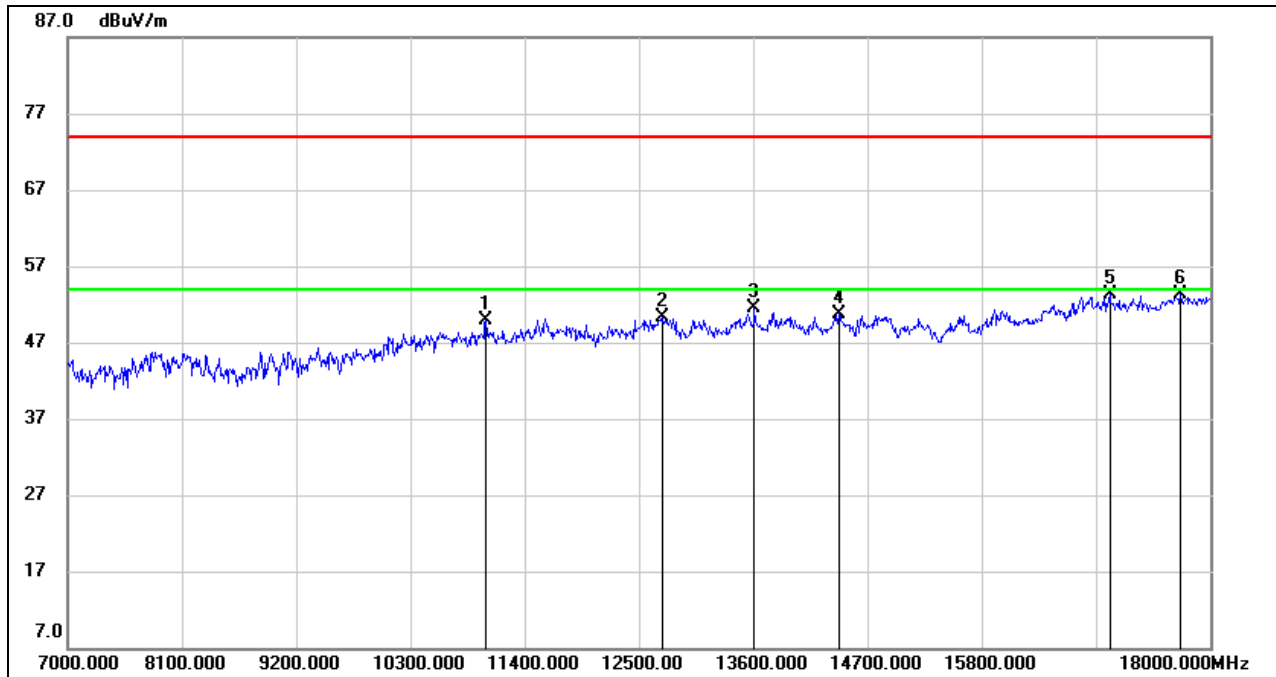

No.	Frequency (MHz)	Reading (dBuV)	Correct (dB/m)	Result (dBuV/m)	Limit (dBuV/m)	Margin (dB)	Remark
1	11026.000	37.30	12.63	49.93	74.00	-24.07	peak
2	12720.000	35.49	14.79	50.28	74.00	-23.72	peak
3	13611.000	35.36	16.10	51.46	74.00	-22.54	peak
4	14425.000	34.15	16.65	50.80	74.00	-23.20	peak
5	17032.000	32.54	20.72	53.26	74.00	-20.74	peak
6	17714.000	30.71	22.62	53.33	74.00	-20.67	peak

Note: 1. Measurement = Reading Level + Correct Factor.
 2. If Peak Result complies with AV limit, AV Result is deemed to comply with AV limit.
 3. Peak: Peak detector.
 4. Filter losses were only considered in the spurious frequency bands and the authorized band was not corrected for HPF losses.
 5. Proper operation of the transmitter prior to adding the filter to the measurement chain.
 6. Owing to the highest peak level of unwanted emission out of the restricted bands complies with the lowest limit(54dBuV/m), so all the test point was deemed to comply with the limits list in the standard.



VERTICAL RESULTS
1-7GHz

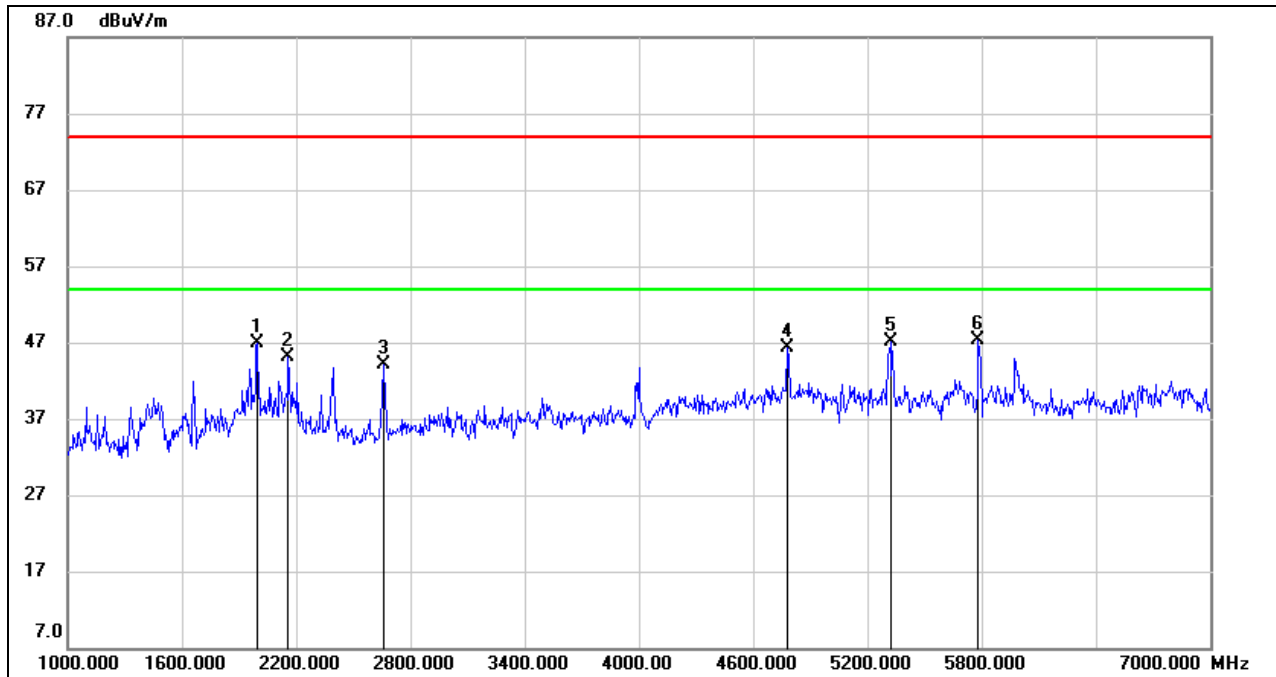

No.	Frequency (MHz)	Reading (dBuV)	Correct (dB/m)	Result (dBuV/m)	Limit (dBuV/m)	Margin (dB)	Remark
1	1996.000	57.15	-10.24	46.91	74.00	-27.09	peak
2	2158.000	54.47	-9.41	45.06	74.00	-28.94	peak
3	2656.000	51.88	-7.83	44.05	74.00	-29.95	peak
4	4780.000	45.98	0.41	46.39	74.00	-27.61	peak
5	5320.000	45.43	1.70	47.13	74.00	-26.87	peak
6	5785.000	45.32	1.95	47.27	74.00	-26.73	peak

Note: 1. Measurement = Reading Level + Correct Factor.
 2. If Peak Result complies with AV limit, AV Result is deemed to comply with AV limit.
 3. Peak: Peak detector.
 4. Filter losses were only considered in the spurious frequency bands and the authorized band was not corrected for Band reject filter losses.
 5. Proper operation of the transmitter prior to adding the filter to the measurement chain.
 6. Owing to the highest peak level of unwanted emission out of the restricted bands complies with the lowest limit(54dBuV/m), so all the test point was deemed to comply with the limits list in the standard.



VERTICAL RESULTS
7-18GHz

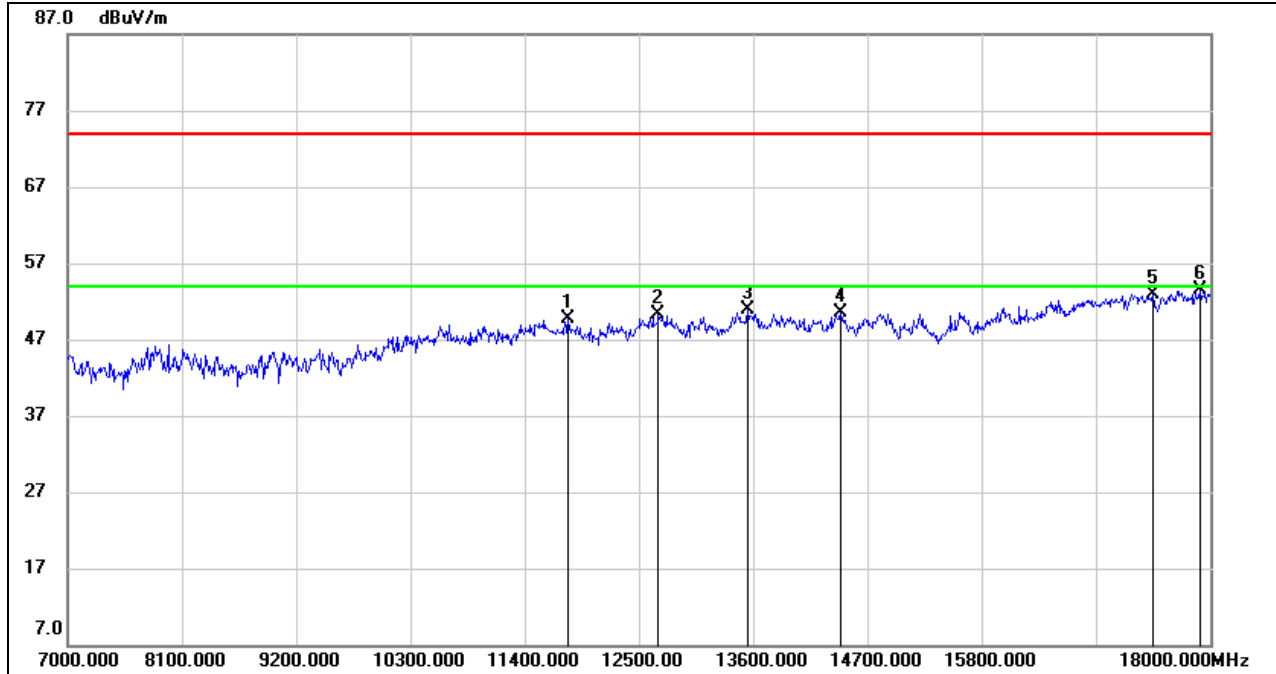

No.	Frequency (MHz)	Reading (dBuV)	Correct (dB/m)	Result (dBuV/m)	Limit (dBuV/m)	Margin (dB)	Remark
1	11818.000	36.38	13.29	49.67	74.00	-24.33	peak
2	12687.000	35.99	14.40	50.39	74.00	-23.61	peak
3	13545.000	34.92	15.98	50.90	74.00	-23.10	peak
4	14447.000	33.96	16.63	50.59	74.00	-23.41	peak
5	17450.000	31.34	21.49	52.83	74.00	-21.17	peak
6	17901.000	30.08	23.40	53.48	74.00	-20.52	peak

Note: 1. Measurement = Reading Level + Correct Factor.
 2. If Peak Result complies with AV limit, AV Result is deemed to comply with AV limit.
 3. Peak: Peak detector.
 4. Filter losses were only considered in the spurious frequency bands and the authorized band was not corrected for HPF losses.
 5. Proper operation of the transmitter prior to adding the filter to the measurement chain.
 6. Owing to the highest peak level of unwanted emission out of the restricted bands complies with the lowest limit(54dBuV/m), so all the test point was deemed to comply with the limits list in the standard.



HARMONICS AND SPURIOUS EMISSIONS HIGH CHANNEL

HORIZONTAL RESULTS
1-7GHz

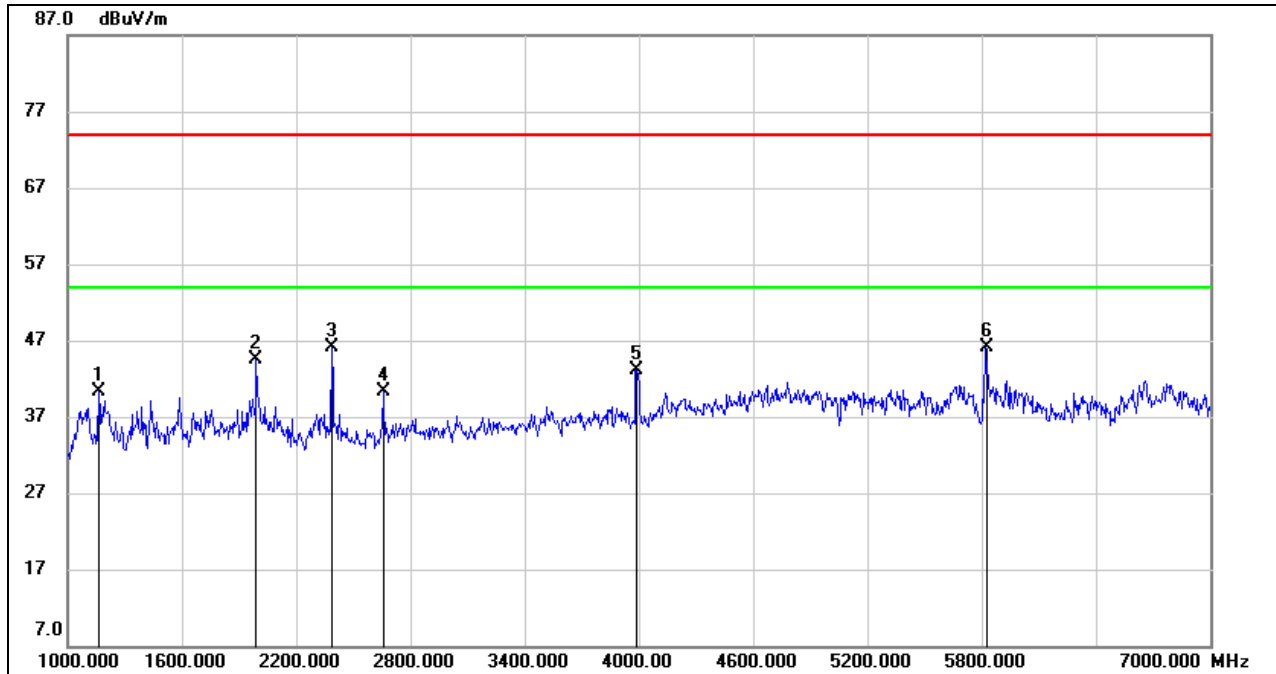

No.	Frequency (MHz)	Reading (dBuV)	Correct (dB/m)	Result (dBuV/m)	Limit (dBuV/m)	Margin (dB)	Remark
1	1162.000	53.63	-13.26	40.37	74.00	-33.63	peak
2	1990.000	54.79	-10.24	44.55	74.00	-29.45	peak
3	2386.000	54.69	-8.67	46.02	74.00	-27.98	peak
4	2656.000	48.21	-7.83	40.38	74.00	-33.62	peak
5	3988.000	46.88	-3.72	43.16	74.00	-30.84	peak
6	5825.000	44.02	2.03	46.05	74.00	-27.95	peak

Note: 1. Measurement = Reading Level + Correct Factor.
 2. If Peak Result complies with AV limit, AV Result is deemed to comply with AV limit.
 3. Peak: Peak detector.
 4. Filter losses were only considered in the spurious frequency bands and the authorized band was not corrected for Band reject filter losses.
 5. Proper operation of the transmitter prior to adding the filter to the measurement chain.
 6. Owing to the highest peak level of unwanted emission out of the restricted bands complies with the lowest limit(54dBuV/m), so all the test point was deemed to comply with the limits list in the standard.



HORIZONTAL RESULTS
7-18GHz

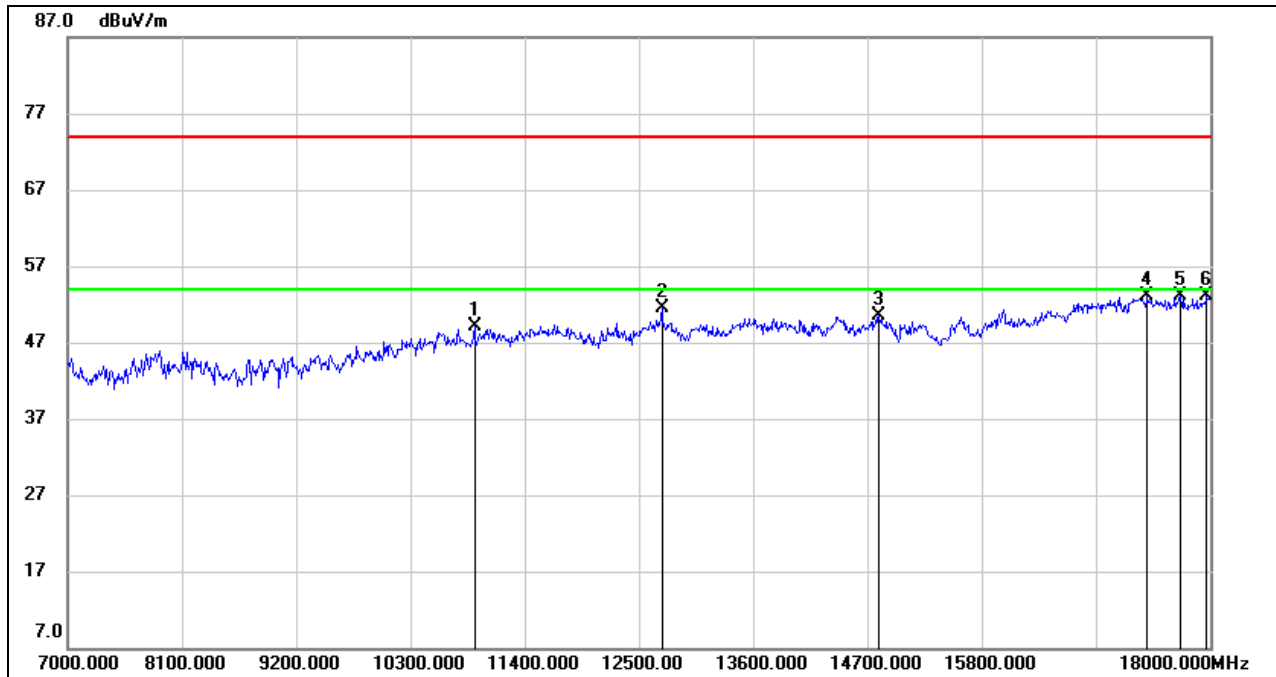

No.	Frequency (MHz)	Reading (dBuV)	Correct (dB/m)	Result (dBuV/m)	Limit (dBuV/m)	Margin (dB)	Remark
1	10916.000	37.16	11.96	49.12	74.00	-24.88	peak
2	12720.000	36.70	14.79	51.49	74.00	-22.51	peak
3	14810.000	34.41	16.07	50.48	74.00	-23.52	peak
4	17395.000	31.57	21.55	53.12	74.00	-20.88	peak
5	17714.000	30.52	22.62	53.14	74.00	-20.86	peak
6	17967.000	29.67	23.49	53.16	74.00	-20.84	peak

Note: 1. Measurement = Reading Level + Correct Factor.
 2. If Peak Result complies with AV limit, AV Result is deemed to comply with AV limit.
 3. Peak: Peak detector.
 4. Filter losses were only considered in the spurious frequency bands and the authorized band was not corrected for HPF losses.
 5. Proper operation of the transmitter prior to adding the filter to the measurement chain.
 6. Owing to the highest peak level of unwanted emission out of the restricted bands complies with the lowest limit(54dBuV/m), so all the test point was deemed to comply with the limits list in the standard.