



TEST REPORT

No.B19N02118-SAR

For

Yulong Computer Telecommunication Scientific (Shenzhen) Co., Ltd

Smartphone

Model Name: cp3648AT

With

Hardware Version: P1

Software Version: 9.0.036.P1.190916.cp3648AT

FCC ID: R38YLCP3648A

Issued Date: 2019-10-08

Designation Number: CN1210

Note:

The test results in this test report relate only to the devices specified in this report. This report shall not be reproduced except in full without the written approval of SAICT.

Test Laboratory:

Shenzhen Academy of Information and Communications Technology

Building G, Shenzhen International Innovation Center, No.1006 Shennan Road, Futian District, Shenzhen, Guangdong, P. R. China 518026.

Tel: +86(0)755-33322000, Fax: +86(0)755-33322001

Email: yewu@caict.ac.cn, website: www.cszit.com

REPORT HISTORY

Report Number	Revision	Issue Date	Description
B19N02118-SAR	Rev.0	2019-10-08	Initial creation of test report

TABLE OF CONTENT

1 TEST LABORATORY	5
1.1 TESTING LOCATION	5
1.2 TESTING ENVIRONMENT	5
1.3 PROJECT DATA	5
1.4 SIGNATURE	5
2 STATEMENT OF COMPLIANCE	6
3 CLIENT INFORMATION	10
3.1 APPLICANT INFORMATION.....	10
3.2 MANUFACTURER INFORMATION	10
4 EQUIPMENT UNDER TEST (EUT) AND ANCILLARY EQUIPMENT (AE)	11
4.1 ABOUT EUT	11
4.2 INTERNAL IDENTIFICATION OF EUT USED DURING THE TEST	12
4.3 INTERNAL IDENTIFICATION OF AE USED DURING THE TEST	12
5 TEST METHODOLOGY	13
5.1 APPLICABLE LIMIT REGULATIONS.....	13
5.2 APPLICABLE MEASUREMENT STANDARDS	13
6 SPECIFIC ABSORPTION RATE (SAR).....	14
6.1 INTRODUCTION.....	14
6.2 SAR DEFINITION.....	14
7 TISSUE SIMULATING LIQUIDS	15
7.1 TARGETS FOR TISSUE SIMULATING LIQUID	15
7.2 DIELECTRIC PERFORMANCE	15
8 SYSTEM VERIFICATION	19
8.1 SYSTEM SETUP.....	19
8.2 SYSTEM VERIFICATION	20
9 MEASUREMENT PROCEDURES	21
9.1 TESTS TO BE PERFORMED.....	21
9.2 GENERAL MEASUREMENT PROCEDURE	23
9.3 WCDMA MEASUREMENT PROCEDURES FOR SAR	24
9.4 BLUETOOTH & WI-FI MEASUREMENT PROCEDURES FOR SAR	25
9.5 SAR MEASUREMENT FOR LTE.....	25
9.6 LTE (TDD) CONSIDERATIONS.....	26
9.7 POWER DRIFT.....	27
10 AREA SCAN BASED 1-G SAR.....	28
10.1 REQUIREMENT OF KDB	28
10.2 FAST SAR ALGORITHMS.....	28
11 CONDUCTED OUTPUT POWER.....	29
11.1 GSM MEASUREMENT RESULT	29
11.3 CDMA MEASUREMENT RESULT	31
11.3 WCDMA MEASUREMENT RESULT	33
11.4 LTE MEASUREMENT RESULT	36
11.5 WI-FI AND BT MEASUREMENT RESULT	137

12 SIMULTANEOUS TX SAR CONSIDERATIONS.....	138
12.1 INTRODUCTION.....	138
12.2 TRANSMIT ANTENNA SEPARATION DISTANCES.....	138
12.3 SAR MEASUREMENT POSITIONS.....	139
12.4 STANDALONE SAR TEST EXCLUSION CONSIDERATIONS.....	139
13 EVALUATION OF SIMULTANEOUS.....	140
14 SUMMARY OF TEST RESULTS.....	141
14.1 SAR RESULTS.....	141
14.2 WLAN EVALUATION FOR 2.4G.....	163
15 SAR MEASUREMENT VARIABILITY.....	165
16 MEASUREMENT UNCERTAINTY.....	167
16.1 MEASUREMENT UNCERTAINTY FOR NORMAL SAR TESTS (300MHZ~3GHZ).....	167
16.2 MEASUREMENT UNCERTAINTY FOR FAST SAR TESTS (300MHZ~3GHZ).....	168
17 MAIN TEST INSTRUMENTS.....	169
ANNEX A GRAPH RESULTS.....	170
ANNEX B SYSTEMVERIFICATION RESULTS.....	208
ANNEX C SAR MEASUREMENT SETUP.....	217
C.1 MEASUREMENT SET-UP.....	217
C.2 DASY5 E-FIELD PROBE SYSTEM.....	218
C.3 E-FIELD PROBE CALIBRATION.....	218
C.4 OTHER TEST EQUIPMENT.....	219
ANNEX D POSITION OF THE WIRELESS DEVICE IN RELATION TO THE PHANTOM.....	223
D.1 GENERAL CONSIDERATIONS.....	223
D.2 BODY-WORN DEVICE.....	224
D.3 DESKTOP DEVICE.....	224
D.4 DUT SETUP PHOTOS.....	225
ANNEX E EQUIVALENT MEDIA RECIPES.....	226
ANNEX F SYSTEM VALIDATION.....	227
ANNEX G LTE BAND 41 POWER CLASS 2 AND POWER CLASS 3 LINEARITY.....	228
ANNEX H DAE CALIBRATION CERTIFICATE.....	230
ANNEX I PROBE CALIBRATION CERTIFICATE.....	233
ANNEX J DIPOLE CALIBRATION CERTIFICATE.....	244
ANNEX K EXTENDED CALIBRATION SAR DIPOLE.....	308
ANNEX L SPOT CHECK TEST.....	309
L.1 INTERNAL IDENTIFICATION OF EUT USED DURING THE SPOT CHECK TEST.....	309
L.2 MEASUREMENT RESULTS.....	309
L.3 GRAPH RESULTS FOR SPOT CHECK.....	313
ANNEX M SYSTEMVERIFICATION RESULTS.....	351

1 Test Laboratory

1.1 Testing Location

Company Name:	Shenzhen Academy of Information and Communications Technology
Address:	Building G, Shenzhen International Innovation Center, No.1006 Shennan Road, Futian District, Shenzhen, Guangdong, P. R. China
Postal Code:	518026
Telephone:	+86-755-33322000
Fax:	+86-755-33322001

1.2 Testing Environment

Temperature:	18°C~25 °C
Relative humidity:	30%~ 70%
Ground system resistance:	<4Ω
Ambient noise & Reflection:	< 0.012 W/kg

1.3 Project Data

Testing Start Date:	May 30, 2019
Testing End Date:	September 27, 2019

1.4 Signature



Li Yongfu

(Prepared this test report)



Zhang Yunzhan

(Reviewed this test report)

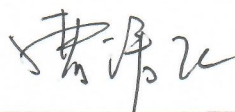

Cao Junfei

Deputy Director of the laboratory
(Approved this test report)

2 Statement of Compliance

This EUT is a variant product and the report of original sample is No.I19N00846-SAR. According to the client request, we quote the test results of original sample. The results of spot check are presented in annex L.

The maximum results of Specific Absorption Rate (SAR) found during testing for Yulong Computer Telecommunication Scientific (Shenzhen) Co., Ltd Smartphone cp3648AT are as follows:

Table 2.1: Highest Reported SAR for Head (1g)

Exposure Configuration	Technology Band	Highest Reported SAR 1g(W/Kg)	Equipment Class
Head	GSM850	0.46	PCE
	PCS1900	0.46	
	CDMA BC0	0.39	
	CDMA BC1	0.65	
	CDMA BC10	0.33	
	UMTS FDD 5	0.43	
	UMTS FDD 2	0.79	
	UMTS FDD 4	0.32	
	LTE Band 2	0.83	
	LTE Band 4	0.47	
	LTE Band 5	0.33	
	LTE Band 12	0.25	
	LTE Band 13	0.25	
	LTE Band 25	0.81	
	LTE Band 26	0.41	
	LTE Band 41	0.27	
	LTE Band 66	0.39	
	LTE Band 71	0.13	
	WLAN 2.4GHz	1.07	DTS

Table 2.2: Highest Reported SAR for Hotspot (1g)

Exposure Configuration	Technology Band	Highest Reported SAR 1g(W/Kg)	Equipment Class
Hotspot	GSM850	0.65	PCE
	PCS1900	1.00	
	CDMA BC0	0.32	
	CDMA BC1	0.57	
	CDMA BC10	0.29	
	UMTS FDD 5	0.36	
	UMTS FDD 2	1.11	
	UMTS FDD 4	0.54	
	LTE Band 2	0.79	
	LTE Band 4	0.58	
	LTE Band 5	0.36	
	LTE Band 12	0.28	
	LTE Band 13	0.25	
	LTE Band 25	0.80	
	LTE Band 26	0.38	
	LTE Band 41	0.14	
	LTE Band 66	0.73	
	LTE Band 71	0.13	DTS
WLAN 2.4GHz	0.25		

Table 2.3: Highest Reported SAR for Body-worn (1g)

Exposure Configuration	Technology Band	Highest Reported SAR 1g(W/Kg)	Equipment Class
Body-worn	GSM850	0.65	PCE
	PCS1900	1.39	
	CDMA BC0	0.32	
	CDMA BC1	1.07	
	CDMA BC10	0.29	
	UMTS FDD 5	0.36	
	UMTS FDD 2	1.38	
	UMTS FDD 4	0.76	
	LTE Band 2	1.13	
	LTE Band 4	0.61	
	LTE Band 5	0.36	
	LTE Band 12	0.28	
	LTE Band 13	0.25	
	LTE Band 25	1.28	
	LTE Band 26	0.38	
	LTE Band 41	0.31	
	LTE Band 66	0.72	
	LTE Band 71	0.05	
WLAN 2.4GHz	0.11	DTS	

The SAR values found for the Mobile Phone are below the maximum recommended levels of 1.6 W/Kg as averaged over any 1g tissue according to the ANSI C95.1-1992.

The EUT battery must be fully charged and checked periodically during the test to ascertain uniform power output.

The measurement together with the test system set-up is described in annex C of this test report. A detailed description of the equipment under test can be found in chapter 4 of this test report.

The highest reported SAR value is obtained at the case of **(Table 2.1 & 2.2 & 2.3)**, and the value is: **1.39W/kg (1g)**.

Table 2.4: The sum of reported SAR values for main antenna and Wi-Fi

<i>/</i>	Position	Main antenna	Wi-Fi	Sum
Highest reported SAR value for Head	Left Touch	0.50	1.07	1.57
Highest reported SAR value for Hotspot	Front	0.97	0.17	1.14
Highest reported SAR value for Body-worn	Front	1.39	0.09	1.48

Table2.5: The sum of reported SAR values for main antenna and BT

<i>/</i>	Position	Main antenna	BT*	Sum
Highest reported SAR value for Head	Right Touch	0.83	0.13	0.96
Highest reported SAR value for Hotspot	Bottom	1.11	0.07	1.18
Highest reported SAR value for Body-worn	Front	1.39	0.04	1.43

BT*-Estimated SAR for Bluetooth (see the table 13.3)

According to the above tables, the highest sum of reported SAR value is **1.57W/kg (1g)**. The detail for simultaneous transmission consideration is described in chapter 13.

3 Client Information

3.1 Applicant Information

Company Name:	Yulong Computer Telecommunication Scientific (Shenzhen) Co., Ltd
Address /Post:	Building B, Boton Science Park, Chaguang Road, Xili Town, Nanshan District, Shenzhen
Contact:	Emily zhang
Email:	zhangxuzhu@yulong.com
Telephone:	+86 15089742056
Fax:	/

3.2 Manufacturer Information

Company Name:	Yulong Computer Telecommunication Scientific (Shenzhen) Co., Ltd
Address /Post:	Building B, Boton Science Park, Chaguang Road, Xili Town, Nanshan District, Shenzhen
Contact:	Emily zhang
Email:	zhangxuzhu@yulong.com
Telephone:	+86 15089742056
Fax:	/

4 Equipment under Test (EUT) and Ancillary Equipment (AE)

4.1 About EUT

Description:	Smartphone
Model Name:	cp3648AT
Frequency Bands:	GSM 850/1900, CDMA BC0/ BC1/ BC10, WCDMA 850/1700/1900, BT, Wi-Fi 2.4G LTE Band 2/4/5/12/13/25/26/41/66/71
Condition of EUT as received	No obvious damage in appearance
Tested Tx Frequency:	825 – 848.8MHz (GSM 850)
	1850.2 – 1910MHz (GSM 1900)
	824.7 – 848.31MHz (CDMA BC0)
	1851.25 – 1908.75MHz (CDMA BC1)
	817.9 – 823.1MHz (CDMA BC10)
	826.4 – 846.6MHz (WCDMA850 Band V)
	1712.4 – 1752.6MHz (WCDMA1700 Band IV)
	1852.4 – 1907.6MHz (WCDMA1900 Band II)
	1850.7 – 1909.3MHz (LTE Band 2)
	1710.7 – 1754.3MHz (LTE Band 4)
	824.7 – 848.3MHz (LTE Band 5)
	699.7 – 715.3MHz (LTE Band 12)
	779.5 – 784.5MHz (LTE Band 13)
	1850.7 – 1914.3MHz (LTE Band 25)
	814.7 – 848.3MHz (LTE Band 26)
2498.5 – 2687.5MHz (LTE Band 41)	
1710.7 – 1779.3MHz (LTE Band 66)	
665.5 – 695.5MHz (LTE Band 71)	
2412 – 2462MHz (Wi-Fi 2.4G)	
GPRS / EGPRS Multislot Class:	33
GPRS capability Class:	B
Test device Production information:	Production unit
Device type:	Portable device
Antenna type:	Integrated antenna
Hotspot mode:	Support

4.2 Internal Identification of EUT used during the test

EUT ID*	IMEI	HW Version	SW Version
EUT1	990013500007310	P1	9.0.002.P1.190609.cp3648A
EUT2	990013500006981	P1	9.0.002.P1.190609.cp3648A
EUT3	990013500006882	P1	9.0.002.P1.190609.cp3648A
EUT4	990015580000321	P1	9.0.036.P1.190916.cp3648AT

*EUT ID: is used to identify the test sample in the lab internally.

Note: It is performed to test SAR with the EUT 1 & EUT 2 & EUT 4, and conducted power with the EUT 3.

4.3 Internal Identification of AE used during the test

AE ID*	Description	Type	Manufacturer
AE1	Battery	Li-ion Polymer	Tianjin Lishen
AE2	Battery	Li-ion Polymer	Zhuhai Coslight

*AE ID: is used to identify the test sample in the lab internally.

5 Test Methodology

5.1 Applicable Limit Regulations

ANSI C95.1–1992: IEEE Standard for Safety Levels with Respect to Human Exposure to Radio Frequency Electromagnetic Fields, 3 kHz to 300 GHz.

It specifies the maximum exposure limit of **1.6 W/kg** as averaged over any 1 gram of tissue for portable devices being used within 20 cm of the user in the uncontrolled environment.

5.2 Applicable Measurement Standards

IEEE 1528–2013: Recommended Practice for Determining the Peak Spatial-Average Specific Absorption Rate (SAR) in the Human Head from Wireless Communications Devices: Experimental Techniques.

KDB 447498 D01 General RF Exposure Guidance v06: Mobile and Portable Devices RF Exposure Procedures and Equipment Authorization Policies.

KDB 648474 D04 Handset SAR v01r03: SAR Evaluation Considerations for Wireless Handsets.

KDB 941225 D01 SAR test for 3G devices v03r01: SAR Measurement Procedures for 3G Devices

KDB 941225 D05 SAR for LTE Devices v02r05: SAR Evaluation Considerations for LTE Devices

KDB 941225 D06 Hot Spot SAR v02r01: SAR Evaluation Procedures for Portable Devices with Wireless Router Capabilities

KDB 248227 D01 802.11 Wi-Fi SAR v02r02: SAR Guidance for IEEE 802.11 (Wi-Fi) Transmitters.

KDB 865664 D01 SAR measurement 100 MHz to 6 GHz v01r04: SAR Measurement Requirements for 100 MHz to 6 GHz.

KDB 865664 D02 RF Exposure Reporting v01r02: RF Exposure Compliance Reporting and Documentation Considerations

KDB 941225 D05A LTE Rel.10 KDB Inquiry Sheet v01r02: REL. 10 LTE SAR TEST GUIDANCE AND KDB INQUIRIES

TCB workshop November 2017; RF Exposure Procedures (LTE UL/DL Carrier Aggregation SAR)

TCB workshop May 2017; RF Exposure Procedures (LTE Band 41 Power Class 2)

TCB workshop April 2019; RF Exposure Procedures (Tissue Simulating Liquids)

6 Specific Absorption Rate (SAR)

6.1 Introduction

SAR is related to the rate at which energy is absorbed per unit mass in an object exposed to a radio field. The SAR distribution in a biological body is complicated and is usually carried out by experimental techniques or numerical modeling. The standard recommends limits for two tiers of groups, occupational/controlled and general population/uncontrolled, based on a person's awareness and ability to exercise control over his or her exposure. In general, occupational/controlled exposure limits are higher than the limits for general population/uncontrolled.

6.2 SAR Definition

The SAR definition is the time derivative (rate) of the incremental energy (dW) absorbed by (dissipated in) an incremental mass (dm) contained in a volume element (dv) of a given density (ρ). The equation description is as below:

$$SAR = \frac{d}{dt} \left(\frac{dW}{dm} \right) = \frac{d}{dt} \left(\frac{dW}{\rho dv} \right)$$

SAR is expressed in units of Watts per kilogram (W/kg)

SAR measurement can be either related to the temperature elevation in tissue by

$$SAR = c \left(\frac{\delta T}{\delta t} \right)$$

Where: C is the specific heat capacity, δT is the temperature rise and δt is the exposure duration, or related to the electrical field in the tissue by

$$SAR = \frac{\sigma |E|^2}{\rho}$$

Where: σ is the conductivity of the tissue, ρ is the mass density of tissue and E is the RMS electrical field strength.

However for evaluating SAR of low power transmitter, electrical field measurement is typically applied.

7 Tissue Simulating Liquids

7.1 Targets for tissue simulating liquid

Table 7.1: Targets for tissue simulating liquid

Frequency (MHz)	Liquid Type	Conductivity (σ)	$\pm 5\%$ Range	Permittivity (ϵ)	$\pm 5\%$ Range
750	Head	0.89	0.85~0.93	41.94	39.8~44.0
835	Head	0.90	0.86~0.95	41.50	39.4~43.6
1750	Head	1.37	1.30~1.44	40.08	38.1~42.1
1900	Head	1.40	1.33~1.47	40.00	38.0~42.0
2450	Head	1.80	1.71~1.89	39.20	37.2~41.2
2550	Head	1.91	1.81~2.01	39.07	37.1~41.0

7.2 Dielectric Performance

Table 7.2: Dielectric Performance of Tissue Simulating Liquid

Measurement Date (yyyy-mm-dd)	Type	Frequency	Conductivity σ (S/m)	Drift (%)	Permittivity ϵ	Drift (%)
2019-6-2	Head	750	0.916	2.92	41.16	-1.86
2019-5-30	Head	835	0.915	1.67	40.44	-2.55
2019-5-31	Head	835	0.923	2.56	40.26	-2.99
2019-6-4	Head	1750	1.361	-0.66	40.33	0.62
2019-6-19	Head	1900	1.384	-1.14	40.45	1.13
2019-6-20	Head	1900	1.395	-0.36	40.27	0.68
2019-6-17	Head	2450	1.823	1.28	38.14	-2.70
2019-6-7	Head	2550	1.951	2.15	38.36	-1.82
2019-9-24	Head	750	0.903	1.46	41.45	-1.17
2019-9-24	Head	835	0.922	2.44	40.86	-1.54
2019-9-26	Head	1750	1.381	0.80	39.13	-2.37
2019-9-26	Head	1900	1.418	1.29	38.72	-3.20
2019-9-27	Head	2450	1.841	2.28	38.48	-1.84
2019-9-27	Head	2550	1.936	1.36	38.12	-2.43

Note: The liquid temperature is 22.0°C.

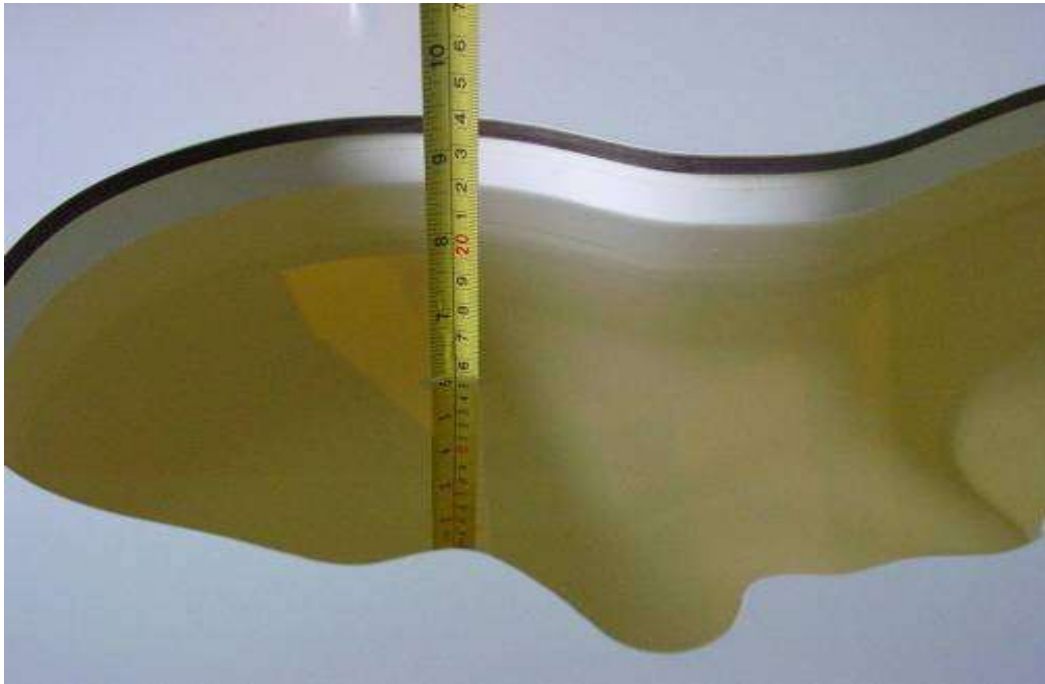

Picture 7-1: Liquid depth in the Head Phantom (750 MHz)



Picture 7-2: Liquid depth in the Head Phantom (835 MHz)



Picture 7-3: Liquid depth in the Head Phantom (1750 MHz)



Picture 7-4: Liquid depth in the Head Phantom (1900 MHz)



Picture 7-5: Liquid depth in the Head Phantom(2450MHz)



Picture 7-6: Liquid depth in the Head Phantom(2550MHz)

8 System verification

8.1 System Setup

In the simplified setup for system evaluation, the DUT is replaced by a calibrated dipole and the power source is replaced by a continuous wave that comes from a signal generator. The calibrated dipole must be placed beneath the flat phantom section of the SAM twin phantom with the correct distance holder. The distance holder should touch the phantom surface with a light pressure at the reference marking and be oriented parallel to the long side of the phantom. The equipment setup is shown below:

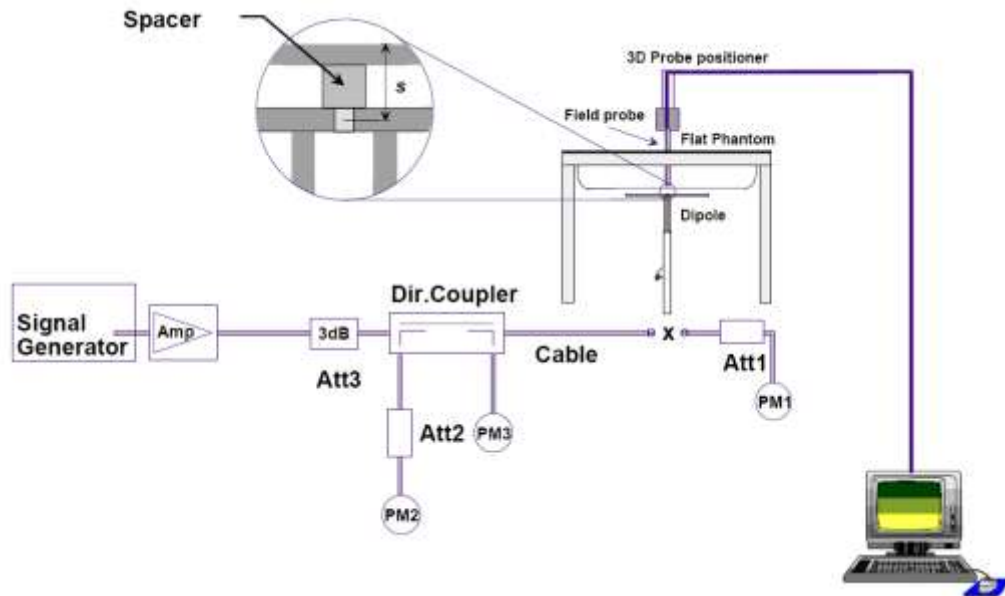

Picture 8.1 System Setup for System Evaluation



Picture 8.2 Photo of Dipole Setup

8.2 System Verification

SAR system verification is required to confirm measurement accuracy, according to the tissue dielectric media, probe calibration points and other system operating parameters required for measuring the SAR of a test device. The system verification must be performed for each frequency band and within the valid range of each probe calibration point required for testing the device.

The system verification results are required that the area scan estimated 1-g SAR is within 3% of the zoom scan 1-g SAR. The details are presented in annex B.

Table 8.1: System Verification of Head

Measurement Date (yyyy-mm-dd)	Frequency	Target value (W/kg)		Measured value (W/kg)		Deviation (%)	
		10 g Average	1 g Average	10 g Average	1 g Average	10 g Average	1 g Average
2019-6-2	750 MHz	5.43	8.26	5.60	8.60	3.13	4.12
2019-5-30	835 MHz	6.29	9.62	6.36	9.88	1.11	2.70
2019-5-31	835 MHz	6.29	9.62	6.44	9.96	2.38	3.53
2019-6-4	1750 MHz	19.4	36.6	19.20	35.40	-1.03	-3.28
2019-6-19	1900 MHz	21.0	40.5	20.52	39.08	-2.29	-3.51
2019-6-20	1900 MHz	21.0	40.5	20.64	39.32	-1.71	-2.91
2019-6-17	2450 MHz	24.1	52.0	24.32	52.80	0.91	1.54
2019-6-7	2550 MHz	26.5	57.8	26.88	59.60	1.43	3.11
2019-9-24	750 MHz	5.70	8.53	5.56	8.12	-2.46	-4.81
2019-9-24	835 MHz	6.29	9.62	6.44	10.00	2.38	3.95
2019-9-26	1750 MHz	19.3	36.4	19.00	35.16	-1.55	-3.41
2019-9-26	1900 MHz	21.0	40.5	21.40	42.00	1.90	3.70
2019-9-27	2450 MHz	24.1	52.0	24.76	54.40	2.74	4.62
2019-9-27	2550 MHz	26.5	57.8	27.12	60.40	2.34	4.50

9 Measurement Procedures

9.1 Tests to be performed

In order to determine the highest value of the peak spatial-average SAR of a handset, all device positions, configurations and operational modes shall be tested for each frequency band according to steps 1 to 3 below. A flowchart of the test process is shown in picture 9.1.

Step 1: The tests described in 9.2 shall be performed at the channel that is closest to the center of the transmit frequency band (f_c) for:

- a) all device positions (cheek and tilt, for both left and right sides of the SAM phantom, as described in annex D),
- b) all configurations for each device position in a), e.g., antenna extended and retracted, and
- c) all operational modes, e.g., analogue and digital, for each device position in a) and configuration in b) in each frequency band.

If more than three frequencies need to be tested according to 11.1 (i.e., $N_c > 3$), then all frequencies, configurations and modes shall be tested for all of the above test conditions.

Step 2: For the condition providing highest peak spatial-average SAR determined in Step 1, perform all tests described in 9.2 at all other test frequencies, i.e., lowest and highest frequencies. In addition, for all other conditions (device position, configuration and operational mode) where the peak spatial-average SAR value determined in Step 1 is within 3 dB of the applicable SAR limit, it is recommended that all other test frequencies shall be tested as well.

Step 3: Examine all data to determine the highest value of the peak spatial-average SAR found in Steps 1 to 2.

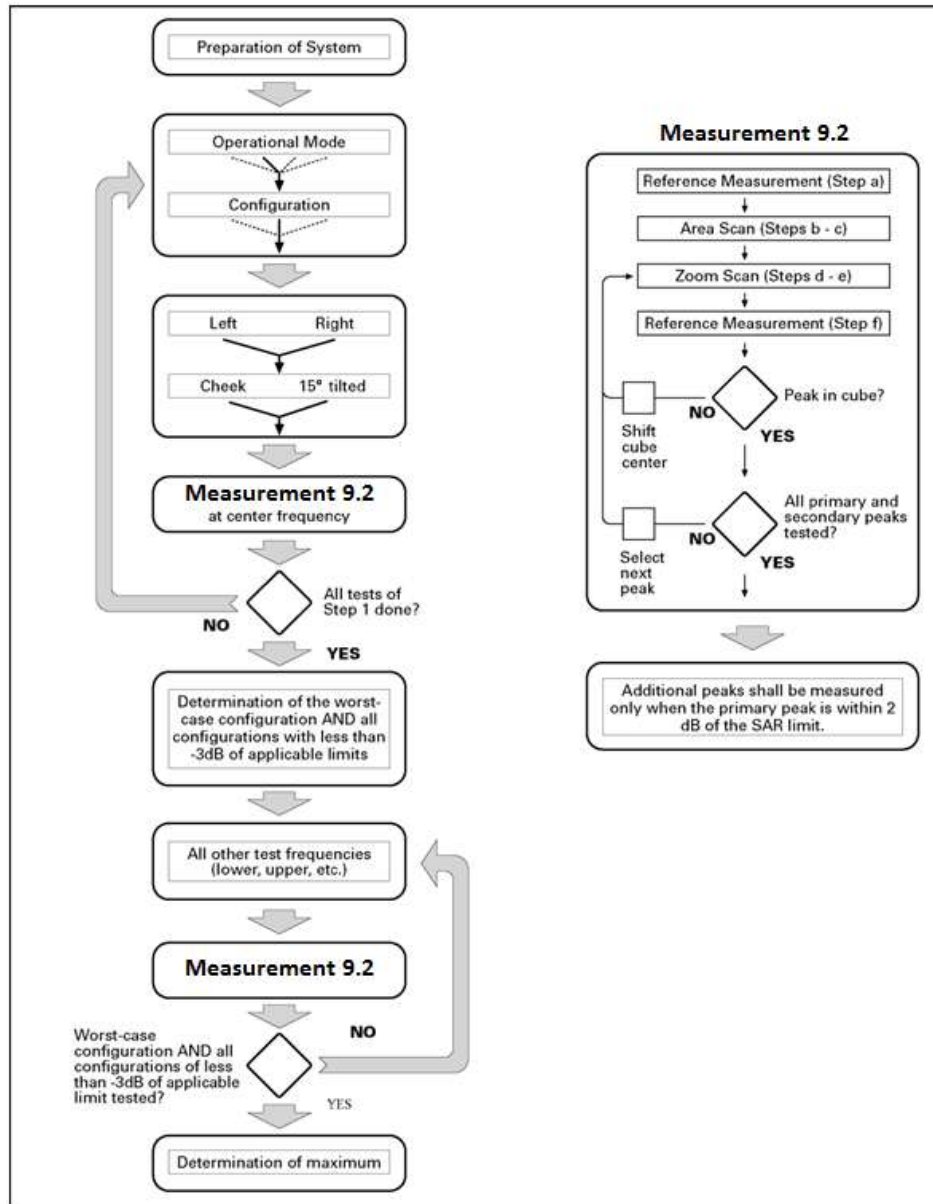

Picture 9.1 Block diagram of the tests to be performed

9.2 General Measurement Procedure

The area and zoom scan resolutions specified in the table below must be applied to the SAR measurements and fully documented in SAR reports to qualify for TCB approval. Probe boundary effect error compensation is required for measurements with the probe tip closer than half a probe tip diameter to the phantom surface. Both the probe tip diameter and sensor offset distance must satisfy measurement protocols; to ensure probe boundary effect errors are minimized and the higher fields closest to the phantom surface can be correctly measured and extrapolated to the phantom surface for computing 1-g SAR. Tolerances of the post-processing algorithms must be verified by the test laboratory for the scan resolutions used in the SAR measurements, according to the reference distribution functions specified in IEEE Std 1528-2013. The results should be documented as part of the system validation records and may be requested to support test results when all the measurement parameters in the following table are not satisfied.

		≤ 3 GHz	> 3 GHz	
Maximum distance from closest measurement point (geometric center of probe sensors) to phantom surface		5 ± 1 mm	$\frac{1}{2} \cdot \delta \cdot \ln(2) \pm 0.5$ mm	
Maximum probe angle from probe axis to phantom surface normal at the measurement location		$30^\circ \pm 1^\circ$	$20^\circ \pm 1^\circ$	
Maximum area scan spatial resolution: $\Delta x_{Area}, \Delta y_{Area}$		≤ 2 GHz: ≤ 15 mm 2 – 3 GHz: ≤ 12 mm	3 – 4 GHz: ≤ 12 mm 4 – 6 GHz: ≤ 10 mm	
		When the x or y dimension of the test device, in the measurement plane orientation, is smaller than the above, the measurement resolution must be \leq the corresponding x or y dimension of the test device with at least one measurement point on the test device.		
Maximum zoom scan spatial resolution: $\Delta x_{Zoom}, \Delta y_{Zoom}$		≤ 2 GHz: ≤ 8 mm 2 – 3 GHz: ≤ 5 mm*	3 – 4 GHz: ≤ 5 mm* 4 – 6 GHz: ≤ 4 mm*	
Maximum zoom scan spatial resolution, normal to phantom surface	uniform grid: $\Delta z_{Zoom}(n)$	≤ 5 mm	3 – 4 GHz: ≤ 4 mm 4 – 5 GHz: ≤ 3 mm 5 – 6 GHz: ≤ 2 mm	
	graded grid	$\Delta z_{Zoom}(1)$: between 1 st two points closest to phantom surface	≤ 4 mm	3 – 4 GHz: ≤ 3 mm 4 – 5 GHz: ≤ 2.5 mm 5 – 6 GHz: ≤ 2 mm
		$\Delta z_{Zoom}(n>1)$: between subsequent points	$\leq 1.5 \cdot \Delta z_{Zoom}(n-1)$	
Minimum zoom scan volume	x, y, z	≥ 30 mm	3 – 4 GHz: ≥ 28 mm 4 – 5 GHz: ≥ 25 mm 5 – 6 GHz: ≥ 22 mm	
<p>Note: δ is the penetration depth of a plane-wave at normal incidence to the tissue medium; see draft standard IEEE P1528-2011 for details.</p> <p>* When zoom scan is required and the <i>reported</i> SAR from the area scan based <i>1-g SAR estimation</i> procedures of KDB 447498 is ≤ 1.4 W/kg, ≤ 8 mm, ≤ 7 mm and ≤ 5 mm zoom scan resolution may be applied, respectively, for 2 GHz to 3 GHz, 3 GHz to 4 GHz and 4 GHz to 6 GHz.</p>				

9.3 WCDMA Measurement Procedures for SAR

The following procedures are applicable to WCDMA handsets operating under 3GPP Release99, Release 5 and Release 6. The default test configuration is to measure SAR with an established radio link between the DUT and a communication test set using a 12.2kbps RMC (reference measurement channel) configured in Test Loop Mode 1. SAR is selectively confirmed for other physical channel configurations (DPCCH & DPDCH_n), HSDPA and HSPA (HSUPA/HSDPA) modes according to output power, exposure conditions and device operating capabilities. Both uplink and downlink should be configured with the same RMC or AMR, when required. SAR for Release 5 HSDPA and Release 6 HSPA are measured using the applicable FRC (fixed reference channel) and E-DCH reference channel configurations. Maximum output power is verified according to applicable versions of 3GPP TS 34.121 and SAR must be measured according to these maximum output conditions. When Maximum Power Reduction (MPR) is not implemented according to Cubic Metric (CM) requirements for Release 6 HSPA, the following procedures do not apply.

For Release 5 HSDPA Data Devices:

Sub-test	β_c	β_d	β_d (SF)	β_c / β_d	β_{hs}	CM/dB
1	2/15	15/15	64	2/15	4/15	0.0
2	12/15	15/15	64	12/15	24/25	1.0
3	15/15	8/15	64	15/8	30/15	1.5
4	15/15	4/15	64	15/4	30/15	1.5

For Release 6 HSPA Data Devices

Sub-test	β_c	β_d	β_d (SF)	β_c / β_d	β_{hs}	β_{ec}	β_{ed}	β_{ed} (SF)	β_{ed} (codes)	CM (dB)	MPR (dB)	AG Index	E-TFCI
1	11/15	15/15	64	11/15	22/15	209/225	1039/225	4	1	1.0	0.0	20	75
2	6/15	15/15	64	6/15	12/15	12/15	12/15	4	1	3.0	2.0	12	67
3	15/15	9/15	64	15/9	30/15	30/15	$\beta_{ed1}:47/15$ $\beta_{ed2}:47/15$	4	2	2.0	1.0	15	92
4	2/15	15/15	64	2/15	4/15	4/15	56/75	4	1	3.0	2.0	17	71
5	15/15	15/15	64	15/15	24/15	30/15	134/15	4	1	1.0	0.0	21	81

9.4 Bluetooth & WI-FI Measurement Procedures for SAR

Normal network operating configurations are not suitable for measuring the SAR of 802.11 transmitters in general. Unpredictable fluctuations in network traffic and antenna diversity conditions can introduce undesirable variations in SAR results. The SAR for these devices should be measured using chipset based test mode software to ensure that the results are consistent and reliable.

Chipset based test mode software is hardware dependent and generally varies among manufacturers. The device operating parameters established in a test mode for SAR measurements must be identical to those programmed in production units, including output power levels, amplifier gain settings and other RF performance tuning parameters. The test frequencies should correspond to actual channel frequencies defined for domestic use. SAR for devices with switched diversity should be measured with only one antenna transmitting at a time during each SAR measurement, according to a fixed modulation and data rate. The same data pattern should be used for all measurements.

9.5 SAR Measurement for LTE

SAR tests for LTE are performed with a base station simulator, Anristu MT8820C. Closed loop power control was used so the UE transmits with maximum output power during SAR testing. All powers were measured with the Anristu MT8820C. It is performed for conducted power and SAR based on the KDB941225 D05.

SAR is evaluated separately according to the following procedures for the different test positions in each exposure condition – head, body, body-worn accessories and other use conditions. The procedures in the following subsections are applied separately to test each LTE frequency band.

1) QPSK with 1 RB allocation

Start with the largest channel bandwidth and measure SAR for QPSK with 1 RB allocation, using the RB offset and required test channel combination with the highest maximum output power among RB offsets at the upper edge, middle and lower edge of each required test channel. When the reported SAR is ≤ 0.8 W/kg, testing of the remaining RB offset configurations and required test channels is not required for 1 RB allocation; otherwise, SAR is required for the remaining required test channels and only for the RB offset configuration with the highest output power for that channel. When the reported SAR of a required test channel is > 1.45 W/kg, SAR is required for all three RB offset configurations for that required test channel.

2) QPSK with 50% RB allocation

The procedures required for 1 RB allocation in 1) are applied to measure the SAR for QPSK with 50% RB allocation.

3) QPSK with 100% RB allocation

For QPSK with 100% RB allocation, SAR is not required when the highest maximum output power for 100 % RB allocation is less than the highest maximum output power in 50% and 1 RB allocations and the highest reported SAR for 1 RB and 50% RB allocation in 1) and 2) are ≤ 0.8 W/kg. Otherwise, SAR is measured for the highest output power channel; and if the reported SAR is > 1.45 W/kg, the remaining required test channels must also be tested.

9.6 LTE (TDD) Considerations

According to KDB 941225 D05 SAR for LTE Devices, for Time-Division Duplex (TDD) systems, SAR must be tested using a fixed periodic duty factor according to the highest transmission duty factor implemented for the device and supported by the defined 3GPP LTE TDD configurations.

SAR was tested with the highest transmission duty factor (63.33%) using Uplink-downlink configuration 0 and Special subframe configuration 7.

LTE TDD Band 41 support 3GPP TS 36.211 section 4.2 for Type 2 Frame Structure and Table 4.2-2 for uplink-downlink configurations and Table 4.2-1 for Special subframe configurations.

Special subframe configuration	Normal cyclic prefix in downlink			Extended cyclic prefix in downlink		
	DwPTS	UpPTS		DwPTS	UpPTS	
		Normal cyclic prefix in uplink	Extended cyclic prefix in uplink		Normal cyclic prefix in uplink	Extended cyclic prefix in uplink
0	$6592 \cdot T_s$	$2192 \cdot T_s$	$2560 \cdot T_s$	$7680 \cdot T_s$	$2192 \cdot T_s$	$2560 \cdot T_s$
1	$19760 \cdot T_s$			$20480 \cdot T_s$		
2	$21952 \cdot T_s$			$23040 \cdot T_s$		
3	$24144 \cdot T_s$			$25600 \cdot T_s$		
4	$26336 \cdot T_s$			$7680 \cdot T_s$		
5	$6592 \cdot T_s$	$4384 \cdot T_s$	$5120 \cdot T_s$	$20480 \cdot T_s$	$4384 \cdot T_s$	$5120 \cdot T_s$
6	$19760 \cdot T_s$			$23040 \cdot T_s$		
7	$21952 \cdot T_s$			$12800 \cdot T_s$		
8	$24144 \cdot T_s$			-		
9	$13168 \cdot T_s$			-		

Configuration of special subframe (lengths of DwPTS/GP/UpPTS)

Uplink-Downlink Configuration	Downlink-to-Uplink Switch-point Periodicity	Subframe Number										Calculated Duty Cycle (%)
		0	1	2	3	4	5	6	7	8	9	
0	5 ms	D	S	U	U	U	D	S	U	U	U	63.33
1	5 ms	D	S	U	U	D	D	S	U	U	D	43.33
2	5 ms	D	S	U	D	D	D	S	U	D	D	23.33
3	10 ms	D	S	U	U	U	D	D	D	D	D	31.67
4	10 ms	D	S	U	U	D	D	D	D	D	D	21.67
5	10 ms	D	S	U	D	D	D	D	D	D	D	11.67
6	5 ms	D	S	U	U	U	D	S	U	U	D	53.33

Calculated Duty Cycle

Calculated Duty Cycle = Extended cyclic prefix in uplink x (Ts) x # of S + # of U

Example for Calculated Duty Cycle for Uplink-Downlink Configuration 0:

Calculated Duty Cycle = $5120 \times [1/(15000 \times 2048)] \times 2 + 6 \text{ ms} = 63.33\%$

Where

$T_s = 1/(15000 \times 2048)$ seconds

Note:

1. From May 2017 TCB Workshop, HPUE does not support uplink-downlink configurations 0 and 6.
2. This device supports uplink-downlink configurations 0-6. The configuration with highest duty cycle was used for SAR Testing: configuration 0 at 63.3% (Power Class 3) and configuration 1 at 43.3% (Power Class 2) duty cycle.

9.7 Power Drift

To control the output power stability during the SAR test, DASY5 system calculates the power drift by measuring the E-field at the same location at the beginning and at the end of the measurement for each test position. These drift values can be found in Section 14 labeled as: (Power Drift [dB]). This ensures that the power drift during one measurement is within 5%.

10 Area Scan Based 1-g SAR

10.1 Requirement of KDB

According to the KDB447498 D01, when the implementation is based the specific polynomial fit algorithm as presented at the 29th Bioelectromagnetics Society meeting (2007) and the estimated 1-gSAR is ≤ 1.2 W/kg, a zoom scan measurement is not required provided it is also not needed for any other purpose; for example, if the peak SAR location required for simultaneous transmission SAR test exclusion can be determined accurately by the SAR system or manually to discriminate between distinctive peaks and scattered noisy SAR distributions from area scans.

There must not be any warning or alert messages due to various measurement concerns identified by the SAR system; for example, noise in measurements, peaks too close to scan boundary, peaks are too sharp, spatial resolution and uncertainty issues etc. The SAR system verification must also demonstrate that the area scan estimated 1-g SAR is within 3% of the zoom scan 1-g SAR (See Annex B). When all the SAR results for each exposure condition in a frequency band and wireless mode are based on estimated 1-g SAR, the 1-g SAR for the highest SAR configuration must be determined by a zoom scan.

10.2 Fast SAR Algorithms

The approach is based on the area scan measurement applying a frequency dependent attenuation parameter. This attenuation parameter was empirically determined by analyzing a large number of phones. The MOTOROLA FAST SAR was developed and validated by the MOTOROLA Research Group in Ft. Lauderdale.

In the initial study, an approximation algorithm based on Linear fit was developed. The accuracy of the algorithm has been demonstrated across a broad frequency range (136-2450 MHz) and for both 1- and 10-g averaged SAR using a sample of 264 SAR measurements from 55 wireless handsets. For the sample size studied, the root-mean-squared errors of the algorithm are 1.2% and 5.8% for 1- and 10-g averaged SAR, respectively. The paper describing the algorithm in detail is expected to be published in August 2004 within the Special Issue of Transactions on MTT.

In the second step, the same research group optimized the fitting algorithm to an Polynomial fit whereby the frequency validity was extended to cover the range 30-6000MHz. Details of this study can be found in the BEMS 2007 Proceedings.

Both algorithms are implemented in DASY software.

11 Conducted Output Power

11.1 GSM Measurement result

During the process of testing, the EUT was controlled via Agilent Digital Radio Communication tester (E5515C) to ensure the maximum power transmission and proper modulation. This result contains conducted output power for the EUT. In all cases, the measured peak output power should be greater and within 5% than EMI measurement.

Table 11.1: The conducted power measurement results for GSM

Full Power / Hotspot on				
GSM 850MHz	Tune up	Conducted Power (dBm)		
		Channel 251(848.8MHz)	Channel 190(836.6MHz)	Channel 128(824.2MHz)
	34.5	33.74	33.87	33.68
Full Power				
GSM 1900MHz	Tune up	Conducted Power(dBm)		
		Channel 810(1909.8MHz)	Channel 661(1880MHz)	Channel512(1850.2MHz)
	32	31.34	31.36	31.38
Hotspot on				
GSM 1900MHz	Tune up	Conducted Power(dBm)		
		Channel 810(1909.8MHz)	Channel 661(1880MHz)	Channel512(1850.2MHz)
	27	26.59	26.30	26.18

Table 11.2: The conducted power measurement results for GPRS and EGPRS

Full Power / Hotspot on								
GPRS850/ EGPRS850	Tune up	Measured Power (dBm)			calculation	Average Power (dBm)		
		251	190	128		251	190	128
1Tx-slots	34.5	33.72	33.86	33.67	-9.03dB	24.69	24.83	24.64
2Tx-slots	33.5	32.81	32.96	32.65	-6.02dB	26.79	26.94	26.63
3Tx-slots	31.5	30.55	30.72	30.38	-4.26dB	26.29	26.46	26.12
4Tx-slots	30.5	29.43	29.62	29.31	-3.01dB	26.42	26.61	26.30
EGPRS 850 (8PSK)	Tune up	Measured Power (dBm)			calculation	Measured Power (dBm)		
		251	190	128		251	190	128
1Tx-slots	27.5	26.66	26.68	26.90	-9.03dB	17.63	17.65	17.87
2Tx-slots	26.5	25.48	25.52	25.74	-6.02dB	19.46	19.50	19.72
3Tx-slots	24.5	23.32	23.28	23.61	-4.26dB	19.06	19.02	19.35
4Tx-slots	23.5	22.16	22.11	22.32	-3.01dB	19.15	19.10	19.31

Full Power								
GPRS1900/ EGPRS1900	Tune up	Measured Power (dBm)			calculation	Average Power (dBm)		
		810	661	512		810	661	512
1Tx-slots	32.0	31.32	31.33	31.36	-9.03dB	22.29	22.30	22.33
2Tx-slots	31.5	30.69	30.66	30.70	-6.02dB	24.67	24.64	24.68
3Tx-slots	29.5	28.96	28.96	28.90	-4.26dB	24.70	24.70	24.64
4Tx-slots	28.5	27.91	27.83	27.67	-3.01dB	24.90	24.82	24.66
EGPRS 1900 (8PSK)	Tune up	Measured Power (dBm)			calculation	Measured Power (dBm)		
		810	661	512		810	661	512
1Tx-slots	26.5	25.87	26.04	25.97	-9.03dB	16.84	17.01	16.94
2Tx-slots	25.5	24.77	24.86	24.75	-6.02dB	18.75	18.84	18.73
3Tx-slots	23.5	22.46	22.59	22.40	-4.26dB	18.20	18.33	18.14
4Tx-slots	22.5	21.27	21.46	21.17	-3.01dB	18.26	18.45	18.16
Hotspot on								
GPRS1900/ EGPRS1900	Tune up	Measured Power (dBm)			calculation	Average Power (dBm)		
		810	661	512		810	661	512
1Tx-slots	27	26.52	26.25	26.09	-9.03dB	17.49	17.22	17.06
2Tx-slots	26	25.49	25.20	25.03	-6.02dB	19.47	19.18	19.01
3Tx-slots	24	23.52	23.22	23.05	-4.26dB	19.26	18.96	18.79
4Tx-slots	23	22.63	22.29	22.15	-3.01dB	19.62	19.28	19.14
EGPRS 1900 (8PSK)	Tune up	Measured Power (dBm)			calculation	Measured Power (dBm)		
		810	661	512		810	661	512
1Tx-slots	22	21.16	21.22	21.07	-9.03dB	12.13	12.19	12.04
2Tx-slots	21	19.97	20.02	19.87	-6.02dB	13.95	14.00	13.85
3Tx-slots	19	17.88	17.91	17.81	-4.26dB	13.62	13.65	13.55
4Tx-slots	18	16.69	16.85	16.72	-3.01dB	13.68	13.84	13.71

NOTES:

1) Division Factors

To average the power, the division factor is as follows:

1TX-slot = 1 transmit time slot out of 8 time slots=> conducted power divided by (8/1) => -9.03dB

2TX-slots = 2 transmit time slots out of 8 time slots=> conducted power divided by (8/2) => -6.02dB

3TX-slots = 3 transmit time slots out of 8 time slots=> conducted power divided by (8/3) => -4.26dB

4TX-slots = 4 transmit time slots out of 8 time slots=> conducted power divided by (8/4) => -3.01dB

According to the conducted power as above, the body measurements are performed with 2Txslots for 850MHz and 4Txslots for 1900MHz.

11.3 CDMA Measurement result

Table 11.3: The conducted power measurement results for CDMA

Full Power / Hotspot on				
CDMA BC0	Tune up	Conducted Power (dBm)		
		Channel 777 (848.31MHz)	Channel 384 (836.52MHz)	Channel 1013 (824.7MHz)
SO55/RC3	24.5	23.66	23.63	23.52
SO55/RC1	24.5	23.62	23.60	23.51
SO32/RC3(FCH only)	24.5	23.63	23.62	23.51
SO32/RC3(FCH+SCHn)	24.5	23.62	23.59	23.48
EVDO Rev.0	24.5	23.60	23.58	23.44
EVDO Rev.A	24.5	23.61	23.57	23.45
CDMA BC10	Tune up	Conducted Power (dBm)		
		Channel 684 (823.1MHz)	Channel 580 (820.5MHz)	Channel 476 (817.9MHz)
SO55/RC3	24.5	23.53	23.57	23.53
SO55/RC1	24.5	23.50	23.55	23.51
SO32/RC3(FCH only)	24.5	23.52	23.55	23.51
SO32/RC3(FCH+SCHn)	24.5	23.52	23.53	23.48
EVDO Rev.0	24.5	23.48	23.52	23.44
EVDO Rev.A	24.5	23.46	23.51	23.45

Full Power				
CDMA BC1	Tune up	Conducted Power (dBm)		
		Channel 1175 (1908.75MHz)	Channel 600 (1880MHz)	Channel 25 (1851.25MHz)
SO55/RC3	24	23.41	23.42	23.15
SO55/RC1	24	23.38	23.40	23.12
SO32/RC3(FCH only)	24	23.42	23.47	23.14
SO32/RC3(FCH+SCHn)	24	23.39	23.45	23.12
EVDO Rev.0	24	23.41	23.43	23.10
EVDO Rev.A	24	23.41	23.42	23.11
Hotspot on				
CDMA BC1	Tune up	Conducted Power (dBm)		
		Channel 1175 (1908.75MHz)	Channel 600 (1880MHz)	Channel 25 (1851.25MHz)
SO55/RC3	19	18.48	18.37	17.89
SO55/RC1	19	18.44	18.34	17.88
SO32/RC3(FCH only)	19	18.44	18.32	17.79
SO32/RC3(FCH+SCHn)	19	18.42	18.29	17.77
EVDO Rev.0	19	18.40	18.27	17.78
EVDO Rev.A	19	18.41	18.29	17.76

11.3 WCDMA Measurement result

Table 11.4: T The conducted power measurement results WCDMA

Full Power / Hotspot on					
Item	band	FDD Band 5 result			
	ARFCN	Tune up	4233 (846.6MHz)	4182 (836.4MHz)	4132 (826.4MHz)
WCDMA	\	24.5	23.3	23.4	23.3
HSUPA	1	22.0	20.8	20.9	20.9
	2	21.5	20.3	20.4	20.4
	3	22.5	21.3	21.4	21.3
	4	21.0	19.8	19.9	19.9
	5	22.5	21.2	21.4	21.4
HSDPA	1	23.5	22.3	22.4	22.4
	2	23.5	22.3	22.4	22.3
	3	23.0	21.8	21.8	21.9
	4	23.0	21.8	21.9	21.8
DC-HSDPA	1	23.5	22.2	22.2	22.2
	2	23.5	22.3	22.1	22.2
	3	23.0	21.7	21.8	21.7
	4	23.0	21.7	21.7	21.8

Full Power					
Item	band	FDD Band 2 result			
	ARFCN	Tune up	9538 (1907.6MHz)	9400 (1880MHz)	9262 (1852.4MHz)
WCDMA	\	24.5	23.6	23.6	23.7
HSUPA	1	22.5	21.2	21.2	21.3
	2	22.0	20.7	20.7	20.8
	3	22.5	21.6	21.7	21.8
	4	21.0	20.2	20.2	20.3
	5	22.5	21.7	21.6	21.7
HSDPA	1	23.5	22.6	22.7	22.8
	2	23.5	22.5	22.6	22.7
	3	23.0	22.1	22.1	22.2
	4	23.0	22.1	22.1	22.2
DC-HSDPA	1	23.5	22.6	22.8	22.8
	2	23.5	22.6	22.5	22.6
	3	23.0	22.2	22.0	22.2
	4	23.0	22.3	22.2	22.1
Item	band	FDD Band 4 result			
	ARFCN	Tune up	1513 (1752.6MHz)	1413 (1732.6MHz)	1312 (1712.4MHz)
WCDMA	\	24.5	23.6	23.5	23.2
HSUPA	1	22.0	21.1	21.0	20.8
	2	21.5	20.6	20.5	20.3
	3	22.5	21.6	21.6	21.3
	4	21.0	20.1	20.0	19.8
	5	22.5	21.5	21.4	21.2
HSDPA	1	23.5	22.6	22.5	22.3
	2	23.5	22.6	22.5	22.2
	3	23.0	22.1	22.0	21.7
	4	23.0	22.1	22.0	21.7
DC-HSDPA	1	23.5	22.4	22.5	22.5
	2	23.5	22.3	22.4	22.4
	3	23.0	22.1	22.2	21.8
	4	23.0	21.9	22.0	21.8

Hotspot on					
Item	band	FDD Band 2 result			
	ARFCN	Tune up	9538 (1907.6MHz)	9400 (1880MHz)	9262 (1852.4MHz)
WCDMA	\	20.0	19.2	19.2	19.2
HSUPA	1	18.0	17.0	17.0	17.2
	2	17.5	16.6	16.6	16.7
	3	18.5	17.5	17.5	17.7
	4	17.0	16.1	16.1	16.3
	5	18.5	17.5	17.5	17.6
HSDPA	1	19.5	18.6	18.6	18.8
	2	19.5	18.6	18.6	18.7
	3	19.0	18.1	18.1	18.2
	4	19.0	18.1	18.2	18.2
DC-HSDPA	1	19.5	18.7	18.7	18.7
	2	19.5	18.5	18.7	18.5
	3	19.0	18.2	18.0	18.2
	4	19.0	18.0	18.1	18.2
Item	band	FDD Band 4 result			
	ARFCN	Tune up	1513 (1752.6MHz)	1413 (1732.6MHz)	1312 (1712.4MHz)
WCDMA	\	21.0	20.0	20.0	19.7
HSUPA	1	18.5	17.6	17.5	17.3
	2	18.0	17.1	17.0	16.8
	3	18.5	18.1	17.5	17.8
	4	18.0	17.6	16.5	16.3
	5	19.0	18.1	18.1	17.7
HSDPA	1	20.0	19.1	19.2	18.7
	2	20.0	19.1	19.0	18.7
	3	19.5	18.6	18.5	18.2
	4	19.5	18.6	18.6	18.3
DC-HSDPA	1	20.0	19.0	19.1	18.8
	2	20.0	19.2	19.0	18.9
	3	19.5	18.5	18.5	18.4
	4	19.5	18.4	18.6	18.5

11.4 LTE Measurement result
Table 11.5: The conducted Power for LTE
<Full Power>

LTE-FDD Band 2				Actual output Power (dBm)			Tune up
Band-width	RB allocation	RB offset	Modulation	High 1909.3MHz	Middle 1880MHz	Low 1850.7MHz	
1.4 MHz	1RB	High	QPSK	22.26	22.34	22.37	23.5
			16QAM	21.45	21.60	21.63	22.5
			64QAM	20.67	20.84	20.85	21.5
		Middle	QPSK	22.37	22.46	22.48	23.5
			16QAM	21.58	21.68	21.72	22.5
			64QAM	20.82	20.89	20.94	21.5
		Low	QPSK	22.27	22.32	22.37	23.5
			16QAM	21.48	21.57	21.61	22.5
			64QAM	20.72	20.80	20.85	21.5
	3RB	High	QPSK	22.36	22.45	22.49	23.5
			16QAM	21.32	21.41	21.45	22.5
			64QAM	20.55	20.65	20.65	21.5
		Middle	QPSK	22.41	22.49	22.51	23.5
			16QAM	21.37	21.45	21.51	22.5
			64QAM	20.62	20.70	20.73	21.5
		Low	QPSK	22.36	22.44	22.48	23.5
			16QAM	21.32	21.39	21.46	22.5
			64QAM	20.57	20.61	20.67	21.5
	6RB	/	QPSK	21.40	21.45	21.49	22.5
			16QAM	20.48	20.52	20.63	21.5
			64QAM	19.72	19.74	19.88	20.5

<Full Power>

Band-width	LTE-FDD Band 2			Actual output Power (dBm)			Tune up
	RB allocation	RB offset	Modulation	High	Middle	Low	
3 MHz	1RB	High	QPSK	1908.5MHz	1880MHz	1851.5MHz	23.5
			16QAM	22.33	22.42	22.43	22.5
			64QAM	21.55	21.67	21.66	21.5
		Middle	QPSK	22.50	22.56	22.58	23.5
			16QAM	21.70	21.85	21.87	22.5
			64QAM	20.95	21.08	21.07	21.5
		Low	QPSK	22.41	22.41	22.47	23.5
			16QAM	21.64	21.68	21.75	22.5
			64QAM	20.86	20.92	20.99	21.5
	8RB	High	QPSK	21.37	21.44	21.45	22.5
			16QAM	20.44	20.54	20.55	21.5
			64QAM	19.65	19.77	19.78	20.5
		Middle	QPSK	21.42	21.47	21.51	22.5
			16QAM	20.50	20.57	20.61	21.5
			64QAM	19.72	19.77	19.84	20.5
		Low	QPSK	21.40	21.43	21.49	22.5
			16QAM	20.48	20.55	20.59	21.5
			64QAM	19.73	19.79	19.83	20.5
	15RB	/	QPSK	21.41	21.46	21.52	22.5
			16QAM	20.44	20.48	20.54	21.5
			64QAM	19.68	19.70	19.77	20.5

<Full Power>

LTE-FDD Band 2				Actual output Power (dBm)			Tune up
Band-width				High	Middle	Low	
5 MHz	RB allocation	RB offset	Modulation	1907.5MHz	1880MHz	1852.5MHz	
	1RB	High	QPSK	22.21	22.30	22.29	23.5
			16QAM	21.48	21.57	21.54	22.5
			64QAM	20.73	20.80	20.76	21.5
		Middle	QPSK	22.50	22.57	22.59	23.5
			16QAM	21.74	21.85	21.85	22.5
			64QAM	20.95	21.05	21.09	21.5
		Low	QPSK	22.30	22.32	22.38	23.5
			16QAM	21.54	21.57	21.68	22.5
			64QAM	20.75	20.79	20.92	21.5
	12RB	High	QPSK	21.36	21.47	21.50	22.5
			16QAM	20.38	20.45	20.50	21.5
			64QAM	19.60	19.67	19.74	20.5
		Middle	QPSK	21.46	21.49	21.54	22.5
			16QAM	20.46	20.52	20.53	21.5
			64QAM	19.70	19.72	19.76	20.5
		Low	QPSK	21.45	21.45	21.49	22.5
			16QAM	20.47	20.43	20.49	21.5
			64QAM	19.67	19.66	19.74	20.5
	25RB	/	QPSK	21.42	21.47	21.47	22.5
			16QAM	20.42	20.47	20.51	21.5
			64QAM	19.63	19.71	19.72	20.5

<Full Power>

Band-width	LTE-FDD Band 2			Actual output Power (dBm)			Tune up
	RB allocation	RB offset	Modulation	High	Middle	Low	
10 MHz	1RB	High	QPSK	1905MHz	1880MHz	1855MHz	23.5
			16QAM	22.23	22.43	22.41	22.5
			64QAM	21.50	21.66	21.65	21.5
		Middle	QPSK	20.72	20.88	20.86	23.5
			16QAM	22.50	22.62	22.60	22.5
			64QAM	21.76	21.87	21.86	21.5
		Low	QPSK	21.01	21.09	21.07	23.5
			16QAM	22.38	22.47	22.54	22.5
			64QAM	21.69	21.74	21.76	21.5
	25RB	High	QPSK	20.91	20.96	20.98	22.5
			16QAM	21.40	21.59	21.60	21.5
			64QAM	20.43	20.61	20.57	20.5
		Middle	QPSK	19.63	19.84	19.81	22.5
			16QAM	21.45	21.59	21.60	21.5
			64QAM	20.50	20.61	20.60	20.5
		Low	QPSK	19.73	19.83	19.82	22.5
			16QAM	21.52	21.59	21.58	21.5
			64QAM	20.54	20.61	20.61	20.5
	50RB	/	QPSK	19.77	19.82	19.86	22.5
			16QAM	21.48	21.61	21.59	21.5
			64QAM	20.50	20.60	20.59	20.5

<Full Power>

Band-width	LTE-FDD Band 2			Actual output Power (dBm)			Tune up
	RB allocation	RB offset	Modulation	High	Middle	Low	
15 MHz	1RB	High	QPSK	1902.5MHz	1880MHz	1857.5MHz	23.5
			16QAM	22.17	22.34	22.33	22.5
			64QAM	21.43	21.57	21.59	21.5
		Middle	QPSK	20.66	20.81	20.84	23.5
			16QAM	22.38	22.51	22.47	22.5
			64QAM	21.69	21.77	21.75	21.5
		Low	QPSK	20.89	21.02	20.97	23.5
			16QAM	22.33	22.45	22.52	22.5
			64QAM	21.61	21.75	21.74	21.5
	36RB	High	QPSK	20.85	20.99	20.98	22.5
			16QAM	21.39	21.54	21.54	21.5
			64QAM	20.41	20.53	20.52	20.5
		Middle	QPSK	19.66	19.74	19.72	22.5
			16QAM	21.47	21.60	21.60	21.5
			64QAM	20.44	20.56	20.60	20.5
		Low	QPSK	19.69	19.80	19.81	22.5
			16QAM	21.47	21.55	21.60	21.5
			64QAM	20.48	20.59	20.61	20.5
	75RB	/	QPSK	19.72	19.82	19.82	22.5
			16QAM	21.44	21.54	21.57	21.5
			64QAM	20.45	20.54	20.56	20.5

<Full Power>

LTE-FDD Band 2				Actual output Power (dBm)			Tune up
Band-width				High	Middle	Low	
20 MHz	RB allocation	RB offset	Modulation	1900MHz	1880MHz	1860MHz	
	1RB	High	QPSK	22.04	22.17	22.19	23.5
			16QAM	21.33	21.43	21.49	22.5
			64QAM	20.58	20.65	20.72	21.5
		Middle	QPSK	22.44	22.47	22.49	23.5
			16QAM	21.75	21.70	21.73	22.5
			64QAM	20.96	20.91	20.96	21.5
		Low	QPSK	22.24	22.30	22.37	23.5
			16QAM	21.58	21.59	21.66	22.5
			64QAM	20.79	20.84	20.86	21.5
	36RB	High	QPSK	21.32	21.38	21.42	22.5
			16QAM	20.35	20.39	20.43	21.5
			64QAM	19.59	19.61	19.65	20.5
		Middle	QPSK	21.41	21.49	21.53	22.5
			16QAM	20.47	20.52	20.53	21.5
			64QAM	19.71	19.77	19.75	20.5
		Low	QPSK	21.48	21.52	21.49	22.5
			16QAM	20.50	20.54	20.50	21.5
			64QAM	19.72	19.78	19.70	20.5
	75RB	/	QPSK	21.38	21.45	21.44	22.5
			16QAM	20.42	20.45	20.44	21.5
64QAM			19.67	19.68	19.69	20.5	

<Full Power>

Band-width	LTE-FDD Band 4			Actual output Power (dBm)			Tune up
	RB allocation	RB offset	Modulation	High	Middle	Low	
1.4 MHz				1754.3MHz	1732.5MHz	1710.7MHz	
	1RB	High	QPSK	23.51	23.36	23.13	24.5
			16QAM	22.79	22.57	22.34	23.5
			64QAM	21.81	21.60	21.35	22.5
		Middle	QPSK	23.64	23.41	23.22	24.5
			16QAM	22.85	22.68	22.44	23.5
			64QAM	21.89	21.71	21.46	22.5
		Low	QPSK	23.52	23.34	23.10	24.5
			16QAM	22.82	22.59	22.35	23.5
			64QAM	21.85	21.62	21.39	22.5
	3RB	High	QPSK	23.67	23.45	23.21	24.5
			16QAM	22.63	22.41	22.18	23.5
			64QAM	21.65	21.44	21.21	22.5
		Middle	QPSK	23.71	23.49	23.28	24.5
			16QAM	22.67	22.46	22.23	23.5
			64QAM	21.66	21.49	21.25	22.5
		Low	QPSK	23.64	23.45	23.23	24.5
			16QAM	22.63	22.42	22.21	23.5
			64QAM	21.65	21.44	21.23	22.5
	6RB	/	QPSK	22.69	22.49	22.29	23.5
			16QAM	21.76	21.56	21.32	22.5
			64QAM	20.78	20.62	20.35	21.5

<Full Power>

Band-width	LTE-FDD Band 4			Actual output Power (dBm)			Tune up
	RB allocation	RB offset	Modulation	High	Middle	Low	
3 MHz				1753.5MHz	1732.5MHz	1711.5MHz	
	1RB	High	QPSK	23.62	23.41	23.25	24.5
			16QAM	22.88	22.66	22.46	23.5
			64QAM	21.89	21.68	21.48	22.5
		Middle	QPSK	23.78	23.56	23.35	24.5
			16QAM	23.05	22.81	22.60	23.5
			64QAM	22.02	21.84	21.63	22.5
		Low	QPSK	23.63	23.44	23.24	24.5
			16QAM	22.87	22.72	22.46	23.5
			64QAM	21.89	21.74	21.49	22.5
	8RB	High	QPSK	22.68	22.50	22.30	23.5
			16QAM	21.75	21.57	21.33	22.5
			64QAM	20.69	20.62	20.39	21.5
		Middle	QPSK	22.70	22.53	22.34	23.5
			16QAM	21.77	21.58	21.38	22.5
			64QAM	20.79	20.61	20.42	21.5
		Low	QPSK	22.67	22.49	22.29	23.5
			16QAM	21.74	21.52	21.33	22.5
			64QAM	21.78	21.56	21.36	21.5
	15RB	/	QPSK	22.73	22.53	22.34	23.5
			16QAM	21.71	21.51	21.31	22.5
			64QAM	20.68	20.55	20.36	21.5

<Full Power>

Band-width	LTE-FDD Band 4			Actual output Power (dBm)			Tune up
	RB allocation	RB offset	Modulation	High	Middle	Low	
5 MHz				1752.5MHz	1732.5MHz	1712.5MHz	
	1RB	High	QPSK	23.50	23.33	23.12	24.5
			16QAM	22.80	22.58	22.40	23.5
			64QAM	21.82	21.63	21.44	22.5
		Middle	QPSK	23.75	23.61	23.43	24.5
			16QAM	22.98	22.74	22.61	23.5
			64QAM	21.96	21.75	21.63	22.5
		Low	QPSK	23.51	23.33	23.16	24.5
			16QAM	22.72	22.60	22.35	23.5
			64QAM	21.70	21.62	21.38	22.5
	12RB	High	QPSK	22.67	22.53	22.31	23.5
			16QAM	21.66	21.49	21.28	22.5
			64QAM	20.69	20.52	20.33	21.5
		Middle	QPSK	22.71	22.56	22.37	23.5
			16QAM	21.70	21.54	21.35	22.5
			64QAM	20.74	20.59	20.38	21.5
		Low	QPSK	22.67	22.51	22.32	23.5
			16QAM	21.65	21.47	21.28	22.5
			64QAM	20.69	20.51	20.32	21.5
	25RB	/	QPSK	22.69	22.54	22.34	23.5
			16QAM	21.68	21.51	21.31	22.5
			64QAM	20.72	20.55	20.36	21.5

<Full Power>

Band-width	LTE-FDD Band 4			Actual output Power (dBm)			Tune up
	RB allocation	RB offset	Modulation	High	Middle	Low	
10 MHz				1750MHz	1732.5MHz	1715MHz	
	1RB	High	QPSK	23.54	23.42	23.28	24.5
			16QAM	22.86	22.65	22.61	23.5
			64QAM	21.85	21.66	21.63	22.5
		Middle	QPSK	23.70	23.58	23.42	24.5
			16QAM	22.94	22.85	22.69	23.5
			64QAM	21.88	21.84	21.71	22.5
		Low	QPSK	23.55	23.40	23.23	24.5
			16QAM	22.78	22.69	22.48	23.5
			64QAM	21.77	21.65	21.52	22.5
	25RB	High	QPSK	22.71	22.62	22.44	23.5
			16QAM	21.68	21.58	21.46	22.5
			64QAM	20.71	20.59	20.52	21.5
		Middle	QPSK	22.74	22.61	22.44	23.5
			16QAM	21.72	21.58	21.40	22.5
			64QAM	20.77	20.63	21.47	21.5
		Low	QPSK	22.75	22.58	22.44	23.5
			16QAM	21.70	21.54	21.42	22.5
			64QAM	20.75	20.58	20.49	21.5
	50RB	/	QPSK	22.73	22.62	22.42	23.5
			16QAM	21.73	21.58	21.40	22.5
			64QAM	20.78	20.62	20.44	21.5

<Full Power>

LTE-FDD Band 4				Actual output Power (dBm)			Tune up
Band-width				High	Middle	Low	
15 MHz	RB allocation	RB offset	Modulation	1747.5MHz	1732.5MHz	1717.5MHz	
	1RB	High	QPSK	23.48	23.35	23.27	24.5
			16QAM	22.72	22.56	22.58	23.5
			64QAM	21.76	21.58	21.61	22.5
		Middle	QPSK	23.57	23.46	23.34	24.5
			16QAM	22.77	22.72	22.61	23.5
			64QAM	21.79	21.77	21.68	22.5
		Low	QPSK	23.44	23.36	23.20	24.5
			16QAM	22.70	22.65	22.43	23.5
			64QAM	22.68	22.67	22.41	22.5
	36RB	High	QPSK	22.64	22.55	22.45	23.5
			16QAM	21.62	21.50	21.43	22.5
			64QAM	20.61	20.57	20.48	21.5
		Middle	QPSK	22.67	22.58	22.47	23.5
			16QAM	21.64	21.53	21.43	22.5
			64QAM	20.67	20.59	20.48	21.5
		Low	QPSK	22.67	22.53	22.41	23.5
			16QAM	21.64	21.49	21.36	22.5
			64QAM	20.65	20.54	20.42	21.5
	75RB	/	QPSK	22.66	22.55	22.45	23.5
			16QAM	21.62	21.52	21.43	22.5
			64QAM	20.59	20.49	20.48	21.5

<Full Power>

LTE-FDD Band 4				Actual output Power (dBm)			Tune up
Band-width				High	Middle	Low	
20 MHz	RB allocation	RB offset	Modulation	1745MHz	1732.5MHz	1720MHz	
	1RB	High	QPSK	23.46	23.33	23.24	24.5
			16QAM	22.73	22.56	22.53	23.5
			64QAM	21.75	21.63	21.67	22.5
		Middle	QPSK	23.65	23.57	23.45	24.5
			16QAM	22.85	22.77	22.74	23.5
			64QAM	21.92	21.73	21.71	22.5
		Low	QPSK	23.40	23.28	23.15	24.5
			16QAM	22.68	22.54	22.42	23.5
			64QAM	22.69	22.53	22.38	22.5
	36RB	High	QPSK	22.63	22.55	22.50	23.5
			16QAM	21.60	21.54	21.49	22.5
			64QAM	20.59	20.62	20.56	21.5
		Middle	QPSK	22.71	22.59	22.50	23.5
			16QAM	21.67	21.58	21.49	22.5
			64QAM	20.65	20.59	20.43	21.5
		Low	QPSK	22.70	22.53	22.48	23.5
			16QAM	21.63	21.51	21.44	22.5
			64QAM	20.62	20.54	20.48	21.5
	75RB	/	QPSK	22.64	22.52	22.50	23.5
			16QAM	21.61	21.51	21.48	22.5
			64QAM	20.63	20.54	20.52	21.5

<Full Power> / < Hotspot on >

Band-width	LTE-FDD Band 5			Actual output Power (dBm)			Tune up
	RB allocation	RB offset	Modulation	High	Middle	Low	
1.4 MHz	1RB	High	QPSK	848.3MHz	836.5MHz	824.7MHz	24
			16QAM	23.13	23.14	23.08	23
			64QAM	22.35	22.41	22.36	22
		Middle	QPSK	21.34	21.38	21.38	24
			16QAM	23.25	23.25	23.22	23
			64QAM	22.53	22.57	22.49	22
		Low	QPSK	21.51	21.61	21.51	24
			16QAM	23.10	23.11	23.07	23
			64QAM	22.40	22.38	22.34	22
	3RB	High	QPSK	21.42	21.37	21.30	24
			16QAM	23.24	23.24	23.20	23
			64QAM	22.21	22.21	22.15	22
		Middle	QPSK	21.21	21.18	21.14	24
			16QAM	23.34	23.28	23.24	23
			64QAM	22.31	22.28	22.26	22
		Low	QPSK	21.36	21.28	21.27	24
			16QAM	23.27	23.24	23.21	23
			64QAM	22.22	22.23	22.20	22
	6RB	/	QPSK	21.19	21.25	21.22	23
			16QAM	22.30	22.24	22.22	22
			64QAM	21.41	21.35	21.33	21
			20.40	20.35	20.37		

<Full Power> / < Hotspot on >

Band-width	LTE-FDD Band 5			Actual output Power (dBm)			Tune up	
	RB allocation	RB offset	Modulation	High	Middle	Low		
3 MHz	1RB	High	QPSK	847.5MHz	836.5MHz	825.5MHz	24	
			16QAM	23.14	23.15	23.13	23	
			64QAM	22.39	22.42	22.34	22	
		Middle	QPSK	21.38	21.46	21.35	24	
			16QAM	23.29	23.30	23.27	23	
			64QAM	22.61	22.63	22.48	22	
		Low	QPSK	21.61	21.62	21.43	24	
			16QAM	23.14	23.14	23.12	23	
			64QAM	22.36	22.45	22.37	22	
	8RB	High	QPSK	21.37	21.45	21.36	23	
			16QAM	22.22	22.19	22.14	22	
			64QAM	21.33	21.31	21.24	21	
		Middle	QPSK	20.36	20.31	20.28	23	
			16QAM	22.26	22.22	22.18	22	
			64QAM	21.38	21.32	21.28	21	
		Low	QPSK	20.36	20.33	20.27	23	
			16QAM	22.20	22.19	22.16	22	
			64QAM	21.31	21.30	21.25	21	
	15RB	/	QPSK	20.31	20.28	20.25	23	
			16QAM	22.26	22.19	22.16	22	
			64QAM	21.30	21.26	21.22	21	
				QPSK	20.34	20.24	20.26	21

<Full Power> / < Hotspot on >

Band-width	LTE-FDD Band 5			Actual output Power (dBm)			Tune up
	RB allocation	RB offset	Modulation	High	Middle	Low	
5 MHz	1RB	High	QPSK	846.5MHz	836.5MHz	826.5MHz	24
			16QAM	23.06	23.03	23.03	23
			64QAM	22.32	22.35	22.23	22
		Middle	QPSK	21.36	21.30	21.18	24
			16QAM	23.35	23.35	23.24	23
			64QAM	22.49	22.60	22.45	22
		Low	QPSK	21.45	21.63	21.48	24
			16QAM	23.07	23.05	23.01	23
			64QAM	22.14	22.33	22.28	22
	12RB	High	QPSK	21.17	21.33	21.31	23
			16QAM	22.24	22.18	22.14	22
			64QAM	21.26	21.24	21.14	21
		Middle	QPSK	20.27	20.22	20.10	23
			16QAM	22.26	22.26	22.21	22
			64QAM	21.29	21.31	21.23	21
		Low	QPSK	20.29	20.26	20.27	23
			16QAM	22.20	22.20	22.20	22
			64QAM	21.18	21.22	21.22	21
	25RB	/	QPSK	20.20	20.18	20.22	23
			16QAM	22.23	22.20	22.19	22
			64QAM	21.24	21.25	21.20	21
			QPSK	20.23	20.28	20.24	21

<Full Power> / < Hotspot on >

Band-width	LTE-FDD Band 5			Actual output Power (dBm)			Tune up
	RB allocation	RB offset	Modulation	High	Middle	Low	
10 MHz				844MHz	836.5MHz	829MHz	
	1RB	High	QPSK	23.20	23.16	23.15	24
			16QAM	22.42	22.39	22.33	23
			64QAM	21.42	21.38	21.32	22
		Middle	QPSK	23.33	23.30	23.31	24
			16QAM	22.37	22.65	22.41	23
			64QAM	21.40	21.65	21.41	22
		Low	QPSK	23.16	23.14	23.11	24
			16QAM	22.44	22.34	22.37	23
			64QAM	21.41	21.30	21.37	22
	25RB	High	QPSK	22.34	22.25	22.27	23
			16QAM	21.32	21.31	21.24	22
			64QAM	20.32	20.34	20.20	21
		Middle	QPSK	22.38	22.30	22.28	23
			16QAM	21.32	21.32	21.27	22
			64QAM	20.32	20.28	20.30	21
		Low	QPSK	22.40	22.25	22.33	23
			16QAM	21.40	21.26	21.29	22
			64QAM	20.44	20.27	20.24	21
	50RB	/	QPSK	22.39	22.25	22.30	23
			16QAM	21.38	21.28	21.30	22
			64QAM	20.41	20.33	20.35	21

<Full Power> / < Hotspot on >

Band-width	LTE-FDD Band 12			Actual output Power (dBm)			Tune up
	RB allocation	RB offset	Modulation	High	Middle	Low	
1.4 MHz	1RB	High	QPSK	715.3MHz	707.5MHz	699.7MHz	24
			16QAM	23.15	23.22	23.26	23
			64QAM	22.42	22.57	22.58	22
		Middle	QPSK	21.72	21.87	21.84	24
			16QAM	23.29	23.34	23.37	23
			64QAM	22.63	22.70	22.64	22
		Low	QPSK	21.97	21.96	21.91	24
			16QAM	23.15	23.19	23.21	23
			64QAM	22.46	22.53	22.54	22
	3RB	High	QPSK	21.75	21.85	21.88	24
			16QAM	23.28	23.32	23.38	23
			64QAM	22.28	22.38	22.39	22
		Middle	QPSK	21.33	21.41	21.34	24
			16QAM	23.34	23.39	23.37	23
			64QAM	22.35	22.42	22.41	22
		Low	QPSK	21.36	21.40	21.38	24
			16QAM	23.29	23.31	23.34	23
			64QAM	22.27	22.36	22.35	22
	6RB	/	QPSK	21.31	21.34	21.34	23
			16QAM	22.33	22.37	22.37	22
			64QAM	21.45	21.46	21.49	21

<Full Power> / < Hotspot on >

LTE-FDD Band 12				Actual output Power (dBm)			Tune up
Band-width				High	Middle	Low	
3 MHz	RB allocation	RB offset	Modulation	714.5MHz	707.5MHz	700.5MHz	
	1RB	High	QPSK	23.19	23.26	23.27	24
			16QAM	22.42	22.57	22.58	23
			64QAM	21.71	21.90	21.85	22
		Middle	QPSK	23.38	23.41	23.40	24
			16QAM	22.68	22.70	22.84	23
			64QAM	22.00	21.98	22.18	22
		Low	QPSK	23.19	23.24	23.21	24
			16QAM	22.51	22.53	22.48	23
			64QAM	21.81	21.85	21.81	22
	8RB	High	QPSK	22.28	22.30	22.36	23
			16QAM	21.37	21.42	21.46	22
			64QAM	20.41	20.44	20.43	21
		Middle	QPSK	22.33	22.35	22.40	23
			16QAM	21.42	21.46	21.48	22
			64QAM	20.46	20.45	20.49	21
		Low	QPSK	22.27	22.33	22.31	23
			16QAM	21.41	21.43	21.40	22
			64QAM	20.39	20.47	20.45	21
	15RB	/	QPSK	22.30	22.32	22.36	23
			16QAM	21.33	21.35	21.38	22
64QAM			20.37	20.39	20.35	21	

<Full Power> / < Hotspot on >

LTE-FDD Band 12				Actual output Power (dBm)			Tune up
Band-width				High	Middle	Low	
5 MHz	RB allocation	RB offset	Modulation	713.5MHz	707.5MHz	701.5MHz	
	1RB	High	QPSK	23.11	23.16	23.16	24
			16QAM	22.37	22.49	22.53	23
			64QAM	21.70	21.75	21.80	22
		Middle	QPSK	23.37	23.40	23.44	24
			16QAM	22.73	22.74	22.82	23
			64QAM	22.00	22.01	22.11	22
		Low	QPSK	23.10	23.12	23.11	24
			16QAM	22.48	22.45	22.40	23
			64QAM	21.77	21.73	21.71	22
	12RB	High	QPSK	22.31	22.29	22.45	23
			16QAM	21.34	21.30	21.47	22
			64QAM	20.38	20.34	20.47	21
		Middle	QPSK	22.30	22.39	22.42	23
			16QAM	21.33	21.42	21.45	22
			64QAM	20.30	20.45	20.46	21
		Low	QPSK	22.25	22.34	22.31	23
			16QAM	21.27	21.34	21.31	22
			64QAM	20.25	20.30	20.30	21
	25RB	/	QPSK	22.33	22.33	22.39	23
			16QAM	21.34	21.32	21.40	22
			64QAM	20.34	20.30	20.45	21

<Full Power> / < Hotspot on >

LTE-FDD Band 12				Actual output Power (dBm)			Tune up
Band-width				High	Middle	Low	
10 MHz	RB allocation	RB offset	Modulation	711MHz	707.5MHz	704MHz	
	1RB	High	QPSK	23.23	23.24	23.28	24
			16QAM	22.50	22.60	22.61	23
			64QAM	21.78	21.93	21.90	22
		Middle	QPSK	23.40	23.39	23.39	24
			16QAM	22.73	22.73	22.72	23
			64QAM	22.01	22.00	21.97	22
		Low	QPSK	23.18	23.20	23.17	24
			16QAM	22.55	22.55	22.45	23
			64QAM	21.86	21.89	21.72	22
	25RB	High	QPSK	22.41	22.35	22.36	23
			16QAM	21.44	21.35	21.36	22
			64QAM	20.40	20.34	20.34	21
		Middle	QPSK	22.40	22.42	22.40	23
			16QAM	21.45	21.42	21.45	22
			64QAM	20.42	20.45	20.42	21
		Low	QPSK	22.48	22.38	22.27	23
			16QAM	21.52	21.38	21.31	22
			64QAM	20.55	20.39	20.27	21
	50RB	/	QPSK	22.48	22.37	22.35	23
			16QAM	21.50	21.38	21.33	22
			64QAM	20.48	20.38	20.36	21

<Full Power> / < Hotspot on >

LTE-FDD Band 13				Actual output Power (dBm)			Tune up
Band-width				High	Middle	Low	
5 MHz	RB allocation	RB offset	Modulation	784.5MHz	782MHz	779.5MHz	
	1RB	High	QPSK	22.76	22.80	22.83	24
			16QAM	22.15	22.16	22.21	23
			64QAM	21.56	21.55	21.60	22
		Middle	QPSK	23.09	23.09	23.11	24
			16QAM	22.45	22.47	22.48	23
			64QAM	21.89	21.89	21.87	22
		Low	QPSK	22.80	22.80	22.81	24
			16QAM	22.13	22.16	22.14	23
			64QAM	21.49	21.52	21.50	22
	12RB	High	QPSK	21.97	21.98	22.02	23
			16QAM	21.02	21.02	21.05	22
			64QAM	20.03	20.02	20.02	21
		Middle	QPSK	22.06	22.09	22.09	23
			16QAM	21.09	21.12	21.12	22
			64QAM	20.11	20.14	20.09	21
		Low	QPSK	22.04	22.03	22.00	23
			16QAM	21.07	21.05	21.04	22
			64QAM	20.10	20.09	20.01	21
	25RB	/	QPSK	22.01	22.02	22.02	23
			16QAM	21.05	21.04	21.04	22
			64QAM	20.09	20.09	20.11	21

<Full Power> / < Hotspot on >

LTE-FDD Band 13				Actual output Power (dBm)			Tune up
Band-width				High	Middle	Low	
10 MHz	RB allocation	RB offset	Modulation	/	782MHz	/	
	1RB	High	QPSK	/	22.88	/	24
			16QAM	/	22.22	/	23
			64QAM	/	21.61	/	22
		Middle	QPSK	/	23.05	/	24
			16QAM	/	22.37	/	23
			64QAM	/	21.80	/	22
		Low	QPSK	/	22.92	/	24
			16QAM	/	22.25	/	23
			64QAM	/	21.61	/	22
	25RB	High	QPSK	/	22.03	/	23
			16QAM	/	21.06	/	22
			64QAM	/	20.05	/	21
		Middle	QPSK	/	22.10	/	23
			16QAM	/	21.13	/	22
			64QAM	/	20.17	/	21
		Low	QPSK	/	22.04	/	23
			16QAM	/	21.07	/	22
			64QAM	/	20.12	/	21
	50RB	/	QPSK	/	22.07	/	23
			16QAM	/	21.10	/	22
			64QAM	/	20.11	/	21

<Full Power>

Band-width	LTE-FDD Band 25			Actual output Power (dBm)			Tune up
	RB allocation	RB offset	Modulation	High	Middle	Low	
1.4 MHz				1914.3MHz	1882.5MHz	1850.7MHz	
	1RB	High	QPSK	22.10	22.24	22.24	23.5
			16QAM	21.27	21.49	21.50	22.5
			64QAM	20.45	20.59	20.61	21.5
		Middle	QPSK	22.23	22.34	22.33	23.5
			16QAM	21.39	21.61	21.58	22.5
			64QAM	20.46	20.78	20.74	21.5
		Low	QPSK	22.12	22.24	22.24	23.5
			16QAM	21.29	21.45	21.49	22.5
			64QAM	20.52	20.58	20.69	21.5
	3RB	High	QPSK	22.23	22.31	22.34	23.5
			16QAM	21.13	21.29	21.31	22.5
			64QAM	20.23	20.41	20.40	21.5
		Middle	QPSK	22.29	22.35	22.41	23.5
			16QAM	21.19	21.36	21.36	22.5
			64QAM	20.30	20.47	20.49	21.5
		Low	QPSK	22.21	22.33	22.36	23.5
			16QAM	21.16	21.27	21.30	22.5
			64QAM	20.27	20.38	20.42	21.5
	6RB	/	QPSK	21.27	21.35	21.36	22.5
			16QAM	20.32	20.44	20.44	21.5
			64QAM	19.44	19.56	19.54	20.5

<Full Power>

LTE-FDD Band 25				Actual output Power (dBm)			Tune up
Band-width				High	Middle	Low	
3 MHz	RB allocation	RB offset	Modulation	1913.5MHz	1882.5MHz	1851.5MHz	
	1RB	High	QPSK	22.23	22.34	22.30	23.5
			16QAM	21.37	21.58	21.55	22.5
			64QAM	20.49	20.66	20.60	21.5
		Middle	QPSK	22.34	22.53	22.53	23.5
			16QAM	21.51	21.67	21.69	22.5
			64QAM	20.68	20.96	21.09	21.5
		Low	QPSK	22.24	22.34	22.36	23.5
			16QAM	21.42	21.63	21.61	22.5
			64QAM	20.64	20.86	20.81	21.5
	8RB	High	QPSK	21.25	21.37	21.37	22.5
			16QAM	20.30	20.47	20.45	21.5
			64QAM	19.39	19.57	19.56	20.5
		Middle	QPSK	21.29	21.41	21.42	22.5
			16QAM	20.34	20.49	20.51	21.5
			64QAM	19.45	19.58	19.62	20.5
		Low	QPSK	21.26	21.36	21.38	22.5
			16QAM	20.32	20.44	20.46	21.5
			64QAM	19.41	19.53	19.56	20.5
	15RB	/	QPSK	21.29	21.36	21.38	22.5
			16QAM	20.30	20.40	20.42	21.5
64QAM			19.39	19.51	19.54	20.5	

<Full Power>

LTE-FDD Band 25				Actual output Power (dBm)			Tune up
Band-width				High	Middle	Low	
5 MHz	RB allocation	RB offset	Modulation	1912.5MHz	1882.5MHz	1852.5MHz	
	1RB	High	QPSK	22.08	22.21	22.18	23.5
			16QAM	21.29	21.43	21.42	22.5
			64QAM	20.42	20.54	20.52	21.5
		Middle	QPSK	22.42	22.52	22.48	23.5
			16QAM	21.54	21.75	21.71	22.5
			64QAM	20.62	20.87	20.83	21.5
		Low	QPSK	22.08	22.21	22.25	23.5
			16QAM	21.36	21.46	21.49	22.5
			64QAM	20.45	20.55	20.60	21.5
	12RB	High	QPSK	21.17	21.37	21.37	22.5
			16QAM	20.16	20.35	20.38	21.5
			64QAM	19.24	19.46	19.49	20.5
		Middle	QPSK	21.28	21.43	21.45	22.5
			16QAM	20.29	20.43	20.44	21.5
			64QAM	19.37	19.52	19.56	20.5
		Low	QPSK	21.31	21.35	21.37	22.5
			16QAM	20.31	20.37	20.38	21.5
			64QAM	19.40	19.45	19.48	20.5
	25RB	/	QPSK	21.25	21.37	21.40	22.5
			16QAM	20.23	20.39	20.41	21.5
64QAM			19.34	19.51	19.51	20.5	

<Full Power>

LTE-FDD Band 25				Actual output Power (dBm)			Tune up
Band-width				High	Middle	Low	
10 MHz	RB allocation	RB offset	Modulation	1910MHz	1882.5MHz	1855MHz	
	1RB	High	QPSK	22.12	22.37	22.38	23.5
			16QAM	21.30	21.59	21.59	22.5
			64QAM	20.42	20.69	20.67	21.5
		Middle	QPSK	22.30	22.53	22.52	23.5
			16QAM	21.52	21.75	21.82	22.5
			64QAM	20.62	20.86	20.95	21.5
		Low	QPSK	22.28	22.40	22.43	23.5
			16QAM	21.53	21.66	21.68	22.5
			64QAM	20.62	20.75	20.80	21.5
	25RB	High	QPSK	21.16	21.47	21.53	22.5
			16QAM	20.15	20.49	20.55	21.5
			64QAM	19.26	19.62	19.64	20.5
		Middle	QPSK	21.32	21.51	21.51	22.5
			16QAM	20.32	20.53	20.52	21.5
			64QAM	19.42	19.61	19.63	20.5
		Low	QPSK	21.40	21.50	21.51	22.5
			16QAM	20.41	20.50	20.53	21.5
			64QAM	19.51	19.59	19.64	20.5
	50RB	/	QPSK	21.30	21.50	21.51	22.5
			16QAM	20.30	20.53	20.50	21.5
			64QAM	19.40	19.63	19.60	20.5

<Full Power>

LTE-FDD Band 25				Actual output Power (dBm)			Tune up
Band-width				High	Middle	Low	
15 MHz	RB allocation	RB offset	Modulation	1907.5MHz	1882.5MHz	1857.5MHz	
	1RB	High	QPSK	22.06	22.31	22.34	23.5
			16QAM	21.23	21.57	21.58	22.5
			64QAM	20.42	20.63	20.69	21.5
		Middle	QPSK	22.29	22.46	22.46	23.5
			16QAM	21.53	21.73	21.70	22.5
			64QAM	20.62	20.86	20.83	21.5
		Low	QPSK	22.23	22.36	22.44	23.5
			16QAM	21.50	21.60	21.69	22.5
			64QAM	20.59	20.72	20.81	21.5
	36RB	High	QPSK	21.19	21.50	21.52	22.5
			16QAM	20.18	20.46	20.49	21.5
			64QAM	19.27	19.58	19.57	20.5
		Middle	QPSK	21.35	21.52	21.55	22.5
			16QAM	20.34	20.50	20.51	21.5
			64QAM	19.46	19.61	19.60	20.5
		Low	QPSK	21.40	21.54	21.57	22.5
			16QAM	20.39	20.50	20.52	21.5
			64QAM	19.48	19.61	19.61	20.5
	75RB	/	QPSK	21.30	21.50	21.53	22.5
			16QAM	20.31	20.48	20.51	21.5
64QAM			19.40	19.59	19.64	20.5	

<Full Power>

LTE-FDD Band 25				Actual output Power (dBm)			Tune up
Band-width				High	Middle	Low	
20 MHz	RB allocation	RB offset	Modulation	1905MHz	1882.5MHz	1860MHz	
	1RB	High	QPSK	22.01	22.16	22.11	23.5
			16QAM	21.21	21.41	21.41	22.5
			64QAM	20.44	20.55	20.54	21.5
		Middle	QPSK	22.42	22.44	22.48	23.5
			16QAM	21.65	21.76	21.67	22.5
			64QAM	20.76	20.87	20.80	21.5
		Low	QPSK	22.29	22.27	22.32	23.5
			16QAM	21.56	21.51	21.55	22.5
			64QAM	20.68	20.61	20.64	21.5
	36RB	High	QPSK	21.16	21.37	21.43	22.5
			16QAM	20.19	20.38	20.41	21.5
			64QAM	19.29	19.47	19.51	20.5
		Middle	QPSK	21.39	21.46	21.51	22.5
			16QAM	20.38	20.45	20.52	21.5
			64QAM	19.49	19.54	19.63	20.5
		Low	QPSK	21.44	21.45	21.45	22.5
			16QAM	20.47	20.46	20.42	21.5
			64QAM	19.58	19.56	19.51	20.5
	75RB	/	QPSK	21.32	21.39	21.42	22.5
			16QAM	20.31	20.41	20.42	21.5
			64QAM	19.41	19.49	19.51	20.5

<Full Power> / < Hotspot on >

LTE-FDD Band 26				Actual output Power (dBm)			Tune up
Band-width				High	Middle	Low	
1.4 MHz	RB allocation	RB offset	Modulation	848.3MHz	831.5MHz	814.7MHz	
	1RB	High	QPSK	22.75	22.77	22.71	24
			16QAM	22.00	21.94	21.96	23
			64QAM	21.27	21.24	21.20	22
		Middle	QPSK	22.92	22.89	22.86	24
			16QAM	22.19	22.11	22.11	23
			64QAM	21.46	21.40	21.33	22
		Low	QPSK	22.79	22.73	22.71	24
			16QAM	22.11	21.96	21.98	23
			64QAM	21.38	21.25	21.18	22
	3RB	High	QPSK	22.89	22.87	22.81	24
			16QAM	21.88	21.80	21.82	23
			64QAM	20.87	20.77	20.86	22
		Middle	QPSK	22.97	22.92	22.87	24
			16QAM	21.97	21.87	21.90	23
			64QAM	20.93	20.89	20.87	22
		Low	QPSK	22.92	22.86	22.82	24
			16QAM	21.91	21.80	21.84	23
			64QAM	20.91	20.82	20.86	22
	6RB	/	QPSK	21.93	21.89	21.90	23
			16QAM	21.05	20.96	20.98	22
			64QAM	20.04	19.97	20.02	21

<Full Power> / < Hotspot on >

LTE-FDD Band 26				Actual output Power (dBm)			Tune up
Band-width				High	Middle	Low	
3 MHz	RB allocation	RB offset	Modulation	847.5MHz	831.5MHz	815.5MHz	
	1RB	High	QPSK	22.81	22.77	22.94	24
			16QAM	22.09	21.97	22.05	23
			64QAM	21.35	21.20	21.35	22
		Middle	QPSK	22.96	22.93	23.13	24
			16QAM	22.27	22.10	22.26	23
			64QAM	21.51	21.36	21.51	22
		Low	QPSK	22.78	22.80	23.01	24
			16QAM	22.04	22.01	22.15	23
			64QAM	21.30	21.24	21.36	22
	8RB	High	QPSK	21.86	21.82	21.97	23
			16QAM	20.98	20.90	21.00	22
			64QAM	19.95	19.88	20.02	21
		Middle	QPSK	21.90	21.84	22.00	23
			16QAM	21.00	20.94	21.03	22
			64QAM	20.00	19.96	20.04	21
		Low	QPSK	21.86	21.81	22.03	23
			16QAM	20.96	20.91	21.01	22
			64QAM	19.93	19.96	19.99	21
	15RB	/	QPSK	21.87	21.84	22.05	23
			16QAM	20.90	20.89	21.01	22
			64QAM	19.91	19.92	20.02	21

<Full Power> / < Hotspot on >

LTE-FDD Band 26				Actual output Power (dBm)			Tune up
Band-width				High	Middle	Low	
5 MHz	RB allocation	RB offset	Modulation	846.5MHz	831.5MHz	816.5MHz	
	1RB	High	QPSK	22.70	22.68	22.65	24
			16QAM	21.97	21.96	21.91	23
			64QAM	21.26	21.23	21.13	22
		Middle	QPSK	22.99	22.91	22.90	24
			16QAM	22.22	22.13	22.15	23
			64QAM	21.48	21.38	21.44	22
		Low	QPSK	22.67	22.67	22.63	24
			16QAM	21.82	21.91	21.90	23
			64QAM	21.06	21.16	21.12	22
	12RB	High	QPSK	21.85	21.83	21.83	23
			16QAM	20.88	20.83	20.83	22
			64QAM	19.92	19.82	19.81	21
		Middle	QPSK	21.90	21.87	21.89	23
			16QAM	20.92	20.89	20.89	22
			64QAM	19.92	19.90	19.87	21
		Low	QPSK	21.85	21.83	21.83	23
			16QAM	20.83	20.81	20.81	22
			64QAM	19.81	19.86	19.79	21
	25RB	/	QPSK	21.89	21.87	21.84	23
			16QAM	20.90	20.87	20.86	22
			64QAM	19.92	19.85	19.84	21

<Full Power> / < Hotspot on >

LTE-FDD Band 26				Actual output Power (dBm)			Tune up
Band-width				High	Middle	Low	
10 MHz	RB allocation	RB offset	Modulation	844MHz	831.5MHz	820MHz	
	1RB	High	QPSK	22.77	22.78	22.74	24
			16QAM	22.06	22.07	22.06	23
			64QAM	21.28	21.29	21.29	22
		Middle	QPSK	22.90	22.87	22.80	24
			16QAM	21.97	22.09	22.07	23
			64QAM	21.24	21.30	21.30	22
		Low	QPSK	22.83	22.75	22.75	24
			16QAM	22.11	22.02	22.04	23
			64QAM	21.37	21.29	21.27	22
	25RB	High	QPSK	21.93	21.89	21.87	23
			16QAM	20.91	20.93	20.88	22
			64QAM	19.94	19.96	19.93	21
		Middle	QPSK	21.89	21.86	21.88	23
			16QAM	20.90	20.87	20.85	22
			64QAM	19.89	19.82	19.86	21
		Low	QPSK	22.02	21.92	21.89	23
			16QAM	21.02	20.90	20.84	22
			64QAM	20.07	19.88	19.86	21
	50RB	/	QPSK	21.97	21.93	21.88	23
			16QAM	20.98	20.94	20.86	22
			64QAM	20.02	19.97	19.84	21

<Full Power> / < Hotspot on >

LTE-FDD Band 26				Actual output Power (dBm)			Tune up
Band-width				High	Middle	Low	
15 MHz	RB allocation	RB offset	Modulation	841.5MHz	831.5MHz	822.5MHz	
	1RB	High	QPSK	22.77	22.80	22.75	24
			16QAM	22.02	22.04	21.97	23
			64QAM	21.30	21.33	21.20	22
		Middle	QPSK	22.90	22.85	22.82	24
			16QAM	22.10	22.03	22.13	23
			64QAM	21.37	21.25	21.35	22
		Low	QPSK	22.73	22.73	22.70	24
			16QAM	22.00	22.00	21.96	23
			64QAM	21.21	21.25	21.19	22
	36RB	High	QPSK	21.91	21.92	21.87	23
			16QAM	20.87	20.92	20.83	22
			64QAM	19.85	19.93	19.84	21
		Middle	QPSK	21.92	21.91	21.91	23
			16QAM	20.92	20.88	20.89	22
			64QAM	19.95	19.84	19.92	21
		Low	QPSK	21.93	21.92	21.89	23
			16QAM	20.94	20.89	20.83	22
			64QAM	19.89	19.86	19.83	21
	75RB	/	QPSK	21.93	21.93	21.85	23
			16QAM	20.94	20.94	20.84	22
			64QAM	19.91	19.96	19.86	21

<Full Power>- PC3

LTE-FDD Band 41				Actual output Power (dBm)			Tune up
Band-width				High	Middle	Low	
5 MHz	RB allocation	RB offset	Modulation	2687.5MHz	2593MHz	2498.5MHz	
	1RB	High	QPSK	22.72	22.76	22.77	24
			16QAM	21.82	21.87	21.88	23
			64QAM	20.97	21.01	20.98	22
		Middle	QPSK	23.00	23.09	23.05	24
			16QAM	22.17	22.17	22.19	23
			64QAM	21.27	21.26	21.26	22
		Low	QPSK	22.75	22.78	22.81	24
			16QAM	21.89	21.87	21.89	23
			64QAM	20.96	20.93	20.94	22
	12RB	High	QPSK	21.86	21.91	21.91	23
			16QAM	20.86	20.93	20.88	22
			64QAM	19.87	19.89	19.87	21
		Middle	QPSK	21.94	21.99	22.01	23
			16QAM	20.90	20.92	20.95	22
			64QAM	19.93	19.97	19.93	21
		Low	QPSK	21.88	21.87	21.91	23
			16QAM	20.87	20.89	20.90	22
			64QAM	19.85	19.87	19.92	21
	25RB	/	QPSK	21.89	21.88	21.91	23
			16QAM	20.90	20.91	20.95	22
			64QAM	19.92	19.93	20.02	21

<Full Power>- PC3

LTE-FDD Band 41				Actual output Power (dBm)			Tune up
Band-width				High	Middle	Low	
10 MHz	RB allocation	RB offset	Modulation	2685MHz	2593MHz	2501MHz	
	1RB	High	QPSK	22.83	22.88	22.91	24
			16QAM	21.96	21.98	22.03	23
			64QAM	21.05	21.09	21.13	22
		Middle	QPSK	23.03	23.04	23.03	24
			16QAM	22.13	22.13	22.15	23
			64QAM	21.22	21.27	21.28	22
		Low	QPSK	22.85	22.89	22.92	24
			16QAM	21.96	21.99	22.01	23
			64QAM	21.02	21.05	21.16	22
	25RB	High	QPSK	21.96	21.95	21.98	23
			16QAM	20.99	21.01	21.04	22
			64QAM	19.96	19.97	20.06	21
		Middle	QPSK	21.97	21.98	22.00	23
			16QAM	21.04	21.02	21.05	22
			64QAM	20.02	20.03	20.02	21
		Low	QPSK	21.94	21.95	21.98	23
			16QAM	20.98	20.99	21.00	22
			64QAM	20.03	19.96	20.00	21
	50RB	/	QPSK	21.99	22.02	22.01	23
			16QAM	21.09	21.07	21.10	22
			64QAM	20.09	20.08	20.19	21

<Full Power>- PC3

LTE-FDD Band 41				Actual output Power (dBm)			Tune up
Band-width				High	Middle	Low	
15 MHz	RB allocation	RB offset	Modulation	2682.5MHz	2593MHz	2503.5MHz	
	1RB	High	QPSK	22.79	22.85	22.90	24
			16QAM	21.91	21.94	21.99	23
			64QAM	20.98	21.07	21.04	22
		Middle	QPSK	22.91	22.96	22.94	24
			16QAM	22.02	22.04	22.05	23
			64QAM	21.14	21.16	21.13	22
		Low	QPSK	22.80	22.85	22.85	24
			16QAM	21.90	21.94	21.94	23
			64QAM	20.97	21.00	21.04	22
	36RB	High	QPSK	21.92	21.94	21.97	23
			16QAM	20.86	20.90	20.93	22
			64QAM	19.91	19.92	19.95	21
		Middle	QPSK	21.96	21.98	21.99	23
			16QAM	20.89	20.89	20.97	22
			64QAM	19.94	19.85	20.00	21
		Low	QPSK	21.89	21.94	21.93	23
			16QAM	20.87	20.90	20.93	22
			64QAM	19.91	19.92	19.94	21
	75RB	/	QPSK	21.96	21.97	21.98	23
			16QAM	20.99	21.00	21.03	22
			64QAM	20.07	20.03	20.10	21

<Full Power>- PC3

LTE-FDD Band 41				Actual output Power (dBm)			Tune up
Band-width				High	Middle	Low	
20 MHz	RB allocation	RB offset	Modulation	2680MHz	2593MHz	2506MHz	
	1RB	High	QPSK	22.76	22.78	22.83	24
			16QAM	21.86	21.89	21.92	23
			64QAM	21.01	20.94	20.97	22
		Middle	QPSK	23.06	23.11	23.12	24
			16QAM	22.14	22.19	22.20	23
			64QAM	21.26	21.30	21.32	22
		Low	QPSK	22.81	22.80	22.81	24
			16QAM	21.91	21.89	21.92	23
			64QAM	21.01	21.03	20.98	22
	36RB	High	QPSK	22.00	22.00	22.03	23
			16QAM	21.04	21.05	21.09	22
			64QAM	20.04	20.07	20.14	21
		Middle	QPSK	22.02	22.02	22.08	23
			16QAM	21.07	21.12	21.11	22
			64QAM	20.10	20.13	20.11	21
		Low	QPSK	21.99	22.00	21.97	23
			16QAM	21.05	21.05	21.02	22
			64QAM	20.03	20.01	20.02	21
	75RB	/	QPSK	21.95	21.93	21.97	23
			16QAM	21.01	20.97	21.03	22
			64QAM	20.08	20.00	20.13	21

<Full Power>- PC3

LTE-FDD Band 41				Actual output Power (dBm)			Tune up
Band-width				High	Middle	Low	
5 MHz	RB allocation	RB offset	Modulation	2640.3MHz	/	2545.8MHz	
	1RB	High	QPSK	22.72	/	22.80	24
			16QAM	21.80	/	21.89	23
			64QAM	20.97	/	21.02	22
		Middle	QPSK	23.08	/	23.11	24
			16QAM	22.13	/	22.21	23
			64QAM	21.27	/	21.29	22
		Low	QPSK	22.75	/	22.84	24
			16QAM	21.90	/	21.89	23
			64QAM	20.94	/	20.95	22
	12RB	High	QPSK	21.91	/	21.88	23
			16QAM	20.85	/	20.91	22
			64QAM	19.88	/	19.91	21
		Middle	QPSK	21.93	/	22.04	23
			16QAM	20.91	/	20.97	22
			64QAM	19.95	/	19.99	21
		Low	QPSK	21.85	/	21.86	23
			16QAM	20.86	/	20.85	22
			64QAM	19.88	/	19.90	21
	25RB	/	QPSK	21.87	/	21.91	23
			16QAM	20.91	/	20.97	22
			64QAM	19.89	/	19.95	21

<Full Power>- PC3

LTE-FDD Band 41				Actual output Power (dBm)			Tune up
Band-width				High	Middle	Low	
10 MHz	RB allocation	RB offset	Modulation	2639MHz	/	2547MHz	
	1RB	High	QPSK	22.89	/	22.94	24
			16QAM	22.02	/	22.04	23
			64QAM	21.09	/	21.07	22
		Middle	QPSK	23.01	/	23.02	24
			16QAM	22.18	/	22.19	23
			64QAM	21.26	/	21.29	22
		Low	QPSK	22.89	/	22.86	24
			16QAM	21.98	/	22.01	23
			64QAM	20.99	/	21.08	22
	25RB	High	QPSK	21.99	/	21.96	23
			16QAM	20.96	/	20.99	22
			64QAM	19.93	/	20.02	21
		Middle	QPSK	21.95	/	21.95	23
			16QAM	21.05	/	21.04	22
			64QAM	20.02	/	20.01	21
		Low	QPSK	21.95	/	21.98	23
			16QAM	20.97	/	20.99	22
			64QAM	19.97	/	20.00	21
	50RB	/	QPSK	22.05	/	22.03	23
			16QAM	21.11	/	21.06	22
			64QAM	20.09	/	20.13	21

<Full Power>- PC3

LTE-FDD Band 41				Actual output Power (dBm)			Tune up
Band-width				High	Middle	Low	
15 MHz	RB allocation	RB offset	Modulation	2637.8MHz	/	2548.3MHz	
	1RB	High	QPSK	22.82	/	22.91	24
			16QAM	21.89	/	21.94	23
			64QAM	21.01	/	21.01	22
		Middle	QPSK	22.94	/	22.93	24
			16QAM	22.02	/	22.05	23
			64QAM	21.11	/	21.16	22
		Low	QPSK	22.80	/	22.89	24
			16QAM	21.94	/	21.97	23
			64QAM	21.02	/	21.01	22
	36RB	High	QPSK	21.97	/	21.93	23
			16QAM	20.88	/	20.92	22
			64QAM	19.88	/	19.95	21
		Middle	QPSK	21.93	/	21.95	23
			16QAM	20.91	/	20.89	22
			64QAM	19.86	/	19.92	21
		Low	QPSK	21.89	/	21.89	23
			16QAM	20.89	/	20.95	22
			64QAM	19.93	/	19.91	21
	75RB	/	QPSK	21.97	/	22.01	23
			16QAM	20.99	/	21.01	22
			64QAM	20.01	/	20.02	21

<Full Power>- PC3

LTE-FDD Band 41				Actual output Power (dBm)			Tune up
Band-width				High	Middle	Low	
20 MHz	RB allocation	RB offset	Modulation	2636.5MHz	/	2549.5MHz	
	1RB	High	QPSK	22.72	/	22.83	24
			16QAM	21.92	/	21.92	23
			64QAM	21.00	/	20.95	22
		Middle	QPSK	23.08	/	23.11	24
			16QAM	22.14	/	22.17	23
			64QAM	21.27	/	21.33	22
		Low	QPSK	22.82	/	22.81	24
			16QAM	21.94	/	21.92	23
			64QAM	21.02	/	20.99	22
	36RB	High	QPSK	21.99	/	22.03	23
			16QAM	21.08	/	21.11	22
			64QAM	20.02	/	20.12	21
		Middle	QPSK	22.00	/	22.01	23
			16QAM	21.09	/	21.12	22
			64QAM	20.11	/	20.16	21
		Low	QPSK	21.99	/	22.02	23
			16QAM	21.08	/	21.01	22
			64QAM	19.98	/	20.03	21
	75RB	/	QPSK	21.92	/	21.98	23
			16QAM	20.98	/	21.02	22
			64QAM	20.01	/	20.05	21

<Full Power>- PC2

Band-width	LTE-FDD Band 41			Actual output Power (dBm)			Tune up
	RB allocation	RB offset	Modulation	High	Middle	Low	
5 MHz	1RB	High	QPSK	2687.5MHz	2593MHz	2498.5MHz	26.5
			16QAM	25.47	25.51	25.55	25.5
			64QAM	24.62	24.64	24.62	24.5
		Middle	QPSK	23.79	23.75	23.76	26.5
			16QAM	25.66	25.60	25.61	25.5
			64QAM	24.70	24.75	24.73	24.5
		Low	QPSK	23.80	23.85	23.89	26.5
			16QAM	25.49	25.53	25.54	25.5
			64QAM	24.58	24.64	24.68	24.5
	12RB	High	QPSK	23.78	23.74	23.81	25.5
			16QAM	24.66	24.66	24.68	24.5
			64QAM	23.66	23.66	23.69	23.5
		Middle	QPSK	22.62	22.66	22.65	25.5
			16QAM	24.72	24.75	24.76	24.5
			64QAM	23.76	23.74	23.78	23.5
		Low	QPSK	22.75	22.72	22.75	25.5
			16QAM	24.65	24.69	24.69	24.5
			64QAM	23.64	23.66	23.68	23.5
	25RB	/	QPSK	22.67	22.63	22.70	25.5
			16QAM	24.61	24.66	24.66	24.5
			64QAM	23.71	23.72	23.72	23.5
			QPSK	22.72	22.77	22.79	23.5

<Full Power>- PC2

LTE-FDD Band 41				Actual output Power (dBm)			Tune up
Band-width				High	Middle	Low	
10 MHz	RB allocation	RB offset	Modulation	2685MHz	2593MHz	2501MHz	
	1RB	High	QPSK	25.62	25.64	25.66	26.5
			16QAM	24.76	24.78	24.80	25.5
			64QAM	23.93	23.91	23.98	24.5
		Middle	QPSK	25.71	25.73	25.75	26.5
			16QAM	24.87	24.86	24.83	25.5
			64QAM	24.04	24.00	23.99	24.5
		Low	QPSK	25.59	25.63	25.64	26.5
			16QAM	24.73	24.78	24.82	25.5
			64QAM	23.92	23.93	23.97	24.5
	25RB	High	QPSK	24.69	24.71	24.76	25.5
			16QAM	23.76	23.76	23.82	24.5
			64QAM	22.75	22.78	22.86	23.5
		Middle	QPSK	24.73	24.72	24.76	25.5
			16QAM	23.78	23.76	23.80	24.5
			64QAM	22.74	22.80	22.82	23.5
		Low	QPSK	24.68	24.70	24.73	25.5
			16QAM	23.75	23.76	23.80	24.5
			64QAM	22.78	22.80	22.78	23.5
	50RB	/	QPSK	24.75	24.78	24.77	25.5
			16QAM	23.75	23.77	23.78	24.5
			64QAM	22.82	22.78	22.88	23.5

<Full Power>- PC2

LTE-FDD Band 41				Actual output Power (dBm)			Tune up
Band-width				High	Middle	Low	
15 MHz	RB allocation	RB offset	Modulation	2682.5MHz	2593MHz	2503.5MHz	
	1RB	High	QPSK	25.54	25.52	25.57	26.5
			16QAM	24.67	24.56	24.76	25.5
			64QAM	23.79	23.74	23.87	24.5
		Middle	QPSK	25.63	25.61	25.65	26.5
			16QAM	24.87	24.76	24.78	25.5
			64QAM	23.98	23.92	23.98	24.5
		Low	QPSK	25.51	25.53	25.57	26.5
			16QAM	24.66	24.69	24.72	25.5
			64QAM	23.82	23.86	23.84	24.5
	36RB	High	QPSK	24.71	24.69	24.76	25.5
			16QAM	23.66	23.63	23.68	24.5
			64QAM	22.67	22.67	22.67	23.5
		Middle	QPSK	24.70	24.71	24.74	25.5
			16QAM	23.65	23.65	23.68	24.5
			64QAM	22.61	22.67	22.65	23.5
		Low	QPSK	24.73	24.68	24.71	25.5
			16QAM	23.67	23.62	23.64	24.5
			64QAM	22.63	22.61	22.65	23.5
	75RB	/	QPSK	24.67	24.66	24.68	25.5
			16QAM	23.67	23.68	23.71	24.5
			64QAM	22.70	22.71	22.76	23.5

<Full Power>- PC2

LTE-FDD Band 41				Actual output Power (dBm)			Tune up
Band-width				High	Middle	Low	
20 MHz	RB allocation	RB offset	Modulation	2680MHz	2593MHz	2506MHz	
	1RB	High	QPSK	25.46	25.56	25.66	26.5
			16QAM	24.50	24.71	24.81	25.5
			64QAM	23.66	23.88	23.99	24.5
		Middle	QPSK	25.63	25.81	25.91	26.5
			16QAM	24.77	24.96	25.04	25.5
			64QAM	23.96	24.07	24.22	24.5
		Low	QPSK	25.54	25.63	25.77	26.5
			16QAM	24.70	24.79	24.84	25.5
			64QAM	23.85	23.93	24.01	24.5
	36RB	High	QPSK	24.70	24.79	24.92	25.5
			16QAM	23.69	23.78	23.90	24.5
			64QAM	22.71	22.82	22.91	23.5
		Middle	QPSK	24.75	24.85	24.95	25.5
			16QAM	23.73	23.83	23.94	24.5
			64QAM	22.73	22.81	22.90	23.5
		Low	QPSK	24.76	24.82	24.85	25.5
			16QAM	23.74	23.81	23.85	24.5
			64QAM	22.76	22.83	22.80	23.5
	75RB	/	QPSK	24.80	24.88	24.93	25.5
			16QAM	23.77	23.87	23.90	24.5
			64QAM	22.81	22.94	22.93	23.5

<Full Power>- PC2

LTE-FDD Band 41				Actual output Power (dBm)			Tune up
Band-width				High	Middle	Low	
5 MHz	RB allocation	RB offset	Modulation	2640.3MHz	/	2545.8MHz	
	1RB	High	QPSK	25.49	/	25.56	26.5
			16QAM	24.63	/	24.76	25.5
			64QAM	23.77	/	23.89	24.5
		Middle	QPSK	25.63	/	25.69	26.5
			16QAM	24.72	/	24.85	25.5
			64QAM	23.83	/	24.03	24.5
		Low	QPSK	25.51	/	25.63	26.5
			16QAM	24.61	/	24.72	25.5
			64QAM	23.76	/	23.95	24.5
	12RB	High	QPSK	24.66	/	24.73	25.5
			16QAM	23.66	/	23.78	24.5
			64QAM	22.64	/	22.73	23.5
		Middle	QPSK	24.74	/	24.73	25.5
			16QAM	23.75	/	23.77	24.5
			64QAM	22.73	/	22.78	23.5
		Low	QPSK	24.67	/	24.68	25.5
			16QAM	23.65	/	23.76	24.5
			64QAM	22.65	/	22.82	23.5
	25RB	/	QPSK	24.64	/	24.75	25.5
			16QAM	23.71	/	23.77	24.5
			64QAM	22.75	/	22.77	23.5

<Full Power>- PC2

LTE-FDD Band 41				Actual output Power (dBm)			Tune up
Band-width				High	Middle	Low	
10 MHz	RB allocation	RB offset	Modulation	2639MHz	/	2547MHz	
	1RB	High	QPSK	25.64	/	25.67	26.5
			16QAM	24.75	/	24.79	25.5
			64QAM	23.90	/	23.93	24.5
		Middle	QPSK	25.69	/	25.72	26.5
			16QAM	24.84	/	24.84	25.5
			64QAM	23.99	/	24.01	24.5
		Low	QPSK	25.57	/	25.61	26.5
			16QAM	24.77	/	24.78	25.5
			64QAM	23.92	/	23.95	24.5
	25RB	High	QPSK	24.67	/	24.71	25.5
			16QAM	23.75	/	23.77	24.5
			64QAM	22.77	/	22.83	23.5
		Middle	QPSK	24.74	/	24.74	25.5
			16QAM	23.80	/	23.77	24.5
			64QAM	22.78	/	22.81	23.5
		Low	QPSK	24.72	/	24.71	25.5
			16QAM	23.73	/	23.77	24.5
			64QAM	22.79	/	22.80	23.5
	50RB	/	QPSK	24.75	/	24.77	25.5
			16QAM	23.76	/	23.76	24.5
			64QAM	22.78	/	22.82	23.5

<Full Power>- PC2

LTE-FDD Band 41				Actual output Power (dBm)			Tune up
Band-width				High	Middle	Low	
15 MHz	RB allocation	RB offset	Modulation	2637.8MHz	/	2548.3MHz	
	1RB	High	QPSK	25.53	/	25.52	26.5
			16QAM	24.61	/	24.60	25.5
			64QAM	23.77	/	23.78	24.5
		Middle	QPSK	25.63	/	25.72	26.5
			16QAM	24.84	/	24.88	25.5
			64QAM	23.93	/	24.04	24.5
		Low	QPSK	25.50	/	25.60	26.5
			16QAM	24.64	/	24.71	25.5
			64QAM	23.81	/	23.86	24.5
	36RB	High	QPSK	24.68	/	24.74	25.5
			16QAM	23.68	/	23.75	24.5
			64QAM	22.66	/	22.74	23.5
		Middle	QPSK	24.73	/	24.83	25.5
			16QAM	23.67	/	23.82	24.5
			64QAM	22.63	/	22.78	23.5
		Low	QPSK	24.74	/	24.76	25.5
			16QAM	23.67	/	23.75	24.5
			64QAM	22.64	/	22.79	23.5
	75RB	/	QPSK	24.69	/	24.85	25.5
			16QAM	23.69	/	23.80	24.5
			64QAM	22.69	/	22.86	23.5

<Full Power>- PC2

LTE-FDD Band 41				Actual output Power (dBm)			Tune up
Band-width				High	Middle	Low	
20 MHz	RB allocation	RB offset	Modulation	2636.5MHz	/	2549.5MHz	
	1RB	High	QPSK	25.52	/	25.62	26.5
			16QAM	24.60	/	24.75	25.5
			64QAM	23.77	/	23.94	24.5
		Middle	QPSK	25.69	/	25.87	26.5
			16QAM	24.87	/	25.02	25.5
			64QAM	24.00	/	24.16	24.5
		Low	QPSK	25.58	/	25.71	26.5
			16QAM	24.72	/	24.84	25.5
			64QAM	23.92	/	23.98	24.5
	36RB	High	QPSK	24.74	/	24.85	25.5
			16QAM	23.73	/	23.87	24.5
			64QAM	22.77	/	22.85	23.5
		Middle	QPSK	24.82	/	24.89	25.5
			16QAM	23.80	/	23.90	24.5
			64QAM	22.77	/	22.85	23.5
		Low	QPSK	24.80	/	24.87	25.5
			16QAM	23.80	/	23.83	24.5
			64QAM	22.77	/	22.79	23.5
	75RB	/	QPSK	24.83	/	24.93	25.5
			16QAM	23.83	/	23.90	24.5
64QAM			22.88	/	22.94	23.5	

<Full Power>

LTE-FDD Band 66				Actual output Power (dBm)			Tune up
Band-width				High	Middle	Low	
1.4 MHz	RB allocation	RB offset	Modulation	1779.3MHz	1745MHz	1710.7MHz	
	1RB	High	QPSK	23.37	23.39	23.22	24.5
			16QAM	22.67	22.65	22.46	23.5
			64QAM	21.46	21.51	21.43	22.5
		Middle	QPSK	23.71	23.60	23.37	24.5
			16QAM	22.79	22.67	22.66	23.5
			64QAM	21.70	21.63	21.62	22.5
		Low	QPSK	23.57	23.33	23.11	24.5
			16QAM	22.86	22.55	22.35	23.5
			64QAM	21.83	21.56	21.33	22.5
	3RB	High	QPSK	23.58	23.65	23.40	24.5
			16QAM	22.56	22.56	22.42	23.5
			64QAM	21.53	21.51	21.40	22.5
		Middle	QPSK	23.72	23.67	23.44	24.5
			16QAM	22.67	22.63	22.40	23.5
			64QAM	21.62	21.60	21.38	22.5
		Low	QPSK	23.70	23.61	23.43	24.5
			16QAM	22.69	22.63	22.41	23.5
			64QAM	21.65	21.53	21.38	22.5
	6RB	/	QPSK	22.67	22.58	22.38	23.5
			16QAM	21.60	21.55	21.38	22.5
			64QAM	20.53	20.50	20.35	21.5

<Full Power>

LTE-FDD Band 66				Actual output Power (dBm)			Tune up
Band-width				High	Middle	Low	
3 MHz	RB allocation	RB offset	Modulation	1778.5MHz	1745MHz	1711.5MHz	
	1RB	High	QPSK	23.54	23.32	23.12	24.5
			16QAM	22.84	22.58	22.36	23.5
			64QAM	21.63	21.44	21.33	22.5
		Middle	QPSK	23.88	23.53	23.27	24.5
			16QAM	22.96	22.60	22.56	23.5
			64QAM	21.87	21.56	21.52	22.5
		Low	QPSK	23.74	23.26	23.01	24.5
			16QAM	23.03	22.48	22.25	23.5
			64QAM	22.00	21.49	21.23	22.5
	8RB	High	QPSK	22.75	22.58	22.30	24.5
			16QAM	21.73	21.49	21.32	23.5
			64QAM	20.70	20.44	20.30	22.5
		Middle	QPSK	22.89	22.60	22.34	24.5
			16QAM	21.84	21.56	21.30	23.5
			64QAM	20.79	20.53	20.28	22.5
		Low	QPSK	22.87	22.54	22.33	24.5
			16QAM	21.86	21.56	21.31	23.5
			64QAM	20.82	20.46	20.28	22.5
	15RB	/	QPSK	22.84	22.51	22.28	23.5
			16QAM	21.77	21.48	21.28	22.5
64QAM			20.70	20.43	20.25	21.5	

<Full Power>

LTE-FDD Band 66				Actual output Power (dBm)			Tune up
Band-width				High	Middle	Low	
5 MHz	RB allocation	RB offset	Modulation	1777.5MHz	1745MHz	1712.5MHz	
	1RB	High	QPSK	23.46	23.34	23.27	24.5
			16QAM	22.76	22.60	22.51	23.5
			64QAM	21.55	21.46	21.48	22.5
		Middle	QPSK	23.80	23.55	23.42	24.5
			16QAM	22.88	22.62	22.71	23.5
			64QAM	21.79	21.58	21.67	22.5
		Low	QPSK	23.66	23.28	23.16	24.5
			16QAM	22.95	22.50	22.40	23.5
			64QAM	21.92	21.51	21.38	22.5
	12RB	High	QPSK	22.67	22.60	22.45	24.5
			16QAM	21.65	21.51	21.47	23.5
			64QAM	20.62	20.46	20.45	22.5
		Middle	QPSK	22.81	22.62	22.49	24.5
			16QAM	21.76	21.58	21.45	23.5
			64QAM	20.71	20.55	20.43	22.5
		Low	QPSK	22.79	22.56	22.48	24.5
			16QAM	21.78	21.58	21.46	23.5
			64QAM	20.74	20.48	20.43	22.5
	25RB	/	QPSK	22.76	22.53	22.43	23.5
			16QAM	21.69	21.50	21.43	22.5
			64QAM	20.62	20.45	20.40	21.5

<Full Power>

LTE-FDD Band 66				Actual output Power (dBm)			Tune up
Band-width				High	Middle	Low	
10 MHz	RB allocation	RB offset	Modulation	1775MHz	1745MHz	1715MHz	
	1RB	High	QPSK	23.40	23.36	23.22	24.5
			16QAM	22.70	22.62	22.46	23.5
			64QAM	21.49	21.48	21.43	22.5
		Middle	QPSK	23.74	23.57	23.37	24.5
			16QAM	22.82	22.64	22.66	23.5
			64QAM	21.73	21.60	21.62	22.5
		Low	QPSK	23.60	23.30	23.11	24.5
			16QAM	22.89	22.52	22.35	23.5
			64QAM	21.86	21.53	21.33	22.5
	25RB	High	QPSK	22.61	22.62	22.40	24.5
			16QAM	21.59	21.53	21.42	23.5
			64QAM	20.56	20.48	20.40	22.5
		Middle	QPSK	22.75	22.64	22.44	24.5
			16QAM	21.70	21.60	21.40	23.5
			64QAM	20.65	20.57	20.38	22.5
		Low	QPSK	22.73	22.58	22.43	24.5
			16QAM	21.72	21.60	21.41	23.5
			64QAM	20.68	20.50	20.38	22.5
	50RB	/	QPSK	22.70	22.55	22.38	23.5
			16QAM	21.63	21.52	21.38	22.5
			64QAM	20.56	20.47	20.35	21.5

<Full Power>

LTE-FDD Band 66				Actual output Power (dBm)			Tune up
Band-width				High	Middle	Low	
15 MHz	RB allocation	RB offset	Modulation	1772.5MHz	1745MHz	1717.5MHz	
	1RB	High	QPSK	23.38	23.32	23.24	24.5
			16QAM	22.64	22.62	22.48	23.5
			64QAM	21.50	21.41	21.45	22.5
		Middle	QPSK	23.59	23.66	23.39	24.5
			16QAM	22.66	22.74	22.68	23.5
			64QAM	21.62	21.65	21.64	22.5
		Low	QPSK	23.32	23.52	23.13	24.5
			16QAM	22.54	22.81	22.37	23.5
			64QAM	21.55	21.78	21.35	22.5
	36RB	High	QPSK	22.64	22.53	22.42	24.5
			16QAM	21.55	21.51	21.44	23.5
			64QAM	20.50	20.48	20.42	22.5
		Middle	QPSK	22.66	22.67	22.46	24.5
			16QAM	21.62	21.62	21.42	23.5
			64QAM	20.59	20.57	20.40	22.5
		Low	QPSK	22.60	22.65	22.45	24.5
			16QAM	21.62	21.64	21.43	23.5
			64QAM	20.52	20.60	20.40	22.5
	75RB	/	QPSK	22.57	22.62	22.40	23.5
			16QAM	21.54	21.55	21.40	22.5
64QAM			20.49	20.48	20.37	21.5	

<Full Power>

LTE-FDD Band 66				Actual output Power (dBm)			Tune up
Band-width				High	Middle	Low	
20 MHz	RB allocation	RB offset	Modulation	1770MHz	1745MHz	1720MHz	
	1RB	High	QPSK	23.43	23.35	23.18	24.5
			16QAM	22.73	22.61	22.42	23.5
			64QAM	21.52	21.47	21.39	22.5
		Middle	QPSK	23.77	23.56	23.33	24.5
			16QAM	22.85	22.63	22.62	23.5
			64QAM	21.76	21.59	21.58	22.5
		Low	QPSK	23.63	23.29	23.07	24.5
			16QAM	22.92	22.51	22.31	23.5
			64QAM	21.89	21.52	21.29	22.5
	36RB	High	QPSK	22.64	22.61	22.36	24.5
			16QAM	21.62	21.52	21.38	23.5
			64QAM	20.59	20.47	20.36	22.5
		Middle	QPSK	22.78	22.63	22.40	24.5
			16QAM	21.73	21.59	21.36	23.5
			64QAM	20.68	20.56	20.34	22.5
		Low	QPSK	22.76	22.57	22.39	24.5
			16QAM	21.75	21.59	21.37	23.5
			64QAM	20.71	20.49	20.34	22.5
	75RB	/	QPSK	22.73	22.54	22.34	23.5
			16QAM	21.66	21.51	21.34	22.5
			64QAM	20.59	20.46	20.31	21.5

<Full Power> / < Hotspot on >

LTE-FDD Band 71				Actual output Power (dBm)			Tune up
Band-width				High	Middle	Low	
5 MHz	RB allocation	RB offset	Modulation	695.5MHz	680.5MHz	665.5MHz	
	1RB	High	QPSK	22.93	22.84	23.01	24
			16QAM	22.45	22.24	22.33	23
			64QAM	21.71	21.45	21.61	22
		Middle	QPSK	23.19	23.09	23.27	24
			16QAM	22.55	22.39	22.61	23
			64QAM	22.79	22.60	21.73	22
		Low	QPSK	22.99	22.88	23.10	24
			16QAM	22.45	22.27	22.34	23
			64QAM	21.79	22.55	21.56	22
	12RB	High	QPSK	22.01	21.94	22.14	23
			16QAM	21.02	20.98	21.17	22
			64QAM	20.04	20.03	20.14	21
		Middle	QPSK	22.05	22.06	22.18	23
			16QAM	21.14	21.09	21.15	22
			64QAM	20.13	20.07	20.16	21
		Low	QPSK	22.04	21.96	22.01	23
			16QAM	21.09	21.00	20.96	22
			64QAM	20.06	20.02	20.01	21
	25RB	/	QPSK	22.00	21.97	22.10	23
			16QAM	21.02	20.99	21.13	22
			64QAM	20.04	20.02	20.09	21

<Full Power> / < Hotspot on >

LTE-FDD Band 71				Actual output Power (dBm)			Tune up
Band-width				High	Middle	Low	
10 MHz	RB allocation	RB offset	Modulation	693MHz	680.5MHz	668MHz	
	1RB	High	QPSK	22.86	22.90	22.93	24
			16QAM	22.38	22.30	22.25	23
			64QAM	21.64	21.51	21.53	22
		Middle	QPSK	23.12	23.15	23.19	24
			16QAM	22.48	22.45	22.53	23
			64QAM	22.72	22.66	21.65	22
		Low	QPSK	22.92	22.94	23.02	24
			16QAM	22.38	22.33	22.26	23
			64QAM	21.72	22.61	21.48	22
	25RB	High	QPSK	21.94	22.00	22.06	23
			16QAM	20.95	21.04	21.09	22
			64QAM	19.97	20.09	20.06	21
		Middle	QPSK	21.98	22.12	22.10	23
			16QAM	21.07	21.15	21.07	22
			64QAM	20.06	20.13	20.08	21
		Low	QPSK	21.97	22.02	21.93	23
			16QAM	21.02	21.06	20.88	22
			64QAM	19.99	20.08	19.93	21
	50RB	/	QPSK	21.93	22.03	22.02	23
			16QAM	20.95	21.05	21.05	22
			64QAM	19.97	20.08	20.01	21

<Full Power> / < Hotspot on >

LTE-FDD Band 71				Actual output Power (dBm)			Tune up
Band-width				High	Middle	Low	
15 MHz	RB allocation	RB offset	Modulation	690.5MHz	680.5MHz	670.5MHz	
	1RB	High	QPSK	22.87	22.88	22.95	24
			16QAM	22.39	22.28	22.27	23
			64QAM	21.65	21.49	21.55	22
		Middle	QPSK	23.13	23.13	23.21	24
			16QAM	22.49	22.43	22.55	23
			64QAM	22.73	22.64	21.67	22
		Low	QPSK	22.93	22.92	23.04	24
			16QAM	22.39	22.31	22.28	23
			64QAM	21.73	22.59	21.50	22
	36RB	High	QPSK	21.95	21.98	22.08	23
			16QAM	20.96	21.02	21.11	22
			64QAM	19.98	20.07	20.08	21
		Middle	QPSK	21.99	22.10	22.12	23
			16QAM	21.08	21.13	21.09	22
			64QAM	20.07	20.11	20.10	21
		Low	QPSK	21.98	22.00	21.95	23
			16QAM	21.03	21.04	20.90	22
			64QAM	20.00	20.06	19.95	21
	75RB	/	QPSK	21.94	22.01	22.04	23
			16QAM	20.96	21.03	21.07	22
			64QAM	19.98	20.06	20.03	21

<Full Power> / < Hotspot on >

Band-width	LTE-FDD Band 71			Actual output Power (dBm)			Tune up	
	RB allocation	RB offset	Modulation	High	Middle	Low		
20 MHz	1RB	High	QPSK	688MHz	683MHz	673MHz	24	
			16QAM	22.90	22.86	22.99	23	
			64QAM	22.42	22.26	22.31	22	
		Middle	QPSK	21.68	21.47	21.59	24	
			16QAM	23.16	23.11	23.25	23	
			64QAM	22.52	22.41	22.59	22	
		Low	QPSK	22.76	22.62	21.71	24	
			16QAM	22.96	22.90	23.08	23	
			64QAM	22.42	22.29	22.32	22	
	36RB	High	QPSK	21.76	22.57	21.54	23	
			16QAM	21.98	21.96	22.12	22	
			64QAM	20.99	21.00	21.15	21	
		Middle	QPSK	20.01	20.05	20.12	23	
			16QAM	22.02	22.08	22.16	22	
			64QAM	21.11	21.11	21.13	21	
		Low	QPSK	20.10	20.09	20.14	23	
			16QAM	22.01	21.98	21.99	22	
			64QAM	21.06	21.02	20.94	21	
	75RB	/	QPSK	20.03	20.04	19.99	23	
			16QAM	21.97	21.99	22.08	22	
			64QAM	20.99	21.01	21.11	21	
				QPSK	20.01	20.04	20.07	21

< Hotspot on >

Band-width	LTE-FDD Band 2			Actual output Power (dBm)			Tune up
	RB allocation	RB offset	Modulation	High	Middle	Low	
1.4 MHz				1909.3MHz	1880MHz	1850.7MHz	
	1RB	High	QPSK	18.24	18.31	18.36	19
			16QAM	18.52	18.69	18.68	19
			64QAM	18.52	18.69	18.68	19
		Middle	QPSK	18.37	18.42	18.48	19
			16QAM	18.72	18.76	18.78	19
			64QAM	18.71	18.76	18.77	19
		Low	QPSK	18.25	18.31	18.36	19
			16QAM	18.57	18.66	18.69	19
			64QAM	18.57	18.66	18.69	19
	3RB	High	QPSK	18.35	18.42	18.45	19
			16QAM	18.37	18.48	18.51	19
			64QAM	18.37	18.47	18.50	19
		Middle	QPSK	18.39	18.45	18.50	19
			16QAM	18.43	18.51	18.56	19
			64QAM	18.43	18.50	18.57	19
		Low	QPSK	18.33	18.41	18.44	19
			16QAM	18.39	18.44	18.52	19
			64QAM	18.39	18.43	18.51	19
	6RB	/	QPSK	18.35	18.41	18.47	19
			16QAM	18.47	18.52	18.58	19
			64QAM	18.47	18.53	18.57	19

< Hotspot on >

Band-width	LTE-FDD Band 2			Actual output Power (dBm)			Tune up
	RB allocation	RB offset	Modulation	High	Middle	Low	
3 MHz				1908.5MHz	1880MHz	1851.5MHz	
	1RB	High	QPSK	18.32	18.41	18.39	19
			16QAM	18.66	18.70	18.75	19
			64QAM	18.66	18.70	18.74	19
		Middle	QPSK	18.51	18.54	18.54	19
			16QAM	18.82	18.88	18.86	19
			64QAM	18.82	18.87	18.87	19
		Low	QPSK	18.36	18.43	18.46	19
			16QAM	18.73	18.74	18.82	19
			64QAM	18.74	18.73	18.82	19
	8RB	High	QPSK	18.35	18.41	18.42	19
			16QAM	18.43	18.49	18.53	19
			64QAM	18.44	18.50	18.54	19
		Middle	QPSK	18.40	18.45	18.49	19
			16QAM	18.50	18.55	18.61	19
			64QAM	18.49	18.56	18.61	19
		Low	QPSK	18.36	18.42	18.46	19
			16QAM	18.46	18.48	18.58	19
			64QAM	18.46	18.48	18.58	19
	15RB	/	QPSK	18.37	18.43	18.46	19
			16QAM	18.40	18.45	18.54	19
			64QAM	18.39	18.45	18.54	19

< Hotspot on >

Band-width	LTE-FDD Band 2			Actual output Power (dBm)			Tune up
	RB allocation	RB offset	Modulation	High	Middle	Low	
5 MHz				1907.5MHz	1880MHz	1852.5MHz	
	1RB	High	QPSK	18.21	18.30	18.27	19
			16QAM	18.55	18.60	18.64	19
			64QAM	18.56	18.60	18.64	19
		Middle	QPSK	18.47	18.57	18.55	19
			16QAM	18.83	18.89	19.01	19
			64QAM	18.83	18.89	19.02	19
		Low	QPSK	18.29	18.28	18.35	19
			16QAM	18.66	18.67	18.71	19
			64QAM	18.67	18.67	18.72	19
	12RB	High	QPSK	18.34	18.44	18.45	19
			16QAM	18.36	18.43	18.46	19
			64QAM	18.36	18.44	18.45	19
		Middle	QPSK	18.39	18.47	18.48	19
			16QAM	18.46	18.48	18.53	19
			64QAM	18.46	18.48	18.53	19
		Low	QPSK	18.42	18.41	18.45	19
			16QAM	18.44	18.41	18.46	19
			64QAM	18.43	18.42	18.46	19
	25RB	/	QPSK	18.39	18.44	18.42	19
			16QAM	18.39	18.45	18.48	19
			64QAM	18.40	18.44	18.48	19

< Hotspot on >

Band-width	LTE-FDD Band 2			Actual output Power (dBm)			Tune up	
	RB allocation	RB offset	Modulation	High	Middle	Low		
10 MHz	1RB	High	QPSK	1905MHz	1880MHz	1855MHz	19	
			16QAM	18.25	18.43	18.39	19	
			64QAM	18.59	18.79	18.75	19	
		Middle	QPSK	18.59	18.78	18.76	19	
			16QAM	18.49	18.57	18.57	19	
			64QAM	18.84	18.90	18.92	19	
		Low	QPSK	18.83	18.91	18.92	19	
			16QAM	18.37	18.46	18.49	19	
			64QAM	18.73	18.78	18.89	19	
	25RB	High	QPSK	18.72	18.79	18.90	19	
			16QAM	18.38	18.57	18.57	19	
			64QAM	18.40	18.59	18.57	19	
		Middle	QPSK	18.40	18.58	18.58	19	
			16QAM	18.43	18.58	18.56	19	
			64QAM	18.45	18.60	18.57	19	
		Low	QPSK	18.45	18.60	18.58	19	
			16QAM	18.48	18.58	18.57	19	
			64QAM	18.51	18.57	18.55	19	
	50RB	/	QPSK	18.51	18.57	18.55	19	
			16QAM	18.43	18.57	18.56	19	
			64QAM	18.47	18.57	18.54	19	
				64QAM	18.47	18.57	18.53	19

< Hotspot on >

Band-width	LTE-FDD Band 2			Actual output Power (dBm)			Tune up
	RB allocation	RB offset	Modulation	High	Middle	Low	
15 MHz	1RB	High	QPSK	1902.5MHz	1880MHz	1857.5MHz	19
			16QAM	18.19	18.35	18.33	19
			64QAM	18.46	18.67	18.69	19
		Middle	QPSK	18.47	18.68	18.69	19
			16QAM	18.38	18.49	18.48	19
			64QAM	18.72	18.79	18.79	19
		Low	QPSK	18.71	18.78	18.79	19
			16QAM	18.34	18.44	18.50	19
			64QAM	18.67	18.77	18.89	19
	36RB	High	QPSK	18.68	18.78	18.89	19
			16QAM	18.35	18.52	18.49	19
			64QAM	18.35	18.51	18.51	19
		Middle	QPSK	18.36	18.52	18.51	19
			16QAM	18.46	18.54	18.57	19
			64QAM	18.44	18.57	18.57	19
		Low	QPSK	18.44	18.57	18.56	19
			16QAM	18.44	18.53	18.57	19
			64QAM	18.46	18.57	18.55	19
	75RB	/	QPSK	18.45	18.57	18.56	19
			16QAM	18.42	18.53	18.55	19
			64QAM	18.43	18.55	18.55	19

< Hotspot on >

Band-width	LTE-FDD Band 2			Actual output Power (dBm)			Tune up
	RB allocation	RB offset	Modulation	High	Middle	Low	
20 MHz	1RB	High	QPSK	1900MHz	1880MHz	1860MHz	19
			16QAM	18.11	18.16	18.19	19
			64QAM	18.50	18.56	18.56	19
		Middle	QPSK	18.44	18.50	18.52	19
			16QAM	18.80	18.80	18.84	19
			64QAM	18.80	18.81	18.85	19
		Low	QPSK	18.28	18.30	18.39	19
			16QAM	18.66	18.66	18.73	19
			64QAM	18.65	18.67	18.74	19
	36RB	High	QPSK	18.31	18.37	18.39	19
			16QAM	18.31	18.37	18.38	19
			64QAM	18.30	18.38	18.38	19
		Middle	QPSK	18.42	18.47	18.50	19
			16QAM	18.40	18.50	18.51	19
			64QAM	18.40	18.50	18.52	19
		Low	QPSK	18.46	18.48	18.48	19
			16QAM	18.45	18.50	18.44	19
			64QAM	18.45	18.49	18.45	19
	75RB	/	QPSK	18.35	18.42	18.42	19
			16QAM	18.38	18.42	18.41	19
			64QAM	18.39	18.43	18.41	19

< Hotspot on >

Band-width	LTE-FDD Band 4			Actual output Power (dBm)			Tune up
	RB allocation	RB offset	Modulation	High	Middle	Low	
1.4 MHz				1754.3MHz	1732.5MHz	1710.7MHz	
	1RB	High	QPSK	19.00	18.91	18.88	20
			16QAM	19.30	19.19	19.20	20
			64QAM	19.30	19.21	19.22	20
		Middle	QPSK	19.11	19.00	19.00	20
			16QAM	19.42	19.30	19.33	20
			64QAM	19.42	19.28	19.32	20
		Low	QPSK	18.99	18.90	18.87	20
			16QAM	19.28	19.23	19.22	20
			64QAM	19.28	19.20	19.26	20
	3RB	High	QPSK	19.12	19.02	18.99	20
			16QAM	19.11	19.01	19.03	20
			64QAM	19.12	19.03	19.03	20
		Middle	QPSK	19.17	19.06	19.04	20
			16QAM	19.17	19.09	19.07	20
			64QAM	19.18	19.09	19.07	20
		Low	QPSK	19.10	19.01	18.96	20
			16QAM	19.11	19.03	18.99	20
			64QAM	19.11	19.03	19.00	20
	6RB	/	QPSK	19.11	18.99	18.99	20
			16QAM	19.18	19.11	19.09	20
			64QAM	19.19	19.15	19.12	20

< Hotspot on >

Band-width	LTE-FDD Band 4			Actual output Power (dBm)			Tune up
	RB allocation	RB offset	Modulation	High	Middle	Low	
3 MHz				1753.5MHz	1732.5MHz	1711.5MHz	
	1RB	High	QPSK	19.09	18.97	18.94	20
			16QAM	19.45	19.25	19.26	20
			64QAM	19.44	19.26	19.26	20
		Middle	QPSK	19.26	19.12	19.13	20
			16QAM	19.54	19.44	19.44	20
			64QAM	19.54	19.42	19.43	20
		Low	QPSK	19.07	19.01	18.98	20
			16QAM	19.40	19.34	19.32	20
			64QAM	19.41	19.35	19.37	20
	8RB	High	QPSK	19.11	19.03	19.01	20
			16QAM	19.17	19.09	19.08	20
			64QAM	19.17	19.11	19.09	20
		Middle	QPSK	19.13	19.01	19.02	20
			16QAM	19.20	19.10	19.11	20
			64QAM	19.21	19.11	19.14	20
		Low	QPSK	19.09	19.05	19.00	20
			16QAM	19.19	19.10	19.07	20
			64QAM	19.19	19.10	19.05	20
	15RB	/	QPSK	19.10	19.04	18.99	20
			16QAM	19.12	19.07	19.02	20
			64QAM	19.12	19.08	19.03	20

< Hotspot on >

Band-width	LTE-FDD Band 4			Actual output Power (dBm)			Tune up
	RB allocation	RB offset	Modulation	High	Middle	Low	
5 MHz				1752.5MHz	1732.5MHz	1712.5MHz	
	1RB	High	QPSK	18.98	18.88	18.85	20
			16QAM	19.30	19.21	19.22	20
			64QAM	19.32	19.25	19.22	20
		Middle	QPSK	19.22	19.15	19.08	20
			16QAM	19.54	19.51	19.40	20
			64QAM	19.57	19.50	19.38	20
		Low	QPSK	18.97	18.90	18.89	20
			16QAM	19.26	19.25	19.23	20
			64QAM	19.28	19.25	19.26	20
	12RB	High	QPSK	19.11	19.03	18.95	20
			16QAM	19.09	19.02	18.99	20
			64QAM	19.11	19.02	19.03	20
		Middle	QPSK	19.15	19.10	19.07	20
			16QAM	19.17	19.13	19.07	20
			64QAM	19.17	19.16	19.08	20
		Low	QPSK	19.10	19.04	18.99	20
			16QAM	19.11	19.04	18.99	20
			64QAM	19.12	19.05	19.01	20
	25RB	/	QPSK	19.12	19.04	19.00	20
			16QAM	19.14	19.06	19.01	20
			64QAM	19.16	19.07	19.03	20

< Hotspot on >

LTE-FDD Band 4				Actual output Power (dBm)			Tune up
Band-width				High	Middle	Low	
10 MHz	RB allocation	RB offset	Modulation	1750MHz	1732.5MHz	1715MHz	
	1RB	High	QPSK	19.07	19.01	18.97	20
			16QAM	19.36	19.32	19.29	20
			64QAM	19.36	19.31	19.25	20
		Middle	QPSK	19.24	19.13	19.12	20
			16QAM	19.54	19.42	19.41	20
			64QAM	19.55	19.47	19.42	20
		Low	QPSK	19.08	19.05	19.01	20
			16QAM	19.36	19.35	19.30	20
			64QAM	19.37	19.35	19.31	20
	25RB	High	QPSK	19.14	19.12	19.04	20
			16QAM	19.14	19.13	19.03	20
			64QAM	19.14	19.13	19.04	20
		Middle	QPSK	19.18	19.13	19.08	20
			16QAM	19.15	19.13	19.08	20
			64QAM	19.16	19.13	19.08	20
		Low	QPSK	19.21	19.12	19.11	20
			16QAM	19.19	19.11	19.09	20
			64QAM	19.20	19.15	19.11	20
	50RB	/	QPSK	19.18	19.14	19.05	20
			16QAM	19.16	19.13	19.05	20
			64QAM	19.17	19.16	19.06	20

< Hotspot on >

Band-width	LTE-FDD Band 4			Actual output Power (dBm)			Tune up
	RB allocation	RB offset	Modulation	High	Middle	Low	
15 MHz				1747.5MHz	1732.5MHz	1717.5MHz	
	1RB	High	QPSK	18.95	18.92	18.93	20
			16QAM	19.29	19.21	19.26	20
			64QAM	19.31	19.22	19.27	20
		Middle	QPSK	19.06	19.03	19.02	20
			16QAM	19.35	19.39	19.35	20
			64QAM	19.37	19.38	19.35	20
		Low	QPSK	19.00	18.99	18.98	20
			16QAM	19.34	19.27	19.32	20
			64QAM	19.36	19.25	19.30	20
	36RB	High	QPSK	19.07	19.05	19.04	20
			16QAM	19.04	19.03	19.02	20
			64QAM	19.06	19.03	19.00	20
		Middle	QPSK	19.14	19.12	19.07	20
			16QAM	19.11	19.10	19.07	20
			64QAM	19.11	19.13	19.07	20
		Low	QPSK	19.10	19.09	19.08	20
			16QAM	19.09	19.06	19.07	20
			64QAM	19.11	19.08	19.81	20
	75RB	/	QPSK	19.10	19.06	19.05	20
			16QAM	19.11	19.07	19.05	20
			64QAM	19.12	19.07	19.05	20

< Hotspot on >

Band-width	LTE-FDD Band 4			Actual output Power (dBm)			Tune up
	RB allocation	RB offset	Modulation	High	Middle	Low	
20 MHz				1745MHz	1732.5MHz	1720MHz	
	1RB	High	QPSK	18.86	18.84	18.93	20
			16QAM	19.17	19.10	19.25	20
			64QAM	19.19	19.11	19.27	20
		Middle	QPSK	19.11	19.12	19.21	20
			16QAM	19.36	19.47	19.54	20
			64QAM	19.37	19.43	19.51	20
		Low	QPSK	18.97	19.04	19.06	20
			16QAM	19.27	19.34	19.42	20
			64QAM	19.26	19.37	19.44	20
	36RB	High	QPSK	18.94	19.05	19.13	20
			16QAM	18.97	19.07	19.16	20
			64QAM	18.95	19.08	19.19	20
		Middle	QPSK	19.09	19.13	19.15	20
			16QAM	19.09	19.15	19.22	20
			64QAM	19.10	19.15	19.21	20
		Low	QPSK	19.11	19.12	19.21	20
			16QAM	19.10	19.15	19.26	20
			64QAM	19.10	19.16	19.26	20
	75RB	/	QPSK	19.03	19.10	19.16	20
			16QAM	19.03	19.12	19.18	20
			64QAM	19.03	19.12	19.17	20

< Hotspot on >

LTE-FDD Band 25				Actual output Power (dBm)			Tune up
Band-width				High	Middle	Low	
1.4 MHz	RB allocation	RB offset	Modulation	1914.3MHz	1882.5MHz	1850.7MHz	
	1RB	High	QPSK	18.08	18.22	18.21	19
			16QAM	18.39	18.53	18.53	19
			64QAM	18.39	18.54	18.53	19
		Middle	QPSK	18.19	18.32	18.30	19
			16QAM	18.52	18.61	18.65	19
			64QAM	18.51	18.62	18.65	19
		Low	QPSK	18.06	18.22	18.23	19
			16QAM	18.46	18.53	18.54	19
			64QAM	18.46	18.54	18.53	19
	3RB	High	QPSK	18.15	18.30	18.30	19
			16QAM	18.22	18.35	18.35	19
			64QAM	18.21	18.35	18.35	19
		Middle	QPSK	18.22	18.33	18.35	19
			16QAM	18.29	18.39	18.39	19
			64QAM	18.28	18.40	18.40	19
		Low	QPSK	18.17	18.28	18.29	19
			16QAM	18.21	18.33	18.33	19
			64QAM	18.21	18.34	18.33	19
	6RB	/	QPSK	18.21	18.29	18.31	19
			16QAM	18.30	18.42	18.43	19
			64QAM	18.30	18.42	18.43	19

< Hotspot on >

LTE-FDD Band 25				Actual output Power (dBm)			Tune up
Band-width				High	Middle	Low	
3 MHz	RB allocation	RB offset	Modulation	1913.5MHz	1882.5MHz	1851.5MHz	
	1RB	High	QPSK	18.18	18.32	18.29	19
			16QAM	18.49	18.62	18.62	19
			64QAM	18.49	18.62	18.61	19
		Middle	QPSK	18.38	18.44	18.48	19
			16QAM	18.69	18.75	18.84	19
			64QAM	18.70	18.75	18.84	19
		Low	QPSK	18.21	18.30	18.33	19
			16QAM	18.57	18.64	18.69	19
			64QAM	18.56	18.65	18.69	19
	8RB	High	QPSK	18.22	18.34	18.35	19
			16QAM	18.32	18.43	18.45	19
			64QAM	18.33	18.43	18.45	19
		Middle	QPSK	18.26	18.37	18.38	19
			16QAM	18.34	18.47	18.50	19
			64QAM	18.35	18.47	18.49	19
		Low	QPSK	18.22	18.34	18.34	19
			16QAM	18.35	18.45	18.44	19
			64QAM	18.35	18.45	18.43	19
	15RB	/	QPSK	18.22	18.33	18.35	19
			16QAM	18.30	18.38	18.39	19
			64QAM	18.29	18.37	18.40	19

< Hotspot on >

LTE-FDD Band 25				Actual output Power (dBm)			Tune up
Band-width				High	Middle	Low	
5 MHz	RB allocation	RB offset	Modulation	1912.5MHz	1882.5MHz	1852.5MHz	
	1RB	High	QPSK	18.06	18.20	18.17	19
			16QAM	18.41	18.53	18.51	19
			64QAM	18.40	18.53	18.51	19
		Middle	QPSK	18.33	18.50	18.46	19
			16QAM	18.72	18.84	18.82	19
			64QAM	18.72	18.84	18.83	19
		Low	QPSK	18.11	18.21	18.23	19
			16QAM	18.45	18.51	18.58	19
			64QAM	18.45	18.52	18.57	19
	12RB	High	QPSK	18.14	18.34	18.34	19
			16QAM	18.15	18.37	18.37	19
			64QAM	18.15	18.37	18.37	19
		Middle	QPSK	18.28	18.40	18.41	19
			16QAM	18.28	18.41	18.45	19
			64QAM	18.28	18.42	18.45	19
		Low	QPSK	18.28	18.32	18.33	19
			16QAM	18.30	18.34	18.33	19
			64QAM	18.30	18.35	18.32	19
	25RB	/	QPSK	18.23	18.35	18.38	19
			16QAM	18.25	18.37	18.38	19
			64QAM	18.25	18.37	18.37	19

< Hotspot on >

LTE-FDD Band 25				Actual output Power (dBm)			Tune up
Band-width				High	Middle	Low	
10 MHz	RB allocation	RB offset	Modulation	1910MHz	1882.5MHz	1855MHz	
	1RB	High	QPSK	18.10	18.36	18.37	19
			16QAM	18.46	18.70	18.72	19
			64QAM	18.46	18.70	18.71	19
		Middle	QPSK	18.29	18.52	18.51	19
			16QAM	18.64	18.83	18.87	19
			64QAM	18.65	18.83	18.88	19
		Low	QPSK	18.27	18.40	18.42	19
			16QAM	18.62	18.72	18.79	19
			64QAM	18.62	18.72	18.80	19
	25RB	High	QPSK	18.14	18.46	18.48	19
			16QAM	18.16	18.48	18.51	19
			64QAM	18.16	18.47	18.51	19
		Middle	QPSK	18.29	18.48	18.49	19
			16QAM	18.31	18.51	18.51	19
			64QAM	18.31	18.50	18.52	19
		Low	QPSK	18.34	18.46	18.47	19
			16QAM	18.37	18.49	18.48	19
			64QAM	18.36	18.49	18.49	19
	50RB	/	QPSK	18.28	18.49	18.48	19
			16QAM	18.30	18.51	18.49	19
			64QAM	18.29	18.51	18.48	19

< Hotspot on >

LTE-FDD Band 25				Actual output Power (dBm)			Tune up
Band-width				High	Middle	Low	
15 MHz	RB allocation	RB offset	Modulation	1907.5MHz	1882.5MHz	1857.5MHz	
	1RB	High	QPSK	18.05	18.29	18.30	19
			16QAM	18.40	18.63	18.59	19
			64QAM	18.40	18.62	18.60	19
		Middle	QPSK	18.27	18.43	18.46	19
			16QAM	18.61	18.77	18.76	19
			64QAM	18.61	18.77	18.76	19
		Low	QPSK	18.22	18.35	18.41	19
			16QAM	18.53	18.70	18.77	19
			64QAM	18.52	18.71	18.77	19
	36RB	High	QPSK	18.16	18.45	18.47	19
			16QAM	18.16	18.43	18.48	19
			64QAM	18.15	18.43	18.49	19
		Middle	QPSK	18.29	18.49	18.51	19
			16QAM	18.32	18.49	18.50	19
			64QAM	18.31	18.50	18.49	19
		Low	QPSK	18.36	18.47	18.52	19
			16QAM	18.35	18.47	18.51	19
			64QAM	18.36	18.47	18.51	19
	75RB	/	QPSK	18.27	18.45	18.48	19
			16QAM	18.29	18.47	18.47	19
64QAM			18.29	18.47	18.48	19	

< Hotspot on >

LTE-FDD Band 25				Actual output Power (dBm)			Tune up
Band-width				High	Middle	Low	
20 MHz	RB allocation	RB offset	Modulation	1905MHz	1882.5MHz	1860MHz	
	1RB	High	QPSK	17.98	18.14	18.10	19
			16QAM	18.35	18.50	18.45	19
			64QAM	18.34	18.50	18.44	19
		Middle	QPSK	18.38	18.43	18.46	19
			16QAM	18.69	18.79	18.81	19
			64QAM	18.70	18.78	18.81	19
		Low	QPSK	18.27	18.25	18.28	19
			16QAM	18.63	18.64	18.59	19
			64QAM	18.64	18.63	18.59	19
	36RB	High	QPSK	18.15	18.36	18.36	19
			16QAM	18.16	18.33	18.37	19
			64QAM	18.17	18.33	18.38	19
		Middle	QPSK	18.34	18.43	18.46	19
			16QAM	18.36	18.41	18.48	19
			64QAM	18.35	18.42	18.48	19
		Low	QPSK	18.41	18.41	18.40	19
			16QAM	18.44	18.39	18.42	19
			64QAM	18.44	18.40	18.41	19
	75RB	/	QPSK	18.25	18.38	18.39	19
			16QAM	18.30	18.36	18.39	19
			64QAM	18.30	18.37	18.38	19

< Hotspot on >- PC3

LTE-FDD Band 41				Actual output Power (dBm)			Tune up
Band-width				High	Middle	Low	
5 MHz	RB allocation	RB offset	Modulation	2687.5MHz	2593MHz	2498.5MHz	
	1RB	High	QPSK	19.64	19.62	19.68	21
			16QAM	19.74	19.73	19.78	21
			64QAM	19.75	19.74	19.79	21
		Middle	QPSK	19.87	19.87	19.91	21
			16QAM	19.97	19.99	20.03	21
			64QAM	19.98	19.89	20.02	21
		Low	QPSK	19.63	19.64	19.68	21
			16QAM	19.73	19.77	19.78	21
			64QAM	19.72	19.75	19.75	21
	12RB	High	QPSK	19.72	19.72	19.76	21
			16QAM	19.73	19.72	19.75	21
			64QAM	19.73	19.71	19.74	21
		Middle	QPSK	19.81	19.80	19.84	21
			16QAM	19.78	19.79	19.79	21
			64QAM	19.79	19.78	19.82	21
		Low	QPSK	19.73	19.76	19.77	21
			16QAM	19.74	19.75	19.76	21
			64QAM	19.75	19.75	19.76	21
	25RB	/	QPSK	19.70	19.76	19.77	21
			16QAM	19.77	19.79	19.83	21
			64QAM	19.75	19.79	19.81	21

< Hotspot on >- PC3

LTE-FDD Band 41				Actual output Power (dBm)			Tune up
Band-width				High	Middle	Low	
10 MHz	RB allocation	RB offset	Modulation	2685MHz	2593MHz	2501MHz	
	1RB	High	QPSK	19.78	19.77	19.80	21
			16QAM	19.87	19.88	19.92	21
			64QAM	19.87	19.89	19.90	21
		Middle	QPSK	19.88	19.86	19.91	21
			16QAM	19.97	19.99	20.02	21
			64QAM	19.99	20.02	20.03	21
		Low	QPSK	19.75	19.76	19.78	21
			16QAM	19.86	19.87	19.88	21
			64QAM	19.85	19.89	19.88	21
	25RB	High	QPSK	19.80	19.82	19.85	21
			16QAM	19.85	19.87	19.90	21
			64QAM	19.84	19.84	19.89	21
		Middle	QPSK	19.82	19.82	19.87	21
			16QAM	19.89	19.84	19.89	21
			64QAM	19.90	19.84	19.85	21
		Low	QPSK	19.82	19.81	19.82	21
			16QAM	19.87	19.90	19.90	21
			64QAM	19.89	19.90	19.88	21
	50RB	/	QPSK	19.88	19.88	19.90	21
			16QAM	19.90	19.91	19.89	21
			64QAM	19.91	19.91	19.89	21

< Hotspot on >- PC3

LTE-FDD Band 41				Actual output Power (dBm)			Tune up
Band-width				High	Middle	Low	
15 MHz	RB allocation	RB offset	Modulation	2682.5MHz	2593MHz	2503.5MHz	
	1RB	High	QPSK	19.67	19.66	19.74	21
			16QAM	19.78	19.77	19.81	21
			64QAM	19.75	19.75	19.80	21
		Middle	QPSK	19.78	19.74	19.76	21
			16QAM	19.86	19.86	19.89	21
			64QAM	19.87	19.88	19.88	21
		Low	QPSK	19.64	19.68	19.69	21
			16QAM	19.76	19.79	19.80	21
			64QAM	19.74	19.79	19.83	21
	36RB	High	QPSK	19.76	19.78	19.81	21
			16QAM	19.71	19.74	19.78	21
			64QAM	19.78	19.72	19.80	21
		Middle	QPSK	19.75	19.81	19.85	21
			16QAM	19.75	19.78	19.80	21
			64QAM	19.75	19.75	19.79	21
		Low	QPSK	19.80	19.75	19.77	21
			16QAM	19.75	19.72	19.73	21
			64QAM	19.78	19.73	19.77	21
	75RB	/	QPSK	19.74	19.75	19.80	21
			16QAM	19.83	19.79	19.83	21
			64QAM	19.80	19.80	19.83	21

< Hotspot on >- PC3

LTE-FDD Band 41				Actual output Power (dBm)			Tune up
Band-width				High	Middle	Low	
20 MHz	RB allocation	RB offset	Modulation	2680MHz	2593MHz	2506MHz	
	1RB	High	QPSK	19.57	19.66	19.78	21
			16QAM	19.67	19.76	19.89	21
			64QAM	19.67	19.75	19.88	21
		Middle	QPSK	19.80	19.92	20.11	21
			16QAM	19.93	20.04	20.13	21
			64QAM	19.91	20.08	20.09	21
		Low	QPSK	19.67	19.76	19.80	21
			16QAM	19.76	19.85	19.91	21
			64QAM	19.76	19.85	19.92	21
	36RB	High	QPSK	19.77	19.84	19.96	21
			16QAM	19.82	19.92	20.02	21
			64QAM	19.80	19.92	19.99	21
		Middle	QPSK	19.83	19.89	19.99	21
			16QAM	19.86	19.97	20.05	21
			64QAM	19.95	20.03	20.08	21
		Low	QPSK	19.80	19.86	19.89	21
			16QAM	19.89	19.91	19.96	21
			64QAM	19.87	19.91	19.95	21
	75RB	/	QPSK	19.76	19.86	19.92	21
			16QAM	19.82	19.88	19.89	21
			64QAM	19.85	19.84	19.84	21

< Hotspot on >- PC3

LTE-FDD Band 41				Actual output Power (dBm)			Tune up
Band-width				High	Middle	Low	
5 MHz	RB allocation	RB offset	Modulation	2640.3MHz	/	2545.8MHz	
	1RB	High	QPSK	19.63	/	19.65	21
			16QAM	19.73	/	19.75	21
			64QAM	19.74	/	19.76	21
		Middle	QPSK	19.87	/	19.89	21
			16QAM	19.98	/	20.01	21
			64QAM	19.93	/	19.95	21
		Low	QPSK	19.64	/	19.66	21
			16QAM	19.75	/	19.77	21
			64QAM	19.73	/	19.75	21
	12RB	High	QPSK	19.72	/	19.74	21
			16QAM	19.73	/	19.74	21
			64QAM	19.72	/	19.73	21
		Middle	QPSK	19.81	/	19.82	21
			16QAM	19.78	/	19.79	21
			64QAM	19.79	/	19.80	21
		Low	QPSK	19.75	/	19.77	21
			16QAM	19.74	/	19.76	21
			64QAM	19.75	/	19.76	21
	25RB	/	QPSK	19.73	/	19.76	21
			16QAM	19.78	/	19.81	21
			64QAM	19.77	/	19.80	21

< Hotspot on >- PC3

LTE-FDD Band 41				Actual output Power (dBm)			Tune up
Band-width				High	Middle	Low	
10 MHz	RB allocation	RB offset	Modulation	2639MHz	/	2547MHz	
	1RB	High	QPSK	19.77	/	19.79	21
			16QAM	19.87	/	19.90	21
			64QAM	19.88	/	19.90	21
		Middle	QPSK	19.87	/	19.89	21
			16QAM	19.98	/	20.01	21
			64QAM	20.01	/	20.03	21
		Low	QPSK	19.76	/	19.77	21
			16QAM	19.87	/	19.88	21
			64QAM	19.87	/	19.88	21
	25RB	High	QPSK	19.81	/	19.84	21
			16QAM	19.86	/	19.89	21
			64QAM	19.84	/	19.87	21
		Middle	QPSK	19.82	/	19.85	21
			16QAM	19.87	/	19.87	21
			64QAM	19.87	/	19.85	21
		Low	QPSK	19.81	/	19.81	21
			16QAM	19.89	/	19.90	21
			64QAM	19.89	/	19.89	21
	50RB	/	QPSK	19.88	/	19.89	21
			16QAM	19.90	/	19.90	21
			64QAM	19.91	/	19.90	21

< Hotspot on >- PC3

LTE-FDD Band 41				Actual output Power (dBm)			Tune up
Band-width				High	Middle	Low	
15 MHz	RB allocation	RB offset	Modulation	2637.8MHz	/	2548.3MHz	
	1RB	High	QPSK	19.67	/	19.70	21
			16QAM	19.78	/	19.79	21
			64QAM	19.75	/	19.78	21
		Middle	QPSK	19.76	/	19.75	21
			16QAM	19.86	/	19.88	21
			64QAM	19.87	/	19.88	21
		Low	QPSK	19.66	/	19.69	21
			16QAM	19.77	/	19.79	21
			64QAM	19.77	/	19.81	21
	36RB	High	QPSK	19.77	/	19.79	21
			16QAM	19.72	/	19.76	21
			64QAM	19.75	/	19.76	21
		Middle	QPSK	19.78	/	19.83	21
			16QAM	19.77	/	19.79	21
			64QAM	19.75	/	19.77	21
		Low	QPSK	19.78	/	19.76	21
			16QAM	19.74	/	19.72	21
			64QAM	19.75	/	19.75	21
	75RB	/	QPSK	19.75	/	19.78	21
			16QAM	19.81	/	19.81	21
			64QAM	19.80	/	19.81	21

< Hotspot on >- PC3

LTE-FDD Band 41				Actual output Power (dBm)			Tune up
Band-width				High	Middle	Low	
20 MHz	RB allocation	RB offset	Modulation	2636.5MHz	/	2549.5MHz	
	1RB	High	QPSK	19.61	/	19.72	21
			16QAM	19.72	/	19.83	21
			64QAM	19.71	/	19.81	21
		Middle	QPSK	19.86	/	19.96	21
			16QAM	19.98	/	20.09	21
			64QAM	20.00	/	20.09	21
		Low	QPSK	19.72	/	19.78	21
			16QAM	19.81	/	19.88	21
			64QAM	19.81	/	19.88	21
	36RB	High	QPSK	19.81	/	19.90	21
			16QAM	19.87	/	19.97	21
			64QAM	19.86	/	19.95	21
		Middle	QPSK	19.86	/	19.94	21
			16QAM	19.92	/	20.01	21
			64QAM	19.99	/	20.01	21
		Low	QPSK	19.83	/	19.88	21
			16QAM	19.90	/	19.94	21
			64QAM	19.89	/	19.93	21
	75RB	/	QPSK	19.81	/	19.89	21
			16QAM	19.85	/	19.89	21
			64QAM	19.84	/	19.84	21

< Hotspot on >- PC2

LTE-FDD Band 41				Actual output Power (dBm)			Tune up
Band-width				High	Middle	Low	
5 MHz	RB allocation	RB offset	Modulation	2687.5MHz	2593MHz	2498.5MHz	
	1RB	High	QPSK	22.48	22.47	22.52	23.5
			16QAM	22.61	22.62	22.67	23.5
			64QAM	22.62	22.64	22.68	23.5
		Middle	QPSK	22.61	22.60	22.64	23.5
			16QAM	22.72	22.76	22.78	23.5
			64QAM	22.73	22.76	22.78	23.5
		Low	QPSK	22.46	22.51	22.50	23.5
			16QAM	22.60	22.66	22.67	23.5
			64QAM	22.62	22.67	22.66	23.5
	12RB	High	QPSK	22.61	22.61	22.63	23.5
			16QAM	22.66	22.61	22.64	23.5
			64QAM	22.67	22.60	22.64	23.5
		Middle	QPSK	22.68	22.69	22.71	23.5
			16QAM	22.68	22.65	22.69	23.5
			64QAM	22.68	22.69	22.69	23.5
		Low	QPSK	22.60	22.63	22.65	23.5
			16QAM	22.60	22.63	22.62	23.5
			64QAM	22.61	22.64	22.64	23.5
	25RB	/	QPSK	22.59	22.61	22.63	23.5
			16QAM	22.61	22.63	22.66	23.5
			64QAM	22.62	22.63	22.65	23.5

< Hotspot on >- PC2

LTE-FDD Band 41				Actual output Power (dBm)			Tune up
Band-width				High	Middle	Low	
10 MHz	RB allocation	RB offset	Modulation	2685MHz	2593MHz	2501MHz	
	1RB	High	QPSK	22.61	22.63	22.66	23.5
			16QAM	22.76	22.75	22.84	23.5
			64QAM	22.78	22.77	22.83	23.5
		Middle	QPSK	22.70	22.70	22.74	23.5
			16QAM	22.86	22.85	22.90	23.5
			64QAM	22.86	22.84	22.92	23.5
		Low	QPSK	22.59	22.60	22.64	23.5
			16QAM	22.77	22.79	22.80	23.5
			64QAM	22.75	22.80	22.81	23.5
	25RB	High	QPSK	22.67	22.68	22.73	23.5
			16QAM	22.66	22.70	22.76	23.5
			64QAM	22.67	22.71	22.75	23.5
		Middle	QPSK	22.68	22.66	22.71	23.5
			16QAM	22.71	22.67	22.70	23.5
			64QAM	22.70	22.66	22.70	23.5
		Low	QPSK	22.66	22.66	22.70	23.5
			16QAM	22.66	22.69	22.70	23.5
			64QAM	22.66	22.68	22.71	23.5
	50RB	/	QPSK	22.72	22.73	22.72	23.5
			16QAM	22.71	22.72	22.73	23.5
			64QAM	22.70	22.74	22.72	23.5

< Hotspot on >- PC2

LTE-FDD Band 41				Actual output Power (dBm)			Tune up
Band-width				High	Middle	Low	
15 MHz	RB allocation	RB offset	Modulation	2682.5MHz	2593MHz	2503.5MHz	
	1RB	High	QPSK	22.50	22.50	22.55	23.5
			16QAM	22.66	22.67	22.71	23.5
			64QAM	22.67	22.67	22.71	23.5
		Middle	QPSK	22.60	22.61	22.64	23.5
			16QAM	22.73	22.75	22.78	23.5
			64QAM	22.71	22.75	22.79	23.5
		Low	QPSK	22.48	22.57	22.58	23.5
			16QAM	22.66	22.67	22.71	23.5
			64QAM	22.67	22.68	22.71	23.5
	36RB	High	QPSK	22.64	22.64	22.69	23.5
			16QAM	22.59	22.55	22.63	23.5
			64QAM	22.61	22.58	22.66	23.5
		Middle	QPSK	22.64	22.67	22.67	23.5
			16QAM	22.55	22.61	22.63	23.5
			64QAM	22.58	22.60	22.66	23.5
		Low	QPSK	22.64	22.61	22.65	23.5
			16QAM	22.58	22.53	22.57	23.5
			64QAM	22.60	22.57	22.60	23.5
	75RB	/	QPSK	22.62	22.65	22.67	23.5
			16QAM	22.59	22.61	22.63	23.5
64QAM			22.62	22.61	22.64	23.5	

< Hotspot on >- PC2

LTE-FDD Band 41				Actual output Power (dBm)			Tune up
Band-width				High	Middle	Low	
20 MHz	RB allocation	RB offset	Modulation	2680MHz	2593MHz	2506MHz	
	1RB	High	QPSK	22.45	22.45	22.49	23.5
			16QAM	22.61	22.62	22.64	23.5
			64QAM	22.60	22.63	22.66	23.5
		Middle	QPSK	22.66	22.66	22.70	23.5
			16QAM	22.78	22.79	22.82	23.5
			64QAM	22.80	22.80	22.83	23.5
		Low	QPSK	22.40	22.39	22.47	23.5
			16QAM	22.59	22.61	22.64	23.5
			64QAM	22.60	22.60	22.66	23.5
	36RB	High	QPSK	22.61	22.63	22.66	23.5
			16QAM	22.62	22.63	22.68	23.5
			64QAM	22.62	22.63	22.67	23.5
		Middle	QPSK	22.65	22.67	22.69	23.5
			16QAM	22.64	22.66	22.69	23.5
			64QAM	22.65	22.65	22.68	23.5
		Low	QPSK	22.60	22.59	22.57	23.5
			16QAM	22.61	22.60	22.59	23.5
			64QAM	22.60	22.61	22.60	23.5
	75RB	/	QPSK	22.68	22.68	22.67	23.5
			16QAM	22.69	22.68	22.67	23.5
64QAM			22.67	22.69	22.67	23.5	

< Hotspot on >- PC2

LTE-FDD Band 41				Actual output Power (dBm)			Tune up
Band-width				Mid-High	/	Mid-Low	
5 MHz	RB allocation	RB offset	Modulation	2640.3MHz	/	2545.8MHz	
	1RB	High	QPSK	22.48	/	22.50	23.5
			16QAM	22.61	/	22.64	23.5
			64QAM	22.63	/	22.66	23.5
		Middle	QPSK	22.61	/	22.62	23.5
			16QAM	22.74	/	22.77	23.5
			64QAM	22.74	/	22.77	23.5
		Low	QPSK	22.48	/	22.50	23.5
			16QAM	22.63	/	22.67	23.5
			64QAM	22.64	/	22.66	23.5
	12RB	High	QPSK	22.61	/	22.62	23.5
			16QAM	22.63	/	22.63	23.5
			64QAM	22.64	/	22.62	23.5
		Middle	QPSK	22.68	/	22.70	23.5
			16QAM	22.67	/	22.67	23.5
			64QAM	22.68	/	22.69	23.5
		Low	QPSK	22.61	/	22.64	23.5
			16QAM	22.61	/	22.62	23.5
			64QAM	22.63	/	22.64	23.5
	25RB	/	QPSK	22.60	/	22.62	23.5
			16QAM	22.62	/	22.65	23.5
			64QAM	22.62	/	22.64	23.5

< Hotspot on >- PC2

LTE-FDD Band 41				Actual output Power (dBm)			Tune up
Band-width				Mid-High	/	Mid-Low	
10 MHz	RB allocation	RB offset	Modulation	2639MHz	/	2547MHz	
	1RB	High	QPSK	22.62	/	22.64	23.5
			16QAM	22.76	/	22.80	23.5
			64QAM	22.77	/	22.80	23.5
		Middle	QPSK	22.70	/	22.72	23.5
			16QAM	22.85	/	22.87	23.5
			64QAM	22.85	/	22.88	23.5
		Low	QPSK	22.59	/	22.62	23.5
			16QAM	22.78	/	22.80	23.5
			64QAM	22.77	/	22.81	23.5
	25RB	High	QPSK	22.68	/	22.71	23.5
			16QAM	22.68	/	22.73	23.5
			64QAM	22.69	/	22.73	23.5
		Middle	QPSK	22.67	/	22.69	23.5
			16QAM	22.69	/	22.69	23.5
			64QAM	22.68	/	22.68	23.5
		Low	QPSK	22.66	/	22.68	23.5
			16QAM	22.68	/	22.70	23.5
			64QAM	22.67	/	22.70	23.5
	50RB	/	QPSK	22.72	/	22.73	23.5
			16QAM	22.72	/	22.73	23.5
			64QAM	22.72	/	22.73	23.5

< Hotspot on >- PC2

LTE-FDD Band 41				Actual output Power (dBm)			Tune up
Band-width				Mid-High	/	Mid-Low	
15 MHz	RB allocation	RB offset	Modulation	2637.8MHz	/	2548.3MHz	
	1RB	High	QPSK	22.50	/	22.53	23.5
			16QAM	22.67	/	22.69	23.5
			64QAM	22.67	/	22.69	23.5
		Middle	QPSK	22.60	/	22.62	23.5
			16QAM	22.74	/	22.77	23.5
			64QAM	22.73	/	22.77	23.5
		Low	QPSK	22.52	/	22.58	23.5
			16QAM	22.67	/	22.69	23.5
			64QAM	22.68	/	22.70	23.5
	36RB	High	QPSK	22.64	/	22.66	23.5
			16QAM	22.57	/	22.59	23.5
			64QAM	22.59	/	22.62	23.5
		Middle	QPSK	22.66	/	22.67	23.5
			16QAM	22.58	/	22.62	23.5
			64QAM	22.59	/	22.63	23.5
		Low	QPSK	22.63	/	22.63	23.5
			16QAM	22.56	/	22.55	23.5
			64QAM	22.59	/	22.59	23.5
	75RB	/	QPSK	22.64	/	22.66	23.5
			16QAM	22.60	/	22.62	23.5
			64QAM	22.62	/	22.63	23.5

< Hotspot on >- PC2

LTE-FDD Band 41				Actual output Power (dBm)			Tune up
Band-width				Mid-High	/	Mid-Low	
20 MHz	RB allocation	RB offset	Modulation	2636.5MHz	/	2549.5MHz	
	1RB	High	QPSK	22.45	/	22.47	23.5
			16QAM	22.62	/	22.63	23.5
			64QAM	22.61	/	22.64	23.5
		Middle	QPSK	22.66	/	22.68	23.5
			16QAM	22.79	/	22.81	23.5
			64QAM	22.80	/	22.82	23.5
		Low	QPSK	22.39	/	22.43	23.5
			16QAM	22.60	/	22.62	23.5
			64QAM	22.60	/	22.63	23.5
	36RB	High	QPSK	22.62	/	22.64	23.5
			16QAM	22.63	/	22.66	23.5
			64QAM	22.63	/	22.65	23.5
		Middle	QPSK	22.66	/	22.68	23.5
			16QAM	22.65	/	22.68	23.5
			64QAM	22.65	/	22.67	23.5
		Low	QPSK	22.59	/	22.58	23.5
			16QAM	22.61	/	22.60	23.5
			64QAM	22.61	/	22.61	23.5
	75RB	/	QPSK	22.68	/	22.67	23.5
			16QAM	22.68	/	22.68	23.5
			64QAM	22.68	/	22.68	23.5

< Hotspot on >

LTE-FDD Band 66				Actual output Power (dBm)			Tune up
Band-width				High	Middle	Low	
1.4 MHz	RB allocation	RB offset	Modulation	1779.3MHz	1745MHz	1710.7MHz	
	1RB	High	QPSK	18.88	18.96	18.81	20
			16QAM	19.12	19.18	19.03	20
			64QAM	19.10	19.19	19.13	20
		Middle	QPSK	19.27	19.25	19.07	20
			16QAM	19.49	19.40	19.41	20
			64QAM	19.47	19.41	19.42	20
		Low	QPSK	19.11	18.97	18.84	20
			16QAM	19.45	19.28	19.23	20
			64QAM	19.43	19.30	19.23	20
	3RB	High	QPSK	19.04	19.20	18.99	20
			16QAM	19.10	19.16	19.05	20
			64QAM	19.10	19.13	19.05	20
		Middle	QPSK	19.23	19.28	19.12	20
			16QAM	19.21	19.27	19.11	20
			64QAM	19.19	19.27	19.11	20
		Low	QPSK	19.26	19.26	19.15	20
			16QAM	19.23	19.27	19.13	20
			64QAM	19.26	19.23	19.16	20
	6RB	/	QPSK	19.15	19.15	19.01	20
			16QAM	19.11	19.14	19.01	20
			64QAM	19.11	19.14	19.03	20

< Hotspot on >

LTE-FDD Band 66				Actual output Power (dBm)			Tune up
Band-width				High	Middle	Low	
3 MHz	RB allocation	RB offset	Modulation	1778.5MHz	1745MHz	1711.5MHz	
	1RB	High	QPSK	19.06	18.89	18.72	20
			16QAM	19.30	19.11	18.94	20
			64QAM	19.28	19.12	19.03	20
		Middle	QPSK	19.44	19.18	18.98	20
			16QAM	19.67	19.33	19.32	20
			64QAM	19.65	19.35	19.33	20
		Low	QPSK	19.29	18.90	18.75	20
			16QAM	19.63	19.21	19.14	20
			64QAM	19.60	19.23	19.13	20
	8RB	High	QPSK	19.22	19.13	18.90	20
			16QAM	19.28	19.09	18.95	20
			64QAM	19.28	19.06	18.95	20
		Middle	QPSK	19.40	19.21	19.03	20
			16QAM	19.39	19.21	19.02	20
			64QAM	19.37	19.20	19.02	20
		Low	QPSK	19.44	19.19	19.06	20
			16QAM	19.41	19.20	19.04	20
			64QAM	19.44	19.16	19.07	20
	15RB	/	QPSK	19.32	19.08	18.92	20
			16QAM	19.29	19.07	18.92	20
			64QAM	19.29	19.07	18.94	20

< Hotspot on >

LTE-FDD Band 66				Actual output Power (dBm)			Tune up
Band-width				High	Middle	Low	
5 MHz	RB allocation	RB offset	Modulation	1777.5MHz	1745MHz	1712.5MHz	
	1RB	High	QPSK	18.97	18.90	18.87	20
			16QAM	19.21	19.12	19.09	20
			64QAM	19.19	19.13	19.18	20
		Middle	QPSK	19.36	19.19	19.13	20
			16QAM	19.58	19.34	19.47	20
			64QAM	19.56	19.36	19.48	20
		Low	QPSK	19.20	18.92	18.90	20
			16QAM	19.54	19.22	19.29	20
			64QAM	19.52	19.25	19.28	20
	12RB	High	QPSK	19.14	19.15	19.05	20
			16QAM	19.19	19.10	19.11	20
			64QAM	19.19	19.07	19.10	20
		Middle	QPSK	19.32	19.22	19.18	20
			16QAM	19.31	19.22	19.17	20
			64QAM	19.28	19.22	19.17	20
		Low	QPSK	19.35	19.20	19.21	20
			16QAM	19.32	19.22	19.19	20
			64QAM	19.35	19.18	19.22	20
	25RB	/	QPSK	19.24	19.09	19.07	20
			16QAM	19.21	19.09	19.07	20
			64QAM	19.20	19.09	19.09	20

< Hotspot on >

LTE-FDD Band 66				Actual output Power (dBm)			Tune up
Band-width				High	Middle	Low	
10 MHz	RB allocation	RB offset	Modulation	1775MHz	1745MHz	1715MHz	
	1RB	High	QPSK	18.92	18.93	18.82	20
			16QAM	19.16	19.15	19.04	20
			64QAM	19.13	19.16	19.13	20
		Middle	QPSK	19.30	19.22	19.08	20
			16QAM	19.53	19.37	19.42	20
			64QAM	19.50	19.38	19.42	20
		Low	QPSK	19.15	18.94	18.85	20
			16QAM	19.49	19.25	19.24	20
			64QAM	19.46	19.27	19.23	20
	25RB	High	QPSK	19.08	19.17	19.00	20
			16QAM	19.14	19.13	19.05	20
			64QAM	19.14	19.10	19.05	20
		Middle	QPSK	19.26	19.25	19.13	20
			16QAM	19.25	19.24	19.12	20
			64QAM	19.23	19.24	19.12	20
		Low	QPSK	19.29	19.23	19.16	20
			16QAM	19.26	19.24	19.14	20
			64QAM	19.30	19.20	19.17	20
	50RB	/	QPSK	19.18	19.12	19.02	20
			16QAM	19.15	19.11	19.02	20
			64QAM	19.14	19.11	19.04	20

< Hotspot on >

LTE-FDD Band 66				Actual output Power (dBm)			Tune up
Band-width				High	Middle	Low	
15 MHz	RB allocation	RB offset	Modulation	1772.5MHz	1745MHz	1717.5MHz	
	1RB	High	QPSK	18.89	18.88	18.83	20
			16QAM	19.09	19.14	19.05	20
			64QAM	19.14	19.08	19.15	20
		Middle	QPSK	19.15	19.30	19.09	20
			16QAM	19.36	19.46	19.44	20
			64QAM	19.39	19.43	19.44	20
		Low	QPSK	18.86	19.16	18.86	20
			16QAM	19.13	19.53	19.25	20
			64QAM	19.15	19.52	19.25	20
	36RB	High	QPSK	19.10	19.08	19.01	20
			16QAM	19.09	19.10	19.07	20
			64QAM	19.07	19.09	19.07	20
		Middle	QPSK	19.17	19.27	19.14	20
			16QAM	19.16	19.26	19.14	20
			64QAM	19.16	19.24	19.13	20
		Low	QPSK	19.16	19.29	19.17	20
			16QAM	19.16	19.28	19.15	20
			64QAM	19.13	19.30	19.18	20
	75RB	/	QPSK	19.05	19.18	19.03	20
			16QAM	19.05	19.14	19.04	20
64QAM			19.07	19.12	19.05	20	

< Hotspot on >

LTE-FDD Band 66				Actual output Power (dBm)			Tune up
Band-width				High	Middle	Low	
20 MHz	RB allocation	RB offset	Modulation	1770MHz	1745MHz	1720MHz	
	1RB	High	QPSK	18.94	18.87	18.85	20
			16QAM	19.16	19.09	19.10	20
			64QAM	19.15	19.12	19.14	20
		Middle	QPSK	19.30	19.15	19.15	20
			16QAM	19.51	19.38	19.39	20
			64QAM	19.50	19.40	19.38	20
		Low	QPSK	19.08	18.93	18.90	20
			16QAM	19.32	19.30	19.29	20
			64QAM	19.31	19.30	19.30	20
	36RB	High	QPSK	19.10	19.08	19.07	20
			16QAM	19.14	19.10	19.07	20
			64QAM	19.13	19.08	19.05	20
		Middle	QPSK	19.23	19.20	19.20	20
			16QAM	19.22	19.20	19.19	20
			64QAM	19.21	19.18	19.19	20
		Low	QPSK	19.22	19.21	19.20	20
			16QAM	19.22	19.21	19.20	20
			64QAM	19.23	19.20	19.20	20
	75RB	/	QPSK	19.15	19.08	19.07	20
			16QAM	19.15	19.06	19.07	20
			64QAM	19.14	19.07	19.07	20

According to November 2017 TCB workshop, Uplink CA SAR Test Guidance as follows:

- a) When the maximum output for UL CA is \leq standalone LTE mode (without CA)
 - PCC is configured according to the highest standalone SAR configuration tested
 - SCC and subsequent CCs are configured according to procedures used for power measurement and parameters (BW, RB etc.) similar to that used for the PCC
- b) When the Reported SAR for UL CA configuration, described above, is $>1.2W/kg$, UL CA SAR is also required for all required test channels (PCC based)
- c) UL CA SAR is also required for standalone SAR configurations $>1.2W/kg$ when they are scaled to the UL CA power level.

The measurement results of downlink LTE CA Conducted Power are as below (**Full Power**):

<>Inter-Band>

CA List	PCC							SCC				Power	
	LTE	BW	UL	UL	Mod.	UL#	UL	LTE	BW	DL	DL	With CA	Without CA
	Band	(MHz)	Freq.	Channel		RB	RB Offset	Band	(MHz)	Freq.	Channel		
			(MHz)							(MHz)		(dBm)	(dBm)
CA_25A-26A	Band 25	20M	1860	26140	QPSK	1	50	Band 26	15M	876.5	8865	22.37	22.48
	Band 26	15M	841.5	26965	QPSK	1	50	Band 25	20M	1962.5	8365	22.76	22.90
CA_25A-41A	Band 25	20M	1860	26140	QPSK	1	50	Band 41	20M	2593	40620	22.42	22.48
	Band 41	20M	2506	39750	QPSK	1	50	Band 25	20M	1962.5	8365	23.08	23.12

<Intra-Band>

CA List	PCC							SCC				Power	
	LTE	BW	UL	UL	Mod.	UL#	UL	LTE	BW	DL	DL	With CA	Without CA
	Band	(MHz)	Freq.	Channel		RB	RB Offset	Band	(MHz)	Freq.	Channel		
			(MHz)							(MHz)		(dBm)	(dBm)
Contiguous													
CA_41C PC3	Band 41	20M	2506	39750	QPSK	1	50	Band 41	20M	2525.8	39948	23.01	23.12
Non- Contiguous													
CA_25A-25A	Band 25	20M	1860	26140	QPSK	1	50	Band 25	5M	1992.5	8665	22.34	22.48

Note: Testing is not required in bands or modes not intended/allowed for US operation.

The measurement results of downlink LTE CA Conducted Power are as below (**Hotspot on**):

<Inter-Band>

CA List	PCC							SCC				Power	
	LTE	BW	UL	UL	Mod.	UL#	UL	LTE	BW	DL	DL	With CA	Without CA
	Band	(MHz)	Freq.	Channel		RB	RB	Band	(MHz)	Freq.	Channel	Tx. Power	
			(MHz)				Offset			(MHz)		(dBm)	(dBm)
CA_25A-26A	Band 25	20M	1860	26140	QPSK	1	50	Band 26	15M	876.5	8865	18.32	18.46
CA_25A-41A	Band 25	20M	1860	26140	QPSK	1	50	Band 41	20M	2593	40620	18.27	18.46
	Band 41	20M	2506	39750	QPSK	1	50	Band 25	20M	1962.5	8365	20.02	20.11

<Intra-Band>

CA List	PCC							SCC				Power	
	LTE	BW	UL	UL	Mod.	UL#	UL	LTE	BW	DL	DL	With CA	Without CA
	Band	(MHz)	Freq.	Channel		RB	RB	Band	(MHz)	Freq.	Channel	Tx. Power	
			(MHz)				Offset			(MHz)		(dBm)	(dBm)
Contiguous													
CA_41C PC3	Band 41	20M	2506	39750	QPSK	1	50	Band 41	20M	2525.8	39948	20.08	20.11
CA_25A-25A	Band 25	20M	1860	26140	QPSK	1	50	Band 25	5M	1992.5	8665	18.36	18.46

Note: Testing is not required in bands or modes not intended/allowed for US operation.

The measurement results of uplink LTE CA Conducted Power are as below (**Full Power**):

<Intra-Band>

CA List	PCC							SCC							Power	
	LTE	BW	UL	UL	Mod.	UL#	UL	LTE	BW	DL	DL	Mod.	UL #	UL	With CA	Without CA
	Band	(MHz)	Freq.	Channel		RB	RB	Band	(MHz)	Freq.	Channel		RB	RB	Tx. Power	
			(MHz)				Offset			(MHz)				Offset	(dBm)	(dBm)
CA_41C PC3	Band 41	20M	2506	39750	QPSK	1	50	Band 41	20M	2486.2	39552	QPSK	1	99	23.05	23.12

Note: Testing is not required in bands or modes not intended/allowed for US operation.

The measurement results of uplink LTE CA Conducted Power are as below (**Hotspot on**):

<Intra-Band>

CA List	PCC							SCC							Power	
	LTE	BW	UL	UL	Mod.	UL#	UL	LTE	BW	DL	DL	Mod.	UL #	UL	With CA	Without CA
	Band	(MHz)	Freq.	Channel		RB	RB	Band	(MHz)	Freq.	Channel		RB	RB	Tx. Power	
			(MHz)				Offset			(MHz)				Offset	(dBm)	(dBm)
CA_41C PC3	Band 41	20M	2506	39750	QPSK	1	50	Band 41	20M	2486.2	39552	QPSK	1	99	20.06	20.11

Note: Testing is not required in bands or modes not intended/allowed for US operation.

11.5 Wi-Fi and BT Measurement result

Table 11.6: The conducted Power measurement results for BT

BT Mode	Tune up	Averaged Power (dBm)		
		Ch.0 (2402 MHz)	Ch39 (2441 MHz)	Ch78 (2480 MHz)
GFSK	5	3.43	4.15	4.13
EDR2M-4_DQPSK	5	2.57	3.28	3.23
EDR3M-8DPSK	5	2.57	3.32	3.28
/	/	Ch0 (2402MHz)	Ch19 (2440MHz)	Ch39 (2480MHz)
BLE	-4	-7.93	-6.93	-7.38

Table 11.7: The conducted Power measurement results for 2.4G WIFI

WiFi 2.4GHz Mode	Tune up	Averaged Power (dBm) Duty Cycle: 100%		
		Ch.1(2412 MHz)	Ch.6(2437Mhz)	Ch.11(2462MHz)
802.11b	16	15.38	15.55	15.61
802.11g	14	13.44	13.62	13.46
802.11n(20MHz)	14	13.41	13.57	13.54
/	/	Ch.3(2422 MHz)	Ch.6(2437Mhz)	Ch.9(2452MHz)
802.11n(40MHz)	13	12.55	12.63	12.71

12 Simultaneous TX SAR Considerations

12.1 Introduction

The following procedures adopted from “FCC SAR Considerations for Cell Phones with Multiple Transmitters” are applicable to handsets with built-in unlicensed transmitters such as 802.11 a/b/g and Bluetooth devices which may simultaneously transmit with the licensed transmitter.

For this device, the BT and Wi-Fi can transmit simultaneous with other transmitters.

12.2 Transmit Antenna Separation Distances

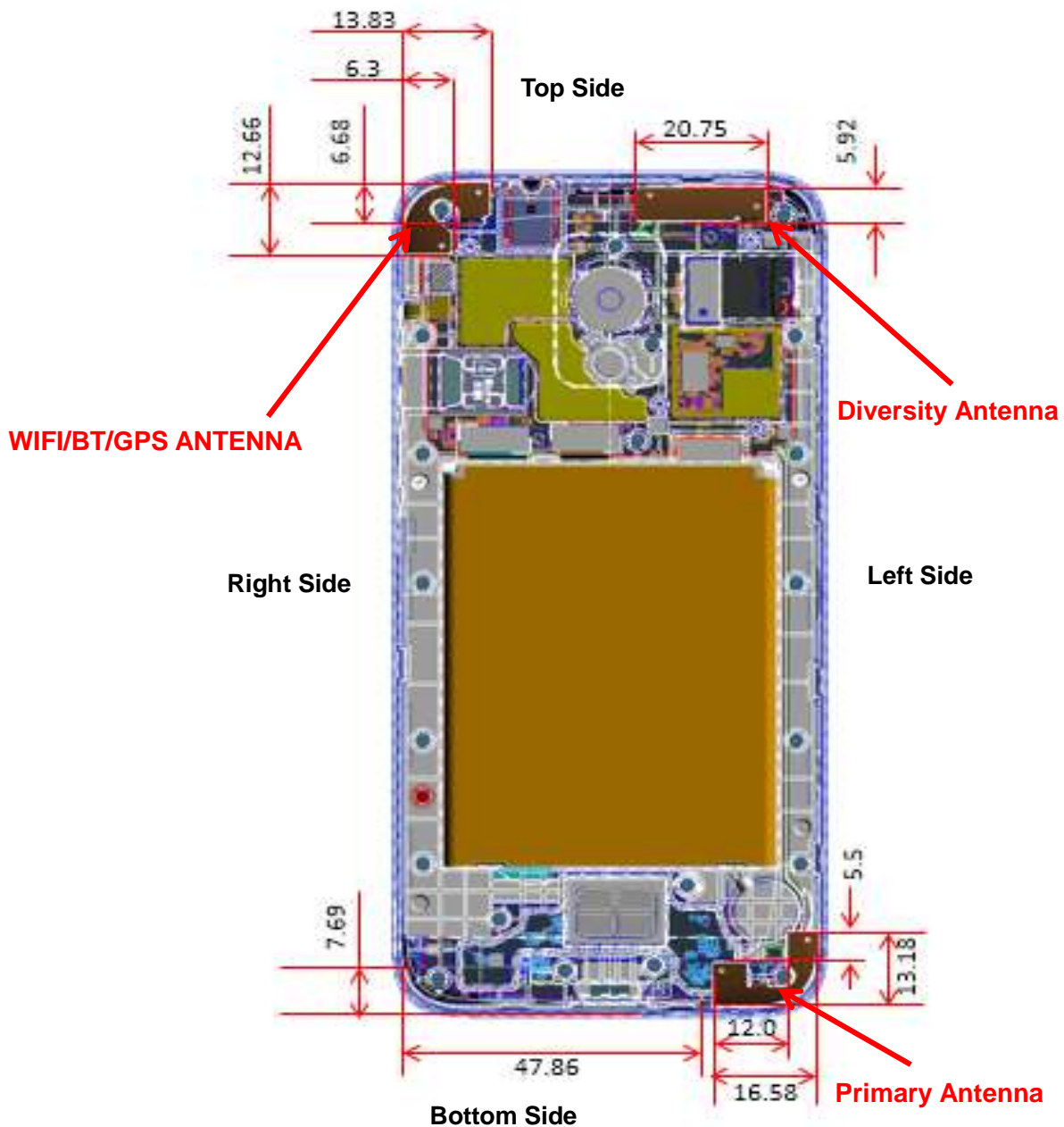

Picture 12.1 Antenna Locations (Back View)

12.3 SAR Measurement Positions

According to the KDB941225 D06 Hot Spot SAR, the edges with less than 25mm distance to the antennas need to be tested for SAR.

SAR measurement positions						
Mode	Front	Rear	Left edge	Right edge	Top edge	Bottom edge
Main antenna	Yes	Yes	Yes	Yes	No	Yes
WIFI antenna	Yes	Yes	Yes	Yes	Yes	No

12.4 Standalone SAR Test Exclusion Considerations

Standalone 1-g head or body SAR evaluation by measurement or numerical simulation is not required when the corresponding SAR Exclusion Threshold condition, listed below, is satisfied. The 1-g SAR test exclusion threshold for 100 MHz to 6 GHz at test separation distances ≤ 50 mm are determined by:

$[(\text{max. power of channel, including tune-up tolerance, mW}) / (\text{min. test separation distance, mm})] \cdot [\sqrt{f(\text{GHz})}] \leq 3.0$ for 1-g SAR, where

- $f(\text{GHz})$ is the RF channel transmit frequency in GHz
- Power and distance are rounded to the nearest mW and mm before calculation
- The result is rounded to one decimal place for comparison

Table 12.1: Standalone SAR test exclusion considerations

Band/Mode	f(GHz)	Position	SAR test exclusion threshold (mW)	RF output power		SAR test exclusion
				dBm	mW	
Bluetooth	2.441	Head	9.60	5	3.16	Yes
		Body	19.20	5	3.16	Yes
2.4GHz WLAN	2.45	Head	9.58	16	19.81	No
		Body	19.17	16	19.81	No

13 Evaluation of Simultaneous

Table 13.1: The sum of reported SAR values for main antenna and Wi-Fi

/	Position	Main antenna	Wi-Fi	Sum
Highest reported SAR value for Head	Left Touch	0.50	1.07	1.57
Highest reported SAR value for Hotspot	Front	0.97	0.17	1.14
Highest reported SAR value for Body-worn	Front	1.39	0.09	1.48

Table 13.2: The sum of reported SAR values for main antenna and Bluetooth

/	Position	Main antenna	BT*	Sum
Highest reported SAR value for Head	Right Touch	0.83	0.13	0.96
Highest reported SAR value for Hotspot	Bottom	1.11	0.07	1.18
Highest reported SAR value for Body-worn	Front	1.39	0.04	1.43

BT* - Estimated SAR for Bluetooth (see the table 13.3)

Table 13.3: Estimated SAR for Bluetooth

Position	f (GHz)	Distance (mm)	Upper limit of power *		Estimated _{1g} (W/kg)
			dBm	mW	
Head	2.441	5	5	3.16	0.13
Body	2.441	10	5	3.16	0.07
Body	2.441	15	5	3.16	0.04

* - Maximum possible output power declared by manufacturer

When standalone SAR test exclusion applies to an antenna that transmits simultaneously with other antennas, the standalone SAR must be estimated according to following to determine simultaneous transmission SAR test exclusion:

$(\text{max. power of channel, including tune-up tolerance, mW}) / (\text{min. test separation distance, mm}) \cdot [\sqrt{f(\text{GHz})}/x] \text{ W/kg}$ for test separation distances $\leq 50 \text{ mm}$;

Where $x = 7.5$ for 1-g SAR.

When the minimum test separation distance is $< 5 \text{ mm}$, a distance of 5 mm is applied to determine SAR test exclusion

Conclusion:

According to the above tables, the sum of reported SAR values is $< 1.6 \text{ W/kg}$. So the simultaneous transmission SAR with volume scans is not required.

14 Summary of Test Results

According to the client's decision rule in the test registration form, which is "based on the measurement results as the basis of the conformity statement", the test conclusion of this report meets the limit requirements.

14.1 SAR results

The calculated SAR is obtained by the following formula:

$$\text{Reported SAR} = \text{Measured SAR} \times 10^{(P_{\text{Target}} - P_{\text{Measured}})/10}$$

Where P_{Target} is the power of manufacturing upper limit;

P_{Measured} is the measured power in chapter 11.

Duty Cycle

Mode	Duty Cycle
Speech for GSM850/1900	1:8.3
GPRS for GSM850	1:4
GPRS for GSM1900	1:2
CDMA BC0/BC1/BC10	1:1
WCDMA850/1700/1900	1:1
FDD_LTE Band 2/4/5/12/13/25//26/66/71	1:1
TDD_LTE Band 41	1:1.58

Note:

B1 (Battery), Tianjin Lishen

B2 (Battery), Zhuhai Coslight

Table 14.1: SAR Values (GSM 850 - Head)

Frequency		Test Mode	Test Position	Figure No.	Ambient Temperature: 22.5°C		Liquid Temperature: 22.0°C		Power Drift(dB)
MHz	Ch.				Conducted Power (dBm)	Max. tune-up Power (dBm)	Measured SAR(1g) (W/kg)	Reported SAR(1g) (W/kg)	
836.6	190	Speech	Left Touch	/	33.87	34.5	0.353	0.41	0.01
836.6	190	Speech	Left Tilt	/	33.87	34.5	0.226	0.26	0.03
836.6	190	Speech	Right Touch	Fig.1	33.87	34.5	0.395	0.46	0.09
836.6	190	Speech	Right Tilt	/	33.87	34.5	0.229	0.26	0.07
The worst case with B2									
836.6	190	Speech	Right Touch	/	836.6	190	0.387	0.45	0.05

Table 14.2: SAR Values (GSM 850 -Body)

Frequency		Test Mode	Test Position	Figure No.	Ambient Temperature: 22.5°C		Liquid Temperature: 22.0°C		Power Drift(dB)
MHz	Ch.				Conducted Power (dBm)	Max. tune-up Power (dBm)	Measured SAR(1g) (W/kg)	Reported SAR(1g) (W/kg)	
Hotspot / Body-Worn Test Data (10mm)									
836.6	190	GPRS	Front	Fig.2	32.96	33.5	0.578	0.65	0.01
836.6	190	GPRS	Rear	/	32.96	33.5	0.419	0.47	0.02
836.6	190	GPRS	Left	/	32.96	33.5	0.193	0.22	0.08
836.6	190	GPRS	Right	/	32.96	33.5	0.380	0.43	0.04
836.6	190	GPRS	Bottom	/	32.96	33.5	0.310	0.35	-0.02
836.6	190	EGPRS	Rear	/	32.96	33.5	0.575	0.65	0.03
The worst case with B2									
836.6	190	GPRS	Front	/	32.96	33.5	0.571	0.65	0.03

Table 14.3: SAR Values (GSM 1900 - Head)

Frequency		Test Mode	Test Position	Figure No.	Conducted Power (dBm)	Max. tune-up Power (dBm)	Measured SAR(1g) (W/kg)	Reported SAR(1g) (W/kg)	Power Drift(dB)
MHz	Ch.								
Ambient Temperature: 22.7°C Liquid Temperature: 22.2°C									
1880	661	Speech	Left Touch	/	31.36	32	0.204	0.24	0.08
1880	661	Speech	Left Tilt	/	31.36	32	0.098	0.11	0.08
1880	661	Speech	Right Touch	Fig.3	31.36	32	0.396	0.46	0.03
1880	661	Speech	Right Tilt	/	31.36	32	0.083	0.10	0.06
The worst case with B2									
1880	661	Speech	Right Touch	/	31.36	32	0.385	0.45	0.10

Table 14.4: SAR Values (GSM 1900 - Body)

Frequency		Test Mode	Test Position	Figure No.	Conducted Power (dBm)	Max. tune-up Power (dBm)	Measured SAR(1g) (W/kg)	Reported SAR(1g) (W/kg)	Power Drift(dB)
MHz	Ch.								
Ambient Temperature: 22.4°C Liquid Temperature: 22.0°C									
Hotspot Test Data (10mm)									
1880	661	GPRS	Front	/	22.29	23	0.827	0.97	0.03
1880	661	GPRS	Rear	/	22.29	23	0.378	0.45	0.09
1880	661	GPRS	Left	/	22.29	23	0.012	0.01	0.13
1880	661	GPRS	Right	/	22.29	23	0.275	0.32	0.06
1880	661	GPRS	Bottom	/	22.29	23	0.853	1.00	0.01
1909.8	810	GPRS	Front	/	22.63	23	0.673	0.73	0.04
1850.2	512	GPRS	Front	/	22.15	23	0.650	0.79	0.09
1909.8	810	GPRS	Bottom	/	22.63	23	0.693	0.75	-0.01
1850.2	512	GPRS	Bottom	/	22.15	23	0.648	0.79	-0.01
1880	661	EGPRS	Bottom	/	22.29	23	0.836	0.98	0.08
Body-Worn Test Data (15mm)									
1880	661	GPRS	Front	Fig.4	27.83	28.5	1.190	1.39	0.09
1880	661	GPRS	Rear	/	27.83	28.5	0.742	0.87	-0.10
1909.8	810	GPRS	Front	/	27.91	28.5	0.919	1.05	0.09
1850.2	512	GPRS	Front	/	27.67	28.5	1.030	1.25	0.04
1909.8	810	GPRS	Rear	/	27.91	28.5	0.547	0.63	-0.06
1850.2	512	GPRS	Rear	/	27.67	28.5	0.651	0.79	-0.11
1880	661	EGPRS	Front	/	27.83	28.5	1.180	1.38	0.05
The worst case with Headset									
1880	661	GPRS	Front	/	27.83	28.5	1.130	1.32	0.04
The worst case with B2									
1880	661	GPRS	Front	/	27.83	28.5	1.160	1.35	-0.02

Table 14.5: SAR Values (CDMA BC0 - Head)

Frequency		Test Mode	Test Position	Figure No.	Conducted Power (dBm)	Max. tune-up Power (dBm)	Measured SAR(1g) (W/kg)	Reported SAR(1g) (W/kg)	Power Drift(dB)
MHz	Ch.								
Ambient Temperature: 22.5°C Liquid Temperature: 22.0°C									
836.52	384	SO55	Left Touch	/	23.63	24.5	0.314	0.38	-0.06
836.52	384	SO55	Left Tilt	/	23.63	24.5	0.185	0.23	0.11
836.52	384	SO55	Right Touch	Fig.5	23.63	24.5	0.322	0.39	0.09
836.52	384	SO55	Right Tilt	/	23.63	24.5	0.175	0.21	0.02
The worst case with B2									
836.52	384	SO55	Right Touch	/	23.63	24.5	0.306	0.37	-0.08

Table 14.6: SAR Values (CDMA BC0 -Body)

Frequency		Test Mode	Test Position	Figure No.	Conducted Power (dBm)	Max. tune-up Power (dBm)	Measured SAR(1g) (W/kg)	Reported SAR(1g) (W/kg)	Power Drift(dB)
MHz	Ch.								
Ambient Temperature: 22.8°C Liquid Temperature: 22.2°C									
Hotspot / Body-Worn Test Data (10mm)									
836.52	384	SO32	Front	/	23.62	24.5	0.256	0.31	0.04
836.52	384	SO32	Rear	/	23.62	24.5	0.240	0.29	0.04
836.52	384	SO32	Left	/	23.62	24.5	0.142	0.17	0.02
836.52	384	SO32	Right	/	23.62	24.5	0.218	0.27	0.06
836.52	384	SO32	Bottom	/	23.62	24.5	0.147	0.18	0.01
The worst case with B2									
836.52	384	SO32	Front	Fig.6	23.62	24.5	0.265	0.32	0.08

Table 14.7: SAR Values (CDMA BC1 - Head)

Frequency		Test Mode	Test Position	Figure No.	Conducted Power (dBm)	Max. tune-up Power (dBm)	Measured SAR(1g) (W/kg)	Reported SAR(1g) (W/kg)	Power Drift(dB)
MHz	Ch.								
Ambient Temperature: 22.7°C Liquid Temperature: 22.2°C									
1880	600	SO55	Left Touch	/	23.42	24	0.360	0.41	0.07
1880	600	SO55	Left Tilt	/	23.42	24	0.177	0.20	-0.03
1880	600	SO55	Right Touch	Fig.7	23.42	24	0.569	0.65	0.05
1880	600	SO55	Right Tilt	/	23.42	24	0.114	0.13	0.07
The worst case with B2									
1880	600	SO55	Right Touch	/	23.42	24	0.554	0.63	-0.03

Table 14.8: SAR Values (CDMA BC1 - Body)

Frequency		Test Mode	Test Position	Figure No.	Conducted Power (dBm)	Max. tune-up Power (dBm)	Measured SAR(1g) (W/kg)	Reported SAR(1g) (W/kg)	Power Drift(dB)
MHz	Ch.								
Ambient Temperature: 22.4°C Liquid Temperature: 22.0°C									
Hotspot Test Data (10mm)									
1880	600	SO32	Front	/	18.32	19	0.484	0.57	0.07
1880	600	SO32	Rear	/	18.32	19	0.137	0.16	0.04
1880	600	SO32	Left	/	18.32	19	0.013	0.01	0.06
1880	600	SO32	Right	/	18.32	19	0.104	0.12	0.08
1880	600	SO32	Bottom	/	18.32	19	0.463	0.54	0.05
Body-Worn Test Data (15mm)									
1880	600	SO32	Front	Fig.8	23.47	24	0.921	1.04	0.11
1880	600	SO32	Rear	/	23.47	24	0.178	0.20	0.13
1908.75	1175	SO32	Front	/	23.42	24	0.557	0.64	0.03
1851.25	25	SO32	Front	/	23.14	24	0.383	0.47	0.04
The worst case with B2									
1880	600	SO32	Front	/	23.47	24	0.903	1.03	0.05

Table 14.9: SAR Values (CDMA BC10 - Head)

Frequency		Test Mode	Test Position	Figure No.	Conducted Power (dBm)	Max. tune-up Power (dBm)	Measured SAR(1g) (W/kg)	Reported SAR(1g) (W/kg)	Power Drift(dB)
MHz	Ch.								
Ambient Temperature: 22.9°C Liquid Temperature: 22.4°C									
820.5	580	SO55	Left Touch	/	23.57	24.5	0.256	0.32	-0.08
820.5	580	SO55	Left Tilt	/	23.57	24.5	0.143	0.18	0.10
820.5	580	SO55	Right Touch	/	23.57	24.5	0.249	0.31	-0.04
820.5	580	SO55	Right Tilt	/	23.57	24.5	0.132	0.16	0.09
The worst case with B2									
820.5	580	SO55	Right Touch	Fig.9	23.57	24.5	0.259	0.32	0.02

Table 14.10: SAR Values (CDMA BC10 - Body)

Frequency		Test Mode	Test Position	Figure No.	Conducted Power (dBm)	Max. tune-up Power (dBm)	Measured SAR(1g) (W/kg)	Reported SAR(1g) (W/kg)	Power Drift(dB)
MHz	Ch.								
Ambient Temperature: 22.6°C Liquid Temperature: 22.1°C									
Hotspot / Body-Worn Test Data (10mm)									
820.5	580	SO32	Front	Fig.10	23.55	24.5	0.217	0.27	0.02
820.5	580	SO32	Rear	/	23.55	24.5	0.199	0.25	0.02
820.5	580	SO32	Left	/	23.55	24.5	0.114	0.14	0.14
820.5	580	SO32	Right	/	23.55	24.5	0.181	0.23	0.05
820.5	580	SO32	Bottom	/	23.55	24.5	0.111	0.14	-0.01
The worst case with B2									
820.5	580	SO32	Front	/	23.55	24.5	0.211	0.26	0.10

Table 14.11: SAR Values (WCDMA 850 - Head)

Frequency		Test Mode	Test Position	Figure No.	Conducted Power (dBm)	Max. tune-up Power (dBm)	Measured SAR(1g) (W/kg)	Reported SAR(1g) (W/kg)	Power Drift(dB)
MHz	Ch.								
Ambient Temperature: 22.5°C Liquid Temperature: 22.0°C									
836.4	4182	RMC	Left Touch	Fig.11	23.4	24.5	0.332	0.43	0.03
836.4	4182	RMC	Left Tilt	/	23.4	24.5	0.207	0.27	0.10
836.4	4182	RMC	Right Touch	/	23.4	24.5	0.328	0.42	0.02
836.4	4182	RMC	Right Tilt	/	23.4	24.5	0.194	0.25	0.07
The worst case with B2									
836.4	4182	RMC	Left Touch	/	23.4	24.5	0.281	0.36	-0.04

Table 14.12: SAR Values (WCDMA 850 -Body)

Frequency		Test Mode	Test Position	Figure No.	Conducted Power (dBm)	Max. tune-up Power (dBm)	Measured SAR(1g) (W/kg)	Reported SAR(1g) (W/kg)	Power Drift(dB)
MHz	Ch.								
Ambient Temperature: 22.8°C Liquid Temperature: 22.2°C									
Hotspot / Body-Worn Test Data (10mm)									
836.4	4182	RMC	Front	/	23.4	24.5	0.231	0.30	0.02
836.4	4182	RMC	Rear	/	23.4	24.5	0.274	0.35	0.05
836.4	4182	RMC	Left	/	23.4	24.5	0.191	0.25	-0.01
836.4	4182	RMC	Right	/	23.4	24.5	0.118	0.15	-0.01
836.4	4182	RMC	Bottom	/	23.4	24.5	0.145	0.19	-0.07
The worst case with B2									
836.4	4182	RMC	Rear	Fig.12	23.4	24.5	0.281	0.36	-0.14

Table 14.13: SAR Values (WCDMA1900 - Head)

Frequency		Test Mode	Test Position	Figure No.	Conducted Power (dBm)	Max. tune-up Power (dBm)	Measured SAR(1g) (W/kg)	Reported SAR(1g) (W/kg)	Power Drift(dB)
MHz	Ch.								
Ambient Temperature: 22.7°C Liquid Temperature: 22.2°C									
1880	9400	RMC	Left Touch	/	23.6	24.5	0.405	0.50	-0.12
1880	9400	RMC	Left Tilt	/	23.6	24.5	0.218	0.27	0.05
1880	9400	RMC	Right Touch	Fig.13	23.6	24.5	0.644	0.79	0.09
1880	9400	RMC	Right Tilt	/	23.6	24.5	0.158	0.19	0.10
The worst case with B2									
1880	9400	RMC	Right Touch	/	23.6	24.5	0.625	0.77	0.06

Table 14.14: SAR Values (WCDMA1900 - Body)

Frequency		Test Mode	Test Position	Figure No.	Conducted Power (dBm)	Max. tune-up Power (dBm)	Measured SAR(1g) (W/kg)	Reported SAR(1g) (W/kg)	Power Drift(dB)
MHz	Ch.								
Ambient Temperature: 22.4°C Liquid Temperature: 22.0°C									
Hotspot Test Data (10mm)									
1880	9400	RMC	Front	/	19.2	20	0.801	0.96	0.06
1880	9400	RMC	Rear	/	19.2	20	0.517	0.62	0.13
1880	9400	RMC	Left	/	19.2	20	0.010	0.01	0.04
1880	9400	RMC	Right	/	19.2	20	0.303	0.36	0.02
1880	9400	RMC	Bottom	/	19.2	20	0.926	1.11	0.05
1907.6	9538	RMC	Front	/	19.2	20	0.734	0.88	0.15
1852.4	9262	RMC	Front	/	19.2	20	0.798	0.96	0.02
1907.6	9538	RMC	Bottom	/	19.2	20	0.771	0.93	-0.03
1852.4	9262	RMC	Bottom	/	19.2	20	0.862	1.04	-0.10
Body-Worn Test Data (15mm)									
1880	9400	RMC	Front	/	23.6	24.5	1.100	1.35	0.02
1880	9400	RMC	Rear	/	23.6	24.5	0.665	0.82	0.01
1907.6	9538	RMC	Front	/	23.6	24.5	0.890	1.09	0.10
1852.4	9262	RMC	Front	/	23.7	24.5	1.010	1.21	0.08
1907.6	9538	RMC	Rear	/	23.6	24.5	0.555	0.68	0.04
1852.4	9262	RMC	Rear	/	23.7	24.5	0.736	0.88	0.01
The worst case with Headset									
1880	9400	RMC	Front	/	23.6	24.5	1.020	1.25	-0.04
The worst case with B2									
1880	9400	RMC	Front	Fig.14	23.6	24.5	1.120	1.38	0.04

Table 14.15: SAR Values (WCDMA 1700 - Head)

Frequency		Test Mode	Test Position	Figure No.	Conducted Power (dBm)	Max. tune-up Power (dBm)	Measured SAR(1g) (W/kg)	Reported SAR(1g) (W/kg)	Power Drift(dB)
MHz	Ch.								
Ambient Temperature: 22.9°C Liquid Temperature: 22.4°C									
1732.6	1413	RMC	Left Touch	/	23.5	24.5	0.119	0.15	0.05
1732.6	1413	RMC	Left Tilt	/	23.5	24.5	0.101	0.13	0.03
1732.6	1413	RMC	Right Touch	Fig.15	23.5	24.5	0.193	0.24	0.08
1732.6	1413	RMC	Right Tilt	/	23.5	24.5	0.055	0.07	0.02
The worst case with B2									
1732.6	1413	RMC	Right Touch	/	23.5	24.5	0.182	0.23	0.09

Table 14.16: SAR Values (WCDMA 1700 - Body)

Frequency		Test Mode	Test Position	Figure No.	Conducted Power (dBm)	Max. tune-up Power (dBm)	Measured SAR(1g) (W/kg)	Reported SAR(1g) (W/kg)	Power Drift(dB)
MHz	Ch.								
Ambient Temperature: 22.6°C Liquid Temperature: 22.1°C									
Hotspot Test Data (10mm)									
1732.6	1413	RMC	Front	/	20	21	0.407	0.51	0.05
1732.6	1413	RMC	Rear	/	20	21	0.259	0.33	0.08
1732.6	1413	RMC	Left	/	20	21	0.007	0.01	0.13
1732.6	1413	RMC	Right	/	20	21	0.183	0.23	0.08
1732.6	1413	RMC	Bottom	/	20	21	0.425	0.54	-0.09
Body-Worn Test Data (15mm)									
1732.6	1413	RMC	Front	/	23.5	24.5	0.502	0.63	0.06
1732.6	1413	RMC	Rear	/	23.5	24.5	0.313	0.39	0.06
The worst case with B2									
1732.6	1413	RMC	Front	Fig.16	23.5	24.5	0.504	0.63	0.06

Table 14.17: SAR Values (LTE Band 2 - Head)

Frequency		Test Mode	Test Position	Figure No.	Conducted Power (dBm)	Max. tune-up Power (dBm)	Measured SAR(1g) (W/kg)	Reported SAR(1g) (W/kg)	Power Drift(dB)
MHz	Ch.								
Ambient Temperature: 22.7°C					Liquid Temperature: 22.2°C				
1860	18700	1RB_Mid	Left Touch	/	22.49	23.5	0.284	0.36	0.10
1860	18700	50RB_Mid	Left Touch	/	21.53	22.5	0.225	0.28	0.06
1860	18700	1RB_Mid	Left Tilt	/	22.49	23.5	0.154	0.19	0.02
1860	18700	50RB_Mid	Left Tilt	/	21.53	22.5	0.119	0.15	0.09
1860	18700	1RB_Mid	Right Touch	Fig.17	22.49	23.5	0.533	0.67	0.02
1860	18700	50RB_Mid	Right Touch	/	21.53	22.5	0.423	0.53	-0.02
1860	18700	1RB_Mid	Right Tilt	/	22.49	23.5	0.116	0.15	0.02
1860	18700	50RB_Mid	Right Tilt	/	21.53	22.5	0.090	0.11	0.11
The worst case with B2									
1860	18700	1RB_Mid	Right Touch	/	22.49	23.5	0.516	0.65	0.06

Table 14.18: SAR Values (LTE Band 2 - Body)

Frequency		Test Mode	Test Position	Figure No.	Ambient Temperature: 22.4°C		Liquid Temperature: 22.0°C		Power Drift(dB)
MHz	Ch.				Conducted Power (dBm)	Max. tune-up Power (dBm)	Measured SAR(1g) (W/kg)	Reported SAR(1g) (W/kg)	
Hotspot Test Data (10mm)									
1860	18700	1RB_Mid	Front	/	18.52	19	0.612	0.68	0.03
1860	18700	50RB_Mid	Front	/	18.50	19	0.617	0.69	0.06
1860	18700	1RB_Mid	Rear	/	18.52	19	0.487	0.54	0.10
1860	18700	50RB_Mid	Rear	/	18.50	19	0.498	0.56	0.03
1860	18700	1RB_Mid	Left	/	18.52	19	0.005	0.01	0.07
1860	18700	50RB_Mid	Left	/	18.50	19	0.010	0.01	0.09
1860	18700	1RB_Mid	Right	/	18.52	19	0.165	0.18	0.01
1860	18700	50RB_Mid	Right	/	18.50	19	0.159	0.18	0.17
1860	18700	1RB_Mid	Bottom	/	18.52	19	0.708	0.79	0.04
1860	18700	50RB_Mid	Bottom	/	18.50	19	0.703	0.79	-0.10
Body-Worn Test Data (15mm)									
1860	18700	1RB_Mid	Front	Fig.18	22.49	23.5	0.899	1.13	0.07
1860	18700	50RB_Mid	Front	/	21.53	22.5	0.729	0.91	0.07
1860	18700	1RB_Mid	Rear	/	22.49	23.5	0.571	0.72	0.09
1860	18700	50RB_Mid	Rear	/	21.53	22.5	0.459	0.57	0.06
1900	19100	1RB_Mid	Front	/	22.44	23.5	0.822	1.05	0.04
1880	18900	1RB_Mid	Front	/	22.47	23.5	0.887	1.12	0.02
1900	19100	50RB_Low	Front	/	21.48	22.5	0.678	0.86	0.08
1880	18900	50RB_Low	Front	/	21.52	22.5	0.703	0.88	0.11
1880	18900	100RB	Front	/	21.45	22.5	0.553	0.70	0.05
The worst case with B2									
1860	18700	1RB_Mid	Front	/	22.49	23.5	0.872	1.10	0.03

Table 14.19: SAR Values (LTE Band 4 - Head)

Frequency		Test Mode	Test Position	Figure No.	Conducted Power (dBm)	Max. tune-up Power (dBm)	Measured SAR(1g) (W/kg)	Reported SAR(1g) (W/kg)	Power Drift(dB)
MHz	Ch.								
Ambient Temperature: 22.9°C					Liquid Temperature: 22.4°C				
1745	20300	1RB_Mid	Left Touch	/	23.65	24.5	0.170	0.21	0.09
1745	20300	50RB_Mid	Left Touch	/	22.71	23.5	0.114	0.14	0.10
1745	20300	1RB_Mid	Left Tilt	/	23.65	24.5	0.091	0.11	0.02
1745	20300	50RB_Mid	Left Tilt	/	22.71	23.5	0.071	0.09	0.04
1745	20300	1RB_Mid	Right Touch	Fig.19	23.65	24.5	0.276	0.34	0.04
1745	20300	50RB_Mid	Right Touch	/	22.71	23.5	0.214	0.26	0.13
1745	20300	1RB_Mid	Right Tilt	/	23.65	24.5	0.068	0.08	0.08
1745	20300	50RB_Mid	Right Tilt	/	22.71	23.5	0.516	0.62	0.06
The worst case with B2									
1745	20300	1RB_Mid	Right Touch	/	23.65	24.5	0.268	0.33	0.05

Table 14.20: SAR Values (LTE Band 4 - Body)

Frequency		Test Mode	Test Position	Figure No.	Conducted Power (dBm)	Max. tune-up Power (dBm)	Measured SAR(1g) (W/kg)	Reported SAR(1g) (W/kg)	Power Drift(dB)
MHz	Ch.								
Ambient Temperature: 22.6°C					Liquid Temperature: 22.1°C				
Hotspot Test Data (10mm)									
1720	20050	1RB_Mid	Front	/	19.21	20	0.450	0.54	0.04
1720	20050	50RB_Low	Front	/	19.21	20	0.435	0.52	0.09
1720	20050	1RB_Mid	Rear	/	19.21	20	0.260	0.31	0.08
1720	20050	50RB_Low	Rear	/	19.21	20	0.250	0.30	0.10
1720	20050	1RB_Mid	Left	/	19.21	20	0.022	0.03	0.06
1720	20050	50RB_Low	Left	/	19.21	20	0.021	0.03	0.05
1720	20050	1RB_Mid	Right	/	19.21	20	0.053	0.06	0.09
1720	20050	50RB_Low	Right	/	19.21	20	0.050	0.06	0.04
1720	20050	1RB_Mid	Bottom	/	19.21	20	0.485	0.58	-0.06
1720	20050	50RB_Low	Bottom	/	19.21	20	0.482	0.58	-0.03
Body-Worn Test Data (15mm)									
1745	20300	1RB_Mid	Front	/	23.65	24.5	0.493	0.60	0.06
1745	20300	50RB_Mid	Front	/	22.71	23.5	0.396	0.48	0.11
1745	20300	1RB_Mid	Rear	/	23.65	24.5	0.386	0.47	0.04
1745	20300	50RB_Mid	Rear	/	22.71	23.5	0.310	0.37	0.05
The worst case with B2									
1745	20300	1RB_Mid	Front	Fig.20	23.65	24.5	0.505	0.61	0.09

Table 14.21: SAR Values (LTE Band 5 - Head)

Frequency		Test Mode	Test Position	Figure No.	Conducted Power (dBm)	Max. tune-up Power (dBm)	Measured SAR(1g) (W/kg)	Reported SAR(1g) (W/kg)	Power Drift(dB)
MHz	Ch.								
Ambient Temperature: 22.5°C					Liquid Temperature: 22.0°C				
844	20600	1RB_Mid	Left Touch	/	23.33	24	0.255	0.30	0.07
844	20600	25RB_Low	Left Touch	/	22.40	23	0.219	0.25	0.02
844	20600	1RB_Mid	Left Tilt	/	23.33	24	0.138	0.16	0.13
844	20600	25RB_Low	Left Tilt	/	22.40	23	0.121	0.14	0.10
844	20600	1RB_Mid	Right Touch	Fig.21	23.33	24	0.264	0.31	0.14
844	20600	25RB_Low	Right Touch	/	22.40	23	0.222	0.25	0.08
844	20600	1RB_Mid	Right Tilt	/	23.33	24	0.161	0.19	0.11
844	20600	25RB_Low	Right Tilt	/	22.40	23	0.141	0.16	0.03
The worst case with B2									
844	20600	1RB_Mid	Right Touch	/	23.33	24	0.254	0.30	0.11

Table 14.22: SAR Values (LTE Band 5 - Body)

Frequency		Test Mode	Test Position	Figure No.	Conducted Power (dBm)	Max. tune-up Power (dBm)	Measured SAR(1g) (W/kg)	Reported SAR(1g) (W/kg)	Power Drift(dB)
MHz	Ch.								
Ambient Temperature: 22.8°C					Liquid Temperature: 22.2°C				
Hotspot / Body-Worn Test Data (10mm)									
844	20600	1RB_Mid	Front	/	23.33	24	0.218	0.25	-0.02
844	20600	25RB_Low	Front	/	22.40	23	0.192	0.22	0.02
844	20600	1RB_Mid	Rear	Fig.22	23.33	24	0.305	0.36	0.03
844	20600	25RB_Low	Rear	/	22.40	23	0.246	0.28	0.02
844	20600	1RB_Mid	Left	/	23.33	24	0.041	0.05	0.11
844	20600	25RB_Low	Left	/	22.40	23	0.032	0.04	0.02
844	20600	1RB_Mid	Right	/	23.33	24	0.246	0.29	-0.03
844	20600	25RB_Low	Right	/	22.40	23	0.190	0.22	0.02
844	20600	1RB_Mid	Bottom	/	23.33	24	0.159	0.19	-0.03
844	20600	25RB_Low	Bottom	/	22.40	23	0.138	0.16	-0.06
The worst case with B2									
844	20600	1RB_Mid	Rear	/	23.33	24	0.293	0.34	0.09

Table 14.23: SAR Values (LTE Band 12 - Head)

Frequency		Test Mode	Test Position	Figure No.	Conducted Power (dBm)	Max. tune-up Power (dBm)	Measured SAR(1g) (W/kg)	Reported SAR(1g) (W/kg)	Power Drift(dB)
MHz	Ch.								
Ambient Temperature: 22.5°C Liquid Temperature: 22.0°C									
711	23130	1RB_Mid	Left Touch	Fig.23	23.40	24	0.209	0.24	0.04
711	23130	25RB_Low	Left Touch	/	22.48	23	0.164	0.18	-0.06
711	23130	1RB_Mid	Left Tilt	/	23.40	24	0.122	0.14	0.14
711	23130	25RB_Low	Left Tilt	/	22.48	23	0.096	0.11	0.02
711	23130	1RB_Mid	Right Touch	/	23.40	24	0.207	0.24	0.04
711	23130	25RB_Low	Right Touch	/	22.48	23	0.161	0.18	0.08
711	23130	1RB_Mid	Right Tilt	/	23.40	24	0.122	0.14	0.01
711	23130	25RB_Low	Right Tilt	/	22.48	23	0.096	0.11	0.07
The worst case with B2									
711	23130	1RB_Mid	Left Touch	/	23.40	24	0.197	0.23	0.06

Table 14.24: SAR Values (LTE Band 12 - Body)

Frequency		Test Mode	Test Position	Figure No.	Conducted Power (dBm)	Max. tune-up Power (dBm)	Measured SAR(1g) (W/kg)	Reported SAR(1g) (W/kg)	Power Drift(dB)
MHz	Ch.								
Ambient Temperature: 22.8°C Liquid Temperature: 22.2°C									
Hotspot / Body-Worn Test Data (10mm)									
711	23130	1RB_Mid	Front	/	23.40	24	0.205	0.24	0.04
711	23130	25RB_Low	Front	/	22.48	23	0.162	0.18	0.07
711	23130	1RB_Mid	Rear	Fig.24	23.40	24	0.245	0.28	0.04
711	23130	25RB_Low	Rear	/	22.48	23	0.191	0.22	0.04
711	23130	1RB_Mid	Left	/	23.40	24	0.034	0.04	0.02
711	23130	25RB_Low	Left	/	22.48	23	0.032	0.04	0.07
711	23130	1RB_Mid	Right	/	23.40	24	0.099	0.11	0.04
711	23130	25RB_Low	Right	/	22.48	23	0.078	0.09	0.07
711	23130	1RB_Mid	Bottom	/	23.40	24	0.112	0.13	-0.07
711	23130	25RB_Low	Bottom	/	22.48	23	0.087	0.10	-0.06
The worst case with B2									
711	23130	1RB_Mid	Rear	/	23.40	24	0.235	0.27	0.08

Table 14.25: SAR Values (LTE Band 13 - Head)

Frequency		Test Mode	Test Position	Figure No.	Ambient Temperature: 22.5°C		Liquid Temperature: 22.0°C		
MHz	Ch.				Conducted Power (dBm)	Max. tune-up Power (dBm)	Measured SAR(1g) (W/kg)	Reported SAR(1g) (W/kg)	Power Drift(dB)
782	23230	1RB_Mid	Left Touch	/	23.05	24	0.180	0.22	0.04
782	23230	25RB_Mid	Left Touch	/	22.10	23	0.148	0.18	0.09
782	23230	1RB_Mid	Left Tilt	/	23.05	24	0.139	0.17	0.04
782	23230	25RB_Mid	Left Tilt	/	22.10	23	0.111	0.14	0.04
782	23230	1RB_Mid	Right Touch	/	23.05	24	0.192	0.24	0.02
782	23230	25RB_Mid	Right Touch	/	22.10	23	0.153	0.19	0.06
782	23230	1RB_Mid	Right Tilt	/	23.05	24	0.122	0.15	0.07
782	23230	25RB_Mid	Right Tilt	/	22.10	23	0.095	0.12	0.04
The worst case with B2									
782	23230	1RB_Mid	Right Touch	Fig.25	23.05	24	0.198	0.25	0.03

Table 14.26: SAR Values (LTE Band 13 - Body)

Frequency		Test Mode	Test Position	Figure No.	Ambient Temperature: 22.8°C		Liquid Temperature: 22.2°C		
MHz	Ch.				Conducted Power (dBm)	Max. tune-up Power (dBm)	Measured SAR(1g) (W/kg)	Reported SAR(1g) (W/kg)	Power Drift(dB)
Hotspot / Body-Worn Test Data (10mm)									
782	23230	1RB_Mid	Front	/	23.05	24	0.170	0.21	0.02
782	23230	25RB_Mid	Front	/	22.10	23	0.138	0.17	0.06
782	23230	1RB_Mid	Rear	Fig.26	23.05	24	0.201	0.25	0.01
782	23230	25RB_Mid	Rear	/	22.10	23	0.157	0.19	0.02
782	23230	1RB_Mid	Left	/	23.05	24	0.035	0.04	0.04
782	23230	25RB_Mid	Left	/	22.10	23	0.021	0.03	0.12
782	23230	1RB_Mid	Right	/	23.05	24	0.102	0.13	0.04
782	23230	25RB_Mid	Right	/	22.10	23	0.083	0.10	0.06
782	23230	1RB_Mid	Bottom	/	23.05	24	0.129	0.16	-0.07
782	23230	25RB_Mid	Bottom	/	22.10	23	0.102	0.13	-0.11
The worst case with B2									
782	23230	1RB_Mid	Rear	/	23.05	24	0.185	0.23	0.02

Table 14.27: SAR Values (LTE Band 25 - Head)

Frequency		Test Mode	Test Position	Figure No.	Ambient Temperature: 22.5°C		Liquid Temperature: 22.0°C		
MHz	Ch.				Conducted Power (dBm)	Max. tune-up Power (dBm)	Measured SAR(1g) (W/kg)	Reported SAR(1g) (W/kg)	Power Drift(dB)
1860	26140	1RB_Mid	Left Touch	/	22.48	23.5	0.287	0.36	0.03
1860	26140	50RB_Mid	Left Touch	/	21.51	22.5	0.232	0.29	0.09
1860	26140	1RB_Mid	Left Tilt	/	22.48	23.5	0.155	0.20	0.02
1860	26140	50RB_Mid	Left Tilt	/	21.51	22.5	0.133	0.17	0.04
1860	26140	1RB_Mid	Right Touch	/	22.48	23.5	0.542	0.69	0.12
1860	26140	50RB_Mid	Right Touch	/	21.51	22.5	0.422	0.53	0.05
1860	26140	1RB_Mid	Right Tilt	/	22.48	23.5	0.126	0.16	0.05
1860	26140	50RB_Mid	Right Tilt	/	21.51	22.5	0.096	0.12	0.10
The worst case with B2									
1860	26140	1RB_Mid	Right Touch	Fig.27	22.48	23.5	0.549	0.69	0.10

Table 14.28: SAR Values (LTE Band 25 - Body)

Frequency		Test Mode	Test Position	Figure No.	Conducted Power (dBm)	Max. tune-up Power (dBm)	Measured SAR(1g) (W/kg)	Reported SAR(1g) (W/kg)	Power Drift(dB)
MHz	Ch.								
Ambient Temperature: 22.8°C					Liquid Temperature: 22.2°C				
Hotspot Test Data (10mm)									
1860	26140	1RB_Mid	Front	/	18.46	19	0.600	0.68	0.08
1860	26140	50RB_Mid	Front	/	18.46	19	0.629	0.71	0.05
1860	26140	1RB_Mid	Rear	/	18.46	19	0.493	0.56	0.13
1860	26140	50RB_Mid	Rear	/	18.46	19	0.496	0.56	0.07
1860	26140	1RB_Mid	Left	/	18.46	19	0.005	0.01	0.04
1860	26140	50RB_Mid	Left	/	18.46	19	0.007	0.01	0.09
1860	26140	1RB_Mid	Right	/	18.46	19	0.143	0.16	0.07
1860	26140	50RB_Mid	Right	/	18.46	19	0.143	0.16	0.05
1860	26140	1RB_Mid	Bottom	/	18.46	19	0.698	0.79	-0.07
1860	26140	50RB_Mid	Bottom	/	18.46	19	0.703	0.80	-0.05
Body-Worn Test Data (15mm)									
1860	26140	1RB_Mid	Front	Fig.28	22.48	23.5	1.010	1.28	0.01
1860	26140	50RB_Mid	Front	/	21.51	22.5	0.691	0.87	0.04
1860	26140	1RB_Mid	Rear	/	22.48	23.5	0.576	0.73	0.05
1860	26140	50RB_Mid	Rear	/	21.51	22.5	0.463	0.58	0.05
1905	26590	1RB_Mid	Front	/	22.42	23.5	0.789	1.01	0.09
1882.5	26365	1RB_Mid	Front	/	22.44	23.5	0.912	1.16	0.10
1905	26590	50RB_Low	Front	/	21.44	22.5	0.588	0.75	0.03
1882.5	26365	50RB_Mid	Front	/	21.46	22.5	0.649	0.82	0.11
1860	26140	100RB	Front	/	21.42	22.5	0.594	0.76	0.12
The worst case with Headset									
1860	26140	1RB_Mid	Front	/	22.48	23.5	0.996	1.26	0.02
The worst case with B2									
1860	26140	1RB_Mid	Front	/	22.48	23.5	0.993	1.26	0.06

Table 14.29: SAR Values (LTE Band 26 - Head)

Frequency		Test Mode	Test Position	Figure No.	Conducted Power (dBm)	Max. tune-up Power (dBm)	Measured SAR(1g) (W/kg)	Reported SAR(1g) (W/kg)	Power Drift(dB)
MHz	Ch.								
Ambient Temperature: 22.5°C Liquid Temperature: 22.0°C									
841.5	26965	1RB_Mid	Left Touch	/	22.90	24	0.280	0.36	0.03
841.5	26965	36RB_Low	Left Touch	/	21.93	23	0.220	0.28	-0.08
841.5	26965	1RB_High	Left Tilt	/	22.90	24	0.190	0.24	0.11
841.5	26965	36RB_Low	Left Tilt	/	21.93	23	0.146	0.19	0.10
841.5	26965	1RB_High	Right Touch	Fig.29	22.90	24	0.288	0.37	0.05
841.5	26965	36RB_Low	Right Touch	/	21.93	23	0.222	0.28	0.01
841.5	26965	1RB_High	Right Tilt	/	22.90	24	0.179	0.23	0.12
841.5	26965	36RB_Low	Right Tilt	/	21.93	23	0.133	0.17	0.10
The worst case with B2									
841.5	26965	1RB_High	Right Touch	/	22.90	24	0.276	0.36	0.08

Table 14.30: SAR Values (LTE Band 26 - Body)

Frequency		Test Mode	Test Position	Figure No.	Conducted Power (dBm)	Max. tune-up Power (dBm)	Measured SAR(1g) (W/kg)	Reported SAR(1g) (W/kg)	Power Drift(dB)
MHz	Ch.								
Ambient Temperature: 22.8°C Liquid Temperature: 22.2°C									
Hotspot / Body-Worn Test Data (10mm)									
841.5	26965	1RB_Mid	Front	/	22.90	24	0.211	0.27	0.03
841.5	26965	36RB_Low	Front	/	21.93	23	0.174	0.22	0.02
841.5	26965	1RB_Mid	Rear	Fig.30	22.90	24	0.295	0.38	0.04
841.5	26965	36RB_Low	Rear	/	21.93	23	0.233	0.30	0.04
841.5	26965	1RB_Mid	Left	/	22.90	24	0.048	0.06	0.10
841.5	26965	36RB_Low	Left	/	21.93	23	0.038	0.05	0.11
841.5	26965	1RB_Mid	Right	/	22.90	24	0.244	0.31	0.01
841.5	26965	36RB_Low	Right	/	21.93	23	0.201	0.26	0.04
841.5	26965	1RB_Mid	Bottom	/	22.90	24	0.161	0.21	-0.06
841.5	26965	36RB_Low	Bottom	/	21.93	23	0.122	0.16	-0.06
The worst case with B2									
841.5	26965	1RB_Mid	Rear	/	22.90	24	0.281	0.36	0.05

Table 14.31: SAR Values (LTE Band 41 - Head)

Frequency		Test Mode	Test Position	Figure No.	Conducted Power (dBm)	Max. tune-up Power (dBm)	Measured SAR(1g) (W/kg)	Reported SAR(1g) (W/kg)	Power Drift(dB)
MHz	Ch.								
Ambient Temperature: 22.5°C		Liquid Temperature: 22.0°C							
2506	39750	1RB_Mid	Left Touch	/	23.12	24	0.123	0.15	0.12
2506	39750	50RB_Mid	Left Touch	/	22.08	23	0.116	0.14	0.08
2506	39750	1RB_Mid	Left Tilt	/	23.12	24	0.032	0.04	0.11
2506	39750	50RB_Mid	Left Tilt	/	22.08	23	0.028	0.03	0.02
2506	39750	1RB_Mid	Right Touch	/	23.12	24	0.074	0.09	0.06
2506	39750	50RB_Mid	Right Touch	/	22.08	23	0.066	0.08	0.11
2506	39750	1RB_Mid	Right Tilt	/	23.12	24	0.046	0.06	0.03
2506	39750	50RB_Mid	Right Tilt	/	22.08	23	0.041	0.05	0.02
The worst case with CA									
2506	39750	1RB_Mid	Left Touch	/	23.02	24	0.118	0.15	0.06
The worst case with PC2									
2506	39750	1RB_Mid	Left Touch	Fig.31	25.91	26.5	0.148	0.17	0.06
The worst case with B2									
2506	39750	1RB_Mid	Left Touch	/	23.12	24	0.116	0.14	0.08

Note: Per **TCB workshop May 2017** Guidance, all SAR tests were performed using power class 3. SAR with power class 2 at the available duty factor was additionally performed for the power class 3 configurations with the highest SAR configuration for each exposure conditions. Please see **ANNEX G** for linearity results.

Table 14.32: SAR Values (LTE Band 41 - Body)

Frequency		Test Mode	Test Position	Figure No.	Ambient Temperature: 22.8°C		Liquid Temperature: 22.2°C		
MHz	Ch.				Conducted Power (dBm)	Max. tune-up Power (dBm)	Measured SAR(1g) (W/kg)	Reported SAR(1g) (W/kg)	Power Drift(dB)
Hotspot Test Data (10mm)									
2506	39750	1RB_Mid	Front	/	20.11	21	0.068	0.08	0.06
2506	39750	50RB_Mid	Front	/	19.99	21	0.061	0.08	0.12
2506	39750	1RB_Mid	Rear	/	20.11	21	0.078	0.10	0.09
2506	39750	50RB_Mid	Rear	/	19.99	21	0.074	0.09	0.14
2506	39750	1RB_Mid	Left	/	20.11	21	0.029	0.04	0.11
2506	39750	50RB_Mid	Left	/	19.99	21	0.027	0.03	0.07
2506	39750	1RB_Mid	Right	/	20.11	21	0.018	0.02	0.11
2506	39750	50RB_Mid	Right	/	19.99	21	0.016	0.02	0.10
2506	39750	1RB_Mid	Bottom	/	20.11	21	0.096	0.12	0.08
2506	39750	50RB_Mid	Bottom	/	19.99	21	0.091	0.11	0.05
Hotspot - The worst case with CA									
2506	39750	1RB_Mid	Bottom	/	20.06	21	0.088	0.11	0.02
Hotspot - The worst case with PC2									
2506	39750	50RB_Mid	Bottom	/	22.70	23.5	0.116	0.14	0.06
Body-Worn Test Data (15mm)									
2506	39750	1RB_Mid	Front	/	23.12	24	0.147	0.18	-0.11
2506	39750	50RB_Mid	Front	/	22.08	23	0.112	0.14	-0.14
2506	39750	1RB_Mid	Rear	/	23.12	24	0.198	0.24	0.06
2506	39750	50RB_Mid	Rear	/	22.08	23	0.147	0.18	0.04
Body-Worn - The worst case with CA									
2506	39750	1RB_Mid	Rear	/	23.02	24	0.183	0.23	0.04
Body-Worn - The worst case with PC2									
2506	39750	50RB_Mid	Rear	Fig.32	25.91	26.5	0.268	0.31	0.10
The worst case with B2									
2506	39750	1RB_Mid	Rear	/	23.12	24	0.175	0.21	0.09

Note: Per **TCB workshop May 2017** Guidance, all SAR tests were performed using power class 3. SAR with power class 2 at the available duty factor was additionally performed for the power class 3 configurations with the highest SAR configuration for each exposure conditions. Please see **ANNEX G** for linearity results.

Table 14.33: SAR Values (LTE Band 66 - Head)

Frequency		Test Mode	Test Position	Figure No.	Conducted Power (dBm)	Max. tune-up Power (dBm)	Measured SAR(1g) (W/kg)	Reported SAR(1g) (W/kg)	Power Drift(dB)
MHz	Ch.								
Ambient Temperature: 22.2°C Liquid Temperature: 21.7°C									
1770	132572	1RB_Mid	Left Touch	/	23.77	24.5	0.047	0.06	0.06
1770	132572	50RB_Mid	Left Touch	/	22.78	23.5	0.034	0.04	0.04
1770	132572	1RB_Mid	Left Tilt	/	23.77	24.5	0.019	0.02	0.09
1770	132572	50RB_Mid	Left Tilt	/	22.78	23.5	0.016	0.02	0.06
1770	132572	1RB_Mid	Right Touch	Fig.33	23.77	24.5	0.081	0.10	0.06
1770	132572	50RB_Mid	Right Touch	/	22.78	23.5	0.062	0.07	0.11
1770	132572	1RB_Mid	Right Tilt	/	23.77	24.5	0.012	0.01	0.07
1770	132572	50RB_Mid	Right Tilt	/	22.78	23.5	0.008	0.01	0.05
The worst case with B2									
1770	132572	1RB_Mid	Right Touch	/	23.77	24.5	0.072	0.09	0.10

Table 14.34: SAR Values (LTE Band 66 - Body)

Frequency		Test Mode	Test Position	Figure No. / Note	Conducted Power (dBm)	Max. tune-up Power (dBm)	Measured SAR(1g) (W/kg)	Reported SAR(1g) (W/kg)	Power Drift(dB)
MHz	Ch.								
Ambient Temperature: 22.2°C Liquid Temperature: 21.7°C									
Hotspot Test Data (10mm)									
1770	132572	1RB_Mid	Front	/	19.30	20	0.587	0.69	0.07
1770	132572	50RB_Mid	Front	/	19.23	20	0.506	0.60	0.10
1770	132572	1RB_Mid	Rear	/	19.30	20	0.344	0.40	0.02
1770	132572	50RB_Mid	Rear	/	19.23	20	0.335	0.40	0.09
1770	132572	1RB_Mid	Left	/	19.30	20	0.011	0.01	0.03
1770	132572	50RB_Mid	Left	/	19.23	20	0.100	0.12	0.04
1770	132572	1RB_Mid	Right	/	19.30	20	0.144	0.17	0.06
1770	132572	50RB_Mid	Right	/	19.23	20	0.138	0.16	-0.03
1770	132572	1RB_Mid	Bottom	Fig.34	19.30	20	0.618	0.73	-0.03
1770	132572	50RB_Mid	Bottom	/	19.23	20	0.609	0.73	-0.04
Body-Worn Test Data (15mm)									
1770	132572	1RB_Mid	Front	/	23.77	24.5	0.609	0.72	0.13
1770	132572	50RB_Low	Front	/	22.78	23.5	0.486	0.57	0.09
1770	132572	1RB_Mid	Rear	/	23.77	24.5	0.486	0.57	0.02
1770	132572	50RB_Low	Rear	/	22.78	23.5	0.389	0.46	0.07
The worst case with B2									
1770	132572	1RB_Mid	Bottom	/	19.30	20	0.613	0.72	0.11

Table 14.35: SAR Values (LTE Band 71 - Head)

Frequency		Test Mode	Test Position	Figure No.	Ambient Temperature: 22.2°C		Liquid Temperature: 21.7°C		
MHz	Ch.				Conducted Power (dBm)	Max. tune-up Power (dBm)	Measured SAR(1g) (W/kg)	Reported SAR(1g) (W/kg)	Power Drift(dB)
673	133222	1RB_Mid	Left Touch	Fig.35	23.25	24	0.032	0.04	0.08
673	133222	50RB_Mid	Left Touch	/	22.16	23	0.023	0.03	0.09
673	133222	1RB_Mid	Left Tilt	/	23.25	24	0.016	0.02	0.12
673	133222	50RB_Mid	Left Tilt	/	22.16	23	0.012	0.01	0.07
673	133222	1RB_Mid	Right Touch	/	23.25	24	0.031	0.04	0.10
673	133222	50RB_Mid	Right Touch	/	22.16	23	0.023	0.03	0.09
673	133222	1RB_Mid	Right Tilt	/	23.25	24	0.018	0.02	0.08
673	133222	50RB_Mid	Right Tilt	/	22.16	23	0.013	0.02	0.11
The worst case with B2									
673	133222	1RB_Mid	Left Touch	/	23.25	24	0.029	0.03	0.05

Table 14.36: SAR Values (LTE Band 71 - Body)

Frequency		Test Mode	Test Position	Figure No. / Note	Ambient Temperature: 22.2°C		Liquid Temperature: 21.7°C		
MHz	Ch.				Conducted Power (dBm)	Max. tune-up Power (dBm)	Measured SAR(1g) (W/kg)	Reported SAR(1g) (W/kg)	Power Drift(dB)
Hotspot / Body-Worn Test Data (10mm)									
673	133222	1RB_Mid	Front	/	23.25	24	0.042	0.05	0.05
673	133222	50RB_Mid	Front	/	22.16	23	0.027	0.03	0.06
673	133222	1RB_Mid	Rear	/	23.25	24	0.035	0.04	0.13
673	133222	50RB_Mid	Rear	/	22.16	23	0.024	0.03	0.07
673	133222	1RB_Mid	Left	/	23.25	24	0.014	0.02	0.02
673	133222	50RB_Mid	Left	/	22.16	23	0.010	0.01	0.10
673	133222	1RB_Mid	Right	/	23.25	24	0.038	0.05	0.09
673	133222	50RB_Mid	Right	/	22.16	23	0.029	0.04	0.12
673	133222	1RB_Mid	Bottom	/	23.25	24	0.027	0.03	0.03
673	133222	50RB_Mid	Bottom	/	22.16	23	0.018	0.02	0.01
The worst case with B2									
673	133222	1RB_Mid	Front	Fig.36	23.25	24	0.045	0.05	0.08

14.2 WLAN Evaluation for 2.4G

According to the KDB248227 D01, SAR is measured for 2.4GHz 802.11b DSSS using the initial test position procedure.

Table 14.37: SAR Values (WLAN 2.4G - Head)

Frequency		Test Mode	Test Position	Figure No.	Conducted Power (dBm)	Max. tune-up Power (dBm)	Measured SAR(1g) (W/kg)	Reported SAR(1g) (W/kg)	Power Drift(dB)
MHz	Ch.								
Ambient Temperature: 22.6°C Liquid Temperature: 22.0°C									
2462	11	802.11 b	Left Touch	/	15.61	16	0.737	0.81	0.02
2462	11	802.11 b	Left Tilt	/	15.61	16	0.570	0.62	0.09
2462	11	802.11 b	Right Touch	/	15.61	16	0.458	0.50	0.03
2462	11	802.11 b	Right Tilt	/	15.61	16	0.595	0.65	0.04
2437	6	802.11 b	Left Touch	Fig.37	15.55	16	0.879	0.97	-0.05
The worst case with B2									
2437	6	802.11 b	Left Touch		15.55	16	0.855	0.95	0.12

Note1: For all positions/configurations tested using the initial test position and subsequent test positions, when the reported SAR is > 0.8 W/kg, SAR is measured for these test positions/configurations on the subsequent next highest measured output power channel until the reported SAR is ≤ 1.2 W/kg or all required channels are tested.

According to the KDB248227 D01, The reported SAR must be scaled to 100% transmission duty factor to determine compliance at the maximum tune-up tolerance limit.

Table 14.38: SAR Values (WLAN - Head) – 802.11b (Scaled Reported SAR)

Frequency		Test Position	Actual duty factor	maximum duty factor	Reported SAR (1g)(W/kg)	Scaled reported SAR (1g)(W/kg)
MHz	Ch					
2437	6	Left Touch	100%	100%	0.97	0.97

SAR is not required for OFDM because the 802.11b adjusted SAR ≤ 1.2 W/kg.

Table 14.39: SAR Values (WLAN 2.4G - Body)

Ambient Temperature: 22.6°C					Liquid Temperature: 22.0°C				
Frequency		Test Mode	Test Position	Figure No.	Conducted Power (dBm)	Max. tune-up Power (dBm)	Measured SAR(1g) (W/kg)	Reported SAR(1g) (W/kg)	Power Drift(dB)
MHz	Ch.								
Test Data (10mm)									
2462	11	802.11 b	Front	/	15.61	16	0.157	0.17	0.08
2462	11	802.11 b	Rear	/	15.61	16	0.162	0.18	0.09
2462	11	802.11 b	Left	/	15.61	16	0.054	0.06	0.10
2462	11	802.11 b	Right	/	15.61	16	0.054	0.06	0.09
2462	11	802.11 b	Top	Fig.38	15.61	16	0.205	0.22	0.04
Test Data (15mm)									
2462	11	802.11 b	Front	/	15.61	16	0.085	0.09	0.03
2462	11	802.11 b	Rear	/	15.61	16	0.098	0.11	0.01
The worst case with B2									
2462	11	802.11 b	Top	/	15.61	16	0.186	0.20	0.06

Note1: For all positions/configurations tested using the initial test position and subsequent test positions, when the reported SAR is > 0.8 W/kg, SAR is measured for these test positions/configurations on the subsequent next highest measured output power channel until the reported SAR is ≤ 1.2 W/kg or all required channels are tested.

According to the KDB248227 D01, The reported SAR must be scaled to 100% transmission duty factor to determine compliance at the maximum tune-up tolerance limit..

Table 14.40: SAR Values (WLAN - Body) – 802.11b (Scaled Reported SAR)

Ambient Temperature: 22.6°C					Liquid Temperature: 22.0°C	
Frequency		Test Position	Actual duty factor	maximum duty factor	Reported SAR (1g)(W/kg)	Scaled reported SAR (1g)(W/kg)
MHz	Ch.					
2462	11	Top	100%	100%	0.22	0.22

SAR is not required for OFDM because the 802.11b adjusted SAR ≤ 1.2 W/kg.

15 SAR Measurement Variability

SAR measurement variability must be assessed for each frequency band, which is determined by the SAR probe calibration point and tissue-equivalent medium used for the device measurements. When both head and body tissue-equivalent media are required for SAR measurements in a frequency band, the variability measurement procedures should be applied to the tissue medium with the highest measured SAR, using the highest measured SAR configuration for that tissue-equivalent medium.

The following procedures are applied to determine if repeated measurements are required.

- 1) Repeated measurement is not required when the original highest measured SAR is < 0.80 W/kg; steps 2) through 4) do not apply.
- 2) When the original highest measured SAR is ≥ 0.80 W/kg, repeat that measurement once.
- 3) Perform a second repeated measurement only if the ratio of largest to smallest SAR for the original and first repeated measurements is > 1.20 or when the original or repeated measurement is ≥ 1.45 W/kg (~ 10% from the 1-g SAR limit).
- 4) Perform a third repeated measurement only if the original, first or second repeated measurement is ≥ 1.5 W/kg and the ratio of largest to smallest SAR for the original, first and second repeated measurements is > 1.20 .

Table 15.1: SAR Measurement Variability for Body – GSM1900

Frequency		Test Position	Original	1 st Repeated	Ratio	2 nd Repeated
MHz	Ch.		SAR (W/kg)	SAR (W/kg)		SAR (W/kg)
1880	661	Front	1.19	1.16	1.03	/

Table 15.2: SAR Measurement Variability for Body – CDMA BC1

Frequency		Test Position	Original	1 st Repeated	Ratio	2 nd Repeated
MHz	Ch.		SAR (W/kg)	SAR (W/kg)		SAR (W/kg)
1880	600	Front	0.921	0.915	1.01	/

Table 15.3: SAR Measurement Variability for Body – WCDMA 1900

Frequency		Test Position	Original	1 st Repeated	Ratio	2 nd Repeated
MHz	Ch.		SAR (W/kg)	SAR (W/kg)		SAR (W/kg)
1880	9400	Front	1.12	1.08	1.04	/

Table 15.4: SAR Measurement Variability for Body – LTE Band 2

Frequency		Test Position	Original	1 st Repeated	Ratio	2 nd Repeated
MHz	Ch.		SAR (W/kg)	SAR (W/kg)		SAR (W/kg)
1860	18700	Front	0.899	0.893	1.01	/

Table 15.5: SAR Measurement Variability for Body – LTE Band 25

Frequency		Test Position	Original	1 st Repeated	Ratio	2 nd Repeated
MHz	Ch.		SAR (W/kg)	SAR (W/kg)		SAR (W/kg)
1860	26140	Front	1.01	0.991	1.02	/

Table 15.6: SAR Measurement Variability for Head – WIFI

Frequency		Test Position	Original	1 st Repeated	Ratio	2 nd Repeated
MHz	Ch.		SAR (W/kg)	SAR (W/kg)		SAR (W/kg)
2437	6	Left Cheek	0.879	0.868	1.01	/

16 Measurement Uncertainty

16.1 Measurement Uncertainty for Normal SAR Tests (300MHz~3GHz)

No.	Error Description	Type	Uncertainty value	Probably Distribution	Div.	(Ci) 1g	(Ci) 10g	Std. Unc. (1g)	Std. Unc. (10g)	Degree of freedom
Measurement system										
1	Probe calibration	B	12	N	2	1	1	6.0	6.0	∞
2	Isotropy	B	7.4	R	$\sqrt{3}$	1	1	4.3	4.3	∞
3	Boundary effect	B	1.1	R	$\sqrt{3}$	1	1	0.6	0.6	∞
4	Linearity	B	4.7	R	$\sqrt{3}$	1	1	2.7	2.7	∞
5	Detection limit	B	1.0	R	$\sqrt{3}$	1	1	0.6	0.6	∞
6	Readout electronics	B	1.0	N	1	1	1	1.0	1.0	∞
7	Response time	B	0.0	R	$\sqrt{3}$	1	1	0.0	0.0	∞
8	Integration time	B	1.7	R	$\sqrt{3}$	1	1	1.0	1.0	∞
9	RF ambient conditions-noise	B	3.0	R	$\sqrt{3}$	1	1	1.7	1.7	∞
10	RF ambient conditions-reflection	B	3.0	R	$\sqrt{3}$	1	1	1.7	1.7	∞
11	Probe positioned mech. restrictions	B	0.35	R	$\sqrt{3}$	1	1	0.2	0.2	∞
12	Probe positioning with respect to phantom shell	B	2.9	R	$\sqrt{3}$	1	1	1.7	1.7	∞
13	Post-processing	B	1.0	R	$\sqrt{3}$	1	1	0.6	0.6	∞
Test sample related										
14	Test sample positioning	A	3.3	N	1	1	1	3.3	3.3	5
15	Device holder uncertainty	A	3.4	N	1	1	1	3.4	3.4	5
16	Drift of output power	B	5.0	R	$\sqrt{3}$	1	1	2.9	2.9	∞
Phantom and set-up										
17	Phantom uncertainty	B	1.0	R	$\sqrt{3}$	1	1	0.6	0.6	∞
18	Liquid conductivity (target)	B	5.0	R	$\sqrt{3}$	0.64	0.43	1.8	1.2	∞
19	Liquid conductivity (meas.)	A	1.3	N	1	0.64	0.43	0.83	0.56	9
20	Liquid permittivity (target)	B	5.0	R	$\sqrt{3}$	0.6	0.49	1.7	1.4	∞
21	Liquid permittivity (meas.)	A	1.6	N	1	0.6	0.49	0.96	0.78	9
Combined standard uncertainty		$u_c = \sqrt{\sum_{i=1}^{21} c_i^2 u_i^2}$						10.4	10.3	95.5
Expanded uncertainty (Confidence interval of 95 %)		$u_e = 2u_c$						20.8	20.6	

16.2 Measurement Uncertainty for Fast SAR Tests (300MHz~3GHz)

No.	Error Description	Type	Uncertainty value	Probably Distribution	Div.	(Ci) 1g	(Ci) 10g	Std. Unc. (1g)	Std. Unc. (10g)	Degree of freedom
Measurement system										
1	Probe calibration	B	12	N	2	1	1	6.0	6.0	∞
2	Isotropy	B	7.4	R	$\sqrt{3}$	1	1	4.3	4.3	∞
3	Boundary effect	B	1.1	R	$\sqrt{3}$	1	1	0.6	0.6	∞
4	Linearity	B	4.7	R	$\sqrt{3}$	1	1	2.7	2.7	∞
5	Detection limit	B	1.0	R	$\sqrt{3}$	1	1	0.6	0.6	∞
6	Readout electronics	B	1.0	N	1	1	1	1.0	1.0	∞
7	Response time	B	0.0	R	$\sqrt{3}$	1	1	0.0	0.0	∞
8	Integration time	B	1.7	R	$\sqrt{3}$	1	1	1.0	1.0	∞
9	RF ambient conditions-noise	B	3.0	R	$\sqrt{3}$	1	1	1.7	1.7	∞
10	RF ambient conditions-reflection	B	3.0	R	$\sqrt{3}$	1	1	1.7	1.7	∞
11	Probe positioned mech. Restrictions	B	0.35	R	$\sqrt{3}$	1	1	0.2	0.2	∞
12	Probe positioning with respect to phantom shell	B	2.9	R	$\sqrt{3}$	1	1	1.7	1.7	∞
13	Post-processing	B	1.0	R	$\sqrt{3}$	1	1	0.6	0.6	∞
14	Fast SAR z-Approximation	B	7.0	R	$\sqrt{3}$	1	1	4.0	4.0	∞
Test sample related										
15	Test sample positioning	A	3.3	N	1	1	1	3.3	3.3	5
16	Device holder uncertainty	A	3.4	N	1	1	1	3.4	3.4	5
17	Drift of output power	B	5.0	R	$\sqrt{3}$	1	1	2.9	2.9	∞
Phantom and set-up										
18	Phantom uncertainty	B	1.0	R	$\sqrt{3}$	1	1	0.6	0.6	∞
19	Liquid conductivity (target)	B	5.0	R	$\sqrt{3}$	0.64	0.43	1.8	1.2	∞
20	Liquid conductivity (meas.)	A	1.3	N	1	0.64	0.43	0.83	0.56	43
21	Liquid permittivity (target)	B	5.0	R	$\sqrt{3}$	0.6	0.49	1.7	1.4	∞
22	Liquid permittivity (meas.)	A	1.6	N	1	0.6	0.49	0.96	0.78	521
Combined standard uncertainty		$u_c = \sqrt{\sum_{i=1}^{22} c_i^2 u_i^2}$						11.1	11.0	257
Expanded uncertainty (Confidence interval of 95 %)		$u_e = 2u_c$						22.2	22.0	

17 Main Test Instruments

Table 17.1: List of Main Instruments

No.	Name	Type	Serial Number	Calibration Date	Valid Period
01	Network analyzer	Agilent E5071C	MY46103759	2018-11-16	One year
02	Dielectric probe	85070E	MY44300317	/	/
03	Power meter	E4418B	MY50000366	2018-12-14	One year
04	Power sensor	E9304A	MY50000188		
05	Power meter	NRP	101460	2019-02-04	One year
06	Power sensor	NRP-Z91	100553		
07	Signal Generator	E8257D	MY47461211	2019-06-03	One year
08	Amplifier	VTL5400	0404	/	/
09	E-field Probe	SPEAG EX3DV4	3633	2019-02-26	One year
10	DAE	SPEAG DAE4	786	2019-01-11	One year
11	Dipole Validation Kit	SPEAG D750V3	1163	2019-09-03	Three year
12	Dipole Validation Kit	SPEAG D835V2	4d057	2018-10-09	Three year
13	Dipole Validation Kit	SPEAG D1750V2	1152	2019-08-30	Three year
14	Dipole Validation Kit	SPEAG D1900V2	5d088	2018-10-24	Three year
15	Dipole Validation Kit	SPEAG D2450V2	873	2018-10-26	Three year
16	Dipole Validation Kit	SPEAG D2550V2	1058	2018-08-24	Three year
18	BTS	E5515C	GB46110722	2019-01-18	One year
17	Radio Communication Analyzer	Anristu MT8820C	6201341853	2019-03-07	One year
19	Radio Communication Analyzer	Anristu MT8821C	6201563766	2019-05-16	One year

END OF REPORT BODY

ANNEX A Graph Results

GSM850 Head

Date: 2019-5-30

Electronics: DAE4 Sn786

Medium: Head 835MHz

Medium parameters used (interpolated): $f = 836.6$ MHz; $\sigma = 0.916$ S/m; $\epsilon_r = 40.429$; $\rho = 1000$ kg/m³

Ambient Temperature: 22.0°C Liquid Temperature: 21.5°C

Communication System: UID 0, GSM (0) Frequency: 836.6 MHz Duty Cycle: 1:8.3

Probe: EX3DV4 – SN3633 ConvF (9.51, 9.51, 9.51);

Right Cheek Middle/Area Scan (61x101x1): Interpolated grid: $dx=1.500$ mm, $dy=1.500$ mm
Maximum value of SAR (interpolated) = 0.426 W/kg

Right Cheek Middle/Zoom Scan (5x5x7)/Cube 0: Measurement grid: $dx=8$ mm, $dy=8$ mm, $dz=5$ mm

Reference Value = 6.957 V/m; Power Drift = 0.09 dB

Peak SAR (extrapolated) = 0.545 W/kg

SAR(1 g) = 0.395 W/kg; SAR(10 g) = 0.284 W/kg

Maximum value of SAR (measured) = 0.471 W/kg

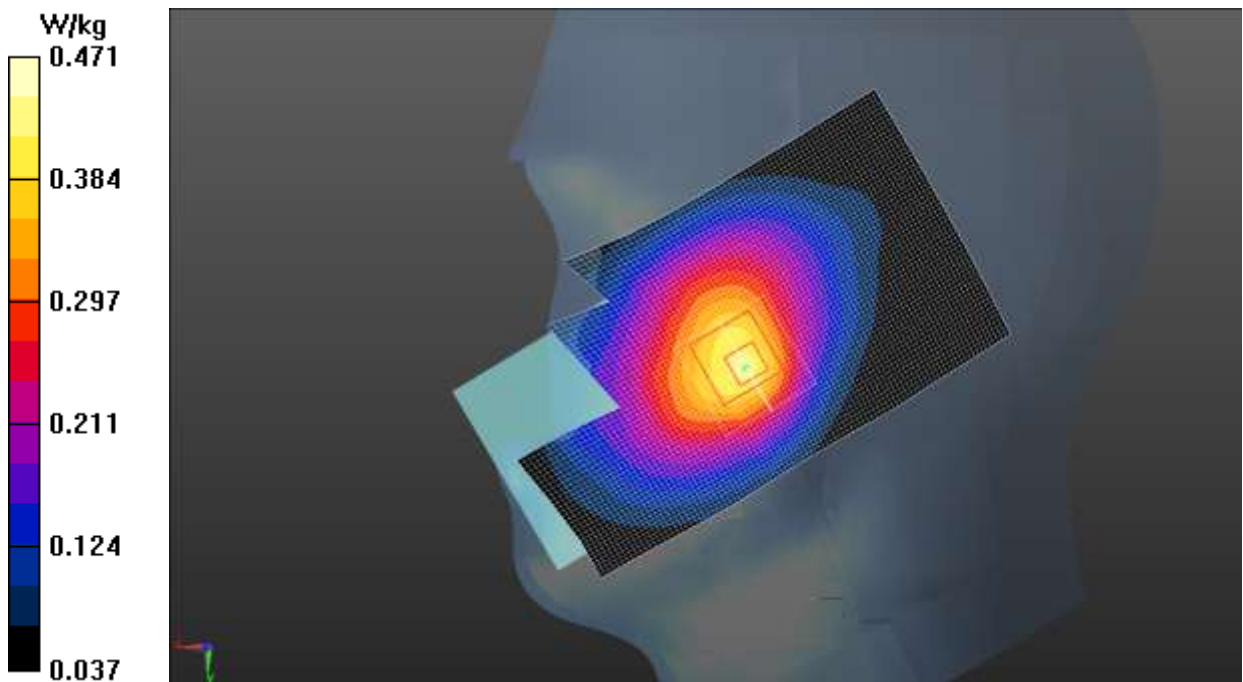

Fig.1 GSM 850

GSM850 Body

Date: 2019-5-30

Electronics: DAE4 Sn786

Medium: Head 835MHz

Medium parameters used (interpolated): $f = 836.6$ MHz; $\sigma = 0.916$ S/m; $\epsilon_r = 40.429$; $\rho = 1000$ kg/m³

Ambient Temperature: 22.0°C Liquid Temperature: 21.5°C

Communication System: UID 0, GPRS 2Txslot (0) Frequency: 836.6 MHz Duty Cycle: 1:4

Probe: EX3DV4 – SN3633 ConvF (9.51, 9.51, 9.51);

Front Side Middle/Area Scan (61x111x1): Interpolated grid: dx=1.500 mm, dy=1.500 mm

Maximum value of SAR (interpolated) = 0.677 W/kg

Front Side Middle/Zoom Scan (5x5x7)/Cube 0: Measurement grid: dx=8mm, dy=8mm, dz=5mm

Reference Value = 24.85 V/m; Power Drift = 0.01 dB

Peak SAR (extrapolated) = 0.763 W/kg

SAR(1 g) = 0.578 W/kg; SAR(10 g) = 0.426 W/kg

Maximum value of SAR (measured) = 0.680 W/kg

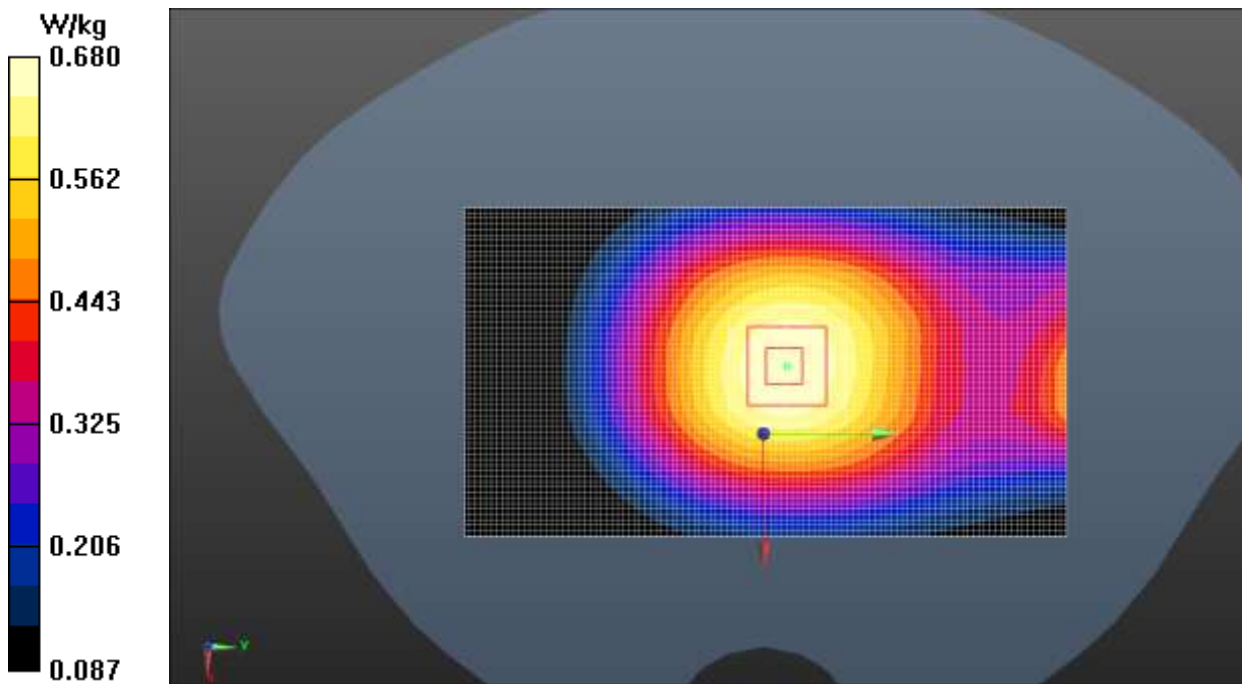

Fig.2 GSM 850

GSM1900 Head

Date: 2019-6-19

Electronics: DAE4 Sn786

Medium: Head 1900MHz

Medium parameters used: $f = 1880 \text{ MHz}$; $\sigma = 1.363 \text{ S/m}$; $\epsilon_r = 40.532$; $\rho = 1000 \text{ kg/m}^3$

Ambient Temperature: 22.0°C Liquid Temperature: 21.5°C

Communication System: UID 0, GSM (0) Frequency: 1880 MHz Duty Cycle: 1:8.3

Probe: EX3DV4 – SN3633 ConvF (7.63, 7.63, 7.63);

Right Cheek Middle/Area Scan (61x101x1): Interpolated grid: $dx=1.500 \text{ mm}$, $dy=1.500 \text{ mm}$

Maximum value of SAR (interpolated) = 0.533 W/kg

Right Cheek Middle/Zoom Scan (5x5x7)/Cube 0: Measurement grid: $dx=8\text{mm}$, $dy=8\text{mm}$, $dz=5\text{mm}$

Reference Value = 2.870 V/m ; Power Drift = 0.03 dB

Peak SAR (extrapolated) = 0.645 W/kg

SAR(1 g) = 0.396 W/kg ; SAR(10 g) = 0.232 W/kg

Maximum value of SAR (measured) = 0.501 W/kg

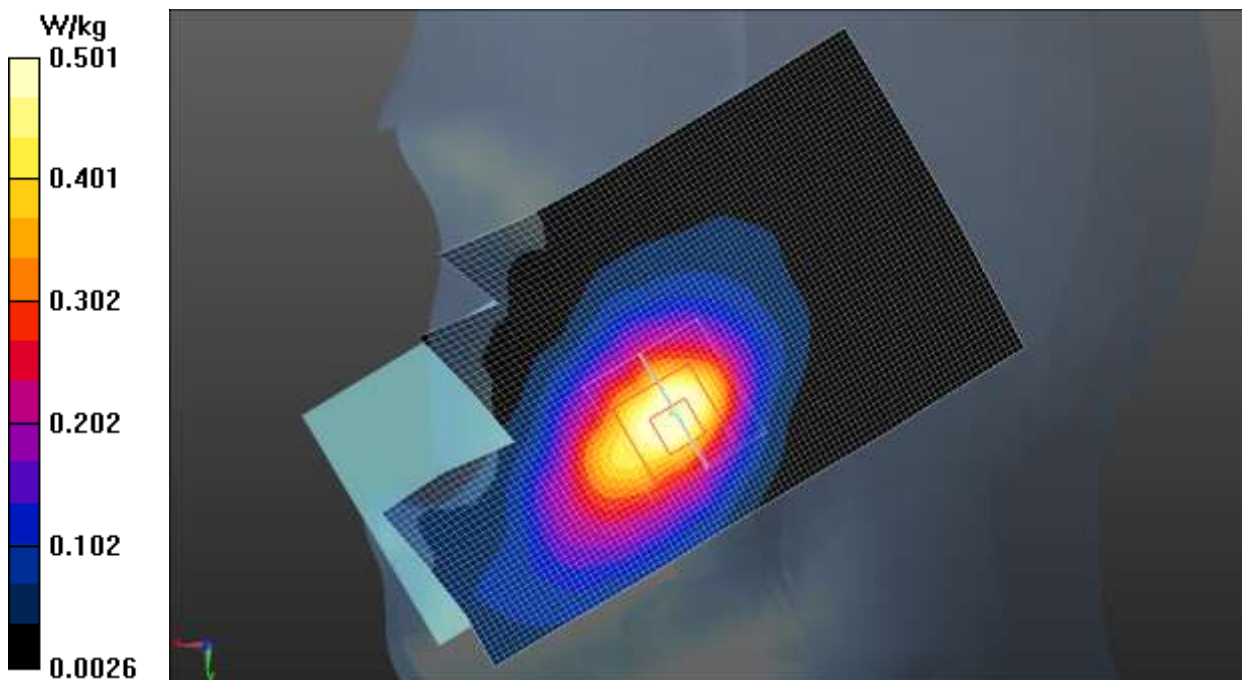

Fig.3 GSM 1900

GSM1900 Body

Date: 2019-6-19

Electronics: DAE4 Sn786

Medium: Head 1900MHz

Medium parameters used: $f = 1880 \text{ MHz}$; $\sigma = 1.363 \text{ S/m}$; $\epsilon_r = 40.532$; $\rho = 1000 \text{ kg/m}^3$

Ambient Temperature: 22.0°C Liquid Temperature: 21.5°C

Communication System: UID 0, GPRS 4Txslot (0) Frequency: 1880 MHz Duty Cycle: 1:2

Probe: EX3DV4 – SN3633 ConvF (7.63, 7.63, 7.63);

Front Side Middle/Area Scan (61x121x1): Interpolated grid: $dx=1.500 \text{ mm}$, $dy=1.500 \text{ mm}$

Maximum value of SAR (interpolated) = 1.67 W/kg

Front Side Middle/Zoom Scan (5x5x7)/Cube 0: Measurement grid: $dx=8\text{mm}$, $dy=8\text{mm}$, $dz=5\text{mm}$

Reference Value = 7.644 V/m ; Power Drift = 0.09 dB

Peak SAR (extrapolated) = 2.15 W/kg

SAR(1 g) = 1.19 W/kg ; SAR(10 g) = 0.612 W/kg

Maximum value of SAR (measured) = 1.67 W/kg

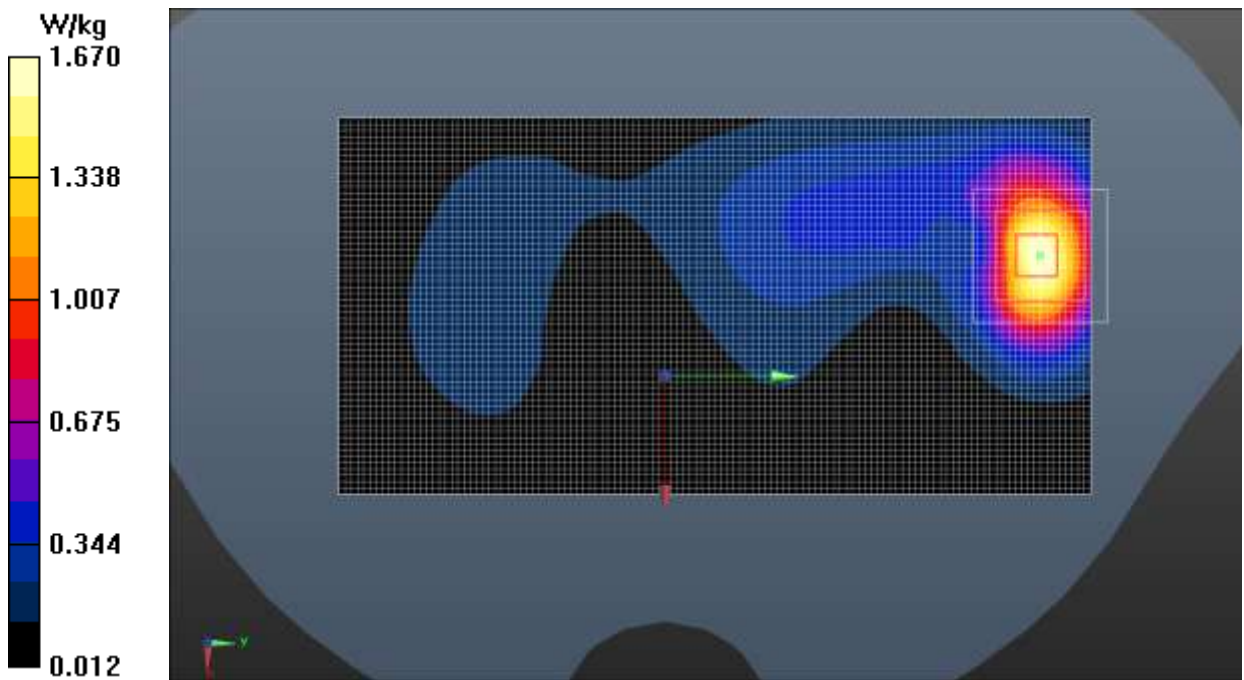

Fig.4 GSM 1900

CDMA BC0 Head

Date: 2019-5-30

Electronics: DAE4 Sn786

Medium: Head 835MHz

Medium parameters used (interpolated): $f = 836.52$ MHz; $\sigma = 0.916$ S/m; $\epsilon_r = 40.43$; $\rho = 1000$ kg/m³

Ambient Temperature: 22.0°C Liquid Temperature: 21.5°C

Communication System: UID 0, CDMA (0) Frequency: 836.52 MHz Duty Cycle: 1:1

Probe: EX3DV4 – SN3633 ConvF (9.51, 9.51, 9.51);

Right Cheek Middle/Area Scan (61x101x1): Interpolated grid: dx=1.500 mm, dy=1.500 mm

Maximum value of SAR (interpolated) = 0.341 W/kg

Right Cheek Middle/Zoom Scan (5x5x7)/Cube 0: Measurement grid: dx=8mm, dy=8mm, dz=5mm

Reference Value = 6.042 V/m; Power Drift = 0.09 dB

Peak SAR (extrapolated) = 0.416 W/kg

SAR(1 g) = 0.322 W/kg; SAR(10 g) = 0.239 W/kg

Maximum value of SAR (measured) = 0.371 W/kg

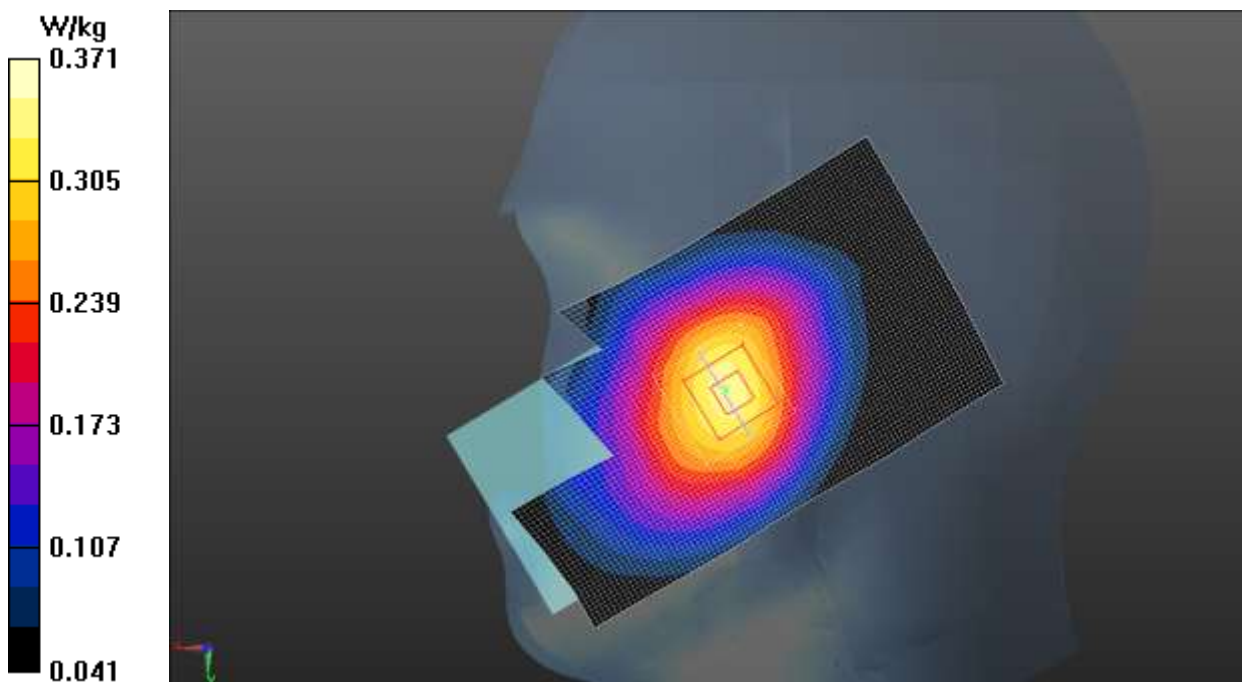

Fig.5 CDMA BC0

CDMA BC0 Body

Date: 2019-5-30

Electronics: DAE4 Sn786

Medium: Head 835MHz

Medium parameters used (interpolated): $f = 836.52$ MHz; $\sigma = 0.916$ S/m; $\epsilon_r = 40.43$; $\rho = 1000$ kg/m³

Ambient Temperature: 22.0°C Liquid Temperature: 21.5°C

Communication System: UID 0, CDMA (0) Frequency: 836.52 MHz Duty Cycle: 1:1

Probe: EX3DV4 – SN3633 ConvF (9.51, 9.51, 9.51);

Front Side Middle/Area Scan (61x111x1): Interpolated grid: dx=1.500 mm, dy=1.500 mm

Maximum value of SAR (interpolated) = 0.303 W/kg

Front Side Middle/Zoom Scan (5x5x7)/Cube 0: Measurement grid: dx=8mm, dy=8mm, dz=5mm

Reference Value = 16.36 V/m; Power Drift = 0.08 dB

Peak SAR (extrapolated) = 0.338 W/kg

SAR(1 g) = 0.265 W/kg; SAR(10 g) = 0.193 W/kg

Maximum value of SAR (measured) = 0.301 W/kg

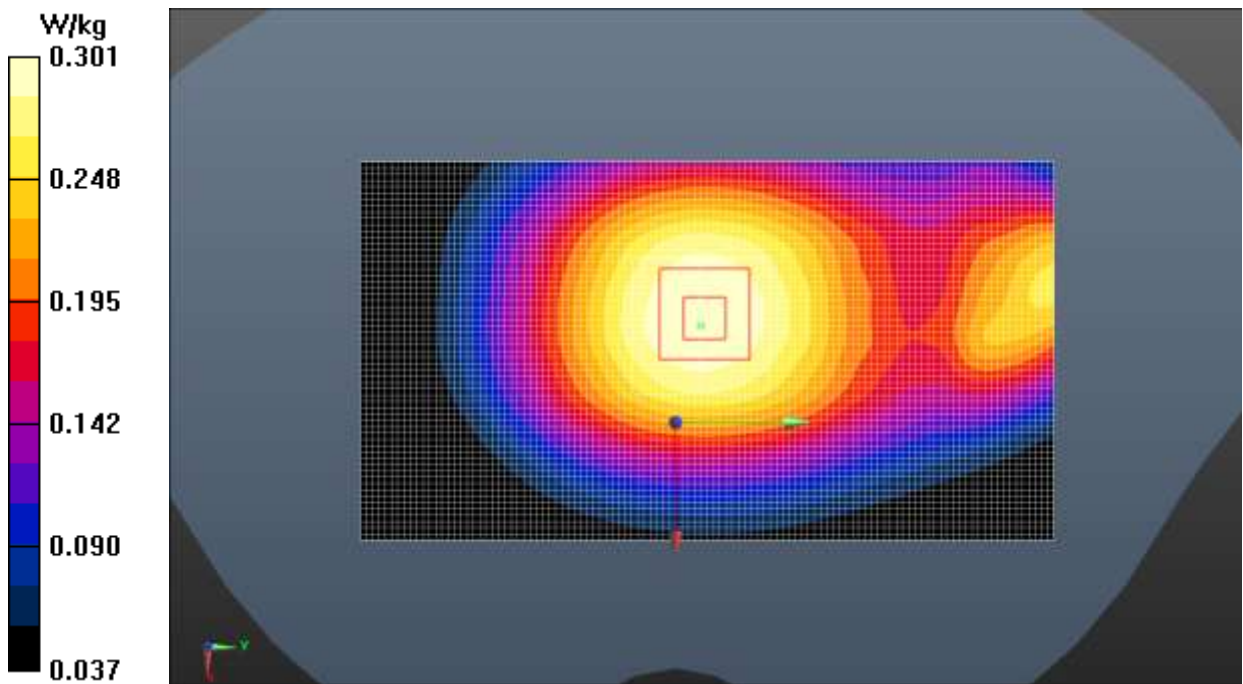

Fig.6 CDMA BC0

CDMA BC1 Head

Date: 2019-6-19

Electronics: DAE4 Sn786

Medium: Head 1900MHz

Medium parameters used: $f = 1880$ MHz; $\sigma = 1.363$ S/m; $\epsilon_r = 40.532$; $\rho = 1000$ kg/m³

Ambient Temperature: 22.0°C Liquid Temperature: 21.5°C

Communication System: UID 0, CDMA (0) Frequency: 1880 MHz Duty Cycle: 1:1

Probe: EX3DV4 – SN3633 ConvF (7.63, 7.63, 7.63);

Right Cheek Middle/Area Scan (61x101x1): Interpolated grid: dx=1.500 mm, dy=1.500 mm

Maximum value of SAR (interpolated) = 0.753 W/kg

Right Cheek Middle/Zoom Scan (5x5x7)/Cube 0: Measurement grid: dx=8mm, dy=8mm, dz=5mm

Reference Value = 3.110 V/m; Power Drift = 0.05 dB

Peak SAR (extrapolated) = 0.904 W/kg

SAR(1 g) = 0.569 W/kg; SAR(10 g) = 0.339 W/kg

Maximum value of SAR (measured) = 0.732 W/kg

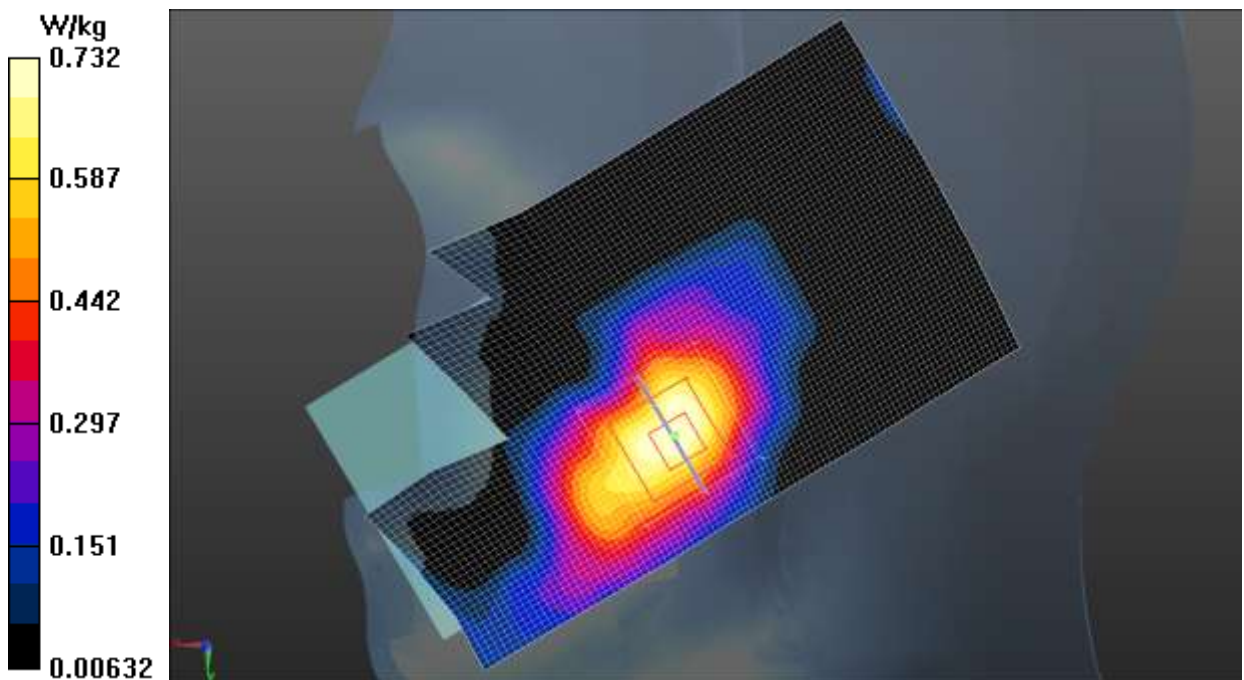

Fig.7 CDMA BC1

CDMA BC1 Body

Date: 2019-6-19

Electronics: DAE4 Sn786

Medium: Head 1900MHz

Medium parameters used: $f = 1880 \text{ MHz}$; $\sigma = 1.363 \text{ S/m}$; $\epsilon_r = 40.532$; $\rho = 1000 \text{ kg/m}^3$

Ambient Temperature: 22.0°C Liquid Temperature: 21.5°C

Communication System: UID 0, CDMA (0) Frequency: 1880 MHz Duty Cycle: 1:1

Probe: EX3DV4 – SN3633 ConvF (7.63, 7.63, 7.63);

Front Side Middle/Area Scan (61x111x1): Interpolated grid: $dx=1.500 \text{ mm}$, $dy=1.500 \text{ mm}$

Maximum value of SAR (interpolated) = 1.28 W/kg

Front Side Middle/Zoom Scan (5x5x7)/Cube 0: Measurement grid: $dx=8\text{mm}$, $dy=8\text{mm}$, $dz=5\text{mm}$

Reference Value = 8.362 V/m ; Power Drift = 0.11 dB

Peak SAR (extrapolated) = 1.62 W/kg

SAR(1 g) = 0.921 W/kg ; SAR(10 g) = 0.477 W/kg

Maximum value of SAR (measured) = 1.27 W/kg

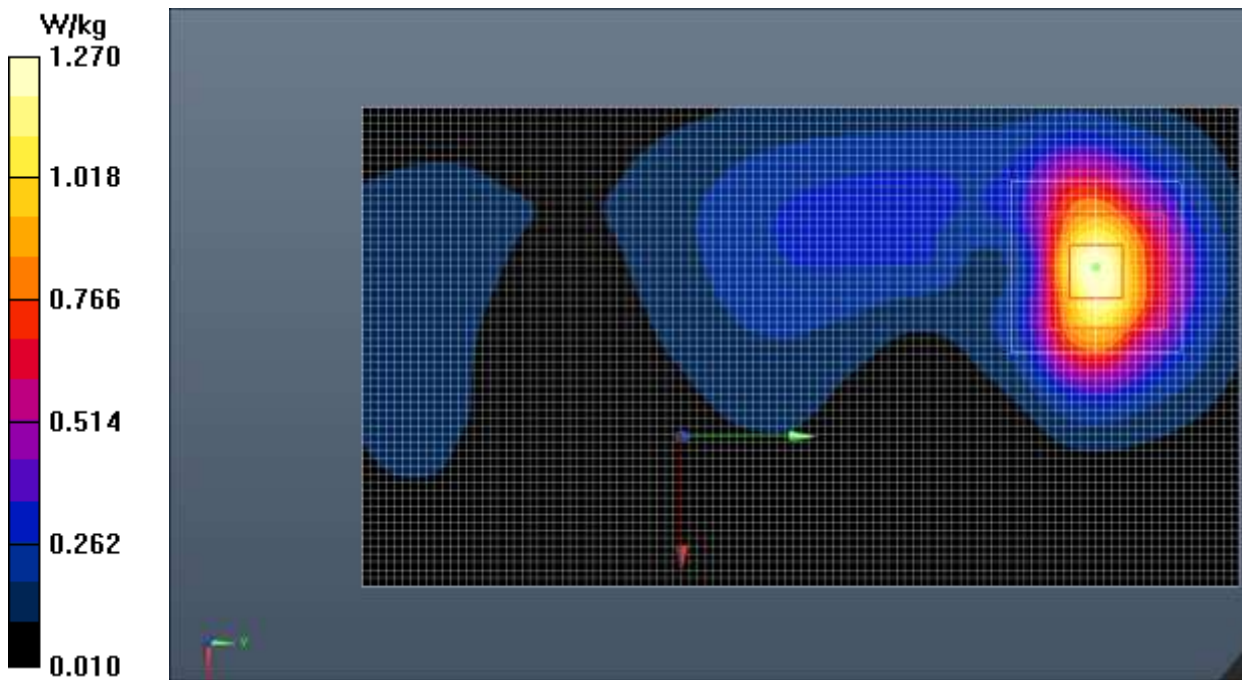

Fig.8 CDMA BC1

CDMA BC10 Head

Date: 2019-5-30

Electronics: DAE4 Sn786

Medium: Head 835MHz

Medium parameters used (interpolated): $f = 820.5$ MHz; $\sigma = 0.909$ S/m; $\epsilon_r = 40.488$; $\rho = 1000$ kg/m³

Ambient Temperature: 22.0°C Liquid Temperature: 21.5°C

Communication System: UID 0, CDMA (0) Frequency: 820.5 MHz Duty Cycle: 1:1

Probe: EX3DV4 – SN3633 ConvF (9.51, 9.51, 9.51);

Left Cheek Middle/Area Scan (61x101x1): Interpolated grid: dx=1.500 mm, dy=1.500 mm

Maximum value of SAR (interpolated) = 0.267 W/kg

Left Cheek Middle/Zoom Scan (5x5x7)/Cube 0: Measurement grid: dx=8mm, dy=8mm, dz=5mm

Reference Value = 5.189 V/m; Power Drift = 0.02 dB

Peak SAR (extrapolated) = 0.346 W/kg

SAR(1 g) = 0.259 W/kg; SAR(10 g) = 0.188 W/kg

Maximum value of SAR (measured) = 0.306 W/kg

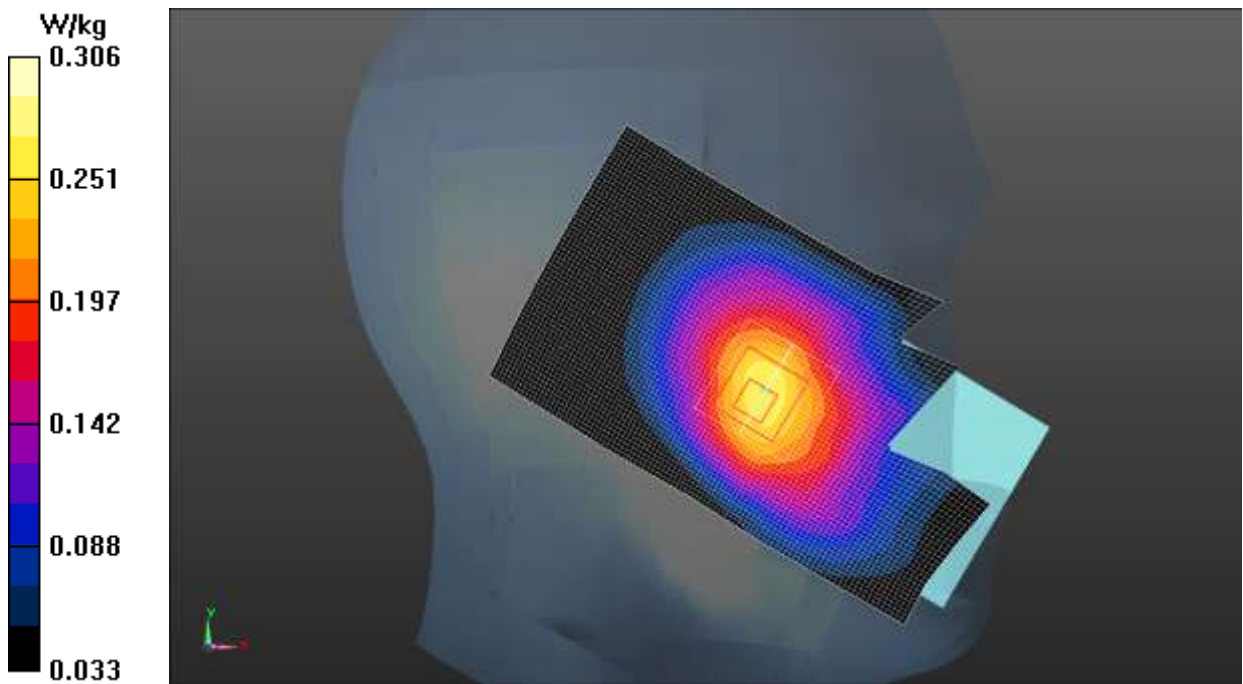

Fig.9 CDMA BC10

CDMA BC10 Body

Date: 2019-5-30

Electronics: DAE4 Sn786

Medium: Head 835MHz

Medium parameters used (interpolated): $f = 820.5$ MHz; $\sigma = 0.909$ S/m; $\epsilon_r = 40.488$; $\rho = 1000$ kg/m³

Ambient Temperature: 22.0°C Liquid Temperature: 21.5°C

Communication System: UID 0, CDMA (0) Frequency: 820.5 MHz Duty Cycle: 1:1

Probe: EX3DV4 – SN3633 ConvF (9.51, 9.51, 9.51);

Front Side Middle/Area Scan (61x111x1): Interpolated grid: dx=1.500 mm, dy=1.500 mm

Maximum value of SAR (interpolated) = 0.256 W/kg

Front Side Middle/Zoom Scan (5x5x7)/Cube 0: Measurement grid: dx=8mm, dy=8mm, dz=5mm

Reference Value = 15.06 V/m; Power Drift = 0.02 dB

Peak SAR (extrapolated) = 0.286 W/kg

SAR(1 g) = 0.217 W/kg; SAR(10 g) = 0.160 W/kg

Maximum value of SAR (measured) = 0.255 W/kg

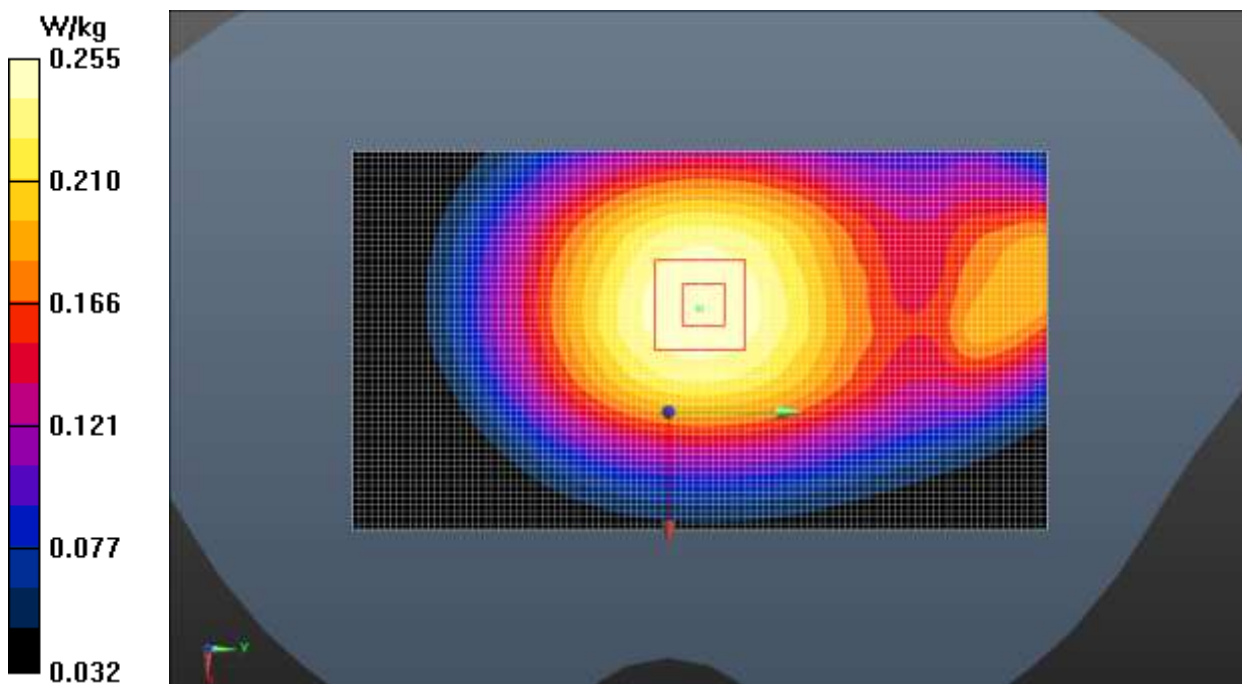

Fig.10 CDMA BC10

WCDMA 850 Head

Date: 2019-5-30

Electronics: DAE4 Sn786

Medium: Head 835MHz

Medium parameters used (interpolated): $f = 836.4$ MHz; $\sigma = 0.916$ S/m; $\epsilon_r = 40.431$; $\rho = 1000$ kg/m³

Ambient Temperature: 22.0°C Liquid Temperature: 21.5°C

Communication System: UID 0, WCDMA (0) Frequency: 836.4 MHz Duty Cycle: 1:1

Probe: EX3DV4 – SN3633 ConvF (9.51, 9.51, 9.51);

Left Cheek Middle/Area Scan (61x101x1): Interpolated grid: dx=1.500 mm, dy=1.500 mm

Maximum value of SAR (interpolated) = 0.348 W/kg

Left Cheek Middle/Zoom Scan (5x5x7)/Cube 0: Measurement grid: dx=8mm, dy=8mm, dz=5mm

Reference Value = 5.387 V/m; Power Drift = 0.03 dB

Peak SAR (extrapolated) = 0.438 W/kg

SAR(1 g) = 0.332 W/kg; SAR(10 g) = 0.242 W/kg

Maximum value of SAR (measured) = 0.389 W/kg

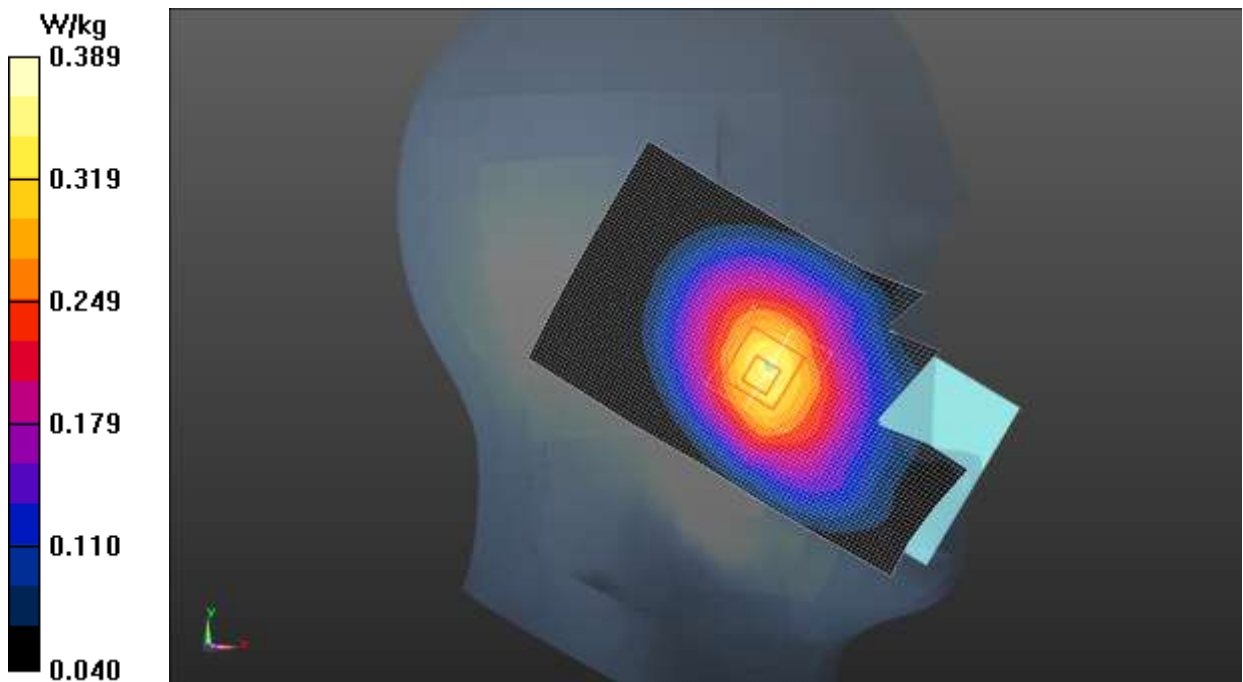

Fig.11 WCDMA 850

WCDMA 850 Body

Date: 2019-5-30

Electronics: DAE4 Sn786

Medium: Head 835MHz

Medium parameters used (interpolated): $f = 836.4$ MHz; $\sigma = 0.916$ S/m; $\epsilon_r = 40.431$; $\rho = 1000$ kg/m³

Ambient Temperature: 22.0°C Liquid Temperature: 21.5°C

Communication System: UID 0, WCDMA (0) Frequency: 836.4 MHz Duty Cycle: 1:1

Probe: EX3DV4 – SN3633 ConvF (9.51, 9.51, 9.51);

Rear Side Middle/Area Scan (61x111x1): Interpolated grid: dx=1.500 mm, dy=1.500 mm

Maximum value of SAR (interpolated) = 0.324 W/kg

Rear Side Middle/Zoom Scan (5x5x7)/Cube 0: Measurement grid: dx=8mm, dy=8mm, dz=5mm

Reference Value = 15.65 V/m; Power Drift = -0.14 dB

Peak SAR (extrapolated) = 0.365 W/kg

SAR(1 g) = 0.281 W/kg; SAR(10 g) = 0.208 W/kg

Maximum value of SAR (measured) = 0.324 W/kg

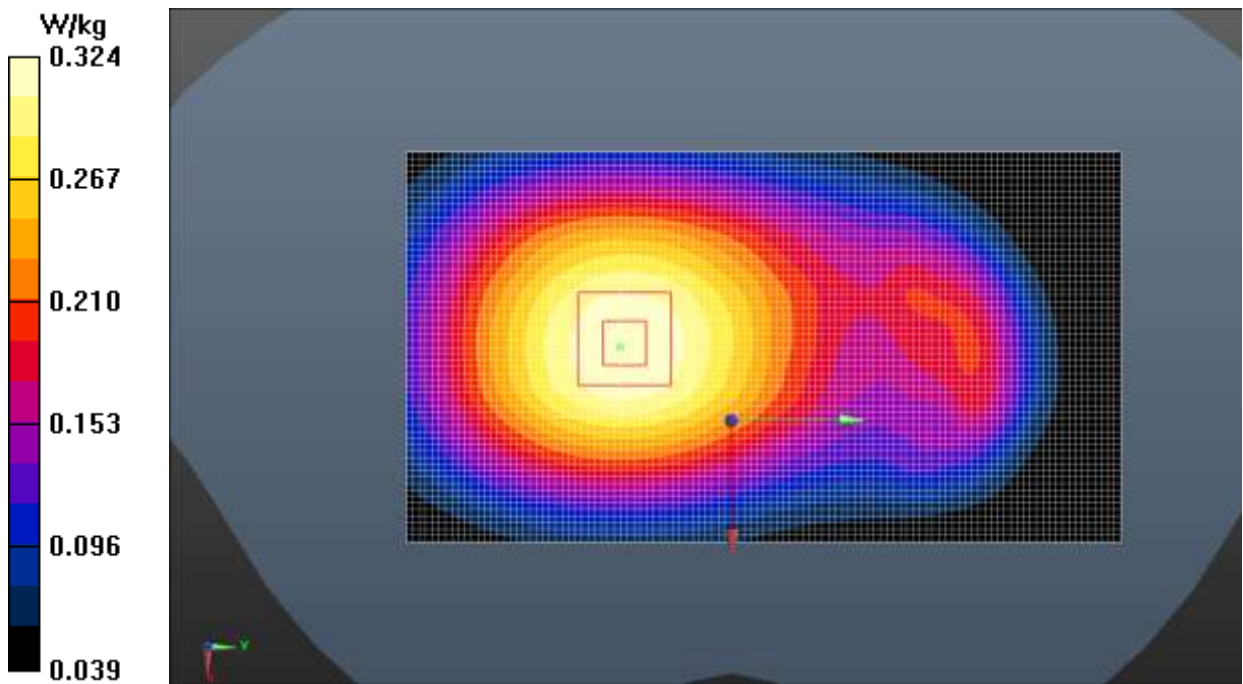

Fig.12 WCDMA 850

WCDMA 1900 Head

Date: 2019-6-19

Electronics: DAE4 Sn786

Medium: Head 1900MHz

Medium parameters used: $f = 1880 \text{ MHz}$; $\sigma = 1.363 \text{ S/m}$; $\epsilon_r = 40.532$; $\rho = 1000 \text{ kg/m}^3$

Ambient Temperature: 22.0°C Liquid Temperature: 21.5°C

Communication System: UID 0, WCDMA (0) Frequency: 1880 MHz Duty Cycle: 1:1

Probe: EX3DV4 – SN3633 ConvF (7.63, 7.63, 7.63);

Right Cheek Middle/Area Scan (61x101x1): Interpolated grid: $dx=1.500 \text{ mm}$, $dy=1.500 \text{ mm}$

Maximum value of SAR (interpolated) = 0.851 W/kg

Right Cheek Middle/Zoom Scan (5x5x7)/Cube 0: Measurement grid: $dx=8\text{mm}$, $dy=8\text{mm}$, $dz=5\text{mm}$

Reference Value = 6.399 V/m ; Power Drift = 0.09 dB

Peak SAR (extrapolated) = 0.995 W/kg

SAR(1 g) = 0.644 W/kg ; SAR(10 g) = 0.396 W/kg

Maximum value of SAR (measured) = 0.799 W/kg

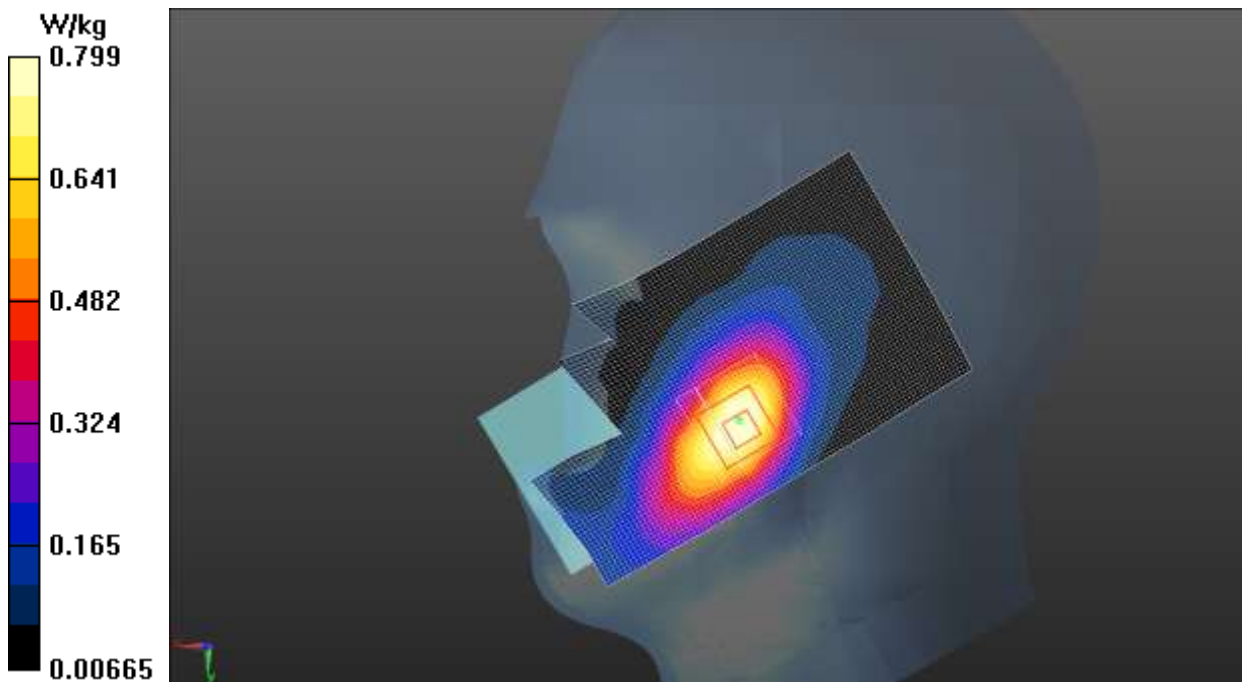

Fig.13 WCDMA 1900

WCDMA 1900 Body

Date: 2019-6-19

Electronics: DAE4 Sn786

Medium: Head 1900MHz

Medium parameters used: $f = 1880 \text{ MHz}$; $\sigma = 1.363 \text{ S/m}$; $\epsilon_r = 40.532$; $\rho = 1000 \text{ kg/m}^3$

Ambient Temperature: 22.0°C Liquid Temperature: 21.5°C

Communication System: UID 0, WCDMA (0) Frequency: 1880 MHz Duty Cycle: 1:1

Probe: EX3DV4 – SN3633 ConvF (7.63, 7.63, 7.63);

Front Side Middle/Area Scan (61x111x1): Interpolated grid: $dx=1.500 \text{ mm}$, $dy=1.500 \text{ mm}$

Maximum value of SAR (interpolated) = 1.46 W/kg

Front Side Middle/Zoom Scan (5x5x7)/Cube 0: Measurement grid: $dx=8\text{mm}$, $dy=8\text{mm}$, $dz=5\text{mm}$

Reference Value = 8.937 V/m ; Power Drift = 0.04 dB

Peak SAR (extrapolated) = 2.01 W/kg

SAR(1 g) = 1.12 W/kg ; SAR(10 g) = 0.591 W/kg

Maximum value of SAR (measured) = 1.52 W/kg

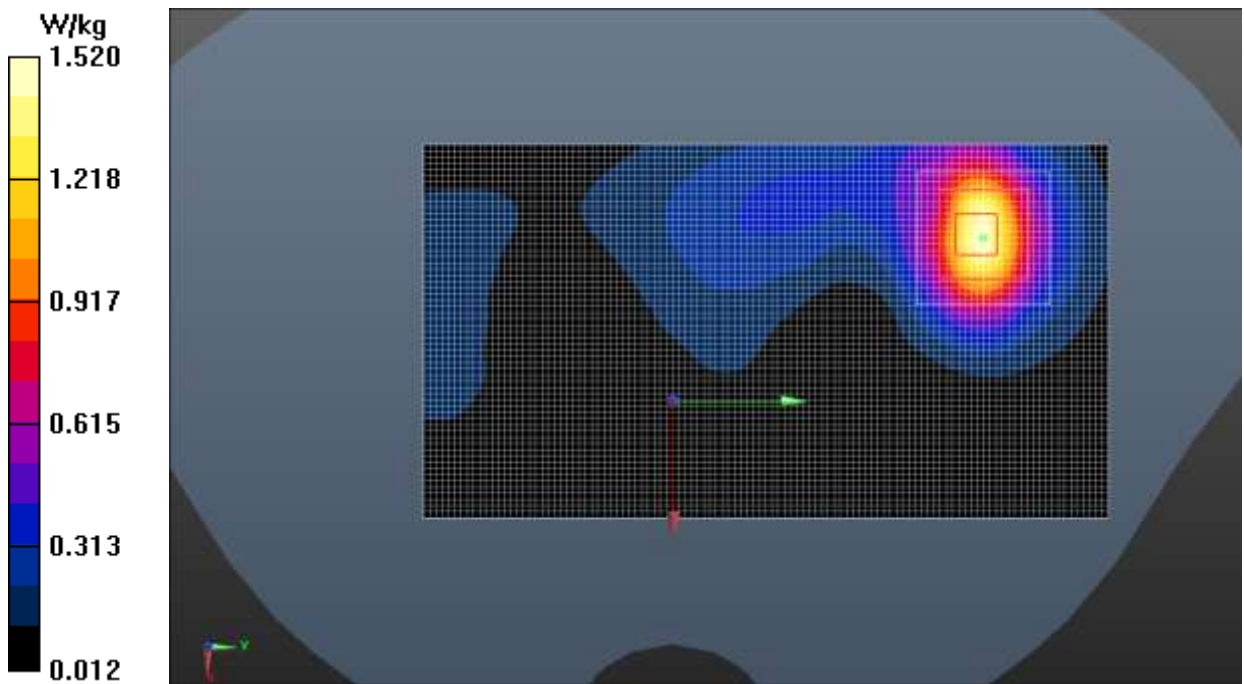

Fig.14 WCDMA 1900

WCDMA 1700 Head

Date: 2019-6-4

Electronics: DAE4 Sn786

Medium: Head 1750MHz

Medium parameters used (interpolated): $f = 1732.6$ MHz; $\sigma = 1.345$ S/m; $\epsilon_r = 40.382$; $\rho = 1000$ kg/m³

Ambient Temperature: 22.0°C Liquid Temperature: 21.5°C

Communication System: UID 0, WCDMA (0) Frequency: 1732.6 MHz Duty Cycle: 1:1

Probe: EX3DV4 – SN3633 ConvF (8.07, 8.07, 8.07);

Right Cheek Middle/Area Scan (61x101x1): Interpolated grid: dx=1.500 mm, dy=1.500 mm

Maximum value of SAR (interpolated) = 0.248 W/kg

Right Cheek Middle/Zoom Scan (5x5x7)/Cube 0: Measurement grid: dx=8mm, dy=8mm, dz=5mm

Reference Value = 2.065 V/m; Power Drift = 0.08 dB

Peak SAR (extrapolated) = 0.294 W/kg

SAR(1 g) = 0.193 W/kg; SAR(10 g) = 0.121 W/kg

Maximum value of SAR (measured) = 0.238 W/kg

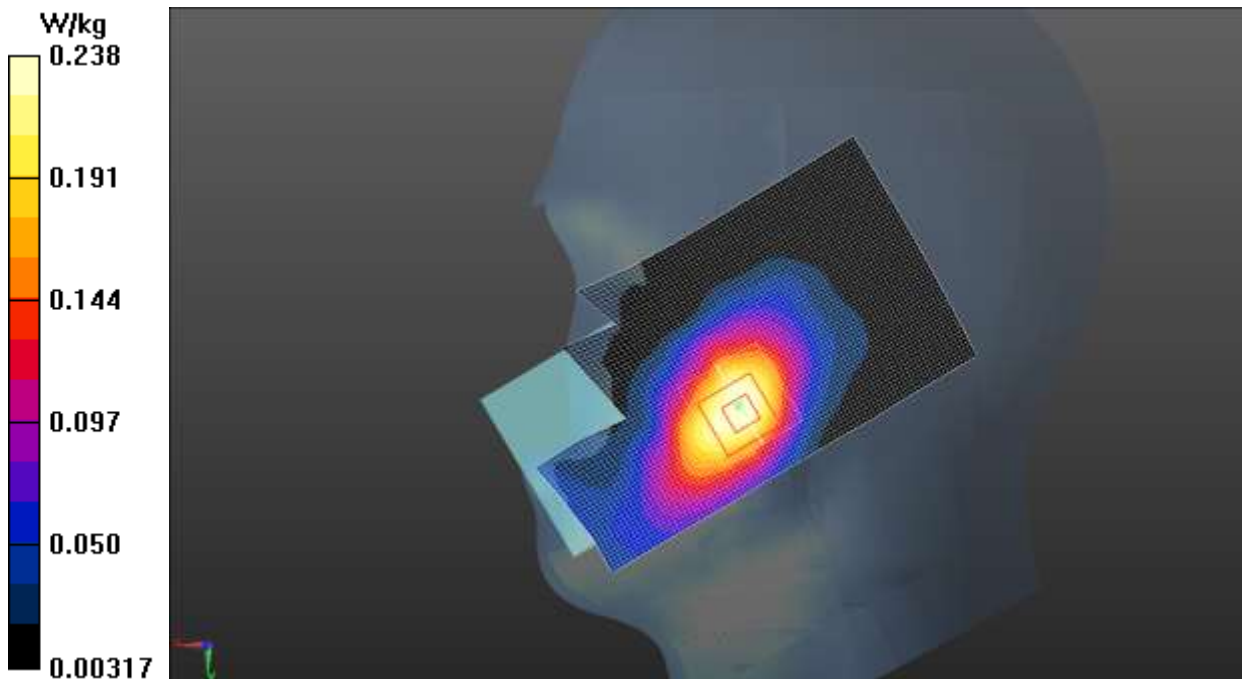

Fig.15 WCDMA 1700

WCDMA 1700 Body

Date: 2019-6-4

Electronics: DAE4 Sn786

Medium: Head 1750MHz

Medium parameters used (interpolated): $f = 1732.6$ MHz; $\sigma = 1.345$ S/m; $\epsilon_r = 40.382$; $\rho = 1000$ kg/m³

Ambient Temperature: 22.0°C Liquid Temperature: 21.5°C

Communication System: UID 0, WCDMA (0) Frequency: 1732.6 MHz Duty Cycle: 1:1

Probe: EX3DV4 – SN3633 ConvF (8.07, 8.07, 8.07);

Front Side Middle/Area Scan (61x111x1): Interpolated grid: dx=1.500 mm, dy=1.500 mm

Maximum value of SAR (interpolated) = 0.674 W/kg

Front Side Middle/Zoom Scan (5x5x7)/Cube 0: Measurement grid: dx=8mm, dy=8mm, dz=5mm

Reference Value = 4.260 V/m; Power Drift = 0.06 dB

Peak SAR (extrapolated) = 0.879 W/kg

SAR(1 g) = 0.504 W/kg; SAR(10 g) = 0.269 W/kg

Maximum value of SAR (measured) = 0.682 W/kg

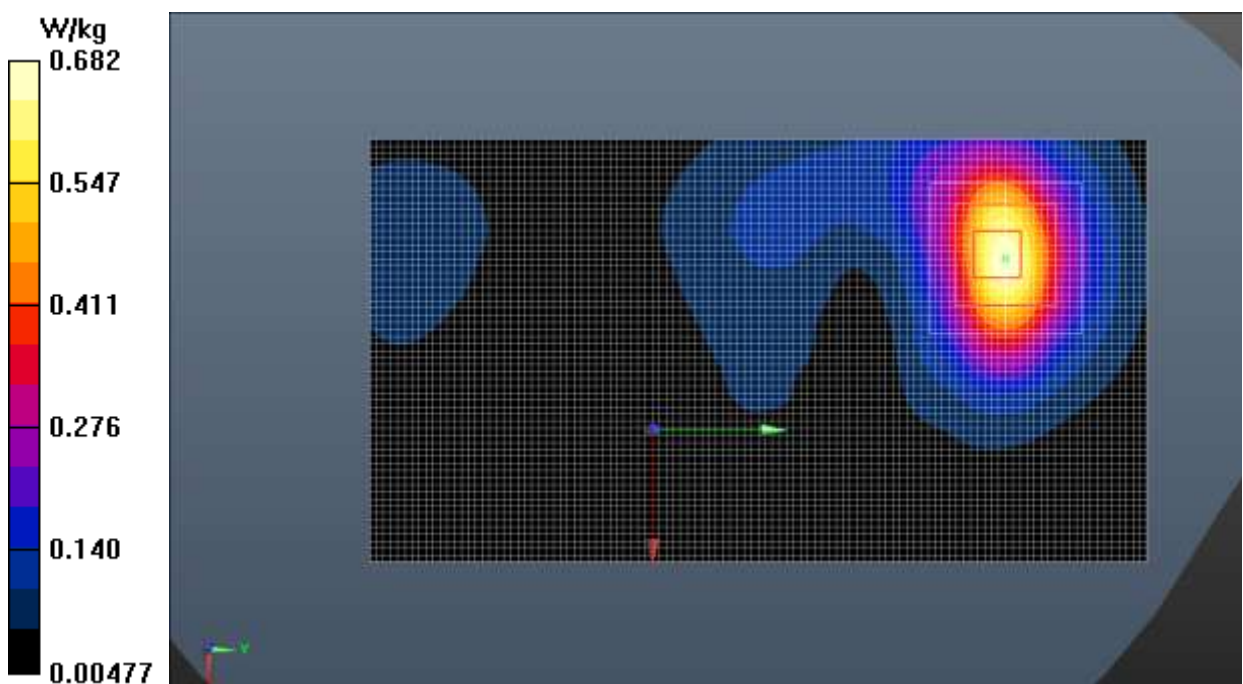

Fig.16 WCDMA 1700

LTE Band 2 Head

Date: 2019-6-20

Electronics: DAE4 Sn786

Medium: Head 1900MHz

Medium parameters used: $f = 1860$ MHz; $\sigma = 1.35$ S/m; $\epsilon_r = 40.415$; $\rho = 1000$ kg/m³

Ambient Temperature: 22.0°C Liquid Temperature: 21.5°C

Communication System: UID 0, LTE_FDD (0) Frequency: 1860 MHz Duty Cycle: 1:1

Probe: EX3DV4 – SN3633 ConvF (7.63, 7.63, 7.63);

Right Cheek Low 1RB_Mid/Area Scan (61x101x1): Interpolated grid: dx=1.500 mm, dy=1.500 mm

Maximum value of SAR (interpolated) = 0.690 W/kg

Right Cheek Low 1RB_Mid/Zoom Scan (5x5x7)/Cube 0: Measurement grid: dx=8mm, dy=8mm, dz=5mm

Reference Value = 4.521 V/m; Power Drift = 0.02 dB

Peak SAR (extrapolated) = 0.844 W/kg

SAR(1 g) = 0.533 W/kg; SAR(10 g) = 0.320 W/kg

Maximum value of SAR (measured) = 0.685 W/kg

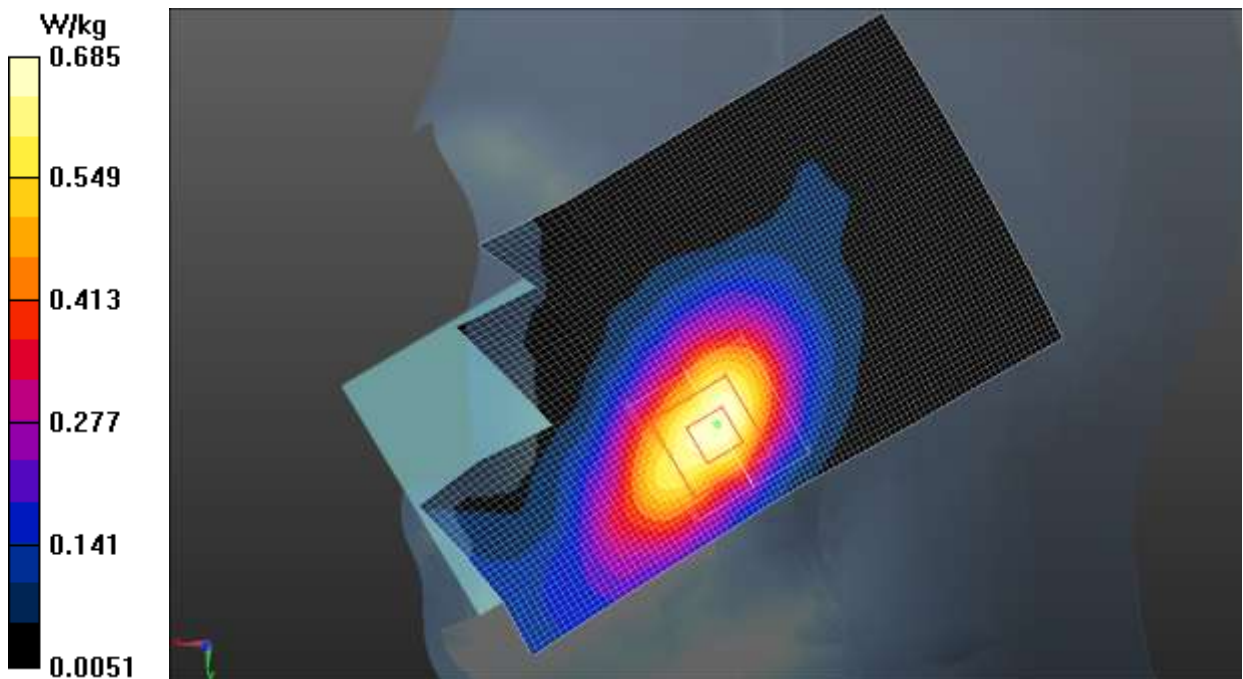

Fig.17 LTE Band 2

LTE Band 2 Body

Date: 2019-6-20

Electronics: DAE4 Sn786

Medium: Head 1900MHz

Medium parameters used: $f = 1860$ MHz; $\sigma = 1.35$ S/m; $\epsilon_r = 40.415$; $\rho = 1000$ kg/m³

Ambient Temperature: 22.0°C Liquid Temperature: 21.5°C

Communication System: UID 0, LTE_FDD (0) Frequency: 1860 MHz Duty Cycle: 1:1

Probe: EX3DV4 – SN3633 ConvF (7.63, 7.63, 7.63);

Front Side Low 1RB_Mid/Area Scan (61x61x1): Interpolated grid: dx=1.500 mm, dy=1.500 mm

Maximum value of SAR (interpolated) = 1.25 W/kg

Front Side Low 1RB_Mid/Zoom Scan (5x5x7)/Cube 0: Measurement grid: dx=8mm, dy=8mm, dz=5mm

Reference Value = 6.518 V/m; Power Drift = 0.07 dB

Peak SAR (extrapolated) = 1.60 W/kg

SAR(1 g) = 0.899 W/kg; SAR(10 g) = 0.465 W/kg

Maximum value of SAR (measured) = 1.27 W/kg

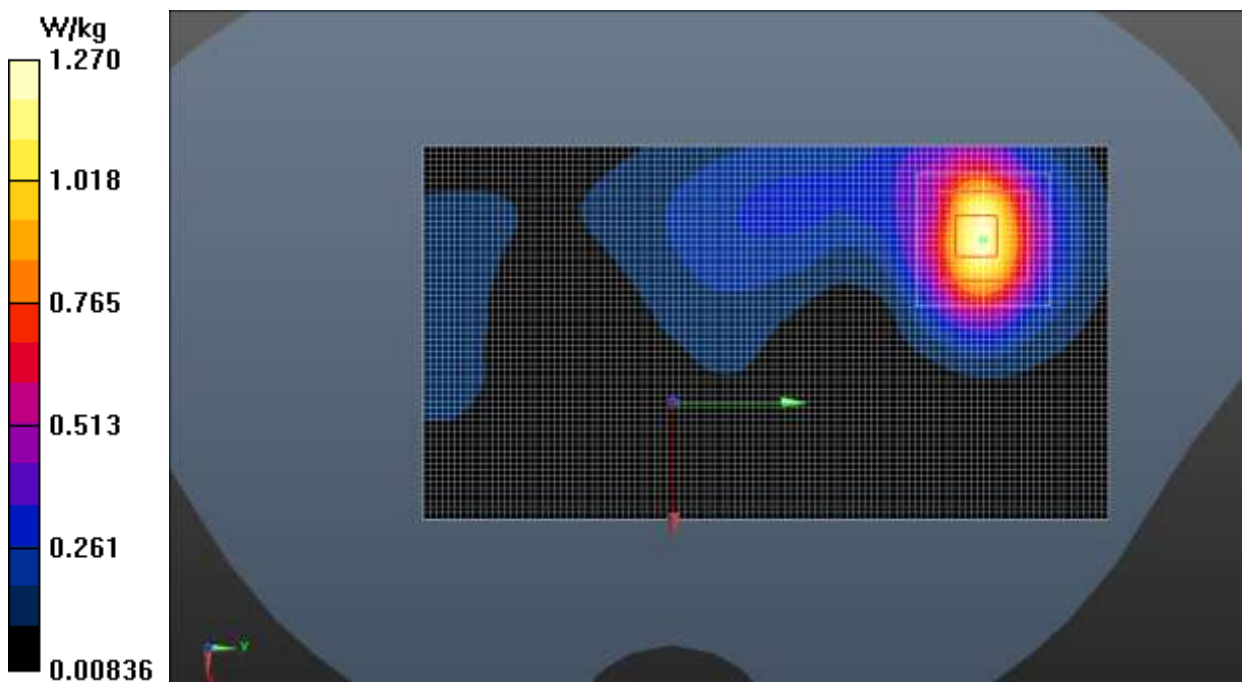

Fig.18 LTE Band 2

LTE Band 4 Head

Date: 2019-6-4

Electronics: DAE4 Sn786

Medium: Head 1750MHz

Medium parameters used: $f = 1745 \text{ MHz}$; $\sigma = 1.357 \text{ S/m}$; $\epsilon_r = 40.544$; $\rho = 1000 \text{ kg/m}^3$

Ambient Temperature: 22.0°C Liquid Temperature: 21.5°C

Communication System: UID 0, LTE_FDD (0) Frequency: 1745 MHz Duty Cycle: 1:1

Probe: EX3DV4 – SN3633 ConvF (8.07, 8.07, 8.07);

Right Cheek High 1RB_Mid/Area Scan (61x101x1): Interpolated grid: $dx=1.500 \text{ mm}$, $dy=1.500 \text{ mm}$

Maximum value of SAR (interpolated) = 0.352 W/kg

Right Cheek High 1RB_Mid/Zoom Scan (5x5x7)/Cube 0: Measurement grid: $dx=8\text{mm}$, $dy=8\text{mm}$, $dz=5\text{mm}$

Reference Value = 1.715 V/m ; Power Drift = 0.04 dB

Peak SAR (extrapolated) = 0.430 W/kg

SAR(1 g) = 0.276 W/kg ; SAR(10 g) = 0.169 W/kg

Maximum value of SAR (measured) = 0.352 W/kg

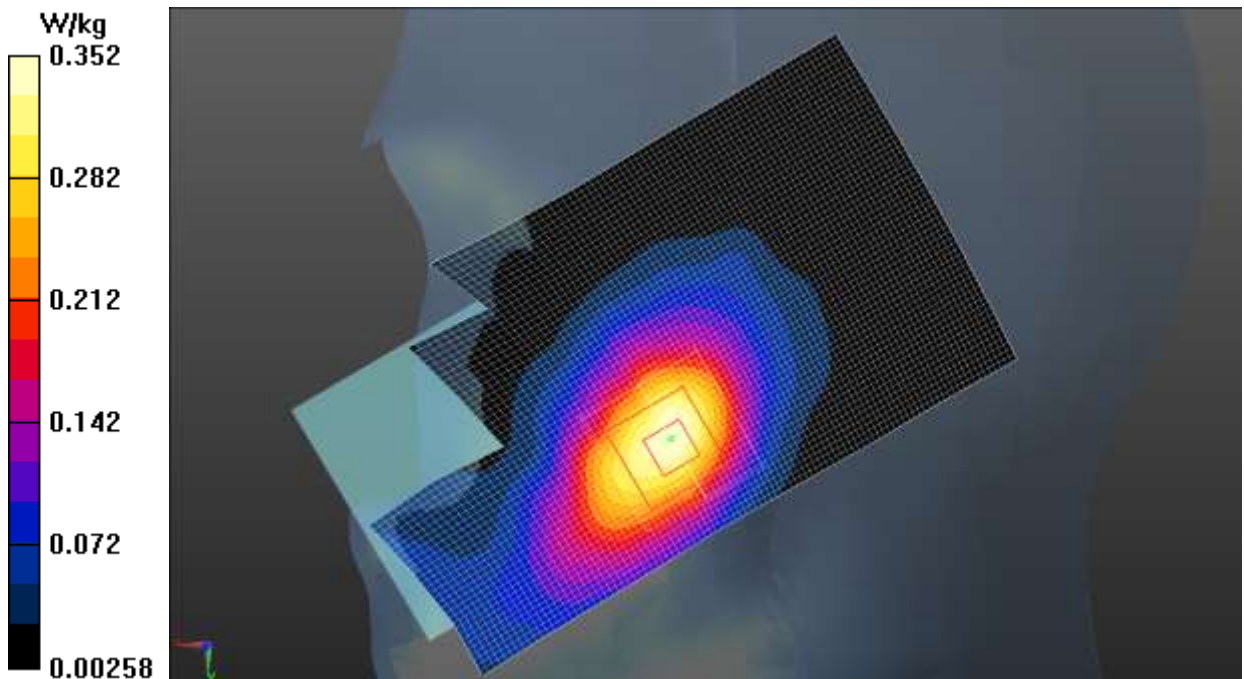

Fig.19 LTE Band 4

LTE Band 4 Body

Date: 2019-6-4

Electronics: DAE4 Sn786

Medium: Head 1750MHz

Medium parameters used: $f = 1745 \text{ MHz}$; $\sigma = 1.357 \text{ S/m}$; $\epsilon_r = 40.544$; $\rho = 1000 \text{ kg/m}^3$

Ambient Temperature: 22.0°C Liquid Temperature: 21.5°C

Communication System: UID 0, LTE_FDD (0) Frequency: 1745 MHz Duty Cycle: 1:1

Probe: EX3DV4 – SN3633 ConvF (8.07, 8.07, 8.07);

Front Side High 1RB_Mid/Area Scan (61x111x1): Interpolated grid: $dx=1.500 \text{ mm}$, $dy=1.500 \text{ mm}$

Maximum value of SAR (interpolated) = 0.599 W/kg

Front Side High 1RB_Mid/Zoom Scan (5x5x7)/Cube 0: Measurement grid: $dx=8\text{mm}$, $dy=8\text{mm}$, $dz=5\text{mm}$

Reference Value = 4.848 V/m; Power Drift = 0.09 dB

Peak SAR (extrapolated) = 0.832 W/kg

SAR(1 g) = 0.505 W/kg; SAR(10 g) = 0.272 W/kg

Maximum value of SAR (measured) = 0.611 W/kg

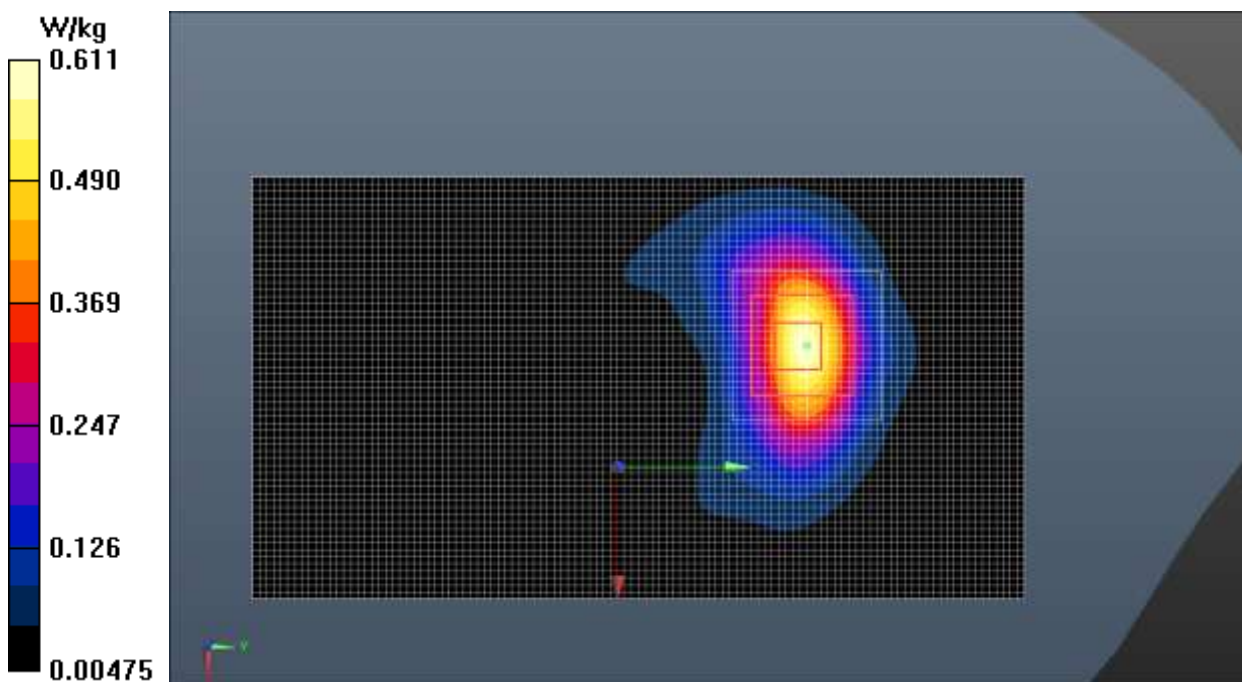

Fig.20 LTE Band 4

LTE Band 5 Head

Date: 2019-5-31

Electronics: DAE4 Sn786

Medium: Head 835MHz

Medium parameters used (interpolated): $f = 836.5$ MHz; $\sigma = 0.924$ S/m; $\epsilon_r = 40.427$; $\rho = 1000$ kg/m³

Ambient Temperature: 22.0°C Liquid Temperature: 21.5°C

Communication System: UID 0, LTE_FDD (0) Frequency: 836.5 MHz Duty Cycle: 1:1

Probe: EX3DV4 – SN3633 ConvF (9.51, 9.51, 9.51);

Right Cheek Middle 1RB_Mid/Area Scan (61x101x1): Interpolated grid: dx=1.500 mm, dy=1.500 mm

Maximum value of SAR (interpolated) = 0.287 W/kg

Right Cheek Middle 1RB_Mid/Zoom Scan (5x5x7)/Cube 0: Measurement grid: dx=8mm, dy=8mm, dz=5mm

Reference Value = 6.615 V/m; Power Drift = 0.14 dB

Peak SAR (extrapolated) = 0.350 W/kg

SAR(1 g) = 0.264 W/kg; SAR(10 g) = 0.194 W/kg

Maximum value of SAR (measured) = 0.311 W/kg

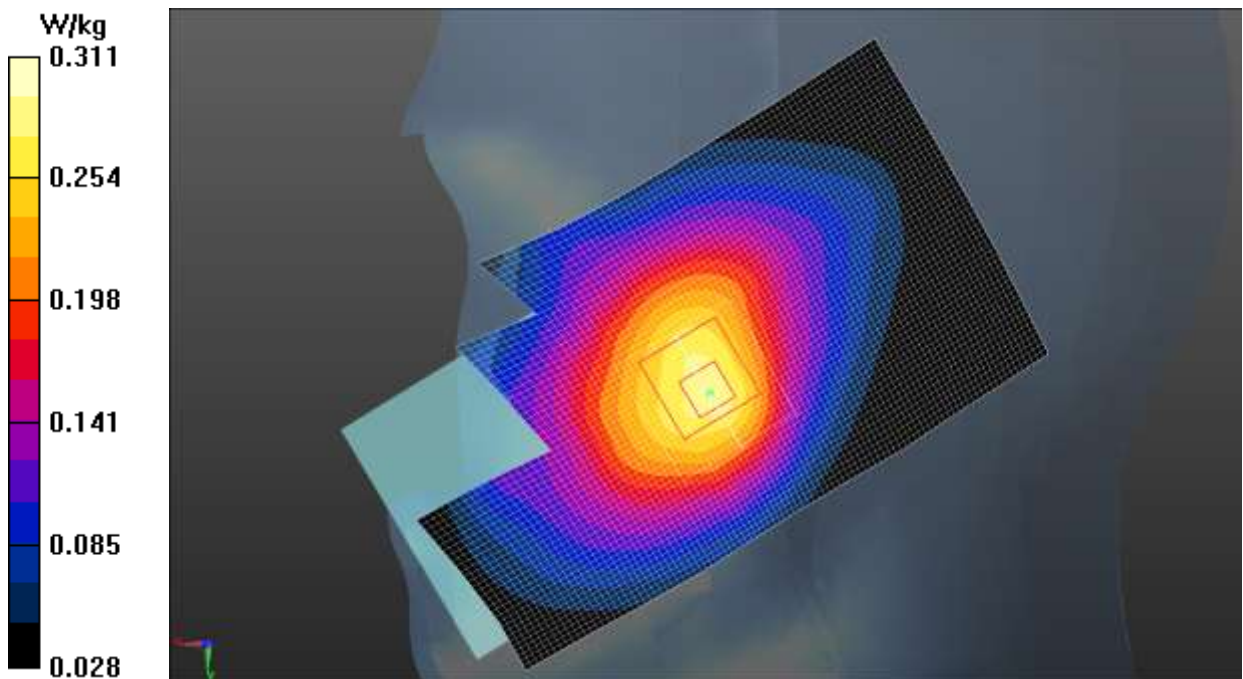

Fig.21 LTE Band 5

LTE Band 5 Body

Date: 2019-5-31

Electronics: DAE4 Sn786

Medium: Head 835MHz

Medium parameters used (interpolated): $f = 836.5$ MHz; $\sigma = 0.924$ S/m; $\epsilon_r = 40.427$; $\rho = 1000$ kg/m³

Ambient Temperature: 22.0°C Liquid Temperature: 21.5°C

Communication System: UID 0, LTE_FDD (0) Frequency: 836.5 MHz Duty Cycle: 1:1

Probe: EX3DV4 – SN3633 ConvF (9.51, 9.51, 9.51);

Rear Side Middle 1RB_Mid/Area Scan (61x111x1): Interpolated grid: dx=1.500 mm, dy=1.500 mm

Maximum value of SAR (interpolated) = 0.358 W/kg

Rear Side Middle 1RB_Mid/Zoom Scan (5x5x7)/Cube 0: Measurement grid: dx=8mm, dy=8mm, dz=5mm

Reference Value = 18.14 V/m; Power Drift = 0.03 dB

Peak SAR (extrapolated) = 0.405 W/kg

SAR(1 g) = 0.305 W/kg; SAR(10 g) = 0.225 W/kg

Maximum value of SAR (measured) = 0.360 W/kg

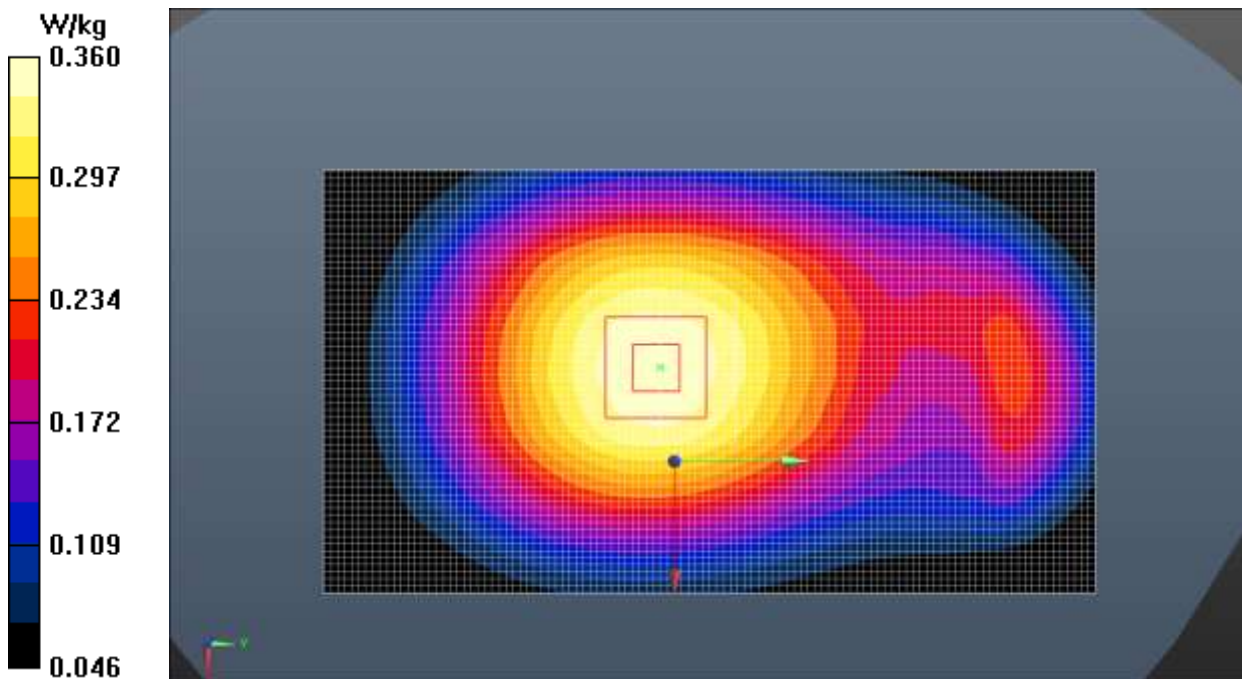

Fig.22 LTE Band 5

LTE Band 12 Head

Date: 2019-6-2

Electronics: DAE4 Sn786

Medium: Head 750MHz

Medium parameters used (interpolated): $f = 711$ MHz; $\sigma = 0.901$ S/m; $\epsilon_r = 41.304$; $\rho = 1000$ kg/m³

Ambient Temperature: 22.0°C Liquid Temperature: 21.5°C

Communication System: UID 0, LTE_FDD (0) Frequency: 711 MHz Duty Cycle: 1:1

Probe: EX3DV4 – SN3633 ConvF (9.51, 9.51, 9.51);

Right Cheek High 1RB_Mid/Area Scan (61x101x1): Interpolated grid: dx=1.500 mm, dy=1.500 mm

Maximum value of SAR (interpolated) = 0.221 W/kg

Right Cheek High 1RB_Mid/Zoom Scan (5x5x7)/Cube 0: Measurement grid: dx=8mm, dy=8mm, dz=5mm

Reference Value = 5.988 V/m; Power Drift = 0.04 dB

Peak SAR (extrapolated) = 0.277 W/kg

SAR(1 g) = 0.209 W/kg; SAR(10 g) = 0.155 W/kg

Maximum value of SAR (measured) = 0.244 W/kg

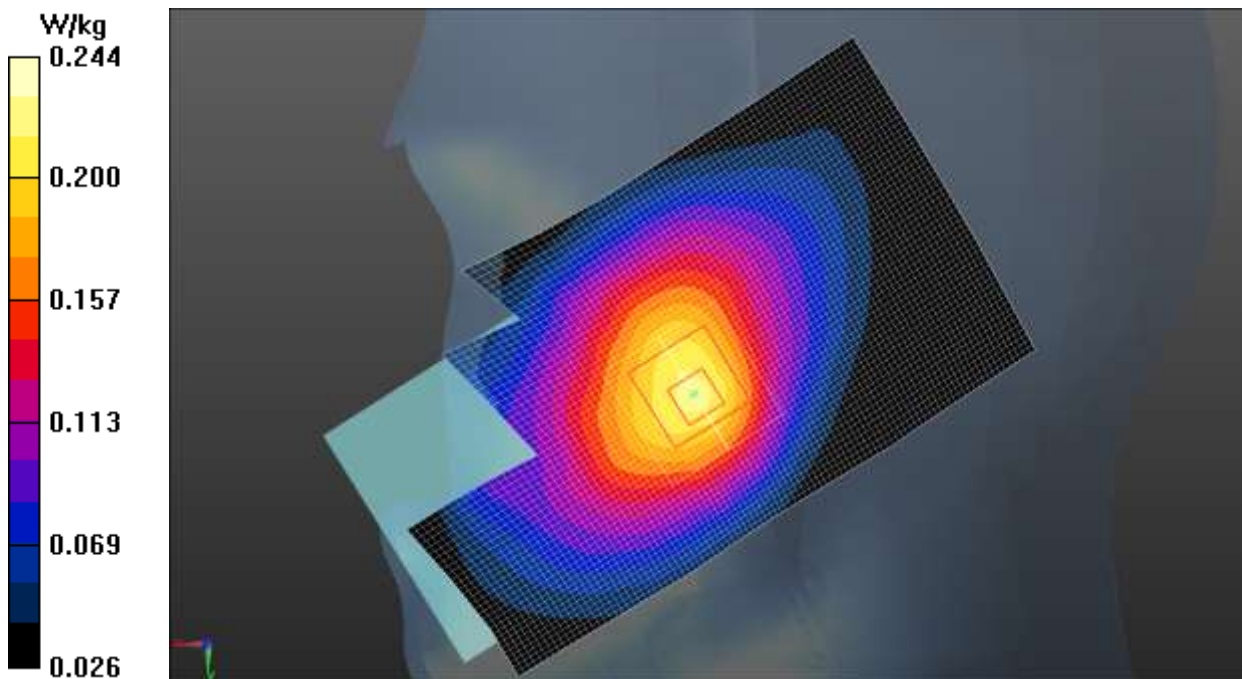

Fig.23 LTE Band 12

LTE Band 12 Body

Date: 2019-6-2

Electronics: DAE4 Sn786

Medium: Head 750MHz

Medium parameters used (interpolated): $f = 711$ MHz; $\sigma = 0.901$ S/m; $\epsilon_r = 41.304$; $\rho = 1000$ kg/m³

Ambient Temperature: 22.0°C Liquid Temperature: 21.5°C

Communication System: UID 0, LTE_FDD (0) Frequency: 711 MHz Duty Cycle: 1:1

Probe: EX3DV4 – SN3633 ConvF (9.51, 9.51, 9.51);

Rear Side High 1RB_Mid/Area Scan (61x111x1): Interpolated grid: dx=1.500 mm, dy=1.500 mm

Maximum value of SAR (interpolated) = 0.286 W/kg

Rear Side High 1RB_Mid/Zoom Scan (5x5x7)/Cube 0: Measurement grid: dx=8mm, dy=8mm, dz=5mm

Reference Value = 16.53 V/m; Power Drift = 0.04 dB

Peak SAR (extrapolated) = 0.324 W/kg

SAR(1 g) = 0.245 W/kg; SAR(10 g) = 0.182 W/kg

Maximum value of SAR (measured) = 0.288 W/kg

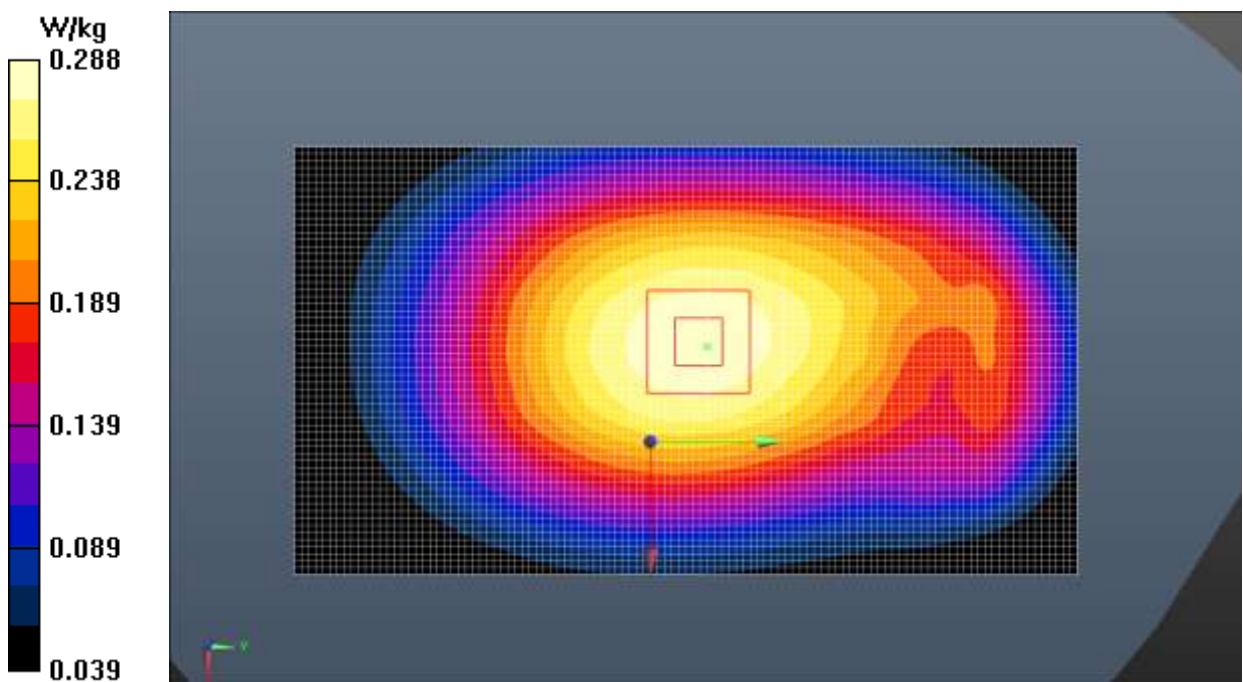

Fig.24 LTE Band 12

LTE Band 13 Head

Date: 2019-6-2

Electronics: DAE4 Sn786

Medium: Head 750MHz

Medium parameters used: $f = 782 \text{ MHz}$; $\sigma = 0.928 \text{ S/m}$; $\epsilon_r = 41.103$; $\rho = 1000 \text{ kg/m}^3$

Ambient Temperature: 22.0°C Liquid Temperature: 21.5°C

Communication System: UID 0, LTE_FDD (0) Frequency: 782 MHz Duty Cycle: 1:1

Probe: EX3DV4 – SN3633 ConvF (9.51, 9.51, 9.51);

Right Cheek Middle 1RB_Mid/Area Scan (61x101x1): Interpolated grid: $dx=1.500 \text{ mm}$, $dy=1.500 \text{ mm}$

Maximum value of SAR (interpolated) = 0.204 W/kg

Right Cheek Middle 1RB_Mid/Zoom Scan (5x5x7)/Cube 0: Measurement grid: $dx=8\text{mm}$, $dy=8\text{mm}$, $dz=5\text{mm}$

Reference Value = 4.856 V/m ; Power Drift = 0.03 dB

Peak SAR (extrapolated) = 0.260 W/kg

SAR(1 g) = 0.198 W/kg ; SAR(10 g) = 0.144 W/kg

Maximum value of SAR (measured) = 0.226 W/kg

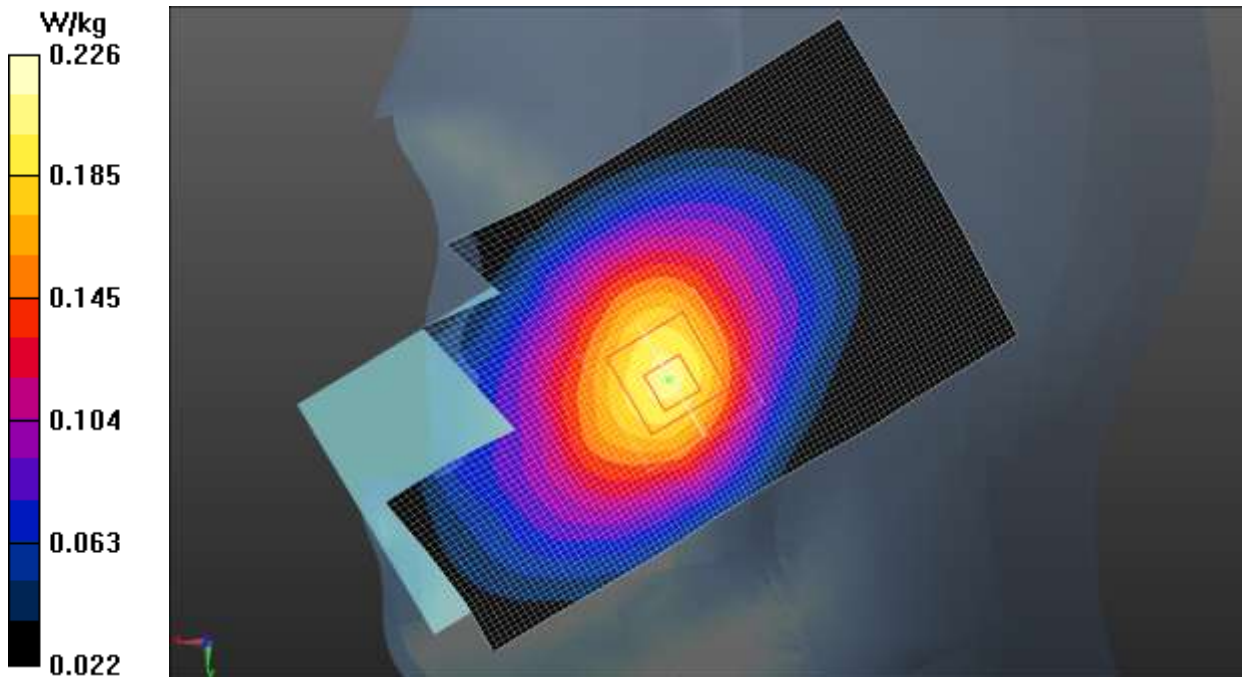

Fig.25 LTE Band 13

LTE Band 13 Body

Date: 2019-6-2

Electronics: DAE4 Sn786

Medium: Head 750MHz

Medium parameters used: $f = 782 \text{ MHz}$; $\sigma = 0.928 \text{ S/m}$; $\epsilon_r = 41.103$; $\rho = 1000 \text{ kg/m}^3$

Ambient Temperature: 22.0°C Liquid Temperature: 21.5°C

Communication System: UID 0, LTE_FDD (0) Frequency: 782 MHz Duty Cycle: 1:1

Probe: EX3DV4 – SN3633 ConvF (9.51, 9.51, 9.51);

Rear Side Middle 1RB_Mid/Area Scan (61x111x1): Interpolated grid: $dx=1.500 \text{ mm}$, $dy=1.500 \text{ mm}$

Maximum value of SAR (interpolated) = 0.238 W/kg

Rear Side Middle 1RB_Mid/Zoom Scan (5x5x7)/Cube 0: Measurement grid: $dx=8\text{mm}$, $dy=8\text{mm}$, $dz=5\text{mm}$

Reference Value = 14.97 V/m ; Power Drift = 0.01 dB

Peak SAR (extrapolated) = 0.267 W/kg

SAR(1 g) = 0.201 W/kg ; SAR(10 g) = 0.149 W/kg

Maximum value of SAR (measured) = 0.237 W/kg

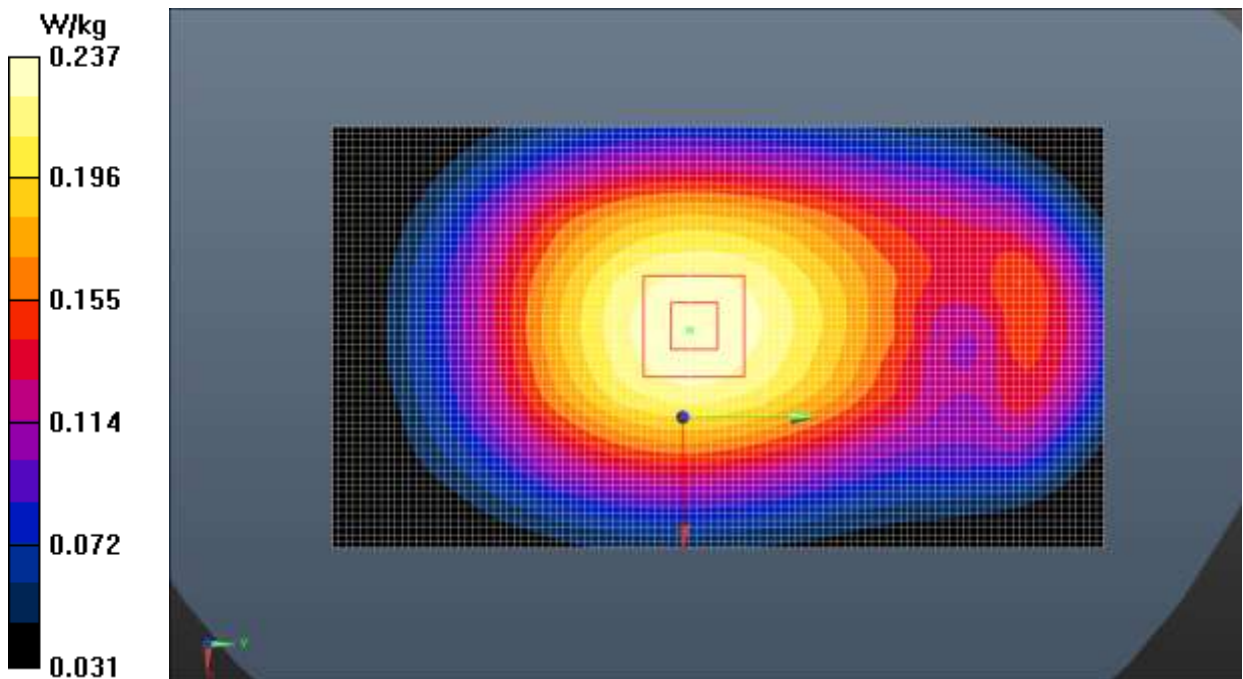

Fig.26 LTE Band 13

LTE Band 25 Head

Date: 2019-6-20

Electronics: DAE4 Sn786

Medium: Head 1900MHz

Medium parameters used: $f = 1860$ MHz; $\sigma = 1.35$ S/m; $\epsilon_r = 40.415$; $\rho = 1000$ kg/m³

Ambient Temperature: 22.0°C Liquid Temperature: 21.5°C

Communication System: UID 0, LTE_FDD (0) Frequency: 1860 MHz Duty Cycle: 1:1

Probe: EX3DV4 – SN3633 ConvF (7.63, 7.63, 7.63);

Right Cheek Low 1RB_Mid/Area Scan (61x101x1): Interpolated grid: dx=1.500 mm, dy=1.500 mm

Maximum value of SAR (interpolated) = 0.693 W/kg

Right Cheek Low 1RB_Mid/Zoom Scan (5x5x7)/Cube 0: Measurement grid: dx=8mm, dy=8mm, dz=5mm

Reference Value = 4.497 V/m; Power Drift = 0.10 dB

Peak SAR (extrapolated) = 0.852 W/kg

SAR(1 g) = 0.549 W/kg; SAR(10 g) = 0.333 W/kg

Maximum value of SAR (measured) = 0.704 W/kg

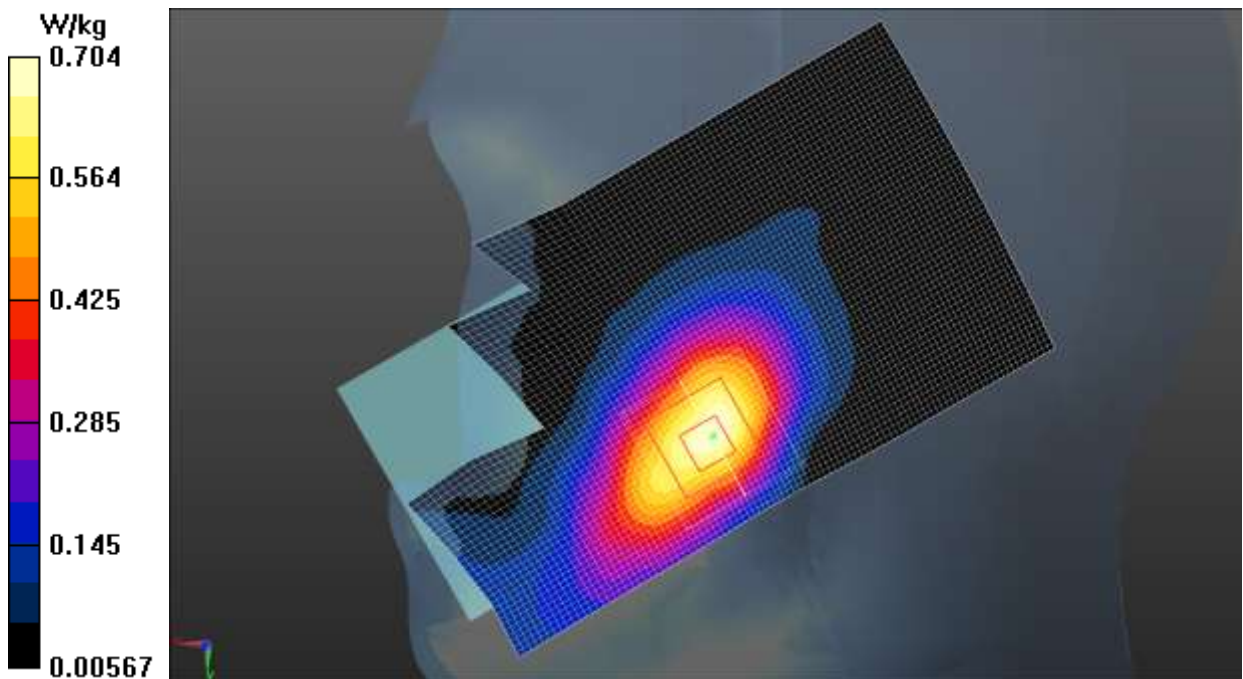

Fig.27 LTE Band 25

LTE Band 25 Body

Date: 2019-6-20

Electronics: DAE4 Sn786

Medium: Head 1900MHz

Medium parameters used: $f = 1860$ MHz; $\sigma = 1.35$ S/m; $\epsilon_r = 40.415$; $\rho = 1000$ kg/m³

Ambient Temperature: 22.0°C Liquid Temperature: 21.5°C

Communication System: UID 0, LTE_FDD (0) Frequency: 1860 MHz Duty Cycle: 1:1

Probe: EX3DV4 – SN3633 ConvF (7.63, 7.63, 7.63);

Front Side Low 1RB_Mid /Area Scan (61x111x1): Interpolated grid: dx=1.500 mm, dy=1.500 mm

Maximum value of SAR (interpolated) = 1.48 W/kg

Front Side Low 1RB_Mid /Zoom Scan (5x5x7)/Cube 0: Measurement grid: dx=8mm, dy=8mm, dz=5mm

Reference Value = 8.939 V/m; Power Drift = 0.01 dB

Peak SAR (extrapolated) = 1.83 W/kg

SAR(1 g) = 1.01 W/kg; SAR(10 g) = 0.513 W/kg

Maximum value of SAR (measured) = 1.36 W/kg

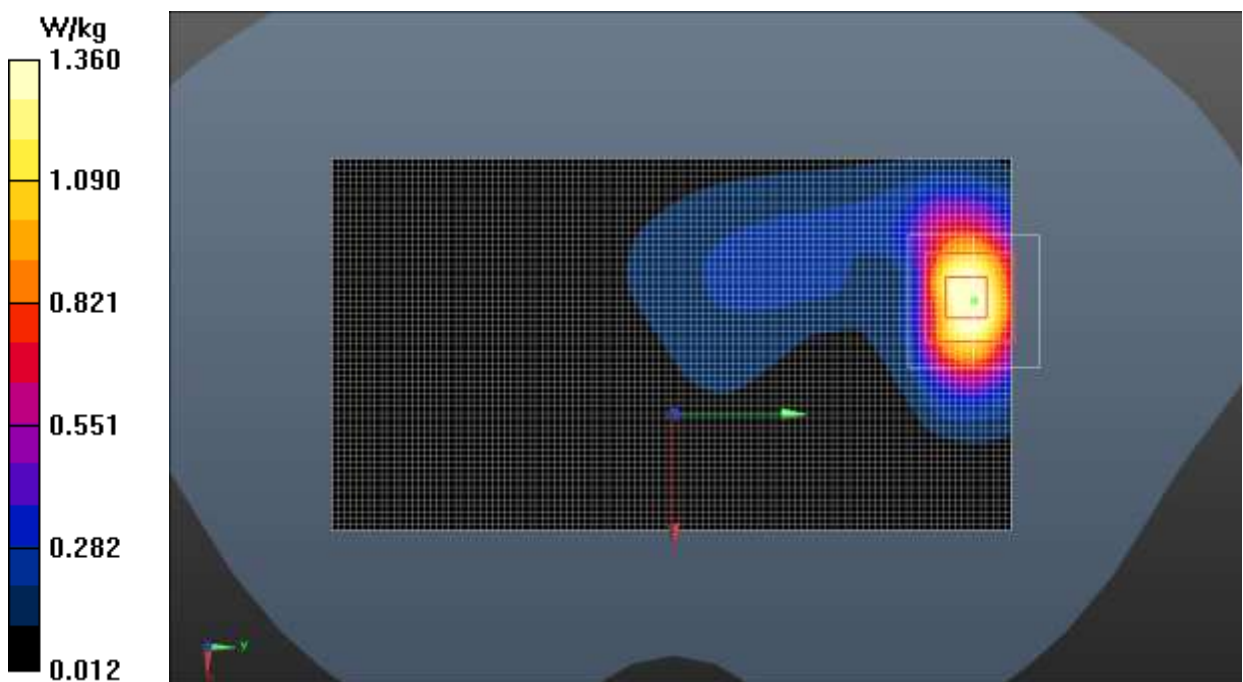

Fig.28 LTE Band 25

LTE Band 26 Head

Date: 2019-5-31

Electronics: DAE4 Sn786

Medium: Head 835MHz

Medium parameters used: $f = 842 \text{ MHz}$; $\sigma = 0.927 \text{ S/m}$; $\epsilon_r = 40.231$; $\rho = 1000 \text{ kg/m}^3$

Ambient Temperature: 22.0°C Liquid Temperature: 21.5°C

Communication System: UID 0, LTE_FDD (0) Frequency: 842 MHz Duty Cycle: 1:1

Probe: EX3DV4 – SN3633 ConvF (9.51, 9.51, 9.51);

Right Cheek High 1RB_Mid/Area Scan (61x101x1): Interpolated grid: $dx=1.500 \text{ mm}$, $dy=1.500 \text{ mm}$

Maximum value of SAR (interpolated) = 0.307 W/kg

Right Cheek High 1RB_Mid/Zoom Scan (5x5x7)/Cube 0: Measurement grid: $dx=8\text{mm}$, $dy=8\text{mm}$, $dz=5\text{mm}$

Reference Value = 6.178 V/m ; Power Drift = 0.05 dB

Peak SAR (extrapolated) = 0.389 W/kg

SAR(1 g) = 0.288 W/kg ; SAR(10 g) = 0.210 W/kg

Maximum value of SAR (measured) = 0.339 W/kg

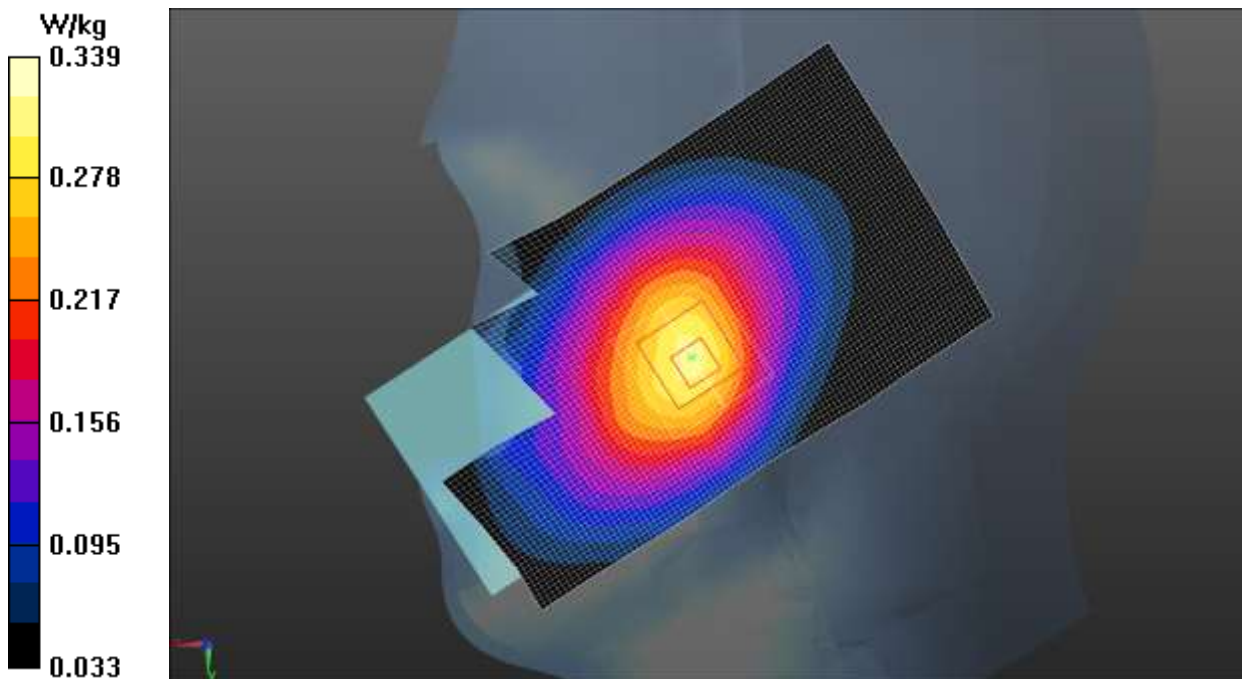

Fig.29 LTE Band 26

LTE Band 26 Body

Date: 2019-5-31

Electronics: DAE4 Sn786

Medium: Head 835MHz

Medium parameters used: $f = 842 \text{ MHz}$; $\sigma = 0.927 \text{ S/m}$; $\epsilon_r = 40.231$; $\rho = 1000 \text{ kg/m}^3$

Ambient Temperature: 22.0°C Liquid Temperature: 21.5°C

Communication System: UID 0, LTE_FDD (0) Frequency: 842 MHz Duty Cycle: 1:1

Probe: EX3DV4 – SN3633 ConvF (9.51, 9.51, 9.51);

Rear Side High 1RB_Mid/Area Scan (61x111x1): Interpolated grid: $dx=1.500 \text{ mm}$, $dy=1.500 \text{ mm}$

Maximum value of SAR (interpolated) = 0.347 W/kg

Rear Side High 1RB_Mid /Zoom Scan (5x5x7)/Cube 0: Measurement grid: $dx=8\text{mm}$, $dy=8\text{mm}$, $dz=5\text{mm}$

Reference Value = 17.79 V/m ; Power Drift = 0.04 dB

Peak SAR (extrapolated) = 0.389 W/kg

SAR(1 g) = 0.295 W/kg ; SAR(10 g) = 0.217 W/kg

Maximum value of SAR (measured) = 0.347 W/kg

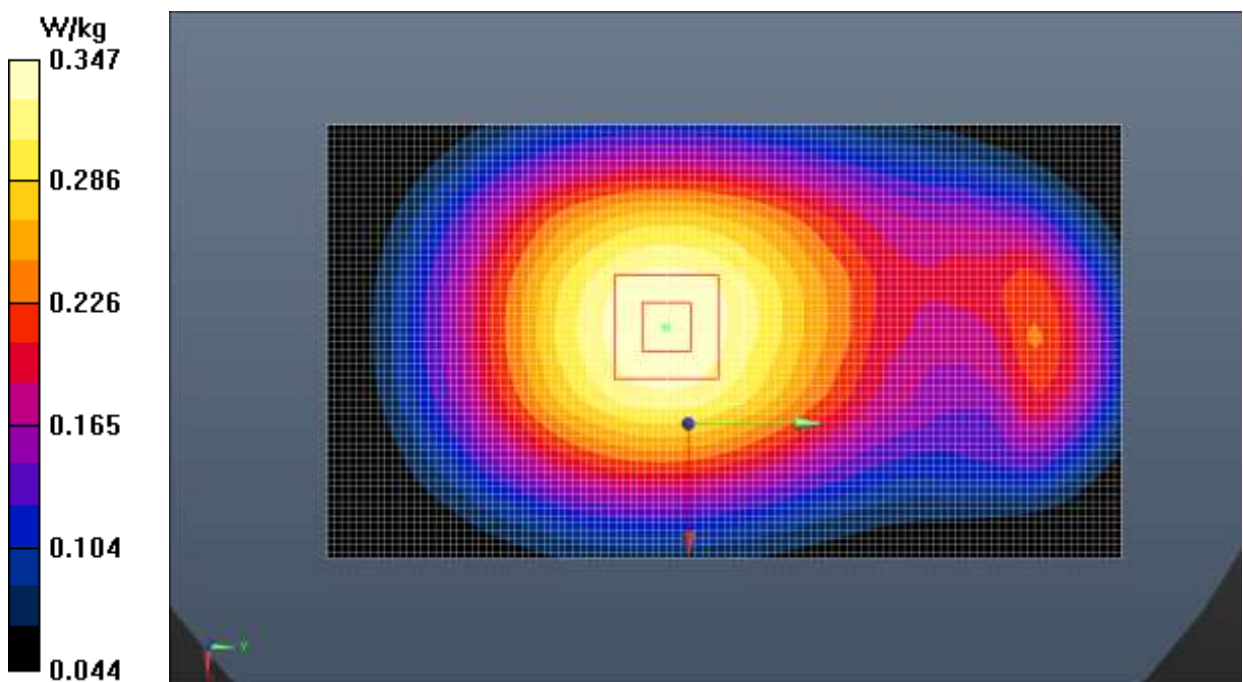

Fig.30 LTE Band 26

LTE Band 41 Head

Date: 2019-6-7

Electronics: DAE4 Sn786

Medium: Head 2550MHz

Medium parameters used: $f = 2506$ MHz; $\sigma = 1.899$ S/m; $\epsilon_r = 38.524$; $\rho = 1000$ kg/m³

Ambient Temperature: 22.0°C Liquid Temperature: 21.5°C

Communication System: UID 0, LTE_TDD (0) Frequency: 2506 MHz Duty Cycle: 1:1.58

Probe: EX3DV4 – SN3633 ConvF (7.33, 7.33, 7.33);

Left Cheek Middle 1RB_Mid/Area Scan (61x111x1): Interpolated grid: dx=1.000 mm, dy=1.000 mm

Maximum value of SAR (interpolated) = 0.147 W/kg

Left Cheek Middle 1RB_Mid/Zoom Scan (7x7x7)/Cube 0: Measurement grid: dx=5mm, dy=5mm, dz=5mm

Reference Value = 1.470 V/m; Power Drift = 0.06 dB

Peak SAR (extrapolated) = 0.252 W/kg

SAR(1 g) = 0.148 W/kg; SAR(10 g) = 0.077 W/kg

Maximum value of SAR (measured) = 0.195 W/kg

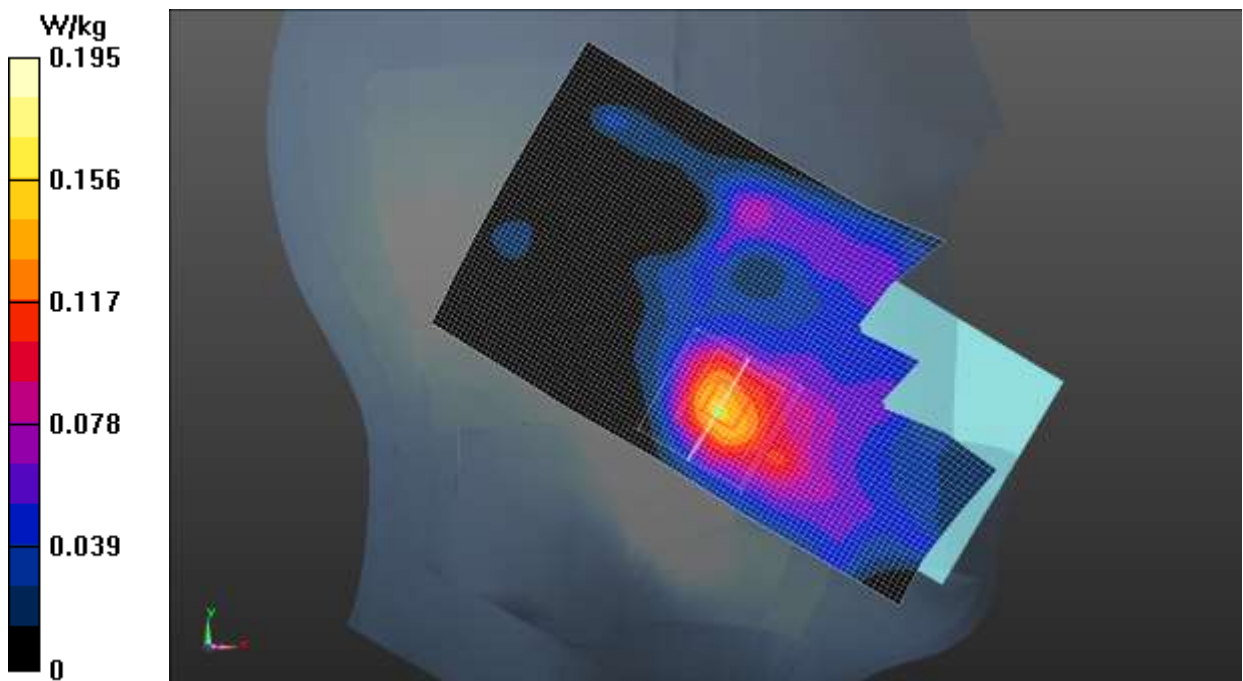

Fig.31 LTE Band 41

LTE Band 41 Body

Date: 2019-6-7

Electronics: DAE4 Sn786

Medium: Head 2550MHz

Medium parameters used: $f = 2506$ MHz; $\sigma = 1.899$ S/m; $\epsilon_r = 38.524$; $\rho = 1000$ kg/m³

Ambient Temperature: 22.0°C Liquid Temperature: 21.5°C

Communication System: UID 0, LTE_TDD (0) Frequency: 2506 MHz Duty Cycle: 1:1.58

Probe: EX3DV4 – SN3633 ConvF (7.33, 7.33, 7.33);

Rear Side Low 1RB_Mid/Area Scan (61x111x1): Interpolated grid: dx=1.000 mm, dy=1.000 mm

Maximum value of SAR (interpolated) = 0.574 W/kg

Rear Side Low 1RB_Mid/Zoom Scan (7x7x7)/Cube 0: Measurement grid: dx=5mm, dy=5mm, dz=5mm

Reference Value = 4.473 V/m; Power Drift = 0.10 dB

Peak SAR (extrapolated) = 0.625 W/kg

SAR(1 g) = 0.268 W/kg; SAR(10 g) = 0.184 W/kg

Maximum value of SAR (measured) = 0.589 W/kg

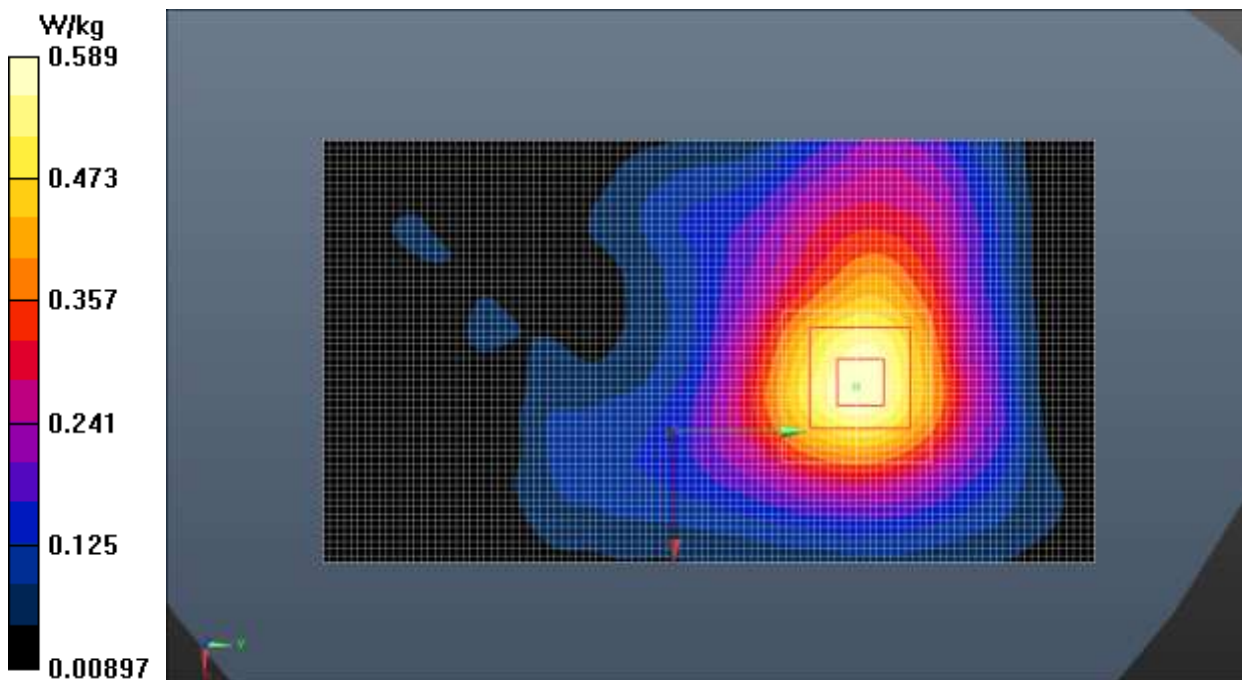

Fig.32 LTE Band 41

LTE Band 66 Head

Date: 2019-6-4

Electronics: DAE4 Sn786

Medium: Head 1750MHz

Medium parameters used: $f = 1770 \text{ MHz}$; $\sigma = 1.379 \text{ S/m}$; $\epsilon_r = 40.273$; $\rho = 1000 \text{ kg/m}^3$

Ambient Temperature: 22.0°C Liquid Temperature: 21.5°C

Communication System: UID 0, LTE_FDD (0) Frequency: 1770 MHz Duty Cycle: 1:1

Probe: EX3DV4 – SN3633 ConvF (8.07, 8.07, 8.07);

Right Cheek High 1RB_Mid/Area Scan (61x101x1): Interpolated grid: $dx=1.500 \text{ mm}$, $dy=1.500 \text{ mm}$

Maximum value of SAR (interpolated) = 0.088 W/kg

Right Cheek High 1RB_Mid/Zoom Scan (5x5x7)/Cube 0: Measurement grid: $dx=8\text{mm}$, $dy=8\text{mm}$, $dz=5\text{mm}$

Reference Value = 1.520 V/m; Power Drift = 0.06 dB

Peak SAR (extrapolated) = 0.121 W/kg

SAR(1 g) = 0.081 W/kg; SAR(10 g) = 0.051 W/kg

Maximum value of SAR (measured) = 0.094 W/kg

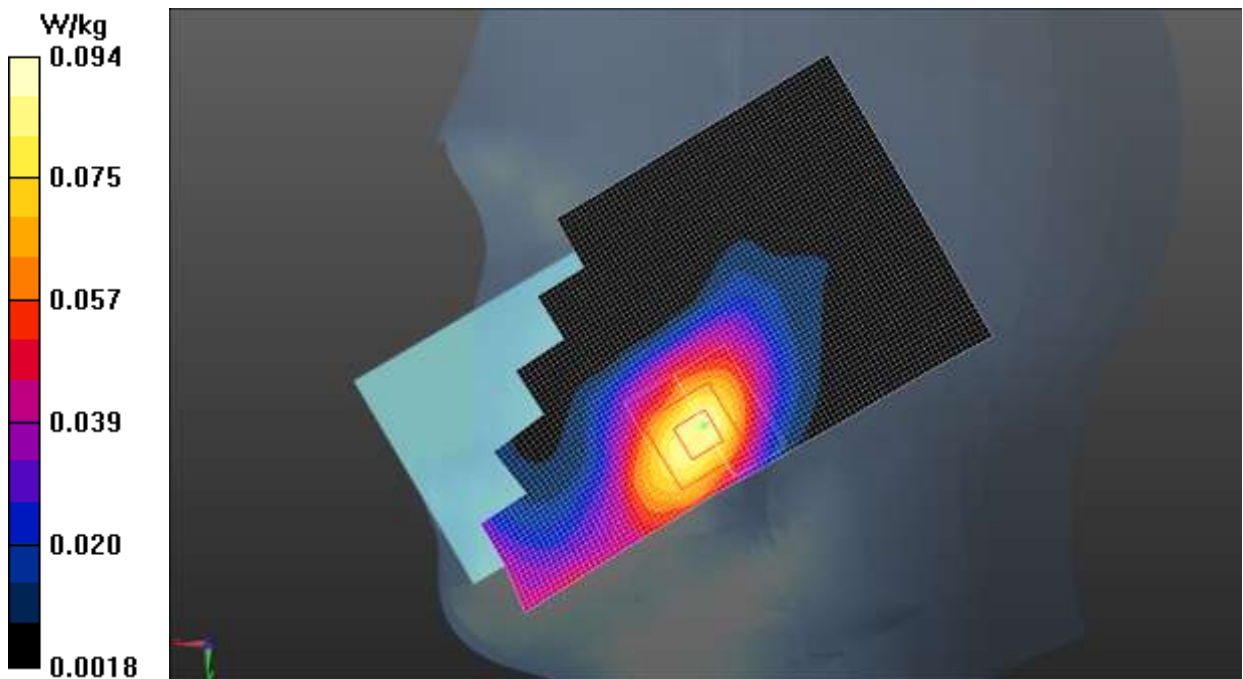

Fig.33 LTE Band 66

LTE Band 66 Body

Date: 2019-6-4

Electronics: DAE4 Sn786

Medium: Head 1750MHz

Medium parameters used: $f = 1770 \text{ MHz}$; $\sigma = 1.379 \text{ S/m}$; $\epsilon_r = 40.273$; $\rho = 1000 \text{ kg/m}^3$

Ambient Temperature: 22.0°C Liquid Temperature: 21.5°C

Communication System: UID 0, LTE_FDD (0) Frequency: 1770 MHz Duty Cycle: 1:1

Probe: EX3DV4 – SN3633 ConvF (8.07, 8.07, 8.07);

Bottom Side High 1RB_Mid/Area Scan (51x61x1): Interpolated grid: $dx=1.500 \text{ mm}$, $dy=1.500 \text{ mm}$

Maximum value of SAR (interpolated) = 0.851 W/kg

Bottom Side High 1RB_Mid/Zoom Scan (5x5x7)/Cube 0: Measurement grid: $dx=8\text{mm}$, $dy=8\text{mm}$, $dz=5\text{mm}$

Reference Value = 21.45 V/m ; Power Drift = -0.03 dB

Peak SAR (extrapolated) = 1.14 W/kg

SAR(1 g) = 0.618 W/kg ; SAR(10 g) = 0.307 W/kg

Maximum value of SAR (measured) = 0.790 W/kg

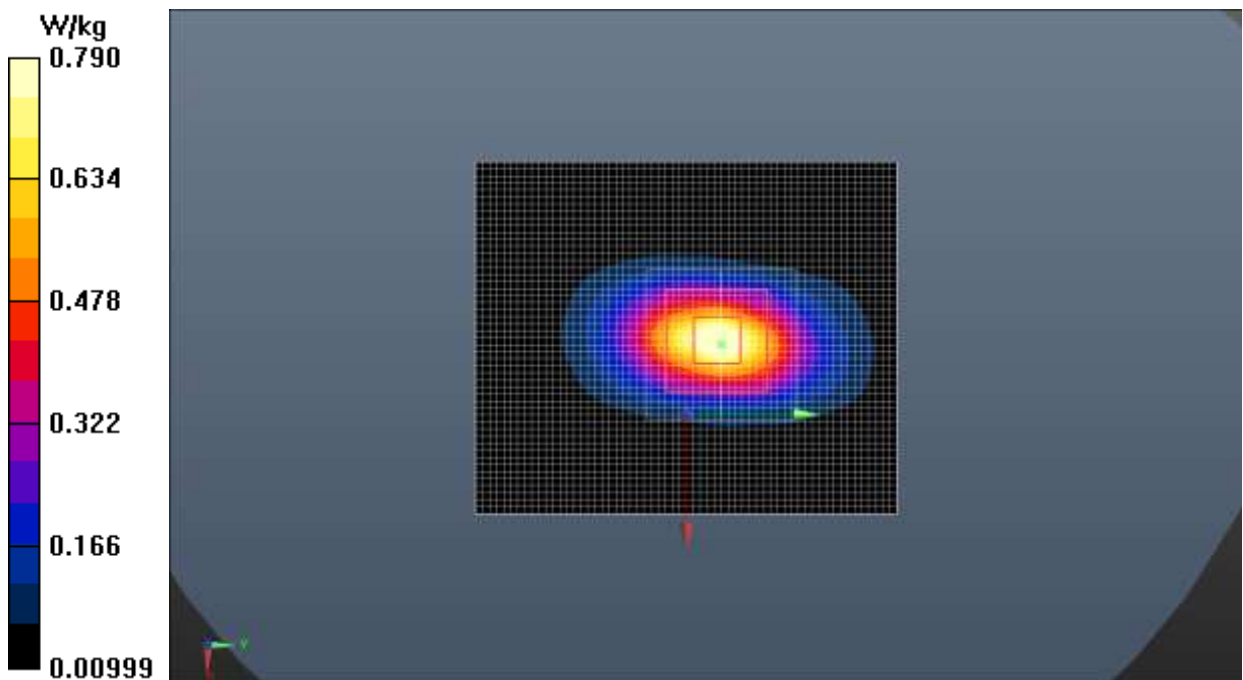

Fig.34 LTE Band 66

LTE Band 71 Head

Date: 2019-6-2

Electronics: DAE4 Sn786

Medium: Head 750MHz

Medium parameters used (extrapolated): $f = 673 \text{ MHz}$; $\sigma = 0.888 \text{ S/m}$; $\epsilon_r = 41.443$; $\rho = 1000 \text{ kg/m}^3$

Ambient Temperature: 22.0°C Liquid Temperature: 21.5°C

Communication System: UID 0, LTE_FDD (0) Frequency: 673 MHz Duty Cycle: 1:1

Probe: EX3DV4 – SN3633 ConvF (9.51, 9.51, 9.51);

Left Cheek Low 1RB_Mid/Area Scan (61x101x1): Interpolated grid: $dx=1.500 \text{ mm}$, $dy=1.500 \text{ mm}$

Maximum value of SAR (interpolated) = 0.034 W/kg

Left Cheek Low 1RB_Mid/Zoom Scan (5x5x7)/Cube 0: Measurement grid: $dx=8\text{mm}$, $dy=8\text{mm}$, $dz=5\text{mm}$

Reference Value = 2.749 V/m ; Power Drift = 0.08 dB

Peak SAR (extrapolated) = 0.045 W/kg

SAR(1 g) = 0.032 W/kg ; SAR(10 g) = 0.023 W/kg

Maximum value of SAR (measured) = 0.036 W/kg

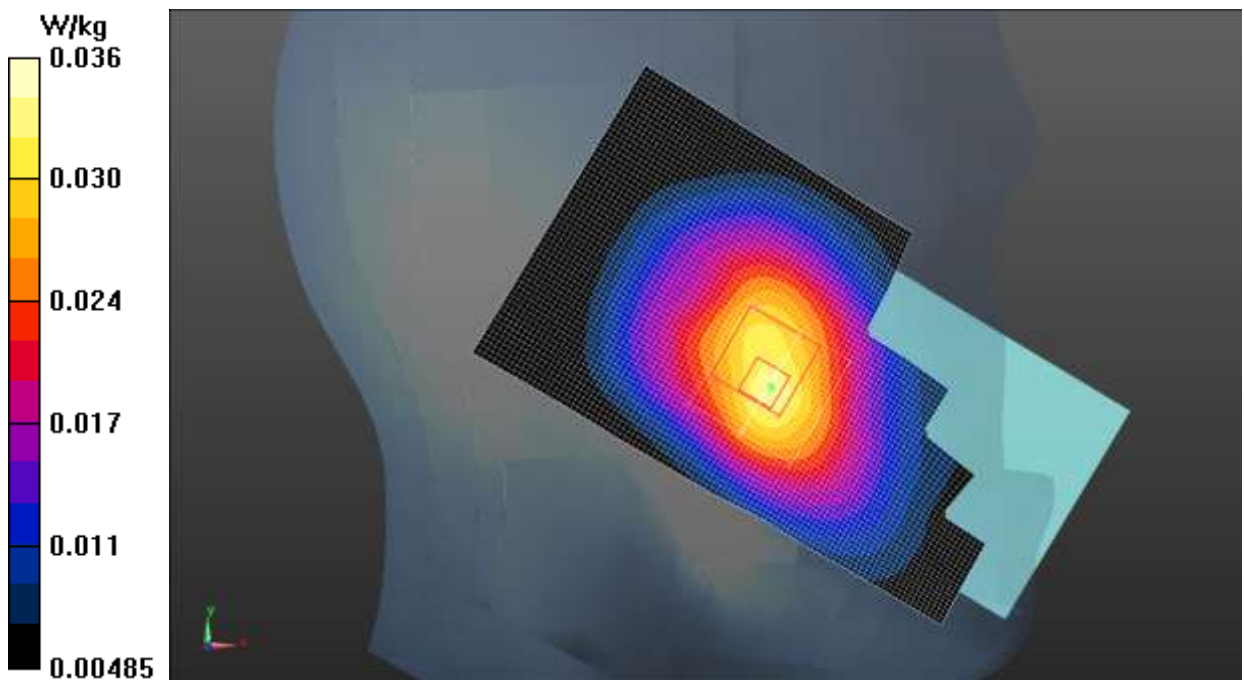

Fig.35 LTE Band 71

LTE Band 71 Body

Date: 2019-6-2

Electronics: DAE4 Sn786

Medium: Head 750MHz

Medium parameters used (extrapolated): $f = 673 \text{ MHz}$; $\sigma = 0.888 \text{ S/m}$; $\epsilon_r = 41.443$; $\rho = 1000 \text{ kg/m}^3$

Ambient Temperature: 22.0°C Liquid Temperature: 21.5°C

Communication System: UID 0, LTE_FDD (0) Frequency: 673 MHz Duty Cycle: 1:1

Probe: EX3DV4 – SN3633 ConvF (9.51, 9.51, 9.51);

Front Side Low 1RB_Mid/Area Scan (61x111x1): Interpolated grid: $dx=1.500 \text{ mm}$, $dy=1.500 \text{ mm}$

Maximum value of SAR (interpolated) = 0.0396 W/kg

Front Side Low 1RB_Mid/Zoom Scan (5x5x7)/Cube 0: Measurement grid: $dx=8\text{mm}$, $dy=8\text{mm}$, $dz=5\text{mm}$

Reference Value = 6.104 V/m; Power Drift = 0.08 dB

Peak SAR (extrapolated) = 0.0800 W/kg

SAR(1 g) = 0.045 W/kg; SAR(10 g) = 0.029 W/kg

Maximum value of SAR (measured) = 0.0527 W/kg

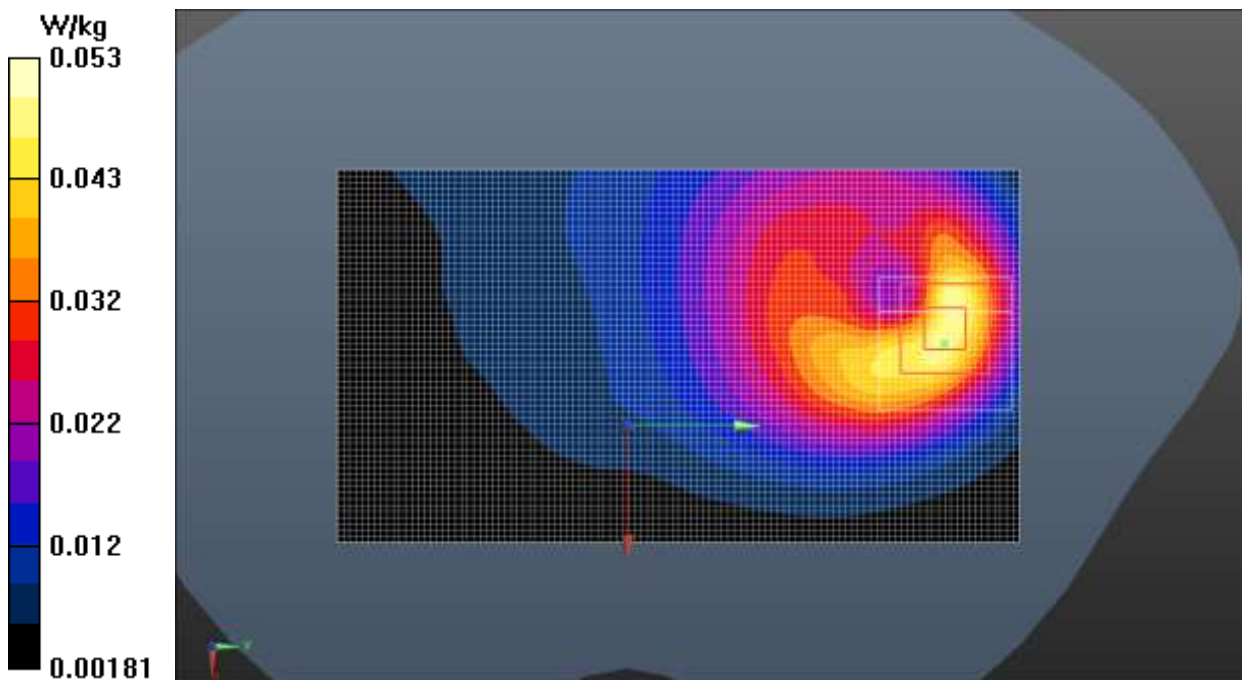

Fig.36 LTE Band 71

Wi-Fi 2.4G Head

Date: 2019-6-17

Electronics: DAE4 Sn786

Medium: Head 2450MHz

Medium parameters used (interpolated): $f = 2437$ MHz; $\sigma = 1.808$ S/m; $\epsilon_r = 38.185$; $\rho = 1000$ kg/m³

Ambient Temperature: 22.0°C Liquid Temperature: 21.5°C

Communication System: UID 0, WiFi (0) Frequency: 2437 MHz Duty Cycle: 1:1

Probe: EX3DV4 – SN3633 ConvF (7.33, 7.33, 7.33);

Left Cheek Middle/Area Scan (61x61x1): Interpolated grid: dx=1.000 mm, dy=1.000 mm

Maximum value of SAR (interpolated) = 1.08 W/kg

Left Cheek Middle/Zoom Scan (7x7x7)/Cube 0: Measurement grid: dx=5mm, dy=5mm, dz=5mm

Reference Value = 13.49 V/m; Power Drift = -0.05 dB

Peak SAR (extrapolated) = 2.03 W/kg

SAR(1 g) = 0.879 W/kg; SAR(10 g) = 0.380 W/kg

Maximum value of SAR (measured) = 1.41 W/kg

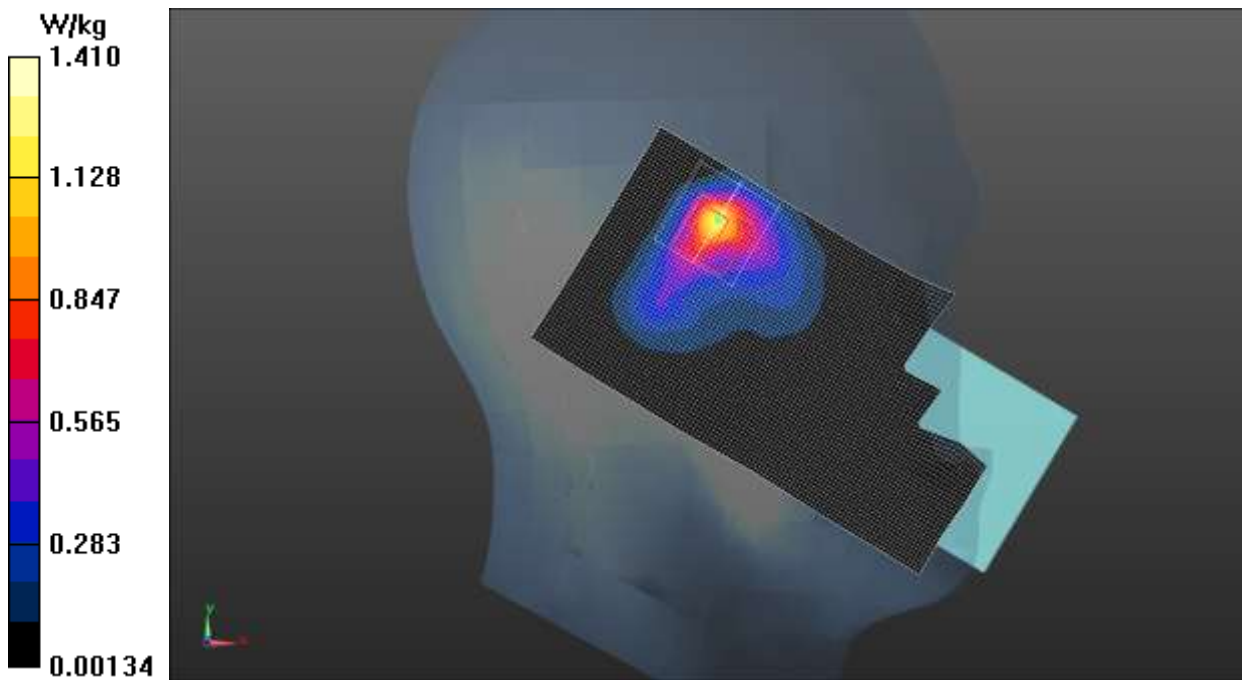

Fig.37 Wi-Fi 2.4G

Wi-Fi 2.4G Body

Date: 2019-6-17

Electronics: DAE4 Sn786

Medium: Head 2450MHz

Medium parameters used: $f = 2462 \text{ MHz}$; $\sigma = 1.838 \text{ S/m}$; $\epsilon_r = 38.093$; $\rho = 1000 \text{ kg/m}^3$

Ambient Temperature: 22.0°C Liquid Temperature: 21.5°C

Communication System: UID 0, WiFi (0) Frequency: 2462 MHz Duty Cycle: 1:1

Probe: EX3DV4 – SN3633 ConvF (7.33, 7.33, 7.33);

Top Side High/Area Scan (41x71x1): Interpolated grid: $dx=1.000 \text{ mm}$, $dy=1.000 \text{ mm}$

Maximum value of SAR (interpolated) = 0.285 W/kg

Top Side High/Zoom Scan (7x7x7)/Cube 0: Measurement grid: $dx=5\text{mm}$, $dy=5\text{mm}$, $dz=5\text{mm}$

Reference Value = 8.276 V/m ; Power Drift = 0.04 dB

Peak SAR (extrapolated) = 0.391 W/kg

SAR(1 g) = 0.205 W/kg ; SAR(10 g) = 0.106 W/kg

Maximum value of SAR (measured) = 0.297 W/kg

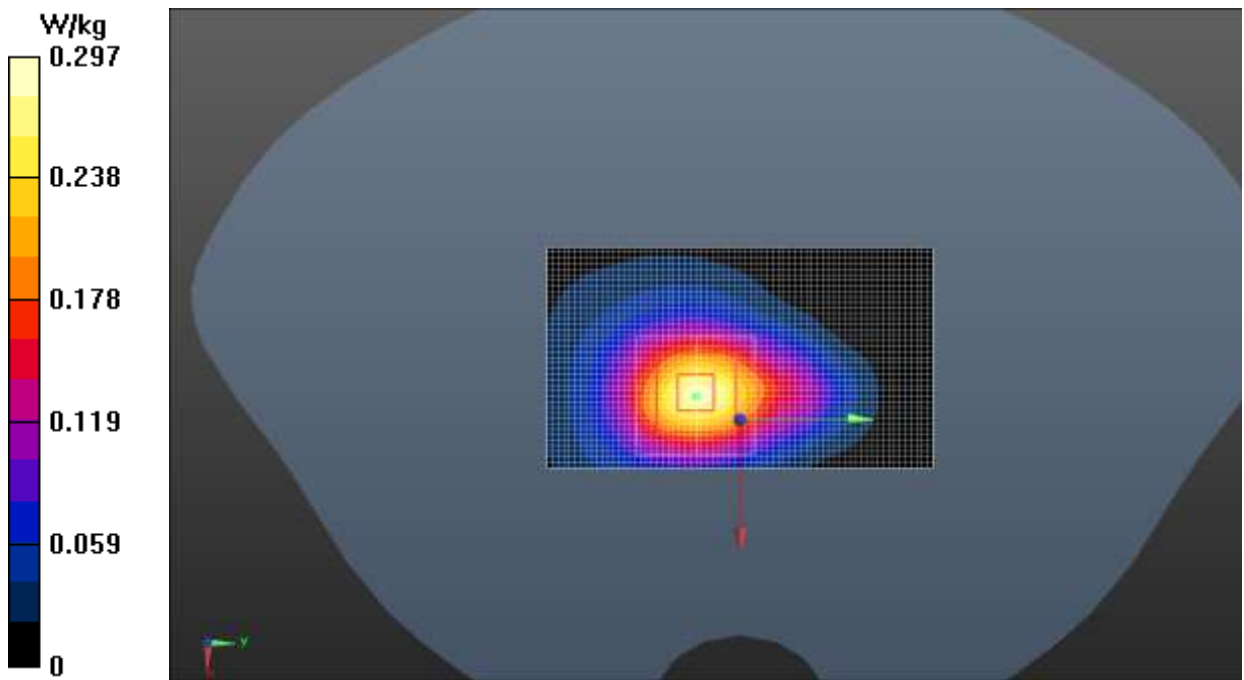

Fig.38 Wi-Fi 2.4G

ANNEX B System Verification Results

750MHz

Date: 2019-6-2

Electronics: DAE4 Sn786

Medium: Head 750MHz

Medium parameters used: $f = 750 \text{ MHz}$; $\sigma = 0.916 \text{ S/m}$; $\epsilon_r = 41.162$; $\rho = 1000 \text{ kg/m}^3$

Ambient Temperature: 22.5°C Liquid Temperature: 22.0°C

Communication System: CW Frequency: 750 MHz Duty Cycle: 1:1

Probe: EX3DV4 – SN3633 ConvF (9.51, 9.51, 9.51);

System Validation /Area Scan (81x191x1): Interpolated grid: $dx=1.000 \text{ mm}$, $dy=1.000 \text{ mm}$

Reference Value = 58.616 V/m; Power Drift = 0.02 dB

SAR(1 g) = 2.12 W/kg; SAR(10 g) = 1.38 W/kg

Maximum value of SAR (interpolated) = 2.28 W/kg

System Validation /Zoom Scan (7x7x7)/Cube 0: Measurement grid: $dx=5\text{mm}$, $dy=5\text{mm}$, $dz=5\text{mm}$

Reference Value = 58.616 V/m; Power Drift = 0.02 dB

Peak SAR (extrapolated) = 2.77 W/kg

SAR(1 g) = 2.15 W/kg; SAR(10 g) = 1.40 W/kg

Maximum value of SAR (measured) = 2.31 W/kg

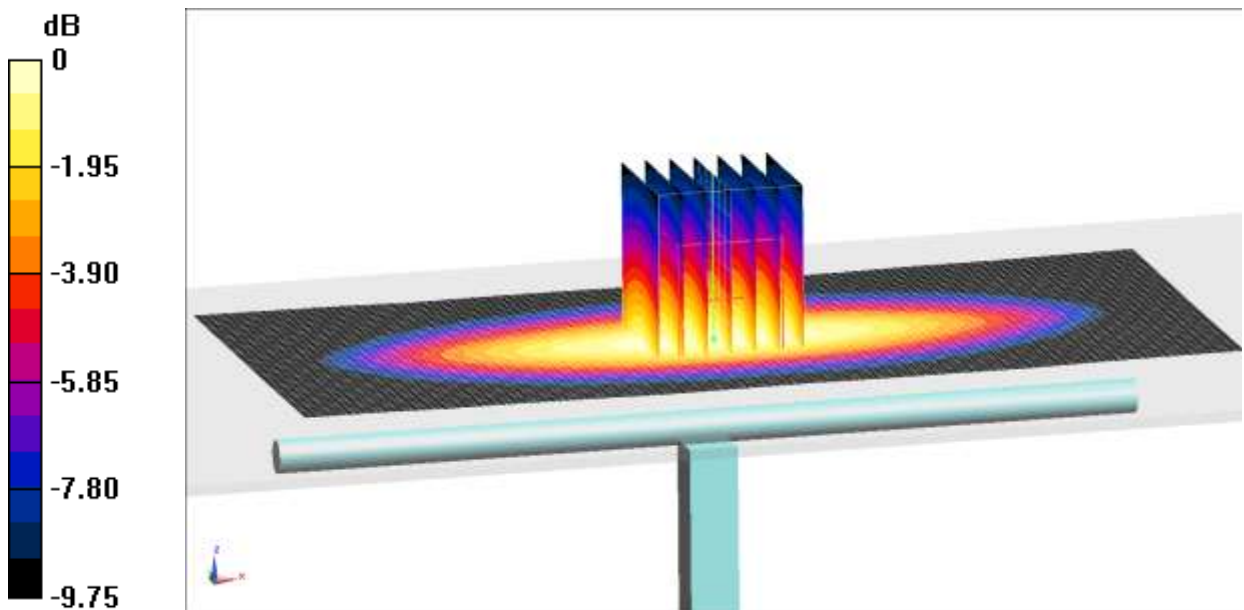

0 dB = 2.31 W/kg = 3.64 dB W/kg

Fig.B.1. Validation 750MHz 250mW

835MHz

Date: 2019-5-30

Electronics: DAE4 Sn786

Medium: Head 835MHz

Medium parameters used: $f = 835 \text{ MHz}$; $\sigma = 0.915 \text{ S/m}$; $\epsilon_r = 40.441$; $\rho = 1000 \text{ kg/m}^3$

Ambient Temperature: 22.5°C Liquid Temperature: 22.0°C

Communication System: CW Frequency: 835 MHz Duty Cycle: 1:1

Probe: EX3DV4 – SN3633 ConvF (9.51, 9.51, 9.51);

System Validation /Area Scan (81x161x1): Interpolated grid: $dx=1.000 \text{ mm}$, $dy=1.000 \text{ mm}$

Reference Value = 60.203 V/m ; Power Drift = -0.09 dB

SAR(1 g) = 2.49 W/kg; SAR(10 g) = 1.60 W/kg

Maximum value of SAR (interpolated) = 2.61 W/kg

System Validation /Zoom Scan (7x7x7)/Cube 0: Measurement grid: $dx=5\text{mm}$, $dy=5\text{mm}$, $dz=5\text{mm}$

Reference Value = 60.203 V/m ; Power Drift = -0.09 dB

Peak SAR (extrapolated) = 3.16 W/kg

SAR(1 g) = 2.47 W/kg; SAR(10 g) = 1.59 W/kg

Maximum value of SAR (measured) = 2.58 W/kg

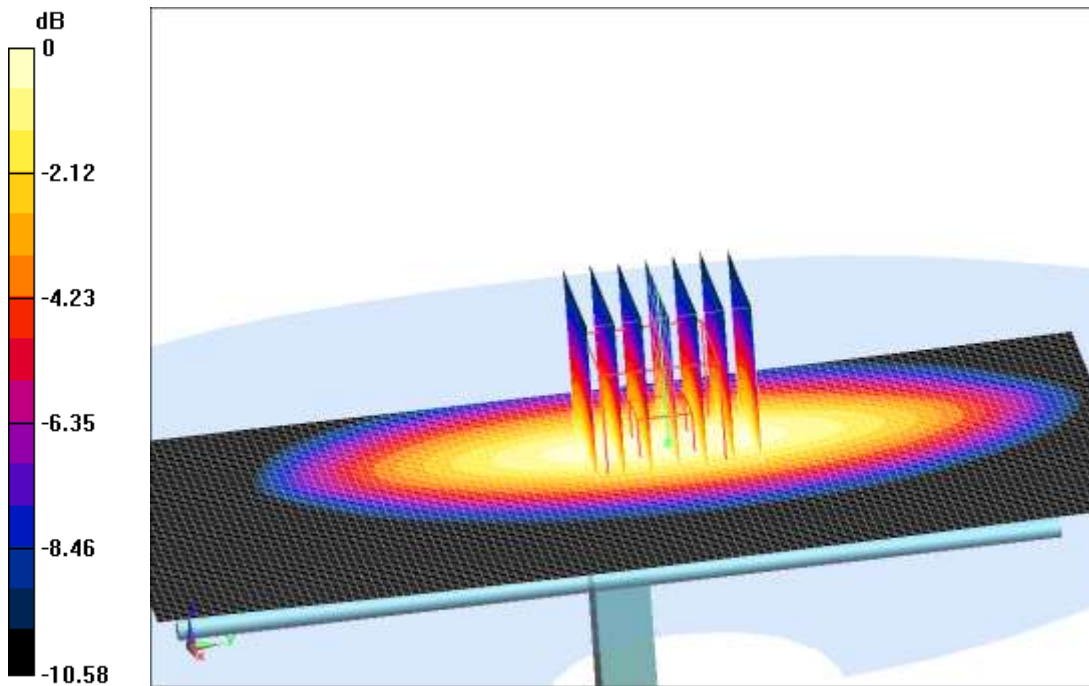

0 dB = 2.58 W/kg = 4.12 dB W/kg

Fig.B.2. Validation 835MHz 250mW

835MHz

Date: 2019-5-31

Electronics: DAE4 Sn786

Medium: Head 835MHz

Medium parameters used: $f = 835 \text{ MHz}$; $\sigma = 0.923 \text{ S/m}$; $\epsilon_r = 40.258$; $\rho = 1000 \text{ kg/m}^3$

Ambient Temperature: 22.5°C Liquid Temperature: 22.0°C

Communication System: CW Frequency: 835 MHz Duty Cycle: 1:1

Probe: EX3DV4 – SN3633 ConvF (9.51, 9.51, 9.51);

System Validation /Area Scan (81x161x1): Interpolated grid: $dx=1.000 \text{ mm}$, $dy=1.000 \text{ mm}$

Reference Value = 61.242 V/m ; Power Drift = 0.05 dB

SAR(1 g) = 2.46 W/kg; SAR(10 g) = 1.60 W/kg

Maximum value of SAR (interpolated) = 2.62 W/kg

System Validation /Zoom Scan (7x7x7)/Cube 0: Measurement grid: $dx=5\text{mm}$, $dy=5\text{mm}$, $dz=5\text{mm}$

Reference Value = 61.242 V/m ; Power Drift = 0.05 dB

Peak SAR (extrapolated) = 3.25 W/kg

SAR(1 g) = 2.49 W/kg; SAR(10 g) = 1.61 W/kg

Maximum value of SAR (measured) = 2.66 W/kg

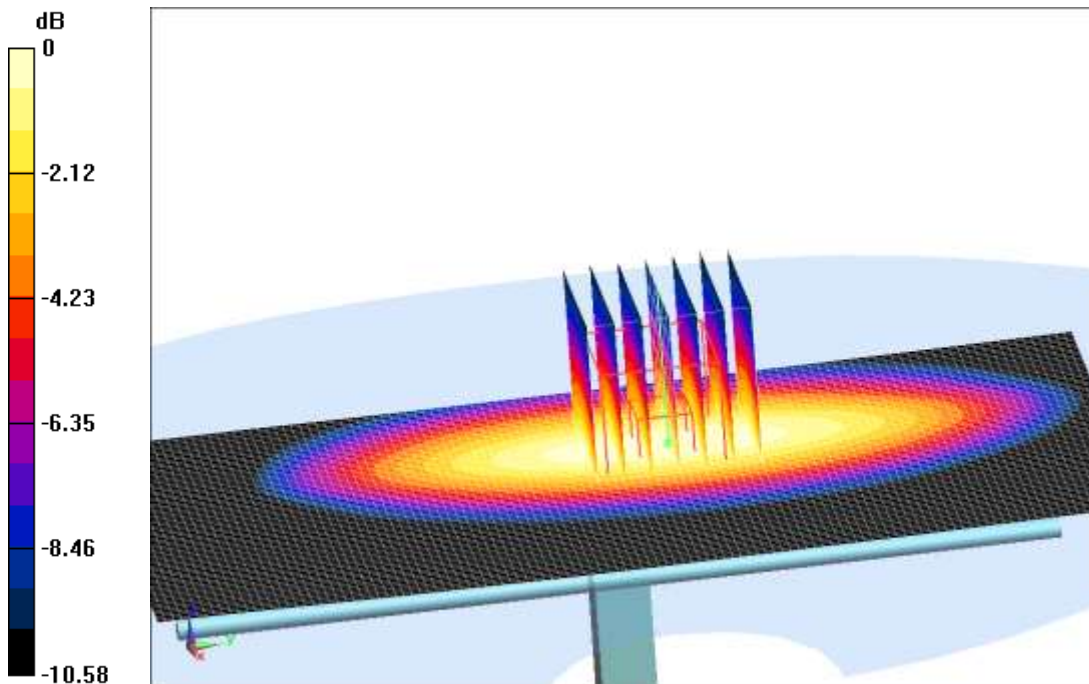

0 dB = 2.66 W/kg = 4.25 dB W/kg

Fig.B.3. Validation 835MHz 250mW

1750MHz

Date: 2019-6-4

Electronics: DAE4 Sn786

Medium: Head 1750MHz

Medium parameters used: $f = 1750 \text{ MHz}$; $\sigma = 1.361 \text{ S/m}$; $\epsilon_r = 40.334$; $\rho = 1000 \text{ kg/m}^3$

Ambient Temperature: 22.5°C Liquid Temperature: 22.0°C

Communication System: CW Frequency: 1750 MHz Duty Cycle: 1:1

Probe: EX3DV4 – SN3633 ConvF (8.07, 8.07, 8.07);

System Validation/Area Scan (61x121x1): Interpolated grid: $dx=1.000 \text{ mm}$, $dy=1.000 \text{ mm}$

Reference Value = 77.815 V/m ; Power Drift = -0.11 dB

SAR(1 g) = 9.02 W/kg; SAR(10 g) = 4.86 W/kg

Maximum value of SAR (interpolated) = 11.2 W/kg

System Validation/Zoom Scan (7x7x7)/Cube 0: Measurement grid: $dx=5\text{mm}$, $dy=5\text{mm}$, $dz=5\text{mm}$

Reference Value = 77.815 V/m ; Power Drift = -0.11 dB

Peak SAR (extrapolated) = 17.3 W/kg

SAR(1 g) = 8.85 W/kg; SAR(10 g) = 4.80 W/kg

Maximum value of SAR (measured) = 11.0 W/kg

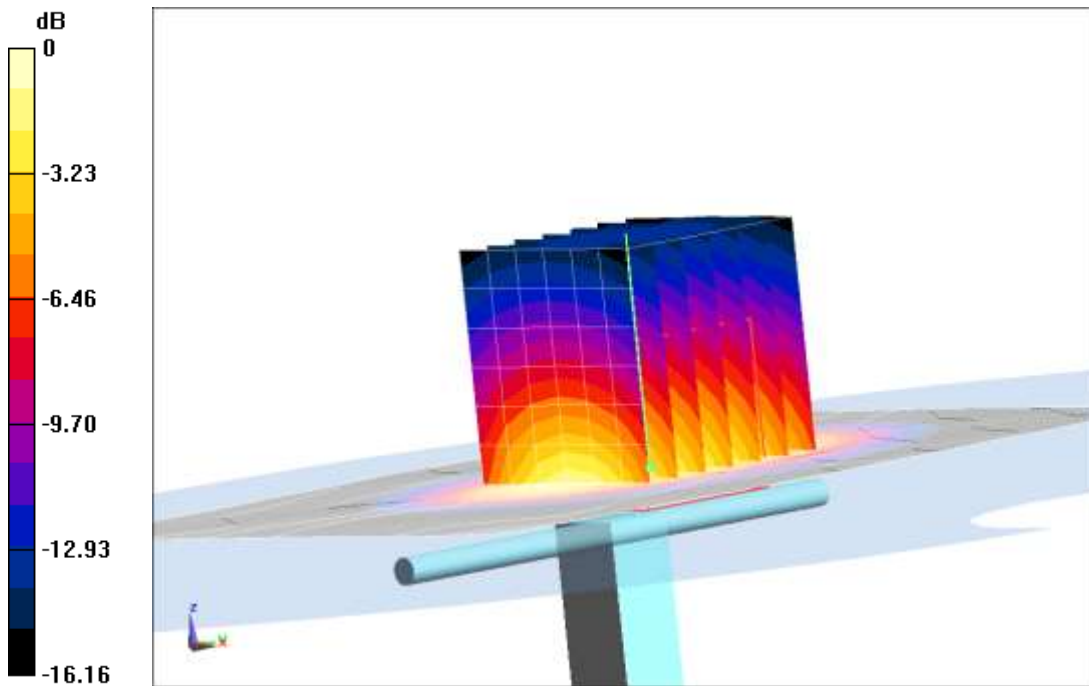

0 dB = 11.0 W/kg = 10.41 dB W/kg

Fig.B.4. Validation 1750MHz 250mW

1900MHz

Date: 2019-6-19

Electronics: DAE4 Sn786

Medium: Head 1900MHz

Medium parameters used: $f = 1900 \text{ MHz}$; $\sigma = 1.384 \text{ S/m}$; $\epsilon_r = 40.452$; $\rho = 1000 \text{ kg/m}^3$

Ambient Temperature: 22.5°C Liquid Temperature: 22.0°C

Communication System: CW Frequency: 1900 MHz Duty Cycle: 1:1

Probe: EX3DV4 – SN3633 ConvF (7.63, 7.63, 7.63);

System Validation /Area Scan (81x121x1): Interpolated grid: $dx=1.000 \text{ mm}$, $dy=1.000 \text{ mm}$

Reference Value = 89.521 V/m ; Power Drift = -0.05 dB

SAR(1 g) = 9.92 W/kg; SAR(10 g) = 5.16 W/kg

Maximum value of SAR (interpolated) = 12.4 W/kg

System Validation /Zoom Scan (7x7x7)/Cube 0: Measurement grid: $dx=5\text{mm}$, $dy=5\text{mm}$, $dz=5\text{mm}$

Reference Value = 89.521 V/m ; Power Drift = -0.05 dB

Peak SAR (extrapolated) = 20.2 W/kg

SAR(1 g) = 9.77 W/kg; SAR(10 g) = 5.13 W/kg

Maximum value of SAR (measured) = 12.1 W/kg

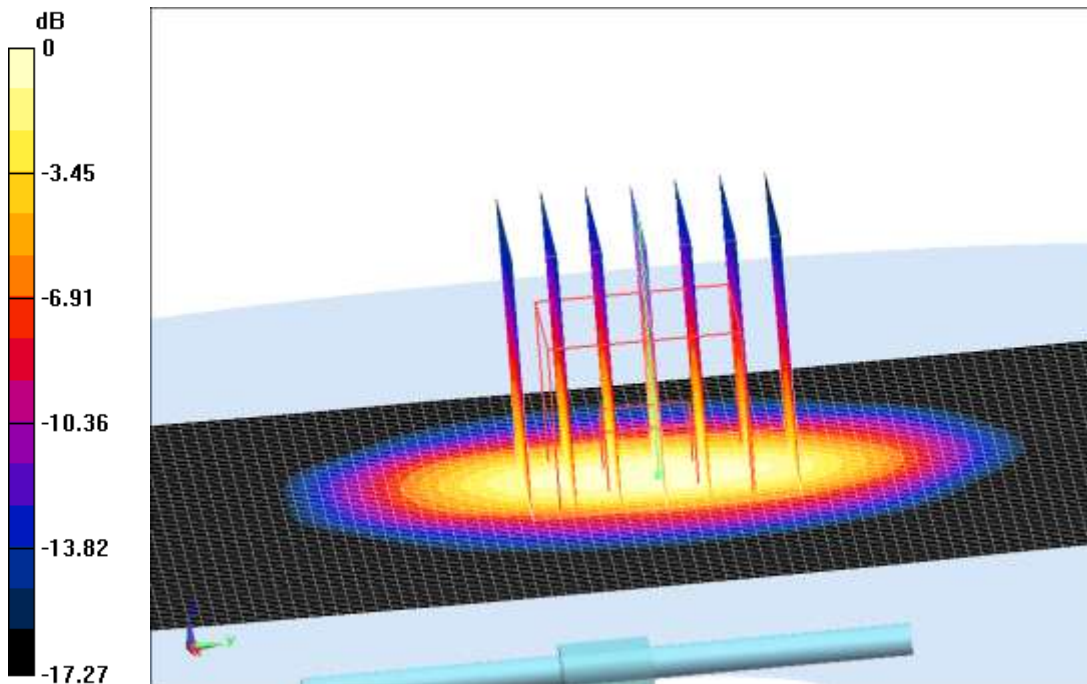

0 dB = 12.1 W/kg = 10.83 dB W/kg

Fig.B.5. Validation 1900MHz 250mW

1900MHz

Date: 2019-6-20

Electronics: DAE4 Sn786

Medium: Head 1900MHz

Medium parameters used: $f = 1900 \text{ MHz}$; $\sigma = 1.395 \text{ S/m}$; $\epsilon_r = 40.266$; $\rho = 1000 \text{ kg/m}^3$

Ambient Temperature: 22.5°C Liquid Temperature: 22.0°C

Communication System: CW Frequency: 1900 MHz Duty Cycle: 1:1

Probe: EX3DV4 – SN3633 ConvF (7.63, 7.63, 7.63);

System Validation /Area Scan (81x121x1): Interpolated grid: $dx=1.000 \text{ mm}$, $dy=1.000 \text{ mm}$

Reference Value = 90.448 V/m ; Power Drift = -0.06 dB

SAR(1 g) = 10.0 W/kg; SAR(10 g) = 5.20 W/kg

Maximum value of SAR (interpolated) = 12.8 W/kg

System Validation /Zoom Scan (7x7x7)/Cube 0: Measurement grid: $dx=5\text{mm}$, $dy=5\text{mm}$, $dz=5\text{mm}$

Reference Value = 90.448 V/m ; Power Drift = -0.06 dB

Peak SAR (extrapolated) = 21.1 W/kg

SAR(1 g) = 9.83 W/kg; SAR(10 g) = 5.16 W/kg

Maximum value of SAR (measured) = 12.6 W/kg

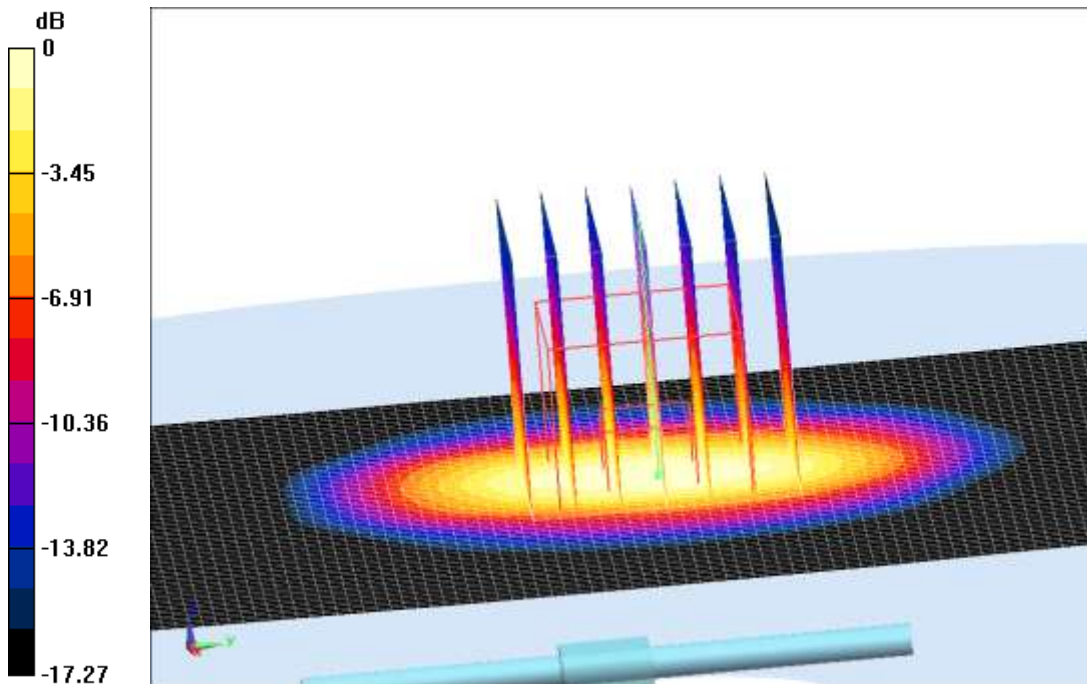

0 dB = 12.6 W/kg = 11.00 dB W/kg

Fig.B.6. Validation 1900MHz 250mW

2450MHz

Date: 2019-6-17

Electronics: DAE4 Sn786

Medium: Head 2450MHz

Medium parameters used: $f = 2450 \text{ MHz}$; $\sigma = 1.823 \text{ S/m}$; $\epsilon_r = 38.142$; $\rho = 1000 \text{ kg/m}^3$

Ambient Temperature: 22.5°C Liquid Temperature: 22.0°C

Communication System: CW Frequency: 2450 MHz Duty Cycle: 1:1

Probe: EX3DV4 – SN3633 ConvF (7.33, 7.33, 7.33);

System Validation /Area Scan (61x81x1): Interpolated grid: $dx=1.000 \text{ mm}$, $dy=1.000 \text{ mm}$

Reference Value = 91.905 V/m; Power Drift = -0.10 dB

SAR(1 g) = 13.3 W/kg; SAR(10 g) = 6.13 W/kg

Maximum value of SAR (interpolated) = 15.1 W/kg

System Validation /Zoom Scan (7x7x7)/Cube 0: Measurement grid: $dx=5\text{mm}$, $dy=5\text{mm}$, $dz=5\text{mm}$

Reference Value = 91.905 V/m; Power Drift = -0.10 dB

Peak SAR (extrapolated) = 25.8 W/kg

SAR(1 g) = 13.2 W/kg; SAR(10 g) = 6.08 W/kg

Maximum value of SAR (measured) = 15.4 W/kg

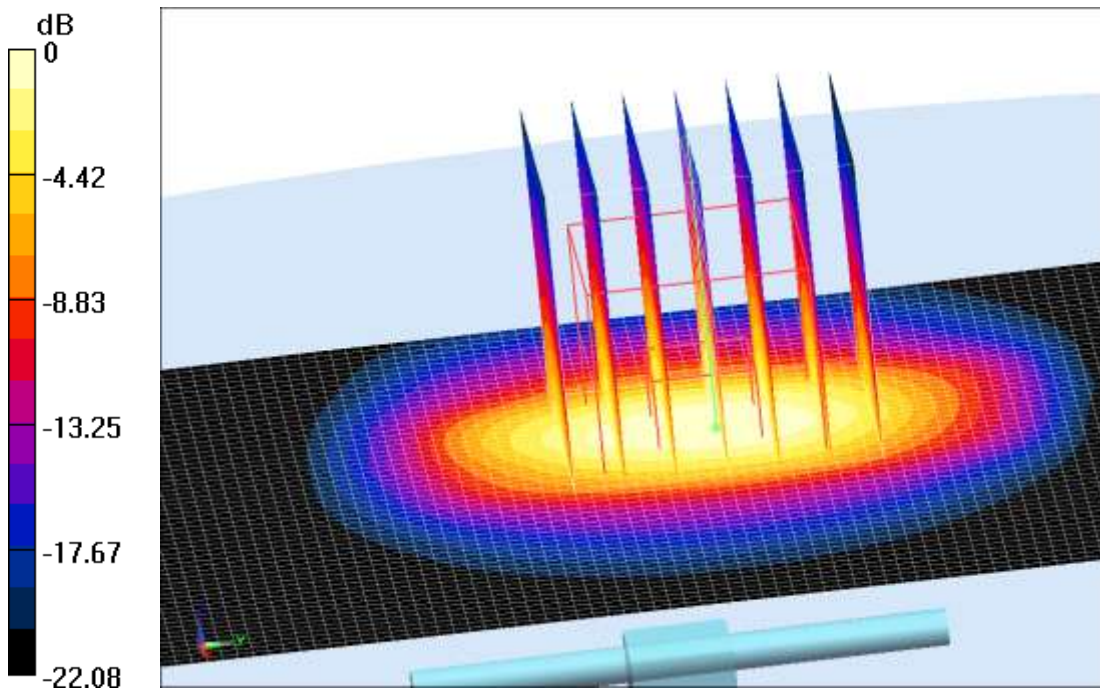

0 dB = 15.4 W/kg = 11.88 dB W/kg

Fig.B.7. Validation 2450MHz 250mW

2550 MHz

Date: 2019-6-7

Electronics: DAE4 Sn786

Medium: Head 2550MHz

Medium parameters used: $f = 2550 \text{ MHz}$; $\sigma = 1.951 \text{ S/m}$; $\epsilon_r = 38.363$; $\rho = 1000 \text{ kg/m}^3$

Ambient Temperature: 22.5°C Liquid Temperature: 22.0°C

Communication System: CW_TMC Frequency: 2550 MHz Duty Cycle: 1:1

Probe: EX3DV4 – SN3633 ConvF (7.12, 7.12, 7.12);

System Validation/Area Scan (61x121x1): Interpolated grid: $dx=1.000 \text{ mm}$, $dy=1.000 \text{ mm}$

Reference Value = 92.426 V/m ; Power Drift = 0.08 dB

SAR(1 g) = 14.7 W/kg ; SAR(10 g) = 6.66 W/kg

Maximum value of SAR (interpolated) = 16.1 W/kg

System Validation/Zoom Scan (7x7x7)/Cube0: Measurement grid: $dx=5\text{mm}$, $dy=5\text{mm}$, $dz=5\text{mm}$

Reference Value = 92.426 V/m ; Power Drift = 0.08 dB

Peak SAR (extrapolated) = 31.3 W/kg

SAR(1 g) = 14.9 W/kg ; SAR(10 g) = 6.72 W/kg

Maximum value of SAR (measured) = 16.3 W/kg

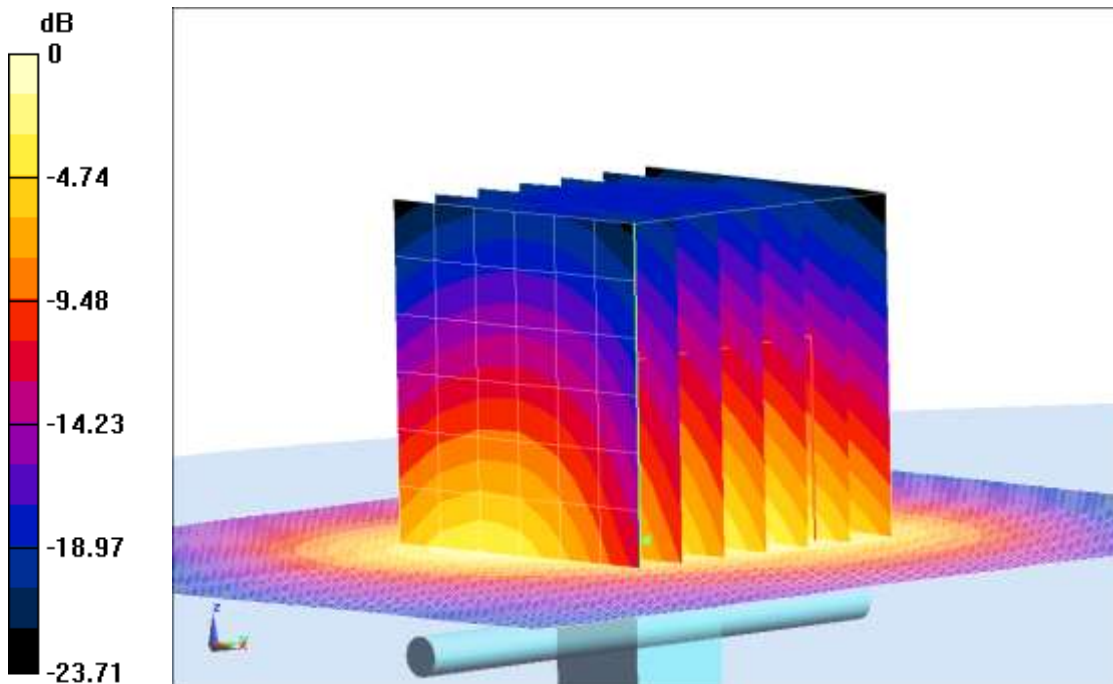

$0 \text{ dB} = 16.3 \text{ W/kg} = 12.12 \text{ dB W/kg}$

Fig.B.8. validation 2550MHz 250mW

The SAR system verification must be required that the area scan estimated 1-g SAR is within 3% of the zoom scan 1-g SAR.

Table B.1 Comparison between area scan and zoom scan for system verification

Band (MHz)	Position	Area scan (1g)	Zoom scan (1g)	Drift (%)
750	Head	2.12	2.15	1.42
835	Head	2.49	2.47	-0.80
835	Head	2.46	2.49	1.22
1750	Head	9.02	8.85	-1.88
1900	Head	9.92	9.77	-1.51
1900	Head	10.0	9.83	-1.70
2450	Head	13.3	13.2	-0.75
2550	Head	14.7	14.9	1.36

ANNEX C SAR Measurement Setup

C.1 Measurement Set-up

DASY5 system for performing compliance tests is illustrated above graphically. This system consists of the following items:

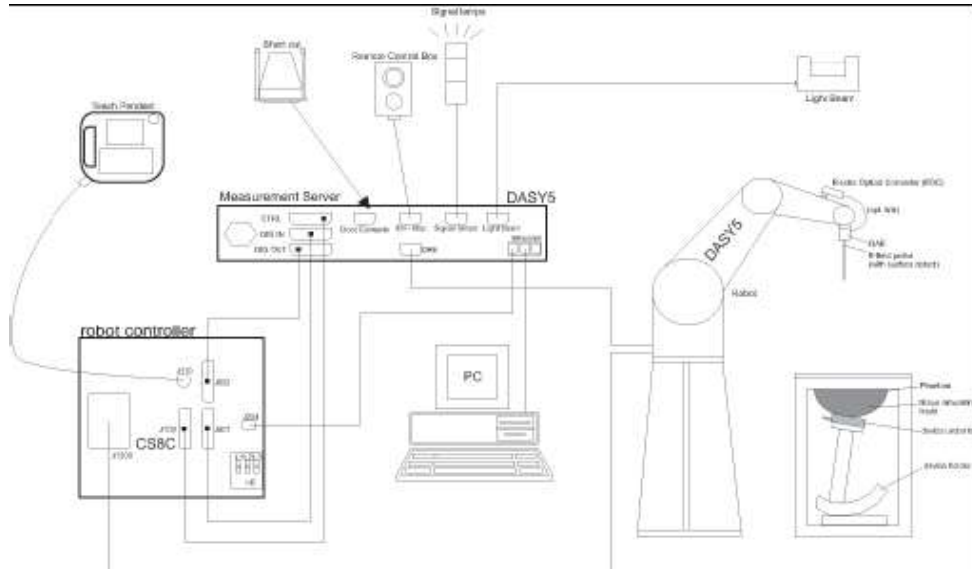

Picture C.1 SAR Lab Test Measurement Set-up

- A standard high precision 6-axis robot (Stäubli TX=RX family) with controller, teach pendant and software. An arm extension for accommodating the data acquisition electronics (DAE).
- An isotropic field probe optimized and calibrated for the targeted measurement.
- A data acquisition electronics (DAE) which performs the signal amplification, signal multiplexing, AD-conversion, offset measurements, mechanical surface detection, collision detection, etc. The unit is battery powered with standard or rechargeable batteries. The signal is optically transmitted to the EOC.
- The Electro-optical converter (EOC) performs the conversion from optical to electrical signals for the digital communication to the DAE. To use optical surface detection, a special version of the EOC is required. The EOC signal is transmitted to the measurement server.
- The function of the measurement server is to perform the time critical tasks such as signal filtering, control of the robot operation and fast movement interrupts.
- The Light Beam used is for probe alignment. This improves the (absolute) accuracy of the probe positioning.
- A computer running WinXP and the DASY5 software.
- Remote control and teach pendant as well as additional circuitry for robot safety such as
- warning lamps, etc.
- The phantom, the device holder and other accessories according to the targeted measurement.

C.2 DASY5 E-field Probe System

The SAR measurements were conducted with the dosimetric probe designed in the classical triangular configuration and optimized for dosimetric evaluation. The probe is constructed using the thick film technique; with printed resistive lines on ceramic substrates. The probe is equipped with an optical multifiber line ending at the front of the probe tip. It is connected to the EOC box on the robot arm and provides an automatic detection of the phantom surface. Half of the fibers are connected to a pulsed infrared transmitter, the other half to a synchronized receiver. As the probe approaches the surface, the reflection from the surface produces a coupling from the transmitting to the receiving fibers. This reflection increases first during the approach, reaches maximum and then decreases. If the probe is flatly touching the surface, the coupling is zero. The distance of the coupling maximum to the surface is independent of the surface reflectivity and largely independent of the surface to probe angle. The DASY5 software reads the reflection during a software approach and looks for the maximum using 2nd order curve fitting. The approach is stopped at reaching the maximum.

Probe Specifications:

Model:	ES3DV3, EX3DV4
Frequency	10MHz — 6.0GHz(EX3DV4)
Range:	10MHz — 4GHz(ES3DV3)
Calibration:	In head and body simulating tissue at Frequencies from 835 up to 5800MHz
Linearity:	± 0.2 dB(30 MHz to 6 GHz) for EX3DV4 ± 0.2 dB(30 MHz to 4 GHz) for ES3DV3
Dynamic Range:	10 mW/kg — 100W/kg
Probe Length:	330 mm
Probe Tip	
Length:	20 mm
Body Diameter:	12 mm
Tip Diameter:	2.5 mm (3.9 mm for ES3DV3)
Tip-Center:	1 mm (2.0mm for ES3DV3)
Application:	SAR Dosimetry Testing Compliance tests of mobile phones Dosimetry in strong gradient fields



Picture C.2 Near-field Probe



Picture C.3 E-field Probe

C.3 E-field Probe Calibration

Each E-Probe/Probe Amplifier combination has unique calibration parameters. A TEM cell calibration procedure is conducted to determine the proper amplifier settings to enter in the probe parameters. The amplifier settings are determined for a given frequency by subjecting the probe to a known E-field density (1 mW/cm^2) using an RF Signal generator, TEM cell, and RF Power Meter.

The free space E-field from amplified probe outputs is determined in a test chamber. This calibration can be performed in a TEM cell if the frequency is below 1 GHz and in a waveguide or

other methodologies above 1 GHz for free space. For the free space calibration, the probe is placed in the volumetric center of the cavity and at the proper orientation with the field. The probe is then rotated 360 degrees until the three channels show the maximum reading. The power density readings equates to 1 mW/ cm² :

E-field temperature correlation calibration is performed in a flat phantom filled with the appropriate simulated brain tissue. The E-field in the medium correlates with the temperature rise in the dielectric medium. For temperature correlation calibration a RF transparent thermistor-based temperature probe is used in conjunction with the E-field probe.

$$SAR = C \frac{\Delta T}{\Delta t}$$

Where:

Δt = Exposure time (30 seconds),

C = Heat capacity of tissue (brain or muscle),

ΔT = Temperature increase due to RF exposure.

$$SAR = \frac{|E|^2 \cdot \sigma}{\rho}$$

Where:

σ = Simulated tissue conductivity,

ρ = Tissue density (kg/m³).

C.4 Other Test Equipment

C.4.1 Data Acquisition Electronics (DAE)

The data acquisition electronics consist of a highly sensitive electrometer-grade preamplifier with auto-zeroing, a channel and gain-switching multiplexer, a fast 16 bit AD-converter and a command decoder with a control logic unit. Transmission to the measurement server is accomplished through an optical downlink for data and status information, as well as an optical uplink for commands and the clock.

The mechanical probe mounting device includes two different sensor systems for frontal and sideways probe contacts. They are used for mechanical surface detection and probe collision detection.

The input impedance of the DAE is 200 MOhm; the inputs are symmetrical and floating. Common mode rejection is above 80 dB.



PictureC.4: DAE

C.4.2 Robot

The SPEAG DASY system uses the high precision robots (DASY5: RX160L) type from Stäubli SA (France). For the 6-axis controller system, the robot controller version from Stäubli is used. The Stäubli robot series have many features that are important for our application:

- High precision (repeatability 0.02mm)
- High reliability (industrial design)
- Low maintenance costs (virtually maintenance free due to direct drive gears; no belt drives)
- Jerk-free straight movements (brushless synchron motors; no stepper motors)
- Low ELF interference (motor control fields shielded via the closed metallic construction shields)



Picture C.5 DASY 5

C.4.3 Measurement Server

The Measurement server is based on a PC/104 CPU board with CPU (DASY5: 400 MHz, Intel Celeron), chipdisk (DASY5:128MB), RAM (DASY5:128MB). The necessary circuits for communication with the DAE electronic box, as well as the 16 bit AD converter system for optical detection and digital I/O interface are contained on the DASY I/O board, which is directly connected to the PC/104 bus of the CPU board.

The measurement server performs all real-time data evaluation of field measurements and surface detection, controls robot movements and handles safety operation. The PC operating system cannot interfere with these time critical processes. All connections are supervised by a watchdog, and disconnection of any of the cables to the measurement server will automatically disarm the robot and disable all program-controlled robot movements. Furthermore, the measurement server is equipped with an expansion port which is reserved for future applications. Please note that this expansion port does not have a standardized pinout, and therefore only devices provided by SPEAG can be connected. Devices from any other supplier could seriously damage the measurement server.



Picture C.6 Server for DASY 5

C.4.4 Device Holder for Phantom

The SAR in the phantom is approximately inversely proportional to the square of the distance between the source and the liquid surface. For a source at 5mm distance, a positioning uncertainty of $\pm 0.5\text{mm}$ would produce a SAR uncertainty of $\pm 20\%$. Accurate device positioning is therefore crucial for accurate and repeatable measurements. The positions in which the devices must be measured are defined by the standards.

The DASY device holder is designed to cope with the different positions given in the standard. It has two scales for device rotation (with respect to the body axis) and device inclination (with respect to the line between the ear reference points). The rotation centers for both scales is the ear reference point (ERP). Thus the device needs no repositioning when changing the angles.

The DASY device holder is constructed of low-loss POM material having the following dielectric

parameters: relative permittivity $\varepsilon = 3$ and loss tangent $\delta = 0.02$. The amount of dielectric material has been reduced in the closest vicinity of the device, since measurements have suggested that the influence of the clamp on the test results could thus be lowered.

<Laptop Extension Kit>

The extension is lightweight and made of POM, acrylic glass and foam. It fits easily on the upper part of the Mounting Device in place of the phone positioner. The extension is fully compatible with the Twin-SAM and ELI phantoms.



Picture C.7-1: Device Holder

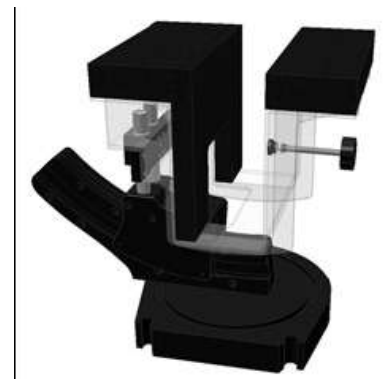

Picture C.7-2: Laptop Extension Kit

C.4.5 Phantom

The SAM Twin Phantom V4.0 is constructed of a fiberglass shell integrated in a table. The shape of the shell is based on data from an anatomical study designed to

Represent the 90th percentile of the population. The phantom enables the dissymmetric evaluation of SAR for both left and right handed handset usage, as well as body-worn usage using the flat phantom region. Reference markings on the Phantom allow the complete setup of all predefined phantom positions and measurement grids by manually teaching three points in the robot. The shell phantom has a 2mm shell thickness (except the ear region where shell thickness increases to 6 mm).

Shell Thickness: 2 ± 0.2 mm
Filling Volume: Approx. 25 liters
Dimensions: 810 x 1000 x 500 mm (H x L x W)
Available: Special



Picture C.8: SAM Twin Phantom

ANNEX D Position of the wireless device in relation to the phantom

D.1 General considerations

This standard specifies two handset test positions against the head phantom – the “cheek” position and the “tilt” position.

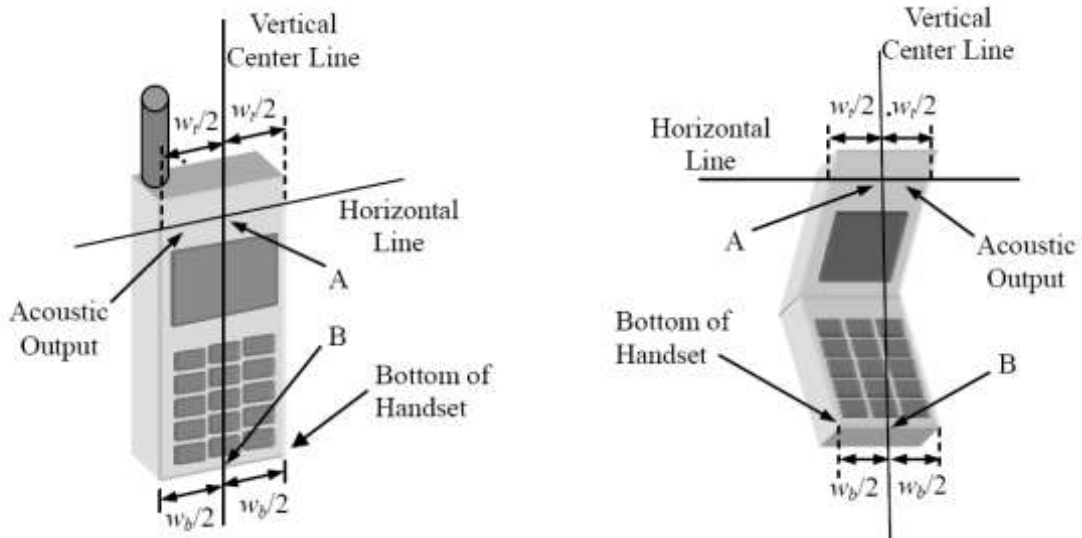

- w_t Width of the handset at the level of the acoustic
- w_b Width of the bottom of the handset
- A Midpoint of the width w_t of the handset at the level of the acoustic output
- B Midpoint of the width w_b of the bottom of the handset

Picture D.1-a Typical “fixed” case handset Picture D.1-b Typical “clam-shell” case handset

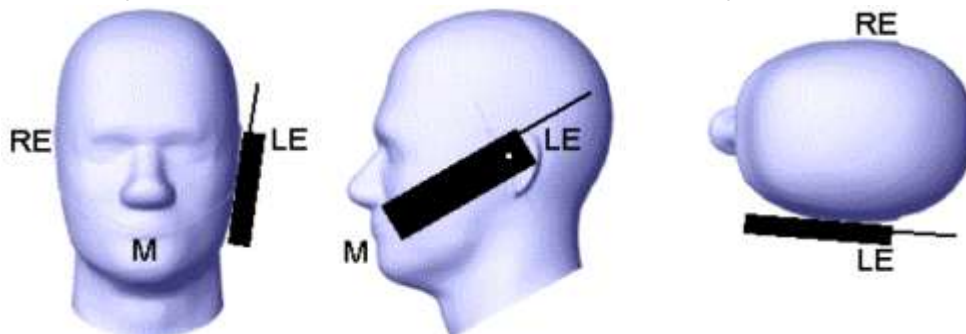

Picture D.2 Cheek position of the wireless device on the left side of SAM

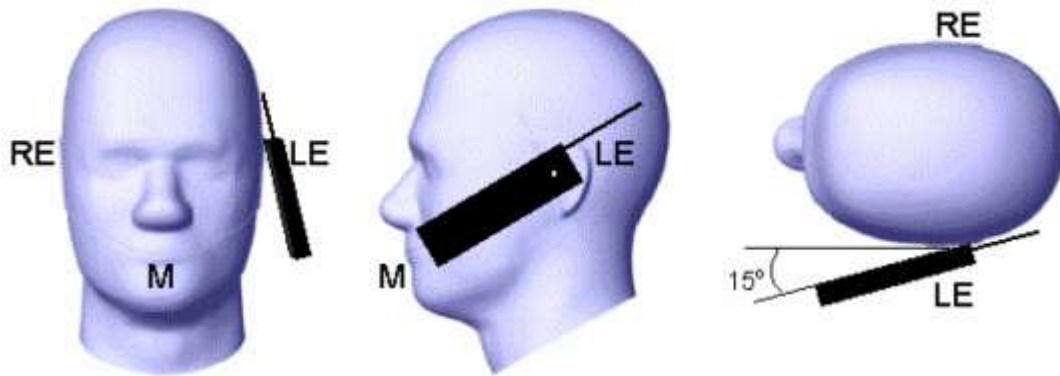

Picture D.3 Tilt position of the wireless device on the left side of SAM

D.2 Body-worn device

A typical example of a body-worn device is a mobile phone, wireless enabled PDA or other battery operated wireless device with the ability to transmit while mounted on a person's body using a carry accessory approved by the wireless device manufacturer.

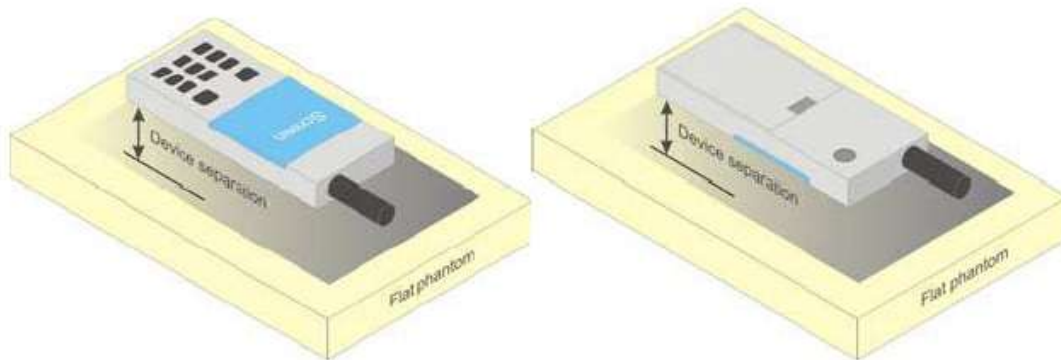

Picture D.4 Test positions for body-worn devices

D.3 Desktop device

A typical example of a desktop device is a wireless enabled desktop computer placed on a table or desk when used.

The DUT shall be positioned at the distance and in the orientation to the phantom that corresponds to the intended use as specified by the manufacturer in the user instructions. For devices that employ an external antenna with variable positions, tests shall be performed for all antenna positions specified. Picture 8.5 show positions for desktop device SAR tests. If the intended use is not specified, the device shall be tested directly against the flat phantom.

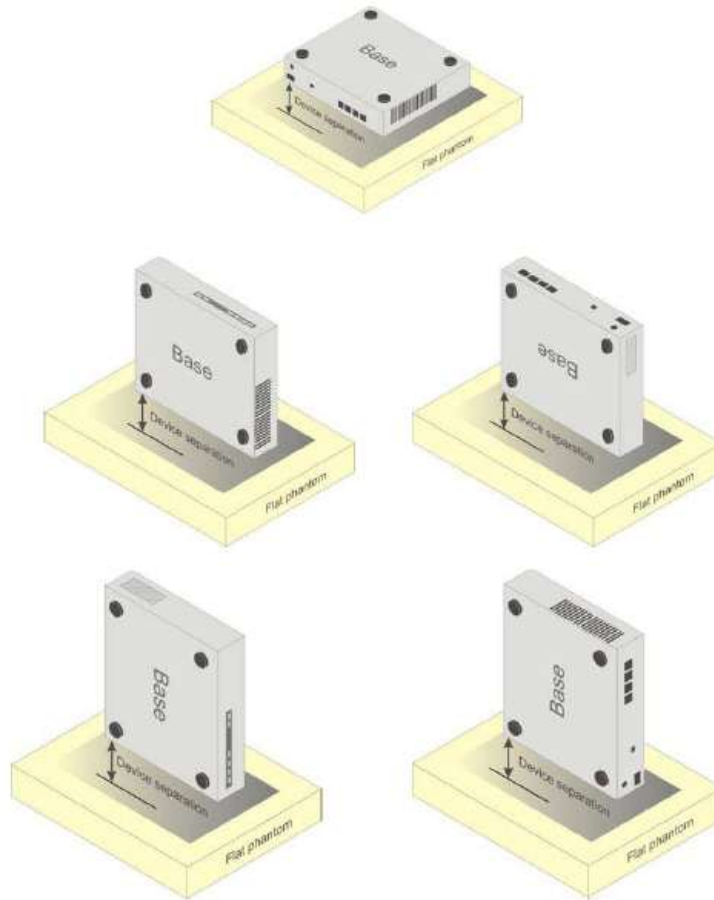

Picture D.5 Test positions for desktop devices

D.4 DUT Setup Photos



Picture D.6

ANNEX E Equivalent Media Recipes

The liquid used for the frequency range of 700-6000 MHz consisted of water, sugar, salt, preventol, glycol monobutyl and Cellulose. The liquid has been previously proven to be suited for worst-case. The Table E.1 shows the detail solution. It's satisfying the latest tissue dielectric parameters requirements proposed by the IEEE 1528 and IEC 62209.

Table E.1: Composition of the Tissue Equivalent Matter

Frequency (MHz)	835 Head	835 Body	1900 Head	1900 Body	2450 Head	2450 Body	5800 Head	5800 Body
Ingredients (% by weight)								
Water	41.45	52.5	55.242	69.91	58.79	72.60	65.53	65.53
Sugar	56.0	45.0	\	\	\	\	\	\
Salt	1.45	1.4	0.306	0.13	0.06	0.18	\	\
Preventol	0.1	0.1	\	\	\	\	\	\
Cellulose	1.0	1.0	\	\	\	\	\	\
Glycol Monobutyl	\	\	44.452	29.96	41.15	27.22	\	\
Diethylenglycol monohexylether	\	\	\	\	\	\	17.24	17.24
Triton X-100	\	\	\	\	\	\	17.24	17.24
Dielectric Parameters Target Value	$\epsilon=41.5$ $\sigma=0.90$	$\epsilon=55.2$ $\sigma=0.97$	$\epsilon=40.0$ $\sigma=1.40$	$\epsilon=53.3$ $\sigma=1.52$	$\epsilon=39.2$ $\sigma=1.80$	$\epsilon=52.7$ $\sigma=1.95$	$\epsilon=35.3$ $\sigma=5.27$	$\epsilon=48.2$ $\sigma=6.00$

Note: There is a little adjustment respectively for 750, 1800, 2600, 5200, 5300, and 5600, based on the recipe of closest frequency in table E.1

ANNEX F System Validation

The SAR system must be validated against its performance specifications before it is deployed. When SAR probes, system components or software are changed, upgraded or recalibrated, these must be validated with the SAR system(s) that operates with such components.

Table F.1: System Validation

Probe SN.	Liquid name	Validation date	Frequency point	Status (OK or Not)
3633	Head 750MHz	2019-03-02	750 MHz	OK
3633	Head 835MHz	2019-03-02	835 MHz	OK
3633	Head 1750MHz	2019-03-02	1800 MHz	OK
3633	Head 1900MHz	2019-03-02	1900 MHz	OK
3633	Head 2450MHz	2019-03-02	2450 MHz	OK
3633	Head 2550MHz	2019-03-02	2550 MHz	OK
3633	Head 5200MHz	2019-03-02	5200 MHz	OK
3633	Head 5300MHz	2019-03-02	5300 MHz	OK
3633	Head 5600MHz	2019-03-02	5600 MHz	OK
3633	Head 5800MHz	2019-03-02	5800 MHz	OK
3633	Body 750MHz	2019-03-03	750 MHz	OK
3633	Body 835MHz	2019-03-03	835 MHz	OK
3633	Body 1750MHz	2019-03-03	1800 MHz	OK
3633	Body 1900MHz	2019-03-03	1900 MHz	OK
3633	Body 2450MHz	2019-03-03	2450 MHz	OK
3633	Body 2550MHz	2019-03-03	5200 MHz	OK
3633	Body 5200MHz	2019-03-03	5200 MHz	OK
3633	Body 5300MHz	2019-03-03	5300 MHz	OK
3633	Body 5600MHz	2019-03-03	5600 MHz	OK
3633	Body 5800MHz	2019-03-03	5800 MHz	OK

ANNEX G LTE Band 41 Power Class 2 and Power Class 3 Linearity

This device supports Power Class 2 and Power Class 3 operations for LTE Band 41. The highest available duty cycle for Power Class 2 operations is 43.3 % using UL-DL configuration 1. Per May 2017 TCB Workshop Notes based on the device behavior, all SAR tests were performed using Power Class 3. SAR with Power Class 2 at the highest power and available duty factor was additionally performed for the Power Class 3 configuration with the highest SAR for each exposure condition. The linearity between the Power Class 2 and Power Class 3 SAR results and the respective frame averaged powers was calculated to determine that the results were linear. When ULCA is active, the device does not supports Power Class 2. Per May 2017 TCB Workshop, no additional SAR measurements were required since the linearity between power classes was < 10% and all reported SAR values were < 1.4 W/kg for 1g and < 3.5 W/kg for 10g.

LTE Band 41 SAR testing with power class 2 at the highest power and available duty factor was additionally performed for the power class 3 configuration with the highest SAR for each exposure condition.

Table G.1 LTE Band 41 Single Carrier Head Linearity Data

/	LTE Band 41 PC3	LTE Band 41 PC2
Maximum Tune up Power (dBm)	24.0	26.5
Reported 1g SAR (W/kg)	0.15	0.17
Duty Cycle	63.30%	43.30%
Frame Averaged (mW)	159.00	193.41
Linearity SAR (W/kg)	0.182	
% deviation from expected linearity		-6.83%

Table G.2 LTE Band 41 Single Carrier Hotspot Linearity Data

/	LTE Band 41 PC3	LTE Band 41 PC2
Maximum Tune up Power (dBm)	21.0	23.5
Reported 1g SAR (W/kg)	0.12	0.14
Duty Cycle	63.30%	43.30%
Frame Averaged (mW)	79.69	96.94
Linearity SAR (W/kg)	0.146	
% deviation from expected linearity		-4.09%

Table G.3 LTE Band 41 Single Carrier Body-Worn Linearity Data

/	LTE Band 41 PC3	LTE Band 41 PC2
Maximum Tune up Power (dBm)	24.0	26.5
Reported 1g SAR (W/kg)	0.24	0.31
Duty Cycle	63.30%	43.30%
Frame Averaged (mW)	159.00	193.41
Linearity SAR (W/kg)	0.292	
% deviation from expected linearity		6.19%

ANNEX H DAE Calibration Certificate

DAE4 SN: 786 Calibration Certificate



In Collaboration with
s p e a g
CALIBRATION LABORATORY

Add: No.51 Xueyuan Road, Haidian District, Beijing, 100191, China
Tel: +86-10-62304633-2512 Fax: +86-10-62304633-2504
E-mail: cttl@chinattl.com [Http://www.chinattl.cn](http://www.chinattl.cn)



中国认可
国际互认
校准
CALIBRATION
CNAS L0570

Client : **CTTL(South Branch)** Certificate No: **Z19-60016**

CALIBRATION CERTIFICATE			
Object	DAE4 - SN: 786		
Calibration Procedure(s)	FF-Z11-002-01 Calibration Procedure for the Data Acquisition Electronics (DAEx)		
Calibration date:	January 11, 2019		
<p>This calibration Certificate documents the traceability to national standards, which realize the physical units of measurements(SI). The measurements and the uncertainties with confidence probability are given on the following pages and are part of the certificate.</p> <p>All calibrations have been conducted in the closed laboratory facility: environment temperature(22±3)°C and humidity<70%.</p> <p>Calibration Equipment used (M&TE critical for calibration)</p>			
Primary Standards	ID #	Cal Date(Calibrated by, Certificate No.)	Scheduled Calibration
Process Calibrator 753	1971018	20-Jun-18 (CTTL, No.J18X05034)	June-19
Calibrated by:	Name	Function	Signature
	Yu Zongying	SAR Test Engineer	
Reviewed by:	Lin Hao	SAR Test Engineer	
Approved by:	Qi Dianyuan	SAR Project Leader	
Issued: January 14, 2019			
This calibration certificate shall not be reproduced except in full without written approval of the laboratory.			



Add: No.51 Xueyuan Road, Haidian District, Beijing, 100191, China
Tel: +86-10-62304633-2512 Fax: +86-10-62304633-2504
E-mail: ttl@chinattl.com [Http://www.chinattl.cn](http://www.chinattl.cn)

Glossary:

DAE data acquisition electronics
Connector angle information used in DASY system to align probe sensor X to the robot coordinate system.

Methods Applied and Interpretation of Parameters:

- *DC Voltage Measurement:* Calibration Factor assessed for use in DASY system by comparison with a calibrated instrument traceable to national standards. The figure given corresponds to the full scale range of the voltmeter in the respective range.
- *Connector angle:* The angle of the connector is assessed measuring the angle mechanically by a tool inserted. Uncertainty is not required.
- The report provide only calibration results for DAE, it does not contain other performance test results.



Add: No.51 Xueyuan Road, Haidian District, Beijing, 100191, China
Tel: +86-10-62304633-2512 Fax: +86-10-62304633-2504
E-mail: cttl@chinattl.com Http://www.chinattl.cn

DC Voltage Measurement

A/D - Converter Resolution nominal
High Range: 1LSB = 6.1 μ V, full range = -100...+300 mV
Low Range: 1LSB = 61nV, full range = -1.....+3mV
DASY measurement parameters: Auto Zero Time: 3 sec; Measuring time: 3 sec

Calibration Factors	X	Y	Z
High Range	404.064 \pm 0.15% (k=2)	404.247 \pm 0.15% (k=2)	404.629 \pm 0.15% (k=2)
Low Range	3.97273 \pm 0.7% (k=2)	3.97435 \pm 0.7% (k=2)	3.95858 \pm 0.7% (k=2)

Connector Angle

Connector Angle to be used in DASY system	229.5 $^{\circ}$ \pm 1 $^{\circ}$
---	-------------------------------------

ANNEX I Probe Calibration Certificate

Probe EX3DV4-SN: 3633 Calibration Certificate



Add: No.51 Xueyuan Road, Haidian District, Beijing, 100191, China
Tel: +86-10-62304633-2512 Fax: +86-10-62304633-2504
E-mail: ctll@chinattl.com <http://www.chinattl.cn>



中国认可
国际互认
校准
CALIBRATION
CNAS L0570

Client **CTTL(South Branch)**

Certificate No: **Z19-60033**

CALIBRATION CERTIFICATE

Object: EX3DV4 - SN:3633

Calibration Procedure(s): FF-Z11-004-01
Calibration Procedures for Dosimetric E-field Probes

Calibration date: February 26, 2019

This calibration Certificate documents the traceability to national standards, which realize the physical units of measurements(SI). The measurements and the uncertainties with confidence probability are given on the following pages and are part of the certificate.

All calibrations have been conducted in the closed laboratory facility; environment temperature(22±3)°C and humidity<70%.

Calibration Equipment used (M&TE critical for calibration)

Primary Standards	ID #	Cal Date(Calibrated by, Certificate No.)	Scheduled Calibration
Power Meter NRP2	101919	20-Jun-18 (CTTL, No.J18X05032)	Jun-19
Power sensor NRP-Z91	101547	20-Jun-18 (CTTL, No.J18X05032)	Jun-19
Power sensor NRP-Z91	101548	20-Jun-18 (CTTL, No.J18X05032)	Jun-19
Reference10dBAttenuator	18N50W-10dB	09-Feb-18(CTTL, No.J18X01133)	Feb-20
Reference20dBAttenuator	18N50W-20dB	09-Feb-18(CTTL, No.J18X01132)	Feb-20
Reference Probe EX3DV4	SN 7514	27-Aug-18(SPEAG, No.EX3-7514_Aug18/2)	Aug-19
DAE4	SN 1555	20-Aug-18(SPEAG, No.DAE4-1555_Aug18)	Aug -19
Secondary Standards	ID #	Cal Date(Calibrated by, Certificate No.)	Scheduled Calibration
SignalGeneratorMG3700A	6201052605	21-Jun-18 (CTTL, No.J18X05033)	Jun-19
Network Analyzer E5071C	MY46110673	24-Jan-18 (CTTL, No.J18X00561)	Jan -19

	Name	Function	Signature
Calibrated by:	Yu Zongying	SAR Test Engineer	
Reviewed by:	Lin Hao	SAR Test Engineer	
Approved by:	Qi Dianyuan	SAR Project Leader	

Issued: February 26, 2019

This calibration certificate shall not be reproduced except in full without written approval of the laboratory.



Add: No.51 Xueyuan Road, Haidian District, Beijing, 100191, China
Tel: +86-10-62304633-2512 Fax: +86-10-62304633-2504
E-mail: cti@chinattl.com <http://www.chinattl.cn>

Glossary:

TSL	tissue simulating liquid
NORM _{x,y,z}	sensitivity in free space
ConvF	sensitivity in TSL / NORM _{x,y,z}
DCP	diode compression point
CF	crest factor (1/duty_cycle) of the RF signal
A,B,C,D	modulation dependent linearization parameters
Polarization Φ	Φ rotation around probe axis
Polarization θ	θ rotation around an axis that is in the plane normal to probe axis (at measurement center), $\theta=0$ is normal to probe axis

Connector Angle information used in DASY system to align probe sensor X to the robot coordinate system

Calibration is Performed According to the Following Standards:

- IEEE Std 1528-2013, "IEEE Recommended Practice for Determining the Peak Spatial-Averaged Specific Absorption Rate (SAR) in the Human Head from Wireless Communications Devices: Measurement Techniques", June 2013
- IEC 62209-1, "Measurement procedure for the assessment of Specific Absorption Rate (SAR) from hand-held and body-mounted devices used next to the ear (frequency range of 300 MHz to 6 GHz)", July 2016
- IEC 62209-2, "Procedure to determine the Specific Absorption Rate (SAR) for wireless communication devices used in close proximity to the human body (frequency range of 30 MHz to 6 GHz)", March 2010
- KDB 865664, "SAR Measurement Requirements for 100 MHz to 6 GHz"

Methods Applied and Interpretation of Parameters:

- NORM_{x,y,z}:** Assessed for E-field polarization $\theta=0$ ($f \leq 900\text{MHz}$ in TEM-cell; $f > 1800\text{MHz}$: waveguide). NORM_{x,y,z} are only intermediate values, i.e., the uncertainties of NORM_{x,y,z} does not effect the E^2 -field uncertainty inside TSL (see below ConvF).
- NORM(f)_{x,y,z} = NORM_{x,y,z} * frequency_response** (see Frequency Response Chart). This linearization is implemented in DASY4 software versions later than 4.2. The uncertainty of the frequency response is included in the stated uncertainty of ConvF.
- DCP_{x,y,z}:** DCP are numerical linearization parameters assessed based on the data of power sweep (no uncertainty required). DCP does not depend on frequency nor media.
- PAR:** PAR is the Peak to Average Ratio that is not calibrated but determined based on the signal characteristics.
- A_{x,y,z}; B_{x,y,z}; C_{x,y,z}; VR_{x,y,z}; A,B,C** are numerical linearization parameters assessed based on the data of power sweep for specific modulation signal. The parameters do not depend on frequency nor media. VR is the maximum calibration range expressed in RMS voltage across the diode.
- ConvF and Boundary Effect Parameters:** Assessed in flat phantom using E-field (or Temperature Transfer Standard for $f \leq 800\text{MHz}$) and inside waveguide using analytical field distributions based on power measurements for $f > 800\text{MHz}$. The same setups are used for assessment of the parameters applied for boundary compensation (alpha, depth) of which typical uncertainty valued are given. These parameters are used in DASY4 software to improve probe accuracy close to the boundary. The sensitivity in TSL corresponds to NORM_{x,y,z} * ConvF whereby the uncertainty corresponds to that given for ConvF. A frequency dependent ConvF is used in DASY version 4.4 and higher which allows extending the validity from $\pm 50\text{MHz}$ to $\pm 100\text{MHz}$.
- Spherical Isotropy (3D deviation from isotropy):** in a field of low gradients realized using a flat phantom exposed by a patch antenna.
- Sensor Offset:** The sensor offset corresponds to the offset of virtual measurement center from the probe tip (on probe axis). No tolerance required.
- Connector Angle:** The angle is assessed using the information gained by determining the NORM_x (no uncertainty required).



Add: No.51 Xueyuan Road, Haidian District, Beijing, 100191, China
Tel: +86-10-62304633-2512 Fax: +86-10-62304633-2504
E-mail: ttl@chinattl.com <http://www.chinattl.cn>

Probe EX3DV4

SN: 3633

Calibrated: February 26, 2019

Calibrated for DASY/EASY Systems

(Note: non-compatible with DASY2 system!)



Add: No.51 Xueyuan Road, Haidian District, Beijing, 100191, China
Tel: +86-10-62304633-2512 Fax: +86-10-62304633-2504
E-mail: cti@chinattl.com <http://www.chinattl.cn>

DASY/EASY – Parameters of Probe: EX3DV4 – SN: 3633

Basic Calibration Parameters

	Sensor X	Sensor Y	Sensor Z	Unc (k=2)
Norm($\mu\text{V}/(\text{V}/\text{m})^2$) ^A	0.39	0.37	0.39	$\pm 10.0\%$
DCP(mV) ^B	97.3	98.6	98.6	

Modulation Calibration Parameters

UID	Communication System Name		A dB	B dB· μV	C	D dB	VR mV	Unc ^E (k=2)
0	CW	X	0.0	0.0	1.0	0.00	144.3	$\pm 2.0\%$
		Y	0.0	0.0	1.0		145.2	
		Z	0.0	0.0	1.0		147.9	

The reported uncertainty of measurement is stated as the standard uncertainty of Measurement multiplied by the coverage factor k=2, which for a normal distribution Corresponds to a coverage probability of approximately 95%.

^A The uncertainties of Norm X, Y, Z do not affect the E²-field uncertainty inside TSL (see Page 5 and Page 6).

^B Numerical linearization parameter: uncertainty not required.

^E Uncertainty is determined using the max. deviation from linear response applying rectangular distribution and is expressed for the square of the field value.



Add: No.51 Xueyuan Road, Haidian District, Beijing, 100191, China
Tel: +86-10-62304633-2512 Fax: +86-10-62304633-2504
E-mail: ttl@chinattl.com <http://www.chinattl.cn>

DASY/EASY – Parameters of Probe: EX3DV4 – SN: 3633

Calibration Parameter Determined in Head Tissue Simulating Media

f [MHz] ^c	Relative Permittivity ^f	Conductivity (S/m) ^f	ConvF X	ConvF Y	ConvF Z	Alpha ^g	Depth ^g (mm)	Unct. (k=2)
750	41.9	0.89	9.51	9.51	9.51	0.09	1.70	±12.1%
900	41.5	0.97	9.27	9.27	9.27	0.27	0.92	±12.1%
1640	40.3	1.29	8.16	8.16	8.16	0.21	1.06	±12.1%
1750	40.1	1.37	8.07	8.07	8.07	0.26	1.00	±12.1%
1900	40.0	1.40	7.63	7.63	7.63	0.24	1.07	±12.1%
2100	39.8	1.49	7.60	7.60	7.60	0.25	1.02	±12.1%
2300	39.5	1.67	7.60	7.60	7.60	0.61	0.69	±12.1%
2450	39.2	1.80	7.33	7.33	7.33	0.61	0.70	±12.1%
2600	39.0	1.96	7.12	7.12	7.12	0.47	0.99	±12.1%
3500	37.9	2.91	6.74	6.74	6.74	0.62	0.86	±13.3%
3700	37.7	3.12	6.47	6.47	6.47	0.58	0.88	±13.3%
5250	35.9	4.71	5.42	5.42	5.42	0.45	1.15	±13.3%
5600	35.5	5.07	4.72	4.72	4.72	0.45	1.30	±13.3%
5750	35.4	5.22	4.73	4.73	4.73	0.45	1.30	±13.3%

^c Frequency validity above 300 MHz of ±100MHz only applies for DASY v4.4 and higher (Page 2), else it is restricted to ±50MHz. The uncertainty is the RSS of ConvF uncertainty at calibration frequency and the uncertainty for the indicated frequency band. Frequency validity below 300 MHz is ± 10, 25, 40, 50 and 70 MHz for ConvF assessments at 30, 64, 128, 150 and 220 MHz respectively. Above 5 GHz frequency validity can be extended to ± 110 MHz.

^f At frequency below 3 GHz, the validity of tissue parameters (ϵ and σ) can be relaxed to ±10% if liquid compensation formula is applied to measured SAR values. At frequencies above 3 GHz, the validity of tissue parameters (ϵ and σ) is restricted to ±5%. The uncertainty is the RSS of the ConvF uncertainty for indicated target tissue parameters.

^g Alpha/Depth are determined during calibration, SPEAG warrants that the remaining deviation due to the boundary effect after compensation is always less than ± 1% for frequencies below 3 GHz and below ± 2% for the frequencies between 3-6 GHz at any distance larger than half the probe tip diameter from the boundary.



Add: No.51 Xueyuan Road, Haidian District, Beijing, 100191, China
Tel: +86-10-62304633-2512 Fax: +86-10-62304633-2504
E-mail: ttl@chinatti.com <http://www.chinatti.cn>

DASY/EASY – Parameters of Probe: EX3DV4 – SN: 3633

Calibration Parameter Determined in Body Tissue Simulating Media

f [MHz] [Ⓒ]	Relative Permittivity [Ⓕ]	Conductivity (S/m) [Ⓕ]	ConvF X	ConvF Y	ConvF Z	Alpha [Ⓖ]	Depth [Ⓖ] (mm)	Unct. (k=2)
750	55.5	0.96	9.56	9.56	9.56	0.40	0.80	±12.1%
900	55.0	1.05	9.25	9.25	9.25	0.20	1.24	±12.1%
1840	53.8	1.40	7.90	7.90	7.90	0.22	1.14	±12.1%
1750	53.4	1.49	7.93	7.93	7.93	0.20	1.16	±12.1%
1900	53.3	1.52	7.67	7.67	7.67	0.21	1.20	±12.1%
2100	53.2	1.62	7.56	7.56	7.56	0.22	1.18	±12.1%
2300	52.9	1.81	7.48	7.48	7.48	0.55	0.80	±12.1%
2450	52.7	1.95	7.40	7.40	7.40	0.62	0.76	±12.1%
2600	52.5	2.16	7.21	7.21	7.21	0.69	0.70	±12.1%
3500	51.3	3.31	6.45	6.45	6.45	0.50	1.15	±13.3%
3700	51.0	3.55	6.37	6.37	6.37	0.52	1.05	±13.3%
5250	48.9	5.36	5.03	5.03	5.03	0.55	1.30	±13.3%
5600	48.5	5.77	4.19	4.19	4.19	0.55	1.50	±13.3%
5750	48.3	5.94	4.29	4.29	4.29	0.55	1.30	±13.3%

[Ⓒ] Frequency validity above 300 MHz of ±100MHz only applies for DASY v4.4 and higher (Page 2), else it is restricted to ±50MHz. The uncertainty is the RSS of ConvF uncertainty at calibration frequency and the uncertainty for the indicated frequency band. Frequency validity below 300 MHz is ±10, 25, 40, 50 and 70 MHz for ConvF assessments at 30, 64, 128, 150 and 220 MHz respectively. Above 5 GHz frequency validity can be extended to ±110 MHz.

[Ⓕ] At frequency below 3 GHz, the validity of tissue parameters (ϵ and σ) can be relaxed to ±10% if liquid compensation formula is applied to measured SAR values. At frequencies above 3 GHz, the validity of tissue parameters (ϵ and σ) is restricted to ±5%. The uncertainty is the RSS of the ConvF uncertainty for indicated target tissue parameters.

[Ⓖ] Alpha/Depth are determined during calibration. SPEAG warrants that the remaining deviation due to the boundary effect after compensation is always less than ±1% for frequencies below 3 GHz and below ±2% for the frequencies between 3-6 GHz at any distance larger than half the probe tip diameter from the boundary.



Add: No.51 Xueyuan Road, Haidian District, Beijing, 100191, China
Tel: +86-10-62304633-2512 Fax: +86-10-62304633-2504
E-mail: ctl@chinattl.com <http://www.chinattl.cn>

Frequency Response of E-Field (TEM-Cell: ifi110 EXX, Waveguide: R22)

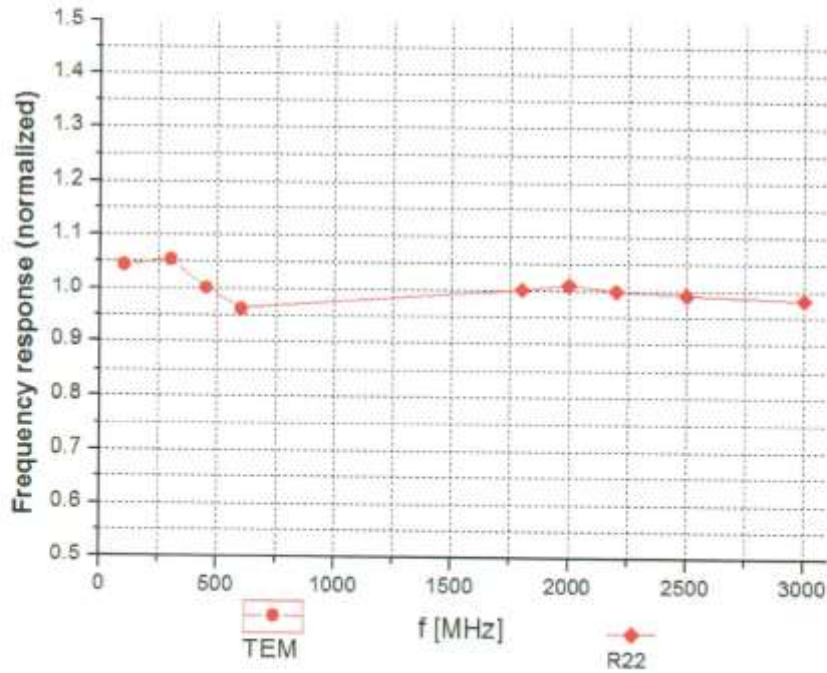

Uncertainty of Frequency Response of E-field: $\pm 7.4\%$ (k=2)



Addr: No.51 Xueyuan Road, Haidian District, Beijing, 100191, China
Tel: +86-10-62304633-2512 Fax: +86-10-62304633-2504
E-mail: cti@chinatl.com <http://www.chinatl.cn>

Receiving Pattern (Φ), $\theta=0^\circ$

f=600 MHz, TEM

f=1800 MHz, R22

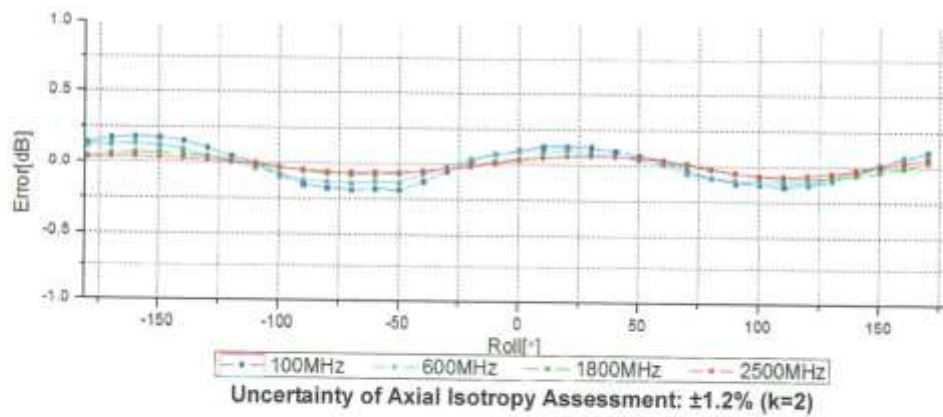
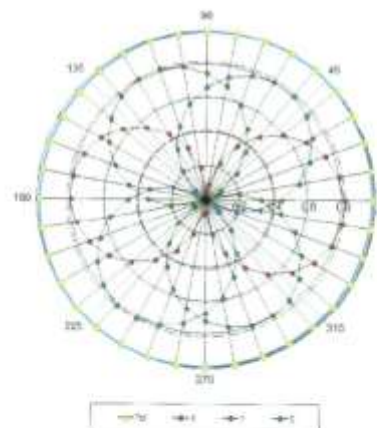
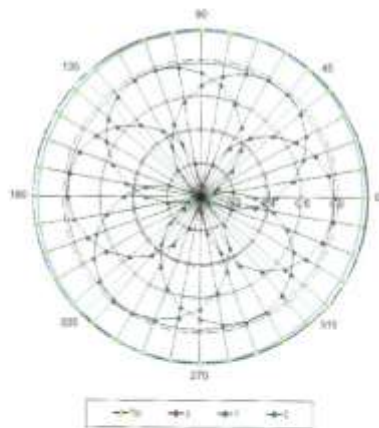



Add: No.51 Xueyuan Road, Haidian District, Beijing, 100191, China
Tel: +86-10-62304633-2512 Fax: +86-10-62304633-2504
E-mail: cttl@chinattl.com <http://www.chinattl.cn>

Dynamic Range f(SAR_{head}) (TEM cell, f = 900 MHz)

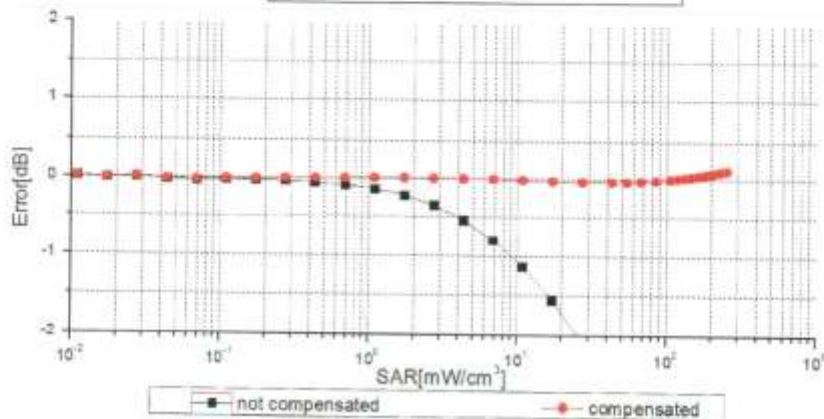
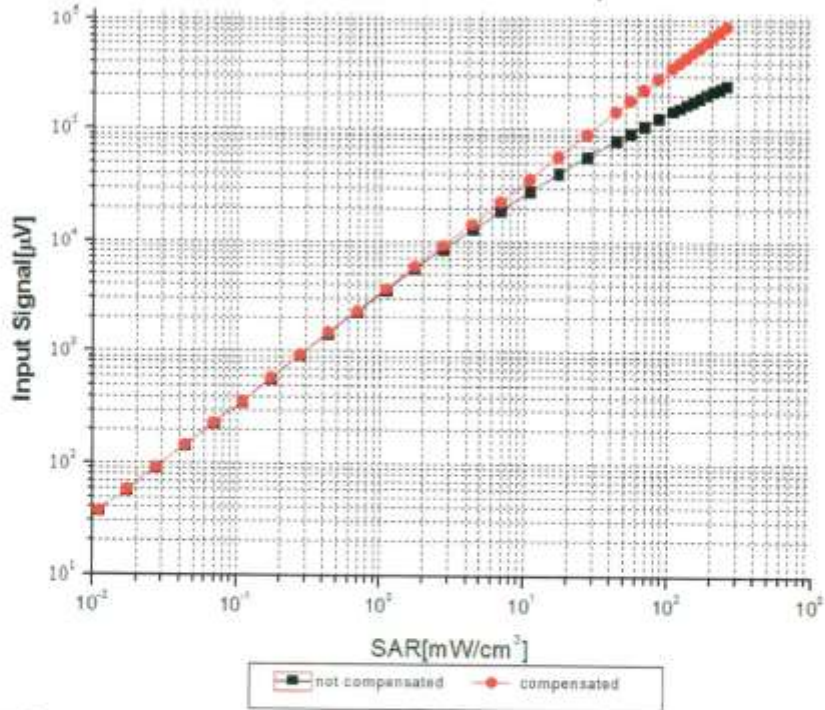

Uncertainty of Linearity Assessment: ±0.9% (k=2)



Add: No.51 Xueyuan Road, Haidian District, Beijing, 100191, China
Tel: +86-10-62304633-2512 Fax: +86-10-62304633-2504
E-mail: cttl@chinattl.com <http://www.chinattl.cn>

Conversion Factor Assessment

f=750 MHz, WGLS R9(H_convF)

f=1750 MHz, WGLS R22(H_convF)

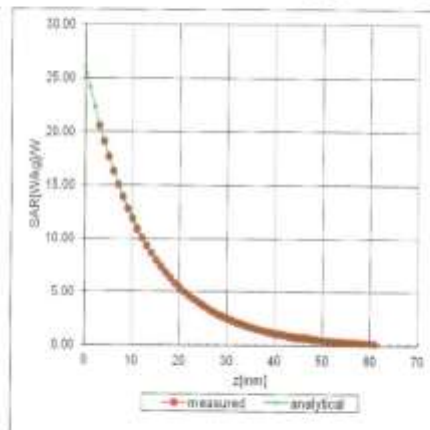
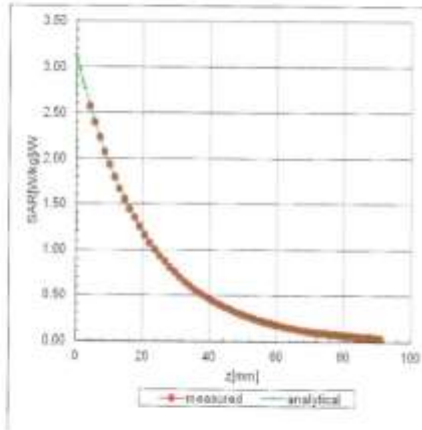

Deviation from Isotropy in Liquid

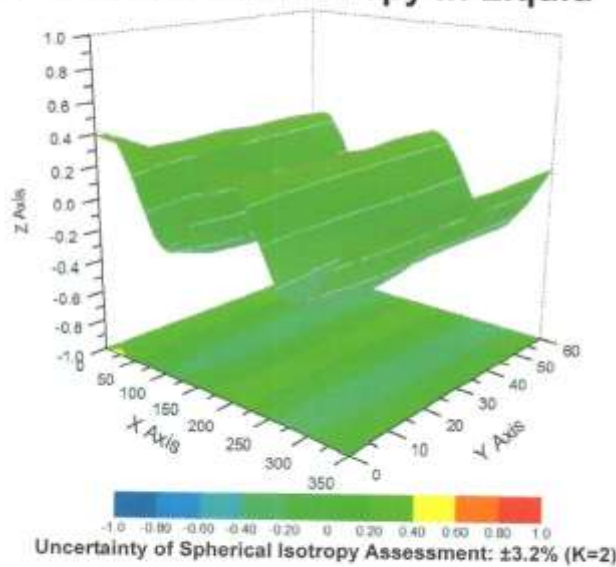



Add: No.51 Xueyuan Road, Haidian District, Beijing, 100191, China
Tel: +86-10-62304633-2512 Fax: +86-10-62304633-2504
E-mail: cttl@chinattl.com <http://www.chinattl.cn>

DASY/EASY – Parameters of Probe: EX3DV4 – SN: 3633

Other Probe Parameters

Sensor Arrangement	Triangular
Connector Angle (°)	72.2
Mechanical Surface Detection Mode	enabled
Optical Surface Detection Mode	disable
Probe Overall Length	337mm
Probe Body Diameter	10mm
Tip Length	9mm
Tip Diameter	2.5mm
Probe Tip to Sensor X Calibration Point	1mm
Probe Tip to Sensor Y Calibration Point	1mm
Probe Tip to Sensor Z Calibration Point	1mm
Recommended Measurement Distance from Surface	1.4mm

ANNEX J Dipole Calibration Certificate

750 MHz Dipole Calibration Certificate -2016

**Calibration Laboratory of
Schmid & Partner
Engineering AG**
Zeughausstrasse 43, 8004 Zurich, Switzerland



S Schweizerischer Kalibrierdienst
C Service suisse d'étalonnage
S Servizio svizzero di taratura
S Swiss Calibration Service

Accredited by the Swiss Accreditation Service (SAS)
The Swiss Accreditation Service is one of the signatories to the EA
Multilateral Agreement for the recognition of calibration certificates.

Accreditation No.: **SCS 0108**

Client **TMC-SZ (Auden)**

Certificate No: **D750V3-1163_Sep16**

CALIBRATION CERTIFICATE

Object **D750V3 - SN:1163**

Calibration procedure(s) **QA CAL-05.v9
Calibration procedure for dipole validation kits above 700 MHz**

Calibration date: **September 19, 2016**

This calibration certificate documents the traceability to national standards, which realize the physical units of measurements (SI).
The measurements and the uncertainties with confidence probability are given on the following pages and are part of the certificate.

All calibrations have been conducted in the closed laboratory facility: environment temperature (22 ± 3)°C and humidity < 70%.

Calibration Equipment used (M&TE critical for calibration)

Primary Standards	ID #	Cal Date (Certificate No.)	Scheduled Calibration
Power meter NRP	SN: 104776	06-Apr-16 (No. 217-02288/02289)	Apr-17
Power sensor NRP-Z91	SN: 103244	06-Apr-16 (No. 217-02288)	Apr-17
Power sensor NRP-Z91	SN: 103245	06-Apr-16 (No. 217-02289)	Apr-17
Reference 20 dB Attenuator	SN: 5058 (20k)	05-Apr-16 (No. 217-02292)	Apr-17
Type-N mismatch combination	SN: 5047.2 / 06327	05-Apr-16 (No. 217-02295)	Apr-17
Reference Probe EX3DV4	SN: 7349	15-Jun-16 (No. EX3-7349_Jun16)	Jun-17
DAE4	SN: 601	30-Dec-15 (No. DAE4-601_Dec15)	Dec-16
Secondary Standards	ID #	Check Date (in house)	Scheduled Check
Power meter EPM-442A	SN: GB37480704	07-Oct-15 (No. 217-02222)	In house check: Oct-16
Power sensor HP 8481A	SN: US37292783	07-Oct-15 (No. 217-02222)	In house check: Oct-16
Power sensor HP 8481A	SN: MY41092317	07-Oct-15 (No. 217-02223)	In house check: Oct-16
RF generator R&S SMT-06	SN: 100972	15-Jun-15 (in house check Jun-15)	In house check: Oct-16
Network Analyzer HP 8753E	SN: US37390585	18-Oct-01 (in house check Oct-15)	In house check: Oct-16

	Name	Function	Signature
Calibrated by:	Jeton Kastrati	Laboratory Technician	
Approved by:	Katja Pokovic	Technical Manager	

Issued: September 19, 2016

This calibration certificate shall not be reproduced except in full without written approval of the laboratory.

**Calibration Laboratory of
Schmid & Partner
Engineering AG**
Zeughausstrasse 43, 8004 Zurich, Switzerland



S Schweizerischer Kalibrierdienst
C Service suisse d'étalonnage
S Servizio svizzero di taratura
S Swiss Calibration Service

Accredited by the Swiss Accreditation Service (SAS)
The Swiss Accreditation Service is one of the signatories to the EA
Multilateral Agreement for the recognition of calibration certificates

Accreditation No.: **SCS 0108**

Glossary:

TSL	tissue simulating liquid
ConvF	sensitivity in TSL / NORM x,y,z
N/A	not applicable or not measured

Calibration is Performed According to the Following Standards:

- a) IEEE Std 1528-2013, "IEEE Recommended Practice for Determining the Peak Spatial-Averaged Specific Absorption Rate (SAR) in the Human Head from Wireless Communications Devices: Measurement Techniques", June 2013
- b) IEC 62209-1, "Procedure to measure the Specific Absorption Rate (SAR) for hand-held devices used in close proximity to the ear (frequency range of 300 MHz to 3 GHz)", February 2005
- c) IEC 62209-2, "Procedure to determine the Specific Absorption Rate (SAR) for wireless communication devices used in close proximity to the human body (frequency range of 30 MHz to 6 GHz)", March 2010
- d) KDB 865664, "SAR Measurement Requirements for 100 MHz to 6 GHz"

Additional Documentation:

- e) DASy4/5 System Handbook

Methods Applied and Interpretation of Parameters:

- *Measurement Conditions:* Further details are available from the Validation Report at the end of the certificate. All figures stated in the certificate are valid at the frequency indicated.
- *Antenna Parameters with TSL:* The dipole is mounted with the spacer to position its feed point exactly below the center marking of the flat phantom section, with the arms oriented parallel to the body axis.
- *Feed Point Impedance and Return Loss:* These parameters are measured with the dipole positioned under the liquid filled phantom. The impedance stated is transformed from the measurement at the SMA connector to the feed point. The Return Loss ensures low reflected power. No uncertainty required.
- *Electrical Delay:* One-way delay between the SMA connector and the antenna feed point. No uncertainty required.
- *SAR measured:* SAR measured at the stated antenna input power.
- *SAR normalized:* SAR as measured, normalized to an input power of 1 W at the antenna connector.
- *SAR for nominal TSL parameters:* The measured TSL parameters are used to calculate the nominal SAR result.

The reported uncertainty of measurement is stated as the standard uncertainty of measurement multiplied by the coverage factor $k=2$, which for a normal distribution corresponds to a coverage probability of approximately 95%.

Measurement Conditions

DASY system configuration, as far as not given on page 1.

DASY Version	DASY5	V52.8.8
Extrapolation	Advanced Extrapolation	
Phantom	Modular Flat Phantom	
Distance Dipole Center - TSL	15 mm	with Spacer
Zoom Scan Resolution	dx, dy, dz = 5 mm	
Frequency	750 MHz ± 1 MHz	

Head TSL parameters

The following parameters and calculations were applied.

	Temperature	Permittivity	Conductivity
Nominal Head TSL parameters	22.0 °C	41.9	0.89 mho/m
Measured Head TSL parameters	(22.0 ± 0.2) °C	41.0 ± 6 %	0.91 mho/m ± 6 %
Head TSL temperature change during test	< 0.5 °C	----	----

SAR result with Head TSL

SAR averaged over 1 cm ³ (1 g) of Head TSL	Condition	
SAR measured	250 mW input power	2.11 W/kg
SAR for nominal Head TSL parameters	normalized to 1W	8.26 W/kg ± 17.0 % (k=2)

SAR averaged over 10 cm ³ (10 g) of Head TSL	condition	
SAR measured	250 mW input power	1.36 W/kg
SAR for nominal Head TSL parameters	normalized to 1W	5.43 W/kg ± 16.5 % (k=2)

Body TSL parameters

The following parameters and calculations were applied.

	Temperature	Permittivity	Conductivity
Nominal Body TSL parameters	22.0 °C	55.5	0.96 mho/m
Measured Body TSL parameters	(22.0 ± 0.2) °C	54.9 ± 6 %	0.99 mho/m ± 6 %
Body TSL temperature change during test	< 0.5 °C	----	----

SAR result with Body TSL

SAR averaged over 1 cm ³ (1 g) of Body TSL	Condition	
SAR measured	250 mW input power	2.20 W/kg
SAR for nominal Body TSL parameters	normalized to 1W	6.58 W/kg ± 17.0 % (k=2)

SAR averaged over 10 cm ³ (10 g) of Body TSL	condition	
SAR measured	250 mW input power	1.44 W/kg
SAR for nominal Body TSL parameters	normalized to 1W	5.64 W/kg ± 16.5 % (k=2)

Appendix (Additional assessments outside the scope of SCS 0108)

Antenna Parameters with Head TSL

Impedance, transformed to feed point	54.5 Ω - 1.8 j Ω
Return Loss	- 26.8 dB

Antenna Parameters with Body TSL

Impedance, transformed to feed point	49.8 Ω - 3.5 j Ω
Return Loss	- 29.0 dB

General Antenna Parameters and Design

Electrical Delay (one direction)	1.032 ns
----------------------------------	----------

After long term use with 100W radiated power, only a slight warming of the dipole near the feedpoint can be measured.

The dipole is made of standard semirigid coaxial cable. The center conductor of the feeding line is directly connected to the second arm of the dipole. The antenna is therefore short-circuited for DC-signals. On some of the dipoles, small end caps are added to the dipole arms in order to improve matching when loaded according to the position as explained in the "Measurement Conditions" paragraph. The SAR data are not affected by this change. The overall dipole length is still according to the Standard.

No excessive force must be applied to the dipole arms, because they might bend or the soldered connections near the feedpoint may be damaged.

Additional EUT Data

Manufactured by	SPEAG
Manufactured on	June 23, 2016

DASY5 Validation Report for Head TSL

Date: 19.09.2016

Test Laboratory: SPEAG, Zurich, Switzerland

DUT: D750V3 - SN1163; Type: D750V3; Serial: SN1163

Communication System: UID 0 - CW; Frequency: 750 MHz

Medium parameters used: $f = 750 \text{ MHz}$; $\sigma = 0.91 \text{ S/m}$; $\epsilon_r = 41$; $\rho = 1000 \text{ kg/m}^3$

Phantom section: Flat Section

Measurement Standard: DASY5 (IEEE/IEC/ANSI C63.19-2011)

DASY52 Configuration:

- Probe: EX3DV4 - SN7349; ConvF(10.07, 10.07, 10.07); Calibrated: 15.06.2016;
- Sensor-Surface: 1.4mm (Mechanical Surface Detection)
- Electronics: DAE4 Sn601; Calibrated: 30.12.2015
- Phantom: Flat Phantom 4.9L; Type: QD000P49AA; Serial: 1001
- DASY52 52.8.8(1258); SEMCAD X 14.6.10(7372)

Dipole Calibration for Head Tissue/Pin=250 mW, d=15mm/Zoom Scan (7x7x7)/Cube 0:

Measurement grid: $dx=5\text{mm}$, $dy=5\text{mm}$, $dz=5\text{mm}$

Reference Value = 58.31 V/m; Power Drift = 0.01 dB

Peak SAR (extrapolated) = 3.16 W/kg

SAR(1 g) = 2.11 W/kg; SAR(10 g) = 1.38 W/kg

Maximum value of SAR (measured) = 2.79 W/kg

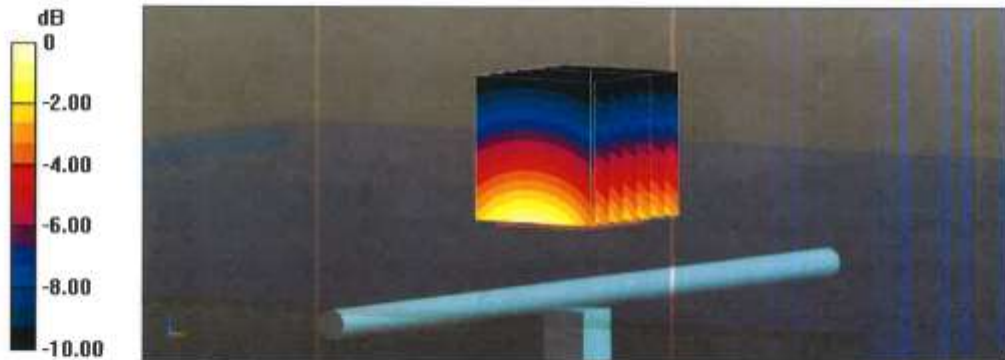

0 dB = 2.79 W/kg = 4.46 dBW/kg

Impedance Measurement Plot for Head TSL

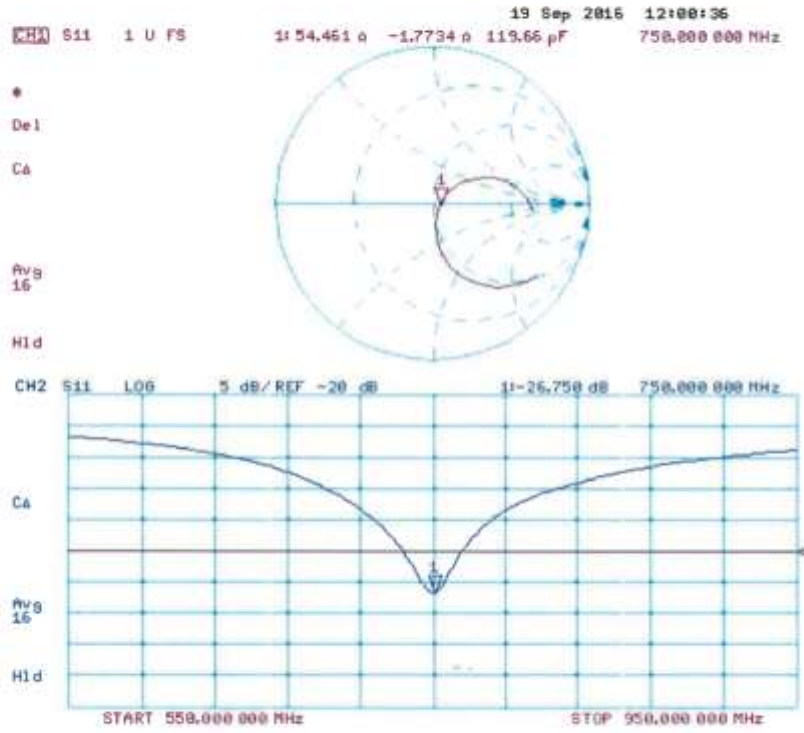

DASY5 Validation Report for Body TSL

Date: 19.09.2016

Test Laboratory: SPEAG, Zurich, Switzerland

DUT: D750V3 - SN1163; Type: D750V3; Serial: SN1163

Communication System: UID 0 - CW; Frequency: 750 MHz

Medium parameters used: $f = 750$ MHz; $\sigma = 0.99$ S/m; $\epsilon_r = 54.9$; $\rho = 1000$ kg/m³

Phantom section: Flat Section

Measurement Standard: DASY5 (IEEE/IEC/ANSI C63.19-2011)

DASY52 Configuration:

- Probe: EX3DV4 - SN7349; ConvF(9.99, 9.99, 9.99); Calibrated: 15.06.2016;
- Sensor-Surface: 1.4mm (Mechanical Surface Detection)
- Electronics: DAE4 Sn601; Calibrated: 30.12.2015
- Phantom: Flat Phantom 4.9L; Type: QD000P49AA; Serial: 1001
- DASY52 52.8.8(1258); SEMCAD X 14.6.10(7372)

Dipole Calibration for Body Tissue/Pin=250 mW, d=15mm/Zoom Scan (7x7x7)/Cube 0:

Measurement grid: dx=5mm, dy=5mm, dz=5mm

Reference Value = 57.12 V/m; Power Drift = -0.00 dB

Peak SAR (extrapolated) = 3.33 W/kg

SAR(1 g) = 2.2 W/kg; SAR(10 g) = 1.44 W/kg

Maximum value of SAR (measured) = 2.94 W/kg

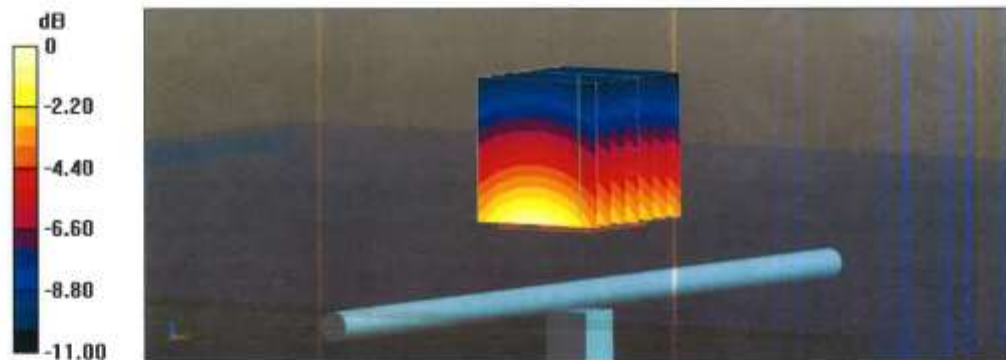

0 dB = 2.94 W/kg = 4.68 dBW/kg

Impedance Measurement Plot for Body TSL

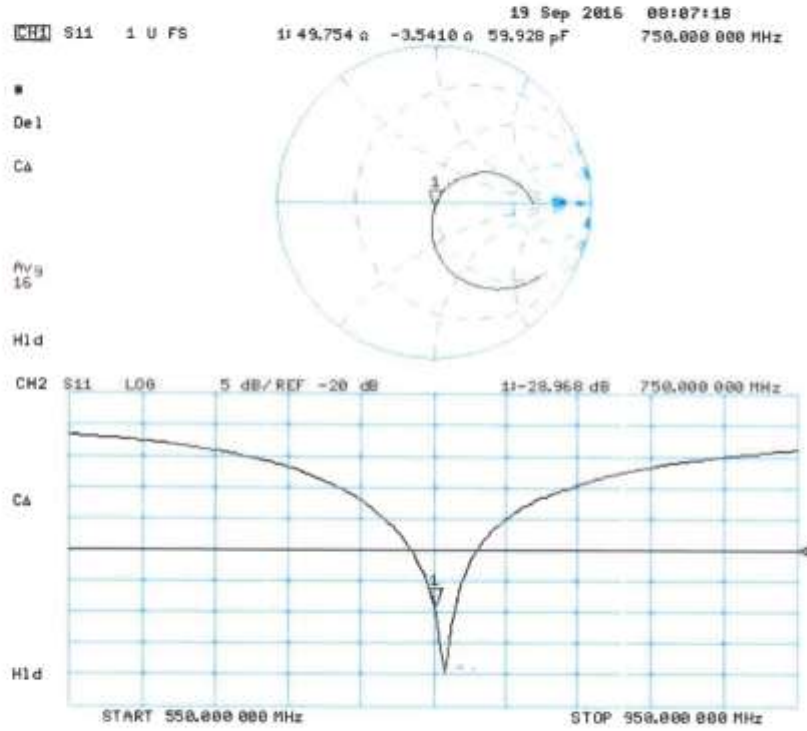

750 MHz Dipole Calibration Certificate -2019



Client **CTTL(South Branch)** Certificate No: **Z19-60291**

CALIBRATION CERTIFICATE			
Object:	D750V3 - SN: 1163		
Calibration Procedure(s)	FF-Z11-003-01 Calibration Procedures for dipole validation kits		
Calibration date:	September 3, 2019		
<p>This calibration Certificate documents the traceability to national standards, which realize the physical units of measurements(SI). The measurements and the uncertainties with confidence probability are given on the following pages and are part of the certificate.</p> <p>All calibrations have been conducted in the closed laboratory facility; environment temperature(22±3)℃ and humidity<70%.</p> <p>Calibration Equipment used (M&TE critical for calibration)</p>			
Primary Standards	ID #	Cal Date(Calibrated by, Certificate No.)	Scheduled Calibration
Power Meter NRP2	106276	11-Apr-19 (CTTL, No.J19X02605)	Apr-20
Power sensor NRP6A	101369	11-Apr-19 (CTTL, No.J19X02605)	Apr-20
Reference Probe EX3DV4	SN 3617	31-Jan-19(SPEAG, No. EX3-3617_Jan19)	Jan-20
DAE4	SN 1555	22-Aug-19(CTTL-SPEAG, No. Z19-60295)	Aug-20
Secondary Standards	ID #	Cal Date(Calibrated by, Certificate No.)	Scheduled Calibration
Signal Generator E4438C	MY49071430	23-Jan-19 (CTTL, No.J19X00336)	Jan-20
NetworkAnalyzer E5071C	MY46110673	24-Jan-19 (CTTL, No.J19X00547)	Jan-20
Calibrated by:	Name	Function	Signature
	Zhao Jing	SAR Test Engineer	
Reviewed by:	Lin Hao	SAR Test Engineer	
Approved by:	Qi Dianyuan	SAR Project Leader	
Issued: September 6, 2019			
This calibration certificate shall not be reproduced except in full without written approval of the laboratory.			



Add: No.51 Xueyuan Road, Haidian District, Beijing, 100191, China
Tel: +86-10-62304633-2079 Fax: +86-10-62304633-2504
E-mail: ctt@chinartl.com http://www.chinartl.cn

Glossary:

TSL	tissue simulating liquid
ConvF	sensitivity in TSL / NORM _{x,y,z}
N/A	not applicable or not measured

Calibration is Performed According to the Following Standards:

- IEEE Std 1528-2013, "IEEE Recommended Practice for Determining the Peak Spatial-Averaged Specific Absorption Rate (SAR) in the Human Head from Wireless Communications Devices: Measurement Techniques", June 2013
- IEC 62209-1, "Measurement procedure for assessment of specific absorption rate of human exposure to radio frequency fields from hand-held and body-mounted wireless communication devices- Part 1: Device used next to the ear (Frequency range of 300MHz to 6GHz)", July 2016
- IEC 62209-2, "Procedure to measure the Specific Absorption Rate (SAR) For wireless communication devices used in close proximity to the human body (frequency range of 30MHz to 6GHz)", March 2010
- KDB865664, SAR Measurement Requirements for 100 MHz to 6 GHz

Additional Documentation:

- DASY4/5 System Handbook

Methods Applied and Interpretation of Parameters:

- Measurement Conditions:** Further details are available from the Validation Report at the end of the certificate. All figures stated in the certificate are valid at the frequency indicated.
- Antenna Parameters with TSL:** The dipole is mounted with the spacer to position its feed point exactly below the center marking of the flat phantom section, with the arms oriented parallel to the body axis.
- Feed Point Impedance and Return Loss:** These parameters are measured with the dipole positioned under the liquid filled phantom. The impedance stated is transformed from the measurement at the SMA connector to the feed point. The Return Loss ensures low reflected power. No uncertainty required.
- Electrical Delay:** One-way delay between the SMA connector and the antenna feed point. No uncertainty required.
- SAR measured:** SAR measured at the stated antenna input power.
- SAR normalized:** SAR as measured, normalized to an input power of 1 W at the antenna connector.
- SAR for nominal TSL parameters:** The measured TSL parameters are used to calculate the nominal SAR result.

The reported uncertainty of measurement is stated as the standard uncertainty of Measurement multiplied by the coverage factor $k=2$, which for a normal distribution Corresponds to a coverage probability of approximately 95%.



Add: No.51 Xueyuan Road, Haidian District, Beijing, 100191, China
Tel: +86-10-62304633-2079 Fax: +86-10-62304633-2504
E-mail: ttl@chinattl.com http://www.chinattl.cn

Measurement Conditions

DASY system configuration, as far as not given on page 1.

DASY Version	DASY52	V52.10.2
Extrapolation	Advanced Extrapolation	
Phantom	Triple Flat Phantom 5.1C	
Distance Dipole Center - TSL	15 mm	with Spacer
Zoom Scan Resolution	dx, dy, dz = 5 mm	
Frequency	750 MHz \pm 1 MHz	

Head TSL parameters

The following parameters and calculations were applied.

	Temperature	Permittivity	Conductivity
Nominal Head TSL parameters	22.0 °C	41.9	0.89 mho/m
Measured Head TSL parameters	(22.0 \pm 0.2) °C	41.6 \pm 6 %	0.90 mho/m \pm 6 %
Head TSL temperature change during test	<1.0 °C	---	---

SAR result with Head TSL

SAR averaged over 1 cm^3 (1 g) of Head TSL	Condition	
SAR measured	250 mW input power	2.16 W/kg
SAR for nominal Head TSL parameters	normalized to 1W	8.53 W/kg \pm 18.8 % (k=2)
SAR averaged over 10 cm^3 (10 g) of Head TSL	Condition	
SAR measured	250 mW input power	1.44 W/kg
SAR for nominal Head TSL parameters	normalized to 1W	5.70 W/kg \pm 18.7 % (k=2)

Body TSL parameters

The following parameters and calculations were applied.

	Temperature	Permittivity	Conductivity
Nominal Body TSL parameters	22.0 °C	55.5	0.96 mho/m
Measured Body TSL parameters	(22.0 \pm 0.2) °C	55.9 \pm 6 %	0.94 mho/m \pm 6 %
Body TSL temperature change during test	<1.0 °C	---	---

SAR result with Body TSL

SAR averaged over 1 cm^3 (1 g) of Body TSL	Condition	
SAR measured	250 mW input power	2.16 W/kg
SAR for nominal Body TSL parameters	normalized to 1W	8.78 W/kg \pm 18.8 % (k=2)
SAR averaged over 10 cm^3 (10 g) of Body TSL	Condition	
SAR measured	250 mW input power	1.45 W/kg
SAR for nominal Body TSL parameters	normalized to 1W	5.87 W/kg \pm 18.7 % (k=2)



Add: No.51 Xueyuan Road, Haidian District, Beijing, 100191, China
Tel: +86-10-62304633-2079 Fax: +86-10-62304633-2504
E-mail: cttl@chinattl.com <http://www.chinattl.cn>

Appendix (Additional assessments outside the scope of CNAS L0570)

Antenna Parameters with Head TSL

Impedance, transformed to feed point	50.5Ω- 4.53jΩ
Return Loss	- 26.9dB

Antenna Parameters with Body TSL

Impedance, transformed to feed point	48.5Ω- 3.38jΩ
Return Loss	- 28.5dB

General Antenna Parameters and Design

Electrical Delay (one direction)	0.900 ns
----------------------------------	----------

After long term use with 100W radiated power, only a slight warming of the dipole near the feedpoint can be measured.

The dipole is made of standard semirigid coaxial cable. The center conductor of the feeding line is directly connected to the second arm of the dipole. The antenna is therefore short-circuited for DC-signals. On some of the dipoles, small end caps are added to the dipole arms in order to improve matching when loaded according to the position as explained in the "Measurement Conditions" paragraph. The SAR data are not affected by this change. The overall dipole length is still according to the Standard. No excessive force must be applied to the dipole arms, because they might bend or the soldered connections near the feedpoint may be damaged.

Additional EUT Data

Manufactured by	SPEAG
-----------------	-------



Add: No.51 Xueyuan Road, Haidian District, Beijing, 100191, China
Tel: +86-10-62304633-2079 Fax: +86-10-62304633-2504
E-mail: cttl@chinattl.com <http://www.chinattl.cn>

DASY5 Validation Report for Head TSL

Date: 09.03.2019

Test Laboratory: CTTL, Beijing, China

DUT: Dipole 750 MHz; Type: D750V3; Serial: D750V3 - SN: 1163

Communication System: UID 0, CW; Frequency: 750 MHz; Duty Cycle: 1:1

Medium parameters used: $f = 750$ MHz; $\sigma = 0.904$ S/m; $\epsilon_r = 41.62$; $\rho = 1000$ kg/m³

Phantom section: Right Section

DASY5 Configuration:

- Probe: EX3DV4 - SN3617; ConvF(10.03, 10.03, 10.03) @ 750 MHz; Calibrated: 1/31/2019
- Sensor-Surface: 1.4mm (Mechanical Surface Detection)
- Electronics: DAE4 Sn1555; Calibrated: 8/22/2019
- Phantom: MFP_V5.1C ; Type: QD 000 P51CA; Serial: 1062
- Measurement SW: DASY52, Version 52.10 (2); SEMCAD X Version 14.6.12 (7470)

Dipole Calibration/Zoom Scan (7x7x7) (7x7x7)/Cube 0: Measurement grid: dx=5mm, dy=5mm, dz=5mm

Reference Value = 55.16 V/m; Power Drift = -0.02 dB

Peak SAR (extrapolated) = 3.11 W/kg

SAR(1 g) = 2.16 W/kg; SAR(10 g) = 1.44 W/kg

Maximum value of SAR (measured) = 2.81 W/kg

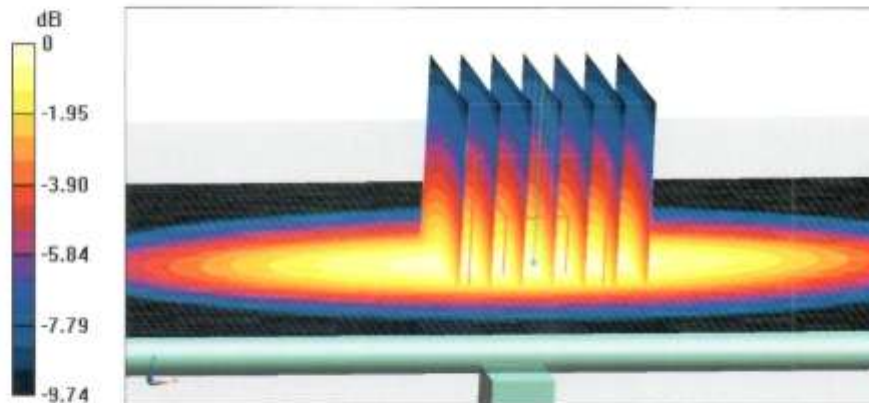

0 dB = 2.81 W/kg = 4.49 dBW/kg



Add: No.51 Xueyuan Road, Haidian District, Beijing, 100191, China
Tel: +86-10-62304633-2079 Fax: +86-10-62304633-2504
E-mail: ctl@chinattl.com <http://www.chinattl.cn>

Impedance Measurement Plot for Head TSL

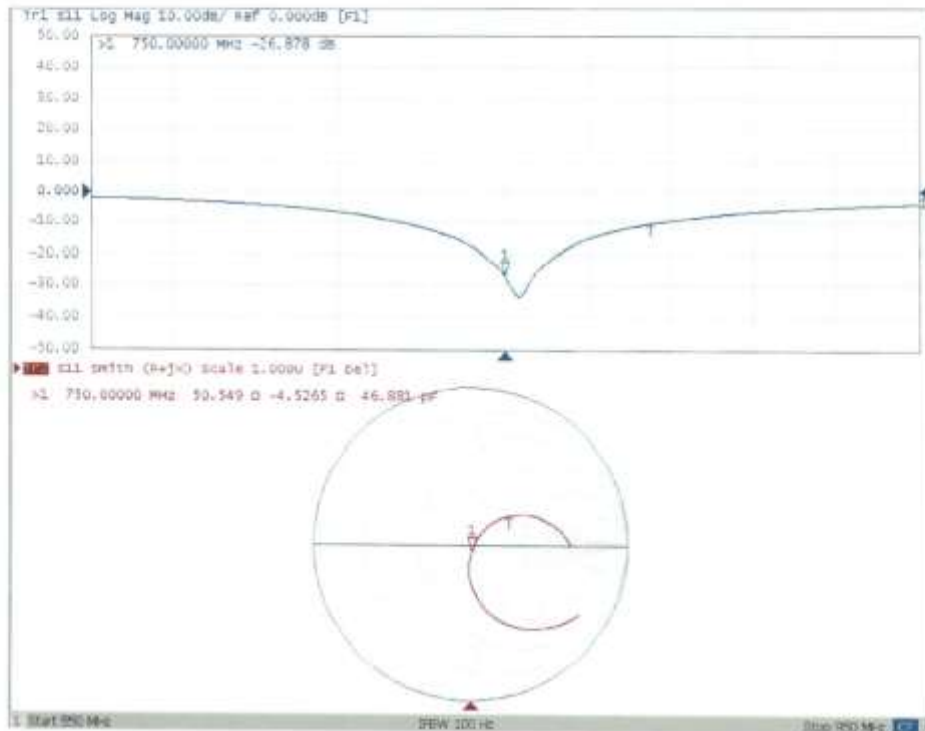



Add: No.51 Xueyuan Road, Haidian District, Beijing, 100191, China
Tel: +86-10-62304633-2079 Fax: +86-10-62304633-2504
E-mail: cttl@chinattl.com http://www.chinattl.cn

DASY5 Validation Report for Body TSL

Date: 09.03.2019

Test Laboratory: CTTL, Beijing, China

DUT: Dipole 750 MHz; Type: D750V3; Serial: D750V3 - SN: 1163

Communication System: UID 0, CW; Frequency: 750 MHz; Duty Cycle: 1:1

Medium parameters used: $f = 750$ MHz; $\sigma = 0.942$ S/m; $\epsilon_r = 55.87$; $\rho = 1000$ kg/m³

Phantom section: Center Section

DASY5 Configuration:

- Probe: EX3DV4 - SN3617; ConvF(9.85, 9.85, 9.85) @ 750 MHz; Calibrated: 1/31/2019
- Sensor-Surface: 1.4mm (Mechanical Surface Detection)
- Electronics: DAE4 Sn1555; Calibrated: 8/22/2019
- Phantom: MFP_V5.1C ; Type: QD 000 P51CA; Serial: 1062
- Measurement SW: DASY52, Version 52.10 (2); SEMCAD X Version 14.6.12 (7470)

Dipole Calibration/Zoom Scan (7x7x7) (7x7x7)/Cube 0: Measurement grid: dx=5mm, dy=5mm, dz=5mm

Reference Value = 52.88 V/m; Power Drift = 0.03 dB

Peak SAR (extrapolated) = 3.20 W/kg

SAR(1 g) = 2.16 W/kg; SAR(10 g) = 1.45 W/kg

Maximum value of SAR (measured) = 2.85 W/kg

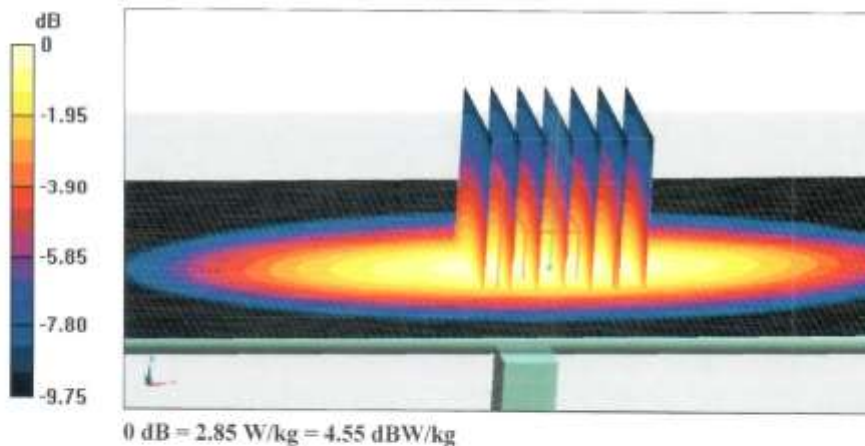



Add: No.51 Xueyuan Road, Haidian District, Beijing, 100191, China
Tel: +86-10-62304633-2079 Fax: +86-10-62304633-2504
E-mail: cml@chinantl.com http://www.chinantl.cn

Impedance Measurement Plot for Body TSL

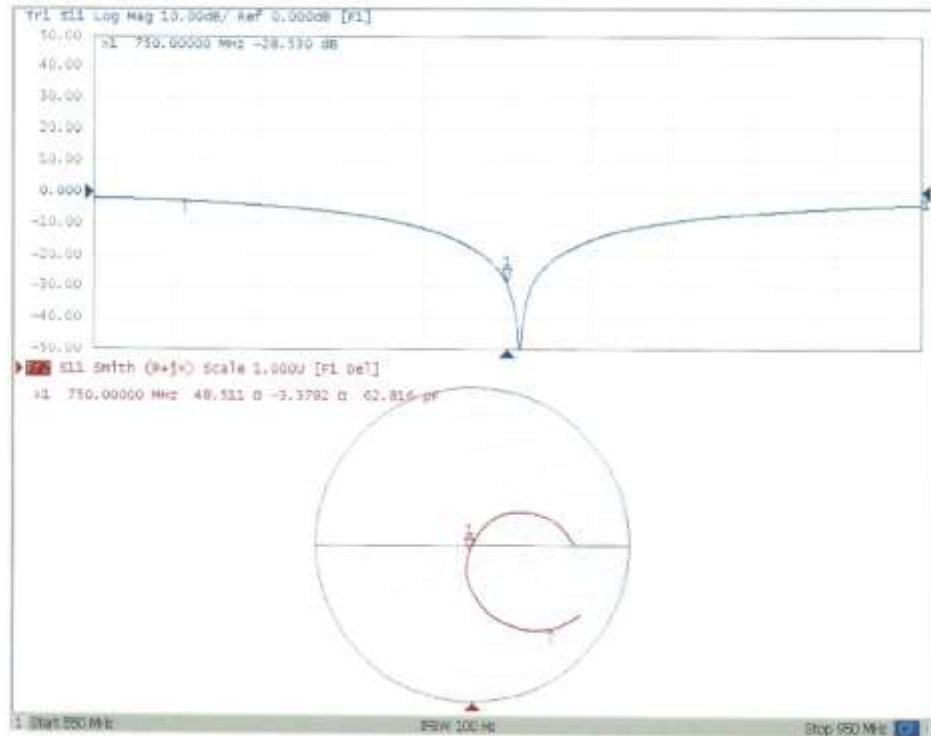

835 MHz Dipole Calibration Certificate



In Collaboration with
s p e a g
CALIBRATION LABORATORY

Add: No.51 Xueyuan Road, Haidian District, Beijing, 100191, China
Tel: +86-10-62304633-2079 Fax: +86-10-62304633-2504
E-mail: cntl@chinattl.com http://www.chinattl.cn



中国认可
国际互认
校准
CALIBRATION
CNAS LD570

Client **CTTL(South Branch)**

Certificate No: **Z18-60385**

CALIBRATION CERTIFICATE			
Object	D835V2 - SN: 4d057		
Calibration Procedure(s)	FF-Z11-003-01 Calibration Procedures for dipole validation kits		
Calibration date:	October 9, 2018		
<p>This calibration Certificate documents the traceability to national standards, which realize the physical units of measurements(SI). The measurements and the uncertainties with confidence probability are given on the following pages and are part of the certificate.</p> <p>All calibrations have been conducted in the closed laboratory facility: environment temperature(22±3)°C and humidity<70%.</p> <p>Calibration Equipment used (M&TE critical for calibration)</p>			
Primary Standards	ID #	Cal Date(Calibrated by, Certificate No.)	Scheduled Calibration
Power Meter NRVD	102083	01-Nov-17 (CTTL, No.J17X08756)	Oct-18
Power sensor NRV-Z5	100542	01-Nov-17 (CTTL, No.J17X08756)	Oct-18
Reference Probe EX3DV4 DAE4	SN 7514	27-Aug-18(SPEAG,No.EX3-7514_Aug18)	Aug-19
	SN 1555	20-Aug-18(SPEAG,No.DAE4-1555_Aug18)	Aug-19
Secondary Standards	ID #	Cal Date(Calibrated by, Certificate No.)	Scheduled Calibration
Signal Generator E4438C	MY49071430	23-Jan-18 (CTTL, No.J18X00560)	Jan-19
NetworkAnalyzer E5071C	MY46110673	24-Jan-18 (CTTL, No.J18X00561)	Jan-19
Calibrated by:	Name Zhao Jing	Function SAR Test Engineer	Signature
Reviewed by:	Name Lin Hao	Function SAR Test Engineer	Signature
Approved by:	Name Qi Dianyuan	Function SAR Project Leader	Signature
Issued: October 11, 2018			
This calibration certificate shall not be reproduced except in full without written approval of the laboratory.			



Add: No.51 Xueyuan Road, Haidian District, Beijing, 100191, China
Tel: +86-10-62304633-2079 Fax: +86-10-62304633-2504
E-mail: ctf@chinattl.com http://www.chinattl.cn

Glossary:

TSL	tissue simulating liquid
ConvF	sensitivity in TSL / NORM _{x,y,z}
N/A	not applicable or not measured

Calibration is Performed According to the Following Standards:

- IEEE Std 1528-2013, "IEEE Recommended Practice for Determining the Peak Spatial-Averaged Specific Absorption Rate (SAR) in the Human Head from Wireless Communications Devices: Measurement Techniques", June 2013
- IEC 62209-1, "Measurement procedure for assessment of specific absorption rate of human exposure to radio frequency fields from hand-held and body-mounted wireless communication devices- Part 1: Device used next to the ear (Frequency range of 300MHz to 6GHz)", July 2016
- IEC 62209-2, "Procedure to measure the Specific Absorption Rate (SAR) For wireless communication devices used in close proximity to the human body (frequency range of 30MHz to 6GHz)", March 2010
- KDB865664, SAR Measurement Requirements for 100 MHz to 6 GHz

Additional Documentation:

- DASY4/5 System Handbook

Methods Applied and Interpretation of Parameters:

- Measurement Conditions:** Further details are available from the Validation Report at the end of the certificate. All figures stated in the certificate are valid at the frequency indicated.
- Antenna Parameters with TSL:** The dipole is mounted with the spacer to position its feed point exactly below the center marking of the flat phantom section, with the arms oriented parallel to the body axis.
- Feed Point Impedance and Return Loss:** These parameters are measured with the dipole positioned under the liquid filled phantom. The impedance stated is transformed from the measurement at the SMA connector to the feed point. The Return Loss ensures low reflected power. No uncertainty required.
- Electrical Delay:** One-way delay between the SMA connector and the antenna feed point. No uncertainty required.
- SAR measured:** SAR measured at the stated antenna input power.
- SAR normalized:** SAR as measured, normalized to an input power of 1 W at the antenna connector.
- SAR for nominal TSL parameters:** The measured TSL parameters are used to calculate the nominal SAR result.

The reported uncertainty of measurement is stated as the standard uncertainty of Measurement multiplied by the coverage factor $k=2$, which for a normal distribution Corresponds to a coverage probability of approximately 95%.