



TEST REPORT

No.I19N00846-HAC RF

For

Yulong Computer Telecommunication Scientific (Shenzhen) Co., Ltd

Smartphone

Model Name: cp3648A

With

Hardware Version: P1

Software Version: 9.0.002.P1.190609.cp3648A

FCC ID: R38YLCP3648A

Results Summary: M Category = M4

Issued Date: 2019-07-05

Designation Number: CN1210

Note:

The test results in this test report relate only to the devices specified in this report. This report shall not be reproduced except in full without the written approval of SAICT.

Test Laboratory:

Shenzhen Academy of Information and Communications Technology

Building G, Shenzhen International Innovation Center, No.1006 Shennan Road, Futian District, Shenzhen,

Guangdong, P. R. China 518026.

Tel: +86(0)755-33322000, Fax: +86(0)755-33322001

Email: yewu@caict.ac.cn, website: www.cszit.com

REPORT HISTORY

| Report Number | Revision | Issue Date | Description |
|----------------------|-----------------|-------------------|---------------------------------|
| I19N00846-HAC RF | Rev.0 | 2019-07-05 | Initial creation of test report |

TABLE OF CONTENT

| | |
|--|-----------|
| 1 TEST LABORATORY | 4 |
| 1.1 TESTING LOCATION | 4 |
| 1.2 TESTING ENVIRONMENT | 4 |
| 1.3 PROJECT DATA | 4 |
| 1.4 SIGNATURE | 4 |
| 2 CLIENT INFORMATION | 5 |
| 2.1 APPLICANT INFORMATION | 5 |
| 2.2 MANUFACTURER INFORMATION | 5 |
| 3 EQUIPMENT UNDER TEST (EUT) AND ANCILLARY EQUIPMENT (AE) | 6 |
| 3.1 ABOUT EUT | 6 |
| 3.2 INTERNAL IDENTIFICATION OF EUT USED DURING THE TEST | 6 |
| 3.3 INTERNAL IDENTIFICATION OF AE USED DURING THE TEST | 6 |
| 3.4 AIR INTERFACES / BANDS INDICATING OPERATING MODES | 6 |
| 4. REFERENCE DOCUMENTS | 7 |
| 5 OPERATIONAL CONDITIONS DURING TEST | 8 |
| 5.1 HAC MEASUREMENT SET-UP | 8 |
| 5.2 PROBE SPECIFICATION | 9 |
| 5.3 TEST ARCH PHANTOM & PHONE POSITIONER | 10 |
| 4.4 ROBOTIC SYSTEM SPECIFICATIONS | 10 |
| 6 EUT ARRANGEMENT | 11 |
| 6.1 WD RF EMISSION MEASUREMENTS REFERENCE AND PLANE | 11 |
| 7 SYSTEM VALIDATION | 12 |
| 7.1 VALIDATION PROCEDURE | 12 |
| 7.2 VALIDATION RESULT | 12 |
| 8 MODULATION INTERFERENCE FACTOR (MIF) | 13 |
| 9 EVALUATION FOR LOW-POWER EXEMPTION | 15 |
| 9.1 PRODUCT TESTING THRESHOLD | 15 |
| 9.2 CONDUCTED POWER | 16 |
| 10 RF TEST PROCEDURES | 17 |
| 11 MEASUREMENT RESULTS (E-FIELD) | 18 |
| 12 ANSI C 63.19-2011 LIMITS | 19 |
| 13 MEASUREMENT UNCERTAINTY | 20 |
| 14 MAIN TEST INSTRUMENTS | 21 |
| ANNEX A RF EMISSION TEST PLOT | 22 |
| ANNEX B SYSTEM VALIDATION RESULT | 42 |
| ANNEX C PROBE CALIBRATION CERTIFICATE | 45 |
| ANNEX D DIPOLE CALIBRATION CERTIFICATE | 55 |
| ANNEX E UID SPECIFICATION | 70 |

1 Test Laboratory

1.1 Testing Location

| | |
|---------------|--|
| Company Name: | Shenzhen Academy of Information and Communications Technology |
| Address: | Building G, Shenzhen International Innovation Center, No.1006 Shennan Road, Futian District, Shenzhen, Guangdong, P. R. China |
| Postal Code: | 518026 |
| Telephone: | +86-755-33322000 |
| Fax: | +86-755-33322001 |

1.2 Testing Environment

| | |
|-----------------------------|--------------|
| Temperature: | 18°C ~ 25°C |
| Relative humidity: | 30% ~ 70% |
| Ground system resistance: | <4Ω |
| Ambient noise & Reflection: | < 0.012 W/kg |

1.3 Project Data

| | |
|---------------------|---------------|
| Testing Start Date: | June 09, 2019 |
| Testing End Date: | June 10, 2019 |

1.4 Signature



Li Yongfu

(Prepared this test report)



Zhang Yunzhan

(Reviewed this test report)



Cao Junfei

Deputy Director of the laboratory

(Approved this test report)

2 Client Information

2.1 Applicant Information

| | |
|----------------|--|
| Company Name: | Yulong Computer Telecommunication Scientific (Shenzhen) Co., Ltd |
| Address /Post: | Building B, Boton Science Park, Chaguang Road, Xili Town, Nanshan District, Shenzhen |
| Contact: | Yentl Chen |
| Email: | chenyanting@yulong.com |
| Telephone: | +86 15927320221 |
| Fax: | / |

2.2 Manufacturer Information

| | |
|----------------|--|
| Company Name: | Yulong Computer Telecommunication Scientific (Shenzhen) Co., Ltd |
| Address /Post: | Building B, Boton Science Park, Chaguang Road, Xili Town, Nanshan District, Shenzhen |
| Contact: | Yentl Chen |
| Email: | chenyanting@yulong.com |
| Telephone: | +86 15927320221 |
| Fax: | / |

3 Equipment under Test (EUT) and Ancillary Equipment (AE)

3.1 About EUT

| | |
|--------------------|--|
| Description: | Smartphone |
| Model name: | cp3648A |
| Operating mode(s): | GSM 850/1900, CDMA BC0/BC1/BC10, WCDMA Band 2/4/5 LTE Band 2/4/5/12/13/25/26/41/66/71, BT, Wi-Fi 2.4G |

3.2 Internal Identification of EUT used during the test

| EUT ID* | IMEI | HW Version | SW Version |
|---------|-----------------|------------|---------------------------|
| EUT1 | 990013500004564 | P1 | 9.0.002.P1.190609.cp3648A |
| EUT2 | 990013500004549 | P1 | 9.0.002.P1.190609.cp3648A |

*EUT ID: is used to identify the test sample in the lab internally.

Note: It is performed to test HAC with the EUT 1 & 2.

3.3 Internal Identification of AE used during the test

| AE ID* | Description | Type | Manufacturer |
|--------|-------------|----------------|-----------------|
| AE1 | Battery | Li-ion Polymer | Tianjin Lishen |
| AE2 | Battery | Li-ion Polymer | Zhuhai Coslight |

*AE ID: is used to identify the test sample in the lab internally.

3.4 Air Interfaces / Bands Indicating Operating Modes

| Air-interface | Band(MHz) | Type | C63.19 / tested | Simultaneous Transmissions | Name of Voice Service | Power Reduction |
|---------------|-----------------------------|------|-----------------|----------------------------|-----------------------|-----------------|
| GSM | 850 /1900 | VO | Yes | BT,WLAN | CMRS Voice | No |
| EDGE | 850 /1900 | DT | Yes | BT,WLAN | Google Duo | |
| WCDMA | B2 / B4/ B5 | VO | Yes | BT,WLAN | CMRS Voice | No |
| | HSPA | DT | Yes | BT,WLAN | Google Duo | |
| CDMA | BC0 / BC1 / BC10 | VO | Yes | BT,WLAN | CMRS Voice | No |
| | 1XRTT / EVDO | DT | Yes | BT,WLAN | Google Duo | |
| LTE (FDD) | 2/4/5/12/13/ 25/26/66/71 | DT | Yes | BT,WLAN | Google Duo | No |
| LTE (TDD) | 41 | DT | Yes | BT,WLAN | Google Duo | |
| WLAN | 2.4G | DT | Yes | WWAN | Google Duo | No |
| BT | 2.4G | DT | No | WWAN | NA | No |

VO: Voice CMRS/PSTN Service Only

VD: Voice CMRS/PSTN and Data Service

DT: Digital Transport

* HAC Rating was not based on concurrent voice and data modes; Non-current mode was found to represent worst case rating for both M and T rating

4. Reference Documents

The following document listed in this section is referred for testing.

| Reference | Title | Version |
|------------------|--|---------|
| ANSI C63.19-2011 | American National Standard for Methods of Measurement of Compatibility between Wireless Communication Devices and Hearing Aids | 2011 |
| KDB 285076 D01 | Equipment Authorization Guidance for Hearing Aid Compatibility | v05 |

5 Operational Conditions During Test

5.1 HAC Measurement Set-up

These measurements are performed using the DASY5 NEO automated dosimetric assessment system. It is made by Schmid & Partner Engineering AG (SPEAG) in Zurich, Switzerland. It consists of high precision robotics system (Stäubli), robot controller, Intel Core2 computer, near-field probe, probe alignment sensor. The robot is a six-axis industrial robot performing precise movements. A cell controller system contains the power supply, robot controller, teach pendant (Joystick), and remote control, is used to drive the robot motors. The PC consists of the HP Intel Core2 1.86 GHz computer with Windows XP system and HAC Measurement Software DASY5 NEO, A/D interface card, monitor, mouse, and keyboard. The Stäubli Robot is connected to the cell controller to allow software manipulation of the robot. A data acquisition electronic (DAE) circuit performs the signal amplification, signal multiplexing, AD-conversion, offset measurements, mechanical surface detection, collision detection, etc. is connected to the Electro-optical coupler (EOC). The EOC performs the conversion from the optical into digital electric signal of the DAE and transfers data to the PC plug-in card.

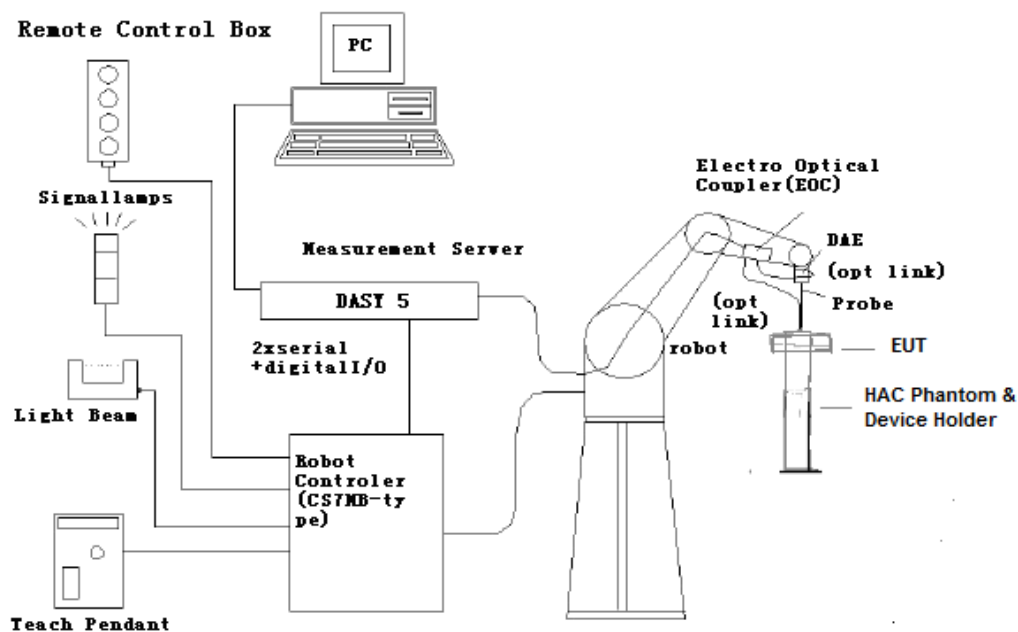

Fig. 1 HAC Test Measurement Set-up

The DAE4 consists of a highly sensitive electrometer-grade preamplifier with auto-zeroing, a channel and gain-switching multiplexer, a fast 16 bit AD-converter and a command decoder and control logic unit. Transmission to the PC-card is accomplished through an optical downlink for data and status information and an optical uplink for commands and clock lines. The mechanical probe mounting device includes two different sensor systems for frontal and sidewise probe contacts. They are also used for mechanical surface detection and probe collision detection. The robot uses its own controller with a built in VME-bus computer.

5.2 Probe Specification

E-Field Probe Description

| | |
|---------------|--|
| Construction | <p>One dipole parallel, two dipoles normal to probe axis</p> <p>Built-in shielding against static charges</p> <p>PEEK enclosure material</p> |
| Calibration | <p>In air from 100 MHz to 3.0 GHz (absolute accuracy $\pm 6.0\%$, $k=2$)</p> |
| Frequency | <p>40 MHz to > 6 GHz (can be extended to < 20 MHz)</p> <p>Linearity: ± 0.2 dB (100 MHz to 3 GHz)</p> |
| Directivity | <p>± 0.2 dB in air (rotation around probe axis)</p> <p>± 0.4 dB in air (rotation normal to probe axis)</p> |
| Dynamic Range | <p>2 V/m to > 1000 V/m; Linearity: ± 0.2 dB</p> |
| Dimensions | <p>Overall length: 330 mm (Tip: 16 mm)</p> <p>Tip diameter: 8 mm (Body: 12 mm)</p> <p>Distance from probe tip to dipole centers: 2.5 mm</p> |
| Application | <p>General near-field measurements up to 6 GHz</p> <p>Field component measurements</p> <p>Fast automatic scanning in phantoms</p> |

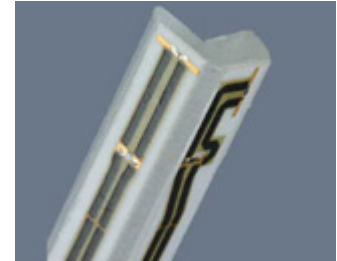

[ER3DV6]

5.3 Test Arch Phantom & Phone Positioner

The Test Arch phantom should be positioned horizontally on a stable surface. Reference markings on the Phantom allow the complete setup of all predefined phantom positions and measurement grids by manually teaching three points in the robot. It enables easy and well defined positioning of the phone and validation dipoles as well as simple teaching of the robot (Dimensions: 370 x 370 x 370 mm).

The Phone Positioner supports accurate and reliable positioning of any phone with effect on near field $<\pm 0.5$ dB.

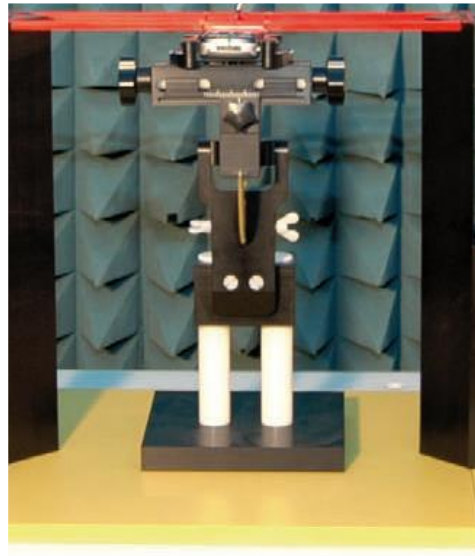

Fig. 2 HAC Phantom & Device Holder

4.4 Robotic System Specifications

Specifications

Positioner: Stäubli Unimation Corp. Robot Model: RX160XL

Repeatability: ± 0.02 mm

No. of Axis: 6

Data Acquisition Electronic (DAE) System

Cell Controller

Processor: Intel Core2

Clock Speed: 1.86 GHz

Operating System: Windows XP

Data Converter

Features: Signal Amplifier, multiplexer, A/D converter, and control logic

Software: DASY5 software

Connecting Lines: Optical downlink for data and status info.

Optical uplink for commands and clock

6 EUT Arrangement

6.1 WD RF Emission Measurements Reference and Plane

Figure 4 illustrates the references and reference plane that shall be used in the WD emissions measurement.

- The grid is 5 cm by 5 cm area that is divided into 9 evenly sized blocks or sub-grids.
- The grid is centered on the audio frequency output transducer of the WD (speaker or T-coil).
- The grid is located by reference to a reference plane. This reference plane is the planar area that contains the highest point in the area of the WD that normally rests against the user's ear
- The measurement plane is located parallel to the reference plane and 15 mm from it, out from the phone. The grid is located in the measurement plane.

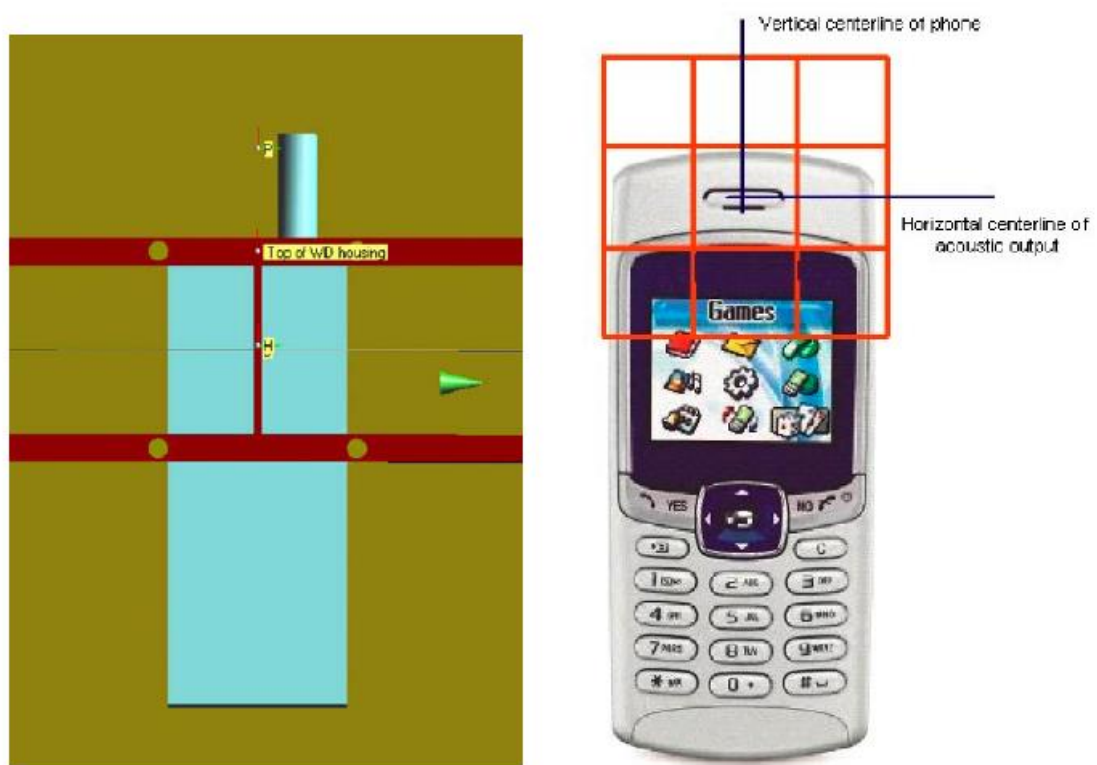

Fig. 3 WD reference and plane for RF emission measurements

7 System Validation

7.1 Validation Procedure

Place a dipole antenna meeting the requirements given in ANSI C63.19 in the position normally occupied by the WD. The dipole antenna serves as a known source for an electrical output. Position the E-field probes so that:

- The probes and their cables are parallel to the coaxial feed of the dipole antenna
- The probe cables and the coaxial feed of the dipole antenna approach the measurement area from opposite directions
- The center point of the probe element(s) are 15 mm from the closest surface of the dipole elements.

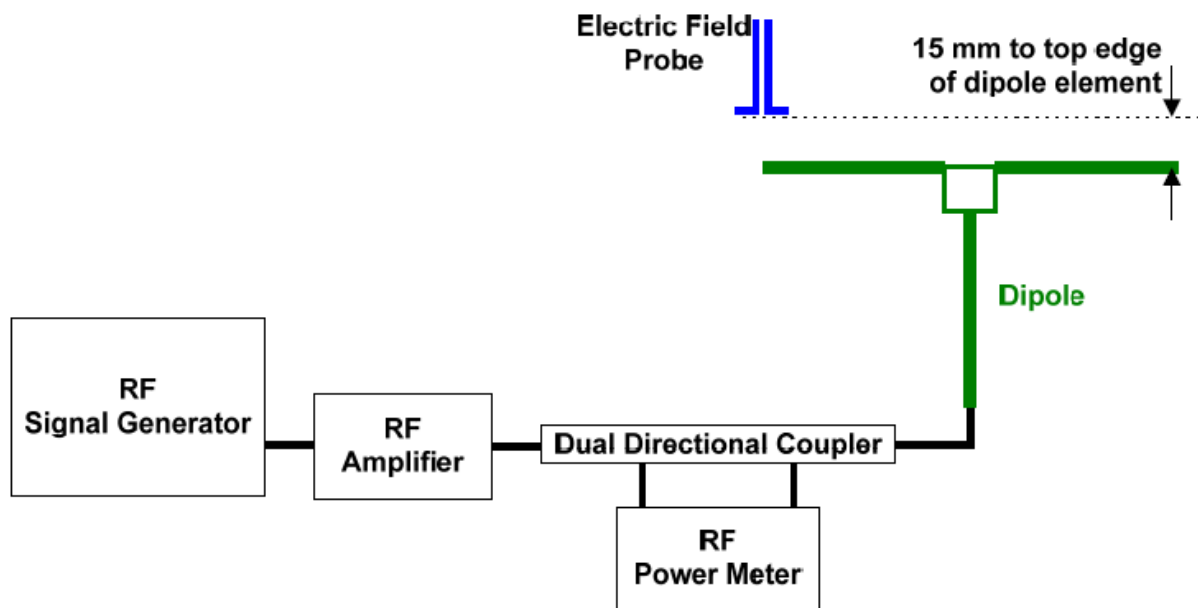

Fig. 4 Dipole Validation Setup

7.2 Validation Result

| E-Field Scan | | | | | | |
|--------------|-----------------|------------------|------------------------------------|----------------------------------|----------------------------|------------------------|
| Mode | Frequency (MHz) | Input Power (mW) | Measured ¹ Value(dBV/m) | Target ² Value(dBV/m) | Deviation ³ (%) | Limit ⁴ (%) |
| CW | 835 | 100 | 42.28 | 40.72 | 3.8 | ±25 |
| CW | 1880 | 100 | 39.64 | 39.06 | 1.5 | ±25 |
| CW | 2600 | 100 | 39.53 | 38.71 | 2.1 | ±25 |

Notes:

1. Please refer to the attachment for detailed measurement data and plot.
2. Target value is provided by SPEAD in the calibration certificate of specific dipoles.
3. Deviation (%) = 100 * (Measured value minus Target value) divided by Target value.
4. ANSI C63.19 requires values within ± 25% are acceptable, of which 12% is deviation and 13% is measurement uncertainty. Values independently validated for the dipole actually used in the measurements should be used, when available.

8 Modulation Interference Factor (MIF)

The HAC Standard ANSI C63.19-2011 defines a new scaling using the Modulation Interference Factor (MIF) which replaces the need for the Articulation Weighting Factor (AWF) during the evaluation and is applicable to any modulation scheme.

The Modulation Interference factor (MIF, in dB) is added to the measured average E-field (in dBV/m) and converts it to the RF Audio Interference level (in dBV/m). This level considers the audible amplitude modulation components in the RF E-field. CW fields without amplitude modulation are assumed to not interfere with the hearing aid electronics. Modulations without time slots and low fluctuations at low frequencies have low MIF values, TDMA modulations with narrow transmission and repetition rates of few 100 Hz have high MIF values and give similar classifications as ANSI C63-2007.

Definitions

ER3D, E-field probes have a bandwidth <10 kHz and can therefore not evaluate the RF envelope in the full audio band. DASY52 is therefore using the “indirect” measurement method according to ANSI C63.19-2011 which is the primary method. These near field probes read the averaged E-field measurement. Especially for the new high peak-to-average (PAR) signal types, the probes shall be linearized by probe modulation response (PMR) calibration in order to not overestimate the field reading.

The evaluation method or the MIF is defined in ANSI C63.19-2011 section D.7. An RMS demodulated RF signal is fed to a spectral filter (similar to an A weighting filter) and forwarded to a temporal filter acting as a quasi-peak detector. The averaged output of these filtering is called to a 1 kHz 80% AM signal as reference. MIF measurement requires additional instrumentation and is not well suited for evaluation by the end user with reasonable uncertainty. It may alternatively be determined through analysis and simulation, because it is constraint and characteristic for a communication signal. DASY52 uses well defined signals for PMR calibration. The MIF of these signals has been determined by simulation and is automatically applied.

MIF values were not tested by a probe or as specified in the standards but are based on analysis provided by SPEAG for all the air interfaces (GSM, WCDMA, CDMA, LTE). The data included in this report are for the worst case operating modes. The UIDs used are listed below:

| UID | Communication System Name | MIF (dB) |
|-------|---|----------|
| 10021 | GSM-FDD (TDMA, GMSK) | 3.63 |
| 10025 | EDGE-FDD (TDMA, 8PSK, TN 0) | 3.75 |
| 10011 | UMTS-FDD (WCDMA) | -27.23 |
| 10225 | UMTS-FDD (HSPA+) | -20.39 |
| 10295 | CDMA2000 (RC1, SO3, 1/8th Rate 25 fr.) | 3.26 |
| 10403 | CDMA2000 (1xEV-DO, Rev. 0) | -17.67 |
| 10170 | LTE-FDD(SC-FDMA, 1RB, 20MHz, 16-QAM) | -9.76 |
| 10176 | LTE-FDD(SC-FDMA, 1RB, 10MHz, 16-QAM) | -9.76 |
| 10173 | LTE-TDD (SC-FDMA, 1 RB, 20 MHz, 16QAM) | -1.44 |
| 10061 | IEEE 802.11b WiFi 2.4 GHz (DSSS, 11 Mbps) | -2.02 |

A PMR calibrated probe is linearized for the selected waveform over the full dynamic range within the uncertainty specified in its calibration certificate. ER3D, EF3D and EU2D E-field probes have a bandwidth <10 kHz and can therefore not evaluate the RF envelope in the full audio band. DASY52 is therefore using the "indirect" measurement method according to ANSI C63.19-2011 which is the primary method. These near field probes read the averaged E-field measurement. Especially for the new high peak-to-average (PAR) signal types, the probes shall be linearized by PMR calibration in order to not overestimate the field reading.

The MIF measurement uncertainty is estimated as follows, for modulation frequencies from slotted waveforms with fundamental frequency and at least 2 harmonics within 10 kHz:

- 0.2 dB for MIF -7 to +5 dB,
- 0.5 dB for MIF -13 to +11 dB
- 1 dB for MIF > -20 dB

9 Evaluation for low-power exemption

9.1 Product testing threshold

There are two methods for exempting an RF air interface technology from testing. The first method requires evaluation of the MIF for the worst-case operating mode. An RF air interface technology of a device is exempt from testing when its average antenna input power plus its MIF is ≤ 17 dBm for any of its operating modes. The second method does not require determination of the MIF. The RF emissions testing exemption shall be applied to an RF air interface technology in a device whose peak antenna input power, averaged over intervals $\leq 50 \mu\text{s}$, is ≤ 23 dBm. An RF air interface technology that is exempted from testing by either method shall be rated as M4.

The first method is used to be exempt from testing for the RF air interface technology in this report.

9.2 Conducted power

| Band | power (dBm) | MIF (dB) | Sum (dBm) | HAC Test |
|-----------------|-------------|----------|-----------|----------|
| GSM 850 | 34.5 | 3.63 | 38.13 | Yes |
| EGPRS 850 | 27.5 | 3.75 | 31.25 | Yes |
| GSM 1900 | 32.0 | 3.63 | 35.63 | Yes |
| EGPRS 1900 | 26.5 | 3.75 | 30.25 | Yes |
| CDMA BC0 | 24.5 | 3.26 | 27.76 | Yes |
| CDMA BC0 -EVDO | 24.5 | -17.67 | 6.83 | No |
| CDMA BC1 | 24.0 | 3.26 | 27.26 | Yes |
| CDMA BC1 -EVDO | 24.0 | -17.67 | 6.33 | No |
| CDMA BC10 | 24.5 | 3.26 | 27.76 | Yes |
| CDMA BC10 -EVDO | 24.5 | -17.67 | 6.83 | No |
| WCDMA B2 | 24.5 | -27.23 | -2.73 | No |
| WCDMA B2 -HSPA | 23.5 | -20.39 | 3.11 | No |
| WCDMA B4 | 24.5 | -27.23 | -2.73 | No |
| WCDMA B4 -HSPA | 23.5 | -20.39 | 3.11 | No |
| WCDMA B5 | 24.5 | -27.23 | -2.73 | No |
| WCDMA B5 -HSPA | 23.5 | -20.39 | 3.11 | No |
| LTE Band 2 | 23.5 | -9.76 | 13.74 | No |
| LTE Band 4 | 24.5 | -9.76 | 14.74 | No |
| LTE Band 5 | 24.0 | -9.76 | 14.24 | No |
| LTE Band 12 | 24.0 | -9.76 | 14.24 | No |
| LTE Band 13 | 24.0 | -9.76 | 14.24 | No |
| LTE Band 25 | 23.5 | -9.76 | 13.74 | No |
| LTE Band 26 | 24.0 | -9.76 | 14.24 | No |
| LTE Band 41 | 24.0 | -1.44 | 22.56 | Yes |
| LTE Band 66 | 24.5 | -9.76 | 14.74 | No |
| LTE Band 71 | 24.0 | -9.76 | 14.24 | No |
| WIFI 2.4G | 16.0 | -2.02 | 13.98 | No |

Note:

1. Power = Max turn-up limit.
2. EGPRS data modes are not necessary due the GSM Voice mode is the worst case.

10 RF Test Procedures

The evaluation was performed with the following procedure:

- 1) Confirm proper operation of the field probe, probe measurement system and other instrumentation and the positioning system.
- 2) Position the WD in its intended test position. The gauge block can simplify this positioning.
- 3) Configure the WD normal operation for maximum rated RF output power, at the desired channel and other operating parameters (e.g., test mode), as intended for the test.
- 4) The center sub-grid shall be centered on the center of the T-Coil mode axial measurement point or the acoustic output, as appropriate. Locate the field probe at the initial test position in the 50 mm by 50 mm grid, which is contained in the measurement plane. If the field alignment method is used, align the probe for maximum field reception.
- 5) Record the reading.
- 6) Scan the entire 50 mm by 50 mm region in equally spaced increments and record the reading at each measurement point. The distance between measurement points shall be sufficient to assure the identification of the maximum reading.
- 7) Identify the five contiguous sub-grids around the center sub-grid whose maximum reading is the lowest of all available choices. This eliminates the three sub-grids with the maximum readings. Thus, the six areas to be used to determine the WD's highest emissions are identified.
- 8) Identify the maximum field reading within the non-excluded sub-grids identified in Step 7)
- 9) Evaluate the MIF and add to the maximum steady-state rms field-strength reading to obtain the RF audio interference level..
- 10) Compare this RF audio interference level with the categories and record the resulting WD category rating.

11 Measurement Results (E-Field)

| Frequency | | Measured Value (dBV/m) | Power Drift (dB) | Category |
|--------------------|---------|---------------------------|---------------------|--------------------------|
| MHz | Channel | | | |
| GSM 850 | | | | |
| 848.8 | 251 | 27.48 | -0.03 | M4 (see Fig A.1) |
| 836.6 | 190 | 27.96 | -0.06 | M4 (see Fig A.2) |
| 824.2 | 128 | 27.75 | -0.04 | M4 (see Fig A.3) |
| GSM 1900 | | | | |
| 1909.8 | 810 | 18.71 | 0.02 | M4 (see Fig A.4) |
| 1880 | 661 | 18.93 | 0.08 | M4 (see Fig A.5) |
| 1850.2 | 512 | 19.48 | 0.03 | M4 (see Fig A.6) |
| CDMA BC0 | | | | |
| 848.31 | 777 | 26.02 | -0.01 | M4 (see Fig A.7) |
| 836.52 | 384 | 26.24 | -0.03 | M4 (see Fig A.8) |
| 824.70 | 1013 | 26.37 | -0.07 | M4 (see Fig A.9) |
| CDMA BC1 | | | | |
| 1908.75 | 1175 | 18.34 | 0.01 | M4 (see Fig A.10) |
| 1880 | 600 | 19.78 | 0.04 | M4 (see Fig A.11) |
| 1851.25 | 25 | 21.54 | 0.02 | M4 (see Fig A.12) |
| CDMA BC10 | | | | |
| 823.1 | 684 | 26.47 | -0.08 | M4 (see Fig A.13) |
| 820.5 | 580 | 28.34 | -0.03 | M4 (see Fig A.14) |
| 817.9 | 476 | 30.39 | -0.09 | M4 (see Fig A.15) |
| LTE Band 41 | | | | |
| 2680 | 41490 | 20.02 | 0.06 | M4 (see Fig A.16) |
| 2636.5 | 41055 | 19.99 | 0.08 | M4 (see Fig A.17) |
| 2593 | 40620 | 19.91 | 0.10 | M4 (see Fig A.18) |
| 2549.5 | 40185 | 19.80 | 0.05 | M4 (see Fig A.19) |
| 2506 | 39750 | 19.04 | 0.08 | M4 (see Fig A.20) |

12 ANSI C 63.19-2011 Limits

WD RF audio interference level categories in logarithmic units

| Emission categories | < 960 MHz | |
|----------------------------|--------------------------|----------|
| | E-field emissions | |
| Category M1 | 50 to 55 | dB (V/m) |
| Category M2 | 45 to 50 | dB (V/m) |
| Category M3 | 40 to 45 | dB (V/m) |
| Category M4 | < 40 | dB (V/m) |
| Emission categories | > 960 MHz | |
| | E-field emissions | |
| Category M1 | 40 to 45 | dB (V/m) |
| Category M2 | 35 to 40 | dB (V/m) |
| Category M3 | 30 to 35 | dB (V/m) |
| Category M4 | < 30 | dB (V/m) |

13 Measurement Uncertainty

| No. | Error source | Type | Uncertainty Value (%) | Prob. Dist. | k | c_i E | Standard Uncertainty (%) u_i (%) E | Degree of freedom V_{eff} OR ν_i | source |
|--|--------------------------------|--------------|-----------------------|-------------|------------|------------|---|--|--------------|
| 1 | System repeatability | A | 0.24 | N | 1 | 1 | 0.24 | 9 | Measurement |
| Measurement System | | | | | | | | | |
| 2 | Probe Calibration | B | 10.1 | N | 1 | 1 | 10.1 | ∞ | Manufacturer |
| 3 | Axial Isotropy | B | 0.5 | R | $\sqrt{3}$ | 1 | 0.5 | ∞ | Cal report |
| 4 | Sensor Displacement | B | 16.5 | R | $\sqrt{3}$ | 1 | 9.5 | ∞ | Manufacturer |
| 5 | Boundary Effects | B | 2.4 | R | $\sqrt{3}$ | 1 | 1.4 | ∞ | Manufacturer |
| 6 | Linearity | B | 0.6 | R | $\sqrt{3}$ | 1 | 0.35 | ∞ | Cal report |
| 7 | Scaling to Peak Envelope Power | B | 2.0 | R | $\sqrt{3}$ | 1 | 1.2 | ∞ | Standard |
| 8 | System Detection Limit | B | 1.0 | R | $\sqrt{3}$ | 1 | 0.6 | ∞ | Manufacturer |
| 9 | Readout Electronics | B | 0.3 | N | 1 | 1 | 0.3 | ∞ | Manufacturer |
| 10 | Response Time | B | 0.8 | R | $\sqrt{3}$ | 1 | 0.5 | ∞ | Manufacturer |
| 11 | Integration Time | B | 2.6 | R | $\sqrt{3}$ | 1 | 1.5 | ∞ | Manufacturer |
| 12 | RF Ambient Conditions | B | 3.0 | R | $\sqrt{3}$ | 1 | 1.7 | ∞ | Measurement |
| 13 | RF Reflections | B | 12.0 | R | $\sqrt{3}$ | 1 | 6.9 | ∞ | Measurement |
| 14 | Probe Positioner | A | 1.2 | R | $\sqrt{3}$ | 1 | 0.7 | ∞ | Manufacturer |
| 15 | Probe Positioning | A | 4.7 | R | $\sqrt{3}$ | 1 | 2.7 | ∞ | Manufacturer |
| 16 | Extra. And Interpolation | B | 1.0 | R | $\sqrt{3}$ | 1 | 0.6 | ∞ | Manufacturer |
| Test Sample Related | | | | | | | | | |
| 17 | Device Positioning Vertical | B | 4.7 | R | $\sqrt{3}$ | 1 | 2.7 | ∞ | Manufacturer |
| 18 | Device Positioning Lateral | B | 1.0 | R | $\sqrt{3}$ | 1 | 0.6 | ∞ | Manufacturer |
| 19 | Device Holder and Phantom | B | 2.4 | R | $\sqrt{3}$ | 1 | 1.4 | ∞ | Manufacturer |
| 20 | Power Drift | B | 5.0 | R | $\sqrt{3}$ | 1 | 2.9 | ∞ | Measurement |
| Phantom and Setup related | | | | | | | | | |
| 21 | Phantom Thickness | B | 2.4 | R | $\sqrt{3}$ | 1 | 1.4 | ∞ | Manufacturer |
| PMF related | | | | | | | | | |
| 22 | Monitor amplitude | B | 3.5 | R | $\sqrt{3}$ | 1 | 2.02 | ∞ | Manufacturer |
| 23 | Setup repeatability | A | 2.3 | N | 1 | 1 | 2.3 | 9 | Manufacturer |
| 24 | Sensor amplitude | B | 12 | R | $\sqrt{3}$ | 1 | 6.93 | ∞ | Manufacturer |
| Combined standard uncertainty(%) | | | | | | | 18.3 | | |
| Expanded uncertainty (confidence interval of 95 %) | | $u_e = 2u_c$ | | N | k=2 | | 36.6 | | |

14 Main Test Instruments

Table 14-1: List of Main Instruments

| No. | Name | Type | Serial Number | Calibration Date | Valid Period |
|-----|------------------|----------|---------------|------------------|--------------|
| 01 | Signal Generator | E8257D | MY47461211 | 2019-06-03 | One year |
| 02 | Power meter | E4418B | MY50000366 | 2018-12-14 | One year |
| 03 | Power sensor | E9304A | MY50000188 | | |
| 04 | Amplifier | VTL5400 | 0404 | / | |
| 05 | HAC Test Arch | N/A | 1150 | / | |
| 06 | DAE | DAE4 | 1527 | 2018-11-08 | One year |
| 07 | E-Field Probe | ER3DV6 | 2424 | 2018-02-23 | Three year |
| 08 | HAC Dipole | CD835V3 | 1165 | 2018-07-19 | Three year |
| 09 | HAC Dipole | CD1880V3 | 1149 | 2018-07-19 | Three year |
| 10 | HAC Dipole | CD2600V3 | 1020 | 2018-10-23 | Three year |
| 11 | BTS | CMU200 | 114544 | 2018-09-03 | One year |
| 12 | BTS | CMU500 | 152499 | 2018-07-19 | One year |

ANNEX A RF Emission Test Plot

HAC RF E-Field GSM 850 High

Date: 2019-6-10

Electronics: DAE4 Sn1527

Medium: Air

Medium parameters used: $\sigma = 0$ S/m, $\epsilon_r = 1$; $\rho = 1000$ kg/m³

Ambient Temperature: 22.0°C Liquid Temperature: 21.5°C

Communication System: UID 0, GSM Frequency: 848.8 MHz Duty Cycle: 1:8.3

Probe: ER3DV6 - SN2424 ConvF (1, 1, 1);

E Scan - ER3DV6 - 2011: 15 mm from Probe Center to the Device /Hearing Aid Compatibility Test (101x101x1): Interpolated grid: dx=0.5000 mm, dy=0.5000 mm

Device Reference Point: 0, 0, -6.3 mm

Reference Value = 18.52 V/m; Power Drift = -0.03 dB

Applied MIF = 3.63 dB

RF audio interference level = 27.48 dBV/m

Emission category: M4

MIF scaled E-field

| | | |
|---------------------------------|---------------------------------|---------------------------------|
| Grid 1 M4 25.52 dBV/m | Grid 2 M4 27.23 dBV/m | Grid 3 M4 27.23 dBV/m |
| Grid 4 M4 25.89 dBV/m | Grid 5 M4 27.48 dBV/m | Grid 6 M4 27.39 dBV/m |
| Grid 7 M4 26.65 dBV/m | Grid 8 M4 27.42 dBV/m | Grid 9 M4 27.39 dBV/m |

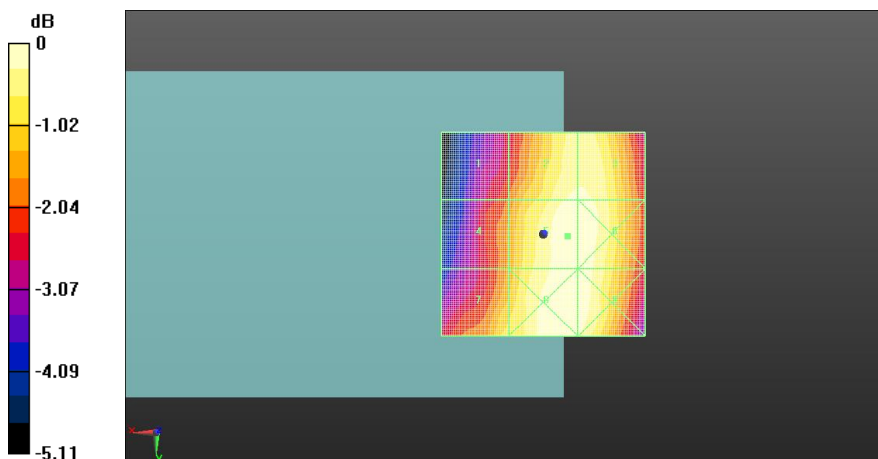

0 dB = 23.66 V/m = 27.48 dBV/m

Fig A.1 HAC RF E-Field GSM850

HAC RF E-Field GSM 850 Middle

Date: 2019-6-10

Electronics: DAE4 Sn1527

Medium: Air

Medium parameters used: $\sigma = 0$ S/m, $\epsilon_r = 1$; $\rho = 1000$ kg/m³

Ambient Temperature: 22.0°C Liquid Temperature: 21.5°C

Communication System: UID 0, GSM Frequency: 836.6 MHz Duty Cycle: 1:8.3

Probe: ER3DV6 - SN2424 ConvF (1, 1, 1);

E Scan - ER3DV6 - 2011: 15 mm from Probe Center to the Device /Hearing Aid Compatibility Test (101x101x1): Interpolated grid: dx=0.5000 mm, dy=0.5000 mm

Device Reference Point: 0, 0, -6.3 mm

Reference Value = 19.76 V/m; Power Drift = -0.06 dB

Applied MIF = 3.63 dB

RF audio interference level = 27.96 dBV/m

Emission category: M4

MIF scaled E-field

| | | |
|--|--|--|
| Grid 1 M4 26.17 dBV/m | Grid 2 M4 27.7 dBV/m | Grid 3 M4 27.7 dBV/m |
| Grid 4 M4 26.47 dBV/m | Grid 5 M4 27.96 dBV/m | Grid 6 M4 27.89 dBV/m |
| Grid 7 M4 27.18 dBV/m | Grid 8 M4 27.96 dBV/m | Grid 9 M4 27.89 dBV/m |

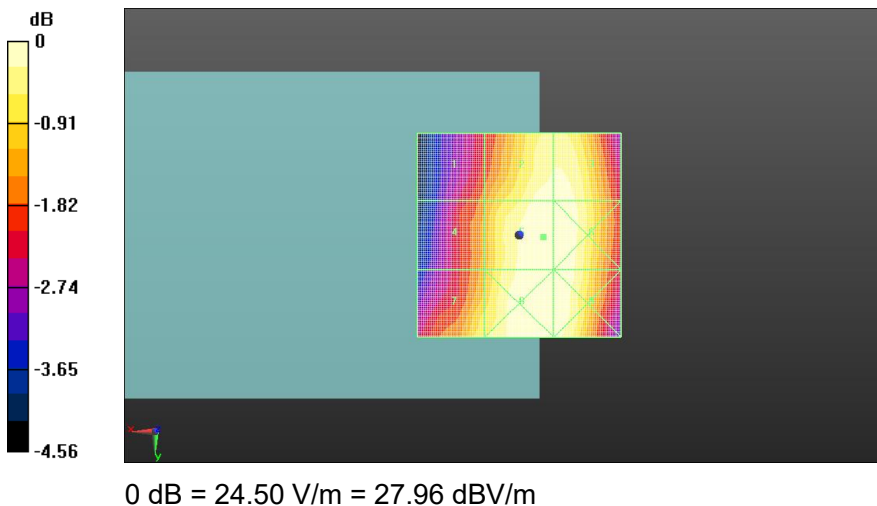

Fig A.2 HAC RF E-Field GSM850

HAC RF E-Field GSM 850 Low

Date: 2019-6-10

Electronics: DAE4 Sn1527

Medium: Air

Medium parameters used: $\sigma = 0$ S/m, $\epsilon_r = 1$; $\rho = 1000$ kg/m³

Ambient Temperature: 22.0°C Liquid Temperature: 21.5°C

Communication System: UID 0, GSM Frequency: 824.2 MHz Duty Cycle: 1:8.3

Probe: ER3DV6 - SN2424 ConvF (1, 1, 1);

E Scan - ER3DV6 - 2011: 15 mm from Probe Center to the Device /Hearing Aid Compatibility

Test (101x101x1): Interpolated grid: dx=0.5000 mm, dy=0.5000 mm

Device Reference Point: 0, 0, -6.3 mm

Reference Value = 19.26 V/m; Power Drift = -0.04 dB

Applied MIF = 3.63 dB

RF audio interference level = 27.75 dBV/m

Emission category: M4

MIF scaled E-field

| | | |
|--|--|--|
| Grid 1 M4 25.94 dBV/m | Grid 2 M4 27.58 dBV/m | Grid 3 M4 27.58 dBV/m |
| Grid 4 M4 26.27 dBV/m | Grid 5 M4 27.75 dBV/m | Grid 6 M4 27.71 dBV/m |
| Grid 7 M4 26.9 dBV/m | Grid 8 M4 27.7 dBV/m | Grid 9 M4 27.68 dBV/m |

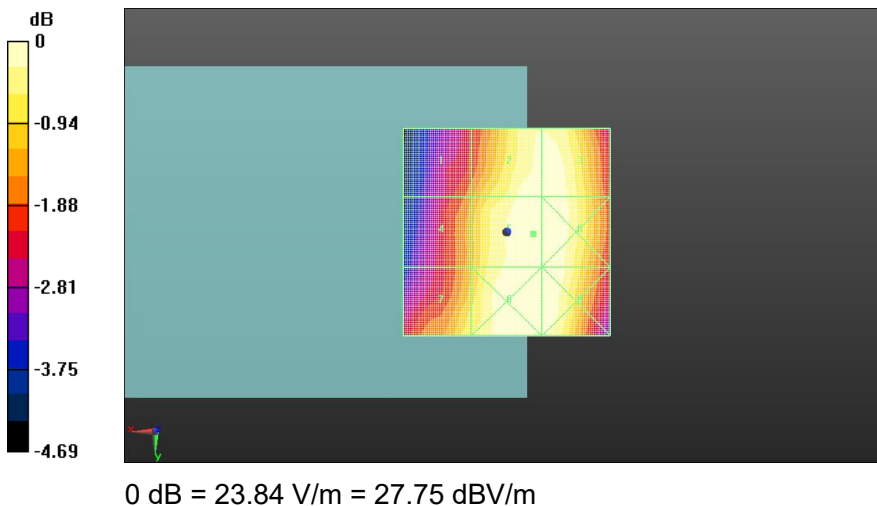

Fig A.3 HAC RF E-Field GSM850

HAC RF E-Field GSM 1900 High

Date: 2019-6-10

Electronics: DAE4 Sn1527

Medium: Air

Medium parameters used: $\sigma = 0$ S/m, $\epsilon_r = 1$; $\rho = 1000$ kg/m³

Ambient Temperature: 22.0°C Liquid Temperature: 21.5°C

Communication System: UID 0, GSM Frequency: 1910 MHz Duty Cycle: 1:8.3

Probe: ER3DV6 - SN2424 ConvF (1, 1, 1);

E Scan - ER3DV6 - 2011: 15 mm from Probe Center to the Device /Hearing Aid Compatibility Test (101x101x1): Interpolated grid: dx=0.5000 mm, dy=0.5000 mm

Device Reference Point: 0, 0, -6.3 mm

Reference Value = 4.559 V/m; Power Drift = 0.02 dB

Applied MIF = 3.63 dB

RF audio interference level = 18.71 dBV/m

Emission category: M4

MIF scaled E-field

| | | |
|--|--|--|
| Grid 1 M4 18.59 dBV/m | Grid 2 M4 20.84 dBV/m | Grid 3 M4 20.73 dBV/m |
| Grid 4 M4 16.37 dBV/m | Grid 5 M4 18.71 dBV/m | Grid 6 M4 18.44 dBV/m |
| Grid 7 M4 16.7 dBV/m | Grid 8 M4 17.21 dBV/m | Grid 9 M4 16.73 dBV/m |

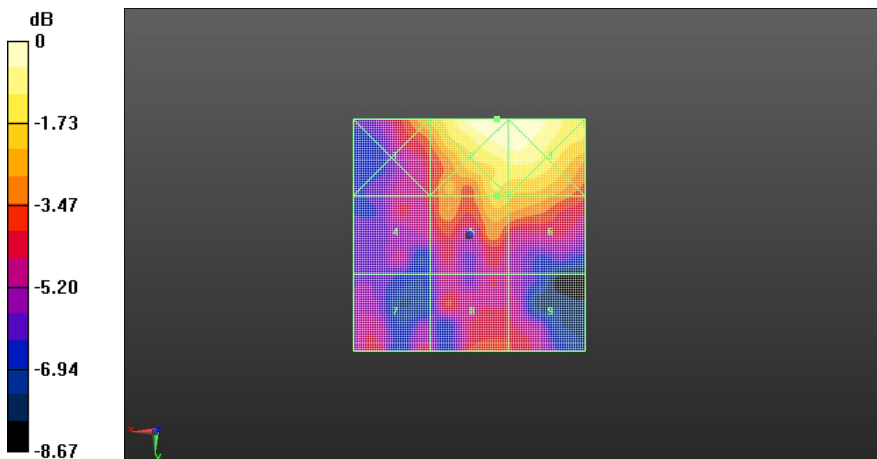

0 dB = 10.77 V/m = 20.84 dBV/m

Fig A.4 HAC RF E-Field GSM1900

HAC RF E-Field GSM 1900 Middle

Date: 2019-6-10

Electronics: DAE4 Sn1527

Medium: Air

Medium parameters used: $\sigma = 0$ S/m, $\epsilon_r = 1$; $\rho = 1000$ kg/m³

Ambient Temperature: 22.0°C Liquid Temperature: 21.5°C

Communication System: UID 0, GSM Frequency: 1880 MHz Duty Cycle: 1:8.3

Probe: ER3DV6 - SN2424 ConvF (1, 1, 1);

E Scan - ER3DV6 - 2011: 15 mm from Probe Center to the Device /Hearing Aid Compatibility Test (101x101x1): Interpolated grid: dx=0.5000 mm, dy=0.5000 mm

Device Reference Point: 0, 0, -6.3 mm

Reference Value = 4.836 V/m; Power Drift = 0.08 dB

Applied MIF = 3.63 dB

RF audio interference level = 18.93 dBV/m

Emission category: M4

MIF scaled E-field

| | | |
|--|--|--|
| Grid 1 M4 20.31 dBV/m | Grid 2 M4 21.86 dBV/m | Grid 3 M4 21.75 dBV/m |
| Grid 4 M4 17.34 dBV/m | Grid 5 M4 18.93 dBV/m | Grid 6 M4 18.92 dBV/m |
| Grid 7 M4 17.55 dBV/m | Grid 8 M4 17.79 dBV/m | Grid 9 M4 17.48 dBV/m |

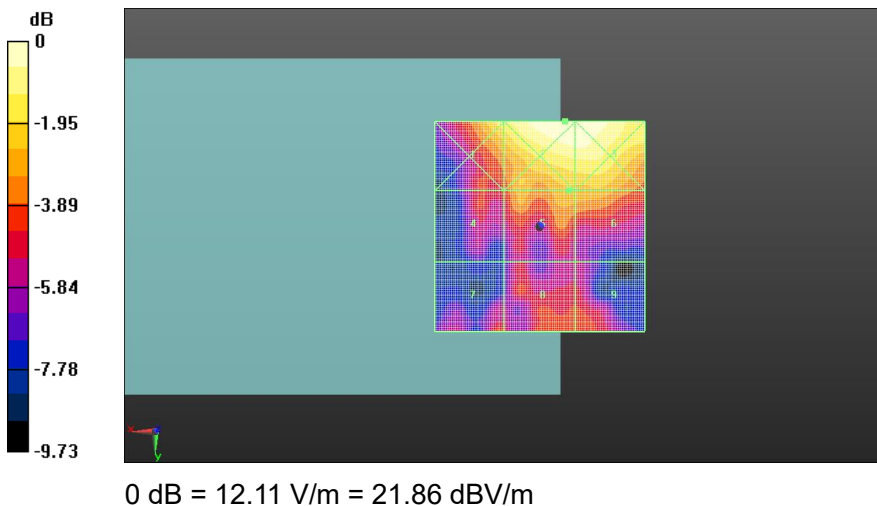

Fig A.5 HAC RF E-Field GSM1900

HAC RF E-Field GSM 1900 Low

Date: 2019-6-10

Electronics: DAE4 Sn1527

Medium: Air

Medium parameters used: $\sigma = 0$ S/m, $\epsilon_r = 1$; $\rho = 1000$ kg/m³

Ambient Temperature: 22.0°C Liquid Temperature: 21.5°C

Communication System: UID 0, GSM Frequency: 1850.2 MHz Duty Cycle: 1:8.3

Probe: ER3DV6 - SN2424 ConvF (1, 1, 1);

E Scan - ER3DV6 - 2011: 15 mm from Probe Center to the Device /Hearing Aid Compatibility Test (101x101x1): Interpolated grid: dx=0.5000 mm, dy=0.5000 mm

Device Reference Point: 0, 0, -6.3 mm

Reference Value = 5.445 V/m; Power Drift = 0.03 dB

Applied MIF = 3.63 dB

RF audio interference level = 19.48 dBV/m

Emission category: M4

MIF scaled E-field

| | | |
|--|--|--|
| Grid 1 M4 20.46 dBV/m | Grid 2 M4 22.23 dBV/m | Grid 3 M4 22.12 dBV/m |
| Grid 4 M4 17.3 dBV/m | Grid 5 M4 19.48 dBV/m | Grid 6 M4 19.48 dBV/m |
| Grid 7 M4 18.01 dBV/m | Grid 8 M4 18.28 dBV/m | Grid 9 M4 17.87 dBV/m |

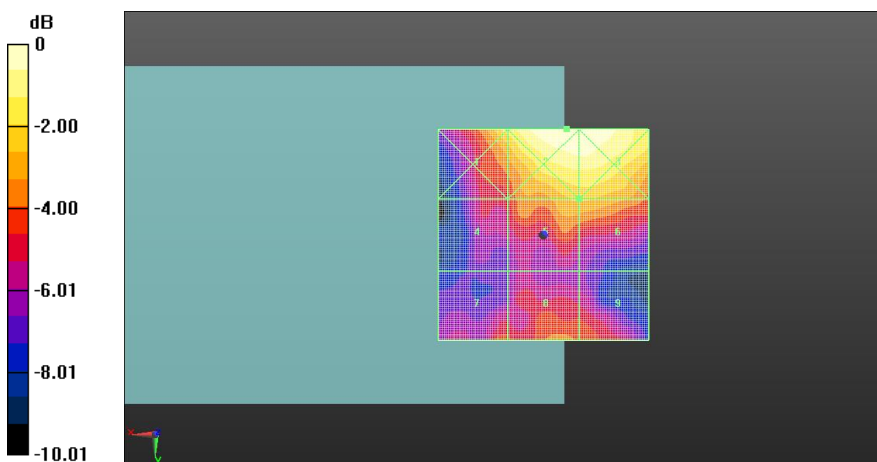

0 dB = 12.63 V/m = 22.23 dBV/m

Fig A.6 HAC RF E-Field GSM1900

HAC RF E-Field CDMA BC0 High

Date: 2019-6-10

Electronics: DAE4 Sn1527

Medium: Air

Medium parameters used: $\sigma = 0$ S/m, $\epsilon_r = 1$; $\rho = 1000$ kg/m³

Ambient Temperature: 22.0°C Liquid Temperature: 21.5°C

Communication System: UID 0, CDMA Frequency: 848.31 MHz Duty Cycle: 1:1

Probe: ER3DV6 - SN2424 ConvF (1, 1, 1);

E Scan - ER3DV6 - 2011: 15 mm from Probe Center to the Device /Hearing Aid Compatibility

Test (101x101x1): Interpolated grid: dx=0.5000 mm, dy=0.5000 mm

Device Reference Point: 0, 0, -6.3 mm

Reference Value = 14.86 V/m; Power Drift = -0.01 dB

Applied MIF = 3.26 dB

RF audio interference level = 26.02 dBV/m

Emission category: M4

MIF scaled E-field

| | | |
|--|--|--|
| Grid 1 M4 23.48 dBV/m | Grid 2 M4 25.83 dBV/m | Grid 3 M4 25.93 dBV/m |
| Grid 4 M4 24.66 dBV/m | Grid 5 M4 26.02 dBV/m | Grid 6 M4 26.1 dBV/m |
| Grid 7 M4 24.34 dBV/m | Grid 8 M4 26.11 dBV/m | Grid 9 M4 26.12 dBV/m |

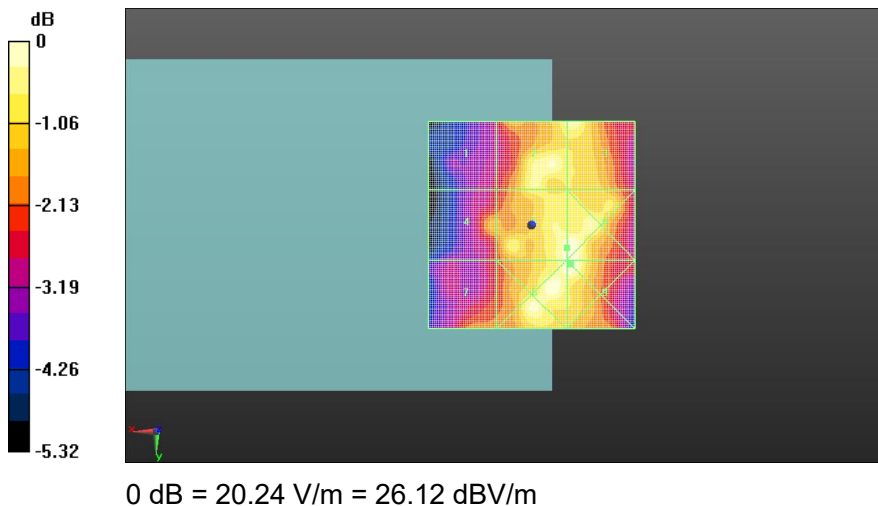

Fig A.7 HAC RF E-Field CDMA BC0

HAC RF E-Field CDMA BC0 Middle

Date: 2019-6-10

Electronics: DAE4 Sn1527

Medium: Air

Medium parameters used: $\sigma = 0$ S/m, $\epsilon_r = 1$; $\rho = 1000$ kg/m³

Ambient Temperature: 22.0°C Liquid Temperature: 21.5°C

Communication System: UID 0, CDMA Frequency: 836.52 MHz Duty Cycle: 1:1

Probe: ER3DV6 - SN2424 ConvF (1, 1, 1);

E Scan - ER3DV6 - 2011: 15 mm from Probe Center to the Device /Hearing Aid Compatibility Test (101x101x1): Interpolated grid: dx=0.5000 mm, dy=0.5000 mm

Device Reference Point: 0, 0, -6.3 mm

Reference Value = 17.41 V/m; Power Drift = -0.03 dB

Applied MIF = 3.26 dB

RF audio interference level = 26.24 dBV/m

Emission category: M4

MIF scaled E-field

| | | |
|---------------------------------|---------------------------------|---------------------------------|
| Grid 1 M4 24.59 dBV/m | Grid 2 M4 26.19 dBV/m | Grid 3 M4 26.24 dBV/m |
| Grid 4 M4 24.8 dBV/m | Grid 5 M4 26.12 dBV/m | Grid 6 M4 26.19 dBV/m |
| Grid 7 M4 24.72 dBV/m | Grid 8 M4 26.48 dBV/m | Grid 9 M4 26.42 dBV/m |

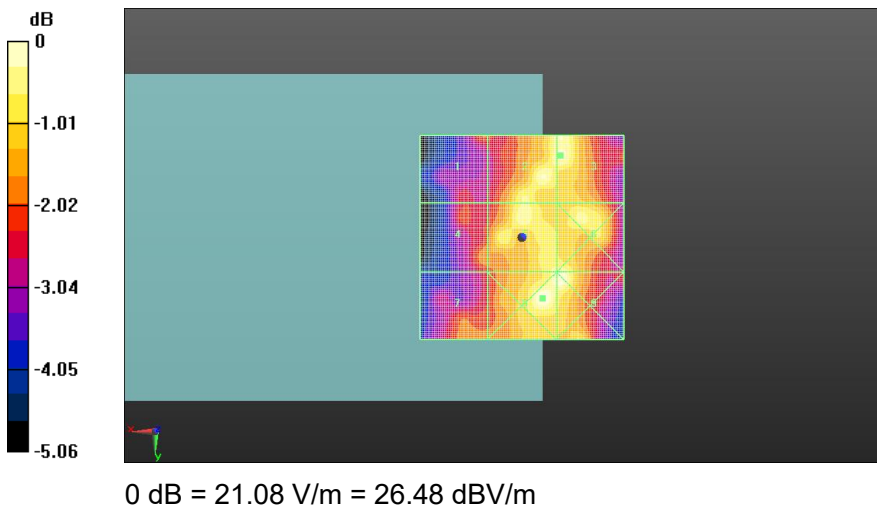

Fig A.8 HAC RF E-Field CDMA BC0

HAC RF E-Field CDMA BC0 Low

Date: 2019-6-10

Electronics: DAE4 Sn1527

Medium: Air

Medium parameters used: $\sigma = 0$ S/m, $\epsilon_r = 1$; $\rho = 1000$ kg/m³

Ambient Temperature: 22.0°C Liquid Temperature: 21.5°C

Communication System: UID 0, CDMA Frequency: 824.7 MHz Duty Cycle: 1:1

Probe: ER3DV6 - SN2424 ConvF (1, 1, 1);

E Scan - ER3DV6 - 2011: 15 mm from Probe Center to the Device /Hearing Aid Compatibility

Test (101x101x1): Interpolated grid: dx=0.5000 mm, dy=0.5000 mm

Device Reference Point: 0, 0, -6.3 mm

Reference Value = 15.47 V/m; Power Drift = -0.07 dB

Applied MIF = 3.26 dB

RF audio interference level = 26.37 dBV/m

Emission category: M4

MIF scaled E-field

| | | |
|---------------------------------|---------------------------------|---------------------------------|
| Grid 1 M4 24.74 dBV/m | Grid 2 M4 26.35 dBV/m | Grid 3 M4 26.22 dBV/m |
| Grid 4 M4 24.68 dBV/m | Grid 5 M4 26.34 dBV/m | Grid 6 M4 26.47 dBV/m |
| Grid 7 M4 25.34 dBV/m | Grid 8 M4 26.37 dBV/m | Grid 9 M4 25.71 dBV/m |

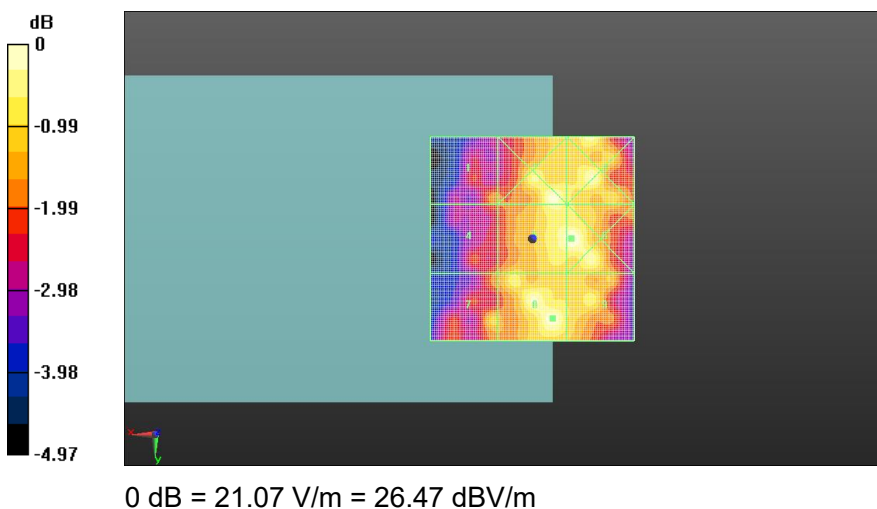

Fig A.9 HAC RF E-Field CDMA BC0

HAC RF E-Field CDMA BC1 High

Date: 2019-6-10

Electronics: DAE4 Sn1527

Medium: Air

Medium parameters used: $\sigma = 0$ S/m, $\epsilon_r = 1$; $\rho = 1000$ kg/m³

Ambient Temperature: 22.0°C Liquid Temperature: 21.5°C

Communication System: UID 0, CDMA Frequency: 1908.75 MHz Duty Cycle: 1:1

Probe: ER3DV6 - SN2424 ConvF (1, 1, 1);

E Scan - ER3DV6 - 2011: 15 mm from Probe Center to the Device /Hearing Aid Compatibility

Test (101x101x1): Interpolated grid: dx=0.5000 mm, dy=0.5000 mm

Device Reference Point: 0, 0, -6.3 mm

Reference Value = 2.739 V/m; Power Drift = 0.11 dB

Applied MIF = 3.26 dB

RF audio interference level = 15.23 dBV/m

Emission category: M4

MIF scaled E-field

| | | |
|--|--|--|
| Grid 1 M4 14.35 dBV/m | Grid 2 M4 14.54 dBV/m | Grid 3 M4 13.06 dBV/m |
| Grid 4 M4 14.44 dBV/m | Grid 5 M4 15.23 dBV/m | Grid 6 M4 13.77 dBV/m |
| Grid 7 M4 15.72 dBV/m | Grid 8 M4 15.13 dBV/m | Grid 9 M4 15.15 dBV/m |

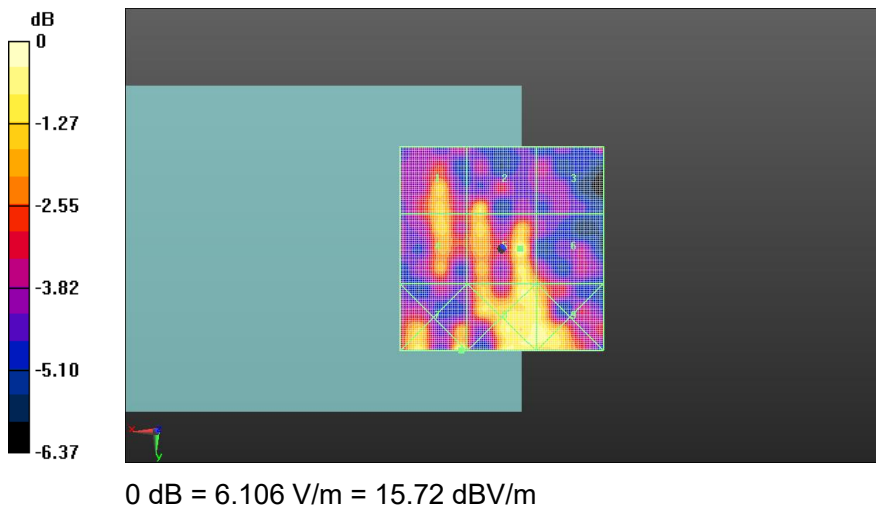

Fig A.10 HAC RF E-Field CDMA BC1

HAC RF E-Field CDMA BC1 Middle

Date: 2019-6-10

Electronics: DAE4 Sn1527

Medium: Air

Medium parameters used: $\sigma = 0$ S/m, $\epsilon_r = 1$; $\rho = 1000$ kg/m³

Ambient Temperature: 22.0°C Liquid Temperature: 21.5°C

Communication System: UID 0, CDMA Frequency: 1880 MHz Duty Cycle: 1:8.3

Probe: ER3DV6 - SN2424 ConvF (1, 1, 1);

E Scan - ER3DV6 - 2011: 15 mm from Probe Center to the Device /Hearing Aid Compatibility Test (101x101x1): Interpolated grid: dx=0.5000 mm, dy=0.5000 mm

Device Reference Point: 0, 0, -6.3 mm

Reference Value = 2.742 V/m; Power Drift = 0.07 dB

Applied MIF = 3.26 dB

RF audio interference level = 14.78 dBV/m

Emission category: M4

MIF scaled E-field

| | | |
|--|--|--|
| Grid 1 M4 14.59 dBV/m | Grid 2 M4 13.85 dBV/m | Grid 3 M4 13.13 dBV/m |
| Grid 4 M4 14.52 dBV/m | Grid 5 M4 14.78 dBV/m | Grid 6 M4 13.19 dBV/m |
| Grid 7 M4 15.65 dBV/m | Grid 8 M4 15.04 dBV/m | Grid 9 M4 14.65 dBV/m |

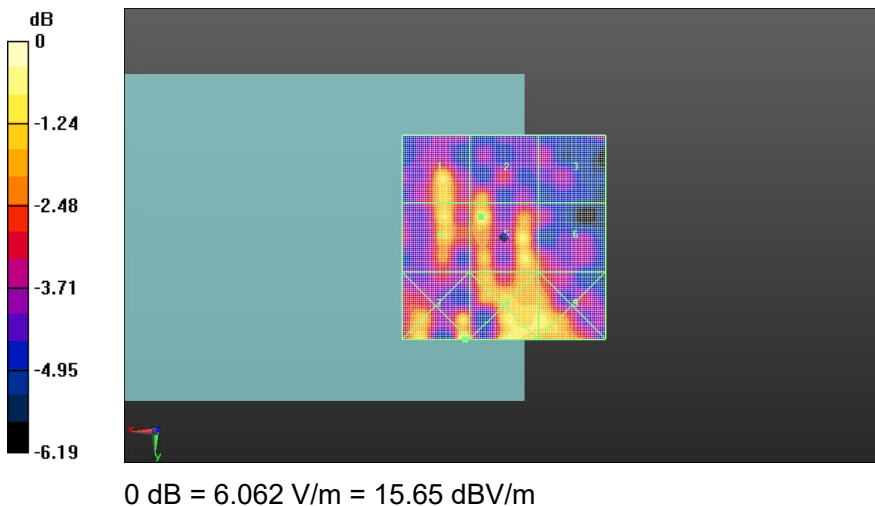

Fig A.11 HAC RF E-Field CDMA BC1

HAC RF E-Field CDMA BC1 Low

Date: 2019-6-10

Electronics: DAE4 Sn1527

Medium: Air

Medium parameters used: $\sigma = 0$ S/m, $\epsilon_r = 1$; $\rho = 1000$ kg/m³

Ambient Temperature: 22.0°C Liquid Temperature: 21.5°C

Communication System: UID 0, CDMA Frequency: 1851.25 MHz Duty Cycle: 1:8.3

Probe: ER3DV6 - SN2424 ConvF (1, 1, 1);

E Scan - ER3DV6 - 2011: 15 mm from Probe Center to the Device /Hearing Aid Compatibility

Test (101x101x1): Interpolated grid: dx=0.5000 mm, dy=0.5000 mm

Device Reference Point: 0, 0, -6.3 mm

Reference Value = 2.873 V/m; Power Drift = 0.01 dB

Applied MIF = 3.26 dB

RF audio interference level = 15.25 dBV/m

Emission category: M4

MIF scaled E-field

| | | |
|---------------------------------|---------------------------------|---------------------------------|
| Grid 1 M4 14.78 dBV/m | Grid 2 M4 14.23 dBV/m | Grid 3 M4 13.08 dBV/m |
| Grid 4 M4 14.85 dBV/m | Grid 5 M4 15.25 dBV/m | Grid 6 M4 14.37 dBV/m |
| Grid 7 M4 15.64 dBV/m | Grid 8 M4 15.65 dBV/m | Grid 9 M4 15.61 dBV/m |

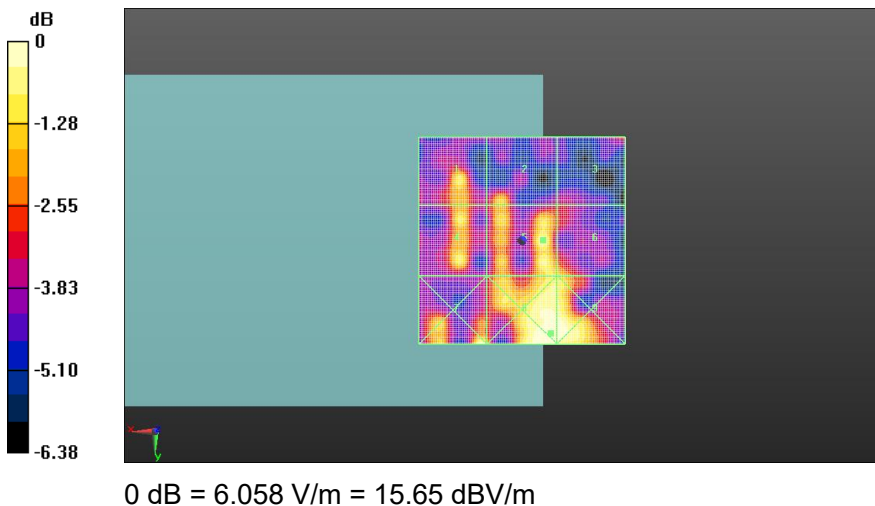

Fig A.12 HAC RF E-Field CDMA BC1

HAC RF E-Field CDMA BC10 High

Date: 2019-6-10

Electronics: DAE4 Sn1527

Medium: Air

Medium parameters used: $\sigma = 0$ S/m, $\epsilon_r = 1$; $\rho = 1000$ kg/m³

Ambient Temperature: 22.0°C Liquid Temperature: 21.5°C

Communication System: UID 0, CDMA Frequency: 823.1 MHz Duty Cycle: 1:1

Probe: ER3DV6 - SN2424 ConvF (1, 1, 1);

E Scan - ER3DV6 - 2011: 15 mm from Probe Center to the Device /Hearing Aid Compatibility

Test (101x101x1): Interpolated grid: dx=0.5000 mm, dy=0.5000 mm

Device Reference Point: 0, 0, -6.3 mm

Reference Value = 17.28 V/m; Power Drift = -0.08 dB

Applied MIF = 3.26 dB

RF audio interference level = 26.47 dBV/m

Emission category: M4

MIF scaled E-field

| | | |
|--|--|--|
| Grid 1 M4 26.14 dBV/m | Grid 2 M4 26.09 dBV/m | Grid 3 M4 26.3 dBV/m |
| Grid 4 M4 26.24 dBV/m | Grid 5 M4 26.47 dBV/m | Grid 6 M4 26.33 dBV/m |
| Grid 7 M4 26.34 dBV/m | Grid 8 M4 26.11 dBV/m | Grid 9 M4 26.09 dBV/m |

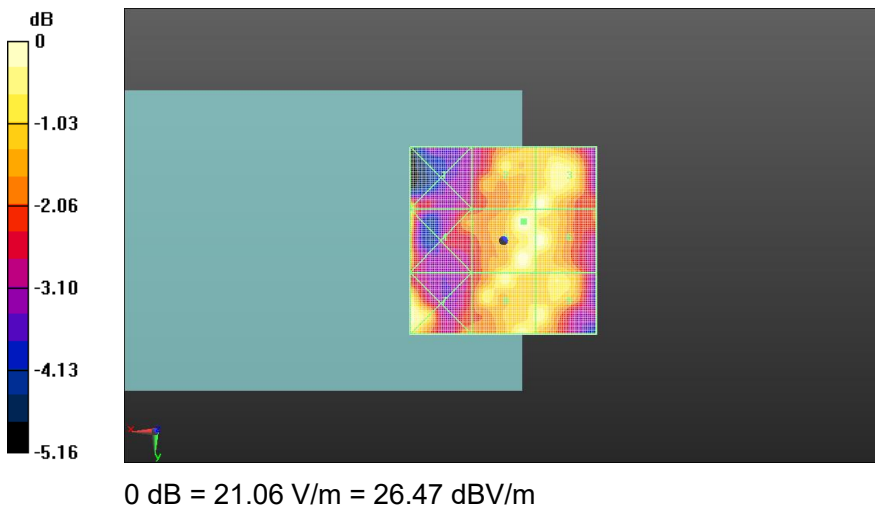

Fig A.13 HAC RF E-Field CDMA BC10

HAC RF E-Field CDMA BC10 Middle

Date: 2019-6-10

Electronics: DAE4 Sn1527

Medium: Air

Medium parameters used: $\sigma = 0$ S/m, $\epsilon_r = 1$; $\rho = 1000$ kg/m³

Ambient Temperature: 22.0°C Liquid Temperature: 21.5°C

Communication System: UID 0, CDMA Frequency: 820.5 MHz Duty Cycle: 1:1

Probe: ER3DV6 - SN2424 ConvF (1, 1, 1);

E Scan - ER3DV6 - 2011: 15 mm from Probe Center to the Device /Hearing Aid Compatibility Test (101x101x1): Interpolated grid: dx=0.5000 mm, dy=0.5000 mm

Device Reference Point: 0, 0, -6.3 mm

Reference Value = 15.33 V/m; Power Drift = -0.03 dB

Applied MIF = 3.26 dB

RF audio interference level = 28.34 dBV/m

Emission category: M4

MIF scaled E-field

| | | |
|--|--|--|
| Grid 1 M4 28.81 dBV/m | Grid 2 M4 28.7 dBV/m | Grid 3 M4 26.39 dBV/m |
| Grid 4 M4 28.38 dBV/m | Grid 5 M4 28.34 dBV/m | Grid 6 M4 26.51 dBV/m |
| Grid 7 M4 25.38 dBV/m | Grid 8 M4 26.02 dBV/m | Grid 9 M4 26.1 dBV/m |

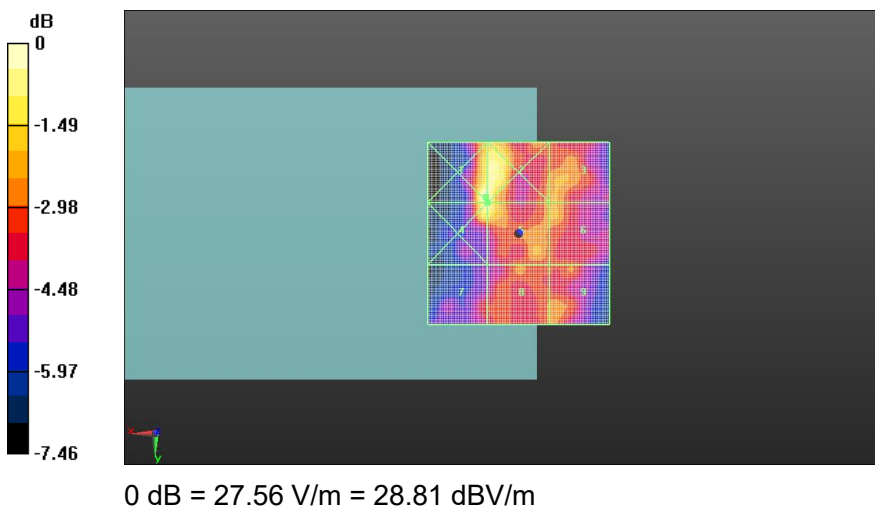

Fig A.14 HAC RF E-Field CDMA BC10

HAC RF E-Field CDMA BC10 Low

Date: 2019-6-10

Electronics: DAE4 Sn1527

Medium: Air

Medium parameters used: $\sigma = 0$ S/m, $\epsilon_r = 1$; $\rho = 1000$ kg/m³

Ambient Temperature: 22.0°C Liquid Temperature: 21.5°C

Communication System: UID 0, CDMA Frequency: 817.9 MHz Duty Cycle: 1:1

Probe: ER3DV6 - SN2424 ConvF (1, 1, 1);

E Scan - ER3DV6 - 2011: 15 mm from Probe Center to the Device /Hearing Aid Compatibility Test (101x101x1): Interpolated grid: dx=0.5000 mm, dy=0.5000 mm

Device Reference Point: 0, 0, -6.3 mm

Reference Value = 17.90 V/m; Power Drift = -0.09 dB

Applied MIF = 3.26 dB

RF audio interference level = 30.39 dBV/m

Emission category: M4

MIF scaled E-field

| | | |
|--|--|--|
| Grid 1 M4 23.96 dBV/m | Grid 2 M4 30.16 dBV/m | Grid 3 M4 26.32 dBV/m |
| Grid 4 M4 25.09 dBV/m | Grid 5 M4 30.39 dBV/m | Grid 6 M4 26.67 dBV/m |
| Grid 7 M4 24.71 dBV/m | Grid 8 M4 26.52 dBV/m | Grid 9 M4 25.8 dBV/m |

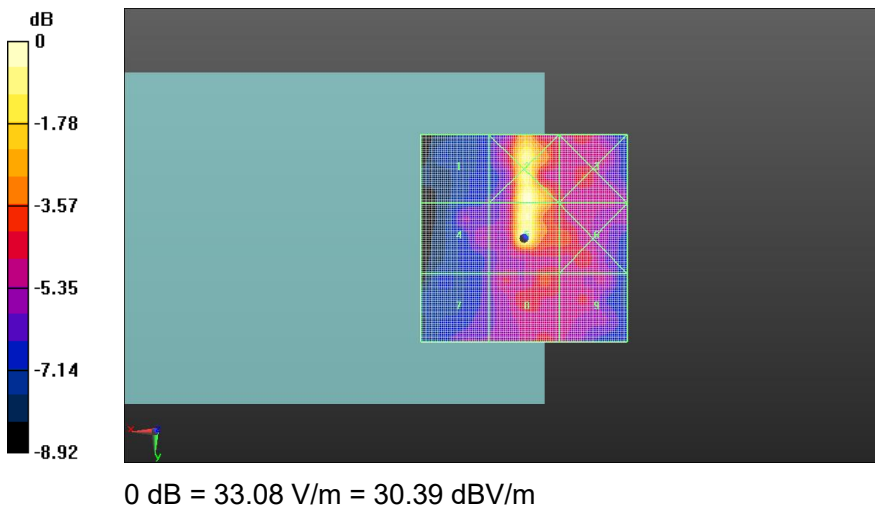

Fig A.15 HAC RF E-Field CDMA BC10

HAC RF E-Field LTE-Band 41 High

Date: 2019-6-9

Electronics: DAE4 Sn1527

Medium: Air

Medium parameters used: $\sigma = 0$ S/m, $\epsilon_r = 1$; $\rho = 1000$ kg/m³

Ambient Temperature: 22.0°C Liquid Temperature: 21.5°C

Communication System: UID 0, LTE_TDD Frequency: 2680 MHz Duty Cycle: 1:1.58

Probe: ER3DV6 - SN2424 ConvF (1, 1, 1);

E Scan - ER3DV6 - 2011: 15 mm from Probe Center to the Device /Hearing Aid Compatibility Test (101x101x1): Interpolated grid: dx=0.5000 mm, dy=0.5000 mm

Device Reference Point: 0, 0, -6.3 mm

Reference Value = 5.935 V/m; Power Drift = 0.06 dB

Applied MIF = -1.44 dB

RF audio interference level = 20.02 dBV/m

Emission category: M4

MIF scaled E-field

| | | |
|--|--|--|
| Grid 1 M4 21.63 dBV/m | Grid 2 M4 18.78 dBV/m | Grid 3 M4 20.1 dBV/m |
| Grid 4 M4 18.99 dBV/m | Grid 5 M4 18.22 dBV/m | Grid 6 M4 20.02 dBV/m |
| Grid 7 M4 17.96 dBV/m | Grid 8 M4 17.19 dBV/m | Grid 9 M4 18.81 dBV/m |

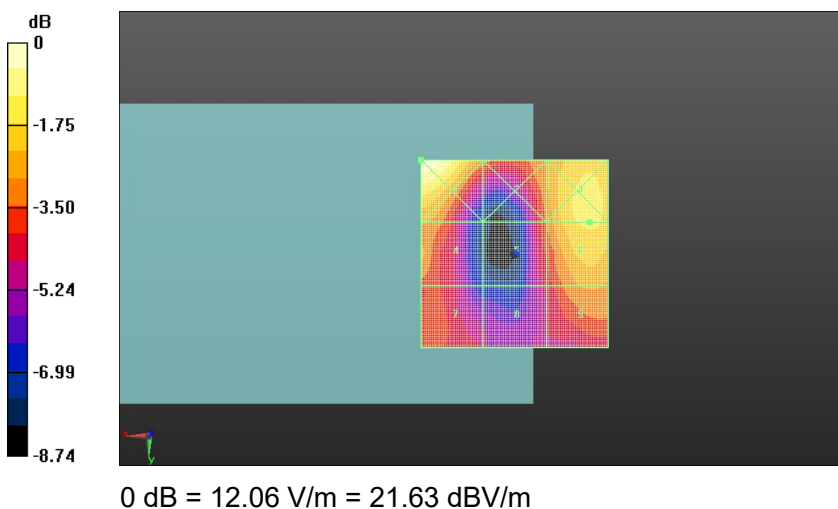

Fig A.7 HAC RF E-Field LTE-Band 41 High

HAC RF E-Field LTE-Band 41 High-2

Date: 2019-6-9

Electronics: DAE4 Sn1527

Medium: Air

Medium parameters used: $\sigma = 0$ S/m, $\epsilon_r = 1$; $\rho = 1000$ kg/m³

Ambient Temperature: 22.0°C Liquid Temperature: 21.5°C

Communication System: UID 0, LTE_TDD Frequency: 2636.5 MHz Duty Cycle: 1:1.58

Probe: ER3DV6 - SN2424 ConvF (1, 1, 1);

E Scan - ER3DV6 - 2011: 15 mm from Probe Center to the Device /Hearing Aid Compatibility

Test (101x101x1): Interpolated grid: dx=0.5000 mm, dy=0.5000 mm

Device Reference Point: 0, 0, -6.3 mm

Reference Value = 7.832 V/m; Power Drift = 0.08 dB

Applied MIF = -1.44 dB

RF audio interference level = 19.99 dBV/m

Emission category: M4

MIF scaled E-field

| | | |
|--|--|--|
| Grid 1 M4 19.99 dBV/m | Grid 2 M4 21.10 dBV/m | Grid 3 M4 21.16 dBV/m |
| Grid 4 M4 16.29 dBV/m | Grid 5 M4 19.37 dBV/m | Grid 6 M4 19.99 dBV/m |
| Grid 7 M4 14.7 dBV/m | Grid 8 M4 16.7 dBV/m | Grid 9 M4 17.99 dBV/m |

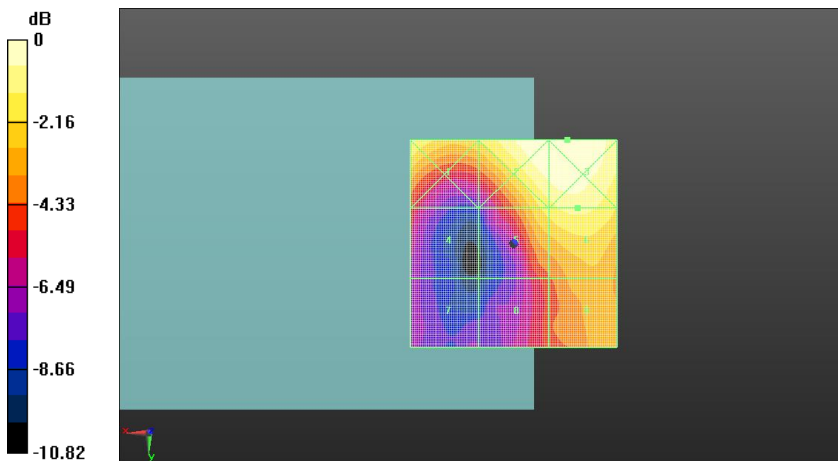

0 dB = 11.43 V/m = 21.16 dBV/m

Fig A.7 HAC RF E-Field LTE-Band 41 High-2

HAC RF E-Field LTE-Band 41 Middle

Date: 2019-6-9

Electronics: DAE4 Sn1527

Medium: Air

Medium parameters used: $\sigma = 0$ S/m, $\epsilon_r = 1$; $\rho = 1000$ kg/m³

Ambient Temperature: 22.0°C Liquid Temperature: 21.5°C

Communication System: UID 0, LTE_TDD Frequency: 2593 MHz Duty Cycle: 1:1.58

Probe: ER3DV6 - SN2424 ConvF (1, 1, 1);

E Scan - ER3DV6 - 2011: 15 mm from Probe Center to the Device /Hearing Aid Compatibility Test (101x101x1): Interpolated grid: dx=0.5000 mm, dy=0.5000 mm

Device Reference Point: 0, 0, -6.3 mm

Reference Value = 5.935 V/m; Power Drift = 0.10 dB

Applied MIF = -1.44 dB

RF audio interference level = 19.91 dBV/m

Emission category: M4

MIF scaled E-field

| | | |
|--|--|--|
| Grid 1 M4 21.60 dBV/m | Grid 2 M4 18.67 dBV/m | Grid 3 M4 19.99 dBV/m |
| Grid 4 M4 18.88 dBV/m | Grid 5 M4 18.11 dBV/m | Grid 6 M4 19.91 dBV/m |
| Grid 7 M4 17.85 dBV/m | Grid 8 M4 17.08 dBV/m | Grid 9 M4 18.7 dBV/m |

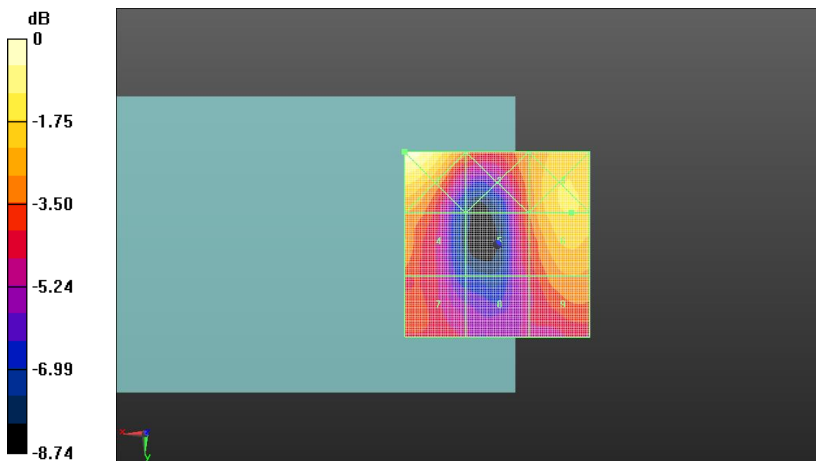

0 dB = 12.06 V/m = 21.60 dBV/m

Fig A.8 HAC RF E-Field LTE-Band 41 Middle

HAC RF E-Field LTE-Band 41 Low-2

Date: 2019-6-9

Electronics: DAE4 Sn1527

Medium: Air

Medium parameters used: $\sigma = 0$ S/m, $\epsilon_r = 1$; $\rho = 1000$ kg/m³

Ambient Temperature: 22.0°C Liquid Temperature: 21.5°C

Communication System: UID 0, LTE_TDD Frequency: 2549.5 MHz Duty Cycle: 1:1.58

Probe: ER3DV6 - SN2424 ConvF (1, 1, 1);

E Scan - ER3DV6 - 2011: 15 mm from Probe Center to the Device /Hearing Aid Compatibility Test (101x101x1): Interpolated grid: dx=0.5000 mm, dy=0.5000 mm

Device Reference Point: 0, 0, -6.3 mm

Reference Value = 7.832 V/m; Power Drift = 0.05 dB

Applied MIF = -1.44 dB

RF audio interference level = 19.80 dBV/m

Emission category: M4

MIF scaled E-field

| | | |
|--|--|--|
| Grid 1 M4 19.8 dBV/m | Grid 2 M4 20.98 dBV/m | Grid 3 M4 21.12 dBV/m |
| Grid 4 M4 16.1 dBV/m | Grid 5 M4 19.18 dBV/m | Grid 6 M4 19.8 dBV/m |
| Grid 7 M4 14.51 dBV/m | Grid 8 M4 16.51 dBV/m | Grid 9 M4 17.8 dBV/m |

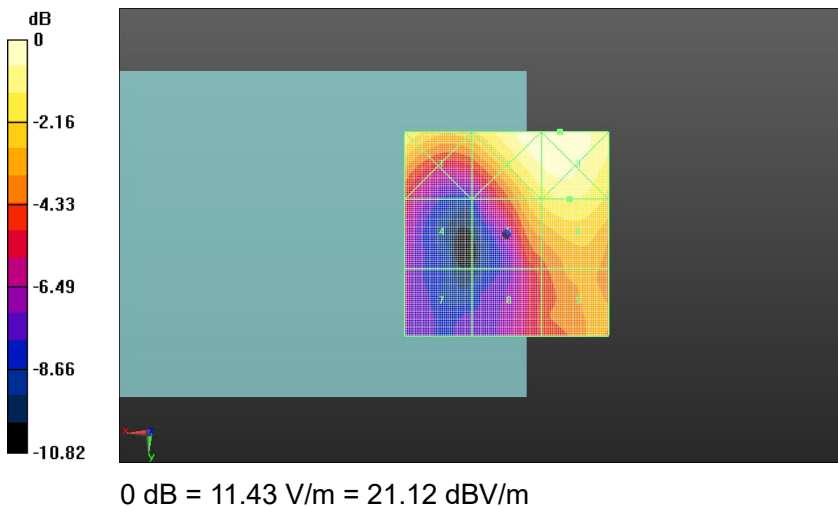

Fig A.9 HAC RF E-Field LTE-Band 41 Low-2

HAC RF E-Field LTE-Band 41 Low

Date: 2019-6-9

Electronics: DAE4 Sn1527

Medium: Air

Medium parameters used: $\sigma = 0$ S/m, $\epsilon_r = 1$; $\rho = 1000$ kg/m³

Ambient Temperature: 22.0°C Liquid Temperature: 21.5°C

Communication System: UID 0, LTE_TDD Frequency: 2506 MHz Duty Cycle: 1:1.58

Probe: ER3DV6 - SN2424 ConvF (1, 1, 1);

E Scan - ER3DV6 - 2011: 15 mm from Probe Center to the Device /Hearing Aid Compatibility

Test (101x101x1): Interpolated grid: dx=0.5000 mm, dy=0.5000 mm

Device Reference Point: 0, 0, -6.3 mm

Reference Value = 6.080 V/m; Power Drift = 0.08 dB

Applied MIF = -1.44 dB

RF audio interference level = 19.04 dBV/m

Emission category: M4

MIF scaled E-field

| | | |
|--|--|--|
| Grid 1 M4 20.14 dBV/m | Grid 2 M4 20.03 dBV/m | Grid 3 M4 20.24 dBV/m |
| Grid 4 M4 18.17 dBV/m | Grid 5 M4 17.98 dBV/m | Grid 6 M4 19.04 dBV/m |
| Grid 7 M4 17.83 dBV/m | Grid 8 M4 16.3 dBV/m | Grid 9 M4 16.96 dBV/m |

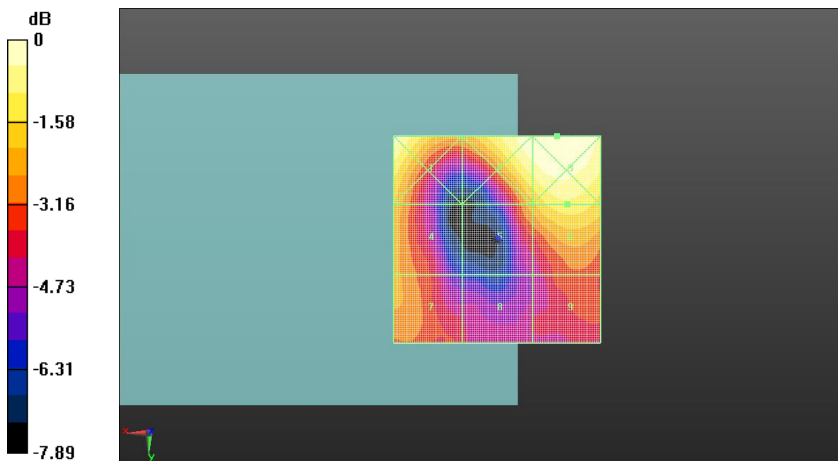

0 dB = 10.28 V/m = 20.24 dBV/m

Fig A.9 HAC RF E-Field LTE-Band 41 Low

ANNEX B System Validation Result

835 MHz

Date: 2019-6-10

Electronics: DAE4 Sn1527

Medium: Air

Medium parameters used: $\sigma = 0$ mho/m, $\epsilon_r = 1$; $\rho = 1000$ kg/m³

Communication System: CW; Frequency: 835 MHz; Duty Cycle: 1:1

Probe: ER3DV6 - SN2424; ConvF (1, 1, 1)

E Scan - measurement distance from the probe sensor center to CD835 Dipole = 15mm

/Hearing Aid Compatibility Test (41x361x1): Interpolated grid: dx=0.5000 mm, dy=0.5000 mm

Device Reference Point: 0, 0, -6.3 mm

Reference Value = 110.9 V/m; Power Drift = 0.08 dB

Applied MIF = 0.00 dB

RF audio interference level = 42.28 dBV/m

Emission category: M3

MIF scaled E-field

| | | |
|---------------------------------|---------------------------------|---------------------------------|
| Grid 1 M3 41.62 dBV/m | Grid 2 M3 42.18 dBV/m | Grid 3 M3 42.02 dBV/m |
| Grid 4 M4 37.11 dBV/m | Grid 5 M4 37.44 dBV/m | Grid 6 M4 37.38 dBV/m |
| Grid 7 M3 41.74 dBV/m | Grid 8 M3 42.28 dBV/m | Grid 9 M3 42.09 dBV/m |

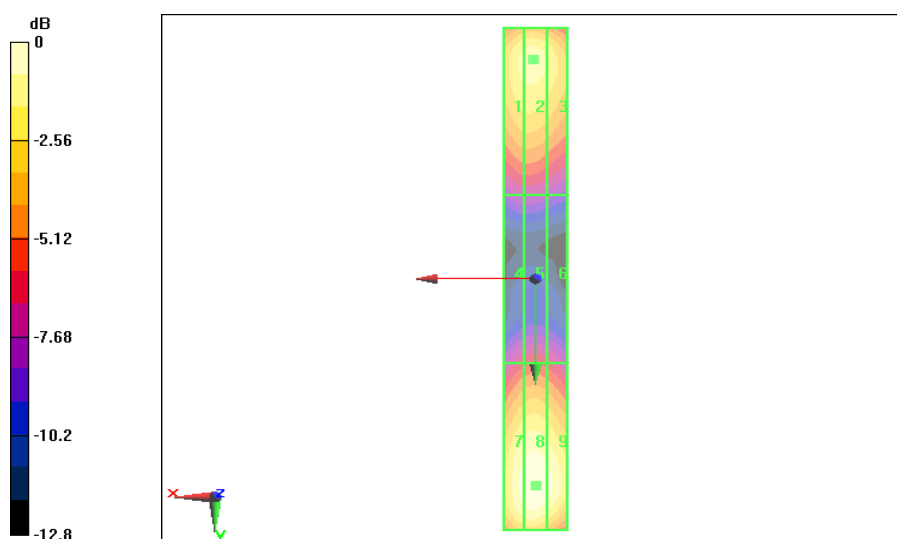

0 dB = 42.28 dBV/m

1880 MHz

Date: 2019-6-10

Electronics: DAE4 Sn1527

Medium: Air

Medium parameters used: $\sigma = 0$ mho/m, $\epsilon_r = 1$; $\rho = 1000$ kg/m³

Communication System: CW; Frequency: 1880 MHz; Duty Cycle: 1:1

Probe: ER3DV6 - SN2424; ConvF (1, 1, 1)

E Scan - measurement distance from the probe sensor center to CD1880 Dipole = 15mm

/Hearing Aid Compatibility Test (41x181x1): Interpolated grid: dx=0.5000 mm, dy=0.5000 mm

Device Reference Point: 0, 0, -6.3 mm

Reference Value = 106.4 V/m; Power Drift = 0.02 dB

Applied MIF = 0.00 dB

RF audio interference level = 39.64 dBV/m

Emission category: M2

MIF scaled E-field

| | | |
|---------------------------------|----------------------------------|---------------------------------|
| Grid 1 M2 39.18 dBV/m | Grid 2 M2 39.64 dBV/m | Grid 3 M2 39.56 dBV/m |
| Grid 4 M2 37.39 dBV/m | Grid 5 M2 37.73 dBV/m | Grid 6 M2 37.68 dBV/m |
| Grid 7 M2 39.15 dBV/m | Grid 8 M2 39.60 dB V/m | Grid 9 M2 39.51 dBV/m |

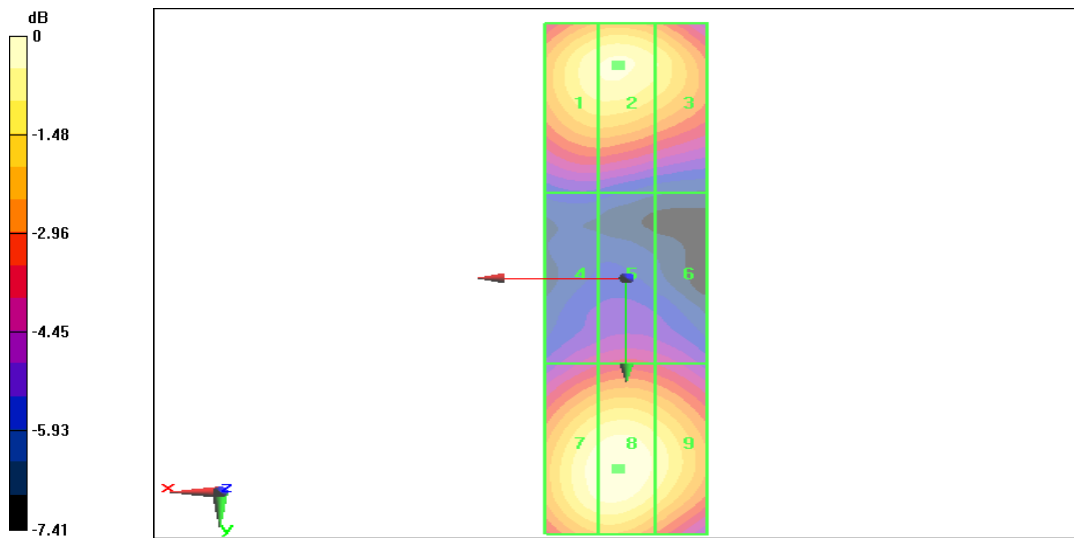

0 dB = 39.64 dBV/m

2600 MHz

Date: 2019-6-9

Electronics: DAE4 Sn1527

Medium: Air

Medium parameters used: $\sigma = 0$ mho/m, $\epsilon_r = 1$; $\rho = 1000$ kg/m³

Communication System: CW; Frequency: 1880 MHz; Duty Cycle: 1:1

Probe: ER3DV6 - SN2424; ConvF (1, 1, 1)

E Scan - measurement distance from the probe sensor center to CD2600 Dipole = 15mm

/Hearing Aid Compatibility Test (41x181x1): Interpolated grid: dx=0.5000 mm, dy=0.5000 mm

Device Reference Point: 0, 0, -6.3 mm

Reference Value = 70.68 V/m; Power Drift = -0.09 dB

Applied MIF = 0.00 dB

RF audio interference level = 39.53 dBV/m

Emission category: M2

MIF scaled E-field

| | | |
|---------------------------------|----------------------------------|---------------------------------|
| Grid 1 M2 39.08 dBV/m | Grid 2 M2 39.35 dBV/m | Grid 3 M2 39.29 dBV/m |
| Grid 4 M2 38.72 dBV/m | Grid 5 M2 38.88 dBV/m | Grid 6 M2 38.86 dBV/m |
| Grid 7 M2 39.36 dBV/m | Grid 8 M2 39.53 dB V/m | Grid 9 M2 39.44 dBV/m |

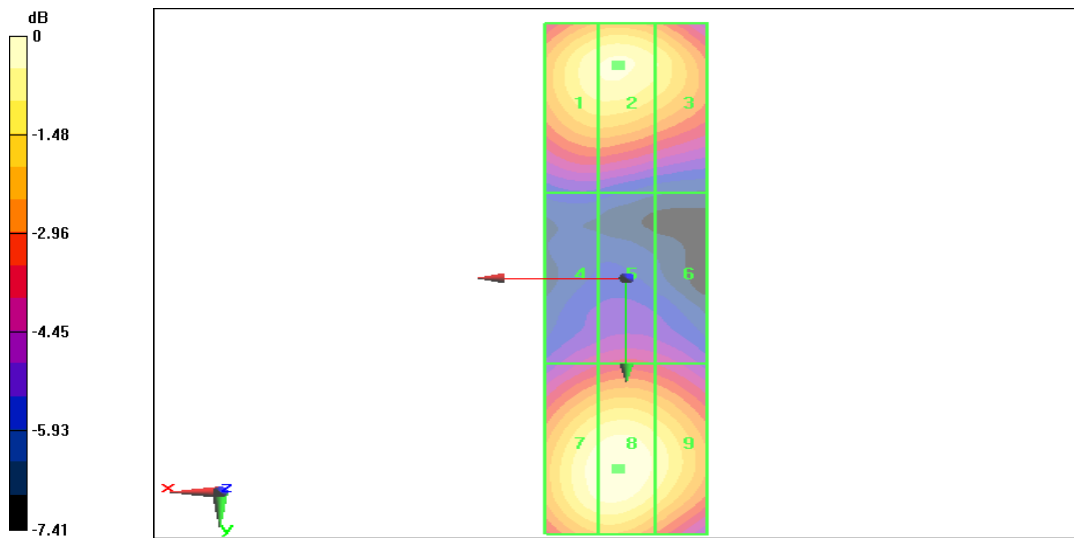

0 dB = 39.53 dBV/m

ANNEX C Probe Calibration Certificate

E_Probe ER3DV6

**Calibration Laboratory of
Schmid & Partner
Engineering AG**
Zeughausstrasse 43, 8004 Zurich, Switzerland



S Schweizerischer Kalibrierdienst
C Service suisse d'étalonnage
S Servizio svizzero di taratura
S Swiss Calibration Service

Accredited by the Swiss Accreditation Service (SAS)
The Swiss Accreditation Service is one of the signatories to the EA
Multilateral Agreement for the recognition of calibration certificates

Accreditation No.: **SCS 0108**

Client **CTTL-SZ (Auden)**

Certificate No: **ER3-2424_Feb18**

CALIBRATION CERTIFICATE

Object **ER3DV6 - SN:2424**

Calibration procedure(s) **QA CAL-02.v8, QA CAL-25.v6
Calibration procedure for E-field probes optimized for close near field
evaluations in air**

Calibration date: **February 23, 2018**

This calibration certificate documents the traceability to national standards, which realize the physical units of measurements (SI).
The measurements and the uncertainties with confidence probability are given on the following pages and are part of the certificate.

All calibrations have been conducted in the closed laboratory facility: environment temperature (22 ± 3)°C and humidity < 70%.

Calibration Equipment used (M&TE critical for calibration)

| Primary Standards | ID | Cal Date (Certificate No.) | Scheduled Calibration |
|----------------------------|------------------|-----------------------------------|------------------------|
| Power meter NRP | SN: 104778 | 04-Apr-17 (No. 217-02521/02522) | Apr-18 |
| Power sensor NRP-Z91 | SN: 103244 | 04-Apr-17 (No. 217-02521) | Apr-18 |
| Power sensor NRP-Z91 | SN: 103245 | 04-Apr-17 (No. 217-02525) | Apr-18 |
| Reference 20 dB Attenuator | SN: S5277 (20x) | 07-Apr-17 (No. 217-02528) | Apr-18 |
| Reference Probe ER3DV6 | SN: 2328 | 10-Oct-17 (No. ER3-2328_Oct17) | Oct-18 |
| DAE4 | SN: 789 | 2-Aug-17 (No. DAE4-789_Aug17) | Aug-18 |
| Secondary Standards | ID | Check Date (in house) | Scheduled Check |
| Power meter E4419B | SN: GB41293874 | 06-Apr-16 (in house check Jun-16) | In house check: Jun-18 |
| Power sensor E4412A | SN: MY41498087 | 06-Apr-16 (in house check Jun-16) | In house check: Jun-18 |
| Power sensor E4412A | SN: 000110210 | 06-Apr-16 (in house check Jun-16) | In house check: Jun-18 |
| RF generator HP 8648C | SN: US3642U01700 | 04-Aug-99 (in house check Jun-16) | In house check: Jun-18 |
| Network Analyzer HP 8753E | SN: US37390585 | 18-Oct-01 (in house check Oct-17) | In house check: Oct-18 |

| | | | |
|----------------|-------------------------------|-----------------------------------|---------------|
| Calibrated by: | Name Jeton Kastrati | Function Laboratory Technician | Signature |
| Approved by: | Name Katja Pokovic | Function Technical Manager | Signature |

Issued: February 23, 2018

This calibration certificate shall not be reproduced except in full without written approval of the laboratory.

**Calibration Laboratory of
Schmid & Partner
Engineering AG**
Zeughausstrasse 43, 8004 Zurich, Switzerland



S Schweizerischer Kalibrierdienst
C Service suisse d'étalonnage
S Servizio svizzero di taratura
S Swiss Calibration Service

Accredited by the Swiss Accreditation Service (SAS)
The Swiss Accreditation Service is one of the signatories to the EA
Multilateral Agreement for the recognition of calibration certificates

Accreditation No.: **SCS 0108**

Glossary:

| | |
|--------------------------|---|
| NORM _{x,y,z} | sensitivity in free space |
| DCP | diode compression point |
| CF | crest factor (1/duty_cycle) of the RF signal |
| A, B, C, D | modulation dependent linearization parameters |
| Polarization φ | φ rotation around probe axis |
| Polarization ϑ | ϑ rotation around an axis that is in the plane normal to probe axis (at measurement center), i.e., $\vartheta = 0$ is normal to probe axis |
| Connector Angle | information used in DASY system to align probe sensor X to the robot coordinate system |

Calibration is Performed According to the Following Standards:

- IEEE Std 1309-2005, "IEEE Standard for calibration of electromagnetic field sensors and probes, excluding antennas, from 9 kHz to 40 GHz", December 2005
- CTIA Test Plan for Hearing Aid Compatibility, Rev 3.0, November 2013

Methods Applied and Interpretation of Parameters:

- NORM_{x,y,z}**: Assessed for E-field polarization $\vartheta = 0$ for XY sensors and $\vartheta = 90$ for Z sensor ($f \leq 900$ MHz in TEM-cell; $f > 1800$ MHz: R22 waveguide).
- NORM(f)_{x,y,z}** = NORM_{x,y,z} * frequency_response (see Frequency Response Chart).
- DCP_{x,y,z}**: DCP are numerical linearization parameters assessed based on the data of power sweep with CW signal (no uncertainty required). DCP does not depend on frequency nor media.
- PAR**: PAR is the Peak to Average Ratio that is not calibrated but determined based on the signal characteristics
- A_{x,y,z}; B_{x,y,z}; C_{x,y,z}; D_{x,y,z}; VR_{x,y,z}**: A, B, C, D are numerical linearization parameters assessed based on the data of power sweep for specific modulation signal. The parameters do not depend on frequency nor media. VR is the maximum calibration range expressed in RMS voltage across the diode.
- Spherical isotropy (3D deviation from isotropy)**: in a locally homogeneous field realized using an open waveguide setup.
- Sensor Offset**: The sensor offset corresponds to the offset of virtual measurement center from the probe tip (on probe axis). No tolerance required.
- Connector Angle**: The angle is assessed using the information gained by determining the NORM_x (no uncertainty required).

ER3DV6 – SN:2424

February 23, 2018

Probe ER3DV6

SN:2424

Manufactured: November 12, 2007
Calibrated: February 23, 2018

Calibrated for DASY/EASY Systems
(Note: non-compatible with DASY2 system!)

ER3DV6 – SN:2424

February 23, 2018

DASY/EASY - Parameters of Probe: ER3DV6 - SN:2424

Basic Calibration Parameters

| | Sensor X | Sensor Y | Sensor Z | Unc (k=2) |
|--|----------|----------|----------|--------------|
| Norm ($\mu\text{V}/(\text{V}/\text{m})^2$) | 1.46 | 1.51 | 1.82 | $\pm 10.1\%$ |
| DCP (mV) ⁵ | 100.0 | 98.3 | 100.6 | |

Modulation Calibration Parameters

| UID | Communication System Name | | A dB | B dB/ μV | C | D dB | VR mV | Unc ^E (k=2) |
|-----------|--|---|---------|------------------------|------|---------|----------|---------------------------|
| 0 | CW | X | 0.0 | 0.0 | 1.0 | 0.00 | 189.6 | $\pm 3.5\%$ |
| | | Y | 0.0 | 0.0 | 1.0 | | 204.8 | |
| | | Z | 0.0 | 0.0 | 1.0 | | 200.6 | |
| 10021-DAC | GSM-FDD (TDMA, GMSK) | X | 21.68 | 99.9 | 28.7 | 9.39 | 106.2 | $\pm 2.2\%$ |
| | | Y | 19.41 | 99.7 | 28.8 | | 111.3 | |
| | | Z | 24.71 | 99.5 | 28.2 | | 119.2 | |
| 10061-CAB | IEEE 802.11g WiFi 2.4 GHz (DSSS, 11 Mbps) | X | 8.35 | 84.6 | 25.4 | 3.60 | 146.9 | $\pm 1.9\%$ |
| | | Y | 4.81 | 74.8 | 21.7 | | 112.9 | |
| | | Z | 6.43 | 78.8 | 22.9 | | 111.9 | |
| 10077-CAB | IEEE 802.11g WiFi 2.4 GHz (DSSS/OFDM, 54 Mbps) | X | 13.28 | 77.7 | 29.3 | 11.00 | 139.0 | $\pm 3.8\%$ |
| | | Y | 11.65 | 73.4 | 26.9 | | 100.8 | |
| | | Z | 11.41 | 72.1 | 25.6 | | 99.2 | |
| 10172-CAD | LTE-TDD (SC-FDMA, 1 RB, 20 MHz, QPSK) | X | 9.48 | 80.8 | 29.7 | 9.21 | 125.2 | $\pm 3.8\%$ |
| | | Y | 9.49 | 81.9 | 30.6 | | 134.1 | |
| | | Z | 10.82 | 83.6 | 30.5 | | 136.8 | |
| 10173-CAD | LTE-TDD (SC-FDMA, 1 RB, 20 MHz, 16-QAM) | X | 9.87 | 81.2 | 29.9 | 9.48 | 125.1 | $\pm 2.5\%$ |
| | | Y | 10.11 | 83.1 | 31.3 | | 134.2 | |
| | | Z | 11.30 | 84.2 | 30.8 | | 136.9 | |
| 10295-AAB | CDMA2000, RC1, SO3, 1/8th Rate 25 fr. | X | 16.69 | 99.5 | 40.3 | 12.49 | 96.6 | $\pm 2.5\%$ |
| | | Y | 15.42 | 99.3 | 41.1 | | 100.6 | |
| | | Z | 17.91 | 99.9 | 39.8 | | 104.3 | |

The reported uncertainty of measurement is stated as the standard uncertainty of measurement multiplied by the coverage factor k=2, which for a normal distribution corresponds to a coverage probability of approximately 95%.

^B Numerical linearization parameter; uncertainty not required.

^E Uncertainty is determined using the max. deviation from linear response applying rectangular distribution and is expressed for the square of the field value.

ER3DV6 – SN:2424

February 23, 2018

Frequency Response of E-Field
(TEM-Cell:ifi110 EXX, Waveguide: R22)

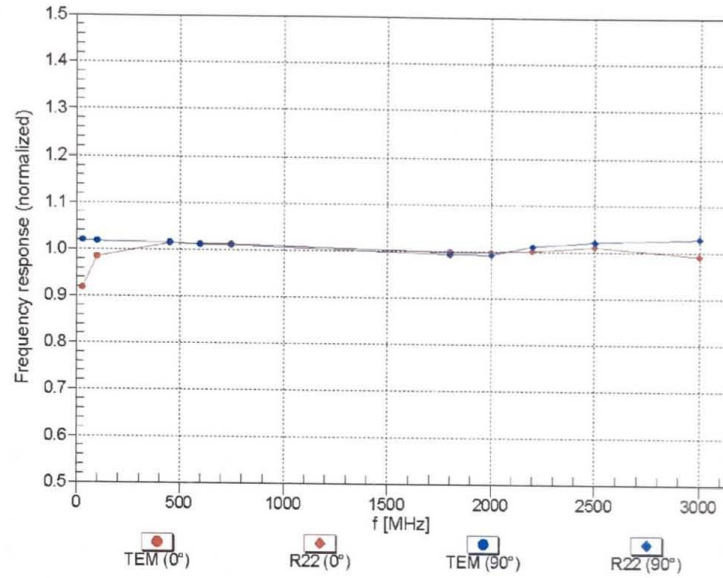

Uncertainty of Frequency Response of E-field: $\pm 6.3\%$ (k=2)

ER3DV6 – SN:2424

February 23, 2018

Receiving Pattern (ϕ), $\vartheta = 0^\circ$

f=600 MHz,TEM,0°

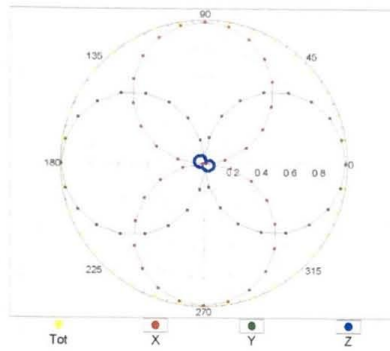

f=2500 MHz,R22,0°

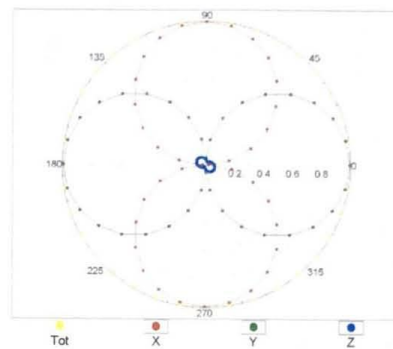

Receiving Pattern (ϕ), $\vartheta = 90^\circ$

f=600 MHz,TEM,90°

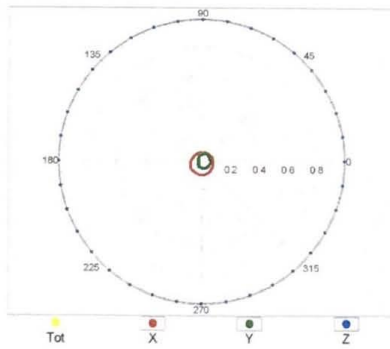

f=2500 MHz,R22,90°

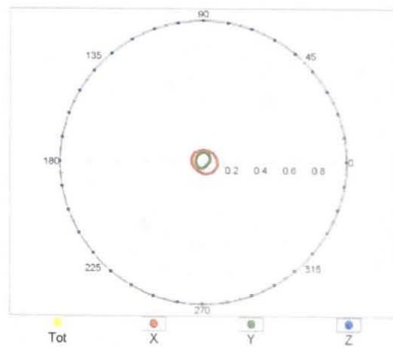

ER3DV6 – SN:2424

February 23, 2018

Receiving Pattern (ϕ), $\vartheta = 0^\circ$

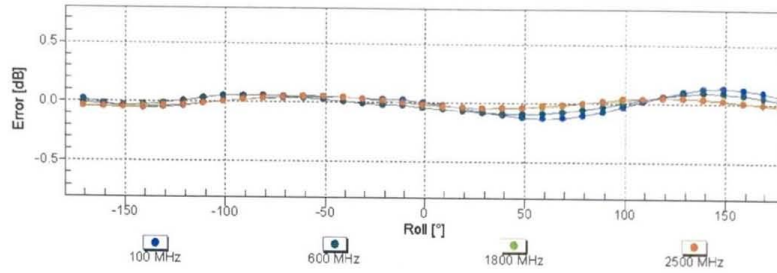

Uncertainty of Axial Isotropy Assessment: $\pm 0.5\%$ ($k=2$)

Receiving Pattern (ϕ), $\vartheta = 90^\circ$

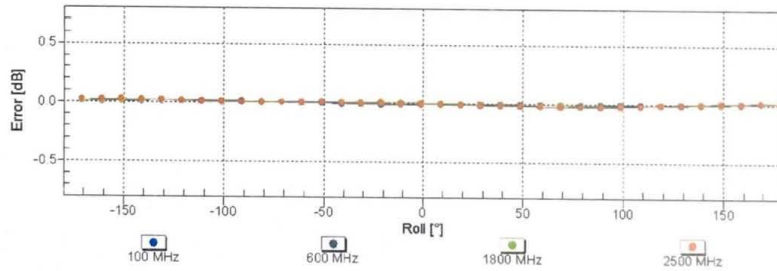

Uncertainty of Axial Isotropy Assessment: $\pm 0.5\%$ ($k=2$)

ER3DV6 – SN:2424

February 23, 2018

Dynamic Range f(E-field)
(TEM cell , f = 900 MHz)

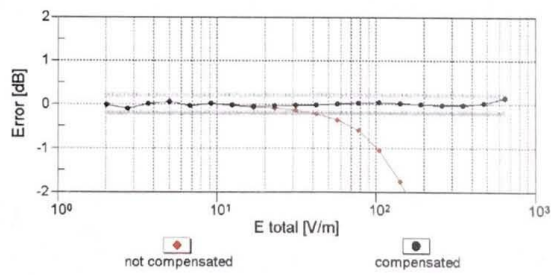
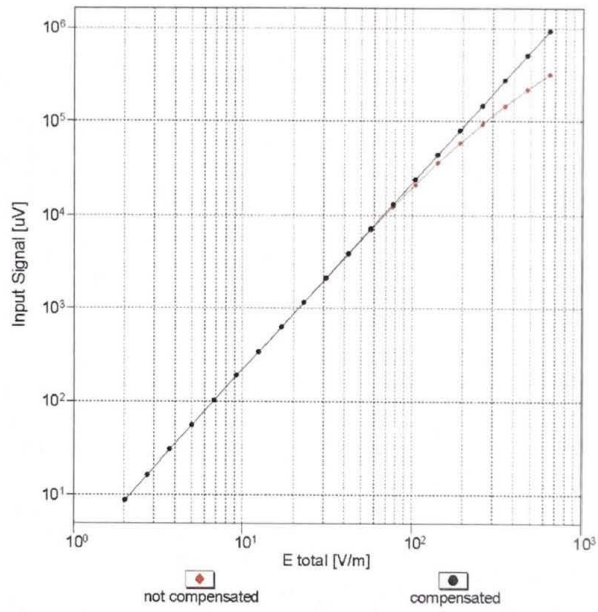

Uncertainty of Linearity Assessment: ± 0.6% (k=2)

ER3DV6 – SN:2424

February 23, 2018

Deviation from Isotropy in Air Error (ϕ, θ), $f = 900$ MHz

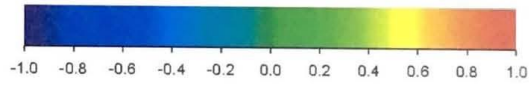
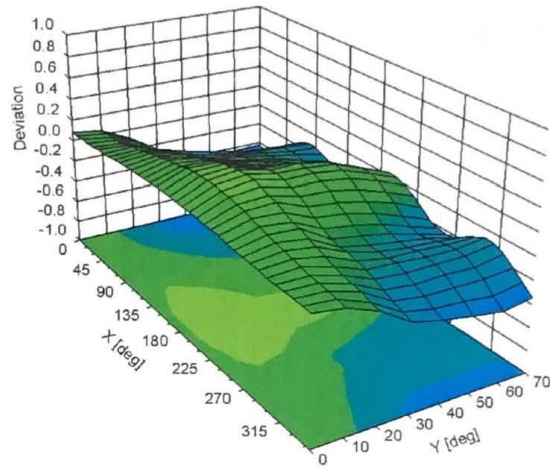

Uncertainty of Spherical Isotropy Assessment: $\pm 2.6\%$ ($k=2$)

ER3DV6 – SN:2424

February 23, 2018

DASY/EASY - Parameters of Probe: ER3DV6 - SN:2424

Other Probe Parameters

| | |
|---|-------------|
| Sensor Arrangement | Rectangular |
| Connector Angle (°) | -11.2 |
| Mechanical Surface Detection Mode | enabled |
| Optical Surface Detection Mode | disabled |
| Probe Overall Length | 337 mm |
| Probe Body Diameter | 10 mm |
| Tip Length | 10 mm |
| Tip Diameter | 8 mm |
| Probe Tip to Sensor X Calibration Point | 2.5 mm |
| Probe Tip to Sensor Y Calibration Point | 2.5 mm |
| Probe Tip to Sensor Z Calibration Point | 2.5 mm |

ANNEX D Dipole Calibration Certificate

Dipole 835 MHz

**Calibration Laboratory of
Schmid & Partner
Engineering AG**
Zeughausstrasse 43, 8004 Zurich, Switzerland



S Schweizerischer Kalibrierdienst
C Service suisse d'étalonnage
S Servizio svizzero di taratura
S Swiss Calibration Service

Accredited by the Swiss Accreditation Service (SAS)
The Swiss Accreditation Service is one of the signatories to the EA
Multilateral Agreement for the recognition of calibration certificates

Accreditation No.: SCS 0108

Client **CTTL (Auden)**

Certificate No: **CD835V3-1165_Jul18**

CALIBRATION CERTIFICATE

Object **CD835V3 - SN: 1165**

Calibration procedure(s) **QA CAL-20.v6
Calibration procedure for dipoles in air**

Calibration date: **July 19, 2018**

This calibration certificate documents the traceability to national standards, which realize the physical units of measurements (SI).
The measurements and the uncertainties with confidence probability are given on the following pages and are part of the certificate.

All calibrations have been conducted in the closed laboratory facility: environment temperature (22 ± 3)°C and humidity < 70%.

Calibration Equipment used (M&TE critical for calibration)

| Primary Standards | ID # | Cal Date (Certificate No.) | Scheduled Calibration |
|---------------------------------|--------------------|-----------------------------------|------------------------|
| Power meter NRP | SN: 104778 | 04-Apr-18 (No. 217-02672/02673) | Apr-19 |
| Power sensor NRP-Z91 | SN: 103244 | 04-Apr-18 (No. 217-02672) | Apr-19 |
| Power sensor NRP-Z91 | SN: 103245 | 04-Apr-18 (No. 217-02673) | Apr-19 |
| Reference 20 dB Attenuator | SN: 5058 (20K) | 04-Apr-18 (No. 217-02682) | Apr-19 |
| Type-N mismatch combination | SN: 5047.2 / 06327 | 04-Apr-18 (No. 217-02683) | Apr-19 |
| Probe EF3DV3 | SN: 4013 | 05-Mar-18 (No. EF3-4013_Mar18) | Mar-19 |
| Probe H3DV6 | SN: 6065 | 30-Dec-17 (No. H3-6065_Dec17) | Dec-18 |
| DAE4 | SN: 781 | 17-Jan-18 (No. DAE4-781_Jan18) | Jan-19 |
| Secondary Standards | ID # | Check Date (in house) | Scheduled Check |
| Power meter Agilent 4419B | SN: GB42420191 | 09-Oct-09 (in house check Oct-17) | In house check: Oct-20 |
| Power sensor HP E4412A | SN: US38485102 | 05-Jan-10 (in house check Oct-17) | In house check: Oct-20 |
| Power sensor HP 8482A | SN: US37295597 | 09-Oct-09 (in house check Oct-17) | In house check: Oct-20 |
| RF generator R&S SMT-06 | SN: 832283/011 | 27-Aug-12 (in house check Oct-17) | In house check: Oct-20 |
| Network Analyzer Agilent E8358A | SN: US41080477 | 31-Mar-14 (in house check Oct-17) | In house check: Oct-18 |

| Calibrated by: | Name | Function | Signature |
|----------------|---------------|-----------------------|-----------|
| | Leif Klysner | Laboratory Technician | |
| Approved by: | Katja Pokovic | Technical Manager | |

Issued: July 19, 2018

This calibration certificate shall not be reproduced except in full without written approval of the laboratory.