



TEST REPORT

No.I18N01882-SAR

For

Yulong Computer Telecommunication Scientific (Shenzhen) Co., Ltd

Mobile Hotspot

Model Name: cp332A

With

Hardware Version: P1

Software Version: 2.0.057.P0.181214.cp332A

FCC ID: R38YLCP332A

Issued Date: 2018-12-28

Designation Number: CN1210

Note:

The test results in this test report relate only to the devices specified in this report. This report shall not be reproduced except in full without the written approval of SAICT.

Test Laboratory:

Shenzhen Academy of Information and Communications Technology
Building G, Shenzhen International Innovation Center, No.1006 Shennan Road, Futian District, Shenzhen,
Guangdong, P. R. China 518026.

Tel: +86(0)755-33322000, Fax: +86(0)755-33322001

Email: yewu@caict.ac.cn, website: www.cszit.com

REPORT HISTORY

Report Number	Revision	Issue Date	Description
I18N01882-SAR	Rev.0	2018-12-28	Initial creation of test report

TABLE OF CONTENT

1 TEST LABORATORY	5
1.1 TESTING LOCATION	5
1.2 TESTING ENVIRONMENT	5
1.3 PROJECT DATA	5
1.4 SIGNATURE	5
2 STATEMENT OF COMPLIANCE	6
3 CLIENT INFORMATION.....	7
3.1 APPLICANT INFORMATION.....	7
3.2 MANUFACTURER INFORMATION	7
4 EQUIPMENT UNDER TEST (EUT) AND ANCILLARY EQUIPMENT (AE)	8
4.1 ABOUT EUT.....	8
4.2 INTERNAL IDENTIFICATION OF EUT USED DURING THE TEST	8
4.3 INTERNAL IDENTIFICATION OF AE USED DURING THE TEST	8
5 TEST METHODOLOGY	9
5.1 APPLICABLE LIMIT REGULATIONS.....	9
5.2 APPLICABLE MEASUREMENT STANDARDS	9
6 SPECIFIC ABSORPTION RATE (SAR).....	10
6.1 INTRODUCTION.....	10
6.2 SAR DEFINITION.....	10
7 TISSUE SIMULATING LIQUIDS	11
7.1 TARGETS FOR TISSUE SIMULATING LIQUID	11
7.2 DIELECTRIC PERFORMANCE	11
8 SYSTEM VERIFICATION.....	15
8.1 SYSTEM SETUP.....	15
8.2 SYSTEM VERIFICATION	16
9 MEASUREMENT PROCEDURES	17
9.1 TESTS TO BE PERFORMED.....	17
9.2 GENERAL MEASUREMENT PROCEDURE	19
9.3 WI-FI MEASUREMENT PROCEDURES FOR SAR	20
9.4 SAR MEASUREMENT FOR LTE.....	20
9.5 LTE (TDD) CONSIDERATIONS.....	21
9.6 POWER DRIFT.....	22
10 AREA SCAN BASED 1-G SAR	23
10.1 REQUIREMENT OF KDB	23
10.2 FAST SAR ALGORITHMS.....	23

11 CONDUCTED OUTPUT POWER.....	24
11.1 LTE MEASUREMENT RESULT	24
11.2 WI-FI MEASUREMENT RESULT	50
12 SIMULTANEOUS TX SAR CONSIDERATIONS	51
12.1 INTRODUCTION.....	51
12.2 TRANSMIT ANTENNA SEPARATION DISTANCES.....	51
12.3 SAR MEASUREMENT POSITIONS.....	51
12.4 STANDALONE SAR TEST EXCLUSION CONSIDERATIONS	52
13 EVALUATION OF SIMULTANEOUS.....	52
14 SAR TEST RESULT	53
14.1 SAR RESULTS.....	54
14.2 WLAN EVALUATION FOR 2.4G.....	59
15 SAR MEASUREMENT VARIABILITY.....	60
16 MEASUREMENT UNCERTAINTY	62
16.1 MEASUREMENT UNCERTAINTY FOR NORMAL SAR TESTS (300MHZ~3GHZ)	62
16.2 MEASUREMENT UNCERTAINTY FOR FAST SAR TESTS (300MHZ~3GHZ)	63
17 MAIN TEST INSTRUMENTS	64
ANNEX A GRAPH RESULTS	65
ANNEX B SYSTEMVERIFICATION RESULTS	76
ANNEX C SAR MEASUREMENT SETUP	83
C.1 MEASUREMENT SET-UP	83
C.2 DASY5 E-FIELD PROBE SYSTEM	84
C.3 E-FIELD PROBE CALIBRATION.....	84
C.4 OTHER TEST EQUIPMENT.....	85
ANNEX D POSITION OF THE WIRELESS DEVICE IN RELATION TO THE PHANTOM.....	89
D.1 BODY-WORN DEVICE	89
D.2 DESKTOP DEVICE.....	89
D.3 DUT SETUP PHOTOS.....	90
ANNEX E EQUIVALENT MEDIA RECIPES.....	91
ANNEX F SYSTEM VALIDATION.....	92
ANNEX G DAE CALIBRATION CERTIFICATE.....	93
ANNEX H PROBE CALIBRATION CERTIFICATE	96
ANNEX I DIPOLE CALIBRATION CERTIFICATE.....	107
ANNEX J EXTENDED CALIBRATION SAR DIPOLE	155

1 Test Laboratory

1.1 Testing Location

Company Name:	Shenzhen Academy of Information and Communications Technology
Address:	Building G, Shenzhen International Innovation Center, No.1006 Shennan Road, Futian District, Shenzhen, Guangdong, P. R. China
Postal Code:	518026
Telephone:	+86-755-33322000
Fax:	+86-755-33322001

1.2 Testing Environment

Temperature:	18°C~25 °C
Relative humidity:	30%~ 70%
Ground system resistance:	<4Ω
Ambient noise & Reflection:	< 0.012 W/kg

1.3 Project Data

Testing Start Date:	December 19, 2018
Testing End Date:	December 24, 2018

1.4 Signature



Li Yongfu

(Prepared this test report)



Zhang Yunzhan

(Reviewed this test report)



Cao Junfei

Deputy Director of the laboratory

(Approved this test report)

2 Statement of Compliance

The maximum results of Specific Absorption Rate (SAR) found during testing for Yulong Computer Telecommunication Scientific (Shenzhen) Co., Ltd Mobile Hotspot cp332A are as follows:

Table 2.1: Highest Reported SAR for Hotspot (1g)

Exposure Configuration	Technology Band	Highest Reported SAR 1g(W/Kg)	Equipment Class
Hotspot (Separation Distance 10 mm)	LTE Band 2	1.18	PCE
	LTE Band 4	1.23	
	LTE Band 5	1.05	
	LTE Band 12	0.81	
	LTE Band 13	0.42	
	LTE Band 25	1.14	
	LTE Band 26	1.06	
	LTE Band 41	0.59	
	LTE Band 66	1.19	
	LTE Band 71	0.30	
	WLAN 2.4G	0.36	DTS

The SAR values found for the Mobile Phone are below the maximum recommended levels of 1.6 W/Kg as averaged over any 1g tissue according to the ANSI C95.1-1992.

For body worn operation, this device has been tested and meets FCC RF exposure guidelines when used with any accessory that contains no metal and which provides a minimum separation distance of 10mm between this device and the body of the user. Use of other accessories may not ensure compliance with FCC RF exposure guidelines.

The EUT battery must be fully charged and checked periodically during the test to ascertain uniform power output.

The measurement together with the test system set-up is described in annex C of this test report. A detailed description of the equipment under test can be found in chapter 4 of this test report.

The highest reported SAR value is obtained at the case of **(Table 2.1)**, and the values are: **1.23W/kg (1g)**.

Table 2.2: The sum of reported SAR values for main antenna and Wi-Fi

/	Position	Main antenna	Wi-Fi	Sum
Highest reported SAR value for Hotspot	Rear	1.23	0.36	1.59

According to the above tables, the highest sum of reported SAR values is **1.59W/kg (1g)**. The detail for simultaneous transmission consideration is described in chapter 13.

3 Client Information

3.1 Applicant Information

Company Name:	Yulong Computer Telecommunication Scientific (Shenzhen) Co., Ltd
Address /Post:	Building B, Boton Science Park, Chaguang Road, Xili Town, Nanshan District, Shenzhen
Contact:	Yentl Chen
Email:	chenyanting@yulong.com
Telephone:	+86 15927320221
Fax:	/

3.2 Manufacturer Information

Company Name:	Yulong Computer Telecommunication Scientific (Shenzhen) Co., Ltd
Address /Post:	Building B, Boton Science Park, Chaguang Road, Xili Town, Nanshan District, Shenzhen
Contact:	Yentl Chen
Email:	chenyanting@yulong.com
Telephone:	+86 15927320221
Fax:	/

4 Equipment under Test (EUT) and Ancillary Equipment (AE)

4.1 About EUT

Description:	Mobile Hotspot
Model Name:	cp332A
Condition of EUT as received	No obvious damage in appearance
Operating mode(s):	LTE Band 2/4/5/12/13/25/26/41/66/71, Wi-Fi 2.4G.
Tested Tx Frequency:	1850.7 – 1909.3MHz (LTE_FDD Band 2)
	1710.7 – 1754.3MHz (LTE_FDD Band 4)
	824.7 – 848.3MHz (LTE_FDD Band 5)
	699.7 – 715.3MHz (LTE_FDD Band 12)
	779.5 – 784.5MHz (LTE_FDD Band 13)
	1850.7 – 1914.3MHz (LTE_FDD Band 25)
	814.7 – 848.3MHz (LTE_FDD Band 26)
	2498.5 – 2687.5MHz (LTE_TDD Band 41)
	1710.7 – 1779.3MHz (LTE_FDD Band 66)
	665.5 – 695.5MHz (LTE_FDD Band 71)
2412 – 2462MHz (Wi-Fi 2.4G)	
Test device Production information:	Production unit
Device type:	Portable device
Antenna type:	Integrated antenna
Hotspot mode:	Support

4.2 Internal Identification of EUT used during the test

EUT ID*	IMEI	HW Version	SW Version
EUT1	867695040000712	P1	2.0.057.P0.181214.cp332A
EUT2	867695040000514	P1	2.0.057.P0.181214.cp332A

*EUT ID: is used to identify the test sample in the lab internally.

Note: It is performed to test SAR with the EUT 1, and conducted power with the EUT 2.

4.3 Internal Identification of AE used during the test

AE ID*	Description	Type	Manufacturer
AE1	Battery	Li-ion	LISHEN

*AE ID: is used to identify the test sample in the lab internally.

5 Test Methodology

5.1 Applicable Limit Regulations

ANSI C95.1–1992: IEEE Standard for Safety Levels with Respect to Human Exposure to Radio Frequency Electromagnetic Fields, 3 kHz to 300 GHz.

It specifies the maximum exposure limit of **1.6 W/kg** as averaged over any 1 gram of tissue for portable devices being used within 20 cm of the user in the uncontrolled environment.

5.2 Applicable Measurement Standards

IEEE 1528–2013: Recommended Practice for Determining the Peak Spatial-Average Specific Absorption Rate (SAR) in the Human Head from Wireless Communications Devices: Experimental Techniques.

KDB 447498 D01 General RF Exposure Guidance v06: Mobile and Portable Devices RF Exposure Procedures and Equipment Authorization Policies.

KDB941225 D05 SAR for LTE Devices v02r05: SAR Evaluation Considerations for LTE Devices

KDB 941225 D06 Hot Spot SAR v02r01: SAR Evaluation Procedures for Portable Devices with Wireless Router Capabilities

KDB 248227 D01 802.11 Wi-Fi SAR v02r02: SAR Guidance for IEEE 802.11 (Wi-Fi) Transmitters.

KDB 865664 D01 SAR measurement 100 MHz to 6 GHz v01r04: SAR Measurement Requirements for 100 MHz to 6 GHz.

KDB 865664 D02 RF Exposure Reporting v01r02: RF Exposure Compliance Reporting and Documentation Considerations

6 Specific Absorption Rate (SAR)

6.1 Introduction

SAR is related to the rate at which energy is absorbed per unit mass in an object exposed to a radio field. The SAR distribution in a biological body is complicated and is usually carried out by experimental techniques or numerical modeling. The standard recommends limits for two tiers of groups, occupational/controlled and general population/uncontrolled, based on a person's awareness and ability to exercise control over his or her exposure. In general, occupational/controlled exposure limits are higher than the limits for general population/uncontrolled.

6.2 SAR Definition

The SAR definition is the time derivative (rate) of the incremental energy (dW) absorbed by (dissipated in) an incremental mass (dm) contained in a volume element (dv) of a given density (ρ). The equation description is as below:

$$SAR = \frac{d}{dt} \left(\frac{dW}{dm} \right) = \frac{d}{dt} \left(\frac{dW}{\rho dv} \right)$$

SAR is expressed in units of Watts per kilogram (W/kg)

SAR measurement can be either related to the temperature elevation in tissue by

$$SAR = c \left(\frac{\delta T}{\delta t} \right)$$

Where: C is the specific heat capacity, δT is the temperature rise and δt is the exposure duration, or related to the electrical field in the tissue by

$$SAR = \frac{\sigma |E|^2}{\rho}$$

Where: σ is the conductivity of the tissue, ρ is the mass density of tissue and E is the RMS electrical field strength.

However for evaluating SAR of low power transmitter, electrical field measurement is typically applied.

7 Tissue Simulating Liquids

7.1 Targets for tissue simulating liquid

Table 7.1: Targets for tissue simulating liquid

Frequency (MHz)	Liquid Type	Conductivity (σ)	$\pm 5\%$ Range	Permittivity (ϵ)	$\pm 5\%$ Range
750	Body	0.96	0.91~1.01	55.50	52.7~58.3
835	Body	0.97	0.92~1.02	55.20	52.4~58.0
1750	Body	1.49	1.42~1.56	53.40	50.7~56.1
1900	Body	1.52	1.44~1.60	53.30	50.6~56.0
2450	Body	1.95	1.85~2.05	52.70	50.1~55.3
2550	Body	2.09	1.99~2.19	52.60	50.0~55.2

7.2 Dielectric Performance

Table 7.2: Dielectric Performance of Tissue Simulating Liquid

Measurement Date (yyyy-mm-dd)	Type	Frequency	Conductivity σ (S/m)	Drift (%)	Permittivity ϵ	Drift (%)
2018-12-20	Body	750	0.955	-0.52	53.94	-2.81
2018-12-20	Body	835	0.982	1.24	53.49	-3.10
2018-12-19	Body	1750	1.468	-1.48	53.16	-0.45
2018-12-19	Body	1900	1.566	3.03	52.68	-1.16
2018-12-24	Body	2450	1.925	-1.28	51.44	-2.39
2018-12-22	Body	2550	2.044	-2.20	51.25	-2.57

Note: The liquid temperature is 22.0°C.

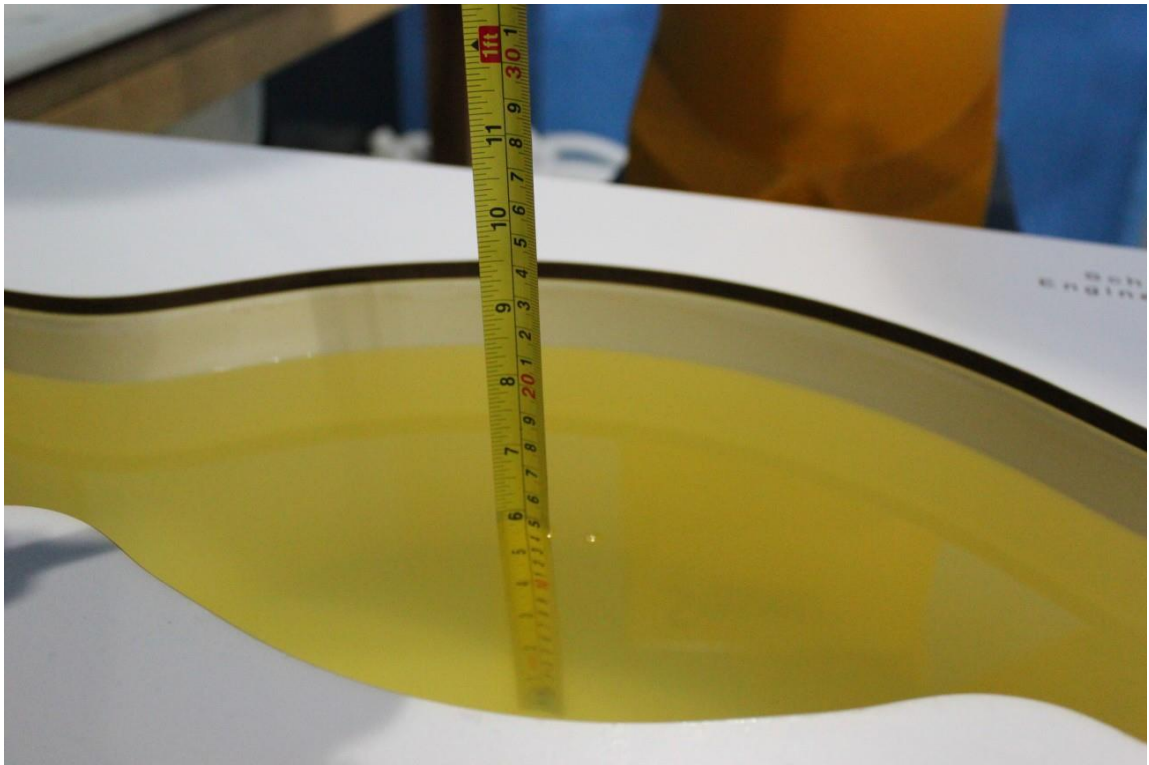

Picture 7-1: Liquid depth in the Flat Phantom (750 MHz)



Picture 7-2: Liquid depth in the Flat Phantom (835 MHz)

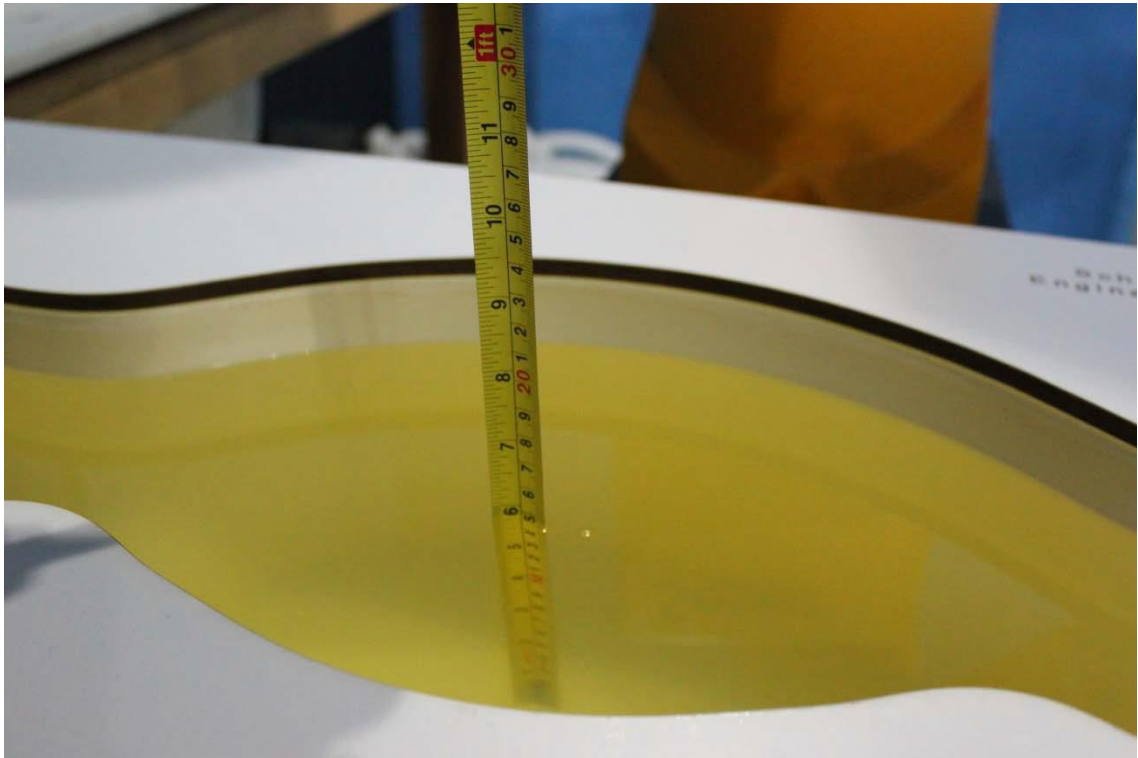

Picture 7-3: Liquid depth in the Flat Phantom (1750 MHz)

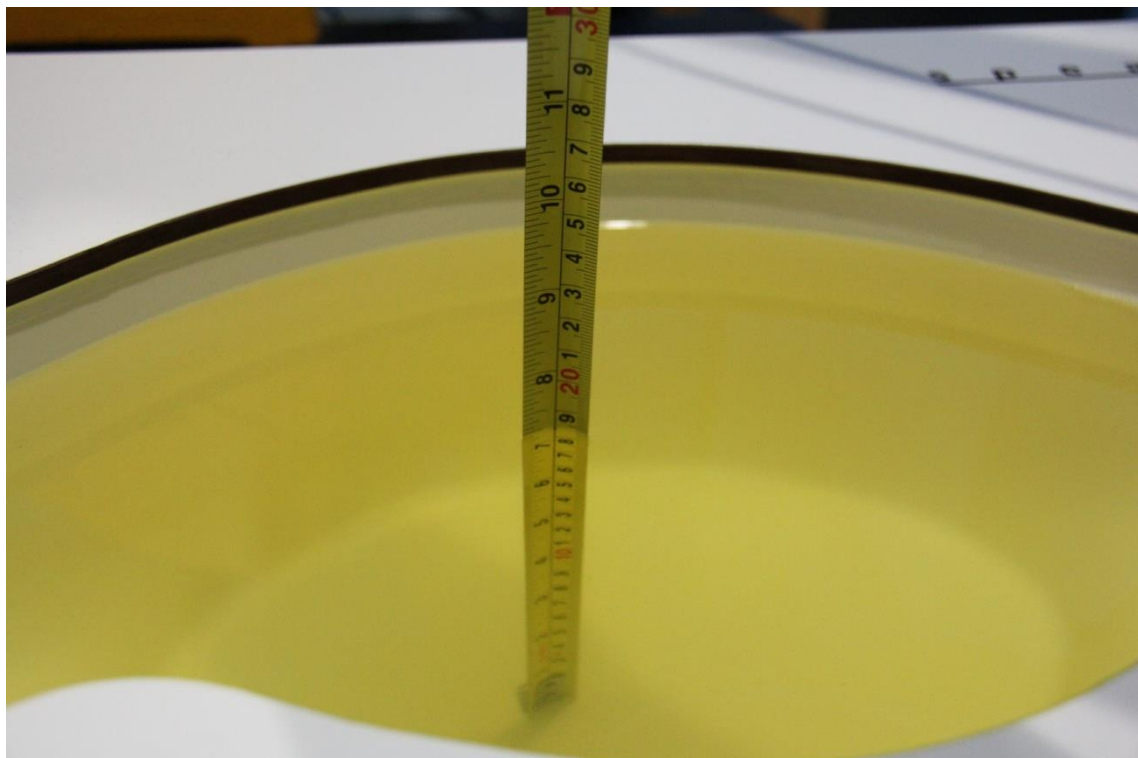

Picture 7-4: Liquid depth in the Flat Phantom (1900MHz)



Picture 7-5: Liquid depth in the Flat Phantom(2450MHz)



Picture 7-6: Liquid depth in the Flat Phantom(2550MHz)

8 System verification

8.1 System Setup

In the simplified setup for system evaluation, the DUT is replaced by a calibrated dipole and the power source is replaced by a continuous wave that comes from a signal generator. The calibrated dipole must be placed beneath the flat phantom section of the SAM twin phantom with the correct distance holder. The distance holder should touch the phantom surface with a light pressure at the reference marking and be oriented parallel to the long side of the phantom. The equipment setup is shown below:

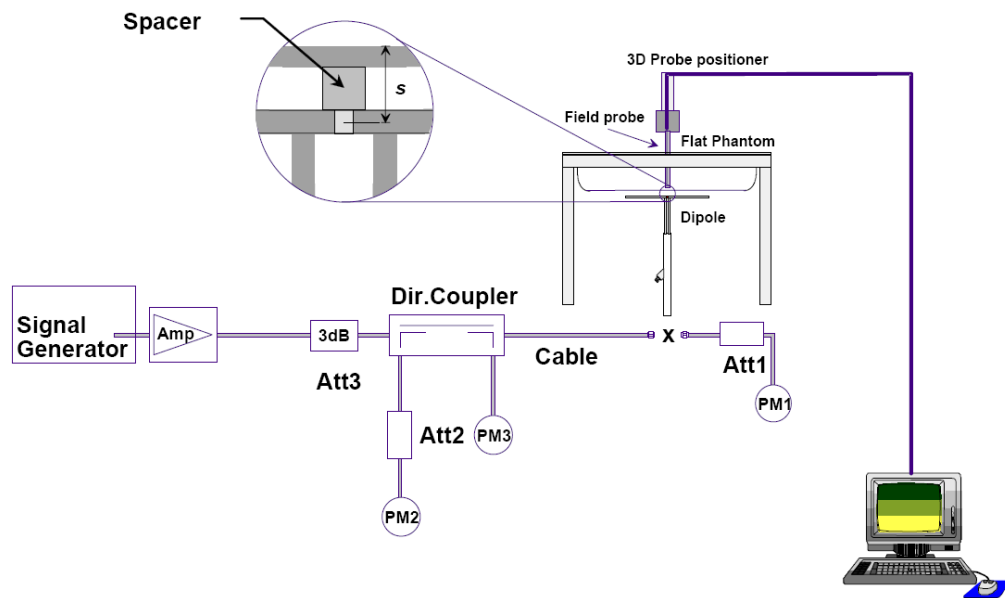

Picture 8.1 System Setup for System Evaluation

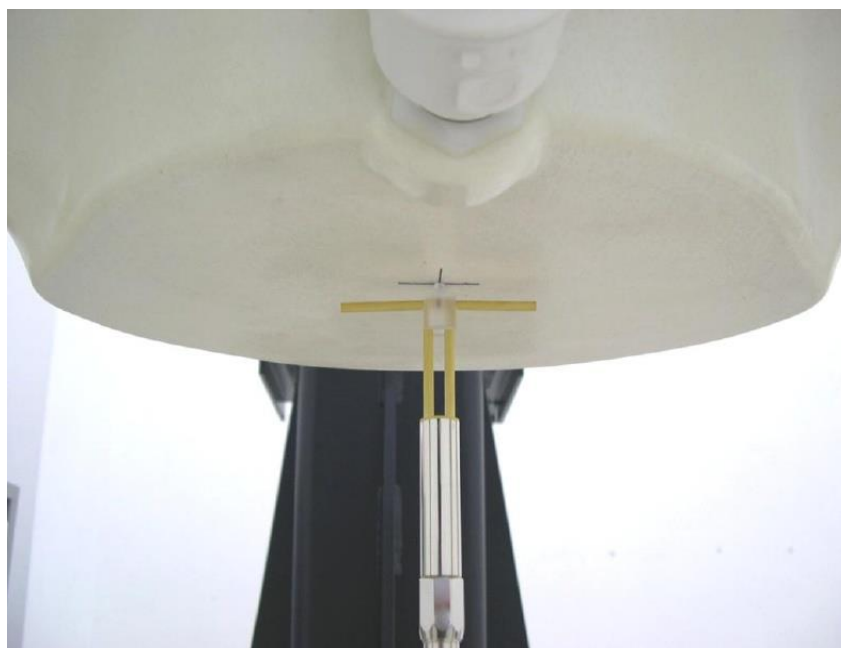

Picture 8.2 Photo of Dipole Setup

8.2 System Verification

SAR system verification is required to confirm measurement accuracy, according to the tissue dielectric media, probe calibration points and other system operating parameters required for measuring the SAR of a test device. The system verification must be performed for each frequency band and within the valid range of each probe calibration point required for testing the device.

The system verification results are required that the area scan estimated 1-g SAR is within 3% of the zoom scan 1-g SAR. The details are presented in annex B.

Table 8.1: System Verification of Body

Measurement Date (yyyy-mm-dd)	Frequency	Target value (W/kg)		Measured value (W/kg)		Deviation (%)	
		10 g Average	1 g Average	10 g Average	1 g Average	10 g Average	1 g Average
2018-12-20	750 MHz	5.64	8.58	5.48	8.28	-2.84	-3.50
2018-12-20	835 MHz	6.56	9.90	6.76	10.32	3.05	4.24
2018-12-19	1750 MHz	19.5	36.2	19.12	35.04	-1.95	-3.20
2018-12-19	1900 MHz	21.4	40.6	21.84	42.00	2.06	3.45
2018-12-24	2450 MHz	23.5	50.5	23.24	49.20	-1.11	-2.57
2018-12-22	2550 MHz	24.7	54.0	24.32	52.80	-1.54	-2.22

9 Measurement Procedures

9.1 Tests to be performed

In order to determine the highest value of the peak spatial-average SAR of a handset, all device positions, configurations and operational modes shall be tested for each frequency band according to steps 1 to 3 below. A flowchart of the test process is shown in picture 9.1.

Step 1: The tests described in 9.2 shall be performed at the channel that is closest to the center of the transmit frequency band (f_c) for:

- a) all device positions (cheek and tilt, for both left and right sides of the SAM phantom, as described in annex D),
- b) all configurations for each device position in a), e.g., antenna extended and retracted, and
- c) all operational modes, e.g., analogue and digital, for each device position in a) and configuration in b) in each frequency band.

If more than three frequencies need to be tested according to 11.1 (i.e., $N_c > 3$), then all frequencies, configurations and modes shall be tested for all of the above test conditions.

Step 2: For the condition providing highest peak spatial-average SAR determined in Step 1, perform all tests described in 9.2 at all other test frequencies, i.e., lowest and highest frequencies. In addition, for all other conditions (device position, configuration and operational mode) where the peak spatial-average SAR value determined in Step 1 is within 3 dB of the applicable SAR limit, it is recommended that all other test frequencies shall be tested as well.

Step 3: Examine all data to determine the highest value of the peak spatial-average SAR found in Steps 1 to 2.

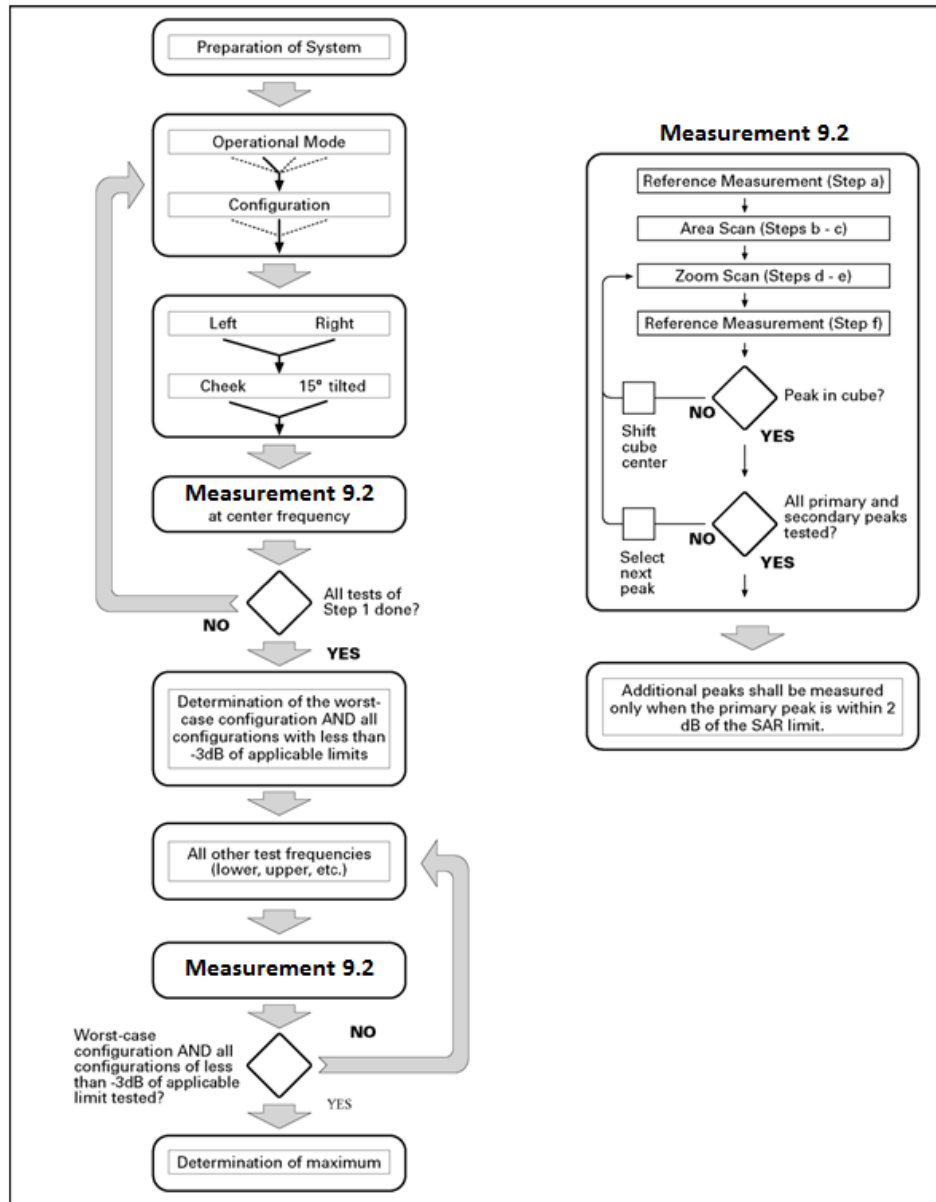

Picture 9.1 Block diagram of the tests to be performed

9.2 General Measurement Procedure

The area and zoom scan resolutions specified in the table below must be applied to the SAR measurements and fully documented in SAR reports to qualify for TCB approval. Probe boundary effect error compensation is required for measurements with the probe tip closer than half a probe tip diameter to the phantom surface. Both the probe tip diameter and sensor offset distance must satisfy measurement protocols; to ensure probe boundary effect errors are minimized and the higher fields closest to the phantom surface can be correctly measured and extrapolated to the phantom surface for computing 1-g SAR. Tolerances of the post-processing algorithms must be verified by the test laboratory for the scan resolutions used in the SAR measurements, according to the reference distribution functions specified in IEEE Std 1528-2013. The results should be documented as part of the system validation records and may be requested to support test results when all the measurement parameters in the following table are not satisfied.

		≤ 3 GHz	> 3 GHz	
Maximum distance from closest measurement point (geometric center of probe sensors) to phantom surface		5 ± 1 mm	$\frac{1}{2} \cdot \delta \cdot \ln(2) \pm 0.5$ mm	
Maximum probe angle from probe axis to phantom surface normal at the measurement location		$30^\circ \pm 1^\circ$	$20^\circ \pm 1^\circ$	
Maximum area scan spatial resolution: $\Delta x_{Area}, \Delta y_{Area}$		≤ 2 GHz: ≤ 15 mm 2 – 3 GHz: ≤ 12 mm	3 – 4 GHz: ≤ 12 mm 4 – 6 GHz: ≤ 10 mm	
		When the x or y dimension of the test device, in the measurement plane orientation, is smaller than the above, the measurement resolution must be \leq the corresponding x or y dimension of the test device with at least one measurement point on the test device.		
Maximum zoom scan spatial resolution: $\Delta x_{Zoom}, \Delta y_{Zoom}$		≤ 2 GHz: ≤ 8 mm 2 – 3 GHz: ≤ 5 mm*	3 – 4 GHz: ≤ 5 mm* 4 – 6 GHz: ≤ 4 mm*	
Maximum zoom scan spatial resolution, normal to phantom surface	uniform grid: $\Delta z_{Zoom}(n)$	≤ 5 mm	3 – 4 GHz: ≤ 4 mm 4 – 5 GHz: ≤ 3 mm 5 – 6 GHz: ≤ 2 mm	
	graded grid	$\Delta z_{Zoom}(1)$: between 1 st two points closest to phantom surface	≤ 4 mm	3 – 4 GHz: ≤ 3 mm 4 – 5 GHz: ≤ 2.5 mm 5 – 6 GHz: ≤ 2 mm
		$\Delta z_{Zoom}(n>1)$: between subsequent points	$\leq 1.5 \cdot \Delta z_{Zoom}(n-1)$	
Minimum zoom scan volume	x, y, z	≥ 30 mm	3 – 4 GHz: ≥ 28 mm 4 – 5 GHz: ≥ 25 mm 5 – 6 GHz: ≥ 22 mm	
<p>Note: δ is the penetration depth of a plane-wave at normal incidence to the tissue medium; see draft standard IEEE P1528-2011 for details.</p> <p>* When zoom scan is required and the reported SAR from the area scan based 1-g SAR estimation procedures of KDB 447498 is ≤ 1.4 W/kg, ≤ 8 mm, ≤ 7 mm and ≤ 5 mm zoom scan resolution may be applied, respectively, for 2 GHz to 3 GHz, 3 GHz to 4 GHz and 4 GHz to 6 GHz.</p>				

9.3 WI-FI Measurement Procedures for SAR

Normal network operating configurations are not suitable for measuring the SAR of 802.11 transmitters in general. Unpredictable fluctuations in network traffic and antenna diversity conditions can introduce undesirable variations in SAR results. The SAR for these devices should be measured using chipset based test mode software to ensure that the results are consistent and reliable.

Chipset based test mode software is hardware dependent and generally varies among manufacturers. The device operating parameters established in a test mode for SAR measurements must be identical to those programmed in production units, including output power levels, amplifier gain settings and other RF performance tuning parameters. The test frequencies should correspond to actual channel frequencies defined for domestic use. SAR for devices with switched diversity should be measured with only one antenna transmitting at a time during each SAR measurement, according to a fixed modulation and data rate. The same data pattern should be used for all measurements.

9.4 SAR Measurement for LTE

SAR tests for LTE are performed with a base station simulator, Anristu MT8820C. Closed loop power control was used so the UE transmits with maximum output power during SAR testing. All powers were measured with the Anristu MT8820C. It is performed for conducted power and SAR based on the KDB941225 D05.

SAR is evaluated separately according to the following procedures for the different test positions in each exposure condition – head, body, body-worn accessories and other use conditions. The procedures in the following subsections are applied separately to test each LTE frequency band.

1) QPSK with 1 RB allocation

Start with the largest channel bandwidth and measure SAR for QPSK with 1 RB allocation, using the RB offset and required test channel combination with the highest maximum output power among RB offsets at the upper edge, middle and lower edge of each required test channel. When the reported SAR is ≤ 0.8 W/kg, testing of the remaining RB offset configurations and required test channels is not required for 1 RB allocation; otherwise, SAR is required for the remaining required test channels and only for the RB offset configuration with the highest output power for that channel. When the reported SAR of a required test channel is > 1.45 W/kg, SAR is required for all three RB offset configurations for that required test channel.

2) QPSK with 50% RB allocation

The procedures required for 1 RB allocation in 1) are applied to measure the SAR for QPSK with 50% RB allocation.

3) QPSK with 100% RB allocation

For QPSK with 100% RB allocation, SAR is not required when the highest maximum output power for 100 % RB allocation is less than the highest maximum output power in 50% and 1 RB allocations and the highest reported SAR for 1 RB and 50% RB allocation in 1) and 2) are ≤ 0.8 W/kg. Otherwise, SAR is measured for the highest output power channel; and if the reported SAR is > 1.45 W/kg, the remaining required test channels must also be tested.

9.5 LTE (TDD) Considerations

According to KDB 941225 D05 SAR for LTE Devices, for Time-Division Duplex (TDD) systems, SAR must be tested using a fixed periodic duty factor according to the highest transmission duty factor implemented for the device and supported by the defined 3GPP LTE TDD configurations.

SAR was tested with the highest transmission duty factor (63.33%) using Uplink-downlink configuration 0 and Special subframe configuration 7.

LTE TDD Band 38 and LTE TDD Band 40 support 3GPP TS 36.211 section 4.2 for Type 2 Frame Structure and Table 4.2-2 for uplink-downlink configurations and Table 4.2-1 for Special subframe configurations.

Special subframe configuration	Normal cyclic prefix in downlink			Extended cyclic prefix in downlink		
	DwPTS	UpPTS		DwPTS	UpPTS	
		Normal cyclic prefix in uplink	Extended cyclic prefix in uplink		Normal cyclic prefix in uplink	Extended cyclic prefix in uplink
0	$6592 \cdot T_s$	$2192 \cdot T_s$	$2560 \cdot T_s$	$7680 \cdot T_s$	$2192 \cdot T_s$	$2560 \cdot T_s$
1	$19760 \cdot T_s$			$20480 \cdot T_s$		
2	$21952 \cdot T_s$			$23040 \cdot T_s$		
3	$24144 \cdot T_s$			$25600 \cdot T_s$		
4	$26336 \cdot T_s$			$7680 \cdot T_s$		
5	$6592 \cdot T_s$	$4384 \cdot T_s$	$5120 \cdot T_s$	$20480 \cdot T_s$	$4384 \cdot T_s$	$5120 \cdot T_s$
6	$19760 \cdot T_s$			$23040 \cdot T_s$		
7	$21952 \cdot T_s$			$12800 \cdot T_s$		
8	$24144 \cdot T_s$			-		
9	$13168 \cdot T_s$			-		

Configuration of special subframe (lengths of DwPTS/GP/UpPTS)

Uplink-Downlink Configuration	Downlink-to-Uplink Switch-point Periodicity	Subframe Number										Calculated Duty Cycle (%)
		0	1	2	3	4	5	6	7	8	9	
0	5 ms	D	S	U	U	U	D	S	U	U	U	63.33
1	5 ms	D	S	U	U	D	D	S	U	U	D	43.33
2	5 ms	D	S	U	D	D	D	S	U	D	D	23.33
3	10 ms	D	S	U	U	U	D	D	D	D	D	31.67
4	10 ms	D	S	U	U	D	D	D	D	D	D	21.67
5	10 ms	D	S	U	D	D	D	D	D	D	D	11.67
6	5 ms	D	S	U	U	U	D	S	U	U	D	53.33

Calculated Duty Cycle

Calculated Duty Cycle = Extended cyclic prefix in uplink x (Ts) x # of S + # of U

Example for Calculated Duty Cycle for Uplink-Downlink Configuration 0:

Calculated Duty Cycle = $5120 \times [1/(15000 \times 2048)] \times 2 + 6 \text{ ms} = 63.33\%$

Where

$T_s = 1/(15000 \times 2048)$ seconds

9.6 Power Drift

To control the output power stability during the SAR test, DASY5 system calculates the power drift by measuring the E-field at the same location at the beginning and at the end of the measurement for each test position. These drift values can be found in Section 14 labeled as: (Power Drift [dB]). This ensures that the power drift during one measurement is within 5%.

10 Area Scan Based 1-g SAR

10.1 Requirement of KDB

According to the KDB447498 D01, when the implementation is based the specific polynomial fit algorithm as presented at the 29th Bioelectromagnetics Society meeting (2007) and the estimated 1-gSAR is ≤ 1.2 W/kg, a zoom scan measurement is not required provided it is also not needed for any other purpose; for example, if the peak SAR location required for simultaneous transmission SAR test exclusion can be determined accurately by the SAR system or manually to discriminate between distinctive peaks and scattered noisy SAR distributions from area scans.

There must not be any warning or alert messages due to various measurement concerns identified by the SAR system; for example, noise in measurements, peaks too close to scan boundary, peaks are too sharp, spatial resolution and uncertainty issues etc. The SAR system verification must also demonstrate that the area scan estimated 1-g SAR is within 3% of the zoom scan 1-g SAR (See Annex B). When all the SAR results for each exposure condition in a frequency band and wireless mode are based on estimated 1-g SAR, the 1-g SAR for the highest SAR configuration must be determined by a zoom scan.

10.2 Fast SAR Algorithms

The approach is based on the area scan measurement applying a frequency dependent attenuation parameter. This attenuation parameter was empirically determined by analyzing a large number of phones. The MOTOROLA FAST SAR was developed and validated by the MOTOROLA Research Group in Ft. Lauderdale.

In the initial study, an approximation algorithm based on Linear fit was developed. The accuracy of the algorithm has been demonstrated across a broad frequency range (136-2450 MHz) and for both 1- and 10-g averaged SAR using a sample of 264 SAR measurements from 55 wireless handsets. For the sample size studied, the root-mean-squared errors of the algorithm are 1.2% and 5.8% for 1- and 10-g averaged SAR, respectively. The paper describing the algorithm in detail is expected to be published in August 2004 within the Special Issue of Transactions on MTT.

In the second step, the same research group optimized the fitting algorithm to an Polynomial fit whereby the frequency validity was extended to cover the range 30-6000MHz. Details of this study can be found in the BEMS 2007 Proceedings.

Both algorithms are implemented in DASY software.

11 Conducted Output Power

11.1 LTE Measurement result

Table 11.1: The conducted Power measurement results for LTE

LTE-FDD Band 2				Actual output Power (dBm)			Tune up
Band-width	RB allocation	RB offset	Modulation	High	Middle	Low	
1.4 MHz				1909.3MHz	1880MHz	1850.7MHz	
	1RB	High	QPSK	21.23	21.24	21.33	22.5
			16QAM	20.22	20.17	20.20	21.5
		Middle	QPSK	21.25	21.21	21.35	22.5
			16QAM	20.33	20.49	20.31	21.5
		Low	QPSK	21.44	21.27	21.35	22.5
			16QAM	20.25	20.25	20.24	21.5
	3RB	High	QPSK	21.55	21.35	21.46	22.5
			16QAM	20.62	20.18	20.33	21.5
		Middle	QPSK	21.51	21.42	21.60	22.5
			16QAM	20.64	20.32	20.34	21.5
		Low	QPSK	21.51	21.41	21.46	22.5
			16QAM	20.57	20.31	20.26	21.5
	6RB	/	QPSK	20.47	20.20	20.44	21.5
16QAM			19.37	19.30	19.28	20.5	
3 MHz				1908.5MHz	1880MHz	1851.5MHz	/
	1RB	High	QPSK	21.51	21.23	21.19	22.5
			16QAM	20.21	20.18	20.07	21.5
		Middle	QPSK	21.70	21.44	21.51	22.5
			16QAM	20.16	20.33	19.98	21.5
		Low	QPSK	21.51	21.23	21.26	22.5
			16QAM	20.12	20.19	20.16	21.5
	8RB	High	QPSK	20.42	20.37	20.32	21.5
			16QAM	19.53	19.39	19.41	20.5
		Middle	QPSK	20.35	20.28	20.42	21.5
			16QAM	19.60	19.50	19.46	20.5
		Low	QPSK	20.40	20.25	20.42	21.5
			16QAM	19.61	19.46	19.46	20.5
	15RB	/	QPSK	20.50	20.26	20.38	21.5
16QAM			19.57	19.32	19.33	20.5	

LTE-FDD Band 2				Actual output Power (dBm)			Tune up
Band-width	RB allocation	RB offset	Modulation	High	Middle	Low	
5 MHz				1907.5MHz	1880MHz	1852.5MHz	
	1RB	High	QPSK	21.45	21.37	21.23	22.5
			16QAM	20.10	20.06	20.04	21.5
		Middle	QPSK	21.57	21.23	21.28	22.5
			16QAM	20.00	20.11	20.02	21.5
		Low	QPSK	21.46	21.15	21.26	22.5
			16QAM	20.11	20.06	20.08	21.5
	12RB	High	QPSK	20.41	20.34	20.28	21.5
			16QAM	19.34	19.27	19.14	20.5
		Middle	QPSK	20.46	20.34	20.23	21.5
			16QAM	19.44	19.31	19.17	20.5
		Low	QPSK	20.45	20.22	20.21	21.5
			16QAM	19.31	19.38	19.36	20.5
	25RB	/	QPSK	20.52	20.28	20.18	21.5
16QAM			19.45	19.35	19.26	20.5	
10 MHz				1905MHz	1880MHz	1855MHz	/
	1RB	High	QPSK	21.34	21.40	21.33	22.5
			16QAM	20.43	20.18	20.30	21.5
		Middle	QPSK	21.48	21.55	21.41	22.5
			16QAM	20.87	20.34	20.27	21.5
		Low	QPSK	21.43	21.38	21.32	22.5
			16QAM	20.26	20.06	20.31	21.5
	25RB	High	QPSK	20.31	20.25	20.34	21.5
			16QAM	19.46	19.41	19.38	20.5
		Middle	QPSK	20.43	20.31	20.44	21.5
			16QAM	19.51	19.45	19.46	20.5
		Low	QPSK	20.41	20.33	20.31	21.5
			16QAM	19.45	19.37	19.56	20.5
	50RB	/	QPSK	20.39	20.29	20.39	21.5
16QAM			19.63	19.41	19.42	20.5	

LTE-FDD Band 2				Actual output Power (dBm)			Tune up
Band-width	RB allocation	RB offset	Modulation	High	Middle	Low	
15 MHz				1902.5MHz	1880MHz	1857.5MHz	
	1RB	High	QPSK	21.50	21.50	21.10	22.5
			16QAM	20.24	20.14	20.13	21.5
		Middle	QPSK	21.55	21.33	21.55	22.5
			16QAM	20.40	20.30	20.20	21.5
		Low	QPSK	21.30	21.23	21.32	22.5
			16QAM	20.26	20.08	20.27	21.5
	36RB	High	QPSK	20.43	20.41	20.41	21.5
			16QAM	19.32	19.23	19.34	20.5
		Middle	QPSK	20.56	20.44	20.45	21.5
			16QAM	19.39	19.35	19.36	20.5
		Low	QPSK	20.37	20.33	20.49	21.5
			16QAM	19.36	19.28	19.30	20.5
	75RB	/	QPSK	20.54	20.30	20.41	21.5
16QAM			19.53	19.38	19.38	20.5	
20 MHz				1900MHz	1880MHz	1860MHz	/
	1RB	High	QPSK	21.57	21.29	21.27	22.5
			16QAM	20.20	20.35	20.13	21.5
		Middle	QPSK	21.75	21.55	21.55	22.5
			16QAM	20.72	20.49	20.63	21.5
		Low	QPSK	21.63	21.42	21.39	22.5
			16QAM	20.31	20.33	20.30	21.5
	50RB	High	QPSK	20.58	20.55	20.44	21.5
			16QAM	19.49	19.58	19.49	20.5
		Middle	QPSK	20.72	20.61	20.55	21.5
			16QAM	19.64	19.43	19.63	20.5
		Low	QPSK	20.61	20.59	20.47	21.5
			16QAM	19.64	19.55	19.51	20.5
	100RB	/	QPSK	20.53	20.64	20.46	21.5
16QAM			19.54	19.47	19.44	20.5	

LTE-FDD Band 4				Actual output Power (dBm)			Tune up
Band-width	RB allocation	RB offset	Modulation	High	Middle	Low	
1.4 MHz				1754.3MHz	1732.5MHz	1710.7MHz	
	1RB	High	QPSK	20.85	20.64	20.68	21.5
			16QAM	19.59	19.58	19.54	20.5
		Middle	QPSK	20.80	20.73	20.72	21.5
			16QAM	19.77	19.68	19.59	20.5
		Low	QPSK	20.87	20.70	20.66	21.5
			16QAM	19.60	19.54	19.47	20.5
	3RB	High	QPSK	21.00	20.69	20.75	21.5
			16QAM	19.72	19.40	19.80	20.5
		Middle	QPSK	21.01	20.63	20.76	21.5
			16QAM	19.77	19.46	19.90	20.5
		Low	QPSK	20.85	20.60	20.78	21.5
			16QAM	19.71	19.45	19.99	20.5
	6RB	/	QPSK	19.74	19.59	19.59	20.5
16QAM			18.65	18.43	18.68	19.5	
3 MHz				1753.5MHz	1732.5MHz	23.95	23.34
	1RB	High	QPSK	20.90	20.45	20.54	21.5
			16QAM	19.57	19.49	19.46	20.5
		Middle	QPSK	20.94	20.57	20.84	21.5
			16QAM	19.58	19.43	19.44	20.5
		Low	QPSK	20.87	20.44	20.64	21.5
			16QAM	19.54	19.48	19.41	20.5
	8RB	High	QPSK	19.81	19.61	19.69	20.5
			16QAM	18.78	18.51	18.40	19.5
		Middle	QPSK	19.75	19.59	19.70	20.5
			16QAM	18.83	18.50	18.52	19.5
		Low	QPSK	19.70	19.61	19.63	20.5
			16QAM	18.78	18.71	18.40	19.5
	15RB	/	QPSK	19.69	19.55	19.74	20.5
16QAM			18.63	18.62	18.51	19.5	

LTE-FDD Band 4				Actual output Power (dBm)			Tune up
Band-width	RB allocation	RB offset	Modulation	High	Middle	Low	
5 MHz				1752.5MHz	1732.5MHz	1712.5MHz	
	1RB	High	QPSK	20.76	20.40	20.40	21.5
			16QAM	19.64	19.39	19.35	20.5
		Middle	QPSK	20.94	20.51	20.72	21.5
			16QAM	19.56	19.73	19.43	20.5
		Low	QPSK	20.79	20.41	20.62	21.5
			16QAM	19.59	19.42	19.37	20.5
	12RB	High	QPSK	19.87	19.55	19.69	20.5
			16QAM	18.84	18.68	18.50	19.5
		Middle	QPSK	19.80	19.58	19.60	20.5
			16QAM	18.81	18.70	18.68	19.5
		Low	QPSK	19.72	19.61	19.65	20.5
			16QAM	18.62	18.68	18.52	19.5
	25RB	/	QPSK	19.83	19.51	19.52	20.5
16QAM			18.99	18.62	18.40	19.5	
10 MHz				1750MHz	1732.5MHz	1715MHz	/
	1RB	High	QPSK	20.89	20.52	20.42	21.5
			16QAM	19.58	19.33	19.46	20.5
		Middle	QPSK	20.80	20.71	20.80	21.5
			16QAM	19.56	19.46	19.48	20.5
		Low	QPSK	20.63	20.48	20.33	21.5
			16QAM	19.04	18.90	19.44	20.5
	25RB	High	QPSK	19.74	19.65	19.59	20.5
			16QAM	18.82	18.48	18.68	19.5
		Middle	QPSK	19.82	19.65	19.70	20.5
			16QAM	19.07	18.59	18.65	19.5
		Low	QPSK	19.77	19.59	19.65	20.5
			16QAM	18.89	18.47	18.74	19.5
	50RB	/	QPSK	19.76	19.52	19.62	20.5
16QAM			18.68	18.43	18.59	19.5	

LTE-FDD Band 4				Actual output Power (dBm)			Tune up
Band-width	RB allocation	RB offset	Modulation	High	Middle	Low	
15 MHz				1747.5MHz	1732.5MHz	1717.5MHz	
	1RB	High	QPSK	20.88	20.42	20.37	21.5
			16QAM	19.60	19.44	19.36	20.5
		Middle	QPSK	20.77	20.57	20.75	21.5
			16QAM	19.71	19.64	19.53	20.5
		Low	QPSK	20.86	20.38	20.48	21.5
			16QAM	19.64	19.41	19.47	20.5
	36RB	High	QPSK	19.66	19.57	19.51	20.5
			16QAM	18.75	18.71	18.54	19.5
		Middle	QPSK	19.84	19.66	19.66	20.5
			16QAM	18.82	18.68	18.68	19.5
		Low	QPSK	19.77	19.62	19.65	20.5
			16QAM	18.74	18.59	18.66	19.5
	75RB	/	QPSK	19.74	19.58	19.64	20.5
16QAM			18.84	18.51	18.66	19.5	
20 MHz				1745MHz	1732.5MHz	1720MHz	/
	1RB	High	QPSK	20.80	20.60	20.55	21.5
			16QAM	19.58	19.42	19.44	20.5
		Middle	QPSK	20.68	20.83	20.95	21.5
			16QAM	19.84	19.81	19.75	20.5
		Low	QPSK	20.74	20.42	20.62	21.5
			16QAM	19.70	19.34	19.40	20.5
	50RB	High	QPSK	19.65	19.62	19.53	20.5
			16QAM	18.67	18.67	18.70	19.5
		Middle	QPSK	19.76	19.65	19.59	20.5
			16QAM	18.79	18.55	18.72	19.5
		Low	QPSK	19.76	19.56	19.73	20.5
			16QAM	18.88	18.67	18.90	19.5
	100RB	/	QPSK	19.82	19.59	19.59	20.5
16QAM			18.82	18.62	18.70	19.5	

LTE-FDD Band 5				Actual output Power (dBm)			Tune up
Band-width	RB allocation	RB offset	Modulation	High	Middle	Low	
1.4 MHz				848.3MHz	836.5MHz	824.7MHz	
	1RB	High	QPSK	22.59	22.83	23.05	23.5
			16QAM	21.95	21.77	21.89	22.5
		Middle	QPSK	22.84	22.76	22.97	23.5
			16QAM	21.94	22.02	22.01	22.5
		Low	QPSK	22.84	22.91	23.03	23.5
			16QAM	21.77	21.85	21.91	22.5
	3RB	High	QPSK	23.07	23.01	23.07	23.5
			16QAM	21.80	21.87	21.75	22.5
		Middle	QPSK	23.22	23.04	23.11	23.5
			16QAM	21.94	21.97	22.04	22.5
		Low	QPSK	22.97	23.02	23.06	23.5
			16QAM	21.88	21.89	21.89	22.5
	6RB	/	QPSK	21.87	21.91	21.99	22.5
16QAM			20.77	20.98	20.96	21.5	
3 MHz				847.5MHz	836.5MHz	825.5MHz	/
	1RB	High	QPSK	22.83	22.88	23.03	23.5
			16QAM	21.62	21.70	21.83	22.5
		Middle	QPSK	23.15	23.09	22.97	23.5
			16QAM	21.79	21.87	21.82	22.5
		Low	QPSK	23.11	23.08	22.92	23.5
			16QAM	21.95	21.92	21.76	22.5
	8RB	High	QPSK	21.90	21.95	22.11	22.5
			16QAM	20.93	20.69	21.12	21.5
		Middle	QPSK	21.93	21.96	22.03	22.5
			16QAM	21.15	21.14	21.19	21.5
		Low	QPSK	22.04	21.97	22.02	22.5
			16QAM	21.31	21.18	21.12	21.5
	15RB	/	QPSK	21.94	21.91	22.12	22.5
16QAM			20.99	20.90	21.01	21.5	

LTE-FDD Band 5				Actual output Power (dBm)			Tune up
Band-width	RB allocation	RB offset	Modulation	High	Middle	Low	
5 MHz				846.5MHz	836.5MHz	826.5MHz	
	1RB	High	QPSK	22.79	22.83	22.93	23.5
			16QAM	21.50	21.57	21.75	22.5
		Middle	QPSK	23.17	22.92	22.84	23.5
			16QAM	21.90	21.79	21.76	22.5
		Low	QPSK	22.95	22.96	22.89	23.5
			16QAM	21.84	21.84	21.29	22.5
	12RB	High	QPSK	21.87	22.04	22.09	22.5
			16QAM	20.92	20.92	21.10	21.5
		Middle	QPSK	22.12	22.00	22.03	22.5
			16QAM	21.18	20.96	21.04	21.5
		Low	QPSK	22.03	22.05	21.97	22.5
			16QAM	21.00	20.93	21.01	21.5
	25RB	/	QPSK	21.92	21.95	22.05	22.5
16QAM			21.20	20.90	21.04	21.5	
10 MHz				844MHz	836.5MHz	829MHz	/
	1RB	High	QPSK	22.70	22.93	22.95	23.5
			16QAM	21.58	21.63	21.70	22.5
		Middle	QPSK	23.25	23.03	23.20	23.5
			16QAM	21.88	21.81	21.82	22.5
		Low	QPSK	23.11	22.81	23.07	23.5
			16QAM	21.60	21.65	21.62	22.5
	25RB	High	QPSK	22.08	21.94	21.98	22.5
			16QAM	21.04	21.03	21.06	21.5
		Middle	QPSK	22.17	22.07	22.11	22.5
			16QAM	21.13	21.08	21.20	21.5
		Low	QPSK	21.94	22.06	22.00	22.5
			16QAM	21.09	21.09	21.07	21.5
	50RB	/	QPSK	22.00	21.99	22.07	22.5
16QAM			21.05	21.08	21.05	21.5	

LTE-FDD Band 12				Actual output Power (dBm)			Tune up
Band-width	RB allocation	RB offset	Modulation	High	Middle	Low	
1.4 MHz				715.3MHz	707.5MHz	699.7MHz	
	1RB	High	QPSK	23.31	23.23	23.20	24
			16QAM	22.10	22.12	22.02	23
		Middle	QPSK	23.32	23.32	23.38	24
			16QAM	22.32	22.27	22.19	23
		Low	QPSK	23.24	23.22	23.24	24
			16QAM	22.12	22.19	21.94	23
	3RB	High	QPSK	23.51	23.49	23.44	24
			16QAM	22.62	22.28	22.23	23
		Middle	QPSK	23.47	23.39	23.42	24
			16QAM	22.34	22.28	22.46	23
		Low	QPSK	23.49	23.31	23.49	24
			16QAM	22.23	22.30	22.25	23
	6RB	/	QPSK	22.29	22.36	22.22	23
16QAM			21.28	21.24	21.14	22	
3 MHz				714.5MHz	707.5MHz	700.5MHz	/
	1RB	High	QPSK	23.47	23.33	23.30	24
			16QAM	22.12	22.18	21.86	23
		Middle	QPSK	23.53	23.40	23.30	24
			16QAM	22.04	22.04	21.87	23
		Low	QPSK	23.34	23.11	23.32	24
			16QAM	22.13	22.02	21.93	23
	8RB	High	QPSK	22.46	22.40	22.37	23
			16QAM	21.53	21.35	21.42	22
		Middle	QPSK	22.41	22.36	22.30	23
			16QAM	21.57	21.47	21.43	22
		Low	QPSK	22.39	22.37	22.34	23
			16QAM	21.38	21.39	21.46	22
	15RB	/	QPSK	22.42	22.35	22.26	23
16QAM			21.27	21.35	21.30	22	

LTE-FDD Band 12				Actual output Power (dBm)			Tune up
Band-width	RB allocation	RB offset	Modulation	High	Middle	Low	
5 MHz				713.5MHz	707.5MHz	701.5MHz	
	1RB	High	QPSK	23.34	23.32	23.26	24
			16QAM	22.04	22.02	21.84	23
		Middle	QPSK	23.35	23.31	23.39	24
			16QAM	22.00	22.01	21.79	23
		Low	QPSK	23.28	23.15	23.20	24
			16QAM	21.97	21.97	21.74	23
	12RB	High	QPSK	22.35	22.36	22.26	23
			16QAM	21.03	21.11	21.19	22
		Middle	QPSK	22.42	22.26	22.36	23
			16QAM	21.32	21.08	21.34	22
		Low	QPSK	22.29	22.25	22.24	23
			16QAM	21.27	21.05	21.32	22
	25RB	/	QPSK	22.31	22.36	22.16	23
16QAM			21.21	21.26	21.43	22	
10 MHz				711MHz	707.5MHz	704MHz	/
	1RB	High	QPSK	23.41	23.28	23.37	24
			16QAM	22.04	22.01	22.06	23
		Middle	QPSK	23.50	23.33	23.46	24
			16QAM	22.10	22.10	22.10	23
		Low	QPSK	23.32	23.05	23.29	24
			16QAM	21.90	21.77	21.89	23
	25RB	High	QPSK	22.34	22.40	22.21	23
			16QAM	21.34	21.27	21.34	22
		Middle	QPSK	22.33	22.34	22.33	23
			16QAM	21.40	21.29	21.35	22
		Low	QPSK	22.42	22.37	22.30	23
			16QAM	21.25	21.29	21.28	22
	50RB	/	QPSK	22.29	22.33	22.27	23
16QAM			21.21	21.31	21.38	22	

LTE-FDD Band 13				Actual output Power (dBm)			Tune up
Band-width	RB allocation	RB offset	Modulation	High	Middle	Low	
5 MHz				784.5MHz	782MHz	779.5MHz	
	1RB	High	QPSK	23.34	23.44	23.21	24
			16QAM	22.25	22.25	22.23	23
		Middle	QPSK	23.52	23.45	23.73	24
			16QAM	22.53	22.67	22.73	23
		Low	QPSK	23.41	23.41	23.50	24
			16QAM	22.31	22.57	22.34	23
	12RB	High	QPSK	22.47	22.45	22.49	23
			16QAM	21.27	21.41	21.48	22
		Middle	QPSK	22.44	22.57	22.65	23
			16QAM	21.38	21.48	21.43	22
		Low	QPSK	22.36	22.49	22.60	23
			16QAM	21.39	21.45	21.54	22
	25RB	/	QPSK	22.46	22.47	22.51	23
16QAM			21.37	21.41	21.57	22	
10 MHz				782MHz	782MHz	782MHz	/
	1RB	High	QPSK	/	23.34	/	24
			16QAM	/	22.41	/	23
		Middle	QPSK	/	23.52	/	24
			16QAM	/	22.50	/	23
		Low	QPSK	/	23.26	/	24
			16QAM	/	22.32	/	23
	25RB	High	QPSK	/	22.39	/	23
			16QAM	/	21.45	/	22
		Middle	QPSK	/	22.46	/	23
			16QAM	/	21.72	/	22
		Low	QPSK	/	22.36	/	23
			16QAM	/	21.64	/	22
	50RB	/	QPSK	/	22.46	/	23
16QAM			/	21.38	/	22	

LTE-FDD Band 25				Actual output Power (dBm)			Tune up
Band-width	RB allocation	RB offset	Modulation	High	Middle	Low	
1.4 MHz				1914.3MHz	1882.5MHz	1850.7MHz	
	1RB	High	QPSK	21.70	21.62	21.48	22.1
			16QAM	20.44	20.44	20.18	21.1
		Middle	QPSK	21.70	21.66	21.56	22.1
			16QAM	20.63	20.51	20.27	21.1
		Low	QPSK	21.72	21.66	21.44	22.1
			16QAM	20.46	20.46	20.33	21.1
	3RB	High	QPSK	21.71	21.85	21.65	22.1
			16QAM	20.69	21.00	20.42	21.1
		Middle	QPSK	21.84	21.90	21.58	22.1
			16QAM	20.63	21.07	20.55	21.1
		Low	QPSK	21.87	21.76	21.55	22.1
			16QAM	20.90	21.03	20.53	21.1
	6RB	/	QPSK	20.67	20.59	20.60	21.1
16QAM			19.72	19.53	19.52	20.1	
3 MHz				1913.5MHz	1882.5MHz	1851.5MHz	/
	1RB	High	QPSK	21.80	21.64	21.48	22.1
			16QAM	20.59	20.42	20.22	21.1
		Middle	QPSK	21.76	21.64	21.44	22.1
			16QAM	20.52	20.05	20.23	21.1
		Low	QPSK	21.81	21.67	21.40	22.1
			16QAM	20.46	20.20	20.32	21.1
	8RB	High	QPSK	20.85	20.69	20.56	21.1
			16QAM	19.80	19.83	19.68	20.1
		Middle	QPSK	20.86	20.64	20.60	21.1
			16QAM	19.87	19.76	19.71	20.1
		Low	QPSK	20.86	20.65	20.60	21.1
			16QAM	19.52	19.76	19.64	20.1
	15RB	/	QPSK	20.79	20.73	20.59	21.1
16QAM			19.66	19.68	19.46	20.1	

LTE-FDD Band 25				Actual output Power (dBm)			Tune up
Band-width	RB allocation	RB offset	Modulation	High	Middle	Low	
5 MHz				1912.5MHz	1882.5MHz	1852.5MHz	
	1RB	High	QPSK	21.70	21.59	21.41	22.1
			16QAM	20.43	20.33	20.23	21.1
		Middle	QPSK	21.68	21.59	21.48	22.1
			16QAM	20.49	20.05	20.10	21.1
		Low	QPSK	21.65	21.60	21.46	22.1
			16QAM	20.45	19.95	20.24	21.1
	12RB	High	QPSK	20.85	20.72	20.53	21.1
			16QAM	19.77	19.66	19.47	20.1
		Middle	QPSK	20.75	20.75	20.59	21.1
			16QAM	19.78	19.52	19.55	20.1
		Low	QPSK	20.69	20.65	20.57	21.1
			16QAM	19.66	19.58	19.48	20.1
	25RB	/	QPSK	20.79	20.70	20.55	21.1
16QAM			19.79	19.65	19.59	20.1	
10 MHz				1910MHz	1882.5MHz	1855MHz	/
	1RB	High	QPSK	21.77	21.63	21.55	22.1
			16QAM	20.55	20.35	20.26	21.1
		Middle	QPSK	21.82	21.72	21.56	22.1
			16QAM	20.53	20.40	20.26	21.1
		Low	QPSK	21.80	21.74	21.54	22.1
			16QAM	20.56	20.48	20.37	21.1
	25RB	High	QPSK	20.79	20.62	20.63	21.1
			16QAM	19.89	19.67	19.61	20.1
		Middle	QPSK	20.88	20.76	20.65	21.1
			16QAM	19.89	19.70	19.62	20.1
		Low	QPSK	20.75	20.71	20.56	21.1
			16QAM	19.93	19.76	19.66	20.1
	50RB	/	QPSK	20.80	20.65	20.63	21.1
16QAM			19.81	19.66	19.62	20.1	

LTE-FDD Band 25				Actual output Power (dBm)			Tune up
Band-width	RB allocation	RB offset	Modulation	High	Middle	Low	
15 MHz				1907.5MHz	1882.5MHz	1857.5MHz	
	1RB	High	QPSK	21.64	21.47	21.65	22.1
			16QAM	20.49	20.37	20.19	21.1
		Middle	QPSK	21.63	21.66	21.40	22.1
			16QAM	20.49	20.38	20.24	21.1
		Low	QPSK	21.66	21.61	21.58	22.1
			16QAM	19.85	20.43	20.38	21.1
	36RB	High	QPSK	20.79	20.62	20.68	21.1
			16QAM	19.69	19.66	19.51	20.1
		Middle	QPSK	20.73	20.76	20.62	21.1
			16QAM	19.72	19.68	19.49	20.1
		Low	QPSK	20.74	20.78	20.54	21.1
			16QAM	19.75	19.57	19.57	20.1
	75RB	/	QPSK	20.76	20.60	20.63	21.1
16QAM			19.81	19.72	19.61	20.1	
20 MHz				1905MHz	1882.5MHz	1860MHz	/
	1RB	High	QPSK	21.51	21.46	21.40	22.1
			16QAM	20.42	20.29	20.23	21.1
		Middle	QPSK	21.75	21.76	21.65	22.1
			16QAM	20.63	20.61	20.51	21.1
		Low	QPSK	21.54	21.46	21.46	22.1
			16QAM	20.44	20.40	20.32	21.1
	50RB	High	QPSK	20.66	20.60	20.63	21.1
			16QAM	19.78	19.54	19.54	20.1
		Middle	QPSK	20.84	20.63	20.57	21.1
			16QAM	19.86	19.68	19.47	20.1
		Low	QPSK	20.73	20.73	20.60	21.1
			16QAM	19.88	19.78	19.55	20.1
	100RB	/	QPSK	20.69	20.64	20.69	21.1
16QAM			19.79	19.66	19.64	20.1	

LTE-FDD Band 26				Actual output Power (dBm)			Tune up
Band-width	RB allocation	RB offset	Modulation	High	Middle	Low	
1.4 MHz				848.3MHz	831.5MHz	814.7MHz	
	1RB	High	QPSK	23.03	23.01	23.21	23.5
			16QAM	21.96	21.79	22.14	22.5
		Middle	QPSK	23.14	23.12	23.35	23.5
			16QAM	22.19	21.86	22.32	22.5
		Low	QPSK	23.15	23.14	23.22	23.5
			16QAM	22.04	21.95	22.51	22.5
	3RB	High	QPSK	23.26	23.22	23.39	23.5
			16QAM	22.22	21.85	22.23	22.5
		Middle	QPSK	23.36	23.23	23.38	23.5
			16QAM	22.35	21.95	22.22	22.5
		Low	QPSK	23.31	23.10	23.29	23.5
			16QAM	22.22	22.14	22.20	22.5
	6RB	/	QPSK	22.16	22.10	22.20	22.5
16QAM			21.20	20.99	21.20	21.5	
3 MHz				847.5MHz	831.5MHz	815.5MHz	/
	1RB	High	QPSK	23.13	23.06	22.46	23.5
			16QAM	21.94	21.95	21.14	22.5
		Middle	QPSK	23.26	23.16	22.45	23.5
			16QAM	22.35	21.78	21.09	22.5
		Low	QPSK	23.18	23.00	22.48	23.5
			16QAM	22.08	21.95	21.11	22.5
	8RB	High	QPSK	22.23	22.17	21.58	22.5
			16QAM	21.30	21.27	20.38	21.5
		Middle	QPSK	22.23	22.25	21.51	22.5
			16QAM	21.32	21.37	20.58	21.5
		Low	QPSK	22.25	22.15	21.58	22.5
			16QAM	21.32	21.28	20.65	21.5
	15RB	/	QPSK	22.17	22.16	21.49	22.5
16QAM			21.09	21.16	20.46	21.5	

LTE-FDD Band 26				Actual output Power (dBm)			Tune up
Band-width	RB allocation	RB offset	Modulation	High	Middle	Low	
5 MHz				846.5MHz	831.5MHz	816.5MHz	
	1RB	High	QPSK	23.04	22.91	22.96	23.5
			16QAM	21.83	21.75	22.13	22.5
		Middle	QPSK	23.24	23.14	23.08	23.5
			16QAM	22.03	21.83	22.25	22.5
		Low	QPSK	23.00	22.99	23.12	23.5
			16QAM	22.26	21.83	22.01	22.5
	12RB	High	QPSK	22.16	22.12	22.21	22.5
			16QAM	21.13	21.05	21.12	21.5
		Middle	QPSK	22.25	22.30	22.28	22.5
			16QAM	21.22	21.25	21.27	21.5
		Low	QPSK	22.14	22.12	22.24	22.5
			16QAM	21.14	21.10	21.18	21.5
	25RB	/	QPSK	22.20	22.07	22.19	22.5
16QAM			21.26	21.04	21.06	21.5	
10 MHz				844MHz	831.5MHz	820MHz	/
	1RB	High	QPSK	23.24	22.97	23.12	23.5
			16QAM	21.93	21.82	21.85	22.5
		Middle	QPSK	23.23	23.18	23.34	23.5
			16QAM	21.94	21.86	21.97	22.5
		Low	QPSK	23.02	23.21	23.18	23.5
			16QAM	21.86	21.73	21.94	22.5
	25RB	High	QPSK	22.23	22.09	22.10	22.5
			16QAM	21.22	21.16	21.28	21.5
		Middle	QPSK	22.18	22.19	22.31	22.5
			16QAM	21.16	21.25	21.24	21.5
		Low	QPSK	22.12	22.15	22.23	22.5
			16QAM	21.21	21.10	21.31	21.5
	50RB	/	QPSK	22.21	22.09	22.15	22.5
16QAM			21.14	21.05	21.10	21.5	

LTE-FDD Band 26				Actual output Power (dBm)			Tune up
Band-width	RB allocation	RB offset	Modulation	High	Middle	Low	
15 MHz				841.5MHz	831.5MHz	822.5MHz	
	1RB	High	QPSK	23.16	23.03	23.09	23.5
			16QAM	21.86	21.76	21.82	22.5
		Middle	QPSK	23.03	23.15	23.10	23.5
			16QAM	22.00	21.87	21.74	22.5
		Low	QPSK	22.88	23.06	23.21	23.5
			16QAM	21.80	21.82	21.83	22.5
	36RB	High	QPSK	22.35	22.23	22.25	22.5
			16QAM	21.26	21.04	21.21	21.5
		Middle	QPSK	22.09	22.21	22.29	22.5
			16QAM	21.10	21.12	21.26	21.5
		Low	QPSK	22.08	22.08	22.22	22.5
			16QAM	20.99	21.09	21.18	21.5
	75RB	/	QPSK	22.25	22.07	22.23	22.5
16QAM			21.26	21.08	21.19	21.5	

LTE-TDD Band 41				Actual output Power (dBm)			Tune up
Band-width	RB allocation	RB offset	Modulation	High	Middle	Low	
5 MHz				2687.5MHz	2593MHz	2498.5MHz	
	1RB	High	QPSK	22.91	22.97	23.27	24
			16QAM	21.48	21.48	21.91	23
		Middle	QPSK	23.16	23.11	23.54	24
			16QAM	21.55	21.62	22.28	23
		Low	QPSK	22.81	23.02	23.43	24
			16QAM	21.37	21.27	21.94	23
	12RB	High	QPSK	21.95	21.83	22.33	23
			16QAM	20.86	20.80	21.43	22
		Middle	QPSK	22.00	21.86	22.43	23
			16QAM	20.91	20.77	21.48	22
		Low	QPSK	21.95	21.75	22.39	23
			16QAM	20.79	20.78	21.40	22
	25RB	/	QPSK	21.91	21.73	22.34	23
16QAM			20.89	21.15	21.54	22	
10 MHz				2685MHz	2593MHz	2501MHz	/
	1RB	High	QPSK	23.18	22.88	23.66	24
			16QAM	21.64	21.51	22.25	23
		Middle	QPSK	23.13	23.15	23.85	24
			16QAM	21.78	21.61	22.31	23
		Low	QPSK	22.99	22.79	23.56	24
			16QAM	21.60	21.41	22.30	23
	25RB	High	QPSK	21.96	22.06	22.57	23
			16QAM	21.08	21.32	21.89	22
		Middle	QPSK	22.09	22.04	22.58	23
			16QAM	21.25	21.25	21.85	22
		Low	QPSK	22.10	21.98	22.53	23
			16QAM	21.34	21.01	21.82	22
	50RB	/	QPSK	22.20	22.04	22.54	23
16QAM			21.05	21.04	21.71	22	

LTE-TDD Band 41				Actual output Power (dBm)			Tune up
Band-width	RB allocation	RB offset	Modulation	High	Middle	Low	
15 MHz				2682.5MHz	2593MHz	2503.5MHz	
	1RB	High	QPSK	22.90	22.77	23.67	24
			16QAM	21.73	21.49	22.37	23
		Middle	QPSK	23.12	23.09	23.72	24
			16QAM	21.75	21.64	22.28	23
		Low	QPSK	22.77	22.71	23.37	24
			16QAM	21.68	21.47	22.26	23
	36RB	High	QPSK	22.21	21.97	22.69	23
			16QAM	21.01	21.00	21.69	22
		Middle	QPSK	22.14	22.05	22.68	23
			16QAM	21.06	21.06	21.67	22
		Low	QPSK	22.01	21.97	22.53	23
			16QAM	21.01	20.98	21.56	22
	75RB	/	QPSK	22.08	22.02	22.49	23
16QAM			21.03	21.08	21.66	22	
20 MHz				2680MHz	2593MHz	2506MHz	/
	1RB	High	QPSK	22.84	22.77	23.54	24
			16QAM	21.52	21.47	22.24	23
		Middle	QPSK	23.12	23.11	23.69	24
			16QAM	21.78	21.74	22.36	23
		Low	QPSK	22.68	22.64	23.38	24
			16QAM	21.60	21.46	22.03	23
	50RB	High	QPSK	22.01	21.97	22.68	23
			16QAM	21.01	20.98	21.72	22
		Middle	QPSK	22.08	22.05	22.69	23
			16QAM	20.97	21.08	21.65	22
		Low	QPSK	21.92	21.85	22.49	23
			16QAM	20.95	20.93	21.42	22
	100RB	/	QPSK	22.01	21.93	22.57	23
16QAM			21.04	20.94	21.62	22	

LTE-TDD Band 41				Actual output Power (dBm)			Tune up
Band-width	RB allocation	RB offset	Modulation	High-2	/	Low-2	
5 MHz				2640.3MHz	/	2545.8MHz	
	1RB	High	QPSK	22.88	/	23.25	24
			16QAM	21.45	/	21.89	23
		Middle	QPSK	23.12	/	23.52	24
			16QAM	21.51	/	22.26	23
		Low	QPSK	22.78	/	23.41	24
			16QAM	21.34	/	21.92	23
	12RB	High	QPSK	21.92	/	22.31	23
			16QAM	20.83	/	21.41	22
		Middle	QPSK	21.97	/	22.42	23
			16QAM	20.88	/	21.46	22
		Low	QPSK	21.92	/	22.37	23
			16QAM	20.76	/	21.38	22
	25RB	/	QPSK	21.88	/	22.32	23
16QAM			20.86	/	21.53	22	
10 MHz				2639MHz	/	2547MHz	/
	1RB	High	QPSK	23.15	/	23.64	24
			16QAM	21.61	/	22.23	23
		Middle	QPSK	23.10	/	23.83	24
			16QAM	21.75	/	22.30	23
		Low	QPSK	22.96	/	23.54	24
			16QAM	21.57	/	22.28	23
	25RB	High	QPSK	21.93	/	22.55	23
			16QAM	21.05	/	21.87	22
		Middle	QPSK	22.06	/	22.56	23
			16QAM	21.22	/	21.83	22
		Low	QPSK	22.07	/	22.51	23
			16QAM	21.31	/	21.81	22
	50RB	/	QPSK	22.17	/	22.52	23
16QAM			20.86	/	21.69	22	

LTE-TDD Band 41				Actual output Power (dBm)			Tune up
Band-width	RB allocation	RB offset	Modulation	High-2	/	Low-2	
15 MHz				2637.8MHz	/	2548.3MHz	
	1RB	High	QPSK	22.87	/	23.65	24
			16QAM	21.69	/	22.35	23
		Middle	QPSK	23.09	/	23.70	24
			16QAM	21.72	/	22.26	23
		Low	QPSK	22.74	/	23.35	24
			16QAM	21.65	/	22.24	23
	36RB	High	QPSK	22.18	/	22.67	23
			16QAM	20.98	/	21.67	22
		Middle	QPSK	22.11	/	22.66	23
			16QAM	21.03	/	21.65	22
		Low	QPSK	21.98	/	22.51	23
			16QAM	20.98	/	21.54	22
	75RB	/	QPSK	22.05	/	22.47	23
16QAM			21.00	/	21.64	22	
20 MHz				2636.5MHz	/	2549.5MHz	/
	1RB	High	QPSK	22.79	/	23.52	24
			16QAM	21.47	/	22.21	23
		Middle	QPSK	23.07	/	23.66	24
			16QAM	21.73	/	22.33	23
		Low	QPSK	22.63	/	23.35	24
			16QAM	21.55	/	22.00	23
	50RB	High	QPSK	21.95	/	22.65	23
			16QAM	20.96	/	21.69	22
		Middle	QPSK	22.03	/	22.66	23
			16QAM	20.92	/	21.62	22
		Low	QPSK	21.87	/	22.47	23
			16QAM	20.90	/	21.40	22
	100RB	/	QPSK	21.96	/	22.54	23
16QAM			20.99	/	21.59	22	

LTE-FDD Band 66				Actual output Power (dBm)			Tune up
Band-width	RB allocation	RB offset	Modulation	High	Middle	Low	
1.4 MHz				1779.3MHz	1745MHz	1710.7MHz	
	1RB	High	QPSK	21.30	21.88	21.78	22
			16QAM	19.83	20.46	20.23	21
		Middle	QPSK	21.66	21.54	21.65	22
			16QAM	20.31	20.14	20.34	21
		Low	QPSK	21.70	21.39	21.78	22
			16QAM	20.35	20.05	20.44	21
	3RB	High	QPSK	21.22	21.85	21.72	22
			16QAM	19.78	20.43	20.21	21
		Middle	QPSK	21.62	21.55	21.62	22
			16QAM	20.33	20.18	20.30	21
		Low	QPSK	21.63	21.41	21.72	22
			16QAM	20.34	20.08	20.47	21
	6RB	/	QPSK	20.57	20.66	20.50	21
16QAM			19.43	19.40	19.25	20	
3 MHz				1778.5MHz	1745MHz	1711.5MHz	/
	1RB	High	QPSK	21.14	21.57	21.39	22
			16QAM	19.83	20.28	20.35	21
		Middle	QPSK	21.55	21.19	21.35	22
			16QAM	20.27	19.92	20.19	21
		Low	QPSK	21.78	21.25	21.74	22
			16QAM	20.39	20.09	20.51	21
	8RB	High	QPSK	20.37	20.51	20.41	21
			16QAM	19.15	19.29	19.22	20
		Middle	QPSK	20.80	20.46	20.43	21
			16QAM	19.37	19.15	19.28	20
		Low	QPSK	20.82	20.67	20.42	21
			16QAM	19.53	19.44	19.23	20
	15RB	/	QPSK	20.68	20.68	20.53	21
16QAM			19.40	19.37	19.12	20	

LTE-FDD Band 66				Actual output Power (dBm)			Tune up
Band-width	RB allocation	RB offset	Modulation	High	Middle	Low	
5 MHz				1777.5MHz	1745MHz	1712.5MHz	
	1RB	High	QPSK	21.15	21.70	21.69	22
			16QAM	19.91	20.22	20.24	21
		Middle	QPSK	21.43	21.27	21.36	22
			16QAM	20.11	19.83	20.02	21
		Low	QPSK	21.51	21.09	21.72	22
			16QAM	20.14	19.86	20.25	21
	12RB	High	QPSK	20.18	20.46	20.29	21
			16QAM	19.10	19.35	19.14	20
		Middle	QPSK	20.60	20.51	20.44	21
			16QAM	19.45	19.36	19.22	20
		Low	QPSK	20.58	20.39	20.39	21
			16QAM	19.39	19.22	19.24	20
	25RB	/	QPSK	20.46	20.50	20.21	21
16QAM			19.09	19.08	18.89	20	
10 MHz				1775MHz	1745MHz	1715MHz	/
	1RB	High	QPSK	21.01	21.67	21.52	22
			16QAM	19.75	20.11	20.16	21
		Middle	QPSK	21.56	21.42	21.42	22
			16QAM	20.18	20.00	20.99	21
		Low	QPSK	21.55	21.15	21.75	22
			16QAM	20.09	19.91	20.31	21
	25RB	High	QPSK	20.19	20.52	20.29	21
			16QAM	18.87	19.06	18.86	20
		Middle	QPSK	20.62	20.56	20.51	21
			16QAM	19.27	19.07	19.09	20
		Low	QPSK	20.56	20.44	20.43	21
			16QAM	19.13	18.89	18.96	20
	50RB	/	QPSK	20.50	20.51	20.25	21
16QAM			19.13	19.12	18.93	20	

LTE-FDD Band 66				Actual output Power (dBm)			Tune up
Band-width	RB allocation	RB offset	Modulation	High	Middle	Low	
15 MHz				1772.5MHz	1745MHz	1717.5MHz	
	1RB	High	QPSK	21.31	21.62	21.64	22
			16QAM	19.70	20.16	20.16	21
		Middle	QPSK	21.69	21.55	21.71	22
			16QAM	20.18	20.24	20.23	21
		Low	QPSK	21.75	21.43	21.71	22
			16QAM	20.45	20.34	20.67	21
	36RB	High	QPSK	20.31	20.55	20.47	21
			16QAM	19.12	19.52	19.35	20
		Middle	QPSK	20.69	20.49	20.68	21
			16QAM	19.62	19.54	19.52	20
		Low	QPSK	20.60	20.64	20.51	21
			16QAM	19.77	19.61	19.59	20
	75RB	/	QPSK	20.50	20.57	20.28	21
16QAM			19.43	19.55	19.26	20	
20 MHz				1770MHz	1745MHz	1720MHz	/
	1RB	High	QPSK	21.37	21.48	21.43	22
			16QAM	19.75	20.24	20.43	21
		Middle	QPSK	21.70	21.54	21.75	22
			16QAM	20.23	20.41	20.38	21
		Low	QPSK	21.63	21.30	21.30	22
			16QAM	19.98	20.02	20.44	21
	50RB	High	QPSK	20.21	20.53	20.42	21
			16QAM	19.05	19.58	19.30	20
		Middle	QPSK	20.49	20.55	20.56	21
			16QAM	19.73	19.58	19.48	20
		Low	QPSK	20.50	20.66	20.43	21
			16QAM	19.73	19.54	19.31	20
	100RB	/	QPSK	20.42	20.60	20.34	21
16QAM			19.39	19.60	19.29	20	

LTE-FDD Band 71				Actual output Power (dBm)			Tune up
Band-width	RB allocation	RB offset	Modulation	High	Middle	Low	
5 MHz				695.5MHz	680.5MHz	665.5MHz	
	1RB	High	QPSK	23.30	23.26	23.22	24
			16QAM	22.38	22.31	22.37	23
		Middle	QPSK	23.45	23.39	23.21	24
			16QAM	22.53	22.45	22.28	23
		Low	QPSK	23.37	23.30	23.14	24
			16QAM	22.45	22.36	22.09	23
	12RB	High	QPSK	22.43	22.39	22.31	23
			16QAM	21.49	21.45	21.37	22
		Middle	QPSK	22.54	22.48	22.41	23
			16QAM	21.66	21.56	21.49	22
		Low	QPSK	22.21	22.32	22.24	23
			16QAM	21.32	21.43	21.37	22
	25RB	/	QPSK	22.38	22.36	22.25	23
16QAM			21.45	21.41	21.32	22	
10 MHz				693MHz	680.5MHz	668MHz	/
	1RB	High	QPSK	23.33	23.26	23.21	24
			16QAM	22.41	22.35	22.30	23
		Middle	QPSK	23.69	23.68	23.54	24
			16QAM	22.63	22.60	22.43	23
		Low	QPSK	23.39	23.33	23.26	24
			16QAM	22.45	22.42	22.35	23
	25RB	High	QPSK	22.41	22.38	22.34	23
			16QAM	21.52	21.44	21.41	22
		Middle	QPSK	22.53	22.49	22.44	23
			16QAM	21.62	21.55	21.46	22
		Low	QPSK	22.37	22.32	22.25	23
			16QAM	21.33	21.28	21.26	22
	50RB	/	QPSK	22.50	22.47	22.36	23
16QAM			21.56	21.49	21.37	22	

LTE-FDD Band 71				Actual output Power (dBm)			Tune up
Band-width	RB allocation	RB offset	Modulation	High	Middle	Low	
15 MHz				/	680.5MHz	/	
	1RB	High	QPSK	/	23.19	/	24
			16QAM	/	22.25	/	23
		Middle	QPSK	/	23.74	/	24
			16QAM	/	22.69	/	23
		Low	QPSK	/	23.29	/	24
			16QAM	/	22.34	/	23
	36RB	High	QPSK	/	22.43	/	23
			16QAM	/	21.58	/	22
		Middle	QPSK	/	22.64	/	23
			16QAM	/	21.72	/	22
		Low	QPSK	/	22.45	/	23
			16QAM	/	21.77	/	22
	75RB	/	QPSK	/	22.55	/	23
16QAM			/	21.62	/	22	
20 MHz				/	680.5MHz	/	/
	1RB	High	QPSK	/	23.05	/	24
			16QAM	/	21.84	/	23
		Middle	QPSK	/	23.22	/	24
			16QAM	/	22.52	/	23
		Low	QPSK	/	22.82	/	24
			16QAM	/	21.78	/	23
	50RB	High	QPSK	/	22.27	/	23
			16QAM	/	21.41	/	22
		Middle	QPSK	/	22.43	/	23
			16QAM	/	21.51	/	22
		Low	QPSK	/	22.38	/	23
			16QAM	/	21.56	/	22
	100RB	/	QPSK	/	22.41	/	23
16QAM			/	21.46	/	22	

11.2 Wi-Fi Measurement result

Table 11.2: The conducted Power measurement results for 2.4G WIFI

WiFi 2.4GHz	Averaged Power (dBm)			Tune up
Mode	Ch.1(2412 MHz)	Ch.6(2437Mhz)	Ch.11(2462MHz)	
802.11b	17.19	17.78	17.80	18
802.11g	14.40	14.97	14.98	16
802.11n(20MHz)	14.23	14.90	14.90	16
/	Ch.3(2422 MHz)	Ch.6(2437Mhz)	Ch.9(2452MHz)	/
802.11n(40MHz)	12.84	13.23	13.16	14

12 Simultaneous TX SAR Considerations

12.1 Introduction

The following procedures adopted from “FCC SAR Considerations for Cell Phones with Multiple Transmitters” are applicable to handsets with built-in unlicensed transmitters such as 802.11 a/b/g devices which may simultaneously transmit with the licensed transmitter.

For this device, the Wi-Fi can transmit simultaneous with other transmitters.

12.2 Transmit Antenna Separation Distances

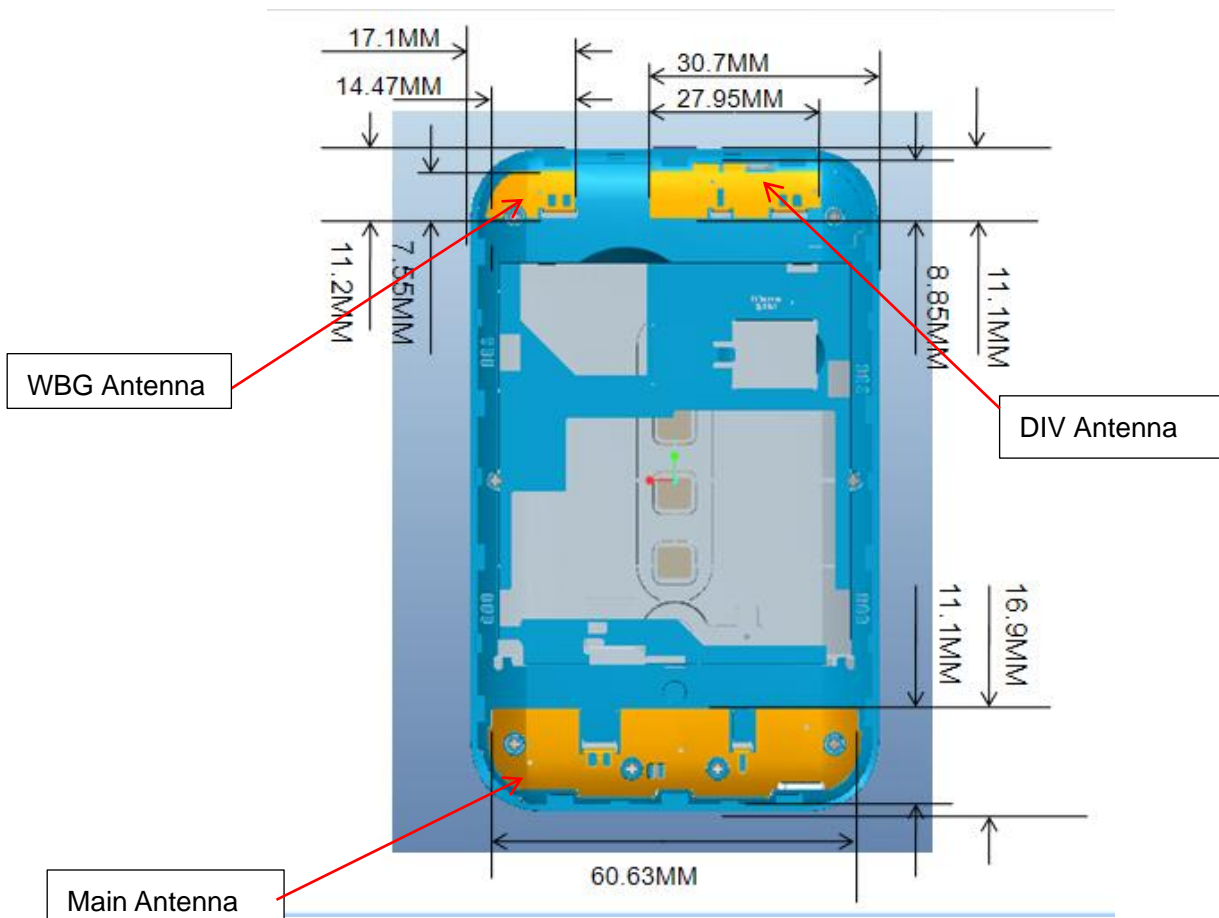

Picture 12.1 Antenna Locations (Back View)

12.3 SAR Measurement Positions

According to the KDB941225 D06 Hot Spot SAR, the edges with less than 25mm distance to the antennas need to be tested for SAR.

SAR measurement positions						
Mode	Front	Rear	Left edge	Right edge	Top edge	Bottom edge
Main antenna	Yes	Yes	Yes	Yes	No	Yes
WIFI antenna	Yes	Yes	No	Yes	Yes	No

12.4 Standalone SAR Test Exclusion Considerations

Standalone 1-g head or body SAR evaluation by measurement or numerical simulation is not required when the corresponding SAR Exclusion Threshold condition, listed below, is satisfied. The 1-g SAR test exclusion threshold for 100 MHz to 6 GHz at test separation distances ≤ 50 mm are determined by:

$[(\text{max. power of channel, including tune-up tolerance, mW}) / (\text{min. test separation distance, mm})] \cdot [\sqrt{f(\text{GHz})}] \leq 3.0$ for 1-g SAR, where

- $f(\text{GHz})$ is the RF channel transmit frequency in GHz
- Power and distance are rounded to the nearest mW and mm before calculation
- The result is rounded to one decimal place for comparison

Table 12.1: Standalone SAR test exclusion considerations

Band/Mode	f(GHz)	Position	SAR test exclusion threshold (mW)	RF output power		SAR test exclusion
				dBm	mW	
2.4GHz WLAN	2.45	Body	19.2	18	63.1	No

13 Evaluation of Simultaneous

Table 13.1: The sum of reported SAR values for main antenna and Wi-Fi

/	Position	Main antenna	Wi-Fi	Sum
Highest reported SAR value for Hotspot	Rear	1.23	0.36	1.59

Conclusion:

According to the above tables, the sum of reported SAR values is < 1.6 W/kg. So the simultaneous transmission SAR with volume scans is not required.

14 SAR Test Result

It is determined by user manual for the distance between the EUT and the phantom bottom.

The distance is 10mm and just applied to the condition of body worn accessory.

It is performed for all SAR measurements with area scan based 1-g SAR estimation (Fast SAR). A zoom scan measurement is added when the estimated 1-g SAR is the highest measured SAR in each exposure configuration, wireless mode and frequency band combination or >1.2W/kg.

The calculated SAR is obtained by the following formula:

$$\text{Reported SAR} = \text{Measured SAR} \times 10^{(P_{\text{Target}} - P_{\text{Measured}})/10}$$

Where P_{Target} is the power of manufacturing upper limit;

P_{Measured} is the measured power in chapter 11.

Duty Cycle

Mode	Duty Cycle
FDD LTE Band 2/4/5/12/13//25/26/66/71	1:1
FDD LTE Band 41	1:1.58

14.1 SAR results
Table 14.1: SAR Values (LTE Band 2 - Body)

Frequency		Ambient Temperature: 22.4°C			Liquid Temperature: 22.0°C				
MHz	Ch.	Test Mode	Test Position	Figure No.	Conducted Power (dBm)	Max. tune-up Power (dBm)	Measured SAR(1g) (W/kg)	Reported SAR(1g) (W/kg)	Power Drift(dB)
1880	18900	1RB_Mid	Front	/	21.55	22.5	0.538	0.67	-0.05
1880	18900	50RB_Mid	Front	/	20.61	21.5	0.407	0.50	0.04
1880	18900	1RB_Mid	Rear	/	21.55	22.5	0.852	1.06	-0.12
1880	18900	50RB_Mid	Rear	/	20.61	21.5	0.690	0.85	0.16
1880	18900	1RB_Mid	Left	/	21.55	22.5	0.037	0.05	0.04
1880	18900	50RB_Mid	Left	/	20.61	21.5	0.031	0.04	0.04
1880	18900	1RB_Mid	Right	/	21.55	22.5	0.488	0.61	0.03
1880	18900	50RB_Mid	Right	/	20.61	21.5	0.384	0.47	-0.02
1880	18900	1RB_Mid	Bottom	/	21.55	22.5	0.284	0.35	0.19
1880	18900	50RB_Mid	Bottom	/	20.61	21.5	0.229	0.28	0.11
1900	19100	1RB_Mid	Rear	Fig.1	21.75	22.5	0.990	1.18	-0.11
1860	18700	1RB_Mid	Rear	/	21.55	22.5	0.820	1.02	0.03
1900	19100	50RB_Mid	Rear	/	20.72	21.5	0.817	0.98	0.04
1860	18700	50RB_Mid	Rear	/	20.55	21.5	0.709	0.88	0.08
1880	18900	100RB	Rear	/	20.64	21.5	0.691	0.84	0.06

Table 14.2: SAR Values (LTE Band 4 - Body)

Frequency		Ambient Temperature: 22.6°C			Liquid Temperature: 22.1°C				
MHz	Ch.	Test Mode	Test Position	Figure No.	Conducted Power (dBm)	Max. tune-up Power (dBm)	Measured SAR(1g) (W/kg)	Reported SAR(1g) (W/kg)	Power Drift(dB)
1732.5	20175	1RB_Mid	Front	/	20.83	21.5	0.355	0.41	-0.01
1732.5	20175	50RB_Mid	Front	/	19.65	20.5	0.276	0.34	0.08
1732.5	20175	1RB_Mid	Rear	/	20.83	21.5	1.000	1.17	-0.11
1732.5	20175	50RB_Mid	Rear	/	19.65	20.5	0.757	0.92	-0.02
1732.5	20175	1RB_Mid	Left	/	20.83	21.5	0.051	0.06	0.04
1732.5	20175	50RB_Mid	Left	/	19.65	20.5	0.041	0.05	0.03
1732.5	20175	1RB_Mid	Right	/	20.83	21.5	0.313	0.37	-0.02
1732.5	20175	50RB_Mid	Right	/	19.65	20.5	0.252	0.31	0.07
1732.5	20175	1RB_Mid	Bottom	/	20.83	21.5	0.569	0.66	-0.16
1732.5	20175	50RB_Mid	Bottom	/	19.65	20.5	0.478	0.58	-0.02
1745	20300	1RB_High	Rear	/	20.80	21.5	0.854	1.00	-0.03
1720	20050	1RB_Mid	Rear	Fig.2	20.95	21.5	1.080	1.23	-0.12
1745	20300	50RB_Mid	Rear	/	19.76	20.5	0.709	0.84	0.10
1720	20050	50RB_Low	Rear	/	19.73	20.5	0.826	0.99	-0.04
1732.5	20175	100RB	Rear	/	19.59	20.5	0.773	0.95	0.06

Table 14.3: SAR Values (LTE Band 5 - Body)

Frequency		Test Mode	Test Position	Figure No.	Ambient Temperature: 22.2°C		Liquid Temperature: 21.7°C		
MHz	Ch.				Conducted Power (dBm)	Max. tune-up Power (dBm)	Measured SAR(1g) (W/kg)	Reported SAR(1g) (W/kg)	Power Drift(dB)
836.5	20525	1RB_Mid	Front	/	23.03	23.5	0.748	0.83	0.02
836.5	20525	25RB_Mid	Front	/	22.07	22.5	0.593	0.65	-0.06
836.5	20525	1RB_Mid	Rear	/	23.03	23.5	0.887	0.99	0.10
836.5	20525	25RB_Mid	Rear	/	22.07	22.5	0.720	0.79	0.01
836.5	20525	1RB_Mid	Left	/	23.03	23.5	0.372	0.41	0.02
836.5	20525	25RB_Mid	Left	/	22.07	22.5	0.303	0.33	0.07
836.5	20525	1RB_Mid	Right	/	23.03	23.5	0.573	0.64	0.02
836.5	20525	25RB_Mid	Right	/	22.07	22.5	0.465	0.51	0.05
836.5	20525	1RB_Mid	Bottom	/	23.03	23.5	0.046	0.05	0.03
836.5	20525	25RB_Mid	Bottom	/	22.07	22.5	0.036	0.04	0.17
844	20600	1RB_Mid	Front	/	23.25	23.5	0.820	0.87	0.12
829	20450	1RB_Mid	Front	/	23.20	23.5	0.707	0.76	0.09
836.5	20525	100RB	Front	/	21.99	22.5	0.593	0.67	-0.06
844	20600	1RB_Mid	Rear	/	23.25	23.5	0.883	0.94	-0.08
829	20450	1RB_Mid	Rear	Fig.3	23.20	23.5	0.984	1.05	-0.15
836.5	20525	100RB	Rear	/	21.99	22.5	0.716	0.81	0.01

Table 14.4: SAR Values (LTE Band 12 - Body)

Frequency		Test Mode	Test Position	Figure No.	Ambient Temperature: 22.5°C		Liquid Temperature: 22.0°C		
MHz	Ch.				Conducted Power (dBm)	Max. tune-up Power (dBm)	Measured SAR(1g) (W/kg)	Reported SAR(1g) (W/kg)	Power Drift(dB)
707.5	23095	1RB_Mid	Front	/	23.33	24	0.423	0.49	0.13
707.5	23095	25RB_High	Front	/	22.40	23	0.342	0.39	0.03
707.5	23095	1RB_Mid	Rear	Fig.4	23.33	24	0.693	0.81	-0.12
707.5	23095	25RB_High	Rear	/	22.40	23	0.529	0.61	-0.05
707.5	23095	1RB_Mid	Left	/	23.33	24	0.158	0.18	-0.01
707.5	23095	25RB_High	Left	/	22.40	23	0.129	0.15	0.00
707.5	23095	1RB_Mid	Right	/	23.33	24	0.320	0.37	-0.02
707.5	23095	25RB_High	Right	/	22.40	23	0.256	0.29	-0.02
707.5	23095	1RB_Mid	Bottom	/	23.33	24	0.025	0.03	0.09
707.5	23095	25RB_High	Bottom	/	22.40	23	0.019	0.02	0.07
711	23130	1RB_Mid	Rear	/	23.50	24	0.644	0.72	-0.05
704	23060	1RB_Mid	Rear	/	23.46	24	0.678	0.77	0.06
707.5	23095	100RB	Rear	/	22.33	23	0.533	0.62	0.03

Table 14.5: SAR Values (LTE Band 13 - Body)

Frequency		Test Mode	Test Position	Figure No.	Ambient Temperature: 22.5°C		Liquid Temperature: 22.0°C		
MHz	Ch.				Conducted Power (dBm)	Max. tune-up Power (dBm)	Measured SAR(1g) (W/kg)	Reported SAR(1g) (W/kg)	Power Drift(dB)
782	23230	1RB_Mid	Front	/	23.52	24	0.341	0.38	0.15
782	23230	25RB_Mid	Front	/	22.46	23	0.254	0.29	0.03
782	23230	1RB_Mid	Rear	Fig.5	23.52	24	0.377	0.42	-0.05
782	23230	25RB_Mid	Rear	/	22.46	23	0.272	0.31	-0.01
782	23230	1RB_Mid	Left	/	23.52	24	0.131	0.15	0.01
782	23230	25RB_Mid	Left	/	22.46	23	0.102	0.12	0.10
782	23230	1RB_Mid	Right	/	23.52	24	0.210	0.23	-0.02
782	23230	25RB_Mid	Right	/	22.46	23	0.167	0.19	0.08
782	23230	1RB_Mid	Bottom	/	23.52	24	0.051	0.06	-0.13
782	23230	25RB_Mid	Bottom	/	22.46	23	0.042	0.05	0.11

Table 14.6: SAR Values (LTE Band 25 - Body)

Frequency		Test Mode	Test Position	Figure No.	Ambient Temperature: 22.5°C		Liquid Temperature: 22.0°C		
MHz	Ch.				Conducted Power (dBm)	Max. tune-up Power (dBm)	Measured SAR(1g) (W/kg)	Reported SAR(1g) (W/kg)	Power Drift(dB)
1882.5	26365	1RB_Mid	Front	/	21.76	22.1	0.547	0.59	0.13
1882.5	26365	50RB_Low	Front	/	20.73	21.1	0.440	0.48	0.14
1882.5	26365	1RB_Mid	Rear	/	21.76	22.1	0.926	1.00	-0.04
1882.5	26365	50RB_Low	Rear	/	20.73	21.1	0.791	0.86	0.10
1882.5	26365	1RB_Mid	Left	/	21.76	22.1	0.046	0.05	-0.09
1882.5	26365	50RB_Low	Left	/	20.73	21.1	0.036	0.04	0.07
1882.5	26365	1RB_Mid	Right	/	21.76	22.1	0.490	0.53	0.01
1882.5	26365	50RB_Low	Right	/	20.73	21.1	0.388	0.42	-0.02
1882.5	26365	1RB_Mid	Bottom	/	21.76	22.1	0.301	0.33	-0.06
1882.5	26365	50RB_Low	Bottom	/	20.73	21.1	0.248	0.27	0.11
1905	26590	1RB_Mid	Rear	Fig.6	21.75	22.1	1.050	1.14	0.03
1860	26140	1RB_Mid	Rear	/	21.65	22.1	0.822	0.91	-0.01
1905	26590	50RB_Mid	Rear	/	20.84	21.1	0.856	0.91	0.10
1860	26140	50RB_High	Rear	/	20.63	21.1	0.744	0.83	0.09
1882.5	26365	100RB	Rear	/	20.64	21.1	0.802	0.89	0.04

Table 14.7: SAR Values (LTE Band 26 - Body)

Frequency		Test Mode	Test Position	Figure No.	Ambient Temperature: 22.5°C		Liquid Temperature: 22.0°C		
MHz	Ch.				Conducted Power (dBm)	Max. tune-up Power (dBm)	Measured SAR(1g) (W/kg)	Reported SAR(1g) (W/kg)	Power Drift(dB)
831.5	26865	1RB_Mid	Front	/	23.15	23.5	0.704	0.76	-0.06
831.5	26865	36RB_High	Front	/	22.23	22.5	0.577	0.61	-0.04
831.5	26865	1RB_Mid	Rear	/	23.15	23.5	0.951	1.03	0.10
831.5	26865	36RB_High	Rear	/	22.23	22.5	0.695	0.74	0.00
831.5	26865	1RB_Mid	Left	/	23.15	23.5	0.543	0.59	0.04
831.5	26865	36RB_High	Left	/	22.23	22.5	0.443	0.47	0.05
831.5	26865	1RB_Mid	Right	/	23.15	23.5	0.584	0.63	0.05
831.5	26865	36RB_High	Right	/	22.23	22.5	0.371	0.39	-0.01
831.5	26865	1RB_Mid	Bottom	/	23.15	23.5	0.044	0.05	0.05
831.5	26865	36RB_High	Bottom	/	22.23	22.5	0.035	0.04	-0.01
841.5	26965	1RB_High	Rear	/	23.16	23.5	0.744	0.80	-0.10
822.5	26775	1RB_Low	Rear	Fig.7	23.21	23.5	0.987	1.06	-0.01
831.5	26865	100RB	Rear	/	22.07	22.5	0.722	0.80	0.03

Table 14.8: SAR Values (LTE Band 41 - Body)

Frequency		Test Mode	Test Position	Figure No.	Ambient Temperature: 22.5°C		Liquid Temperature: 22.0°C		
MHz	Ch.				Conducted Power (dBm)	Max. tune-up Power (dBm)	Measured SAR(1g) (W/kg)	Reported SAR(1g) (W/kg)	Power Drift(dB)
2593	40620	1RB_Mid	Front	/	23.11	24	0.256	0.31	-0.17
2593	40620	50RB_Mid	Front	/	22.05	23	0.195	0.24	0.07
2593	40620	1RB_Mid	Rear	Fig.8	23.11	24	0.479	0.59	0.09
2593	40620	50RB_Mid	Rear	/	22.05	23	0.337	0.42	-0.01
2593	40620	1RB_Mid	Left	/	23.11	24	0.277	0.34	0.09
2593	40620	50RB_Mid	Left	/	22.05	23	0.219	0.27	0.06
2593	40620	1RB_Mid	Right	/	23.11	24	0.119	0.15	0.08
2593	40620	50RB_Mid	Right	/	22.05	23	0.092	0.11	0.01
2593	40620	1RB_Mid	Bottom	/	23.11	24	0.226	0.28	-0.08
2593	40620	50RB_Mid	Bottom	/	22.05	23	0.177	0.22	0.05

Table 14.9: SAR Values (LTE Band 66 - Body)

Frequency		Test Mode	Test Position	Figure No. / Note	Ambient Temperature: 22.6°C		Liquid Temperature: 22.1°C		
MHz	Ch.				Conducted Power (dBm)	Max. tune-up Power (dBm)	Measured SAR(1g) (W/kg)	Reported SAR(1g) (W/kg)	Power Drift(dB)
1745	132322	1RB_Mid	Front	/	21.54	22	0.395	0.44	0.01
1745	132322	50RB_Low	Front	/	20.66	21	0.318	0.34	0.05
1745	132322	1RB_Mid	Rear	/	21.54	22	0.948	1.05	0.09
1745	132322	50RB_Low	Rear	/	20.66	21	0.814	0.88	0.00
1745	132322	1RB_Mid	Left	/	21.54	22	0.040	0.04	0.02
1745	132322	50RB_Low	Left	/	20.66	21	0.033	0.04	0.01
1745	132322	1RB_Mid	Right	/	21.54	22	0.317	0.35	0.01
1745	132322	50RB_Low	Right	/	20.66	21	0.256	0.28	0.01
1745	132322	1RB_Mid	Bottom	/	21.54	22	0.727	0.81	0.02
1745	132322	50RB_Low	Bottom	/	20.66	21	0.586	0.63	-0.02
1770	132572	1RB_Mid	Rear	/	21.70	22	0.721	0.77	0.00
1720	132072	1RB_Mid	Rear	Fig.9	21.75	22	1.120	1.19	-0.02
1770	132572	50RB_Low	Rear	/	20.50	21	0.689	0.77	-0.11
1720	132072	50RB_Mid	Rear	/	20.56	21	0.965	1.07	-0.11
1745	132322	100RB	Rear	/	20.60	21	0.815	0.89	0.13
1770	132572	1RB_Mid	Bottom	/	21.70	22	0.580	0.62	0.00
1720	132072	1RB_Mid	Bottom	/	21.75	22	0.893	0.95	-0.02
1745	132322	100RB	Bottom	/	20.60	21	0.717	0.79	0.13

Table 14.10: SAR Values (LTE Band 71 - Body)

Frequency		Test Mode	Test Position	Figure No. / Note	Ambient Temperature: 22.5°C		Liquid Temperature: 22.0°C		
MHz	Ch.				Conducted Power (dBm)	Max. tune-up Power (dBm)	Measured SAR(1g) (W/kg)	Reported SAR(1g) (W/kg)	Power Drift(dB)
680.5	133297	1RB_Mid	Front	/	23.22	24	0.168	0.20	-0.12
680.5	133297	50RB_Mid	Front	/	22.43	23	0.128	0.15	0.07
680.5	133297	1RB_Mid	Rear	Fig.10	23.22	24	0.254	0.30	0.06
680.5	133297	50RB_Mid	Rear	/	22.43	23	0.186	0.21	0.14
680.5	133297	1RB_Mid	Left	/	23.22	24	0.104	0.12	-0.08
680.5	133297	50RB_Mid	Left	/	22.43	23	0.078	0.09	0.04
680.5	133297	1RB_Mid	Right	/	23.22	24	0.110	0.13	0.15
680.5	133297	50RB_Mid	Right	/	22.43	23	0.082	0.09	0.07
680.5	133297	1RB_Mid	Bottom	/	23.22	24	0.037	0.04	-0.09
680.5	133297	50RB_Mid	Bottom	/	22.43	23	0.027	0.03	0.01

14.2 WLAN Evaluation for 2.4G

According to the KDB248227 D01, SAR is measured for 2.4GHz 802.11b DSSS using the initial test position procedure.

Table 14.11: SAR Values (WLAN 2.4G - Body)

Frequency		Test Mode	Test Position	Figure No.	Ambient Temperature: 22.4°C		Liquid Temperature: 21.8°C		Power Drift(dB)
MHz	Ch.				Conducted Power (dBm)	Max. tune-up Power (dBm)	Measured SAR(1g) (W/kg)	Reported SAR(1g) (W/kg)	
2462	11	802.11 b	Front	/	17.80	18	0.282	0.30	0.09
2462	11	802.11 b	Rear	Fig.11	17.80	18	0.344	0.36	-0.09
2462	11	802.11 b	Right	/	17.80	18	0.271	0.28	0.06
2462	11	802.11 b	Top	/	17.80	18	0.155	0.16	-0.01

Note1: For all positions/configurations tested using the initial test position and subsequent test positions, when the reported SAR is > 0.8 W/kg, SAR is measured for these test positions/configurations on the subsequent next highest measured output power channel until the reported SAR is ≤ 1.2 W/kg or all required channels are tested.

According to the KDB248227 D01, The reported SAR must be scaled to 100% transmission duty factor to determine compliance at the maximum tune-up tolerance limit. A maximum transmission duty factor of 100% is achievable for WLAN in this project and the scaled reported SAR is presented as below.

Table 14.12: SAR Values (WLAN - Body) – 802.11b 1Mbps (Scaled Reported SAR)

Frequency		Test Position	Actual duty factor	maximum duty factor	Reported SAR (1g)(W/kg)	Scaled reported SAR (1g)(W/kg)
MHz	Ch.					
2462	11	Rear	100%	100%	0.36	0.36

SAR is not required for OFDM because the 802.11b adjusted SAR ≤ 1.2 W/kg.

15 SAR Measurement Variability

SAR measurement variability must be assessed for each frequency band, which is determined by the SAR probe calibration point and tissue-equivalent medium used for the device measurements. When both head and body tissue-equivalent media are required for SAR measurements in a frequency band, the variability measurement procedures should be applied to the tissue medium with the highest measured SAR, using the highest measured SAR configuration for that tissue-equivalent medium.

The following procedures are applied to determine if repeated measurements are required.

- 1) Repeated measurement is not required when the original highest measured SAR is < 0.80 W/kg; steps 2) through 4) do not apply.
- 2) When the original highest measured SAR is ≥ 0.80 W/kg, repeat that measurement once.
- 3) Perform a second repeated measurement only if the ratio of largest to smallest SAR for the original and first repeated measurements is > 1.20 or when the original or repeated measurement is ≥ 1.45 W/kg (~ 10% from the 1-g SAR limit).
- 4) Perform a third repeated measurement only if the original, first or second repeated measurement is ≥ 1.5 W/kg and the ratio of largest to smallest SAR for the original, first and second repeated measurements is > 1.20 .

Table 15.1: SAR Measurement Variability for Body – LTE Band 2

Frequency		Test Position	Original	1 st Repeated	Ratio	2 nd Repeated
MHz	Ch.		SAR (W/kg)	SAR (W/kg)		SAR (W/kg)
1900	19100	Rear	0.990	0.976	1.01	/

Table 15.2: SAR Measurement Variability for Body – LTE Band 4

Frequency		Test Position	Original	1 st Repeated	Ratio	2 nd Repeated
MHz	Ch.		SAR (W/kg)	SAR (W/kg)		SAR (W/kg)
1720	20050	Rear	1.08	1.04	1.04	/

Table 15.3: SAR Measurement Variability for Body – LTE Band 5

Frequency		Test Position	Original	1 st Repeated	Ratio	2 nd Repeated
MHz	Ch.		SAR (W/kg)	SAR (W/kg)		SAR (W/kg)
829	20450	Rear	0.984	0.965	1.02	/

Table 15.4: SAR Measurement Variability for Body – LTE Band 25

Frequency		Test Position	Original	1 st Repeated	Ratio	2 nd Repeated
MHz	Ch.		SAR (W/kg)	SAR (W/kg)		SAR (W/kg)
1905	26590	Rear	1.05	0.998	1.05	/

Table 15.5: SAR Measurement Variability for Body – LTE Band 26

Frequency		Test Position	Original	1 st Repeated	Ratio	2 nd Repeated
MHz	Ch.		SAR (W/kg)	SAR (W/kg)		SAR (W/kg)
822.5	26775	Rear	0.987	0.976	1.01	/

Table 15.6: SAR Measurement Variability for Body – LTE Band 66

Frequency		Test Position	Original	1 st Repeated	Ratio	2 nd Repeated
MHz	Ch.		SAR (W/kg)	SAR (W/kg)		SAR (W/kg)
1720	132072	Rear	1.12	1.07	1.05	/

16 Measurement Uncertainty

16.1 Measurement Uncertainty for Normal SAR Tests (300MHz~3GHz)

No.	Error Description	Type	Uncertainty value	Probably Distribution	Div.	(Ci) 1g	(Ci) 10g	Std. Unc. (1g)	Std. Unc. (10g)	Degree of freedom
Measurement system										
1	Probe calibration	B	12	N	2	1	1	6.0	6.0	∞
2	Isotropy	B	7.4	R	$\sqrt{3}$	1	1	4.3	4.3	∞
3	Boundary effect	B	1.1	R	$\sqrt{3}$	1	1	0.6	0.6	∞
4	Linearity	B	4.7	R	$\sqrt{3}$	1	1	2.7	2.7	∞
5	Detection limit	B	1.0	R	$\sqrt{3}$	1	1	0.6	0.6	∞
6	Readout electronics	B	1.0	N	1	1	1	1.0	1.0	∞
7	Response time	B	0.0	R	$\sqrt{3}$	1	1	0.0	0.0	∞
8	Integration time	B	1.7	R	$\sqrt{3}$	1	1	1.0	1.0	∞
9	RF ambient conditions-noise	B	3.0	R	$\sqrt{3}$	1	1	1.7	1.7	∞
10	RF ambient conditions-reflection	B	3.0	R	$\sqrt{3}$	1	1	1.7	1.7	∞
11	Probe positioned mech. restrictions	B	0.35	R	$\sqrt{3}$	1	1	0.2	0.2	∞
12	Probe positioning with respect to phantom shell	B	2.9	R	$\sqrt{3}$	1	1	1.7	1.7	∞
13	Post-processing	B	1.0	R	$\sqrt{3}$	1	1	0.6	0.6	∞
Test sample related										
14	Test sample positioning	A	3.3	N	1	1	1	3.3	3.3	5
15	Device holder uncertainty	A	3.4	N	1	1	1	3.4	3.4	5
16	Drift of output power	B	5.0	R	$\sqrt{3}$	1	1	2.9	2.9	∞
Phantom and set-up										
17	Phantom uncertainty	B	1.0	R	$\sqrt{3}$	1	1	0.6	0.6	∞
18	Liquid conductivity (target)	B	5.0	R	$\sqrt{3}$	0.64	0.43	1.8	1.2	∞
19	Liquid conductivity (meas.)	A	1.3	N	1	0.64	0.43	0.83	0.56	9
20	Liquid permittivity (target)	B	5.0	R	$\sqrt{3}$	0.6	0.49	1.7	1.4	∞
21	Liquid permittivity (meas.)	A	1.6	N	1	0.6	0.49	0.96	0.78	9
Combined standard uncertainty		$u_c = \sqrt{\sum_{i=1}^{21} c_i^2 u_i^2}$						10.4	10.3	95.5
Expanded uncertainty (Confidence interval of 95 %)		$u_e = 2u_c$						20.8	20.6	