



# TEST REPORT

No.I20N02376-SAR

For

**Yulong Computer Telecommunication Scientific (Shenzhen) Co., Ltd**

**Feature phone**

**Model Name: CP3321AT**

**With**

**Hardware Version: P1**

**Software Version: 3321AT.201014.2S**

**FCC ID: R38YLCP3321AT**

**Issued Date: 2020-10-23**

**Designation Number: CN1210**

**Note:**

The test results in this test report relate only to the devices specified in this report. This report shall not be reproduced except in full without the written approval of SAICT.

**Test Laboratory:**

**SAICT, Shenzhen Academy of Information and Communications Technology**

Building G, Shenzhen International Innovation Center, No.1006 Shennan Road, Futian District, Shenzhen, Guangdong, P. R. China 518000.

Tel:+86(0)755-33322000, Fax:+86(0)755-33322001

Email: yewu@caict.ac.cn. www.saict.ac.cn



No.I20N02376-SAR

## **REPORT HISTORY**

<b>Report Number</b>	<b>Revision</b>	<b>Description</b>	<b>Issue Date</b>
I20N02376-SAR	Rev.0	1st edition	2020-10-23

## CONTENTS

<b>1. SUMMARY OF TEST REPORT .....</b>	<b>5</b>
1.1. TEST ITEMS .....	5
1.2. TEST STANDARDS .....	5
1.3. TEST RESULT.....	5
1.4. TESTING LOCATION .....	5
1.5. PROJECT DATA .....	5
1.6. SIGNATURE .....	5
<b>2. STATEMENT OF COMPLIANCE .....</b>	<b>6</b>
<b>3. CLIENT INFORMATION .....</b>	<b>10</b>
3.1. APPLICANT INFORMATION.....	10
3.2. MANUFACTURER INFORMATION .....	10
<b>4. EQUIPMENT UNDER TEST (EUT) AND ANCILLARY EQUIPMENT (AE) .....</b>	<b>11</b>
4.1. ABOUT EUT .....	11
4.2. INTERNAL IDENTIFICATION OF EUT USED DURING THE TEST .....	12
4.3. INTERNAL IDENTIFICATION OF AE USED DURING THE TEST .....	12
<b>5. TEST METHODOLOGY .....</b>	<b>13</b>
5.1. APPLICABLE LIMIT REGULATIONS.....	13
5.2. APPLICABLE MEASUREMENT STANDARDS .....	13
<b>6. SPECIFIC ABSORPTION RATE (SAR).....</b>	<b>14</b>
6.1. INTRODUCTION.....	14
6.2. SAR DEFINITION.....	14
<b>7. TISSUE SIMULATING LIQUIDS .....</b>	<b>15</b>
7.1. TARGETS FOR TISSUE SIMULATING LIQUID .....	15
7.2. DIELECTRIC PERFORMANCE .....	15
<b>8. SYSTEM VERIFICATION .....</b>	<b>19</b>
8.1. SYSTEM SETUP.....	19
8.2. SYSTEM VERIFICATION .....	20
<b>9. MEASUREMENT PROCEDURES .....</b>	<b>21</b>
9.1. TESTS TO BE PERFORMED.....	21
9.2. GENERAL MEASUREMENT PROCEDURE .....	23
9.3. WCDMA MEASUREMENT PROCEDURES FOR SAR .....	24
9.4. BLUETOOTH & WLAN MEASUREMENT PROCEDURES FOR SAR.....	25
9.5. SAR MEASUREMENT FOR LTE.....	25
9.6. LTE (TDD) CONSIDERATIONS.....	26
9.7. POWER DRIFT.....	27



<b>10. CONDUCTED OUTPUT POWER .....</b>	<b>28</b>
10.1. GSM MEASUREMENT RESULT .....	28
10.2. CDMA MEASUREMENT RESULT .....	30
10.3. WCDMA MEASUREMENT RESULT .....	31
10.4. LTE MEASUREMENT RESULT .....	33
10.5. WLAN AND BLUETOOTH MEASUREMENT RESULT .....	79
<b>11. SIMULTANEOUS TX SAR CONSIDERATIONS .....</b>	<b>80</b>
11.1. INTRODUCTION .....	80
11.2. TRANSMIT ANTENNA SEPARATION DISTANCES .....	80
11.3. SAR MEASUREMENT POSITIONS .....	81
11.4. STANDALONE SAR TEST EXCLUSION CONSIDERATIONS .....	81
<b>12. EVALUATION OF SIMULTANEOUS .....</b>	<b>82</b>
<b>13. SUMMARY OF TEST RESULTS .....</b>	<b>83</b>
13.1. TESTING ENVIRONMENT .....	83
13.2. SAR RESULTS .....	84
13.3. WLAN EVALUATION FOR 2.4G .....	101
<b>14. SAR MEASUREMENT VARIABILITY .....</b>	<b>103</b>
<b>15. MEASUREMENT UNCERTAINTY .....</b>	<b>105</b>
15.1. MEASUREMENT UNCERTAINTY FOR NORMAL SAR TESTS (300MHZ~3GHZ) .....	105
15.2. MEASUREMENT UNCERTAINTY FOR NORMAL SAR TESTS (3GHZ~6GHZ) .....	106
<b>16. MAIN TEST INSTRUMENTS .....</b>	<b>107</b>
<b>ANNEX A: GRAPH RESULTS .....</b>	<b>108</b>
<b>ANNEX B: SYSTEMVERIFICATION RESULTS .....</b>	<b>142</b>
<b>ANNEX C: SAR MEASUREMENT SETUP .....</b>	<b>148</b>
<b>ANNEX D: POSITION OF THE WIRELESS DEVICE IN RELATION TO THE PHANTOM .....</b>	<b>154</b>
<b>ANNEX E: EQUIVALENT MEDIA RECIPES .....</b>	<b>157</b>
<b>ANNEX F: SYSTEM VALIDATION .....</b>	<b>158</b>
<b>ANNEX G: LTE BAND 41 POWER CLASS 2 AND POWER CLASS 3 LINEARITY .....</b>	<b>159</b>
<b>ANNEX H: DAE CALIBRATION CERTIFICATE .....</b>	<b>161</b>
<b>ANNEX I: PROBE CALIBRATION CERTIFICATE .....</b>	<b>164</b>
<b>ANNEX J: DIPOLE CALIBRATION CERTIFICATE .....</b>	<b>174</b>
<b>ANNEX K: EXTENDED CALIBRATION SAR DIPOLE .....</b>	<b>222</b>
<b>ANNEX L: ACCREDITATION CERTIFICATE .....</b>	<b>224</b>



## 1. Summary of Test Report

### 1.1. Test Items

Description: Feature phone  
Model Name: CP3321AT  
Applicant's name: Yulong Computer Telecommunication Scientific (Shenzhen) Co., Ltd  
Manufacturer's Name: Yulong Computer Telecommunication Scientific (Shenzhen) Co., Ltd

### 1.2. Test Standards

ANSI C95.1-1992, IEEE 1528-2013

### 1.3. Test Result

Pass. Please refer to "13. Summary of Test Results"

### 1.4. Testing Location

Address: Building G, Shenzhen International Innovation Center, No.1006 Shennan Road, Futian District, Shenzhen, Guangdong, P. R. China

### 1.5. Project Data

Testing Start Date: 2020-09-18

Testing End Date: 2020-10-15

### 1.6. Signature

Li Yongfu

(Prepared this test report)

Zhang Yunzhan

(Reviewed this test report)

Cao Junfei

(Approved this test report)

## 2. Statement of Compliance

The maximum results of Specific Absorption Rate (SAR) found during testing for Yulong Computer Telecommunication Scientific (Shenzhen) Co., Ltd Feature phone CP3321AT are as follows:

**Table 2.1: Highest Reported SAR for Head (1g)**

Exposure Configuration	Technology Band	Highest Reported SAR 1g(W/Kg)	Equipment Class
Head (Separation Distance 0mm)	GSM850	0.20	PCE
	PCS1900	0.21	
	CDMA BC0	0.29	
	CDMA BC1	0.41	
	CDMA BC10	0.27	
	WCDMA Band2	0.17	
	WCDMA Band4	0.32	
	WCDMA Band5	0.32	
	LTE Band 5	0.26	
	LTE Band 12	0.26	
	LTE Band 13	0.05	
	LTE Band 25	0.30	
	LTE Band 26	0.32	
	LTE Band 41	0.31	
	LTE Band 66	0.26	
	LTE Band 71	0.06	
WLAN 2.4GHz	0.08	DTS	

**Table 2.2: Highest Reported SAR for Hotspot (1g)**

Exposure Configuration	Technology Band	Highest Reported SAR 1g(W/Kg)	Equipment Class
Hotspot (Separation Distance 10 mm)	GSM850	1.17	PCE
	PCS1900	0.79	
	CDMA BC0	1.03	
	CDMA BC1	0.55	
	CDMA BC10	1.10	
	WCDMA Band2	1.06	
	WCDMA Band4	1.15	
	WCDMA Band5	0.53	
	LTE Band 5	0.67	
	LTE Band 12	0.39	
	LTE Band 13	0.09	
	LTE Band 25	<b>1.29</b>	
	LTE Band 26	0.68	
	LTE Band 41	0.74	
	LTE Band 66	1.23	
	LTE Band 71	0.18	
WLAN 2.4GHz	0.14	DTS	

**Table 2.3: Highest Reported SAR for Body-worn (1g)**

Exposure Configuration	Technology Band	Highest Reported SAR 1g(W/Kg)	Equipment Class
Body-worn (Separation Distance 10/15 mm)	GSM850	1.17	PCE
	PCS1900	0.72	
	CDMA BC0	1.03	
	CDMA BC1	0.80	
	CDMA BC10	1.10	
	WCDMA Band2	1.06	
	WCDMA Band4	1.05	
	WCDMA Band5	0.53	
	LTE Band 5	0.67	
	LTE Band 12	0.39	
	LTE Band 13	0.09	
	LTE Band 25	<b>1.29</b>	
	LTE Band 26	0.68	
	LTE Band 41	1.06	
	LTE Band 66	1.23	
	LTE Band 71	0.18	
WLAN 2.4GHz	0.14	DTS	

The SAR values found for the Mobile Phone are below the maximum recommended levels of 1.6 W/Kg as averaged over any 1g tissue according to the ANSI C95.1-1992.

The EUT battery must be fully charged and checked periodically during the test to ascertain uniform power output.

The measurement together with the test system set-up is described in annex C of this test report. A detailed description of the equipment under test can be found in chapter 4 of this test report.

The highest reported SAR value is obtained at the case of **(Table 2.1 & 2.2 & 2.3)**, and the values are: **1.29 W/kg (1g)**.



**Table 2.4: The sum of reported SAR values for main antenna and WLAN**

<i>/</i>	Position	Main antenna	WLAN	Sum
Highest reported SAR value for Head	Left Cheek	0.41	0.08	0.49
Highest reported SAR value for Hotspot	Rear	1.29	0.11	1.40
Highest reported SAR value for Body-worn	Rear	1.29	0.11	1.40

Note: the test positions of above tables are for the worse case that has been evaluated.

**Table 2.5: The sum of reported SAR values for main antenna and Bluetooth**

<i>/</i>	Position	Main antenna	Bluetooth	Sum
Highest reported SAR value for Head	Left Cheek	0.41	0.05	0.46
Highest reported SAR value for Hotspot	Rear	1.29	0.03	1.32
Highest reported SAR value for Body-worn	Rear	1.29	0.03	1.32

Note: the test positions of above tables are for the worse case that has been evaluated.

According to the above tables, the highest sum of reported SAR values is **1.40 W/kg (1g)**.

The detail for simultaneous transmission consideration is described in chapter 12.



### 3. Client Information

#### 3.1. Applicant Information

Company Name:	Yulong Computer Telecommunication Scientific (Shenzhen) Co., Ltd
Address:	Building B, Boton Science Park, Chaguang Road, Xili Town, Nanshan District, Shenzhen
City:	Shenzhen
Country:	China
Telephone:	+86 15927320221

#### 3.2. Manufacturer Information

Company Name:	Yulong Computer Telecommunication Scientific (Shenzhen) Co., Ltd
Address:	Building B, Boton Science Park, Chaguang Road, Xili Town, Nanshan District, Shenzhen
City:	Shenzhen
Country:	China
Telephone:	+86 15927320221

## 4. Equipment under Test (EUT) and Ancillary Equipment (AE)

### 4.1. About EUT

Description:	Feature phone
Model Name:	CP3321AT
Condition of EUT as received:	No obvious damage in appearance
Frequency Bands:	GSM 850/1900, CDMA BC0/BC1/BC10, WCDMA Band 2/4/5, LTE Band 2/4/5/12/13/17/25/26/41/66/71, Bluetooth, WLAN 2.4G
Tested Tx Frequency:	824 – 849MHz (GSM 850)
	1850 – 1910MHz (GSM 1900)
	824 – 849MHz (CDMA BC0)
	1850 – 1910MHz (CDMA BC1)
	817 – 824MHz (CDMA BC10)
	1850 – 1910MHz (WCDMA Band 2)
	1710 – 1755MHz (WCDMA Band 4)
	824 – 849MHz (WCDMA Band 5)
	1850 – 1910MHz (LTE Band 2)
	1710 – 1755MHz (LTE Band 4)
	824 – 849MHz (LTE Band 5)
	699 – 716MHz (LTE Band 12)
	777 – 787MHz (LTE Band 13)
	704 – 716MHz (LTE Band 17)
	1850 – 1915MHz (LTE Band 25)
	814 – 849MHz (LTE Band 26)
	2496 – 2690MHz (LTE Band 41)
1710 – 1780MHz (LTE Band 66)	
663 – 698MHz (LTE Band 71)	
2402 – 2480MHz (Bluetooth)	
2412 – 2462MHz (WLAN 2.4G)	
GPRS / EGPRS Multislot Class:	33
GPRS capability Class:	B
Test device Production information:	Production unit
Device type:	Portable device
Antenna type:	Integrated antenna
Hotspot mode:	Support
<b>Remark:</b>	
1. This device does not support DTM operation.	

#### 4.2. Internal Identification of EUT used during the test

EUT ID*	IMEI	HW Version	SW Version
UT06aa	990016030008344	P1	3321AT.201014.2S
UT08aa	990016030008518	P1	3321AT.201014.2S

\*EUT ID: is used to identify the test sample in the lab internally.

**Note:** It is performed to test SAR with the UT 06aa, and conducted power with the UT 08aa.

#### 4.3. Internal Identification of AE used during the test

AE ID*	Description	Type	Manufacturer
AE1	Battery	Li-ion	Tianjin Lishen
AE2	Battery	Li-ion	Zhuhai Coslight

\*AE ID: is used to identify the test sample in the lab internally.

**Note:** The device has two types of batteries. AE1 battery was used for the initial test, AE2 battery was used for verification tests with the worst configuration.

## 5. Test Methodology

### 5.1. Applicable Limit Regulations

**ANSI C95.1–1992:** IEEE Standard for Safety Levels with Respect to Human Exposure to Radio Frequency Electromagnetic Fields, 3 kHz to 300 GHz.

It specifies the maximum exposure limit of **1.6 W/kg** as averaged over any 1 gram of tissue for portable devices being used within 20 cm of the user in the uncontrolled environment.

### 5.2. Applicable Measurement Standards

**IEEE 1528–2013:** Recommended Practice for Determining the Peak Spatial-Average Specific Absorption Rate (SAR) in the Human Head from Wireless Communications Devices: Experimental Techniques.

**KDB 447498 D01 General RF Exposure Guidance v06:** Mobile and Portable Devices RF Exposure Procedures and Equipment Authorization Policies.

**KDB 648474 D04 Handset SAR v01r03:** SAR Evaluation Considerations for Wireless Handsets.

**KDB 941225 D01 SAR test for 3G devices v03r01:** SAR Measurement Procedures for 3G Devices

**KDB 941225 D05 SAR for LTE Devices v02r05:** SAR Evaluation Considerations for LTE Devices

**KDB 941225 D06 Hot Spot SAR v02r01:** SAR Evaluation Procedures for Portable Devices with Wireless Router Capabilities

**KDB 248227 D01 802.11 Wi-Fi SAR v02r02:** SAR Guidance for IEEE 802.11 (Wi-Fi) Transmitters.

**KDB 865664 D01 SAR measurement 100 MHz to 6 GHz v01r04:** SAR Measurement Requirements for 100 MHz to 6 GHz.

**KDB 865664 D02 RF Exposure Reporting v01r02:** RF Exposure Compliance Reporting and Documentation Considerations

**KDB 941225 D05A LTE Rel.10 KDB Inquiry Sheet v01r02:** REL. 10 LTE SAR TEST GUIDANCE AND KDB INQUIRIES

**TCB workshop April 2019; RF Exposure Procedures (Tissue Simulating Liquids)**

**TCB workshop May 2017; RF Exposure Procedures (LTE Band 41 Power Class 2)**

## 6. Specific Absorption Rate (SAR)

### 6.1. Introduction

SAR is related to the rate at which energy is absorbed per unit mass in an object exposed to a radio field. The SAR distribution in a biological body is complicated and is usually carried out by experimental techniques or numerical modeling. The standard recommends limits for two tiers of groups, occupational/controlled and general population/uncontrolled, based on a person's awareness and ability to exercise control over his or her exposure. In general, occupational/controlled exposure limits are higher than the limits for general population/uncontrolled.

### 6.2. SAR Definition

The SAR definition is the time derivative (rate) of the incremental energy ( $dW$ ) absorbed by (dissipated in) an incremental mass ( $dm$ ) contained in a volume element ( $dv$ ) of a given density ( $\rho$ ). The equation description is as below:

$$SAR = \frac{d}{dt} \left( \frac{dW}{dm} \right) = \frac{d}{dt} \left( \frac{dW}{\rho dv} \right)$$

SAR is expressed in units of Watts per kilogram (W/kg)

SAR measurement can be either related to the temperature elevation in tissue by

$$SAR = c \left( \frac{\delta T}{\delta t} \right)$$

Where:  $C$  is the specific heat capacity,  $\delta T$  is the temperature rise and  $\delta t$  is the exposure duration, or related to the electrical field in the tissue by

$$SAR = \frac{\sigma |E|^2}{\rho}$$

Where:  $\sigma$  is the conductivity of the tissue,  $\rho$  is the mass density of tissue and  $E$  is the RMS electrical field strength.

However for evaluating SAR of low power transmitter, electrical field measurement is typically applied.

## 7. Tissue Simulating Liquids

### 7.1. Targets for tissue simulating liquid

**Table 7.1: Targets for tissue simulating liquid**

Frequency (MHz)	Liquid Type	Conductivity ( $\sigma$ )	$\pm 5\%$ Range	Permittivity ( $\epsilon$ )	$\pm 5\%$ Range
750	Head	0.89	0.85~0.93	41.9	39.8~44.0
835	Head	0.90	0.86~0.95	41.5	39.4~43.6
1750	Head	1.37	1.30~1.44	40.1	38.1~42.1
1900	Head	1.40	1.33~1.47	40.0	38.0~42.0
2450	Head	1.80	1.71~1.89	39.2	37.2~41.2
2550	Head	1.91	1.81~2.01	39.1	37.1~41.0

### 7.2. Dielectric Performance

**Table 7.2: Dielectric Performance of Tissue Simulating Liquid**

Measurement Date (yyyy-mm-dd)	Type	Frequency	Conductivity $\sigma$ (S/m)	Drift (%)	Permittivity $\epsilon$	Drift (%)
2020-09-18	Head	750	0.901	1.24	41.25	-1.55
2020-09-20	Head	835	0.914	1.56	40.76	-1.78
2020-10-13	Head	1750	1.385	1.09	39.58	-1.30
2020-10-12	Head	1900	1.417	1.21	38.99	-2.53
2020-09-22	Head	2450	1.826	1.44	38.42	-1.99
2020-10-15	Head	2550	1.949	2.04	38.11	-2.53

Note: The liquid temperature is 22.0°C.

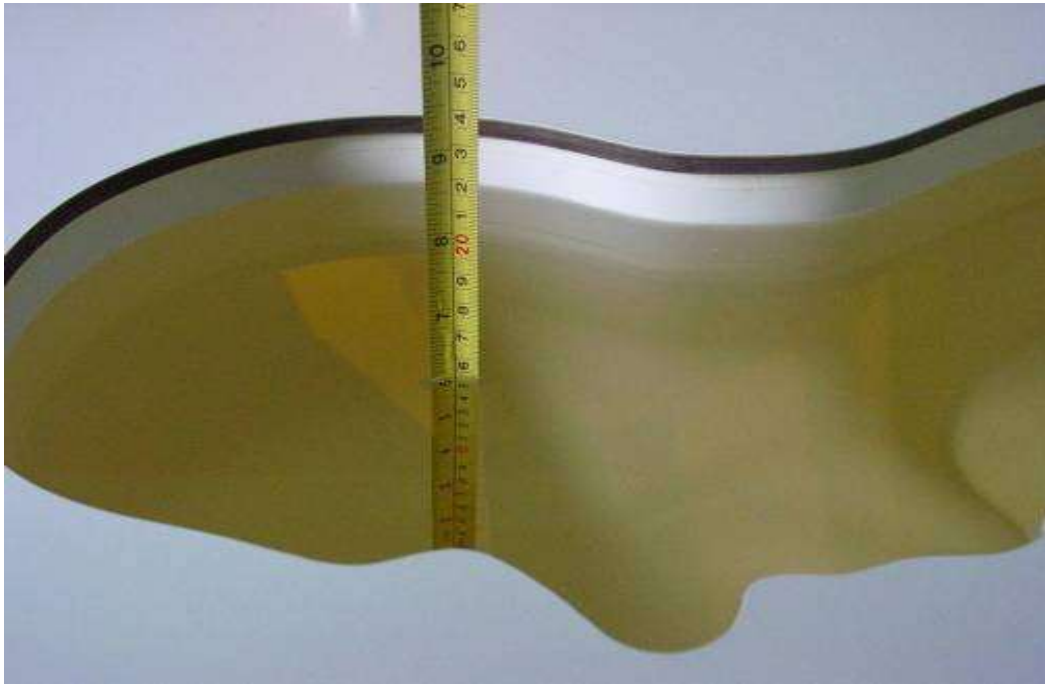

**Picture 7-1: Liquid depth in the Head Phantom (750 MHz)**



**Picture 7-2: Liquid depth in the Head Phantom (835 MHz)**





**Picture 7-3: Liquid depth in the Head Phantom (1750 MHz)**



**Picture 7-4: Liquid depth in the Head Phantom (1900 MHz)**



**Picture 7-5: Liquid depth in the Head Phantom(2450MHz)**

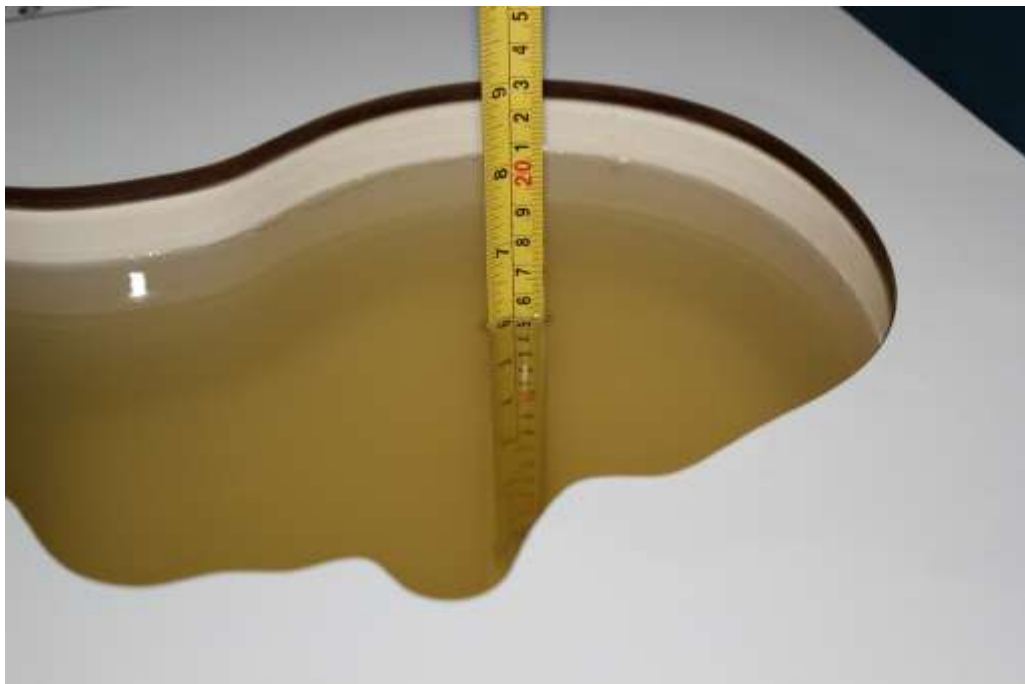

**Picture 7-6: Liquid depth in the Head Phantom(2550MHz)**

## 8. System verification

### 8.1. System Setup

In the simplified setup for system evaluation, the DUT is replaced by a calibrated dipole and the power source is replaced by a continuous wave that comes from a signal generator. The calibrated dipole must be placed beneath the flat phantom section of the SAM twin phantom with the correct distance holder. The distance holder should touch the phantom surface with a light pressure at the reference marking and be oriented parallel to the long side of the phantom. The equipment setup is shown below:

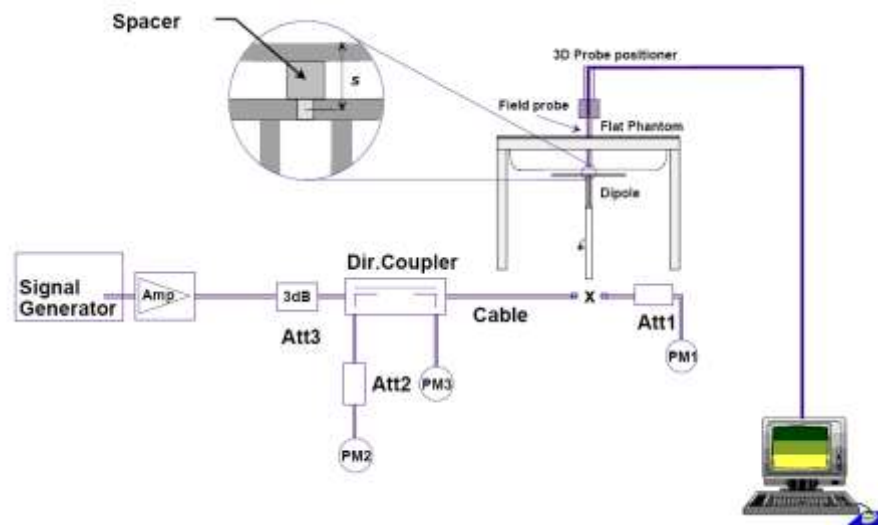

**Picture 8.1 System Setup for System Evaluation**

For the dipole below 3GHz, the output power on dipole port must be calibrated to 24 dBm (250mW) before dipole is connected.



**Picture 8.2 Photo of Dipole Setup**

## 8.2. System Verification

SAR system verification is required to confirm measurement accuracy, according to the tissue dielectric media, probe calibration points and other system operating parameters required for measuring the SAR of a test device. The system verification must be performed for each frequency band and within the valid range of each probe calibration point required for testing the device.

**Table 8.1: System Verification of Head**

Measurement Date (yyyy-mm-dd)	Frequency	Target value (W/kg)		Measured value (W/kg)		Deviation (%)	
		10 g Average	1 g Average	10 g Average	1 g Average	10 g Average	1 g Average
2020-09-18	750 MHz	5.70	8.53	5.76	8.72	1.05	2.23
2020-09-20	835 MHz	6.29	9.62	6.52	10.04	3.66	4.37
2020-10-13	1750 MHz	19.30	36.40	19.80	37.88	2.59	4.07
2020-10-12	1900 MHz	21.00	40.50	21.28	41.60	1.33	2.72
2020-09-22	2450 MHz	24.10	52.00	24.52	54.00	1.74	3.85
2020-10-15	2550 MHz	26.50	57.80	27.04	60.00	2.04	3.81

## 9. Measurement Procedures

### 9.1. Tests to be performed

In order to determine the highest value of the peak spatial-average SAR of a handset, all device positions, configurations and operational modes shall be tested for each frequency band according to steps 1 to 3 below. A flowchart of the test process is shown in picture 9.1.

**Step 1:** The tests described in 9.2 shall be performed at the channel that is closest to the center of the transmit frequency band ( $f_c$ ) for:

- a) all device positions (cheek and tilt, for both left and right sides of the SAM phantom, as described in annex D),
- b) all configurations for each device position in a), e.g., antenna extended and retracted, and
- c) all operational modes, e.g., analogue and digital, for each device position in a) and configuration in b) in each frequency band.

If more than three frequencies need to be tested according to 11.1 (i.e.,  $N_c > 3$ ), then all frequencies, configurations and modes shall be tested for all of the above test conditions.

**Step 2:** For the condition providing highest peak spatial-average SAR determined in Step 1, perform all tests described in 9.2 at all other test frequencies, i.e., lowest and highest frequencies. In addition, for all other conditions (device position, configuration and operational mode) where the peak spatial-average SAR value determined in Step 1 is within 3 dB of the applicable SAR limit, it is recommended that all other test frequencies shall be tested as well.

**Step 3:** Examine all data to determine the highest value of the peak spatial-average SAR found in Steps 1 to 2.

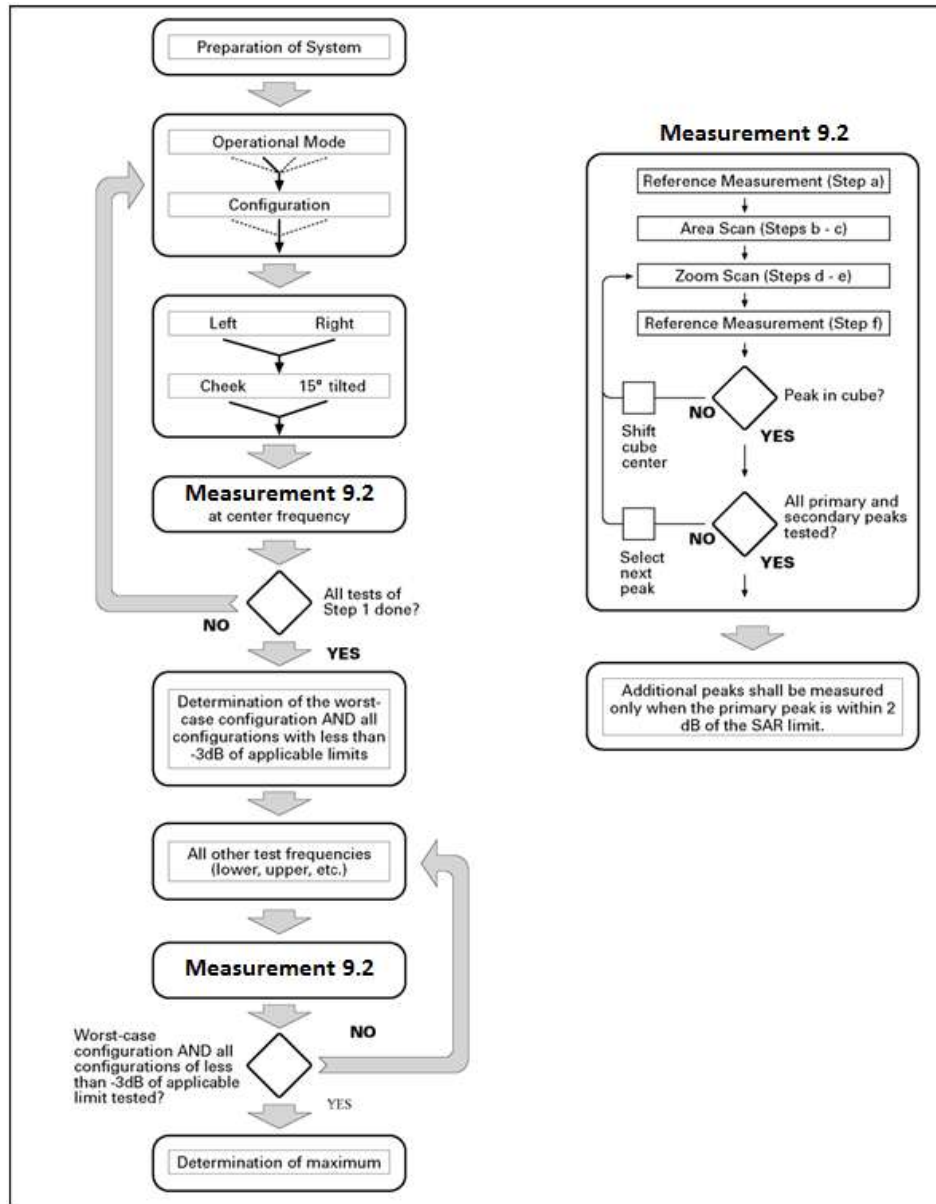

Picture 9.1 Block diagram of the tests to be performed

## 9.2. General Measurement Procedure

The area and zoom scan resolutions specified in the table below must be applied to the SAR measurements and fully documented in SAR reports to qualify for TCB approval. Probe boundary effect error compensation is required for measurements with the probe tip closer than half a probe tip diameter to the phantom surface. Both the probe tip diameter and sensor offset distance must satisfy measurement protocols; to ensure probe boundary effect errors are minimized and the higher fields closest to the phantom surface can be correctly measured and extrapolated to the phantom surface for computing 1-g SAR. Tolerances of the post-processing algorithms must be verified by the test laboratory for the scan resolutions used in the SAR measurements, according to the reference distribution functions specified in IEEE Std 1528-2013. The results should be documented as part of the system validation records and may be requested to support test results when all the measurement parameters in the following table are not satisfied.

		$\leq 3$ GHz	$> 3$ GHz
Maximum distance from closest measurement point (geometric center of probe sensors) to phantom surface		$5 \pm 1$ mm	$\frac{1}{2} \cdot \delta \cdot \ln(2) \pm 0.5$ mm
Maximum probe angle from probe axis to phantom surface normal at the measurement location		$30^\circ \pm 1^\circ$	$20^\circ \pm 1^\circ$
Maximum area scan spatial resolution: $\Delta x_{Area}, \Delta y_{Area}$		$\leq 2$ GHz: $\leq 15$ mm 2 – 3 GHz: $\leq 12$ mm	3 – 4 GHz: $\leq 12$ mm 4 – 6 GHz: $\leq 10$ mm
		When the x or y dimension of the test device, in the measurement plane orientation, is smaller than the above, the measurement resolution must be $\leq$ the corresponding x or y dimension of the test device with at least one measurement point on the test device.	
Maximum zoom scan spatial resolution: $\Delta x_{Zoom}, \Delta y_{Zoom}$		$\leq 2$ GHz: $\leq 8$ mm 2 – 3 GHz: $\leq 5$ mm*	3 – 4 GHz: $\leq 5$ mm* 4 – 6 GHz: $\leq 4$ mm*
Maximum zoom scan spatial resolution, normal to phantom surface	uniform grid: $\Delta z_{Zoom}(n)$	$\leq 5$ mm	3 – 4 GHz: $\leq 4$ mm 4 – 5 GHz: $\leq 3$ mm 5 – 6 GHz: $\leq 2$ mm
	graded grid $\Delta z_{Zoom}(1)$ : between 1 <sup>st</sup> two points closest to phantom surface	$\leq 4$ mm	3 – 4 GHz: $\leq 3$ mm 4 – 5 GHz: $\leq 2.5$ mm 5 – 6 GHz: $\leq 2$ mm
	$\Delta z_{Zoom}(n>1)$ : between subsequent points	$\leq 1.5 \cdot \Delta z_{Zoom}(n-1)$	
Minimum zoom scan volume	x, y, z	$\geq 30$ mm	3 – 4 GHz: $\geq 28$ mm 4 – 5 GHz: $\geq 25$ mm 5 – 6 GHz: $\geq 22$ mm
Note: $\delta$ is the penetration depth of a plane-wave at normal incidence to the tissue medium; see draft standard IEEE P1528-2011 for details. * When zoom scan is required and the <i>reported</i> SAR from the area scan based 1-g SAR estimation procedures of KDB 447498 is $\leq 1.4$ W/kg, $\leq 8$ mm, $\leq 7$ mm and $\leq 5$ mm zoom scan resolution may be applied, respectively, for 2 GHz to 3 GHz, 3 GHz to 4 GHz and 4 GHz to 6 GHz.			

### 9.3. WCDMA Measurement Procedures for SAR

The following procedures are applicable to WCDMA handsets operating under 3GPP Release99, Release 5 and Release 6. The default test configuration is to measure SAR with an established radio link between the DUT and a communication test set using a 12.2kbps RMC (reference measurement channel) configured in Test Loop Mode 1. SAR is selectively confirmed for other physical channel configurations (DPCCH & DPDCH<sub>n</sub>), HSDPA and HSPA (HSUPA/HSDPA) modes according to output power, exposure conditions and device operating capabilities. Both uplink and downlink should be configured with the same RMC or AMR, when required. SAR for Release 5 HSDPA and Release 6 HSPA are measured using the applicable FRC (fixed reference channel) and E-DCH reference channel configurations. Maximum output power is verified according to applicable versions of 3GPP TS 34.121 and SAR must be measured according to these maximum output conditions. When Maximum Power Reduction (MPR) is not implemented according to Cubic Metric (CM) requirements for Release 6 HSPA, the following procedures do not apply.

#### For Release 5 HSDPA Data Devices:

Sub-test	$\beta_c$	$\beta_d$	$\beta_d$ (SF)	$\beta_c / \beta_d$	$\beta_{hs}$	CM/dB
1	2/15	15/15	64	2/15	4/15	0.0
2	12/15	15/15	64	12/15	24/25	1.0
3	15/15	8/15	64	15/8	30/15	1.5
4	15/15	4/15	64	15/4	30/15	1.5

#### For Release 6 HSPA Data Devices

Sub-test	$\beta_c$	$\beta_d$	$\beta_d$ (SF)	$\beta_c / \beta_d$	$\beta_{hs}$	$\beta_{ec}$	$\beta_{ed}$	$\beta_{ed}$ (SF)	$\beta_{ed}$ (codes)	CM (dB)	MPR (dB)	AG Index	E-TFCI
1	11/15	15/15	64	11/15	22/15	209/225	1039/225	4	1	1.0	0.0	20	75
2	6/15	15/15	64	6/15	12/15	12/15	12/15	4	1	3.0	2.0	12	67
3	15/15	9/15	64	15/9	30/15	30/15	$\beta_{ed1}:47/1$ 5 $\beta_{ed2}:47/15$	4	2	2.0	1.0	15	92
4	2/15	15/15	64	2/15	4/15	4/15	56/75	4	1	3.0	2.0	17	71
5	15/15	15/15	64	15/15	24/15	30/15	134/15	4	1	1.0	0.0	21	81



#### 9.4. Bluetooth & WLAN Measurement Procedures for SAR

Normal network operating configurations are not suitable for measuring the SAR of 802.11 transmitters in general. Unpredictable fluctuations in network traffic and antenna diversity conditions can introduce undesirable variations in SAR results. The SAR for these devices should be measured using chipset based test mode software to ensure that the results are consistent and reliable.

Chipset based test mode software is hardware dependent and generally varies among manufacturers. The device operating parameters established in a test mode for SAR measurements must be identical to those programmed in production units, including output power levels, amplifier gain settings and other RF performance tuning parameters. The test frequencies should correspond to actual channel frequencies defined for domestic use. SAR for devices with switched diversity should be measured with only one antenna transmitting at a time during each SAR measurement, according to a fixed modulation and data rate. The same data pattern should be used for all measurements.

#### 9.5. SAR Measurement for LTE

SAR tests for LTE are performed with a base station simulator, Anristu MT8820C. Closed loop power control was used so the UE transmits with maximum output power during SAR testing. All powers were measured with the Anristu MT8820C. It is performed for conducted power and SAR based on the KDB941225 D05.

SAR is evaluated separately according to the following procedures for the different test positions in each exposure condition – head, body, body-worn accessories and other use conditions. The procedures in the following subsections are applied separately to test each LTE frequency band.

1) QPSK with 1 RB allocation

Start with the largest channel bandwidth and measure SAR for QPSK with 1 RB allocation, using the RB offset and required test channel combination with the highest maximum output power among RB offsets at the upper edge, middle and lower edge of each required test channel. When the reported SAR is  $\leq 0.8$  W/kg, testing of the remaining RB offset configurations and required test channels is not required for 1 RB allocation; otherwise, SAR is required for the remaining required test channels and only for the RB offset configuration with the highest output power for that channel. When the reported SAR of a required test channel is  $> 1.45$  W/kg, SAR is required for all three RB offset configurations for that required test channel.

2) QPSK with 50% RB allocation

The procedures required for 1 RB allocation in 1) are applied to measure the SAR for QPSK with 50% RB allocation.

3) QPSK with 100% RB allocation

For QPSK with 100% RB allocation, SAR is not required when the highest maximum output power for 100 % RB allocation is less than the highest maximum output power in 50% and 1 RB allocations and the highest reported SAR for 1 RB and 50% RB allocation in 1) and 2) are  $\leq 0.8$  W/kg. Otherwise, SAR is measured for the highest output power channel; and if the reported SAR is  $> 1.45$  W/kg, the remaining required test channels must also be tested.

## 9.6. LTE (TDD) Considerations

According to KDB 941225 D05 SAR for LTE Devices, for Time-Division Duplex (TDD) systems, SAR must be tested using a fixed periodic duty factor according to the highest transmission duty factor implemented for the device and supported by the defined 3GPP LTE TDD configurations.

SAR was tested with the highest transmission duty factor (63.33%) using Uplink-downlink configuration 0 and Special subframe configuration 7.

LTE TDD Band 41 support 3GPP TS 36.211 section 4.2 for Type 2 Frame Structure and Table 4.2-2 for uplink-downlink configurations and Table 4.2-1 for Special subframe configurations.

Special subframe configuration	Normal cyclic prefix in downlink			Extended cyclic prefix in downlink		
	DwPTS	UpPTS		DwPTS	UpPTS	
		Normal cyclic prefix in uplink	Extended cyclic prefix in uplink		Normal cyclic prefix in uplink	Extended cyclic prefix in uplink
0	$6592 \cdot T_s$	$2192 \cdot T_s$	$2560 \cdot T_s$	$7680 \cdot T_s$	$2192 \cdot T_s$	$2560 \cdot T_s$
1	$19760 \cdot T_s$			$20480 \cdot T_s$		
2	$21952 \cdot T_s$			$23040 \cdot T_s$		
3	$24144 \cdot T_s$			$25600 \cdot T_s$		
4	$26336 \cdot T_s$			$7680 \cdot T_s$		
5	$6592 \cdot T_s$	$4384 \cdot T_s$	$5120 \cdot T_s$	$20480 \cdot T_s$	$4384 \cdot T_s$	$5120 \cdot T_s$
6	$19760 \cdot T_s$			$23040 \cdot T_s$		
7	$21952 \cdot T_s$			$12800 \cdot T_s$		
8	$24144 \cdot T_s$			-		
9	$13168 \cdot T_s$			-		

Configuration of special subframe (lengths of DwPTS/GP/UpPTS)

Uplink-Downlink Configuration	Downlink-to-Uplink Switch-point Periodicity	Subframe Number										Calculated Duty Cycle (%)
		0	1	2	3	4	5	6	7	8	9	
0	5 ms	D	S	U	U	U	D	S	U	U	U	63.33
1	5 ms	D	S	U	U	D	D	S	U	U	D	43.33
2	5 ms	D	S	U	D	D	D	S	U	D	D	23.33
3	10 ms	D	S	U	U	U	D	D	D	D	D	31.67
4	10 ms	D	S	U	U	D	D	D	D	D	D	21.67
5	10 ms	D	S	U	D	D	D	D	D	D	D	11.67
6	5 ms	D	S	U	U	U	D	S	U	U	D	53.33

Calculated Duty Cycle

Calculated Duty Cycle = Extended cyclic prefix in uplink x (Ts) x # of S + # of U

Example for Calculated Duty Cycle for Uplink-Downlink Configuration 0:

Calculated Duty Cycle =  $5120 \times [1/(15000 \times 2048)] \times 2 + 6 \text{ ms} = 63.33\%$

Where

$T_s = 1/(15000 \times 2048)$  seconds

### Note:

1. From May 2017 TCB Workshop, HPUE does not support uplink-downlink configurations 0 and 6.
2. This device supports uplink-downlink configurations 0-6. The configuration with highest duty cycle was used for SAR Testing: configuration 0 at 63.3% (Power Class 3) and configuration 1 at 43.3% (Power Class 2) duty cycle.



No.I20N02376-SAR

### **9.7. Power Drift**

To control the output power stability during the SAR test, DASY5 system calculates the power drift by measuring the E-field at the same location at the beginning and at the end of the measurement for each test position. These drift values can be found in Section 14 labeled as: (Power Drift [dB]). This ensures that the power drift during one measurement is within 5%.

## 10. Conducted Output Power

### 10.1. GSM Measurement result

During the process of testing, the EUT was controlled via Agilent Digital Radio Communication tester (E5515C) to ensure the maximum power transmission and proper modulation. This result contains conducted output power for the EUT. In all cases, the measured peak output power should be greater and within 5% than EMI measurement.

**Table 10.1: The conducted power measurement results for GSM**

Full Power / Hotspot on				
GSM 850MHz	Tune up	Conducted Power (dBm)		
		Channel 251(848.8MHz)	Channel 190(836.6MHz)	Channel 128(824.2MHz)
	<b>34.0</b>	33.09	33.09	33.10
Full Power				
GSM 1900MHz	Tune up	Conducted Power(dBm)		
		Channel 810(1909.8MHz)	Channel 661(1880MHz)	Channel512(1850.2MHz)
	<b>32.0</b>	31.14	31.13	31.29
Hotspot on				
GSM 1900MHz	Tune up	Conducted Power(dBm)		
		Channel 810(1909.8MHz)	Channel 661(1880MHz)	Channel512(1850.2MHz)
	<b>29.5</b>	28.61	28.51	28.63

**Table 10.2: The conducted power measurement results for GPRS and EGPRS**

Full Power / Hotspot on								
GPRS850/ EGPRS850	Tune up	Measured Power (dBm)			calculation	Average Power (dBm)		
		251	190	128		251	190	128
1Tx-slots	<b>34.0</b>	33.12	33.41	33.24	-9.03dB	24.09	24.38	24.21
2Tx-slots	<b>31.5</b>	30.68	30.81	30.82	-6.02dB	24.66	24.79	24.80
3Tx-slots	<b>29.5</b>	28.79	28.73	28.77	-4.26dB	24.53	24.47	24.51
<b>4Tx-slots</b>	<b>28.5</b>	<b>27.76</b>	<b>27.89</b>	<b>27.77</b>	<b>-3.01dB</b>	<b>24.75</b>	<b>24.88</b>	<b>24.76</b>
EGPRS 850 (8PSK)	Tune up	Measured Power (dBm)			calculation	Measured Power (dBm)		
		251	190	128		251	190	128
1Tx-slots	<b>29.0</b>	28.38	28.29	28.47	-9.03dB	19.35	19.26	19.44
2Tx-slots	<b>27.5</b>	26.66	26.72	26.84	-6.02dB	20.64	20.70	20.82
3Tx-slots	<b>24.0</b>	23.13	23.13	23.19	-4.26dB	18.87	18.87	18.93
4Tx-slots	<b>24.0</b>	23.10	23.14	23.21	-3.01dB	24.09	20.13	20.20

Full Power								
GPRS1900/ EGPRS1900	Tune up	Measured Power (dBm)			calculation	Average Power (dBm)		
		810	661	512		810	661	512
1Tx-slots	<b>32.0</b>	31.14	31.08	31.30	-9.03dB	22.11	22.05	22.27
2Tx-slots	<b>30.0</b>	28.89	29.25	29.37	-6.02dB	22.87	23.23	23.35
3Tx-slots	<b>29.0</b>	28.05	27.92	28.18	-4.26dB	23.79	23.66	23.92
<b>4Tx-slots</b>	<b>28.0</b>	<b>26.83</b>	<b>27.00</b>	<b>27.32</b>	<b>-3.01dB</b>	<b>23.82</b>	<b>23.99</b>	<b>24.31</b>
EGPRS 1900 (8PSK)	Tune up	Measured Power (dBm)			calculation	Measured Power (dBm)		
		810	661	512		810	661	512
1Tx-slots	<b>28.0</b>	27.28	27.37	27.54	-9.03dB	18.25	18.34	18.51
2Tx-slots	<b>26.5</b>	25.70	25.92	26.12	-6.02dB	19.68	19.90	20.10
3Tx-slots	<b>23.0</b>	22.24	22.47	22.57	-4.26dB	17.98	18.21	18.31
4Tx-slots	<b>23.0</b>	21.89	22.12	22.32	-3.01dB	18.88	19.11	19.31
Hotspot on								
GPRS1900/ EGPRS1900	Tune up	Measured Power (dBm)			calculation	Average Power (dBm)		
		810	661	512		810	661	512
1Tx-slots	<b>29.5</b>	28.58	28.44	28.59	-9.03dB	19.55	19.41	19.56
2Tx-slots	<b>27.5</b>	26.66	26.14	26.36	-6.02dB	20.64	20.12	20.34
3Tx-slots	<b>26.5</b>	24.95	25.48	25.03	-4.26dB	20.69	21.22	20.77
<b>4Tx-slots</b>	<b>25.5</b>	<b>23.74</b>	<b>24.47</b>	<b>24.49</b>	<b>-3.01dB</b>	<b>20.73</b>	<b>21.46</b>	<b>21.48</b>
EGPRS 1900 (8PSK)	Tune up	Measured Power (dBm)			calculation	Measured Power (dBm)		
		810	661	512		810	661	512
1Tx-slots	<b>26.5</b>	25.75	25.82	26.01	-9.03dB	16.72	16.79	16.98
2Tx-slots	<b>24.5</b>	23.43	23.61	23.78	-6.02dB	17.41	17.59	17.76
3Tx-slots	<b>23.0</b>	22.37	22.41	22.53	-4.26dB	18.11	18.15	18.27
4Tx-slots	<b>23.0</b>	21.56	21.63	21.79	-3.01dB	18.55	18.62	18.78

Notes:

1) Division Factors

To average the power, the division factor is as follows:

1TX-slot = 1 transmit time slot out of 8 time slots=> conducted power divided by (8/1) => -9.03dB

2TX-slots = 2 transmit time slots out of 8 time slots=> conducted power divided by (8/2) => -6.02dB

3TX-slots = 3 transmit time slots out of 8 time slots=> conducted power divided by (8/3) => -4.26dB

4TX-slots = 4 transmit time slots out of 8 time slots=> conducted power divided by (8/4) => -3.01dB

**According to the conducted power as above, the body measurements are performed with 4Txslots for 850MHz and 1900MHz.**

## 10.2. CDMA Measurement result

**Table 10.3: The conducted power measurement results for CDMA**

<b>Full Power / Hotspot on</b>				
CDMA BC0	Tune up	Conducted Power (dBm)		
		Channel 777 (848.31MHz)	Channel 384 (836.52MHz)	Channel 1013 (824.7MHz)
SO55/RC3	23.5	22.30	23.01	22.15
SO55/RC1	23.5	22.25	22.94	22.10
SO32/RC3(FCH only)	23.5	22.22	22.93	22.08
SO32/RC3(FCH+SCHn)	23.5	22.24	22.98	22.14
EVDO Rev.0	23.5	22.19	22.92	22.11
EVDO Rev.A	23.5	22.17	22.87	22.09
CDMA BC10	Tune up	Conducted Power (dBm)		
		Channel 684 (823.1MHz)	Channel 580 (820.5MHz)	Channel 476 (817.9MHz)
SO55/RC3	23.5	23.10	22.84	22.89
SO55/RC1	23.5	23.04	22.81	22.85
SO32/RC3(FCH only)	23.5	23.25	22.77	22.86
SO32/RC3(FCH+SCHn)	23.5	23.30	22.80	22.91
EVDO Rev.0	23.5	23.22	22.75	22.86
EVDO Rev.A	23.5	23.17	22.71	22.83
<b>Full Power</b>				
CDMA BC1	Tune up	Conducted Power (dBm)		
		Channel 1175 (1908.75MHz)	Channel 600 (1880MHz)	Channel 25 (1851.25MHz)
SO55/RC3	23.5	22.56	22.50	22.67
SO55/RC1	23.5	22.50	22.46	22.63
SO32/RC3(FCH only)	23.5	22.32	22.35	22.46
SO32/RC3(FCH+SCHn)	23.5	22.34	22.48	22.50
EVDO Rev.0	23.5	22.30	22.38	22.41
EVDO Rev.A	23.5	22.27	22.35	22.39
<b>Hotspot on</b>				
CDMA BC1	Tune up	Conducted Power (dBm)		
		Channel 1175 (1908.75MHz)	Channel 600 (1880MHz)	Channel 25 (1851.25MHz)
SO55/RC3	19.0	17.92	18.08	18.18
SO55/RC1	19.0	17.85	18.03	18.11
SO32/RC3(FCH only)	19.0	17.74	17.82	17.97
SO32/RC3(FCH+SCHn)	19.0	17.77	17.86	18.02
EVDO Rev.0	19.0	17.75	17.83	17.94
EVDO Rev.A	19.0	17.72	17.69	17.86

### 10.3. WCDMA Measurement result

Table 10.4: T The conducted power measurement results WCDMA

Full Power / Hotspot on					
Item	band	WCDMA Band 2 result			
	ARFCN	Tune up	9538 (1907.6MHz)	9400 (1880MHz)	9262 (1852.4MHz)
WCDMA	\	23.5	23.0	22.7	22.7
HSUPA	1	22.0	21.2	20.9	20.1
	2	22.0	21.3	21.0	20.2
	3	21.0	20.5	20.5	20.5
	4	21.0	20.8	20.6	19.8
	5	22.5	21.9	21.2	21.2
HSDPA	1	22.5	21.8	21.6	21.6
	2	22.5	21.9	21.7	21.7
	3	22.0	21.4	21.2	21.2
	4	22.0	21.4	21.1	21.1
DC-HSDPA	1	22.5	21.7	21.7	21.7
	2	22.5	21.9	21.8	21.7
	3	22.0	21.4	21.3	21.2
	4	22.0	21.3	21.2	21.2
Item	band	WCDMA Band 5 result			
	ARFCN	Tune up	4233 (846.6MHz)	4182 (836.4MHz)	4132 (826.4MHz)
WCDMA	\	23.5	22.9	22.8	23.0
HSUPA	1	22.0	21.0	21.0	21.1
	2	22.0	21.1	21.1	21.2
	3	21.0	20.7	20.6	20.5
	4	21.0	20.4	20.8	20.6
	5	22.5	21.5	22.0	21.8
HSDPA	1	22.5	22.0	21.9	22.0
	2	22.5	22.1	22.0	22.1
	3	22.0	21.5	21.4	21.6
	4	22.0	21.5	21.6	21.5
DC-HSDPA	1	22.5	21.8	21.9	21.9
	2	22.5	22.0	22.0	21.9
	3	22.0	21.5	21.5	21.5
	4	22.0	21.4	21.5	21.6

<b>Full Power</b>					
Item	band	WCDMA Band 4 result			
	ARFCN	Tune up	1513 (1752.6MHz)	1413 (1732.6MHz)	1312 (1712.4MHz)
WCDMA	\	23.5	22.3	22.8	22.5
HSUPA	1	22.0	21.2	20.5	21.1
	2	22.0	21.3	20.6	21.2
	3	21.0	20.5	19.3	19.5
	4	21.0	20.8	20.1	19.8
	5	22.5	21.9	21.7	20.9
HSDPA	1	22.5	21.3	21.5	21.4
	2	22.5	21.4	21.6	21.5
	3	22.0	20.7	21.2	21.0
	4	22.0	20.7	21.2	21.0
DC-HSDPA	1	22.5	21.3	21.5	21.4
	2	22.5	21.4	21.6	21.5
	3	22.0	20.7	21.2	21.0
	4	22.0	20.7	21.2	21.0
<b>Hotspot on</b>					
Item	band	WCDMA Band 4 result			
	ARFCN	Tune up	1513 (1752.6MHz)	1413 (1732.6MHz)	1312 (1712.4MHz)
WCDMA	\	22.5	21.3	21.5	21.2
HSUPA	1	21.0	20.2	19.7	20.0
	2	21.0	20.3	19.8	20.2
	3	20.0	19.5	18.6	18.8
	4	20.0	19.8	19.1	19.0
	5	21.5	20.9	20.7	20.2
HSDPA	1	21.5	20.5	20.5	20.5
	2	21.5	20.6	20.5	20.4
	3	21.0	19.8	20.0	20.1
	4	21.0	19.7	19.9	20.0
DC-HSDPA	1	21.5	20.4	20.5	20.3
	2	21.5	20.3	20.4	20.3
	3	21.0	19.7	19.8	19.0
	4	21.0	19.8	19.9	20.0



#### 10.4. LTE Measurement result

According to April 2015 TCB workshop, SAR Test exclusion can be applied for testing overlapping LTE Bands as follows:

- a) The maximum out power, including tolerance, for the smaller band must be  $\leq$  the larger band to qualify for SAR test exclusion.
- b) The channel bandwidth and other operating parameters for the smaller band must be fully supported by the larger band.

LTE Band 2 (1850-1910MHz) is covered by LTE Band 25 (1850-1915MHz)

LTE Band 4 (1710-1755MHz) is covered by LTE Band 66 (1710-1780MHz)

LTE Band 17 (704-716MHz) is covered by LTE Band 12 (699-716MHz)

**Table 10.5: The conducted Power for LTE**

Full Power / Hotspot on								
LTE Band 5			Actual output Power (dBm)			Tune up		
Band -width	RB No. / RB offset	Frequency (MHz)	Modulation			Modulation		
			QPSK	16QAM	64QAM	QPSK	16QAM	64QAM
1.4 MHz	1RB_5	848.3	22.76	22.19	/	24.0	23.0	/
		836.5	22.92	21.57	/	24.0	23.0	/
		824.7	22.86	21.26	/	24.0	23.0	/
	1RB_3	848.3	22.86	21.34	/	24.0	23.0	/
		836.5	22.89	21.75	/	24.0	23.0	/
		824.7	22.78	21.41	/	24.0	23.0	/
	1RB_0	848.3	22.69	21.68	/	24.0	23.0	/
		836.5	22.84	21.60	/	24.0	23.0	/
		824.7	22.74	21.27	/	24.0	23.0	/
	3RB_3	848.3	22.98	21.99	/	24.0	23.0	/
		836.5	22.96	22.19	/	24.0	23.0	/
		824.7	22.86	21.73	/	24.0	23.0	/
	3RB_1	848.3	23.05	21.75	/	24.0	23.0	/
		836.5	22.90	22.29	/	24.0	23.0	/
		824.7	22.85	21.68	/	24.0	23.0	/
	3RB_0	848.3	22.92	21.72	/	24.0	23.0	/
		836.5	23.16	22.04	/	24.0	23.0	/
		824.7	22.87	21.70	/	24.0	23.0	/
	6RB_0	848.3	21.83	20.57	/	23.0	22.0	/
		836.5	21.87	20.80	/	23.0	22.0	/
		824.7	21.69	20.60	/	23.0	22.0	/

Full Power / Hotspot on								
LTE Band 5			Actual output Power (dBm)			Tune up		
Band -width	RB No. / RB offset	Frequency (MHz)	Modulation			Modulation		
			QPSK	16QAM	64QAM	QPSK	16QAM	64QAM
3 MHz	1RB_14	847.5	22.73	21.82	/	24.0	23.0	/
		836.5	22.97	22.14	/	24.0	23.0	/
		825.5	22.99	22.18	/	24.0	23.0	/
	1RB_7	847.5	23.00	21.30	/	24.0	23.0	/
		836.5	23.02	21.41	/	24.0	23.0	/
		825.5	23.07	21.62	/	24.0	23.0	/
	1RB_0	847.5	22.80	21.17	/	24.0	23.0	/
		836.5	22.80	21.17	/	24.0	23.0	/
		825.5	22.79	21.47	/	24.0	23.0	/
	8RB_7	847.5	21.99	21.06	/	23.0	22.0	/
		836.5	22.10	21.04	/	23.0	22.0	/
		825.5	21.98	21.07	/	23.0	22.0	/
	8RB_4	847.5	21.98	21.25	/	23.0	22.0	/
		836.5	22.02	21.09	/	23.0	22.0	/
		825.5	22.06	21.05	/	23.0	22.0	/
	8RB_0	847.5	21.90	21.15	/	23.0	22.0	/
		836.5	21.98	21.07	/	23.0	22.0	/
		825.5	22.01	21.10	/	23.0	22.0	/
	15RB_0	847.5	21.93	20.82	/	23.0	22.0	/
		836.5	21.98	21.04	/	23.0	22.0	/
		825.5	22.02	21.13	/	23.0	22.0	/

Full Power / Hotspot on								
LTE Band 5			Actual output Power (dBm)			Tune up		
Band -width	RB No. / RB offset	Frequency (MHz)	Modulation			Modulation		
			QPSK	16QAM	64QAM	QPSK	16QAM	64QAM
5 MHz	1RB_24	846.5	22.72	21.35	/	24.0	23.0	/
		836.5	22.98	22.13	/	24.0	23.0	/
		826.5	22.63	21.90	/	24.0	23.0	/
	1RB_12	846.5	22.76	21.65	/	24.0	23.0	/
		836.5	23.08	21.73	/	24.0	23.0	/
		826.5	22.98	21.95	/	24.0	23.0	/
	1RB_0	846.5	22.79	21.54	/	24.0	23.0	/
		836.5	22.78	21.35	/	24.0	23.0	/
		826.5	22.67	21.34	/	24.0	23.0	/
	12RB_13	846.5	21.93	20.66	/	23.0	22.0	/
		836.5	21.95	21.11	/	23.0	22.0	/
		826.5	21.96	20.91	/	23.0	22.0	/
	12RB_6	846.5	21.93	20.95	/	23.0	22.0	/
		836.5	22.05	21.21	/	23.0	22.0	/
		826.5	22.08	21.05	/	23.0	22.0	/
	12RB_0	846.5	21.85	20.87	/	23.0	22.0	/
		836.5	21.97	21.01	/	23.0	22.0	/
		826.5	21.97	20.92	/	23.0	22.0	/
	25RB_0	846.5	21.95	20.98	/	23.0	22.0	/
		836.5	21.97	21.14	/	23.0	22.0	/
		826.5	22.02	21.15	/	23.0	22.0	/

Full Power / Hotspot on								
LTE Band 5			Actual output Power (dBm)			Tune up		
Band -width	RB No. / RB offset	Frequency (MHz)	Modulation			Modulation		
			QPSK	16QAM	64QAM	QPSK	16QAM	64QAM
10 MHz	1RB_49	844.0	22.74	21.91	/	24.0	23.0	/
		836.5	22.72	21.44	/	24.0	23.0	/
		829.0	22.82	21.45	/	24.0	23.0	/
	1RB_24	844.0	23.00	21.23	/	24.0	23.0	/
		836.5	23.05	21.43	/	24.0	23.0	/
		829.0	23.02	21.75	/	24.0	23.0	/
	1RB_0	844.0	22.59	21.44	/	24.0	23.0	/
		836.5	22.62	21.88	/	24.0	23.0	/
		829.0	22.62	21.41	/	24.0	23.0	/
	25RB_25	844.0	21.87	20.92	/	23.0	22.0	/
		836.5	22.00	21.03	/	23.0	22.0	/
		829.0	21.95	20.96	/	23.0	22.0	/
	25RB_12	844.0	21.88	21.30	/	23.0	22.0	/
		836.5	22.13	21.26	/	23.0	22.0	/
		829.0	22.00	21.08	/	23.0	22.0	/
	25RB_0	844.0	21.88	21.20	/	23.0	22.0	/
		836.5	21.91	21.03	/	23.0	22.0	/
		829.0	21.96	20.97	/	23.0	22.0	/
	50RB_0	844.0	21.93	21.07	/	23.0	22.0	/
		836.5	22.11	21.03	/	23.0	22.0	/
		829.0	22.05	21.09	/	23.0	22.0	/

Full Power / Hotspot on								
LTE Band 12			Actual output Power (dBm)			Tune up		
Band -width	RB No. / RB offset	Frequency (MHz)	Modulation			Modulation		
			QPSK	16QAM	64QAM	QPSK	16QAM	64QAM
1.4 MHz	1RB_5	715.3	23.09	21.27	/	24.0	23.0	/
		707.5	23.03	21.93	/	24.0	23.0	/
		699.7	22.87	21.42	/	24.0	23.0	/
	1RB_3	715.3	23.03	21.72	/	24.0	23.0	/
		707.5	22.89	21.73	/	24.0	23.0	/
		699.7	22.86	21.46	/	24.0	23.0	/
	1RB_0	715.3	23.09	21.47	/	24.0	23.0	/
		707.5	22.79	21.54	/	24.0	23.0	/
		699.7	22.90	21.50	/	24.0	23.0	/
	3RB_3	715.3	23.18	22.29	/	24.0	23.0	/
		707.5	23.08	21.77	/	24.0	23.0	/
		699.7	22.93	22.05	/	24.0	23.0	/
	3RB_1	715.3	23.14	21.94	/	24.0	23.0	/
		707.5	23.06	21.93	/	24.0	23.0	/
		699.7	22.93	22.00	/	24.0	23.0	/
	3RB_0	715.3	23.21	22.04	/	24.0	23.0	/
		707.5	23.06	21.82	/	24.0	23.0	/
		699.7	22.91	22.06	/	24.0	23.0	/
	6RB_0	715.3	22.13	20.87	/	23.0	22.0	/
		707.5	22.05	21.13	/	23.0	22.0	/
		699.7	21.85	20.85	/	23.0	22.0	/

Full Power / Hotspot on								
LTE Band 12			Actual output Power (dBm)			Tune up		
Band -width	RB No. / RB offset	Frequency (MHz)	Modulation			Modulation		
			QPSK	16QAM	64QAM	QPSK	16QAM	64QAM
3 MHz	1RB_14	714.5	23.09	21.53	/	24.0	23.0	/
		707.5	23.05	21.29	/	24.0	23.0	/
		700.5	22.99	21.05	/	24.0	23.0	/
	1RB_7	714.5	23.17	21.76	/	24.0	23.0	/
		707.5	23.09	21.76	/	24.0	23.0	/
		700.5	22.96	21.48	/	24.0	23.0	/
	1RB_0	714.5	23.09	21.29	/	24.0	23.0	/
		707.5	23.05	21.54	/	24.0	23.0	/
		700.5	22.90	21.40	/	24.0	23.0	/
	8RB_7	714.5	22.20	21.29	/	23.0	22.0	/
		707.5	22.20	21.27	/	23.0	22.0	/
		700.5	21.92	21.13	/	23.0	22.0	/
	8RB_4	714.5	22.09	21.20	/	23.0	22.0	/
		707.5	22.16	21.12	/	23.0	22.0	/
		700.5	21.95	21.15	/	23.0	22.0	/
	8RB_0	714.5	22.07	21.38	/	23.0	22.0	/
		707.5	22.08	21.15	/	23.0	22.0	/
		700.5	21.98	21.27	/	23.0	22.0	/
	15RB_0	714.5	22.11	21.11	/	23.0	22.0	/
		707.5	22.15	20.85	/	23.0	22.0	/
		700.5	21.91	21.02	/	23.0	22.0	/

Full Power / Hotspot on								
LTE Band 12			Actual output Power (dBm)			Tune up		
Band -width	RB No. / RB offset	Frequency (MHz)	Modulation			Modulation		
			QPSK	16QAM	64QAM	QPSK	16QAM	64QAM
5 MHz	1RB_24	713.5	22.88	21.36	/	24.0	23.0	/
		707.5	22.74	21.54	/	24.0	23.0	/
		701.5	22.96	21.92	/	24.0	23.0	/
	1RB_12	713.5	23.12	21.57	/	24.0	23.0	/
		707.5	22.84	21.84	/	24.0	23.0	/
		701.5	22.98	22.07	/	24.0	23.0	/
	1RB_0	713.5	22.83	21.28	/	24.0	23.0	/
		707.5	22.83	21.73	/	24.0	23.0	/
		701.5	22.73	21.52	/	24.0	23.0	/
	12RB_13	713.5	22.06	21.00	/	23.0	22.0	/
		707.5	21.89	21.18	/	23.0	22.0	/
		701.5	21.71	20.90	/	23.0	22.0	/
	12RB_6	713.5	21.97	21.03	/	23.0	22.0	/
		707.5	22.03	21.13	/	23.0	22.0	/
		701.5	21.83	20.89	/	23.0	22.0	/
	12RB_0	713.5	21.79	20.73	/	23.0	22.0	/
		707.5	21.96	21.05	/	23.0	22.0	/
		701.5	21.77	21.01	/	23.0	22.0	/
	25RB_0	713.5	21.88	21.00	/	23.0	22.0	/
		707.5	21.93	21.01	/	23.0	22.0	/
		701.5	21.76	20.96	/	23.0	22.0	/

Full Power / Hotspot on								
LTE Band 12			Actual output Power (dBm)			Tune up		
Band -width	RB No. / RB offset	Frequency (MHz)	Modulation			Modulation		
			QPSK	16QAM	64QAM	QPSK	16QAM	64QAM
10 MHz	1RB_49	711.0	23.05	22.15	/	24.0	23.0	/
		707.5	22.84	22.02	/	24.0	23.0	/
		704.0	22.84	21.76	/	24.0	23.0	/
	1RB_24	711.0	23.06	21.65	/	24.0	23.0	/
		707.5	23.05	22.00	/	24.0	23.0	/
		704.0	23.14	22.03	/	24.0	23.0	/
	1RB_0	711.0	22.84	21.69	/	24.0	23.0	/
		707.5	22.61	21.48	/	24.0	23.0	/
		704.0	22.91	21.39	/	24.0	23.0	/
	25RB_25	711.0	22.00	20.98	/	23.0	22.0	/
		707.5	21.96	21.03	/	23.0	22.0	/
		704.0	22.02	21.06	/	23.0	22.0	/
	25RB_12	711.0	21.92	21.13	/	23.0	22.0	/
		707.5	21.95	20.97	/	23.0	22.0	/
		704.0	22.02	21.06	/	23.0	22.0	/
	25RB_0	711.0	21.95	21.03	/	23.0	22.0	/
		707.5	21.95	20.98	/	23.0	22.0	/
		704.0	21.74	20.99	/	23.0	22.0	/
	50RB_0	711.0	21.97	20.90	/	23.0	22.0	/
		707.5	21.90	21.03	/	23.0	22.0	/
		704.0	21.94	20.76	/	23.0	22.0	/



Full Power / Hotspot on								
LTE Band 13			Actual output Power (dBm)			Tune up		
Band -width	RB No. / RB offset	Frequency (MHz)	Modulation			Modulation		
			QPSK	16QAM	64QAM	QPSK	16QAM	64QAM
5 MHz	1RB_24	784.5	22.94	21.86	/	24.0	23.0	/
		782.0	23.17	21.76	/	24.0	23.0	/
		779.5	23.07	21.45	/	24.0	23.0	/
	1RB_12	784.5	23.21	21.93	/	24.0	23.0	/
		782.0	23.29	21.91	/	24.0	23.0	/
		779.5	23.16	21.84	/	24.0	23.0	/
	1RB_0	784.5	23.11	21.59	/	24.0	23.0	/
		782.0	22.98	21.48	/	24.0	23.0	/
		779.5	23.09	21.67	/	24.0	23.0	/
	12RB_13	784.5	22.25	21.13	/	23.0	22.0	/
		782.0	22.34	21.06	/	23.0	22.0	/
		779.5	22.27	21.11	/	23.0	22.0	/
	12RB_6	784.5	22.48	21.20	/	23.0	22.0	/
		782.0	22.31	21.02	/	23.0	22.0	/
		779.5	22.31	21.37	/	23.0	22.0	/
	12RB_0	784.5	22.29	21.02	/	23.0	22.0	/
		782.0	22.29	21.09	/	23.0	22.0	/
		779.5	22.25	21.20	/	23.0	22.0	/
25RB_0	784.5	22.25	21.10	/	23.0	22.0	/	
	782.0	22.32	21.09	/	23.0	22.0	/	
	779.5	22.27	21.17	/	23.0	22.0	/	
10 MHz	1RB_49	782.0	23.18	21.64	/	24.0	23.0	/
	1RB_24	782.0	23.18	22.21	/	24.0	23.0	/
	1RB_0	782.0	23.23	21.75	/	24.0	23.0	/
	25RB_25	782.0	22.26	21.38	/	23.0	22.0	/
	25RB_12	782.0	22.27	21.37	/	23.0	22.0	/
	25RB_0	782.0	22.21	21.28	/	23.0	22.0	/
	50RB_0	782.0	22.26	21.20	/	23.0	22.0	/

Full Power / Hotspot on								
LTE Band 25			Actual output Power (dBm)			Tune up		
Band -width	RB No. / RB offset	Frequency (MHz)	Modulation			Modulation		
			QPSK	16QAM	64QAM	QPSK	16QAM	64QAM
1.4 MHz	1RB_5	1914.3	22.78	21.47	/	24.0	23.0	/
		1882.5	22.70	21.46	/	24.0	23.0	/
		1850.7	23.06	21.63	/	24.0	23.0	/
	1RB_3	1914.3	22.75	21.90	/	24.0	23.0	/
		1882.5	22.77	21.76	/	24.0	23.0	/
		1850.7	23.10	21.80	/	24.0	23.0	/
	1RB_0	1914.3	22.76	22.08	/	24.0	23.0	/
		1882.5	22.65	21.63	/	24.0	23.0	/
		1850.7	22.99	21.70	/	24.0	23.0	/
	3RB_3	1914.3	22.96	21.80	/	24.0	23.0	/
		1882.5	22.76	21.61	/	24.0	23.0	/
		1850.7	23.28	22.26	/	24.0	23.0	/
	3RB_1	1914.3	23.09	21.83	/	24.0	23.0	/
		1882.5	22.89	21.72	/	24.0	23.0	/
		1850.7	23.21	22.05	/	24.0	23.0	/
	3RB_0	1914.3	22.94	21.82	/	24.0	23.0	/
		1882.5	22.85	21.69	/	24.0	23.0	/
		1850.7	23.32	21.98	/	24.0	23.0	/
	6RB_0	1914.3	21.82	20.81	/	23.0	22.0	/
		1882.5	21.79	20.78	/	23.0	22.0	/
		1850.7	22.10	21.02	/	23.0	22.0	/

Full Power / Hotspot on								
LTE Band 25			Actual output Power (dBm)			Tune up		
Band -width	RB No. / RB offset	Frequency (MHz)	Modulation			Modulation		
			QPSK	16QAM	64QAM	QPSK	16QAM	64QAM
3 MHz	1RB_14	1913.5	22.92	21.58	/	24.0	23.0	/
		1882.5	22.76	21.98	/	24.0	23.0	/
		1851.5	22.90	21.67	/	24.0	23.0	/
	1RB_7	1913.5	22.94	21.82	/	24.0	23.0	/
		1882.5	22.88	22.01	/	24.0	23.0	/
		1851.5	23.09	21.85	/	24.0	23.0	/
	1RB_0	1913.5	22.82	21.52	/	24.0	23.0	/
		1882.5	22.70	21.57	/	24.0	23.0	/
		1851.5	22.90	21.65	/	24.0	23.0	/
	8RB_7	1913.5	22.03	21.17	/	23.0	22.0	/
		1882.5	21.87	20.87	/	23.0	22.0	/
		1851.5	22.10	21.13	/	23.0	22.0	/
	8RB_4	1913.5	22.14	21.17	/	23.0	22.0	/
		1882.5	21.84	21.12	/	23.0	22.0	/
		1851.5	22.10	21.35	/	23.0	22.0	/
	8RB_0	1913.5	22.05	21.19	/	23.0	22.0	/
		1882.5	21.93	21.02	/	23.0	22.0	/
		1851.5	22.14	21.27	/	23.0	22.0	/
	15RB_0	1913.5	21.96	20.82	/	23.0	22.0	/
		1882.5	21.91	20.67	/	23.0	22.0	/
		1851.5	22.07	21.12	/	23.0	22.0	/

Full Power / Hotspot on								
LTE Band 25			Actual output Power (dBm)			Tune up		
Band -width	RB No. / RB offset	Frequency (MHz)	Modulation			Modulation		
			QPSK	16QAM	64QAM	QPSK	16QAM	64QAM
5 MHz	1RB_24	1912.5	22.90	21.38	/	24.0	23.0	/
		1882.5	22.52	22.05	/	24.0	23.0	/
		1852.5	22.92	22.34	/	24.0	23.0	/
	1RB_12	1912.5	23.03	21.56	/	24.0	23.0	/
		1882.5	22.64	21.81	/	24.0	23.0	/
		1852.5	23.10	21.78	/	24.0	23.0	/
	1RB_0	1912.5	22.75	21.54	/	24.0	23.0	/
		1882.5	22.70	21.41	/	24.0	23.0	/
		1852.5	22.89	22.20	/	24.0	23.0	/
	12RB_13	1912.5	21.99	20.86	/	23.0	22.0	/
		1882.5	21.83	20.84	/	23.0	22.0	/
		1852.5	22.00	21.04	/	23.0	22.0	/
	12RB_6	1912.5	22.00	20.89	/	23.0	22.0	/
		1882.5	21.85	20.87	/	23.0	22.0	/
		1852.5	21.99	21.02	/	23.0	22.0	/
	12RB_0	1912.5	21.91	20.80	/	23.0	22.0	/
		1882.5	21.78	20.90	/	23.0	22.0	/
		1852.5	22.07	21.06	/	23.0	22.0	/
	25RB_0	1912.5	22.03	21.12	/	23.0	22.0	/
		1882.5	21.90	20.95	/	23.0	22.0	/
		1852.5	22.05	20.98	/	23.0	22.0	/

Full Power / Hotspot on								
LTE Band 25			Actual output Power (dBm)			Tune up		
Band -width	RB No. / RB offset	Frequency (MHz)	Modulation			Modulation		
			QPSK	16QAM	64QAM	QPSK	16QAM	64QAM
10 MHz	1RB_49	1910.0	22.69	21.70	/	24.0	23.0	/
		1882.5	22.81	21.25	/	24.0	23.0	/
		1855.0	23.07	21.29	/	24.0	23.0	/
	1RB_24	1910.0	22.79	21.85	/	24.0	23.0	/
		1882.5	22.80	21.39	/	24.0	23.0	/
		1855.0	23.03	21.59	/	24.0	23.0	/
	1RB_0	1910.0	22.69	21.53	/	24.0	23.0	/
		1882.5	22.93	21.15	/	24.0	23.0	/
		1855.0	23.07	21.66	/	24.0	23.0	/
	25RB_25	1910.0	21.81	21.05	/	23.0	22.0	/
		1882.5	21.80	20.83	/	23.0	22.0	/
		1855.0	21.96	21.00	/	23.0	22.0	/
	25RB_12	1910.0	21.99	21.15	/	23.0	22.0	/
		1882.5	21.87	21.02	/	23.0	22.0	/
		1855.0	22.06	21.23	/	23.0	22.0	/
	25RB_0	1910.0	21.83	20.91	/	23.0	22.0	/
		1882.5	21.88	20.91	/	23.0	22.0	/
		1855.0	22.02	20.93	/	23.0	22.0	/
	50RB_0	1910.0	21.96	21.05	/	23.0	22.0	/
		1882.5	21.94	20.99	/	23.0	22.0	/
		1855.0	22.05	21.09	/	23.0	22.0	/

Full Power / Hotspot on								
LTE Band 25			Actual output Power (dBm)			Tune up		
Band -width	RB No. / RB offset	Frequency (MHz)	Modulation			Modulation		
			QPSK	16QAM	64QAM	QPSK	16QAM	64QAM
15 MHz	1RB_74	1907.5	22.67	21.67	/	24.0	23.0	/
		1882.5	22.77	21.95	/	24.0	23.0	/
		1857.5	22.99	22.11	/	24.0	23.0	/
	1RB_37	1907.5	22.72	21.46	/	24.0	23.0	/
		1882.5	22.62	21.98	/	24.0	23.0	/
		1857.5	23.01	21.55	/	24.0	23.0	/
	1RB_0	1907.5	22.51	21.34	/	24.0	23.0	/
		1882.5	22.87	21.44	/	24.0	23.0	/
		1857.5	22.92	21.35	/	24.0	23.0	/
	36RB_38	1907.5	21.94	20.92	/	23.0	22.0	/
		1882.5	21.79	20.84	/	23.0	22.0	/
		1857.5	21.98	21.05	/	23.0	22.0	/
	36RB_19	1907.5	21.83	20.92	/	23.0	22.0	/
		1882.5	21.86	21.05	/	23.0	22.0	/
		1857.5	22.04	21.00	/	23.0	22.0	/
	36RB_0	1907.5	21.78	20.79	/	23.0	22.0	/
		1882.5	21.80	20.98	/	23.0	22.0	/
		1857.5	21.92	20.98	/	23.0	22.0	/
	75RB_0	1907.5	21.86	20.97	/	23.0	22.0	/
		1882.5	21.91	20.85	/	23.0	22.0	/
		1857.5	21.96	21.01	/	23.0	22.0	/

Full Power / Hotspot on								
LTE Band 25			Actual output Power (dBm)			Tune up		
Band -width	RB No. / RB offset	Frequency (MHz)	Modulation			Modulation		
			QPSK	16QAM	64QAM	QPSK	16QAM	64QAM
20 MHz	1RB_99	1905.0	22.15	21.49	/	24.0	23.0	/
		1882.5	22.87	21.93	/	24.0	23.0	/
		1860.0	22.73	21.28	/	24.0	23.0	/
	1RB_50	1905.0	22.81	22.35	/	24.0	23.0	/
		1882.5	22.80	22.13	/	24.0	23.0	/
		1860.0	23.10	21.75	/	24.0	23.0	/
	1RB_0	1905.0	<b>22.82</b>	21.72	/	24.0	23.0	/
		1882.5	<b>22.88</b>	21.13	/	24.0	23.0	/
		1860.0	<b>23.14</b>	21.76	/	24.0	23.0	/
	50RB_50	1905.0	21.90	20.92	/	23.0	22.0	/
		1882.5	21.78	20.93	/	23.0	22.0	/
		1860.0	21.95	21.01	/	23.0	22.0	/
	50RB_25	1905.0	21.90	20.92	/	23.0	22.0	/
		1882.5	21.92	20.97	/	23.0	22.0	/
		1860.0	<b>22.00</b>	20.96	/	23.0	22.0	/
	50RB_0	1905.0	21.79	20.91	/	23.0	22.0	/
		1882.5	21.89	20.86	/	23.0	22.0	/
		1860.0	21.99	21.05	/	23.0	22.0	/
	100RB_0	1905.0	21.88	20.91	/	23.0	22.0	/
		1882.5	21.90	20.94	/	23.0	22.0	/
		1860.0	<b>22.02</b>	21.08	/	23.0	22.0	/

Full Power / Hotspot on								
LTE Band 26			Actual output Power (dBm)			Tune up		
Band -width	RB No. / RB offset	Frequency (MHz)	Modulation			Modulation		
			QPSK	16QAM	64QAM	QPSK	16QAM	64QAM
1.4 MHz	1RB_5	848.3	22.75	21.64	/	24.0	23.0	/
		831.5	23.12	22.39	/	24.0	23.0	/
		814.7	23.28	21.91	/	24.0	23.0	/
	1RB_3	848.3	23.00	21.77	/	24.0	23.0	/
		831.5	23.15	21.89	/	24.0	23.0	/
		814.7	23.28	21.91	/	24.0	23.0	/
	1RB_0	848.3	22.77	21.67	/	24.0	23.0	/
		831.5	23.05	21.80	/	24.0	23.0	/
		814.7	23.18	21.82	/	24.0	23.0	/
	3RB_3	848.3	23.09	22.31	/	24.0	23.0	/
		831.5	23.22	22.35	/	24.0	23.0	/
		814.7	23.35	22.15	/	24.0	23.0	/
	3RB_1	848.3	23.23	22.09	/	24.0	23.0	/
		831.5	23.52	22.37	/	24.0	23.0	/
		814.7	23.24	22.15	/	24.0	23.0	/
	3RB_0	848.3	23.11	22.14	/	24.0	23.0	/
		831.5	23.34	21.92	/	24.0	23.0	/
		814.7	23.32	22.27	/	24.0	23.0	/
	6RB_0	848.3	21.89	21.04	/	23.0	22.0	/
		831.5	22.14	21.08	/	23.0	22.0	/
		814.7	22.23	21.10	/	23.0	22.0	/



Full Power / Hotspot on								
LTE Band 26			Actual output Power (dBm)			Tune up		
Band -width	RB No. / RB offset	Frequency (MHz)	Modulation			Modulation		
			QPSK	16QAM	64QAM	QPSK	16QAM	64QAM
3 MHz	1RB_14	847.5	22.71	21.62	/	24.0	23.0	/
		831.5	23.12	22.25	/	24.0	23.0	/
		815.5	22.89	21.71	/	24.0	23.0	/
	1RB_7	847.5	22.91	21.81	/	24.0	23.0	/
		831.5	23.26	22.47	/	24.0	23.0	/
		815.5	22.79	21.77	/	24.0	23.0	/
	1RB_0	847.5	22.78	21.82	/	24.0	23.0	/
		831.5	23.21	22.45	/	24.0	23.0	/
		815.5	22.93	21.75	/	24.0	23.0	/
	8RB_7	847.5	22.04	21.30	/	23.0	22.0	/
		831.5	22.17	21.34	/	23.0	22.0	/
		815.5	21.98	21.05	/	23.0	22.0	/
	8RB_4	847.5	22.04	21.18	/	23.0	22.0	/
		831.5	22.19	21.23	/	23.0	22.0	/
		815.5	22.00	21.16	/	23.0	22.0	/
	8RB_0	847.5	22.04	21.19	/	23.0	22.0	/
		831.5	22.10	21.15	/	23.0	22.0	/
		815.5	22.03	21.10	/	23.0	22.0	/
	15RB_0	847.5	21.99	21.20	/	23.0	22.0	/
		831.5	22.14	21.30	/	23.0	22.0	/
		815.5	21.86	20.73	/	23.0	22.0	/

Full Power / Hotspot on								
LTE Band 26			Actual output Power (dBm)			Tune up		
Band -width	RB No. / RB offset	Frequency (MHz)	Modulation			Modulation		
			QPSK	16QAM	64QAM	QPSK	16QAM	64QAM
5 MHz	1RB_24	846.5	22.69	21.44	/	24.0	23.0	/
		831.5	23.07	22.23	/	24.0	23.0	/
		816.5	23.13	21.62	/	24.0	23.0	/
	1RB_12	846.5	22.98	21.80	/	24.0	23.0	/
		831.5	23.31	22.58	/	24.0	23.0	/
		816.5	23.38	21.96	/	24.0	23.0	/
	1RB_0	846.5	22.86	21.80	/	24.0	23.0	/
		831.5	23.01	22.47	/	24.0	23.0	/
		816.5	23.07	21.43	/	24.0	23.0	/
	12RB_13	846.5	21.87	21.14	/	23.0	22.0	/
		831.5	22.16	21.04	/	23.0	22.0	/
		816.5	22.32	21.07	/	23.0	22.0	/
	12RB_6	846.5	22.06	20.97	/	23.0	22.0	/
		831.5	22.19	20.98	/	23.0	22.0	/
		816.5	22.28	21.14	/	23.0	22.0	/
	12RB_0	846.5	22.08	21.28	/	23.0	22.0	/
		831.5	22.04	20.92	/	23.0	22.0	/
		816.5	22.22	21.26	/	23.0	22.0	/
	25RB_0	846.5	21.97	21.09	/	23.0	22.0	/
		831.5	22.11	21.14	/	23.0	22.0	/
		816.5	22.27	21.32	/	23.0	22.0	/

Full Power / Hotspot on								
LTE Band 26			Actual output Power (dBm)			Tune up		
Band -width	RB No. / RB offset	Frequency (MHz)	Modulation			Modulation		
			QPSK	16QAM	64QAM	QPSK	16QAM	64QAM
10 MHz	1RB_49	844.0	23.03	22.13	/	24.0	23.0	/
		831.5	22.97	22.31	/	24.0	23.0	/
		820.0	23.15	21.71	/	24.0	23.0	/
	1RB_24	844.0	23.16	22.23	/	24.0	23.0	/
		831.5	23.26	22.32	/	24.0	23.0	/
		820.0	23.30	22.43	/	24.0	23.0	/
	1RB_0	844.0	23.06	21.76	/	24.0	23.0	/
		831.5	23.03	21.74	/	24.0	23.0	/
		820.0	22.93	21.72	/	24.0	23.0	/
	25RB_25	844.0	21.98	21.13	/	23.0	22.0	/
		831.5	22.23	21.13	/	23.0	22.0	/
		820.0	22.29	21.32	/	23.0	22.0	/
	25RB_12	844.0	22.20	21.38	/	23.0	22.0	/
		831.5	22.15	21.18	/	23.0	22.0	/
		820.0	22.32	21.34	/	23.0	22.0	/
	25RB_0	844.0	22.02	21.23	/	23.0	22.0	/
		831.5	22.11	21.12	/	23.0	22.0	/
		820.0	22.21	21.24	/	23.0	22.0	/
	50RB_0	844.0	22.12	21.22	/	23.0	22.0	/
		831.5	22.21	21.23	/	23.0	22.0	/
		820.0	22.33	21.36	/	23.0	22.0	/

Full Power / Hotspot on								
LTE Band 26			Actual output Power (dBm)			Tune up		
Band -width	RB No. / RB offset	Frequency (MHz)	Modulation			Modulation		
			QPSK	16QAM	64QAM	QPSK	16QAM	64QAM
15 MHz	1RB_74	841.5	22.82	21.78	/	24.0	23.0	/
		831.5	22.85	21.78	/	24.0	23.0	/
		822.5	23.25	22.44	/	24.0	23.0	/
	1RB_37	841.5	23.24	21.72	/	24.0	23.0	/
		831.5	23.21	21.74	/	24.0	23.0	/
		822.5	23.19	21.65	/	24.0	23.0	/
	1RB_0	841.5	23.01	21.66	/	24.0	23.0	/
		831.5	22.82	21.78	/	24.0	23.0	/
		822.5	23.02	21.93	/	24.0	23.0	/
	36RB_38	841.5	22.20	21.22	/	23.0	22.0	/
		831.5	22.25	21.28	/	23.0	22.0	/
		822.5	22.32	21.17	/	23.0	22.0	/
	36RB_19	841.5	22.16	21.17	/	23.0	22.0	/
		831.5	22.28	21.31	/	23.0	22.0	/
		822.5	22.36	21.30	/	23.0	22.0	/
	36RB_0	841.5	22.13	21.04	/	23.0	22.0	/
		831.5	22.20	21.31	/	23.0	22.0	/
		822.5	22.24	21.27	/	23.0	22.0	/
	75RB_0	841.5	22.16	21.18	/	23.0	22.0	/
		831.5	22.27	21.10	/	23.0	22.0	/
		822.5	22.29	21.22	/	23.0	22.0	/

Full Power / Hotspot on								
LTE Band 66			Actual output Power (dBm)			Tune up		
Band -width	RB No. / RB offset	Frequency (MHz)	Modulation			Modulation		
			QPSK	16QAM	64QAM	QPSK	16QAM	64QAM
1.4 MHz	1RB_5	1779.3	23.07	21.72	/	24.0	23.0	/
		1745.0	23.24	22.02	/	24.0	23.0	/
		1710.7	23.14	21.80	/	24.0	23.0	/
	1RB_3	1779.3	23.16	21.99	/	24.0	23.0	/
		1745.0	23.31	22.10	/	24.0	23.0	/
		1710.7	23.16	21.97	/	24.0	23.0	/
	1RB_0	1779.3	23.06	21.72	/	24.0	23.0	/
		1745.0	23.11	21.97	/	24.0	23.0	/
		1710.7	22.96	21.87	/	24.0	23.0	/
	3RB_3	1779.3	23.14	22.35	/	24.0	23.0	/
		1745.0	23.45	22.47	/	24.0	23.0	/
		1710.7	23.27	22.03	/	24.0	23.0	/
	3RB_1	1779.3	23.21	22.18	/	24.0	23.0	/
		1745.0	23.46	22.63	/	24.0	23.0	/
		1710.7	23.28	21.96	/	24.0	23.0	/
	3RB_0	1779.3	23.18	22.01	/	24.0	23.0	/
		1745.0	23.31	22.39	/	24.0	23.0	/
		1710.7	23.41	22.02	/	24.0	23.0	/
	6RB_0	1779.3	22.14	21.23	/	23.0	22.0	/
		1745.0	22.32	21.27	/	23.0	22.0	/
		1710.7	22.13	21.08	/	23.0	22.0	/

Full Power / Hotspot on								
LTE Band 66			Actual output Power (dBm)			Tune up		
Band -width	RB No. / RB offset	Frequency (MHz)	Modulation			Modulation		
			QPSK	16QAM	64QAM	QPSK	16QAM	64QAM
3 MHz	1RB_14	1778.5	23.08	21.80	/	24.0	23.0	/
		1745.0	23.20	21.59	/	24.0	23.0	/
		1711.5	22.91	22.18	/	24.0	23.0	/
	1RB_7	1778.5	23.07	21.75	/	24.0	23.0	/
		1745.0	23.19	21.90	/	24.0	23.0	/
		1711.5	23.05	22.32	/	24.0	23.0	/
	1RB_0	1778.5	23.16	21.75	/	24.0	23.0	/
		1745.0	23.28	21.76	/	24.0	23.0	/
		1711.5	23.23	21.95	/	24.0	23.0	/
	8RB_7	1778.5	22.09	21.20	/	23.0	22.0	/
		1745.0	22.39	21.47	/	23.0	22.0	/
		1711.5	22.23	21.10	/	23.0	22.0	/
	8RB_4	1778.5	22.21	21.23	/	23.0	22.0	/
		1745.0	22.40	21.38	/	23.0	22.0	/
		1711.5	22.11	21.09	/	23.0	22.0	/
	8RB_0	1778.5	22.14	21.28	/	23.0	22.0	/
		1745.0	22.33	21.40	/	23.0	22.0	/
		1711.5	22.13	21.14	/	23.0	22.0	/
	15RB_0	1778.5	22.09	21.04	/	23.0	22.0	/
		1745.0	22.36	21.40	/	23.0	22.0	/
		1711.5	22.18	21.24	/	23.0	22.0	/

Full Power / Hotspot on								
LTE Band 66			Actual output Power (dBm)			Tune up		
Band -width	RB No. / RB offset	Frequency (MHz)	Modulation			Modulation		
			QPSK	16QAM	64QAM	QPSK	16QAM	64QAM
5 MHz	1RB_24	1777.5	22.95	21.67	/	24.0	23.0	/
		1745.0	23.27	21.67	/	24.0	23.0	/
		1712.5	23.06	21.59	/	24.0	23.0	/
	1RB_12	1777.5	22.92	21.69	/	24.0	23.0	/
		1745.0	23.30	21.87	/	24.0	23.0	/
		1712.5	23.03	21.84	/	24.0	23.0	/
	1RB_0	1777.5	23.12	21.77	/	24.0	23.0	/
		1745.0	23.23	21.73	/	24.0	23.0	/
		1712.5	22.91	21.59	/	24.0	23.0	/
	12RB_13	1777.5	21.99	21.05	/	23.0	22.0	/
		1745.0	22.32	21.27	/	23.0	22.0	/
		1712.5	22.09	21.13	/	23.0	22.0	/
	12RB_6	1777.5	22.17	21.07	/	23.0	22.0	/
		1745.0	22.31	21.35	/	23.0	22.0	/
		1712.5	22.00	20.96	/	23.0	22.0	/
	12RB_0	1777.5	22.17	21.16	/	23.0	22.0	/
		1745.0	22.23	21.19	/	23.0	22.0	/
		1712.5	21.97	21.02	/	23.0	22.0	/
	25RB_0	1777.5	21.97	21.17	/	23.0	22.0	/
		1745.0	22.37	21.61	/	23.0	22.0	/
		1712.5	22.08	21.14	/	23.0	22.0	/

Full Power / Hotspot on								
LTE Band 66			Actual output Power (dBm)			Tune up		
Band -width	RB No. / RB offset	Frequency (MHz)	Modulation			Modulation		
			QPSK	16QAM	64QAM	QPSK	16QAM	64QAM
10 MHz	1RB_49	1775.0	23.09	21.18	/	24.0	23.0	/
		1745.0	23.41	22.49	/	24.0	23.0	/
		1715.0	23.24	22.30	/	24.0	23.0	/
	1RB_24	1775.0	23.15	21.75	/	24.0	23.0	/
		1745.0	23.41	22.48	/	24.0	23.0	/
		1715.0	23.13	21.58	/	24.0	23.0	/
	1RB_0	1775.0	23.13	21.67	/	24.0	23.0	/
		1745.0	23.41	22.02	/	24.0	23.0	/
		1715.0	23.09	21.75	/	24.0	23.0	/
	25RB_25	1775.0	22.01	21.10	/	23.0	22.0	/
		1745.0	22.39	21.40	/	23.0	22.0	/
		1715.0	22.04	21.17	/	23.0	22.0	/
	25RB_12	1775.0	22.18	21.22	/	23.0	22.0	/
		1745.0	22.34	21.44	/	23.0	22.0	/
		1715.0	22.12	21.23	/	23.0	22.0	/
	25RB_0	1775.0	22.08	21.14	/	23.0	22.0	/
		1745.0	22.33	21.26	/	23.0	22.0	/
		1715.0	22.07	21.11	/	23.0	22.0	/
	50RB_0	1775.0	22.12	21.11	/	23.0	22.0	/
		1745.0	22.31	21.42	/	23.0	22.0	/
		1715.0	22.15	21.19	/	23.0	22.0	/



Full Power / Hotspot on								
LTE Band 66			Actual output Power (dBm)			Tune up		
Band -width	RB No. / RB offset	Frequency (MHz)	Modulation			Modulation		
			QPSK	16QAM	64QAM	QPSK	16QAM	64QAM
15 MHz	1RB_74	1772.5	23.12	21.85	/	24.0	23.0	/
		1745.0	23.39	21.90	/	24.0	23.0	/
		1717.5	23.25	21.73	/	24.0	23.0	/
	1RB_37	1772.5	23.16	22.49	/	24.0	23.0	/
		1745.0	23.36	22.52	/	24.0	23.0	/
		1717.5	23.09	21.83	/	24.0	23.0	/
	1RB_0	1772.5	22.99	21.81	/	24.0	23.0	/
		1745.0	23.24	21.98	/	24.0	23.0	/
		1717.5	23.20	21.77	/	24.0	23.0	/
	36RB_38	1772.5	22.11	21.17	/	23.0	22.0	/
		1745.0	22.31	21.36	/	23.0	22.0	/
		1717.5	22.19	21.15	/	23.0	22.0	/
	36RB_19	1772.5	22.10	21.19	/	23.0	22.0	/
		1745.0	22.37	21.43	/	23.0	22.0	/
		1717.5	22.04	21.11	/	23.0	22.0	/
	36RB_0	1772.5	22.06	21.15	/	23.0	22.0	/
		1745.0	22.27	21.42	/	23.0	22.0	/
		1717.5	21.98	21.04	/	23.0	22.0	/
	75RB_0	1772.5	22.12	21.22	/	23.0	22.0	/
		1745.0	22.39	21.43	/	23.0	22.0	/
		1717.5	22.09	21.15	/	23.0	22.0	/

Full Power / Hotspot on								
LTE Band 66			Actual output Power (dBm)			Tune up		
Band -width	RB No. / RB offset	Frequency (MHz)	Modulation			Modulation		
			QPSK	16QAM	64QAM	QPSK	16QAM	64QAM
20 MHz	1RB_99	1770.0	22.89	21.62	/	<b>24.0</b>	<b>23.0</b>	/
		1745.0	23.34	21.79	/	<b>24.0</b>	<b>23.0</b>	/
		1720.0	23.05	21.47	/	<b>24.0</b>	<b>23.0</b>	/
	1RB_50	1770.0	<b>23.24</b>	22.49	/	<b>24.0</b>	<b>23.0</b>	/
		1745.0	<b>23.43</b>	21.80	/	<b>24.0</b>	<b>23.0</b>	/
		1720.0	<b>23.28</b>	21.79	/	<b>24.0</b>	<b>23.0</b>	/
	1RB_0	1770.0	22.99	21.87	/	<b>24.0</b>	<b>23.0</b>	/
		1745.0	23.42	21.86	/	<b>24.0</b>	<b>23.0</b>	/
		1720.0	23.07	21.57	/	<b>24.0</b>	<b>23.0</b>	/
	50RB_50	1770.0	22.08	21.25	/	<b>23.0</b>	<b>22.0</b>	/
		1745.0	22.30	21.39	/	<b>23.0</b>	<b>22.0</b>	/
		1720.0	22.15	21.27	/	<b>23.0</b>	<b>22.0</b>	/
	50RB_25	1770.0	<b>22.18</b>	21.19	/	<b>23.0</b>	<b>22.0</b>	/
		1745.0	<b>22.31</b>	21.39	/	<b>23.0</b>	<b>22.0</b>	/
		1720.0	<b>22.17</b>	21.28	/	<b>23.0</b>	<b>22.0</b>	/
	50RB_0	1770.0	22.08	21.32	/	<b>23.0</b>	<b>22.0</b>	/
		1745.0	22.27	21.26	/	<b>23.0</b>	<b>22.0</b>	/
		1720.0	22.04	21.14	/	<b>23.0</b>	<b>22.0</b>	/
	100RB_0	1770.0	22.13	21.16	/	<b>23.0</b>	<b>22.0</b>	/
		1745.0	<b>22.40</b>	21.39	/	<b>23.0</b>	<b>22.0</b>	/
		1720.0	22.16	21.16	/	<b>23.0</b>	<b>22.0</b>	/



Full Power / Hotspot on								
LTE Band 71			Actual output Power (dBm)			Tune up		
Band -width	RB No. / RB offset	Frequency (MHz)	Modulation			Modulation		
			QPSK	16QAM	64QAM	QPSK	16QAM	64QAM
5 MHz	1RB_24	695.5	22.79	21.33	/	24.0	23.0	/
		680.5	22.50	21.16	/	24.0	23.0	/
		665.5	22.64	20.98	/	24.0	23.0	/
	1RB_12	695.5	22.68	21.28	/	24.0	23.0	/
		680.5	22.77	21.41	/	24.0	23.0	/
		665.5	22.85	21.23	/	24.0	23.0	/
	1RB_0	695.5	22.57	21.24	/	24.0	23.0	/
		680.5	22.82	21.05	/	24.0	23.0	/
		665.5	22.47	20.90	/	24.0	23.0	/
	12RB_13	695.5	21.61	20.61	/	23.0	22.0	/
		680.5	21.70	20.64	/	23.0	22.0	/
		665.5	21.65	20.65	/	23.0	22.0	/
	12RB_6	695.5	21.73	20.65	/	23.0	22.0	/
		680.5	21.81	20.63	/	23.0	22.0	/
		665.5	21.63	20.59	/	23.0	22.0	/
	12RB_0	695.5	21.83	20.65	/	23.0	22.0	/
		680.5	21.81	20.75	/	23.0	22.0	/
		665.5	21.57	20.50	/	23.0	22.0	/
	25RB_0	695.5	21.71	20.73	/	23.0	22.0	/
		680.5	21.77	20.89	/	23.0	22.0	/
		665.5	21.62	20.64	/	23.0	22.0	/

Full Power / Hotspot on								
LTE Band 71			Actual output Power (dBm)			Tune up		
Band -width	RB No. / RB offset	Frequency (MHz)	Modulation			Modulation		
			QPSK	16QAM	64QAM	QPSK	16QAM	64QAM
10 MHz	1RB_49	693.0	22.55	21.16	/	24.0	23.0	/
		680.5	22.68	20.74	/	24.0	23.0	/
		668.0	22.50	20.95	/	24.0	23.0	/
	1RB_24	693.0	22.90	21.26	/	24.0	23.0	/
		680.5	22.99	21.09	/	24.0	23.0	/
		668.0	22.86	21.02	/	24.0	23.0	/
	1RB_0	693.0	22.60	21.30	/	24.0	23.0	/
		680.5	22.79	20.77	/	24.0	23.0	/
		668.0	22.42	21.27	/	24.0	23.0	/
	25RB_25	693.0	21.71	20.72	/	23.0	22.0	/
		680.5	21.73	20.95	/	23.0	22.0	/
		668.0	21.68	20.73	/	23.0	22.0	/
	25RB_12	693.0	21.82	20.85	/	23.0	22.0	/
		680.5	21.86	21.07	/	23.0	22.0	/
		668.0	21.64	20.80	/	23.0	22.0	/
	25RB_0	693.0	21.77	20.89	/	23.0	22.0	/
		680.5	21.82	20.93	/	23.0	22.0	/
		668.0	21.60	20.57	/	23.0	22.0	/
	50RB_0	693.0	21.80	20.84	/	23.0	22.0	/
		680.5	21.88	20.77	/	23.0	22.0	/
		668.0	21.78	20.87	/	23.0	22.0	/

Full Power / Hotspot on								
LTE Band 71			Actual output Power (dBm)			Tune up		
Band -width	RB No. / RB offset	Frequency (MHz)	Modulation			Modulation		
			QPSK	16QAM	64QAM	QPSK	16QAM	64QAM
15 MHz	1RB_74	690.5	22.59	21.28	/	24.0	23.0	/
		680.5	22.69	21.15	/	24.0	23.0	/
		670.5	22.70	21.16	/	24.0	23.0	/
	1RB_37	690.5	22.86	21.94	/	24.0	23.0	/
		680.5	22.81	21.68	/	24.0	23.0	/
		670.5	22.60	21.19	/	24.0	23.0	/
	1RB_0	690.5	22.57	21.16	/	24.0	23.0	/
		680.5	22.72	20.59	/	24.0	23.0	/
		670.5	22.63	21.11	/	24.0	23.0	/
	36RB_38	690.5	21.76	20.67	/	23.0	22.0	/
		680.5	21.69	20.81	/	23.0	22.0	/
		670.5	21.87	20.89	/	23.0	22.0	/
	36RB_19	690.5	21.88	20.90	/	23.0	22.0	/
		680.5	21.86	20.89	/	23.0	22.0	/
		670.5	21.66	20.68	/	23.0	22.0	/
	36RB_0	690.5	21.66	20.67	/	23.0	22.0	/
		680.5	21.81	20.82	/	23.0	22.0	/
		670.5	21.51	20.54	/	23.0	22.0	/
	75RB_0	690.5	21.78	20.68	/	23.0	22.0	/
		680.5	21.80	20.83	/	23.0	22.0	/
		670.5	21.76	20.69	/	23.0	22.0	/

Full Power / Hotspot on								
LTE Band 71			Actual output Power (dBm)			Tune up		
Band -width	RB No. / RB offset	Frequency (MHz)	Modulation			Modulation		
			QPSK	16QAM	64QAM	QPSK	16QAM	64QAM
20 MHz	1RB_99	688.0	22.55	21.17	/	24.0	23.0	/
		683.0	22.60	21.35	/	24.0	23.0	/
		673.0	22.71	21.31	/	24.0	23.0	/
	1RB_50	688.0	23.02	21.25	/	24.0	23.0	/
		683.0	22.92	22.14	/	24.0	23.0	/
		673.0	22.98	21.32	/	24.0	23.0	/
	1RB_0	688.0	22.58	21.16	/	24.0	23.0	/
		683.0	22.47	21.35	/	24.0	23.0	/
		673.0	22.58	20.95	/	24.0	23.0	/
	50RB_50	688.0	21.85	20.73	/	23.0	22.0	/
		683.0	21.75	20.79	/	23.0	22.0	/
		673.0	21.84	20.79	/	23.0	22.0	/
	50RB_25	688.0	21.81	20.86	/	23.0	22.0	/
		683.0	21.87	20.82	/	23.0	22.0	/
		673.0	21.89	20.85	/	23.0	22.0	/
	50RB_0	688.0	21.74	20.65	/	23.0	22.0	/
		683.0	21.82	20.77	/	23.0	22.0	/
		673.0	21.70	20.78	/	23.0	22.0	/
	100RB_0	688.0	21.79	20.79	/	23.0	22.0	/
		683.0	21.83	20.89	/	23.0	22.0	/
		673.0	21.81	20.79	/	23.0	22.0	/

Full Power								
LTE Band 41 PC3			Actual output Power (dBm)			Tune up		
Band -width	RB No. / RB offset	Frequency (MHz)	Modulation			Modulation		
			QPSK	16QAM	64QAM	QPSK	16QAM	64QAM
5 MHz	1RB_24	2687.5	23.02	21.85	/	24.5	23.5	/
		2640.3	23.29	21.61	/	24.5	23.5	/
		2593.0	23.05	21.92	/	24.5	23.5	/
		2545.8	23.41	21.96	/	24.5	23.5	/
		2498.5	23.56	22.17	/	24.5	23.5	/
	1RB_12	2687.5	23.04	21.90	/	24.5	23.5	/
		2640.3	23.30	21.75	/	24.5	23.5	/
		2593.0	23.12	21.79	/	24.5	23.5	/
		2545.8	23.47	21.99	/	24.5	23.5	/
		2498.5	24.08	22.38	/	24.5	23.5	/
	1RB_0	2687.5	23.11	21.78	/	24.5	23.5	/
		2640.3	23.00	21.54	/	24.5	23.5	/
		2593.0	22.94	21.70	/	24.5	23.5	/
		2545.8	23.39	21.86	/	24.5	23.5	/
		2498.5	23.97	22.24	/	24.5	23.5	/
	12RB_13	2687.5	22.16	21.45	/	23.5	22.5	/
		2640.3	22.24	21.27	/	23.5	22.5	/
		2593.0	22.17	21.12	/	23.5	22.5	/
		2545.8	22.58	21.38	/	23.5	22.5	/
		2498.5	22.78	21.81	/	23.5	22.5	/
	12RB_6	2687.5	22.02	21.11	/	23.5	22.5	/
		2640.3	22.14	21.17	/	23.5	22.5	/
		2593.0	22.23	21.28	/	23.5	22.5	/
		2545.8	22.50	21.47	/	23.5	22.5	/
		2498.5	22.75	21.87	/	23.5	22.5	/
	12RB_0	2687.5	22.18	21.09	/	23.5	22.5	/
		2640.3	22.16	21.11	/	23.5	22.5	/
		2593.0	22.22	21.19	/	23.5	22.5	/
		2545.8	22.51	21.37	/	23.5	22.5	/
		2498.5	22.74	21.67	/	23.5	22.5	/
25RB_0	2687.5	22.01	21.36	/	23.5	22.5	/	
	2640.3	22.17	21.46	/	23.5	22.5	/	
	2593.0	22.15	21.16	/	23.5	22.5	/	
	2545.8	22.62	21.64	/	23.5	22.5	/	
	2498.5	22.79	22.02	/	23.5	22.5	/	

Full Power								
LTE Band 41 PC3			Actual output Power (dBm)			Tune up		
Band -width	RB No. / RB offset	Frequency (MHz)	Modulation			Modulation		
			QPSK	16QAM	64QAM	QPSK	16QAM	64QAM
10 MHz	1RB_49	2685.0	23.23	21.70	/	24.5	23.5	/
		2639.0	23.05	21.89	/	24.5	23.5	/
		2593.0	23.31	22.41	/	24.5	23.5	/
		2547.0	23.55	22.11	/	24.5	23.5	/
		2501.0	23.84	22.53	/	24.5	23.5	/
	1RB_24	2685.0	23.59	22.03	/	24.5	23.5	/
		2639.0	23.35	21.85	/	24.5	23.5	/
		2593.0	23.28	21.97	/	24.5	23.5	/
		2547.0	23.65	21.95	/	24.5	23.5	/
		2501.0	24.09	22.39	/	24.5	23.5	/
	1RB_0	2685.0	23.06	21.89	/	24.5	23.5	/
		2639.0	23.39	21.77	/	24.5	23.5	/
		2593.0	23.22	21.78	/	24.5	23.5	/
		2547.0	23.41	22.09	/	24.5	23.5	/
		2501.0	23.95	22.47	/	24.5	23.5	/
	25RB_25	2685.0	22.04	21.42	/	23.5	22.5	/
		2639.0	22.25	21.50	/	23.5	22.5	/
		2593.0	22.24	21.12	/	23.5	22.5	/
		2547.0	22.49	21.68	/	23.5	22.5	/
		2501.0	22.84	22.20	/	23.5	22.5	/
	25RB_12	2685.0	22.15	21.44	/	23.5	22.5	/
		2639.0	22.30	21.43	/	23.5	22.5	/
		2593.0	22.33	21.27	/	23.5	22.5	/
		2547.0	22.61	21.80	/	23.5	22.5	/
		2501.0	22.91	22.05	/	23.5	22.5	/
25RB_0	2685.0	22.16	21.15	/	23.5	22.5	/	
	2639.0	22.20	21.24	/	23.5	22.5	/	
	2593.0	22.19	21.26	/	23.5	22.5	/	
	2547.0	22.55	21.64	/	23.5	22.5	/	
	2501.0	22.85	22.01	/	23.5	22.5	/	
50RB_0	2685.0	22.31	21.42	/	23.5	22.5	/	
	2639.0	22.29	21.23	/	23.5	22.5	/	
	2593.0	22.33	21.29	/	23.5	22.5	/	
	2547.0	22.48	21.58	/	23.5	22.5	/	
	2501.0	22.93	21.89	/	23.5	22.5	/	



Full Power								
LTE Band 41 PC3			Actual output Power (dBm)			Tune up		
Band -width	RB No. / RB offset	Frequency (MHz)	Modulation			Modulation		
			QPSK	16QAM	64QAM	QPSK	16QAM	64QAM
15 MHz	1RB_74	2682.5	23.12	22.00	/	24.5	23.5	/
		2637.8	23.01	21.88	/	24.5	23.5	/
		2593.0	23.26	21.98	/	24.5	23.5	/
		2548.3	23.53	22.07	/	24.5	23.5	/
		2503.5	23.70	22.46	/	24.5	23.5	/
	1RB_37	2682.5	23.30	21.91	/	24.5	23.5	/
		2637.8	23.27	21.56	/	24.5	23.5	/
		2593.0	23.21	21.94	/	24.5	23.5	/
		2548.3	23.58	22.07	/	24.5	23.5	/
		2503.5	23.80	22.40	/	24.5	23.5	/
	1RB_0	2682.5	23.12	21.82	/	24.5	23.5	/
		2637.8	23.21	21.86	/	24.5	23.5	/
		2593.0	23.23	21.88	/	24.5	23.5	/
		2548.3	23.46	22.13	/	24.5	23.5	/
		2503.5	23.67	22.44	/	24.5	23.5	/
	36RB_38	2682.5	22.21	21.30	/	23.5	22.5	/
		2637.8	22.23	21.32	/	23.5	22.5	/
		2593.0	22.23	21.36	/	23.5	22.5	/
		2548.3	22.70	21.55	/	23.5	22.5	/
		2503.5	22.79	21.94	/	23.5	22.5	/
	36RB_19	2682.5	22.28	21.18	/	23.5	22.5	/
		2637.8	22.37	21.35	/	23.5	22.5	/
		2593.0	22.31	21.21	/	23.5	22.5	/
		2548.3	22.50	21.52	/	23.5	22.5	/
		2503.5	22.80	21.75	/	23.5	22.5	/
36RB_0	2682.5	22.10	21.20	/	23.5	22.5	/	
	2637.8	22.21	21.28	/	23.5	22.5	/	
	2593.0	22.34	21.24	/	23.5	22.5	/	
	2548.3	22.55	21.46	/	23.5	22.5	/	
	2503.5	22.70	21.74	/	23.5	22.5	/	
75RB_0	2682.5	22.11	21.42	/	23.5	22.5	/	
	2637.8	22.37	21.39	/	23.5	22.5	/	
	2593.0	22.29	21.45	/	23.5	22.5	/	
	2548.3	22.49	21.65	/	23.5	22.5	/	
	2503.5	22.65	21.85	/	23.5	22.5	/	

Full Power								
LTE Band 41 PC3			Actual output Power (dBm)			Tune up		
Band -width	RB No. / RB offset	Frequency (MHz)	Modulation			Modulation		
			QPSK	16QAM	64QAM	QPSK	16QAM	64QAM
20 MHz	1RB_99	2680.0	23.15	21.76	/	24.5	23.5	/
		2636.5	22.89	21.68	/	24.5	23.5	/
		2593.0	23.16	21.95	/	24.5	23.5	/
		2549.5	23.28	22.19	/	24.5	23.5	/
		2506.0	23.38	22.16	/	24.5	23.5	/
	1RB_50	2680.0	23.12	22.39	/	24.5	23.5	/
		2636.5	23.51	21.83	/	24.5	23.5	/
		2593.0	23.26	22.01	/	24.5	23.5	/
		2549.5	23.53	22.09	/	24.5	23.5	/
		2506.0	24.10	22.48	/	24.5	23.5	/
	1RB_0	2680.0	23.10	21.86	/	24.5	23.5	/
		2636.5	23.01	21.80	/	24.5	23.5	/
		2593.0	23.04	21.89	/	24.5	23.5	/
		2549.5	23.37	22.04	/	24.5	23.5	/
		2506.0	23.79	22.47	/	24.5	23.5	/
	50RB_50	2680.0	22.09	21.43	/	23.5	22.5	/
		2636.5	22.19	21.19	/	23.5	22.5	/
		2593.0	22.18	21.24	/	23.5	22.5	/
		2549.5	22.53	21.72	/	23.5	22.5	/
		2506.0	22.59	21.61	/	23.5	22.5	/
	50RB_25	2680.0	22.34	21.26	/	23.5	22.5	/
		2636.5	22.20	21.32	/	23.5	22.5	/
		2593.0	22.29	21.35	/	23.5	22.5	/
		2549.5	22.58	21.56	/	23.5	22.5	/
		2506.0	22.70	21.83	/	23.5	22.5	/
	50RB_0	2680.0	22.18	21.29	/	23.5	22.5	/
		2636.5	22.09	21.12	/	23.5	22.5	/
		2593.0	22.22	21.32	/	23.5	22.5	/
		2549.5	22.45	21.33	/	23.5	22.5	/
		2506.0	22.78	21.72	/	23.5	22.5	/
100RB_0	2680.0	22.10	21.11	/	23.5	22.5	/	
	2636.5	22.24	21.36	/	23.5	22.5	/	
	2593.0	22.23	21.26	/	23.5	22.5	/	
	2549.5	22.50	21.68	/	23.5	22.5	/	
	2506.0	22.61	21.92	/	23.5	22.5	/	

Hotspot on								
LTE Band 41 PC3			Actual output Power (dBm)			Tune up		
Band -width	RB No. / RB offset	Frequency (MHz)	Modulation			Modulation		
			QPSK	16QAM	64QAM	QPSK	16QAM	64QAM
5 MHz	1RB_24	2687.5	19.20	18.84	/	20.5	20.5	/
		2640.3	18.97	18.51	/	20.5	20.5	/
		2593.0	19.01	18.60	/	20.5	20.5	/
		2545.8	19.17	19.10	/	20.5	20.5	/
		2498.5	19.36	19.17	/	20.5	20.5	/
	1RB_12	2687.5	19.21	18.90	/	20.5	20.5	/
		2640.3	19.08	18.72	/	20.5	20.5	/
		2593.0	19.04	18.73	/	20.5	20.5	/
		2545.8	19.22	18.95	/	20.5	20.5	/
		2498.5	19.52	19.37	/	20.5	20.5	/
	1RB_0	2687.5	19.00	18.91	/	20.5	20.5	/
		2640.3	19.12	18.54	/	20.5	20.5	/
		2593.0	19.12	18.57	/	20.5	20.5	/
		2545.8	19.30	18.79	/	20.5	20.5	/
		2498.5	19.56	19.30	/	20.5	20.5	/
	12RB_13	2687.5	19.20	18.99	/	20.5	20.5	/
		2640.3	19.07	19.13	/	20.5	20.5	/
		2593.0	19.15	19.18	/	20.5	20.5	/
		2545.8	19.35	19.28	/	20.5	20.5	/
		2498.5	19.73	19.69	/	20.5	20.5	/
	12RB_6	2687.5	19.07	19.01	/	20.5	20.5	/
		2640.3	19.15	19.10	/	20.5	20.5	/
		2593.0	19.18	19.22	/	20.5	20.5	/
		2545.8	19.39	19.24	/	20.5	20.5	/
		2498.5	19.68	19.76	/	20.5	20.5	/
	12RB_0	2687.5	19.23	18.99	/	20.5	20.5	/
		2640.3	19.07	19.05	/	20.5	20.5	/
		2593.0	19.21	19.12	/	20.5	20.5	/
		2545.8	19.40	19.24	/	20.5	20.5	/
		2498.5	19.68	19.55	/	20.5	20.5	/
25RB_0	2687.5	19.15	19.08	/	20.5	20.5	/	
	2640.3	19.16	19.31	/	20.5	20.5	/	
	2593.0	19.10	19.20	/	20.5	20.5	/	
	2545.8	19.37	19.53	/	20.5	20.5	/	
	2498.5	19.70	19.61	/	20.5	20.5	/	

Hotspot on								
LTE Band 41 PC3			Actual output Power (dBm)			Tune up		
Band -width	RB No. / RB offset	Frequency (MHz)	Modulation			Modulation		
			QPSK	16QAM	64QAM	QPSK	16QAM	64QAM
10 MHz	1RB_49	2685.0	19.28	18.70	/	20.5	20.5	/
		2639.0	19.21	18.91	/	20.5	20.5	/
		2593.0	19.33	18.83	/	20.5	20.5	/
		2547.0	19.22	19.51	/	20.5	20.5	/
		2501.0	19.69	19.33	/	20.5	20.5	/
	1RB_24	2685.0	19.57	18.99	/	20.5	20.5	/
		2639.0	19.14	18.87	/	20.5	20.5	/
		2593.0	19.10	18.99	/	20.5	20.5	/
		2547.0	19.45	19.02	/	20.5	20.5	/
		2501.0	19.79	19.33	/	20.5	20.5	/
	1RB_0	2685.0	19.14	18.75	/	20.5	20.5	/
		2639.0	19.13	18.74	/	20.5	20.5	/
		2593.0	19.15	18.80	/	20.5	20.5	/
		2547.0	19.36	18.94	/	20.5	20.5	/
		2501.0	19.64	19.26	/	20.5	20.5	/
	25RB_25	2685.0	19.07	19.36	/	20.5	20.5	/
		2639.0	19.09	19.10	/	20.5	20.5	/
		2593.0	19.06	19.11	/	20.5	20.5	/
		2547.0	19.43	19.59	/	20.5	20.5	/
		2501.0	19.73	19.76	/	20.5	20.5	/
	25RB_12	2685.0	19.16	19.12	/	20.5	20.5	/
		2639.0	19.26	19.35	/	20.5	20.5	/
		2593.0	19.10	19.32	/	20.5	20.5	/
		2547.0	19.43	19.36	/	20.5	20.5	/
		2501.0	19.78	19.90	/	20.5	20.5	/
25RB_0	2685.0	19.08	19.07	/	20.5	20.5	/	
	2639.0	19.15	19.05	/	20.5	20.5	/	
	2593.0	19.28	19.20	/	20.5	20.5	/	
	2547.0	19.37	19.53	/	20.5	20.5	/	
	2501.0	19.76	19.87	/	20.5	20.5	/	
50RB_0	2685.0	19.15	18.99	/	20.5	20.5	/	
	2639.0	19.13	19.24	/	20.5	20.5	/	
	2593.0	19.11	19.00	/	20.5	20.5	/	
	2547.0	19.41	19.56	/	20.5	20.5	/	
	2501.0	19.74	19.86	/	20.5	20.5	/	

Hotspot on								
LTE Band 41 PC3			Actual output Power (dBm)			Tune up		
Band -width	RB No. / RB offset	Frequency (MHz)	Modulation			Modulation		
			QPSK	16QAM	64QAM	QPSK	16QAM	64QAM
15 MHz	1RB_74	2682.5	18.98	19.38	/	20.5	20.5	/
		2637.8	18.87	18.94	/	20.5	20.5	/
		2593.0	19.04	18.79	/	20.5	20.5	/
		2548.3	19.24	19.21	/	20.5	20.5	/
		2503.5	19.50	19.17	/	20.5	20.5	/
	1RB_37	2682.5	19.16	18.93	/	20.5	20.5	/
		2637.8	18.94	18.93	/	20.5	20.5	/
		2593.0	19.12	18.92	/	20.5	20.5	/
		2548.3	19.28	18.98	/	20.5	20.5	/
		2503.5	19.52	19.40	/	20.5	20.5	/
	1RB_0	2682.5	19.08	18.89	/	20.5	20.5	/
		2637.8	19.04	18.70	/	20.5	20.5	/
		2593.0	19.09	18.96	/	20.5	20.5	/
		2548.3	19.26	19.06	/	20.5	20.5	/
		2503.5	19.60	19.20	/	20.5	20.5	/
	36RB_38	2682.5	19.17	18.92	/	20.5	20.5	/
		2637.8	19.16	19.09	/	20.5	20.5	/
		2593.0	19.18	19.14	/	20.5	20.5	/
		2548.3	19.42	19.29	/	20.5	20.5	/
		2503.5	19.63	19.54	/	20.5	20.5	/
	36RB_19	2682.5	19.30	19.10	/	20.5	20.5	/
		2637.8	19.18	19.10	/	20.5	20.5	/
		2593.0	19.18	19.18	/	20.5	20.5	/
		2548.3	19.42	19.34	/	20.5	20.5	/
		2503.5	19.63	19.62	/	20.5	20.5	/
36RB_0	2682.5	19.11	18.93	/	20.5	20.5	/	
	2637.8	19.13	19.05	/	20.5	20.5	/	
	2593.0	19.14	19.11	/	20.5	20.5	/	
	2548.3	19.37	19.36	/	20.5	20.5	/	
	2503.5	19.53	19.54	/	20.5	20.5	/	
75RB_0	2682.5	19.14	19.02	/	20.5	20.5	/	
	2637.8	19.19	19.06	/	20.5	20.5	/	
	2593.0	19.21	19.25	/	20.5	20.5	/	
	2548.3	19.42	19.46	/	20.5	20.5	/	
	2503.5	19.69	19.55	/	20.5	20.5	/	

<b>Hotspot on</b>								
LTE Band 41 <b>PC3</b>			Actual output Power (dBm)			Tune up		
Band -width	RB No. / RB offset	Frequency (MHz)	Modulation			Modulation		
			QPSK	16QAM	64QAM	QPSK	16QAM	64QAM
20 MHz	1RB_99	2680.0	18.86	18.85	/	<b>20.5</b>	<b>20.5</b>	/
		2636.5	18.94	18.74	/	<b>20.5</b>	<b>20.5</b>	/
		2593.0	19.11	18.95	/	<b>20.5</b>	<b>20.5</b>	/
		2549.5	19.31	19.09	/	<b>20.5</b>	<b>20.5</b>	/
		2506.0	19.28	19.07	/	<b>20.5</b>	<b>20.5</b>	/
	1RB_50	2680.0	19.15	19.32	/	<b>20.5</b>	<b>20.5</b>	/
		2636.5	19.42	18.76	/	<b>20.5</b>	<b>20.5</b>	/
		2593.0	19.16	18.92	/	<b>20.5</b>	<b>20.5</b>	/
		2549.5	19.30	19.17	/	<b>20.5</b>	<b>20.5</b>	/
		2506.0	<b>19.56</b>	19.51	/	<b>20.5</b>	<b>20.5</b>	/
	1RB_0	2680.0	19.07	18.76	/	<b>20.5</b>	<b>20.5</b>	/
		2636.5	18.95	18.74	/	<b>20.5</b>	<b>20.5</b>	/
		2593.0	19.02	18.76	/	<b>20.5</b>	<b>20.5</b>	/
		2549.5	19.33	19.03	/	<b>20.5</b>	<b>20.5</b>	/
		2506.0	19.47	19.30	/	<b>20.5</b>	<b>20.5</b>	/
	50RB_50	2680.0	19.06	19.12	/	<b>20.5</b>	<b>20.5</b>	/
		2636.5	19.21	19.19	/	<b>20.5</b>	<b>20.5</b>	/
		2593.0	19.18	19.27	/	<b>20.5</b>	<b>20.5</b>	/
		2549.5	19.50	19.39	/	<b>20.5</b>	<b>20.5</b>	/
		2506.0	19.53	19.51	/	<b>20.5</b>	<b>20.5</b>	/
	50RB_25	2680.0	19.18	19.23	/	<b>20.5</b>	<b>20.5</b>	/
		2636.5	19.13	19.20	/	<b>20.5</b>	<b>20.5</b>	/
		2593.0	19.24	19.24	/	<b>20.5</b>	<b>20.5</b>	/
		2549.5	19.40	19.41	/	<b>20.5</b>	<b>20.5</b>	/
		2506.0	<b>19.63</b>	19.74	/	<b>20.5</b>	<b>20.5</b>	/
	50RB_0	2680.0	19.11	19.14	/	<b>20.5</b>	<b>20.5</b>	/
		2636.5	19.14	19.10	/	<b>20.5</b>	<b>20.5</b>	/
		2593.0	19.24	19.12	/	<b>20.5</b>	<b>20.5</b>	/
		2549.5	19.38	19.28	/	<b>20.5</b>	<b>20.5</b>	/
		2506.0	19.56	19.59	/	<b>20.5</b>	<b>20.5</b>	/
100RB_0	2680.0	19.22	19.06	/	<b>20.5</b>	<b>20.5</b>	/	
	2636.5	19.19	19.15	/	<b>20.5</b>	<b>20.5</b>	/	
	2593.0	19.21	19.28	/	<b>20.5</b>	<b>20.5</b>	/	
	2549.5	19.44	19.55	/	<b>20.5</b>	<b>20.5</b>	/	
	2506.0	19.65	19.52	/	<b>20.5</b>	<b>20.5</b>	/	

Full Power								
LTE Band 41 PC2			Actual output Power (dBm)			Tune up		
Band -width	RB No. / RB offset	Frequency (MHz)	Modulation			Modulation		
			QPSK	16QAM	64QAM	QPSK	16QAM	64QAM
5 MHz	1RB_24	2687.5	26.04	24.89	/	27.0	26.0	/
		2640.3	25.91	24.83	/	27.0	26.0	/
		2593.0	25.93	24.87	/	27.0	26.0	/
		2545.8	26.29	25.07	/	27.0	26.0	/
		2498.5	26.49	25.33	/	27.0	26.0	/
	1RB_12	2687.5	26.15	24.87	/	27.0	26.0	/
		2640.3	26.06	24.88	/	27.0	26.0	/
		2593.0	26.12	24.85	/	27.0	26.0	/
		2545.8	26.42	25.13	/	27.0	26.0	/
		2498.5	26.60	25.45	/	27.0	26.0	/
	1RB_0	2687.5	26.15	24.80	/	27.0	26.0	/
		2640.3	25.91	24.76	/	27.0	26.0	/
		2593.0	26.03	24.76	/	27.0	26.0	/
		2545.8	26.15	24.96	/	27.0	26.0	/
		2498.5	26.41	25.49	/	27.0	26.0	/
	12RB_13	2687.5	25.18	24.26	/	26.0	25.0	/
		2640.3	25.12	24.26	/	26.0	25.0	/
		2593.0	25.10	24.20	/	26.0	25.0	/
		2545.8	25.44	24.36	/	26.0	25.0	/
		2498.5	25.61	24.68	/	26.0	25.0	/
	12RB_6	2687.5	25.13	24.10	/	26.0	25.0	/
		2640.3	25.11	24.27	/	26.0	25.0	/
		2593.0	25.17	24.27	/	26.0	25.0	/
		2545.8	25.52	24.36	/	26.0	25.0	/
		2498.5	25.70	24.75	/	26.0	25.0	/
	12RB_0	2687.5	25.22	24.06	/	26.0	25.0	/
		2640.3	25.13	23.99	/	26.0	25.0	/
		2593.0	25.18	24.17	/	26.0	25.0	/
		2545.8	25.43	24.35	/	26.0	25.0	/
		2498.5	25.68	24.66	/	26.0	25.0	/
25RB_0	2687.5	25.17	24.32	/	26.0	25.0	/	
	2640.3	25.12	24.39	/	26.0	25.0	/	
	2593.0	25.11	24.48	/	26.0	25.0	/	
	2545.8	25.43	24.57	/	26.0	25.0	/	
	2498.5	25.60	24.99	/	26.0	25.0	/	

Full Power								
LTE Band 41 PC2			Actual output Power (dBm)			Tune up		
Band -width	RB No. / RB offset	Frequency (MHz)	Modulation			Modulation		
			QPSK	16QAM	64QAM	QPSK	16QAM	64QAM
10 MHz	1RB_49	2685.0	25.96	24.89	/	27.0	26.0	/
		2639.0	25.93	25.00	/	27.0	26.0	/
		2593.0	25.98	24.92	/	27.0	26.0	/
		2547.0	26.25	25.14	/	27.0	26.0	/
		2501.0	26.62	25.61	/	27.0	26.0	/
	1RB_24	2685.0	26.16	25.25	/	27.0	26.0	/
		2639.0	26.25	25.10	/	27.0	26.0	/
		2593.0	26.18	25.15	/	27.0	26.0	/
		2547.0	26.47	25.34	/	27.0	26.0	/
		2501.0	26.72	25.53	/	27.0	26.0	/
	1RB_0	2685.0	26.05	24.89	/	27.0	26.0	/
		2639.0	26.13	24.90	/	27.0	26.0	/
		2593.0	26.10	24.87	/	27.0	26.0	/
		2547.0	26.51	25.12	/	27.0	26.0	/
		2501.0	26.57	25.46	/	27.0	26.0	/
	25RB_25	2685.0	25.17	24.11	/	26.0	25.0	/
		2639.0	25.15	24.15	/	26.0	25.0	/
		2593.0	25.14	24.13	/	26.0	25.0	/
		2547.0	25.41	24.48	/	26.0	25.0	/
		2501.0	25.88	24.99	/	26.0	25.0	/
	25RB_12	2685.0	25.11	24.43	/	26.0	25.0	/
		2639.0	25.19	24.52	/	26.0	25.0	/
		2593.0	25.19	24.22	/	26.0	25.0	/
		2547.0	25.44	24.41	/	26.0	25.0	/
		2501.0	25.75	25.06	/	26.0	25.0	/
	25RB_0	2685.0	25.17	24.11	/	26.0	25.0	/
		2639.0	25.20	24.20	/	26.0	25.0	/
		2593.0	25.35	24.12	/	26.0	25.0	/
		2547.0	25.39	24.73	/	26.0	25.0	/
		2501.0	25.72	25.01	/	26.0	25.0	/
50RB_0	2685.0	25.18	24.13	/	26.0	25.0	/	
	2639.0	25.19	24.22	/	26.0	25.0	/	
	2593.0	25.22	24.09	/	26.0	25.0	/	
	2547.0	25.58	24.55	/	26.0	25.0	/	
	2501.0	25.65	24.82	/	26.0	25.0	/	



Full Power								
LTE Band 41 PC2			Actual output Power (dBm)			Tune up		
Band -width	RB No. / RB offset	Frequency (MHz)	Modulation			Modulation		
			QPSK	16QAM	64QAM	QPSK	16QAM	64QAM
15 MHz	1RB_74	2682.5	25.87	25.17	/	27.0	26.0	/
		2637.8	26.20	24.91	/	27.0	26.0	/
		2593.0	25.99	24.87	/	27.0	26.0	/
		2548.3	26.39	25.14	/	27.0	26.0	/
		2503.5	26.66	25.46	/	27.0	26.0	/
	1RB_37	2682.5	26.15	25.09	/	27.0	26.0	/
		2637.8	26.11	24.91	/	27.0	26.0	/
		2593.0	26.11	24.94	/	27.0	26.0	/
		2548.3	26.34	25.15	/	27.0	26.0	/
		2503.5	26.49	25.35	/	27.0	26.0	/
	1RB_0	2682.5	26.08	25.06	/	27.0	26.0	/
		2637.8	26.17	24.96	/	27.0	26.0	/
		2593.0	26.02	24.95	/	27.0	26.0	/
		2548.3	26.25	25.20	/	27.0	26.0	/
		2503.5	26.57	25.38	/	27.0	26.0	/
	36RB_38	2682.5	25.09	23.99	/	26.0	25.0	/
		2637.8	25.25	24.16	/	26.0	25.0	/
		2593.0	25.33	24.15	/	26.0	25.0	/
		2548.3	25.52	24.60	/	26.0	25.0	/
		2503.5	25.64	24.75	/	26.0	25.0	/
	36RB_19	2682.5	25.22	24.22	/	26.0	25.0	/
		2637.8	25.19	24.21	/	26.0	25.0	/
		2593.0	25.25	24.19	/	26.0	25.0	/
		2548.3	25.52	24.40	/	26.0	25.0	/
		2503.5	25.58	24.67	/	26.0	25.0	/
	36RB_0	2682.5	25.14	24.15	/	26.0	25.0	/
		2637.8	25.20	24.13	/	26.0	25.0	/
		2593.0	25.32	24.28	/	26.0	25.0	/
		2548.3	25.46	24.42	/	26.0	25.0	/
		2503.5	25.65	24.45	/	26.0	25.0	/
75RB_0	2682.5	25.14	24.21	/	26.0	25.0	/	
	2637.8	25.17	24.34	/	26.0	25.0	/	
	2593.0	25.28	24.22	/	26.0	25.0	/	
	2548.3	25.49	24.59	/	26.0	25.0	/	
	2503.5	25.61	24.74	/	26.0	25.0	/	

Full Power								
LTE Band 41 PC2			Actual output Power (dBm)			Tune up		
Band -width	RB No. / RB offset	Frequency (MHz)	Modulation			Modulation		
			QPSK	16QAM	64QAM	QPSK	16QAM	64QAM
20 MHz	1RB_99	2680.0	25.99	24.75	/	27.0	26.0	/
		2636.5	25.93	24.80	/	27.0	26.0	/
		2593.0	26.13	24.90	/	27.0	26.0	/
		2549.5	26.32	25.08	/	27.0	26.0	/
		2506.0	26.09	25.25	/	27.0	26.0	/
	1RB_50	2680.0	26.18	25.24	/	27.0	26.0	/
		2636.5	26.30	24.97	/	27.0	26.0	/
		2593.0	26.16	25.24	/	27.0	26.0	/
		2549.5	26.50	25.44	/	27.0	26.0	/
		2506.0	26.64	25.50	/	27.0	26.0	/
	1RB_0	2680.0	25.93	24.90	/	27.0	26.0	/
		2636.5	26.09	24.88	/	27.0	26.0	/
		2593.0	26.03	25.00	/	27.0	26.0	/
		2549.5	26.15	25.19	/	27.0	26.0	/
		2506.0	26.54	25.38	/	27.0	26.0	/
	50RB_50	2680.0	25.14	24.11	/	26.0	25.0	/
		2636.5	25.29	24.31	/	26.0	25.0	/
		2593.0	25.31	24.17	/	26.0	25.0	/
		2549.5	25.51	24.61	/	26.0	25.0	/
		2506.0	25.63	24.66	/	26.0	25.0	/
	50RB_25	2680.0	25.23	24.29	/	26.0	25.0	/
		2636.5	25.20	24.32	/	26.0	25.0	/
		2593.0	25.15	24.27	/	26.0	25.0	/
		2549.5	25.56	24.59	/	26.0	25.0	/
		2506.0	25.70	24.76	/	26.0	25.0	/
	50RB_0	2680.0	25.25	24.31	/	26.0	25.0	/
		2636.5	25.17	24.21	/	26.0	25.0	/
		2593.0	25.19	24.36	/	26.0	25.0	/
		2549.5	25.44	24.27	/	26.0	25.0	/
		2506.0	25.47	24.64	/	26.0	25.0	/
100RB_0	2680.0	25.16	24.21	/	26.0	25.0	/	
	2636.5	25.26	24.24	/	26.0	25.0	/	
	2593.0	25.26	24.21	/	26.0	25.0	/	
	2549.5	25.56	24.49	/	26.0	25.0	/	
	2506.0	25.58	24.65	/	26.0	25.0	/	

<b>Hotspot on</b>								
LTE Band 41 <b>PC2</b>			Actual output Power (dBm)			Tune up		
Band -width	RB No. / RB offset	Frequency (MHz)	Modulation			Modulation		
			QPSK	16QAM	64QAM	QPSK	16QAM	64QAM
5 MHz	1RB_24	2687.5	19.05	18.74	/	<b>20.5</b>	<b>20.5</b>	/
		2640.3	18.87	18.75	/	<b>20.5</b>	<b>20.5</b>	/
		2593.0	19.07	18.94	/	<b>20.5</b>	<b>20.5</b>	/
		2545.8	19.38	19.10	/	<b>20.5</b>	<b>20.5</b>	/
		2498.5	19.41	19.23	/	<b>20.5</b>	<b>20.5</b>	/
	1RB_12	2687.5	19.35	18.79	/	<b>20.5</b>	<b>20.5</b>	/
		2640.3	19.19	18.86	/	<b>20.5</b>	<b>20.5</b>	/
		2593.0	19.42	18.83	/	<b>20.5</b>	<b>20.5</b>	/
		2545.8	19.23	19.15	/	<b>20.5</b>	<b>20.5</b>	/
		2498.5	19.89	19.52	/	<b>20.5</b>	<b>20.5</b>	/
	1RB_0	2687.5	19.09	18.70	/	<b>20.5</b>	<b>20.5</b>	/
		2640.3	19.00	18.90	/	<b>20.5</b>	<b>20.5</b>	/
		2593.0	19.14	18.70	/	<b>20.5</b>	<b>20.5</b>	/
		2545.8	18.99	19.01	/	<b>20.5</b>	<b>20.5</b>	/
		2498.5	19.73	19.39	/	<b>20.5</b>	<b>20.5</b>	/
	12RB_13	2687.5	19.17	19.17	/	<b>20.5</b>	<b>20.5</b>	/
		2640.3	19.13	19.20	/	<b>20.5</b>	<b>20.5</b>	/
		2593.0	19.17	19.17	/	<b>20.5</b>	<b>20.5</b>	/
		2545.8	19.40	19.40	/	<b>20.5</b>	<b>20.5</b>	/
		2498.5	19.74	19.70	/	<b>20.5</b>	<b>20.5</b>	/
	12RB_6	2687.5	19.18	19.08	/	<b>20.5</b>	<b>20.5</b>	/
		2640.3	19.20	19.15	/	<b>20.5</b>	<b>20.5</b>	/
		2593.0	19.21	19.12	/	<b>20.5</b>	<b>20.5</b>	/
		2545.8	19.35	19.33	/	<b>20.5</b>	<b>20.5</b>	/
		2498.5	19.80	19.66	/	<b>20.5</b>	<b>20.5</b>	/
	12RB_0	2687.5	19.15	19.05	/	<b>20.5</b>	<b>20.5</b>	/
		2640.3	19.13	19.10	/	<b>20.5</b>	<b>20.5</b>	/
		2593.0	19.22	19.28	/	<b>20.5</b>	<b>20.5</b>	/
		2545.8	19.36	19.36	/	<b>20.5</b>	<b>20.5</b>	/
		2498.5	19.70	19.72	/	<b>20.5</b>	<b>20.5</b>	/
25RB_0	2687.5	19.18	19.33	/	<b>20.5</b>	<b>20.5</b>	/	
	2640.3	19.13	19.11	/	<b>20.5</b>	<b>20.5</b>	/	
	2593.0	19.14	19.25	/	<b>20.5</b>	<b>20.5</b>	/	
	2545.8	19.38	19.31	/	<b>20.5</b>	<b>20.5</b>	/	
	2498.5	19.73	19.96	/	<b>20.5</b>	<b>20.5</b>	/	

Hotspot on								
LTE Band 41 PC2			Actual output Power (dBm)			Tune up		
Band -width	RB No. / RB offset	Frequency (MHz)	Modulation			Modulation		
			QPSK	16QAM	64QAM	QPSK	16QAM	64QAM
10 MHz	1RB_49	2685.0	18.97	18.92	/	20.5	20.5	/
		2639.0	18.99	18.85	/	20.5	20.5	/
		2593.0	18.97	18.94	/	20.5	20.5	/
		2547.0	19.39	19.12	/	20.5	20.5	/
		2501.0	19.72	19.47	/	20.5	20.5	/
	1RB_24	2685.0	19.38	19.25	/	20.5	20.5	/
		2639.0	19.22	19.12	/	20.5	20.5	/
		2593.0	19.15	19.09	/	20.5	20.5	/
		2547.0	19.42	19.27	/	20.5	20.5	/
		2501.0	19.63	19.58	/	20.5	20.5	/
	1RB_0	2685.0	19.04	18.96	/	20.5	20.5	/
		2639.0	19.10	18.77	/	20.5	20.5	/
		2593.0	19.10	18.98	/	20.5	20.5	/
		2547.0	19.25	19.10	/	20.5	20.5	/
		2501.0	19.66	19.43	/	20.5	20.5	/
	25RB_25	2685.0	19.15	19.43	/	20.5	20.5	/
		2639.0	19.15	19.16	/	20.5	20.5	/
		2593.0	19.35	19.50	/	20.5	20.5	/
		2547.0	19.38	19.52	/	20.5	20.5	/
		2501.0	19.82	19.61	/	20.5	20.5	/
	25RB_12	2685.0	19.16	19.41	/	20.5	20.5	/
		2639.0	19.17	19.24	/	20.5	20.5	/
		2593.0	19.22	19.49	/	20.5	20.5	/
		2547.0	19.37	19.31	/	20.5	20.5	/
		2501.0	19.76	19.65	/	20.5	20.5	/
25RB_0	2685.0	19.29	19.44	/	20.5	20.5	/	
	2639.0	19.11	19.14	/	20.5	20.5	/	
	2593.0	19.38	19.29	/	20.5	20.5	/	
	2547.0	19.32	19.44	/	20.5	20.5	/	
	2501.0	19.63	19.54	/	20.5	20.5	/	
50RB_0	2685.0	19.24	19.26	/	20.5	20.5	/	
	2639.0	19.18	19.10	/	20.5	20.5	/	
	2593.0	19.30	19.17	/	20.5	20.5	/	
	2547.0	19.45	19.37	/	20.5	20.5	/	
	2501.0	19.74	19.74	/	20.5	20.5	/	

<b>Hotspot on</b>								
LTE Band 41 <b>PC2</b>			Actual output Power (dBm)			Tune up		
Band -width	RB No. / RB offset	Frequency (MHz)	Modulation			Modulation		
			QPSK	16QAM	64QAM	QPSK	16QAM	64QAM
15 MHz	1RB_74	2682.5	19.14	18.97	/	<b>20.5</b>	<b>20.5</b>	/
		2637.8	18.95	18.88	/	<b>20.5</b>	<b>20.5</b>	/
		2593.0	19.13	18.94	/	<b>20.5</b>	<b>20.5</b>	/
		2548.3	19.23	19.07	/	<b>20.5</b>	<b>20.5</b>	/
		2503.5	19.00	19.36	/	<b>20.5</b>	<b>20.5</b>	/
	1RB_37	2682.5	18.95	18.88	/	<b>20.5</b>	<b>20.5</b>	/
		2637.8	19.15	18.97	/	<b>20.5</b>	<b>20.5</b>	/
		2593.0	19.02	18.92	/	<b>20.5</b>	<b>20.5</b>	/
		2548.3	19.31	19.13	/	<b>20.5</b>	<b>20.5</b>	/
		2503.5	19.13	19.55	/	<b>20.5</b>	<b>20.5</b>	/
	1RB_0	2682.5	19.15	19.06	/	<b>20.5</b>	<b>20.5</b>	/
		2637.8	19.10	18.85	/	<b>20.5</b>	<b>20.5</b>	/
		2593.0	18.99	19.05	/	<b>20.5</b>	<b>20.5</b>	/
		2548.3	19.41	19.14	/	<b>20.5</b>	<b>20.5</b>	/
		2503.5	19.07	19.34	/	<b>20.5</b>	<b>20.5</b>	/
	36RB_38	2682.5	19.15	19.15	/	<b>20.5</b>	<b>20.5</b>	/
		2637.8	19.24	19.07	/	<b>20.5</b>	<b>20.5</b>	/
		2593.0	19.23	19.28	/	<b>20.5</b>	<b>20.5</b>	/
		2548.3	19.47	19.53	/	<b>20.5</b>	<b>20.5</b>	/
		2503.5	19.22	19.62	/	<b>20.5</b>	<b>20.5</b>	/
	36RB_19	2682.5	19.20	19.21	/	<b>20.5</b>	<b>20.5</b>	/
		2637.8	19.16	19.10	/	<b>20.5</b>	<b>20.5</b>	/
		2593.0	19.26	19.29	/	<b>20.5</b>	<b>20.5</b>	/
		2548.3	19.42	19.47	/	<b>20.5</b>	<b>20.5</b>	/
		2503.5	19.24	19.71	/	<b>20.5</b>	<b>20.5</b>	/
	36RB_0	2682.5	19.22	19.22	/	<b>20.5</b>	<b>20.5</b>	/
		2637.8	19.11	19.02	/	<b>20.5</b>	<b>20.5</b>	/
		2593.0	19.30	19.30	/	<b>20.5</b>	<b>20.5</b>	/
		2548.3	19.46	19.29	/	<b>20.5</b>	<b>20.5</b>	/
		2503.5	19.29	19.63	/	<b>20.5</b>	<b>20.5</b>	/
75RB_0	2682.5	19.27	19.22	/	<b>20.5</b>	<b>20.5</b>	/	
	2637.8	19.16	19.12	/	<b>20.5</b>	<b>20.5</b>	/	
	2593.0	19.24	19.33	/	<b>20.5</b>	<b>20.5</b>	/	
	2548.3	19.42	19.50	/	<b>20.5</b>	<b>20.5</b>	/	
	2503.5	19.23	19.69	/	<b>20.5</b>	<b>20.5</b>	/	

Hotspot on								
LTE Band 41 PC2			Actual output Power (dBm)			Tune up		
Band -width	RB No. / RB offset	Frequency (MHz)	Modulation			Modulation		
			QPSK	16QAM	64QAM	QPSK	16QAM	64QAM
20 MHz	1RB_99	2680.0	19.01	18.87	/	20.5	20.5	/
		2636.5	18.94	18.77	/	20.5	20.5	/
		2593.0	19.19	18.88	/	20.5	20.5	/
		2549.5	19.33	19.02	/	20.5	20.5	/
		2506.0	19.33	19.12	/	20.5	20.5	/
	1RB_50	2680.0	19.32	19.19	/	20.5	20.5	/
		2636.5	19.21	19.06	/	20.5	20.5	/
		2593.0	19.22	19.09	/	20.5	20.5	/
		2549.5	19.40	19.39	/	20.5	20.5	/
		2506.0	19.73	19.57	/	20.5	20.5	/
	1RB_0	2680.0	19.19	18.84	/	20.5	20.5	/
		2636.5	19.01	18.83	/	20.5	20.5	/
		2593.0	19.09	18.92	/	20.5	20.5	/
		2549.5	19.22	19.15	/	20.5	20.5	/
		2506.0	19.45	19.27	/	20.5	20.5	/
	50RB_50	2680.0	19.17	19.14	/	20.5	20.5	/
		2636.5	19.27	19.03	/	20.5	20.5	/
		2593.0	19.20	19.14	/	20.5	20.5	/
		2549.5	19.46	19.51	/	20.5	20.5	/
		2506.0	19.56	19.59	/	20.5	20.5	/
	50RB_25	2680.0	19.30	19.36	/	20.5	20.5	/
		2636.5	19.18	19.04	/	20.5	20.5	/
		2593.0	19.28	19.23	/	20.5	20.5	/
		2549.5	19.48	19.33	/	20.5	20.5	/
		2506.0	19.68	19.81	/	20.5	20.5	/
	50RB_0	2680.0	19.22	19.35	/	20.5	20.5	/
		2636.5	19.29	19.13	/	20.5	20.5	/
		2593.0	19.28	19.41	/	20.5	20.5	/
		2549.5	19.47	19.29	/	20.5	20.5	/
		2506.0	19.58	19.65	/	20.5	20.5	/
100RB_0	2680.0	19.35	19.20	/	20.5	20.5	/	
	2636.5	19.25	19.19	/	20.5	20.5	/	
	2593.0	19.38	19.26	/	20.5	20.5	/	
	2549.5	19.53	19.45	/	20.5	20.5	/	
	2506.0	19.58	19.61	/	20.5	20.5	/	

## 10.5. WLAN and Bluetooth Measurement result

**Table 10.10: The conducted Power measurement results for Bluetooth**

Bluetooth	Tune up	Averaged Power (dBm)		
Mode		Ch.0 (2402 MHz)	Ch39 (2441 MHz)	Ch78 (2480 MHz)
GFSK	1.0	-0.84	0.24	-0.39
EDR2M-4_DQPSK	1.0	-0.11	0.41	0.30
EDR3M-8DPSK	1.0	0.05	0.52	0.43
/	/	Ch0 (2402MHz)	Ch19 (2440MHz)	Ch39 (2480MHz)
BLE	0.5	-0.95	-0.56	-0.66

**Table 10.11: The conducted Power measurement results for 2.4G WLAN**

WLAN 2.4GHz	Tune up	Averaged Power (dBm) Duty Cycle: 100%		
Mode		Ch.1(2412 MHz)	Ch.6(2437Mhz)	Ch.11(2462MHz)
802.11b	16.0	15.12	15.37	15.79
802.11g	14.0	12.70	12.97	13.31
802.11n(20MHz)	13.0	12.29	11.90	12.39
/	/	Ch.3(2422 MHz)	Ch.6(2437Mhz)	Ch.9(2452MHz)
802.11n(40MHz)	12.0	10.88	10.92	10.95

## 11. Simultaneous TX SAR Considerations

### 11.1. Introduction

The following procedures adopted from “FCC SAR Considerations for Cell Phones with Multiple Transmitters” are applicable to handsets with built-in unlicensed transmitters such as 802.11 a/b/g and Bluetooth devices which may simultaneously transmit with the licensed transmitter.

For this device, the Bluetooth and WLAN can transmit simultaneous with other transmitters.

### 11.2. Transmit Antenna Separation Distances

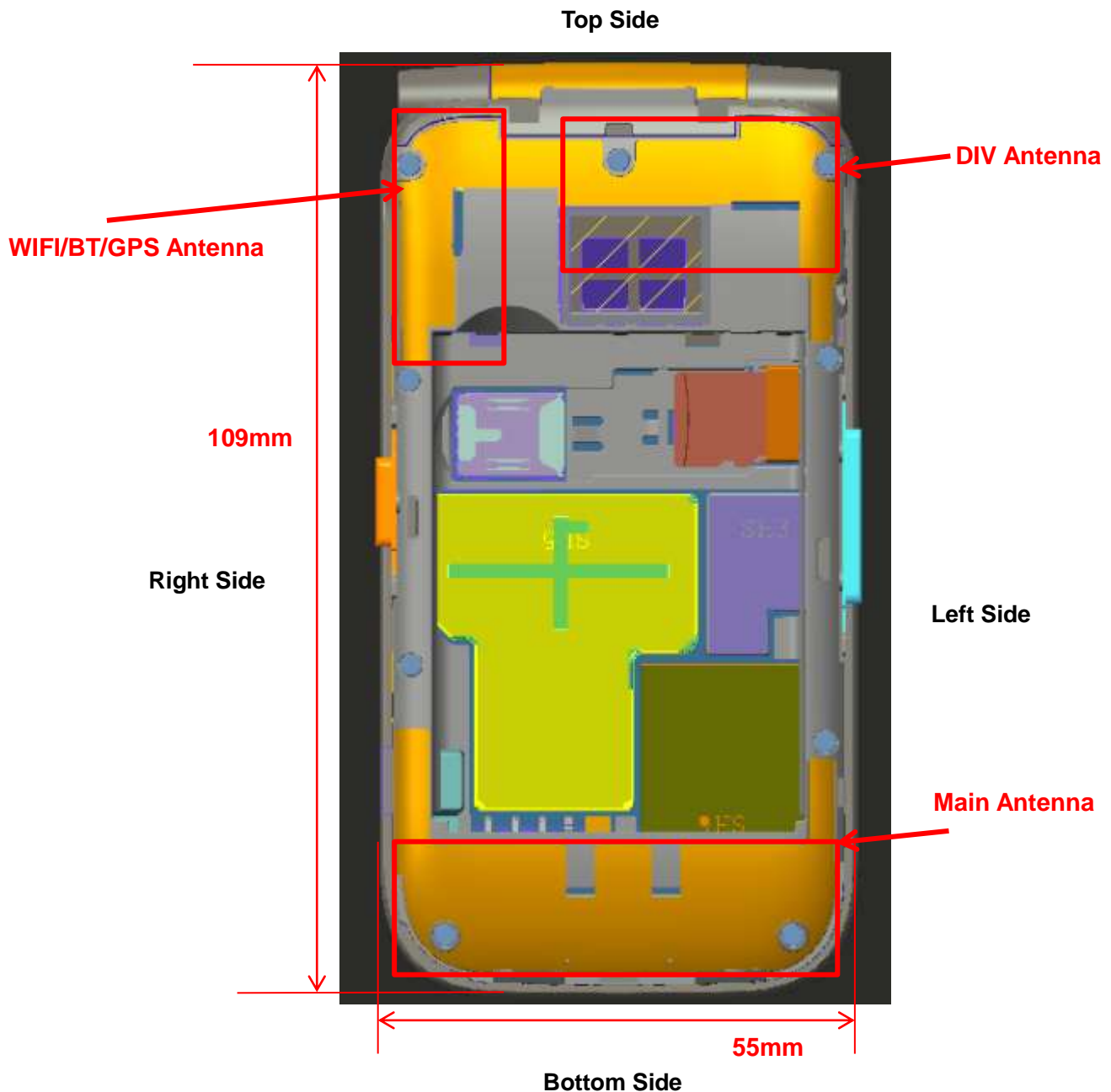

Picture 12.1 Antenna Locations (Back View)



### 11.3. SAR Measurement Positions

According to the KDB941225 D06 Hot Spot SAR, the edges with less than 25mm distance to the antennas need to be tested for SAR.

SAR measurement positions						
Mode	Front	Rear	Left edge	Right edge	Top edge	Bottom edge
Main antenna	Yes	Yes	Yes	Yes	No	Yes
WLAN antenna	Yes	Yes	Yes	Yes	Yes	No

### 11.4. Standalone SAR Test Exclusion Considerations

Standalone 1-g head or body SAR evaluation by measurement or numerical simulation is not required when the corresponding SAR Exclusion Threshold condition, listed below, is satisfied.

The 1-g SAR test exclusion threshold for 100 MHz to 6 GHz at test separation distances  $\leq 50$  mm are determined by:

$[(\text{max. power of channel, including tune-up tolerance, mW}) / (\text{min. test separation distance, mm})] \cdot [\sqrt{f(\text{GHz})}] \leq 3.0$  for 1-g SAR, where

- $f(\text{GHz})$  is the RF channel transmit frequency in GHz
- Power and distance are rounded to the nearest mW and mm before calculation
- The result is rounded to one decimal place for comparison

**Table 12.1: Standalone SAR test exclusion considerations**

Band/Mode	f(GHz)	Position	SAR test exclusion threshold (mW)	RF output power		SAR test exclusion
				dBm	mW	
Bluetooth	2.441	Head	9.60	1	1.26	Yes
		Body	19.20	1	1.26	Yes
WLAN 2.4GHz	2.45	Head	9.58	16	39.81	No
		Body	19.17	16	39.81	No

## 12. Evaluation of Simultaneous

**Table 12.1: The sum of reported SAR values for main antenna and WLAN**

/	Position	Main antenna	WLAN	Sum
Highest reported SAR value for Head	Left Cheek	0.41	0.08	0.49
Highest reported SAR value for Hotspot	Rear	1.29	0.11	1.40
Highest reported SAR value for Body-worn	Rear	1.29	0.11	1.40

Note: the test positions of above tables are for the worse case that has been evaluated.

**Table 12.2: The sum of reported SAR values for main antenna and Bluetooth**

/	Position	Main antenna	Bluetooth	Sum
Highest reported SAR value for Head	Left Cheek	0.41	0.05	0.46
Highest reported SAR value for Hotspot	Rear	1.29	0.03	1.32
Highest reported SAR value for Body-worn	Rear	1.29	0.03	1.32

Note: the test positions of above tables are for the worse case that has been evaluated.

**Table 12.3: Estimated SAR for Bluetooth**

Position	f (GHz)	Distance (mm)	Upper limit of power *		Estimated <sub>1g</sub> (W/kg)
			dBm	mW	
Head	2.441	5	1.0	1.26	0.05
Body	2.441	10	1.0	1.26	0.03

\* - Maximum possible output power declared by manufacturer

When standalone SAR test exclusion applies to an antenna that transmits simultaneously with other antennas, the standalone SAR must be estimated according to following to determine simultaneous transmission SAR test exclusion:

(max. power of channel, including tune-up tolerance, mW) / (min. test separation distance, mm) · [ $\sqrt{f(\text{GHz})/x}$ ] W/kg for test separation distances  $\leq 50$  mm;

Where  $x = 7.5$  for 1-g SAR.

When the minimum test separation distance is  $< 5$  mm, a distance of 5 mm is applied to determine SAR test exclusion

### Conclusion:

According to the above tables, the sum of reported SAR values is  $< 1.6\text{W/kg}$ . So the simultaneous transmission SAR with volume scans is not required.

### 13. Summary of Test Results

According to the client's decision rule in the test registration form, which is "based on the measurement results as the basis of the conformity statement", the test conclusion of this report meets the limit requirements.

The calculated SAR is obtained by the following formula:

$$\text{Reported SAR} = \text{Measured SAR} \times 10^{(P_{\text{Target}} - P_{\text{Measured}})/10}$$

Where  $P_{\text{Target}}$  is the power of manufacturing upper limit;

$P_{\text{Measured}}$  is the measured power in chapter 10.

**Note:** B2 (Battery), Zhuhai Coslight

#### Duty Cycle

Mode	Duty Cycle
Speech for GSM850/1900	1:8.3
GPRS for GSM850/1900	1:2
CDMA BC0/BC1/BC10	1:1
WCDMA Band 2/4/5	1:1
FDD_LTE Band 5/12/13/25//26/66/71	1:1
TDD_LTE Band 41 PC3	1:1.58
TDD_LTE Band 41 PC2	1:2.31

#### 13.1. Testing Environment

Temperature:	18°C~25°C
Relative humidity:	30%~70%
Ground system resistance:	<4Ω
Ambient noise & Reflection:	< 0.012 W/kg

### 13.2. SAR results

**Table 13.1: SAR Values (GSM 850 - Head)**

Frequency		Test Mode	Test Position	Figure No. / Note	Ambient Temperature: 22.7°C		Liquid Temperature: 22.2°C		
MHz	Ch.				Conducted Power (dBm)	Max. tune-up Power (dBm)	Measured SAR(1g) (W/kg)	Reported SAR(1g) (W/kg)	Power Drift(dB)
836.6	190	Speech	Left Cheek	/	33.09	34.0	0.143	<b>0.18</b>	0.06
836.6	190	Speech	Left Tilt	/	33.09	34.0	0.158	<b>0.19</b>	0.03
836.6	190	Speech	Right Cheek	<b>1</b>	33.09	34.0	<b>0.166</b>	<b>0.20</b>	0.08
836.6	190	Speech	Right Tilt	/	33.09	34.0	0.133	<b>0.16</b>	0.03
836.6	190	Speech	Right Cheek	B2	33.09	34.0	0.158	<b>0.19</b>	0.12

**Table 13.2: SAR Values (GSM 850 -Body)**

Frequency		Test Mode	Test Position	Figure No. / Note	Ambient Temperature: 22.7°C		Liquid Temperature: 22.2°C		
MHz	Ch.				Conducted Power (dBm)	Max. tune-up Power (dBm)	Measured SAR(1g) (W/kg)	Reported SAR(1g) (W/kg)	Power Drift(dB)
<b>Hotspot / Body-Worn Test Data (10mm)</b>									
836.6	190	GPRS	Front	/	27.89	28.5	0.290	<b>0.33</b>	0.07
836.6	190	GPRS	Rear	/	27.89	28.5	0.924	<b>1.06</b>	0.18
836.6	190	GPRS	Left	/	27.89	28.5	0.295	<b>0.34</b>	0.06
836.6	190	GPRS	Right	/	27.89	28.5	0.590	<b>0.68</b>	0.04
836.6	190	GPRS	Bottom	/	27.89	28.5	0.204	<b>0.23</b>	0.07
848.8	251	GPRS	Rear	/	27.76	28.5	0.822	<b>0.97</b>	0.18
824.2	128	GPRS	Rear	<b>2</b>	27.77	28.5	<b>0.993</b>	<b>1.17</b>	0.11
824.2	128	GPRS	Rear	B2	27.77	28.5	0.963	<b>1.14</b>	0.03

**Table 13.3: SAR Values (GSM 1900 - Head)**

Frequency		Test Mode	Test Position	Figure No. / Note	Conducted Power (dBm)	Max. tune-up Power (dBm)	Measured SAR(1g) (W/kg)	Reported SAR(1g) (W/kg)	Power Drift(dB)
MHz	Ch.								
		Ambient Temperature: 22.2°C		Liquid Temperature: 21.6°C					
1880	661	Speech	Left Cheek	3	31.13	32.0	0.175	0.21	0.17
1880	661	Speech	Left Tilt	/	31.13	32.0	0.077	0.09	0.02
1880	661	Speech	Right Cheek	/	31.13	32.0	0.098	0.12	0.05
1880	661	Speech	Right Tilt	/	31.13	32.0	0.066	0.08	0.00
1880	661	Speech	Left Cheek	B2	31.13	32.0	0.163	0.20	0.17

**Table 13.4: SAR Values (GSM 1900 - Body)**

Frequency		Test Mode	Test Position	Figure No. / Note	Conducted Power (dBm)	Max. tune-up Power (dBm)	Measured SAR(1g) (W/kg)	Reported SAR(1g) (W/kg)	Power Drift(dB)
MHz	Ch.								
		Ambient Temperature: 22.2°C		Liquid Temperature: 21.6°C					
<b>Hotspot Test Data (10mm)</b>									
1880	661	GPRS	Front	/	24.47	25.5	0.124	0.16	0.01
1880	661	GPRS	Rear	4	24.47	25.5	0.627	0.79	0.07
1880	661	GPRS	Left	/	24.47	25.5	0.048	0.06	0.03
1880	661	GPRS	Right	/	24.47	25.5	0.059	0.07	0.05
1880	661	GPRS	Bottom	/	24.47	25.5	0.406	0.51	0.09
1880	661	GPRS	Rear	B2	24.47	25.5	0.617	0.78	0.03
<b>Body-Worn Test Data (15mm)</b>									
1880	661	GPRS	Front	/	27.00	28.0	0.161	0.20	0.03
1880	661	GPRS	Rear	/	27.00	28.0	0.572	0.72	0.07

**Table 13.5: SAR Values (CDMA BC0 - Head)**

Frequency		Test Mode	Test Position	Figure No. / Note	Conducted Power (dBm)	Max. tune-up Power (dBm)	Measured SAR(1g) (W/kg)	Reported SAR(1g) (W/kg)	Power Drift(dB)
MHz	Ch.								
Ambient Temperature: 22.7°C		Liquid Temperature: 22.2°C							
836.52	384	SO55	Left Cheek	/	23.01	23.5	0.189	<b>0.21</b>	0.09
836.52	384	SO55	Left Tilt	/	23.01	23.5	0.131	<b>0.15</b>	0.02
836.52	384	SO55	Right Cheek	<b>5</b>	23.01	23.5	<b>0.257</b>	<b>0.29</b>	0.12
836.52	384	SO55	Right Tilt	/	23.01	23.5	0.149	<b>0.17</b>	-0.03
836.52	384	SO55	Right Cheek	B2	23.01	23.5	0.244	<b>0.27</b>	0.03

**Table 13.6: SAR Values (CDMA BC0 -Body)**

Frequency		Test Mode	Test Position	Figure No. / Note	Conducted Power (dBm)	Max. tune-up Power (dBm)	Measured SAR(1g) (W/kg)	Reported SAR(1g) (W/kg)	Power Drift(dB)
MHz	Ch.								
Ambient Temperature: 22.7°C		Liquid Temperature: 22.2°C							
<b>Hotspot / Body-Worn Test Data (10mm)</b>									
836.52	384	SO32	Front	/	22.98	23.5	0.307	<b>0.35</b>	0.10
836.52	384	SO32	Rear	<b>6</b>	22.98	23.5	<b>0.911</b>	<b>1.03</b>	0.09
836.52	384	SO32	Left	/	22.98	23.5	0.388	<b>0.44</b>	-0.05
836.52	384	SO32	Right	/	22.98	23.5	0.493	<b>0.56</b>	0.07
836.52	384	SO32	Bottom	/	22.98	23.5	0.163	<b>0.18</b>	0.12
848.31	777	SO32	Rear	/	22.24	23.5	0.654	<b>0.87</b>	-0.07
824.70	1013	SO32	Rear	/	22.14	23.5	0.664	<b>0.91</b>	0.00
836.52	384	SO32	Rear	B2	22.98	23.5	0.903	<b>1.02</b>	0.03

**Table 13.7: SAR Values (CDMA BC1 - Head)**

Frequency		Test Mode	Test Position	Figure No. / Note	Conducted Power (dBm)	Max. tune-up Power (dBm)	Measured SAR(1g) (W/kg)	Reported SAR(1g) (W/kg)	Power Drift(dB)
MHz	Ch.								
Ambient Temperature: 22.2°C      Liquid Temperature: 21.6°C									
1880	600	SO55	Left Cheek	7	22.50	23.5	0.325	0.41	-0.04
1880	600	SO55	Left Tilt	/	22.50	23.5	0.152	0.19	0.05
1880	600	SO55	Right Cheek	/	22.50	23.5	0.199	0.25	-0.03
1880	600	SO55	Right Tilt	/	22.50	23.5	0.133	0.17	0.10
1880	600	SO55	Left Cheek	B2	22.50	23.5	0.301	0.38	0.03

**Table 13.8: SAR Values (CDMA BC1 - Body)**

Frequency		Test Mode	Test Position	Figure No. / Note	Conducted Power (dBm)	Max. tune-up Power (dBm)	Measured SAR(1g) (W/kg)	Reported SAR(1g) (W/kg)	Power Drift(dB)
MHz	Ch.								
Ambient Temperature: 22.2°C      Liquid Temperature: 21.6°C									
<b>Hotspot Test Data (10mm)</b>									
1880	600	SO32	Front	/	17.86	19.0	0.083	0.11	0.12
1880	600	SO32	Rear	/	17.86	19.0	0.422	0.55	0.12
1880	600	SO32	Left	/	17.86	19.0	0.131	0.17	0.00
1880	600	SO32	Right	/	17.86	19.0	0.032	0.04	0.09
1880	600	SO32	Bottom	/	17.86	19.0	0.291	0.38	0.09
<b>Body-Worn Test Data (15mm)</b>									
1880	600	SO32	Front	/	22.48	23.5	0.176	0.22	0.04
1880	600	SO32	Rear	8	22.48	23.5	0.636	0.80	0.03
1880	600	SO32	Rear	B2	22.48	23.5	0.606	0.77	0.03

**Table 13.9: SAR Values (CDMA BC10 - Head)**

Frequency		Test Mode	Test Position	Figure No. / Note	Conducted Power (dBm)	Max. tune-up Power (dBm)	Measured SAR(1g) (W/kg)	Reported SAR(1g) (W/kg)	Power Drift(dB)
MHz	Ch.								
		Ambient Temperature: 22.7°C		Liquid Temperature: 22.2°C					
820.5	580	SO55	Left Cheek	/	22.84	23.5	0.127	<b>0.15</b>	-0.03
820.5	580	SO55	Left Tilt	/	22.84	23.5	0.059	<b>0.07</b>	-0.13
820.5	580	SO55	Right Cheek	<b>9</b>	22.84	23.5	<b>0.236</b>	<b>0.27</b>	0.00
820.5	580	SO55	Right Tilt	/	22.84	23.5	0.074	<b>0.09</b>	0.03
820.5	580	SO55	Right Cheek	B2	22.84	23.5	0.206	<b>0.24</b>	0.03

**Table 13.10: SAR Values (CDMA BC10 - Body)**

Frequency		Test Mode	Test Position	Figure No. / Note	Conducted Power (dBm)	Max. tune-up Power (dBm)	Measured SAR(1g) (W/kg)	Reported SAR(1g) (W/kg)	Power Drift(dB)
MHz	Ch.								
		Ambient Temperature: 22.7°C		Liquid Temperature: 22.2°C					
<b>Hotspot / Body-Worn Test Data (10mm)</b>									
820.5	580	SO32	Front	/	22.80	23.5	0.290	<b>0.34</b>	0.00
820.5	580	SO32	Rear	/	22.80	23.5	0.893	<b>1.05</b>	-0.16
820.5	580	SO32	Left	/	22.80	23.5	0.393	<b>0.46</b>	-0.13
820.5	580	SO32	Right	/	22.80	23.5	0.438	<b>0.51</b>	0.08
820.5	580	SO32	Bottom	/	22.80	23.5	0.119	<b>0.14</b>	-0.07
823.1	684	SO32	Rear	/	23.30	23.5	0.742	<b>0.78</b>	-0.07
817.9	476	SO32	Rear	<b>10</b>	22.91	23.5	<b>0.958</b>	<b>1.10</b>	0.03
817.9	476	SO32	Rear	B2	22.91	23.5	0.947	<b>1.08</b>	0.03



**Table 13.11: SAR Values (WCDMA Band 2 - Head)**

Frequency		Test Mode	Test Position	Figure No. / Note	Conducted Power (dBm)	Max. tune-up Power (dBm)	Measured SAR(1g) (W/kg)	Reported SAR(1g) (W/kg)	Power Drift(dB)
MHz	Ch.								
Ambient Temperature: 22.2°C      Liquid Temperature: 21.6°C									
1880	9400	RMC	Left Cheek	11	22.70	23.5	0.143	0.17	0.08
1880	9400	RMC	Left Tilt	/	22.70	23.5	0.059	0.07	0.07
1880	9400	RMC	Right Cheek	/	22.70	23.5	0.092	0.11	0.12
1880	9400	RMC	Right Tilt	/	22.70	23.5	0.051	0.06	0.03
1880	9400	RMC	Left Cheek	B2	22.70	23.5	0.133	0.16	0.03

**Table 13.12: SAR Values (WCDMA Band 2 - Body)**

Frequency		Test Mode	Test Position	Figure No. / Note	Conducted Power (dBm)	Max. tune-up Power (dBm)	Measured SAR(1g) (W/kg)	Reported SAR(1g) (W/kg)	Power Drift(dB)
MHz	Ch.								
Ambient Temperature: 22.2°C      Liquid Temperature: 21.6°C									
<b>Hotspot / Body-Worn Test Data (10mm)</b>									
1880	9400	RMC	Front	/	22.70	23.5	0.125	0.15	0.03
1880	9400	RMC	Rear	/	22.70	23.5	0.848	1.02	0.15
1880	9400	RMC	Left	/	22.70	23.5	0.255	0.31	0.07
1880	9400	RMC	Right	/	22.70	23.5	0.060	0.07	0.12
1880	9400	RMC	Bottom	/	22.70	23.5	0.595	0.72	0.05
1907.6	9538	RMC	Rear	12	23.00	23.5	0.942	1.06	0.06
1852.4	9262	RMC	Rear	/	22.70	23.5	0.736	0.88	0.03
1907.6	9538	RMC	Rear	B2	23.00	23.5	0.933	1.05	0.12

**Table 13.13: SAR Values (WCDMA Band 4 - Head)**

Frequency		Test Mode	Figure No. / Note	Figure No.	Conducted Power (dBm)	Max. tune-up Power (dBm)	Measured SAR(1g) (W/kg)	Reported SAR(1g) (W/kg)	Power Drift(dB)
MHz	Ch.								
Ambient Temperature: 22.2°C		Liquid Temperature: 21.7°C							
1732.6	1413	RMC	Left Cheek	/	22.80	23.5	0.254	<b>0.30</b>	-0.01
1732.6	1413	RMC	Left Tilt	<b>13</b>	22.80	23.5	<b>0.272</b>	<b>0.32</b>	0.12
1732.6	1413	RMC	Right Cheek	/	22.80	23.5	0.268	<b>0.31</b>	0.11
1732.6	1413	RMC	Right Tilt	/	22.80	23.5	0.234	<b>0.27</b>	0.02
1732.6	1413	RMC	Left Tilt	B2	22.80	23.5	0.263	<b>0.31</b>	0.03

**Table 13.14: SAR Values (WCDMA Band 4 - Body)**

Frequency		Test Mode	Figure No. / Note	Figure No.	Conducted Power (dBm)	Max. tune-up Power (dBm)	Measured SAR(1g) (W/kg)	Reported SAR(1g) (W/kg)	Power Drift(dB)
MHz	Ch.								
Ambient Temperature: 22.2°C		Liquid Temperature: 21.7°C							
<b>Hotspot Test Data (10mm)</b>									
1732.6	1413	RMC	Front	/	21.50	22.5	0.203	<b>0.26</b>	0.16
1732.6	1413	RMC	Rear	/	21.50	22.5	0.830	<b>1.04</b>	0.04
1732.6	1413	RMC	Left	/	21.50	22.5	0.585	<b>0.74</b>	0.08
1732.6	1413	RMC	Right	/	21.50	22.5	0.191	<b>0.24</b>	0.01
1732.6	1413	RMC	Bottom	/	21.50	22.5	0.706	<b>0.89</b>	0.04
1752.6	1513	RMC	Rear	/	21.30	22.5	0.870	<b>1.15</b>	0.02
1712.4	1312	RMC	Rear	/	21.20	22.5	0.801	<b>1.08</b>	0.03
1752.6	1513	RMC	Bottom	/	21.30	22.5	0.706	<b>0.93</b>	0.02
1712.4	1312	RMC	Bottom	/	21.20	22.5	0.687	<b>0.93</b>	0.03
1752.6	1513	RMC	Rear	B2	21.30	22.5	0.863	<b>1.14</b>	-0.17
<b>Body-Worn Test Data (15mm)</b>									
1732.6	1413	RMC	Front	/	22.80	23.5	0.246	<b>0.29</b>	-0.14
1732.6	1413	RMC	Rear	<b>14</b>	22.80	23.5	<b>0.897</b>	<b>1.05</b>	-0.08
1752.6	1513	RMC	Rear	/	22.80	23.5	0.817	<b>0.96</b>	0.12
1712.4	1312	RMC	Rear	/	22.80	23.5	0.696	<b>0.82</b>	0.04

**Table 13.15: SAR Values (WCDMA Band 5 - Head)**

Frequency		Test Mode	Test Position	Figure No. / Note	Conducted Power (dBm)	Max. tune-up Power (dBm)	Measured SAR(1g) (W/kg)	Reported SAR(1g) (W/kg)	Power Drift(dB)
MHz	Ch.								
Ambient Temperature: 22.7°C      Liquid Temperature: 22.2°C									
836.4	4182	RMC	Left Cheek	/	22.80	23.5	0.157	<b>0.18</b>	0.14
836.4	4182	RMC	Left Tilt	/	22.80	23.5	0.219	<b>0.26</b>	0.07
836.4	4182	RMC	Right Cheek	<b>15</b>	22.80	23.5	<b>0.275</b>	<b>0.32</b>	0.09
836.4	4182	RMC	Right Tilt	/	22.80	23.5	0.271	<b>0.32</b>	0.11
836.4	4182	RMC	Right Cheek	B2	22.80	23.5	0.271	<b>0.32</b>	0.03

**Table 13.16: SAR Values (WCDMA Band 5 -Body)**

Frequency		Test Mode	Test Position	Figure No. / Note	Conducted Power (dBm)	Max. tune-up Power (dBm)	Measured SAR(1g) (W/kg)	Reported SAR(1g) (W/kg)	Power Drift(dB)
MHz	Ch.								
Ambient Temperature: 22.7°C      Liquid Temperature: 22.2°C									
<b>Hotspot / Body-Worn Test Data (10mm)</b>									
836.4	4182	RMC	Front	/	22.80	23.5	0.120	<b>0.14</b>	0.07
836.4	4182	RMC	Rear	<b>16</b>	22.80	23.5	<b>0.448</b>	<b>0.53</b>	0.00
836.4	4182	RMC	Left	/	22.80	23.5	0.222	<b>0.26</b>	0.05
836.4	4182	RMC	Right	/	22.80	23.5	0.285	<b>0.33</b>	0.12
836.4	4182	RMC	Bottom	/	22.80	23.5	0.087	<b>0.10</b>	0.07
836.4	4182	RMC	Rear	B2	22.80	23.5	0.434	<b>0.51</b>	0.03

**Table 13.17: SAR Values (LTE Band 5 - Head)**

Frequency		Test Mode	Test Position	Figure No. / Note	Conducted Power (dBm)	Max. tune-up Power (dBm)	Measured SAR(1g) (W/kg)	Reported SAR(1g) (W/kg)	Power Drift(dB)
MHz	Ch.								
Ambient Temperature: 22.7°C      Liquid Temperature: 22.2°C									
836.5	20525	1RB_24	Left Cheek	/	23.05	24.0	0.144	<b>0.18</b>	0.01
836.5	20525	25RB_12	Left Cheek	/	22.13	23.0	0.109	<b>0.13</b>	0.10
836.5	20525	1RB_24	Left Tilt	/	23.05	24.0	0.073	<b>0.09</b>	0.02
836.5	20525	25RB_12	Left Tilt	/	22.13	23.0	0.057	<b>0.07</b>	-0.08
836.5	20525	1RB_24	Right Cheek	<b>17</b>	23.05	24.0	<b>0.209</b>	<b>0.26</b>	0.09
836.5	20525	25RB_12	Right Cheek	/	22.13	23.0	0.164	<b>0.20</b>	0.06
836.5	20525	1RB_24	Right Tilt	/	23.05	24.0	0.083	<b>0.10</b>	0.16
836.5	20525	25RB_12	Right Tilt	/	22.13	23.0	0.651	<b>0.80</b>	0.06
836.5	20525	1RB_24	Right Cheek	B2	23.05	24.0	0.189	<b>0.24</b>	0.07

**Table 13.18: SAR Values (LTE Band 5 - Body)**

Frequency		Test Mode	Test Position	Figure No. / Note	Conducted Power (dBm)	Max. tune-up Power (dBm)	Measured SAR(1g) (W/kg)	Reported SAR(1g) (W/kg)	Power Drift(dB)
MHz	Ch.								
Ambient Temperature: 22.7°C      Liquid Temperature: 22.2°C									
<b>Hotspot / Body-Worn Test Data (10mm)</b>									
836.5	20525	1RB_24	Front	/	23.05	24.0	0.177	<b>0.22</b>	0.04
836.5	20525	25RB_12	Front	/	22.13	23.0	0.141	<b>0.17</b>	0.08
836.5	20525	1RB_24	Rear	<b>18</b>	23.05	24.0	<b>0.538</b>	<b>0.67</b>	0.06
836.5	20525	25RB_12	Rear	/	22.13	23.0	0.436	<b>0.53</b>	0.04
836.5	20525	1RB_24	Left	/	23.05	24.0	0.295	<b>0.37</b>	-0.14
836.5	20525	25RB_12	Left	/	22.13	23.0	0.191	<b>0.23</b>	0.11
836.5	20525	1RB_24	Right	/	23.05	24.0	0.321	<b>0.40</b>	0.19
836.5	20525	25RB_12	Right	/	22.13	23.0	0.248	<b>0.30</b>	0.01
836.5	20525	1RB_24	Bottom	/	23.05	24.0	0.093	<b>0.12</b>	0.08
836.5	20525	25RB_12	Bottom	/	22.13	23.0	0.075	<b>0.09</b>	0.02
836.5	20525	1RB_24	Rear	B2	23.05	24.0	0.528	<b>0.66</b>	0.03

**Table 13.19: SAR Values (LTE Band 12 - Head)**

Frequency		Test Mode	Test Position	Figure No. / Note	Ambient Temperature: 22.5°C		Liquid Temperature: 22.0°C		
MHz	Ch.				Conducted Power (dBm)	Max. tune-up Power (dBm)	Measured SAR(1g) (W/kg)	Reported SAR(1g) (W/kg)	Power Drift(dB)
704	23060	1RB_24	Left Cheek	<b>19</b>	23.14	24.0	<b>0.217</b>	<b>0.26</b>	0.15
704	23060	25RB_25	Left Cheek	/	22.02	23.0	0.155	<b>0.19</b>	0.07
704	23060	1RB_24	Left Tilt	/	23.14	24.0	0.130	<b>0.16</b>	0.12
704	23060	25RB_25	Left Tilt	/	22.02	23.0	0.095	<b>0.12</b>	0.07
704	23060	1RB_24	Right Cheek	/	23.14	24.0	0.207	<b>0.25</b>	0.03
704	23060	25RB_25	Right Cheek	/	22.02	23.0	0.152	<b>0.19</b>	0.15
704	23060	1RB_24	Right Tilt	/	23.14	24.0	0.121	<b>0.15</b>	0.10
704	23060	25RB_25	Right Tilt	/	22.02	23.0	0.090	<b>0.11</b>	0.10
704	23060	1RB_24	Left Cheek	B2	23.14	24.0	0.198	<b>0.24</b>	0.03

**Table 13.20: SAR Values (LTE Band 12 - Body)**

Frequency		Test Mode	Test Position	Figure No. / Note	Ambient Temperature: 22.5°C		Liquid Temperature: 22.0°C		
MHz	Ch.				Conducted Power (dBm)	Max. tune-up Power (dBm)	Measured SAR(1g) (W/kg)	Reported SAR(1g) (W/kg)	Power Drift(dB)
<b>Hotspot / Body-Worn Test Data (10mm)</b>									
704	23060	1RB_24	Front	/	23.14	24.0	0.072	<b>0.09</b>	0.02
704	23060	25RB_25	Front	/	22.02	23.0	0.062	<b>0.08</b>	0.01
704	23060	1RB_24	Rear	<b>20</b>	23.14	24.0	<b>0.322</b>	<b>0.39</b>	0.03
704	23060	25RB_25	Rear	/	22.02	23.0	0.273	<b>0.34</b>	0.17
704	23060	1RB_24	Left	/	23.14	24.0	0.145	<b>0.18</b>	0.09
704	23060	25RB_25	Left	/	22.02	23.0	0.112	<b>0.14</b>	0.08
704	23060	1RB_24	Right	/	23.14	24.0	0.117	<b>0.14</b>	0.01
704	23060	25RB_25	Right	/	22.02	23.0	0.090	<b>0.11</b>	0.08
704	23060	1RB_24	Bottom	/	23.14	24.0	0.073	<b>0.09</b>	0.07
704	23060	25RB_25	Bottom	/	22.02	23.0	0.059	<b>0.07</b>	0.18
704	23060	1RB_24	Rear	B2	23.14	24.0	0.301	<b>0.37</b>	0.12

**Note:** SAR for LTE Band 17 is covered by LTE Band 12 due to similar frequency range, same maximum tune-up limit and same channel bandwidth.

**Table 13.21: SAR Values (LTE Band 13 - Head)**

Frequency		Test Mode	Test Position	Figure No. / Note	Conducted Power (dBm)	Max. tune-up Power (dBm)	Measured SAR(1g) (W/kg)	Reported SAR(1g) (W/kg)	Power Drift(dB)
MHz	Ch.								
Ambient Temperature: 22.5°C					Liquid Temperature: 22.0°C				
782	23230	1RB_49	Left Cheek	/	23.23	24.0	0.037	<b>0.04</b>	0.05
782	23230	25RB_12	Left Cheek	/	22.27	23.0	0.035	<b>0.04</b>	0.00
782	23230	1RB_49	Left Tilt	/	23.23	24.0	0.023	<b>0.03</b>	0.05
782	23230	25RB_12	Left Tilt	/	22.27	23.0	0.023	<b>0.03</b>	0.06
782	23230	1RB_49	Right Cheek	<b>21</b>	23.23	24.0	<b>0.044</b>	<b>0.05</b>	0.14
782	23230	25RB_12	Right Cheek	/	22.27	23.0	0.038	<b>0.05</b>	-0.03
782	23230	1RB_49	Right Tilt	/	23.23	24.0	0.024	<b>0.03</b>	0.01
782	23230	25RB_12	Right Tilt	/	22.27	23.0	0.024	<b>0.03</b>	0.08
782	23230	1RB_49	Right Cheek	B2	23.23	24.0	0.040	<b>0.05</b>	0.03

**Table 13.22: SAR Values (LTE Band 13 - Body)**

Frequency		Test Mode	Test Position	Figure No. / Note	Conducted Power (dBm)	Max. tune-up Power (dBm)	Measured SAR(1g) (W/kg)	Reported SAR(1g) (W/kg)	Power Drift(dB)
MHz	Ch.								
Ambient Temperature: 22.5°C					Liquid Temperature: 22.0°C				
<b>Hotspot / Body-Worn Test Data (10mm)</b>									
782	23230	1RB_49	Front	/	23.23	24.0	0.012	<b>0.01</b>	0.09
782	23230	25RB_12	Front	/	22.27	23.0	0.009	<b>0.01</b>	0.08
782	23230	1RB_49	Rear	<b>22</b>	23.23	24.0	<b>0.074</b>	<b>0.09</b>	0.02
782	23230	25RB_12	Rear	/	22.27	23.0	0.059	<b>0.07</b>	0.19
782	23230	1RB_49	Left	/	23.23	24.0	0.016	<b>0.02</b>	0.11
782	23230	25RB_12	Left	/	22.27	23.0	0.012	<b>0.01</b>	0.01
782	23230	1RB_49	Right	/	23.23	24.0	0.023	<b>0.03</b>	0.18
782	23230	25RB_12	Right	/	22.27	23.0	0.018	<b>0.02</b>	0.18
782	23230	1RB_49	Bottom	/	23.23	24.0	0.039	<b>0.05</b>	0.16
782	23230	25RB_12	Bottom	/	22.27	23.0	0.031	<b>0.04</b>	0.12
782	23230	1RB_49	Rear	B2	23.23	24.0	0.070	<b>0.08</b>	0.03

**Table 13.23: SAR Values (LTE Band 25 - Head)**

Frequency		Test Mode	Test Position	Figure No. / Note	Conducted Power (dBm)	Max. tune-up Power (dBm)	Measured SAR(1g) (W/kg)	Reported SAR(1g) (W/kg)	Power Drift(dB)
MHz	Ch.								
Ambient Temperature: 22.2°C      Liquid Temperature: 21.6°C									
1860	26140	1RB_0	Left Cheek	<b>23</b>	23.14	24.0	<b>0.248</b>	<b>0.30</b>	0.08
1860	26140	50RB_25	Left Cheek	/	22.00	23.0	0.184	<b>0.23</b>	0.16
1860	26140	1RB_0	Left Tilt	/	23.14	24.0	0.127	<b>0.15</b>	0.02
1860	26140	50RB_25	Left Tilt	/	22.00	23.0	0.099	<b>0.12</b>	0.08
1860	26140	1RB_0	Right Cheek	/	23.14	24.0	0.155	<b>0.19</b>	0.01
1860	26140	50RB_25	Right Cheek	/	22.00	23.0	0.119	<b>0.15</b>	0.05
1860	26140	1RB_0	Right Tilt	/	23.14	24.0	0.100	<b>0.12</b>	0.06
1860	26140	50RB_25	Right Tilt	/	22.00	23.0	0.076	<b>0.10</b>	0.04
1860	26140	1RB_0	Left Cheek	B2	23.14	24.0	0.223	<b>0.27</b>	0.03

**Table 13.24: SAR Values (LTE Band 25 - Body)**

Frequency		Test Mode	Test Position	Figure No. / Note	Conducted Power (dBm)	Max. tune-up Power (dBm)	Measured SAR(1g) (W/kg)	Reported SAR(1g) (W/kg)	Power Drift(dB)
MHz	Ch.								
Ambient Temperature: 22.2°C      Liquid Temperature: 21.6°C									
<b>Hotspot / Body-Worn Test Data (10mm)</b>									
1860	26140	1RB_0	Front	/	23.14	24.0	0.182	<b>0.22</b>	0.01
1860	26140	50RB_25	Front	/	22.00	23.0	0.143	<b>0.18</b>	0.07
1860	26140	1RB_0	Rear	/	23.14	24.0	0.773	<b>0.94</b>	0.06
1860	26140	50RB_25	Rear	/	22.00	23.0	0.594	<b>0.75</b>	0.04
1860	26140	1RB_0	Left	/	23.14	24.0	0.302	<b>0.37</b>	0.09
1860	26140	50RB_25	Left	/	22.00	23.0	0.236	<b>0.30</b>	0.10
1860	26140	1RB_0	Right	/	23.14	24.0	0.084	<b>0.10</b>	0.05
1860	26140	50RB_25	Right	/	22.00	23.0	0.068	<b>0.09</b>	0.06
1860	26140	1RB_0	Bottom	/	23.14	24.0	0.559	<b>0.68</b>	0.01
1860	26140	50RB_25	Bottom	/	22.00	23.0	0.454	<b>0.57</b>	0.03
1905	26590	1RB_0	Rear	<b>24</b>	22.82	24.0	<b>0.980</b>	<b>1.29</b>	0.03
1882.5	26365	1RB_0	Rear	/	22.88	24.0	0.867	<b>1.12</b>	0.01
1860	26140	100RB	Rear	/	22.02	23.0	0.610	<b>0.76</b>	0.03
1905	26590	1RB_0	Rear	Headset	22.82	24.0	0.957	<b>1.26</b>	0.12
1905	26590	1RB_0	Rear	B2	22.82	24.0	0.970	<b>1.27</b>	0.03

**Note:** SAR for LTE Band 2 is covered by LTE Band 25 due to similar frequency range, same maximum tune-up limit and same channel bandwidth.

**Table 13.25: SAR Values (LTE Band 26 - Head)**

Frequency		Test Mode	Test Position	Figure No. / Note	Conducted Power (dBm)	Max. tune-up Power (dBm)	Measured SAR(1g) (W/kg)	Reported SAR(1g) (W/kg)	Power Drift(dB)
MHz	Ch.								
Ambient Temperature: 22.7°C      Liquid Temperature: 22.2°C									
822.5	26775	1RB_37	Left Cheek	/	23.25	24.0	0.180	<b>0.21</b>	0.06
822.5	26775	36RB_19	Left Cheek	/	22.36	23.0	0.128	<b>0.15</b>	0.03
822.5	26775	1RB_37	Left Tilt	/	23.25	24.0	0.104	<b>0.12</b>	0.03
822.5	26775	36RB_19	Left Tilt	/	22.36	23.0	0.066	<b>0.08</b>	0.02
822.5	26775	1RB_37	Right Cheek	<b>25</b>	23.25	24.0	<b>0.271</b>	<b>0.32</b>	0.09
822.5	26775	36RB_19	Right Cheek	/	22.36	23.0	0.192	<b>0.22</b>	0.10
822.5	26775	1RB_37	Right Tilt	/	23.25	24.0	0.113	<b>0.13</b>	0.13
822.5	26775	36RB_19	Right Tilt	/	22.36	23.0	0.073	<b>0.08</b>	0.05
822.5	26775	1RB_37	Right Cheek	B2	23.25	24.0	0.263	<b>0.31</b>	0.03

**Table 13.26: SAR Values (LTE Band 26 - Body)**

Frequency		Test Mode	Test Position	Figure No. / Note	Conducted Power (dBm)	Max. tune-up Power (dBm)	Measured SAR(1g) (W/kg)	Reported SAR(1g) (W/kg)	Power Drift(dB)
MHz	Ch.								
Ambient Temperature: 22.7°C      Liquid Temperature: 22.2°C									
<b>Hotspot / Body-Worn Test Data (10mm)</b>									
822.5	26775	1RB_37	Front	/	23.25	24.0	0.200	<b>0.24</b>	-0.05
822.5	26775	36RB_19	Front	/	22.36	23.0	0.148	<b>0.17</b>	0.08
822.5	26775	1RB_37	Rear	<b>26</b>	23.25	24.0	<b>0.575</b>	<b>0.68</b>	0.01
822.5	26775	36RB_19	Rear	/	22.36	23.0	0.463	<b>0.54</b>	0.03
822.5	26775	1RB_37	Left	/	23.25	24.0	0.270	<b>0.32</b>	0.02
822.5	26775	36RB_19	Left	/	22.36	23.0	0.198	<b>0.23</b>	0.06
822.5	26775	1RB_37	Right	/	23.25	24.0	0.328	<b>0.39</b>	0.03
822.5	26775	36RB_19	Right	/	22.36	23.0	0.268	<b>0.31</b>	0.06
822.5	26775	1RB_37	Bottom	/	23.25	24.0	0.096	<b>0.11</b>	0.02
822.5	26775	36RB_19	Bottom	/	22.36	23.0	0.078	<b>0.09</b>	-0.04
822.5	26775	1RB_37	Rear	B2	23.25	24.0	0.553	<b>0.66</b>	0.03



**Table 13.27: SAR Values (LTE Band 41 - Head)**

Frequency		Ambient Temperature: 22.6°C			Liquid Temperature: 22.2°C				
MHz	Ch.	Test Mode	Test Position	Figure No. / Note	Conducted Power (dBm)	Max. tune-up Power (dBm)	Measured SAR(1g) (W/kg)	Reported SAR(1g) (W/kg)	Power Drift(dB)
2506	39750	1RB_50	Left Cheek	/	24.10	24.5	0.218	<b>0.24</b>	-0.06
2506	39750	50RB_0	Left Cheek	/	22.78	23.5	0.166	<b>0.20</b>	0.04
2506	39750	1RB_50	Left Tilt	/	24.10	24.5	0.030	<b>0.03</b>	0.05
2506	39750	50RB_0	Left Tilt	/	22.78	23.5	0.020	<b>0.02</b>	0.04
2506	39750	1RB_50	Right Cheek	/	24.10	24.5	0.165	<b>0.18</b>	-0.01
2506	39750	50RB_0	Right Cheek	/	22.78	23.5	0.076	<b>0.09</b>	-0.12
2506	39750	1RB_50	Right Tilt	/	24.10	24.5	0.025	<b>0.03</b>	-0.03
2506	39750	50RB_0	Right Tilt	/	22.78	23.5	0.008	<b>0.01</b>	-0.07
2506	39750	1RB_50	Left Cheek	B2	24.10	24.5	0.207	<b>0.23</b>	0.03
<b>The worst case with PC2</b>									
2506	39750	1RB_50	Left Cheek	<b>27</b>	26.64	27.0	<b>0.286</b>	<b>0.31</b>	0.05

Note: Per **TCB workshop May 2017** Guidance, all SAR tests were performed using power class 3. SAR with power class 2 at the available duty factor was additionally performed for the power class 3 configuration with the highest SAR configuration for each exposure conditions. Please see **ANNEX G** for linearity results.

**Table 13.28: SAR Values (LTE Band 41 - Body)**

Frequency		Test Mode	Test Position	Figure No. / Note	Ambient Temperature: 22.6°C		Liquid Temperature: 22.2°C		
MHz	Ch.				Conducted Power (dBm)	Max. tune-up Power (dBm)	Measured SAR(1g) (W/kg)	Reported SAR(1g) (W/kg)	Power Drift(dB)
<b>Hotspot Test Data (10mm)</b>									
2506	39750	1RB_50	Front	/	19.56	20.5	0.072	<b>0.09</b>	0.03
2506	39750	50RB_25	Front	/	19.63	20.5	0.071	<b>0.09</b>	0.00
2506	39750	1RB_50	Rear	/	19.56	20.5	0.592	<b>0.74</b>	0.01
2506	39750	50RB_25	Rear	/	19.63	20.5	0.591	<b>0.72</b>	0.04
2506	39750	1RB_50	Left	/	19.56	20.5	0.113	<b>0.14</b>	0.07
2506	39750	50RB_25	Left	/	19.63	20.5	0.091	<b>0.11</b>	0.12
2506	39750	1RB_50	Right	/	19.56	20.5	0.224	<b>0.28</b>	0.03
2506	39750	50RB_25	Right	/	19.63	20.5	0.184	<b>0.22</b>	0.05
2506	39750	1RB_50	Bottom	/	19.56	20.5	0.281	<b>0.35</b>	0.12
2506	39750	50RB_25	Bottom	/	19.63	20.5	0.227	<b>0.28</b>	0.03
<b>Hotspot - The worst case with PC2</b>									
2506	39750	1RB_50	Rear	/	19.73	20.5	0.411	<b>0.49</b>	0.04
<b>Body-Worn Test Data (15mm)</b>									
2506	39750	1RB_50	Front	/	24.10	24.5	0.061	<b>0.07</b>	0.18
2506	39750	50RB_0	Front	/	22.78	23.5	0.047	<b>0.06</b>	0.06
2506	39750	1RB_50	Rear	/	24.10	24.5	0.788	<b>0.86</b>	0.03
2506	39750	50RB_0	Rear	/	22.78	23.5	0.545	<b>0.64</b>	0.09
2680	41490	1RB_50	Rear	/	23.15	24.5	0.477	<b>0.65</b>	0.08
2636.5	41055	1RB_50	Rear	/	23.51	24.5	0.598	<b>0.75</b>	0.14
2593	40620	1RB_50	Rear	/	23.26	24.5	0.605	<b>0.80</b>	0.13
2549.5	40185	1RB_50	Rear	/	23.53	24.5	0.821	<b>1.03</b>	0.00
2506	39750	100RB	Rear	/	22.61	23.5	0.512	<b>0.63</b>	0.14
2549.5	40185	1RB_50	Rear	B2	23.53	24.5	0.807	<b>1.01</b>	0.06
<b>Body-Worn - The worst case with PC2</b>									
2506	39750	1RB_50	Rear	<b>28</b>	26.64	27.0	<b>0.979</b>	<b>1.06</b>	0.19

Note: Per **TCB workshop May 2017** Guidance, all SAR tests were performed using power class 3. SAR with power class 2 at the available duty factor was additionally performed for the power class 3 configuration with the highest SAR configuration for each exposure conditions. Please see **ANNEX G** for linearity results.

**Table 13.29: SAR Values (LTE Band 66 - Head)**

Frequency		Test Mode	Test Position	Figure No. / Note	Ambient Temperature: 22.2°C		Liquid Temperature: 21.7°C		
MHz	Ch.				Conducted Power (dBm)	Max. tune-up Power (dBm)	Measured SAR(1g) (W/kg)	Reported SAR(1g) (W/kg)	Power Drift(dB)
1745	132322	1RB_50	Left Cheek	/	23.43	24.0	0.197	<b>0.22</b>	0.01
1745	132322	50RB_25	Left Cheek	/	22.31	23.0	0.149	<b>0.17</b>	0.05
1745	132322	1RB_50	Left Tilt	/	23.43	24.0	0.207	<b>0.24</b>	0.01
1745	132322	50RB_25	Left Tilt	/	22.31	23.0	0.162	<b>0.19</b>	0.05
1745	132322	1RB_50	Right Cheek	<b>29</b>	23.43	24.0	0.174	<b>0.226</b>	0.13
1745	132322	50RB_25	Right Cheek	/	22.31	23.0	0.178	<b>0.21</b>	0.01
1745	132322	1RB_50	Right Tilt	/	23.43	24.0	0.174	<b>0.20</b>	0.05
1745	132322	50RB_25	Right Tilt	/	22.31	23.0	0.139	<b>0.16</b>	0.04
1745	132322	1RB_50	Right Cheek	B2	23.43	24.0	0.213	<b>0.24</b>	0.03

**Table 13.30: SAR Values (LTE Band 66 - Body)**

Frequency		Test Mode	Test Position	Figure No. / Note	Ambient Temperature: 22.2°C		Liquid Temperature: 21.7°C		
MHz	Ch.				Conducted Power (dBm)	Max. tune-up Power (dBm)	Measured SAR(1g) (W/kg)	Reported SAR(1g) (W/kg)	Power Drift(dB)
<b>Hotspot / Body-Worn Test Data (10mm)</b>									
1745	132322	1RB_50	Front	/	23.43	24.0	0.229	<b>0.26</b>	0.04
1745	132322	50RB_25	Front	/	22.31	23.0	0.180	<b>0.21</b>	0.06
1745	132322	1RB_50	Rear	<b>30</b>	23.43	24.0	1.050	<b>1.20</b>	0.04
1745	132322	50RB_25	Rear	/	22.31	23.0	0.893	<b>1.05</b>	0.01
1745	132322	1RB_50	Left	/	23.43	24.0	0.466	<b>0.53</b>	0.03
1745	132322	50RB_25	Left	/	22.31	23.0	0.380	<b>0.45</b>	0.11
1745	132322	1RB_50	Right	/	23.43	24.0	0.132	<b>0.15</b>	0.01
1745	132322	50RB_25	Right	/	22.31	23.0	0.106	<b>0.12</b>	0.03
1745	132322	1RB_50	Bottom	/	23.43	24.0	0.458	<b>0.52</b>	0.07
1745	132322	50RB_25	Bottom	/	22.31	23.0	0.386	<b>0.45</b>	0.16
1770	132572	1RB_0	Rear	/	23.24	24.0	1.030	<b>1.23</b>	0.00
1720	132072	1RB_50	Rear	/	23.28	24.0	1.010	<b>1.19</b>	-0.11
1770	132572	50RB_25	Rear	/	22.18	23.0	0.873	<b>1.05</b>	0.01
1720	132072	50RB_25	Rear	/	22.17	23.0	0.843	<b>1.02</b>	-0.06
1745	132322	100RB	Rear	/	22.40	23.0	0.879	<b>1.01</b>	0.19
1770	132572	1RB_0	Rear	Headset	23.24	24.0	0.987	<b>1.18</b>	0.03
1770	132572	1RB_0	Rear	B2	23.24	24.0	0.993	<b>1.18</b>	0.12

**Note:** SAR for LTE Band 4 is covered by LTE Band 66 due to similar frequency range, same maximum tune-up limit and same channel bandwidth.

**Table 13.31: SAR Values (LTE Band 71 - Head)**

Frequency		Test Mode	Test Position	Figure No. / Note	Ambient Temperature: 22.5°C		Liquid Temperature: 22.0°C		
MHz	Ch.				Conducted Power (dBm)	Max. tune-up Power (dBm)	Measured SAR(1g) (W/kg)	Reported SAR(1g) (W/kg)	Power Drift(dB)
688	133372	1RB_50	Left Cheek	/	23.02	24.0	0.032	<b>0.04</b>	0.01
673	133222	50RB_25	Left Cheek	/	21.89	23.0	0.025	<b>0.03</b>	0.04
688	133372	1RB_50	Left Tilt	/	23.02	24.0	0.015	<b>0.02</b>	0.03
673	133222	50RB_25	Left Tilt	/	21.89	23.0	0.013	<b>0.02</b>	0.07
688	133372	1RB_50	Right Cheek	<b>31</b>	23.02	24.0	<b>0.049</b>	<b>0.06</b>	0.03
673	133222	50RB_25	Right Cheek	/	21.89	23.0	0.001	<b>0.00</b>	0.09
688	133372	1RB_50	Right Tilt	/	23.02	24.0	0.014	<b>0.02</b>	0.02
673	133222	50RB_25	Right Tilt	/	21.89	23.0	0.013	<b>0.02</b>	0.01
688	133372	1RB_50	Right Cheek	B2	23.02	24.0	0.042	<b>0.05</b>	0.04

**Table 13.32: SAR Values (LTE Band 71 - Body)**

Frequency		Test Mode	Test Position	Figure No. / Note	Ambient Temperature: 22.5°C		Liquid Temperature: 22.0°C		
MHz	Ch.				Conducted Power (dBm)	Max. tune-up Power (dBm)	Measured SAR(1g) (W/kg)	Reported SAR(1g) (W/kg)	Power Drift(dB)
<b>Hotspot / Body-Worn Test Data (10mm)</b>									
688	133372	1RB_50	Front	/	23.02	24.0	0.029	<b>0.04</b>	0.04
673	133222	50RB_25	Front	/	21.89	23.0	0.020	<b>0.03</b>	0.14
688	133372	1RB_50	Rear	<b>32</b>	23.02	24.0	<b>0.144</b>	<b>0.18</b>	0.16
673	133222	50RB_25	Rear	/	21.89	23.0	0.105	<b>0.14</b>	0.12
688	133372	1RB_50	Left	/	23.02	24.0	0.047	<b>0.06</b>	0.09
673	133222	50RB_25	Left	/	21.89	23.0	0.031	<b>0.04</b>	0.16
688	133372	1RB_50	Right	/	23.02	24.0	0.043	<b>0.05</b>	0.02
673	133222	50RB_25	Right	/	21.89	23.0	0.029	<b>0.04</b>	0.16
688	133372	1RB_50	Bottom	/	23.02	24.0	0.051	<b>0.06</b>	0.01
673	133222	50RB_25	Bottom	/	21.89	23.0	0.038	<b>0.05</b>	0.03
688	133372	1RB_50	Rear	B2	23.02	24.0	0.132	<b>0.17</b>	0.03

### 13.3. WLAN Evaluation for 2.4G

According to the KDB248227 D01, SAR is measured for 2.4GHz 802.11b DSSS using the initial test position procedure.

**Table 13.33: SAR Values (WLAN 2.4G - Head)**

Frequency		Test Mode	Test Position	Figure No. / Note	Ambient Temperature: 22.3°C		Liquid Temperature: 21.8°C		
MHz	Ch.				Conducted Power (dBm)	Max. tune-up Power (dBm)	Measured SAR(1g) (W/kg)	Reported SAR(1g) (W/kg)	Power Drift(dB)
2462	11	802.11 b	Left Cheek	<b>33</b>	15.79	16.0	<b>0.079</b>	<b>0.08</b>	0.03
2462	11	802.11 b	Left Tilt	/	15.79	16.0	0.028	<b>0.03</b>	-0.15
2462	11	802.11 b	Right Cheek	/	15.79	16.0	0.067	<b>0.07</b>	0.04
2462	11	802.11 b	Right Tilt	/	15.79	16.0	0.026	<b>0.03</b>	-0.14
2462	11	802.11 b	Left Cheek	B2	15.79	16.0	0.069	<b>0.07</b>	0.03

Note1: For all positions/configurations tested using the initial test position and subsequent test positions, when the reported SAR is > 0.8 W/kg, SAR is measured for these test positions/configurations on the subsequent next highest measured output power channel until the reported SAR is ≤ 1.2 W/kg or all required channels are tested.

According to the KDB248227 D01, The reported SAR must be scaled to 100% transmission duty factor to determine compliance at the maximum tune-up tolerance limit.

**Table 13.34: SAR Values (WLAN - Head) – 802.11b (Scaled Reported SAR)**

Frequency		Test Position	Actual duty factor	maximum duty factor	Reported SAR (1g)(W/kg)	Scaled reported SAR (1g)(W/kg)
MHz	Ch					
2462	11	Left Cheek	100%	100%	0.08	<b>0.08</b>

SAR is not required for OFDM because the 802.11b adjusted SAR ≤ 1.2 W/kg.

**Table 13.35: SAR Values (WLAN 2.4G - Body)**

Frequency		Test Mode	Test Position	Figure No. / Note	Conducted Power (dBm)	Max. tune-up Power (dBm)	Measured SAR(1g) (W/kg)	Reported SAR(1g) (W/kg)	Power Drift(dB)
MHz	Ch.								
Ambient Temperature: 22.3°C      Liquid Temperature: 21.8°C									
<b>Test Data (10mm)</b>									
2462	11	802.11 b	Front	/	15.79	16.0	0.066	<b>0.07</b>	0.08
2462	11	802.11 b	Rear	/	15.79	16.0	0.105	<b>0.11</b>	-0.09
2462	11	802.11 b	Left	/	15.79	16.0	0.030	<b>0.03</b>	-0.04
2462	11	802.11 b	Right	<b>34</b>	15.79	16.0	<b>0.137</b>	<b>0.14</b>	0.06
2462	11	802.11 b	Top	/	15.79	16.0	0.033	<b>0.03</b>	-0.09
2462	11	802.11 b	Right	B2	15.79	16.0	0.127	<b>0.13</b>	0.12

Note1: For all positions/configurations tested using the initial test position and subsequent test positions, when the reported SAR is > 0.8 W/kg, SAR is measured for these test positions/configurations on the subsequent next highest measured output power channel until the reported SAR is ≤ 1.2 W/kg or all required channels are tested.

According to the KDB248227 D01, The reported SAR must be scaled to 100% transmission duty factor to determine compliance at the maximum tune-up tolerance limit..

**Table 13.36: SAR Values (WLAN - Body) – 802.11b (Scaled Reported SAR)**

Frequency		Test Position	Actual duty factor	maximum duty factor	Reported SAR (1g)(W/kg)	Scaled reported SAR (1g)(W/kg)
MHz	Ch.					
Ambient Temperature: 22.6°C      Liquid Temperature: 22.0°C						
2462	11	Right	100%	100%	0.14	<b>0.14</b>

SAR is not required for OFDM because the 802.11b adjusted SAR ≤ 1.2 W/kg.

## 14. SAR Measurement Variability

SAR measurement variability must be assessed for each frequency band, which is determined by the SAR probe calibration point and tissue-equivalent medium used for the device measurements. When both head and body tissue-equivalent media are required for SAR measurements in a frequency band, the variability measurement procedures should be applied to the tissue medium with the highest measured SAR, using the highest measured SAR configuration for that tissue-equivalent medium.

The following procedures are applied to determine if repeated measurements are required.

- 1) Repeated measurement is not required when the original highest measured SAR is  $< 0.80$  W/kg; steps 2) through 4) do not apply.
- 2) When the original highest measured SAR is  $\geq 0.80$  W/kg, repeat that measurement once.
- 3) Perform a second repeated measurement only if the ratio of largest to smallest SAR for the original and first repeated measurements is  $> 1.20$  or when the original or repeated measurement is  $\geq 1.45$  W/kg (~ 10% from the 1-g SAR limit).
- 4) Perform a third repeated measurement only if the original, first or second repeated measurement is  $\geq 1.5$  W/kg and the ratio of largest to smallest SAR for the original, first and second repeated measurements is  $> 1.20$ .

**Table 14.1: SAR Measurement Variability for Body – GSM850**

Frequency		Test Position	Original	1 <sup>st</sup> Repeated	Ratio	2 <sup>nd</sup> Repeated
MHz	Ch.		SAR (W/kg)	SAR (W/kg)		SAR (W/kg)
824.2	128	Rear	0.993	0.976	1.02	/

**Table 14.2: SAR Measurement Variability for Body – CDMA BC0**

Frequency		Test Position	Original	1 <sup>st</sup> Repeated	Ratio	2 <sup>nd</sup> Repeated
MHz	Ch.		SAR (W/kg)	SAR (W/kg)		SAR (W/kg)
836.52	384	Rear	0.911	0.884	1.03	/

**Table 14.3: SAR Measurement Variability for Body – CDMA BC10**

Frequency		Test Position	Original	1 <sup>st</sup> Repeated	Ratio	2 <sup>nd</sup> Repeated
MHz	Ch.		SAR (W/kg)	SAR (W/kg)		SAR (W/kg)
817.9	476	Rear	0.958	0.943	1.02	/

**Table 14.4: SAR Measurement Variability for Body – WCDMA Band 2**

Frequency		Test Position	Original	1 <sup>st</sup> Repeated	Ratio	2 <sup>nd</sup> Repeated
MHz	Ch.		SAR (W/kg)	SAR (W/kg)		SAR (W/kg)
1907.6	9538	Rear	0.942	0.918	1.03	/

**Table 14.5: SAR Measurement Variability for Body – WCDMA Band 4**

Frequency		Test Position	Original	1 <sup>st</sup> Repeated	Ratio	2 <sup>nd</sup> Repeated
MHz	Ch.		SAR (W/kg)	SAR (W/kg)		SAR (W/kg)
1732.6	1413	Rear	0.897	0.854	1.05	/

**Table 14.6: SAR Measurement Variability for Body – LTE Band 25**

Frequency		Test Position	Original	1 <sup>st</sup> Repeated	Ratio	2 <sup>nd</sup> Repeated
MHz	Ch.		SAR (W/kg)	SAR (W/kg)		SAR (W/kg)
1905	26590	Rear	0.980	0.966	1.01	/

**Table 14.7: SAR Measurement Variability for Body – LTE Band 41**

Frequency		Test Position	Original	1 <sup>st</sup> Repeated	Ratio	2 <sup>nd</sup> Repeated
MHz	Ch.		SAR (W/kg)	SAR (W/kg)		SAR (W/kg)
2506	39750	Rear	0.979	0.953	1.03	/

**Table 14.8: SAR Measurement Variability for Body – LTE Band 66**

Frequency		Test Position	Original	1 <sup>st</sup> Repeated	Ratio	2 <sup>nd</sup> Repeated
MHz	Ch.		SAR (W/kg)	SAR (W/kg)		SAR (W/kg)
1745	132322	Rear	1.05	0.996	1.05	/



## 15. Measurement Uncertainty

### 15.1. Measurement Uncertainty for Normal SAR Tests (300MHz~3GHz)

No.	Error Description	Type	Uncertainty value	Probably Distribution	Div.	(Ci) 1g	(Ci) 10g	Std. Unc. (1g)	Std. Unc. (10g)	Degree of freedom
<b>Measurement system</b>										
1	Probe calibration	B	12	N	2	1	1	6.0	6.0	∞
2	Isotropy	B	7.4	R	$\sqrt{3}$	1	1	4.3	4.3	∞
3	Boundary effect	B	1.1	R	$\sqrt{3}$	1	1	0.6	0.6	∞
4	Linearity	B	4.7	R	$\sqrt{3}$	1	1	2.7	2.7	∞
5	Detection limit	B	1.0	R	$\sqrt{3}$	1	1	0.6	0.6	∞
6	Readout electronics	B	1.0	N	1	1	1	1.0	1.0	∞
7	Response time	B	0.0	R	$\sqrt{3}$	1	1	0.0	0.0	∞
8	Integration time	B	1.7	R	$\sqrt{3}$	1	1	1.0	1.0	∞
9	RF ambient conditions-noise	B	3.0	R	$\sqrt{3}$	1	1	1.7	1.7	∞
10	RF ambient conditions-reflection	B	3.0	R	$\sqrt{3}$	1	1	1.7	1.7	∞
11	Probe positioned mech. restrictions	B	0.35	R	$\sqrt{3}$	1	1	0.2	0.2	∞
12	Probe positioning with respect to phantom shell	B	2.9	R	$\sqrt{3}$	1	1	1.7	1.7	∞
13	Post-processing	B	1.0	R	$\sqrt{3}$	1	1	0.6	0.6	∞
<b>Test sample related</b>										
14	Test sample positioning	A	3.3	N	1	1	1	3.3	3.3	5
15	Device holder uncertainty	A	3.4	N	1	1	1	3.4	3.4	5
16	Drift of output power	B	5.0	R	$\sqrt{3}$	1	1	2.9	2.9	∞
<b>Phantom and set-up</b>										
17	Phantom uncertainty	B	1.0	R	$\sqrt{3}$	1	1	0.6	0.6	∞
18	Liquid conductivity (target)	B	5.0	R	$\sqrt{3}$	0.64	0.43	1.8	1.2	∞
19	Liquid conductivity (meas.)	A	1.3	N	1	0.64	0.43	0.83	0.56	9
20	Liquid permittivity (target)	B	5.0	R	$\sqrt{3}$	0.6	0.49	1.7	1.4	∞
21	Liquid permittivity (meas.)	A	1.6	N	1	0.6	0.49	0.96	0.78	9
Combined standard uncertainty		$u_c = \sqrt{\sum_{i=1}^{21} c_i^2 u_i^2}$						10.4	10.3	95.5
Expanded uncertainty (Confidence interval of 95 %)		$u_e = 2u_c$						20.8	20.6	

**15.2. Measurement Uncertainty for Normal SAR Tests (3GHz~6GHz)**

No.	Error Description	Type	Uncertainty value	Probably Distribution	Div.	(Ci) 1g	(Ci) 10g	Std. Unc. (1g)	Std. Unc. (10g)	Degree of freedom
<b>Measurement system</b>										
1	Probe calibration	B	12	N	2	1	1	6.0	6.0	∞
2	Isotropy	B	7.4	R	$\sqrt{3}$	1	1	4.3	4.3	∞
3	Boundary effect	B	1.1	R	$\sqrt{3}$	1	1	0.6	0.6	∞
4	Linearity	B	4.7	R	$\sqrt{3}$	1	1	2.7	2.7	∞
5	Detection limit	B	1.0	R	$\sqrt{3}$	1	1	0.6	0.6	∞
6	Readout electronics	B	1.0	N	1	1	1	1.0	1.0	∞
7	Response time	B	0.0	R	$\sqrt{3}$	1	1	0.0	0.0	∞
8	Integration time	B	1.7	R	$\sqrt{3}$	1	1	1.0	1.0	∞
9	RF ambient conditions-noise	B	3.0	R	$\sqrt{3}$	1	1	1.7	1.7	∞
10	RF ambient conditions-reflection	B	3.0	R	$\sqrt{3}$	1	1	1.7	1.7	∞
11	Probe positioned mech. Restrictions	B	0.35	R	$\sqrt{3}$	1	1	0.2	0.2	∞
12	Probe positioning with respect to phantom shell	B	2.9	R	$\sqrt{3}$	1	1	1.7	1.7	∞
13	Post-processing	B	1.0	R	$\sqrt{3}$	1	1	0.6	0.6	∞
14	Fast SAR z-Approximation	B	7.0	R	$\sqrt{3}$	1	1	4.0	4.0	∞
<b>Test sample related</b>										
15	Test sample positioning	A	3.3	N	1	1	1	3.3	3.3	5
16	Device holder uncertainty	A	3.4	N	1	1	1	3.4	3.4	5
17	Drift of output power	B	5.0	R	$\sqrt{3}$	1	1	2.9	2.9	∞
<b>Phantom and set-up</b>										
18	Phantom uncertainty	B	1.0	R	$\sqrt{3}$	1	1	0.6	0.6	∞
19	Liquid conductivity (target)	B	5.0	R	$\sqrt{3}$	0.64	0.43	1.8	1.2	∞
20	Liquid conductivity (meas.)	A	1.3	N	1	0.64	0.43	0.83	0.56	43
21	Liquid permittivity (target)	B	5.0	R	$\sqrt{3}$	0.6	0.49	1.7	1.4	∞
22	Liquid permittivity (meas.)	A	1.6	N	1	0.6	0.49	0.96	0.78	521
Combined standard uncertainty		$u_c = \sqrt{\sum_{i=1}^{22} c_i^2 u_i^2}$						11.1	11.0	257
Expanded uncertainty (Confidence interval of 95 %)		$u_e = 2u_c$						22.2	22.0	

## 16. Main Test Instruments

**Table 16.1: List of Main Instruments for original sample test**

No.	Name	Type	Serial Number	Calibration Date	Valid Period
01	Network analyzer	E5071C	MY46103759	2019-11-15	One year
02	Dielectric probe	85070E	MY44300317	/	/
03	Power meter	E4418B	MY50000366	2019-12-14	One year
04	Power sensor	E9304A	MY50000188		
05	Power meter	NRP	101460	2020-01-15	One year
06	Power sensor	NRP-Z91	100553		
07	Signal Generator	E8257D	MY47461211	2020-01-15	One year
08	Amplifier	VTL5400	0404	/	/
09	E-field Probe	EX3DV4	3633	2020-04-01	One year
10	DAE	DAE4	786	2020-03-03	One year
11	Dipole Validation Kit	D750V3	1163	2019-09-03	Three year
12	Dipole Validation Kit	D835V2	4d057	2018-10-09	Three year
13	Dipole Validation Kit	D1750V2	1152	2019-08-30	Three year
14	Dipole Validation Kit	D1900V2	5d088	2018-10-24	Three year
15	Dipole Validation Kit	D2450V2	873	2018-10-26	Three year
16	Dipole Validation Kit	D2550V2	1058	2018-08-24	Three year
17	Radio Communication Analyzer	MT8820C	6201341853	2020-01-15	One year
18	Radio Communication Analyzer	MT8821C	6201563766	2020-01-15	One year
19	BTS	E5515C	GB46110722	2020-01-15	One year
20	Software	DASY5	52.8.8.1222	/	/

## ANNEX A: Graph Results

### GSM850 Head

Date: 2020-9-20

Electronics: DAE4 Sn786

Medium: Head 835MHz

Medium parameters used (interpolated):  $f = 836.6$  MHz;  $\sigma = 0.915$  S/m;  $\epsilon_r = 40.738$ ;  $\rho = 1000$  kg/m<sup>3</sup>

Ambient Temperature: 22.0°C      Liquid Temperature: 21.5°C

Communication System: UID 0, GSM (0) Frequency: 836.6 MHz Duty Cycle: 1:8.3

Probe: EX3DV4 – SN3633 ConvF (9.59, 9.59, 9.59);

**Right Cheek Middle/Area Scan (51x61x1):** Interpolated grid: dx=1.500 mm, dy=1.500 mm  
Maximum value of SAR (interpolated) = 0.169 W/kg

**Right Cheek Middle/Zoom Scan (5x5x7)/Cube 0:** Measurement grid: dx=8mm, dy=8mm, dz=5mm

Reference Value = 3.037 V/m; Power Drift = 0.08 dB

Peak SAR (extrapolated) = 0.235 W/kg

**SAR(1 g) = 0.166 W/kg; SAR(10 g) = 0.108 W/kg**

Maximum value of SAR (measured) = 0.191 W/kg

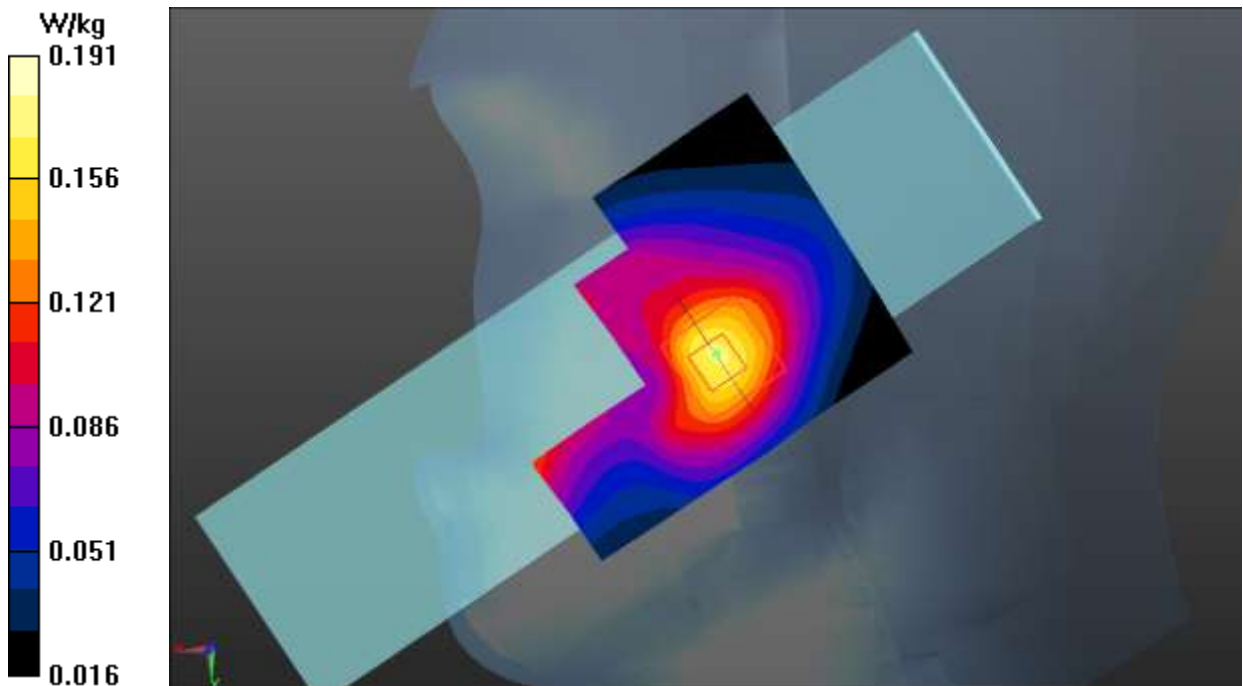

Fig.1 GSM 850

**GSM850 Body**

Date: 2020-9-20

Electronics: DAE4 Sn786

Medium: Head 835MHz

Medium parameters used (interpolated):  $f = 824.2$  MHz;  $\sigma = 0.904$  S/m;  $\epsilon_r = 40.887$ ;  $\rho = 1000$  kg/m<sup>3</sup>

Ambient Temperature: 22.0°C      Liquid Temperature: 21.5°C

Communication System: UID 0, GPRS 4Txslot (0) Frequency: 824.2 MHz Duty Cycle: 1:2

Probe: EX3DV4 – SN3633 ConvF (9.59, 9.59, 9.59);

**Rear Side Low/Area Scan (51x61x1):** Interpolated grid: dx=1.500 mm, dy=1.500 mm

Maximum value of SAR (interpolated) = 1.14 W/kg

**Rear Side Low/Zoom Scan (5x5x7)/Cube 0:** Measurement grid: dx=8mm, dy=8mm, dz=5mm

Reference Value = 24.87 V/m; Power Drift = 0.11 dB

Peak SAR (extrapolated) = 1.51 W/kg

**SAR(1 g) = 0.993 W/kg; SAR(10 g) = 0.658 W/kg**

Maximum value of SAR (measured) = 1.06 W/kg

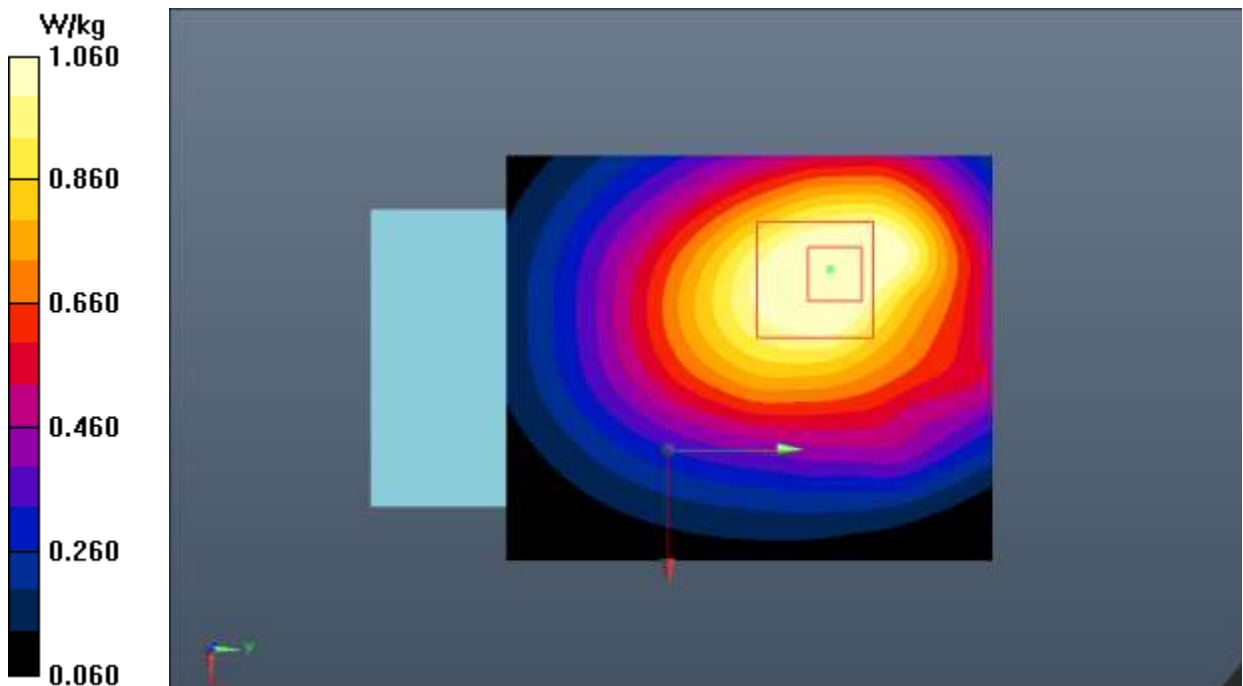

Fig.2 GSM 850

**GSM1900 Head**

Date: 2020-10-12

Electronics: DAE4 Sn786

Medium: Head 1900MHz

Medium parameters used:  $f = 1880$  MHz;  $\sigma = 1.399$  S/m;  $\epsilon_r = 39.071$ ;  $\rho = 1000$  kg/m<sup>3</sup>

Ambient Temperature: 22.0°C      Liquid Temperature: 21.5°C

Communication System: UID 0, GSM (0) Frequency: 1880 MHz Duty Cycle: 1:8.3

Probe: EX3DV4 – SN3633 ConvF (7.76, 7.76, 7.76);

**Left Cheek Middle/Area Scan (51x61x1):** Interpolated grid: dx=1.500 mm, dy=1.500 mm

Maximum value of SAR (interpolated) = 0.229 W/kg

**Left Cheek Middle/Zoom Scan (5x5x7)/Cube 0:** Measurement grid: dx=8mm, dy=8mm, dz=5mm

Reference Value = 3.467 V/m; Power Drift = 0.17 dB

Peak SAR (extrapolated) = 0.278 W/kg

**SAR(1 g) = 0.175 W/kg; SAR(10 g) = 0.081 W/kg**

Maximum value of SAR (measured) = 0.230 W/kg

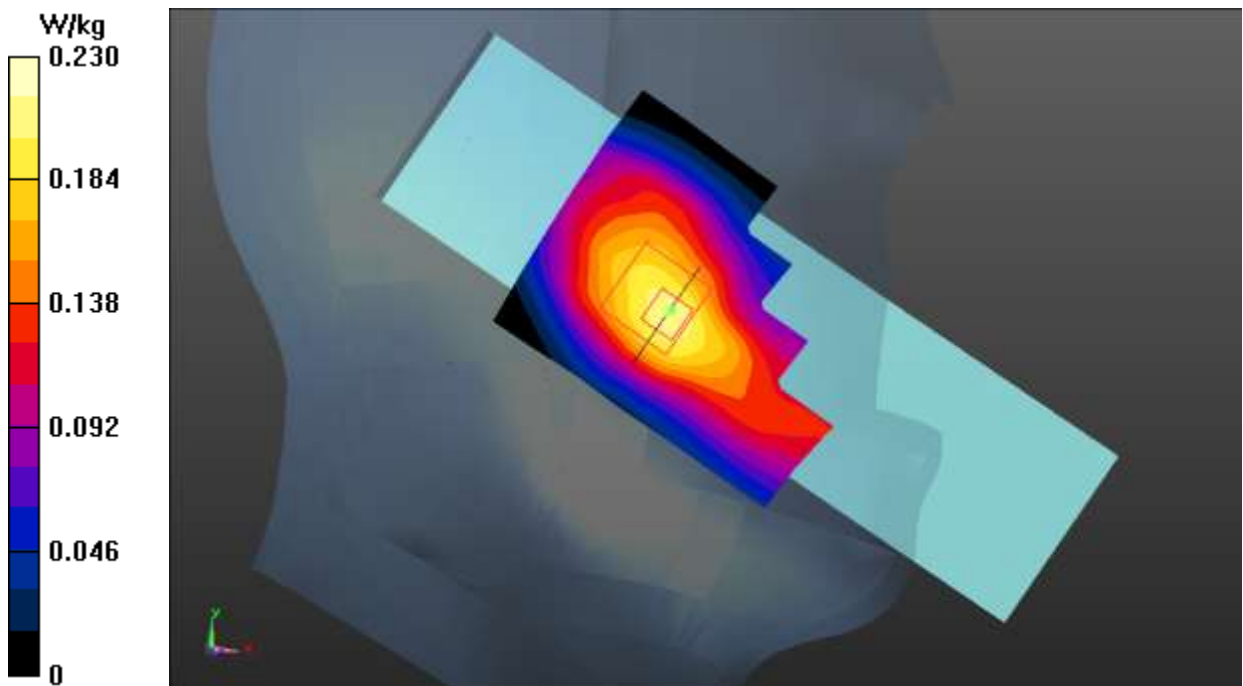
**Fig.3 GSM 1900**

**GSM1900 Body**

Date: 2020-10-12

Electronics: DAE4 Sn786

Medium: Head 1900MHz

Medium parameters used:  $f = 1880$  MHz;  $\sigma = 1.399$  S/m;  $\epsilon_r = 39.071$ ;  $\rho = 1000$  kg/m<sup>3</sup>

Ambient Temperature: 22.0°C      Liquid Temperature: 21.5°C

Communication System: UID 0, GPRS 4Txslot (0) Frequency: 1880 MHz Duty Cycle: 1:2

Probe: EX3DV4 – SN3633 ConvF (7.76, 7.76, 7.76);

**Rear Side Middle/Area Scan (51x61x1):** Interpolated grid: dx=1.500 mm, dy=1.500 mm

Maximum value of SAR (interpolated) = 0.793 W/kg

**Rear Side Middle/Zoom Scan (5x5x7)/Cube 0:** Measurement grid: dx=8mm, dy=8mm, dz=5mm

Reference Value = 7.740 V/m; Power Drift = 0.07 dB

Peak SAR (extrapolated) = 1.13 W/kg

**SAR(1 g) = 0.627 W/kg; SAR(10 g) = 0.338 W/kg**

Maximum value of SAR (measured) = 0.678 W/kg

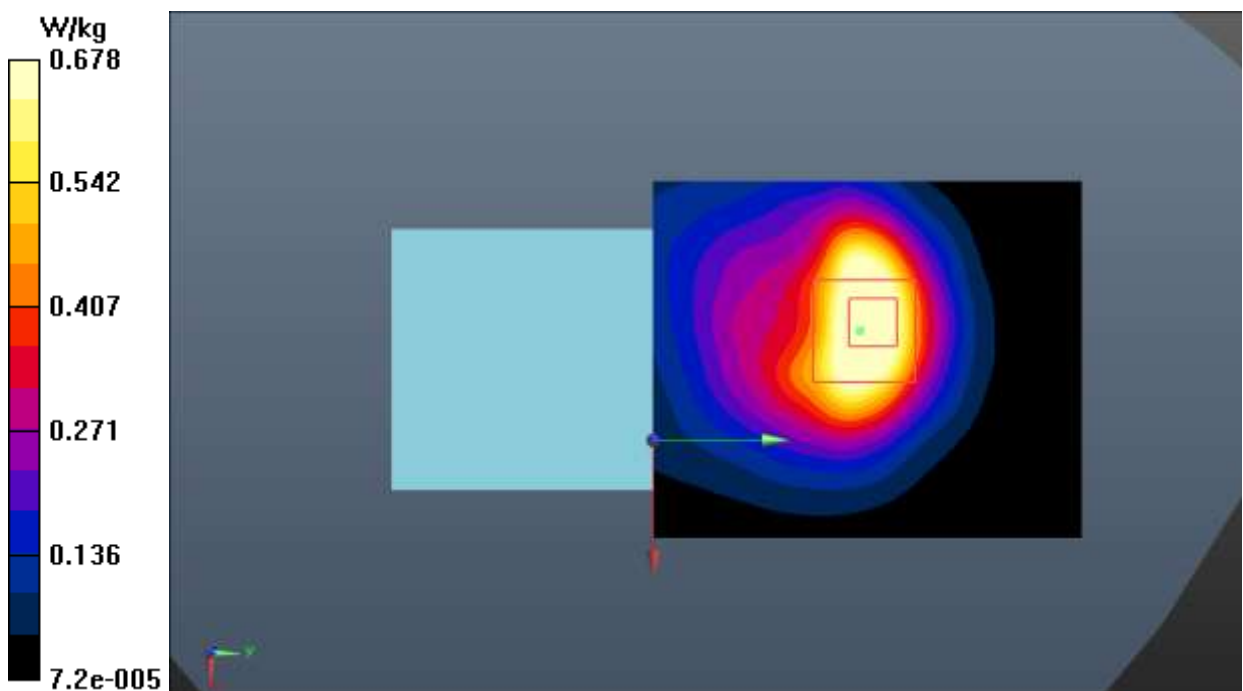

Fig.4 GSM 1900

**CDMA BC0 Head**

Date: 2020-9-20

Electronics: DAE4 Sn786

Medium: Head 835MHz

Medium parameters used (interpolated):  $f = 836.52$  MHz;  $\sigma = 0.915$  S/m;  $\epsilon_r = 40.739$ ;  $\rho = 1000$  kg/m<sup>3</sup>

Ambient Temperature: 22.0°C      Liquid Temperature: 21.5°C

Communication System: UID 0, CDMA (0) Frequency: 836.52 MHz Duty Cycle: 1:1

Probe: EX3DV4 – SN3633 ConvF (9.59, 9.59, 9.59);

**Right Cheek Middle/Area Scan (51x61x1):** Interpolated grid: dx=1.500 mm, dy=1.500 mm

Maximum value of SAR (interpolated) = 0.267 W/kg

**Right Cheek Middle/Zoom Scan (5x5x7)/Cube 0:** Measurement grid: dx=8mm, dy=8mm, dz=5mm

Reference Value = 3.790 V/m; Power Drift = 0.12 dB

Peak SAR (extrapolated) = 0.363 W/kg

**SAR(1 g) = 0.257 W/kg; SAR(10 g) = 0.169 W/kg**

Maximum value of SAR (measured) = 0.297 W/kg

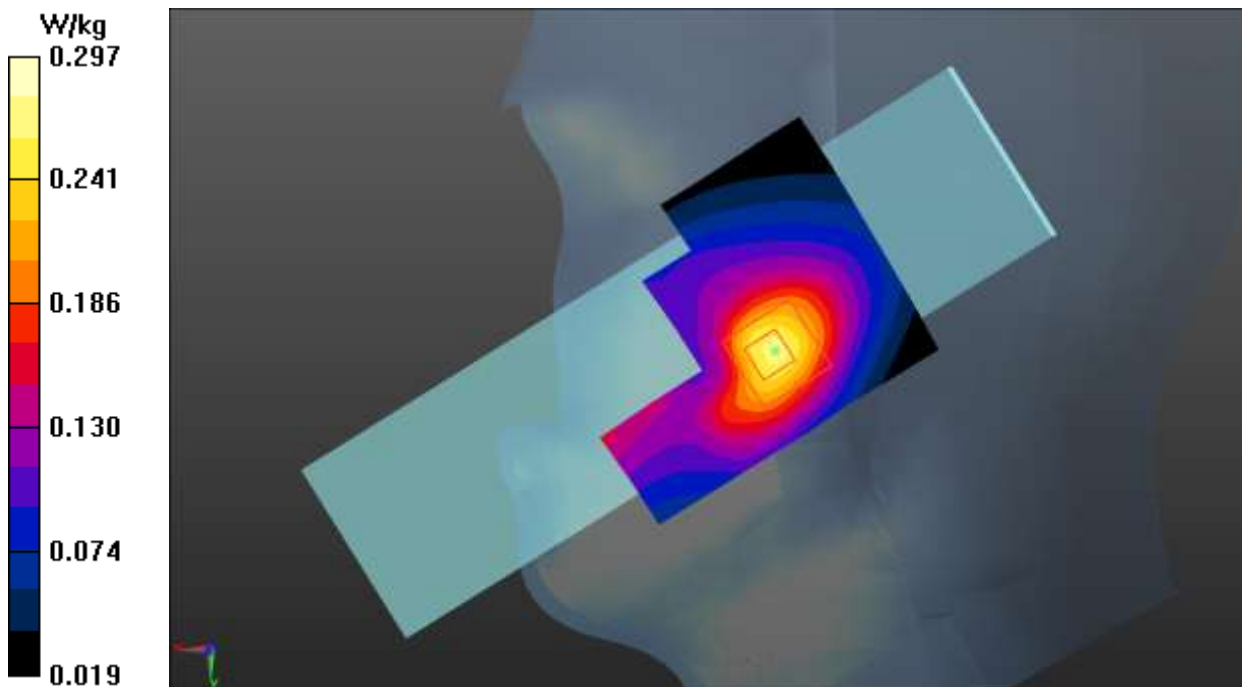

Fig.5 CDMA BC0



**CDMA BC0 Body**

Date: 2020-9-20

Electronics: DAE4 Sn786

Medium: Head 835MHz

Medium parameters used (interpolated):  $f = 836.52$  MHz;  $\sigma = 0.915$  S/m;  $\epsilon_r = 40.739$ ;  $\rho = 1000$  kg/m<sup>3</sup>

Ambient Temperature: 22.0°C      Liquid Temperature: 21.5°C

Communication System: UID 0, CDMA (0) Frequency: 836.52 MHz Duty Cycle: 1:1

Probe: EX3DV4 – SN3633 ConvF (9.59, 9.59, 9.59);

**Rear Side Middle/Area Scan (51x81x1):** Interpolated grid: dx=1.500 mm, dy=1.500 mm

Maximum value of SAR (interpolated) = 1.05 W/kg

**Rear Side Middle/Zoom Scan (5x5x7)/Cube 0:** Measurement grid: dx=8mm, dy=8mm, dz=5mm

Reference Value = 25.66 V/m; Power Drift = 0.09 dB

Peak SAR (extrapolated) = 1.37 W/kg

**SAR(1 g) = 0.911 W/kg; SAR(10 g) = 0.611 W/kg**

Maximum value of SAR (measured) = 1.05 W/kg

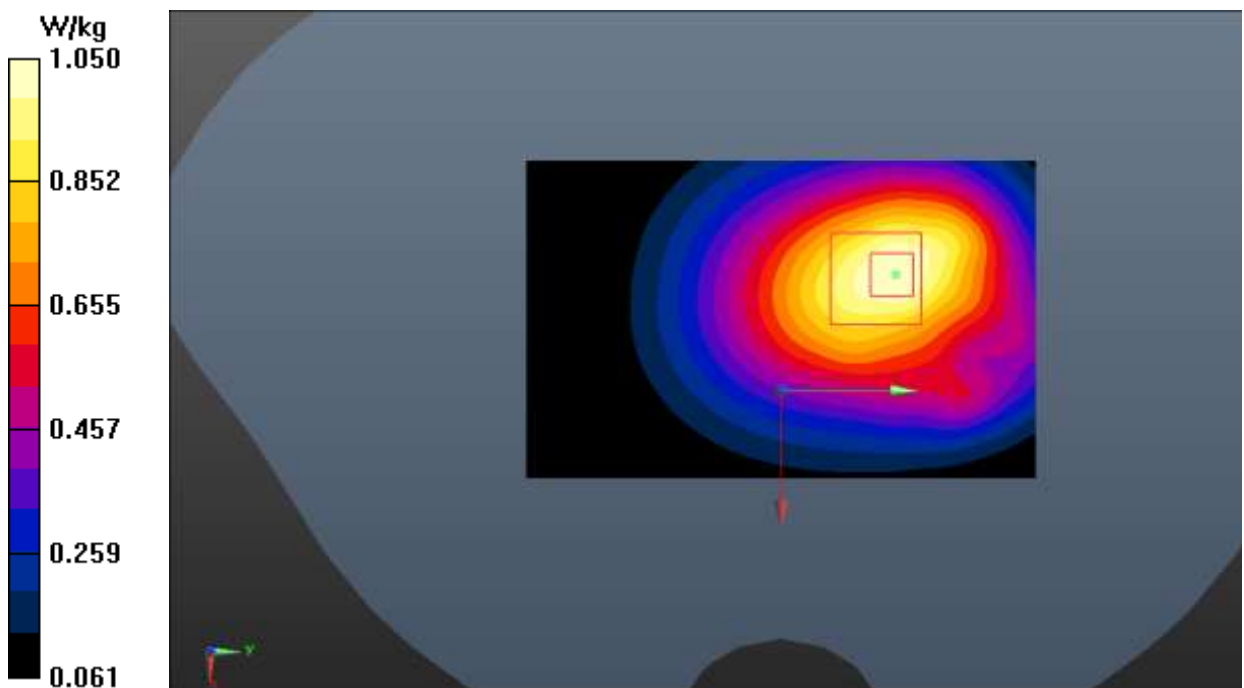
**Fig.6 CDMA BC0**

**CDMA BC1 Head**

Date: 2020-10-12

Electronics: DAE4 Sn786

Medium: Head 1900MHz

Medium parameters used:  $f = 1880$  MHz;  $\sigma = 1.399$  S/m;  $\epsilon_r = 39.071$ ;  $\rho = 1000$  kg/m<sup>3</sup>

Ambient Temperature: 22.0°C      Liquid Temperature: 21.5°C

Communication System: UID 0, CDMA (0) Frequency: 1880 MHz Duty Cycle: 1:1

Probe: EX3DV4 – SN3633 ConvF (7.76, 7.76, 7.76);

**Left Cheek Middle/Area Scan (51x61x1):** Interpolated grid: dx=1.500 mm, dy=1.500 mm

Maximum value of SAR (interpolated) = 0.430 W/kg

**Left Cheek Middle/Zoom Scan (5x5x7)/Cube 0:** Measurement grid: dx=8mm, dy=8mm, dz=5mm

Reference Value = 5.353 V/m; Power Drift = -0.04 dB

Peak SAR (extrapolated) = 0.593 W/kg

**SAR(1 g) = 0.325 W/kg; SAR(10 g) = 0.154 W/kg**

Maximum value of SAR (measured) = 0.464 W/kg

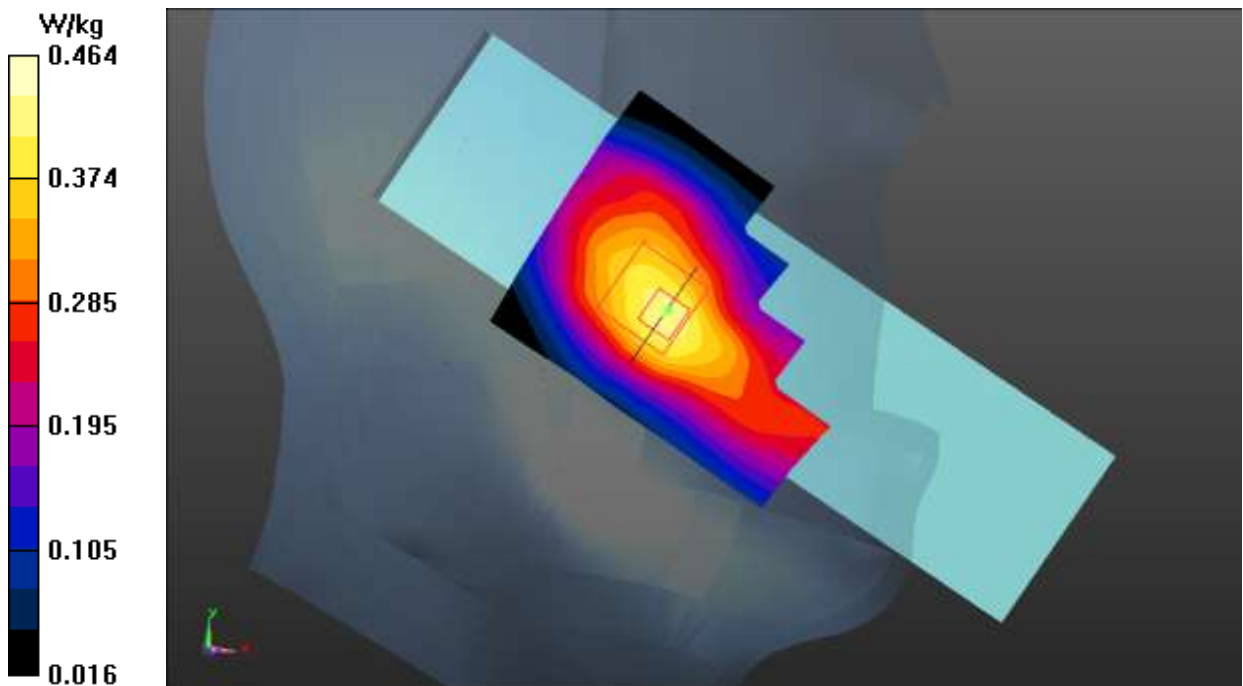

Fig.7 CDMA BC1

**CDMA BC1 Body**

Date: 2020-10-12

Electronics: DAE4 Sn786

Medium: Head 1900MHz

Medium parameters used:  $f = 1880$  MHz;  $\sigma = 1.399$  S/m;  $\epsilon_r = 39.071$ ;  $\rho = 1000$  kg/m<sup>3</sup>

Ambient Temperature: 22.0°C      Liquid Temperature: 21.5°C

Communication System: UID 0, CDMA (0) Frequency: 1880 MHz Duty Cycle: 1:1

Probe: EX3DV4 – SN3633 ConvF (7.76, 7.76, 7.76);

**Rear Side Middle/Area Scan (51x61x1):** Interpolated grid: dx=1.500 mm, dy=1.500 mm

Maximum value of SAR (interpolated) = 0.801 W/kg

**Rear Side Middle /Zoom Scan (5x5x7)/Cube 0:** Measurement grid: dx=8mm, dy=8mm, dz=5mm

Reference Value = 7.378 V/m; Power Drift = 0.03 dB

Peak SAR (extrapolated) = 1.08 W/kg

**SAR(1 g) = 0.636 W/kg; SAR(10 g) = 0.360 W/kg**

Maximum value of SAR (measured) = 0.780 W/kg

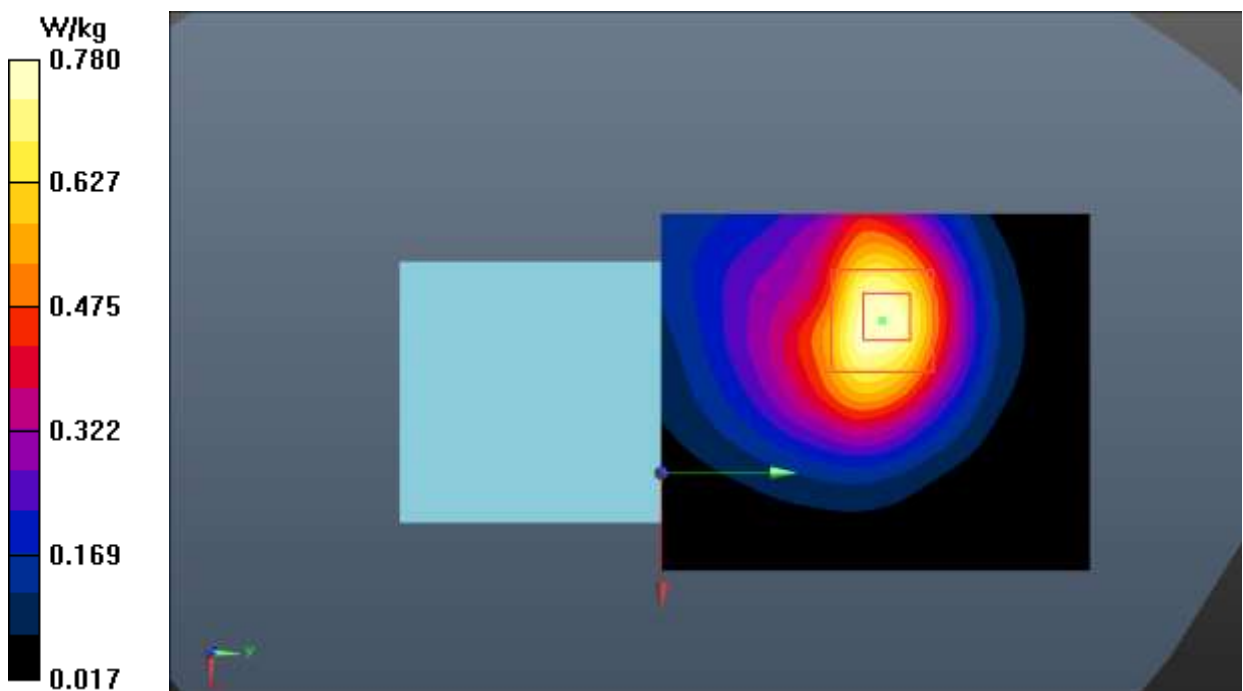

Fig.8 CDMA BC1

**CDMA BC10 Head**

Date: 2020-9-20

Electronics: DAE4 Sn786

Medium: Head 835MHz

Medium parameters used (interpolated):  $f = 820.5$  MHz;  $\sigma = 0.901$  S/m;  $\epsilon_r = 40.931$ ;  $\rho = 1000$  kg/m<sup>3</sup>

Ambient Temperature: 22.0°C      Liquid Temperature: 21.5°C

Communication System: UID 0, CDMA (0) Frequency: 820.5 MHz Duty Cycle: 1:1

Probe: EX3DV4 – SN3633 ConvF (9.59, 9.59, 9.59);

**Right Cheek Middle/Area Scan (51x61x1):** Interpolated grid: dx=1.500 mm, dy=1.500 mm

Maximum value of SAR (interpolated) = 0.262 W/kg

**Right Cheek Middle/Zoom Scan (5x5x7)/Cube 0:** Measurement grid: dx=8mm, dy=8mm, dz=5mm

Reference Value = 3.287 V/m; Power Drift = 0.00 dB

Peak SAR (extrapolated) = 0.351 W/kg

**SAR(1 g) = 0.236 W/kg; SAR(10 g) = 0.150 W/kg**

Maximum value of SAR (measured) = 0.275 W/kg

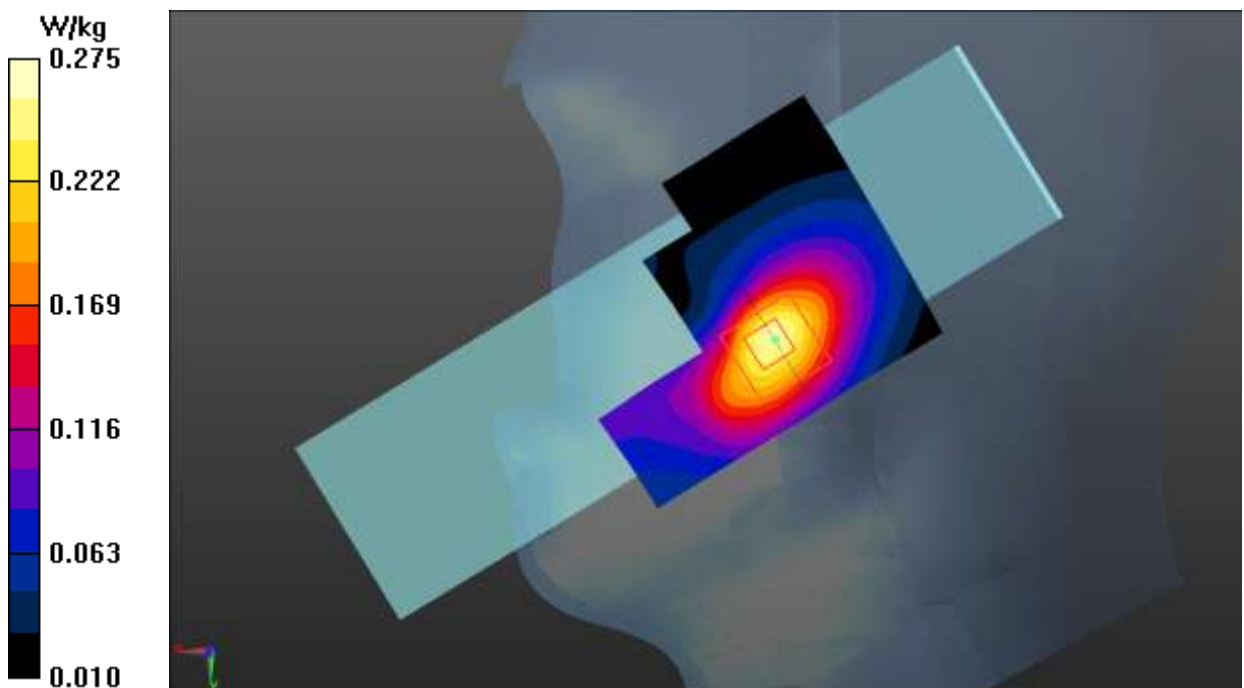
**Fig.9 CDMA BC10**

**CDMA BC10 Body**

Date: 2020-9-20

Electronics: DAE4 Sn786

Medium: Head 835MHz

Medium parameters used:  $f = 818 \text{ MHz}$ ;  $\sigma = 0.898 \text{ S/m}$ ;  $\epsilon_r = 40.962$ ;  $\rho = 1000 \text{ kg/m}^3$ Ambient Temperature:  $22.0^\circ\text{C}$       Liquid Temperature:  $21.5^\circ\text{C}$ 

Communication System: UID 0, CDMA (0) Frequency: 817.9 MHz Duty Cycle: 1:1

Probe: EX3DV4 – SN3633 ConvF (9.59, 9.59, 9.59);

**Rear Side Low/Area Scan (51x81x1):** Interpolated grid:  $dx=1.500 \text{ mm}$ ,  $dy=1.500 \text{ mm}$ 

Maximum value of SAR (interpolated) = 1.14 W/kg

**Rear Side Low/Zoom Scan (5x5x7)/Cube 0:** Measurement grid:  $dx=8\text{mm}$ ,  $dy=8\text{mm}$ ,  $dz=5\text{mm}$ 

Reference Value = 26.81 V/m; Power Drift = 0.03 dB

Peak SAR (extrapolated) = 1.43 W/kg

**SAR(1 g) = 0.958 W/kg; SAR(10 g) = 0.647 W/kg**

Maximum value of SAR (measured) = 1.11 W/kg

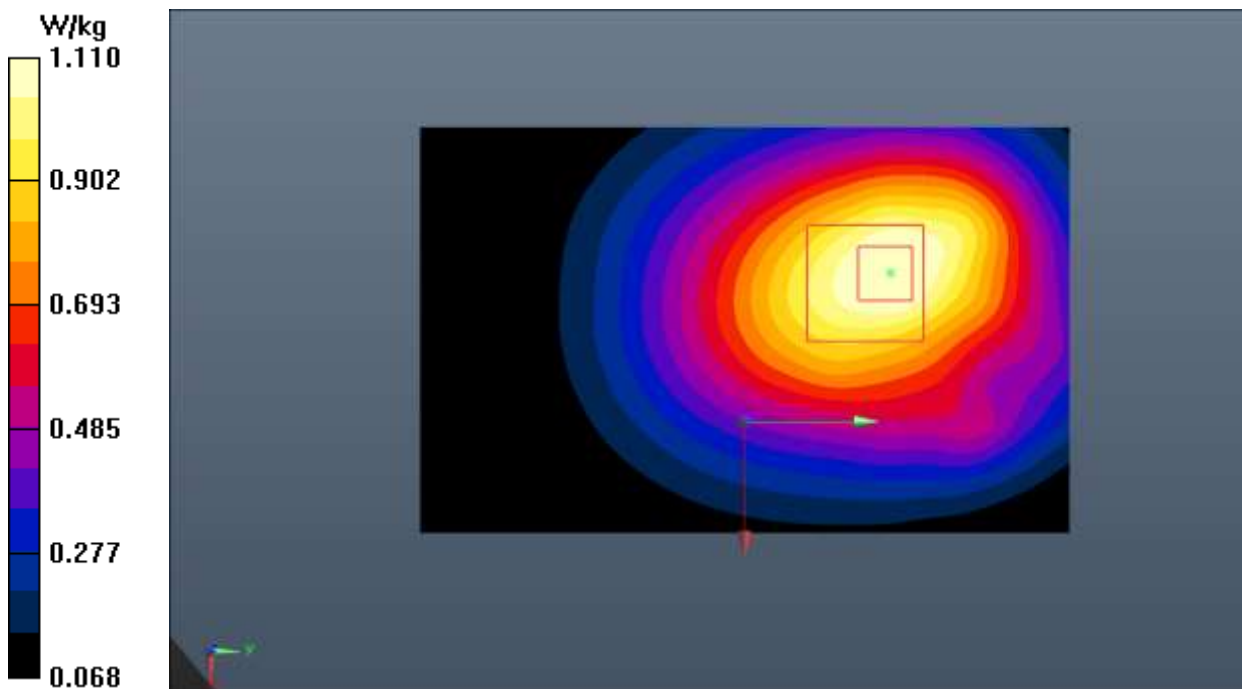

Fig.10 CDMA BC10

**WCDMA Band 2 Head**

Date: 2020-10-12

Electronics: DAE4 Sn786

Medium: Head 1900MHz

Medium parameters used:  $f = 1880$  MHz;  $\sigma = 1.399$  S/m;  $\epsilon_r = 39.071$ ;  $\rho = 1000$  kg/m<sup>3</sup>

Ambient Temperature: 22.0°C      Liquid Temperature: 21.5°C

Communication System: UID 0, WCDMA (0) Frequency: 1880 MHz Duty Cycle: 1:1

Probe: EX3DV4 – SN3633 ConvF (7.76, 7.76, 7.76);

**Left Cheek Middle/Area Scan (61x71x1):** Interpolated grid: dx=1.500 mm, dy=1.500 mm

Maximum value of SAR (interpolated) = 0.172 W/kg

**Left Cheek Middle/Zoom Scan (5x5x7)/Cube 0:** Measurement grid: dx=8mm, dy=8mm, dz=5mm

Reference Value = 2.718 V/m; Power Drift = 0.08 dB

Peak SAR (extrapolated) = 0.219 W/kg

**SAR(1 g) = 0.143 W/kg; SAR(10 g) = 0.091 W/kg**

Maximum value of SAR (measured) = 0.149 W/kg

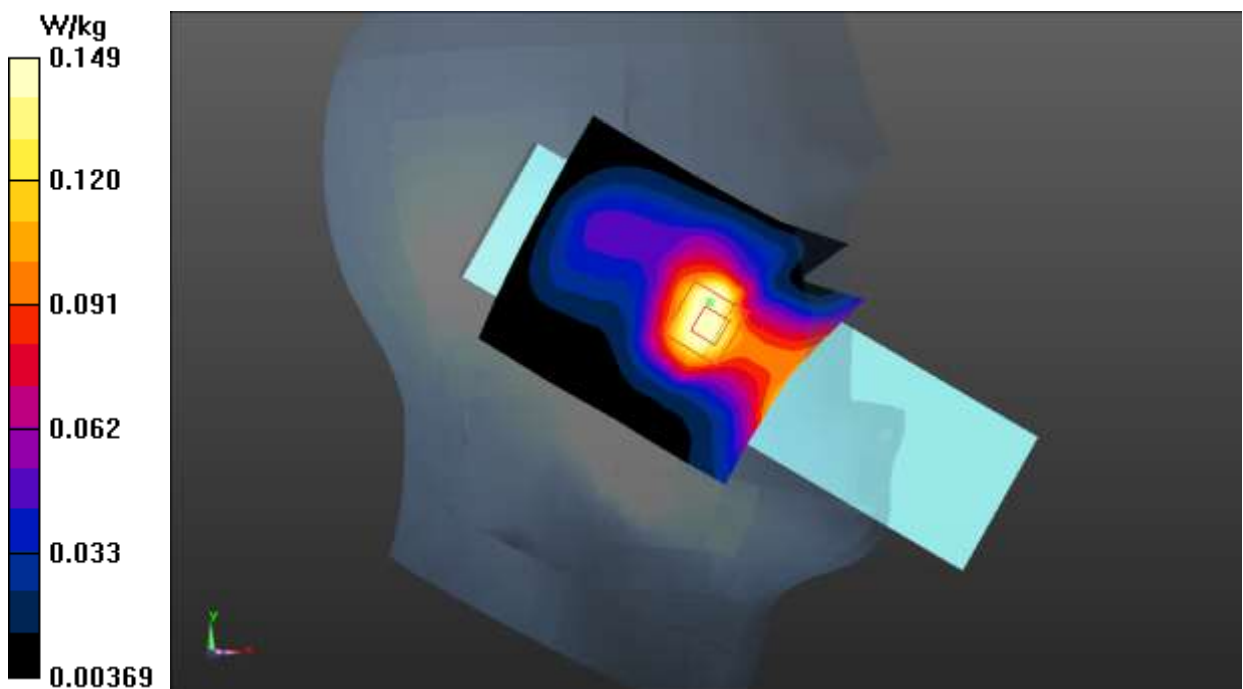

Fig.11 WCDMA Band 2

**WCDMA Band 2 Body**

Date: 2020-10-12

Electronics: DAE4 Sn786

Medium: Head 1900MHz

Medium parameters used:  $f = 1908$  MHz;  $\sigma = 1.424$  S/m;  $\epsilon_r = 38.962$ ;  $\rho = 1000$  kg/m<sup>3</sup>

Ambient Temperature: 22.0°C      Liquid Temperature: 21.5°C

Communication System: UID 0, WCDMA (0) Frequency: 1907.6 MHz Duty Cycle: 1:1

Probe: EX3DV4 – SN3633 ConvF (7.76, 7.76, 7.76);

**Rear Side High/Area Scan (51x61x1):** Interpolated grid: dx=1.500 mm, dy=1.500 mm

Maximum value of SAR (interpolated) = 1.37 W/kg

**Rear Side High/Zoom Scan (5x5x7)/Cube 0:** Measurement grid: dx=8mm, dy=8mm, dz=5mm

Reference Value = 8.181 V/m; Power Drift = 0.06 dB

Peak SAR (extrapolated) = 1.64 W/kg

**SAR(1 g) = 0.942 W/kg; SAR(10 g) = 0.511 W/kg**

Maximum value of SAR (measured) = 1.31 W/kg

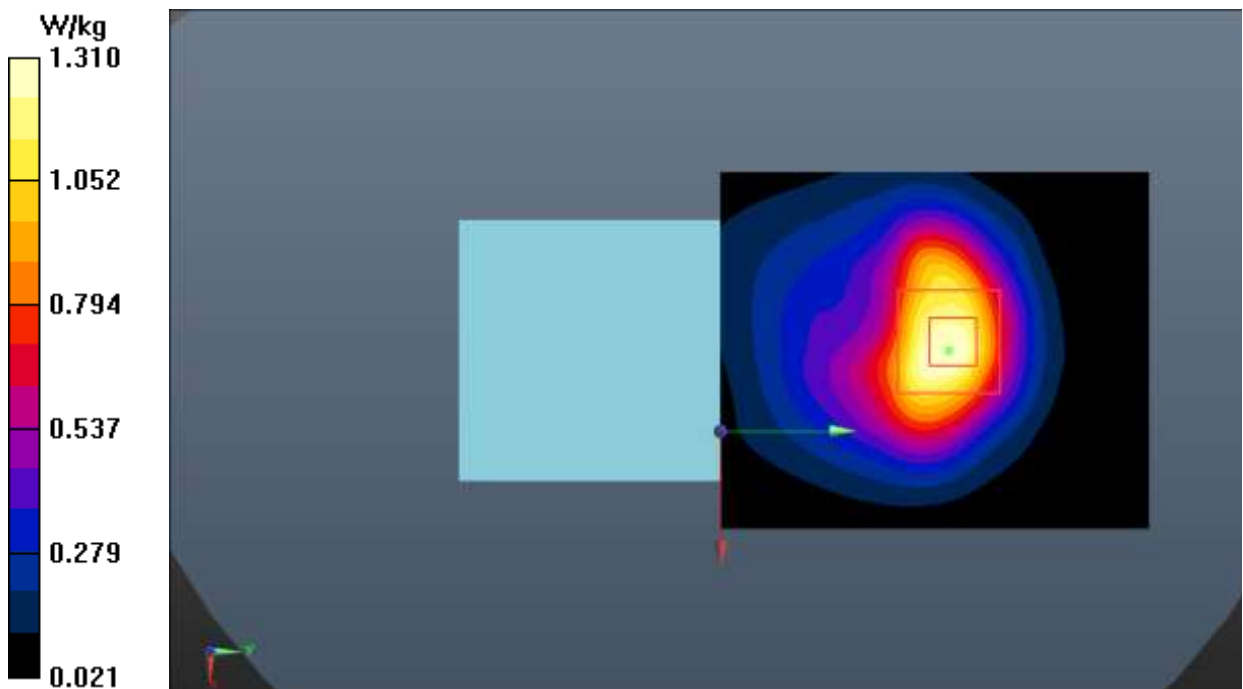

Fig.12 WCDMA Band 2

**WCDMA Band 4 Head**

Date: 2020-10-13

Electronics: DAE4 Sn786

Medium: Head 1750MHz

Medium parameters used:  $f = 1733 \text{ MHz}$ ;  $\sigma = 1.37 \text{ S/m}$ ;  $\epsilon_r = 39.65$ ;  $\rho = 1000 \text{ kg/m}^3$ Ambient Temperature:  $22.0^\circ\text{C}$       Liquid Temperature:  $21.5^\circ\text{C}$ Communication System: UID 0, WCDMA (0) Frequency:  $1732.6 \text{ MHz}$  Duty Cycle: 1:1

Probe: EX3DV4 – SN3633 ConvF (8.09, 8.09, 8.09);

**Left Tilt Middle/Area Scan (51x61x1):** Interpolated grid:  $dx=1.500 \text{ mm}$ ,  $dy=1.500 \text{ mm}$ Maximum value of SAR (interpolated) =  $0.305 \text{ W/kg}$ **Left Tilt Middle/Zoom Scan (5x5x7)/Cube 0:** Measurement grid:  $dx=8\text{mm}$ ,  $dy=8\text{mm}$ ,  $dz=5\text{mm}$ Reference Value =  $11.44 \text{ V/m}$ ; Power Drift =  $0.12 \text{ dB}$ Peak SAR (extrapolated) =  $0.381 \text{ W/kg}$ **SAR(1 g) =  $0.272 \text{ W/kg}$ ; SAR(10 g) =  $0.179 \text{ W/kg}$** Maximum value of SAR (measured) =  $0.304 \text{ W/kg}$ 

Fig.13 WCDMA Band 4



**WCDMA Band 4 Body**

Date: 2020-10-13

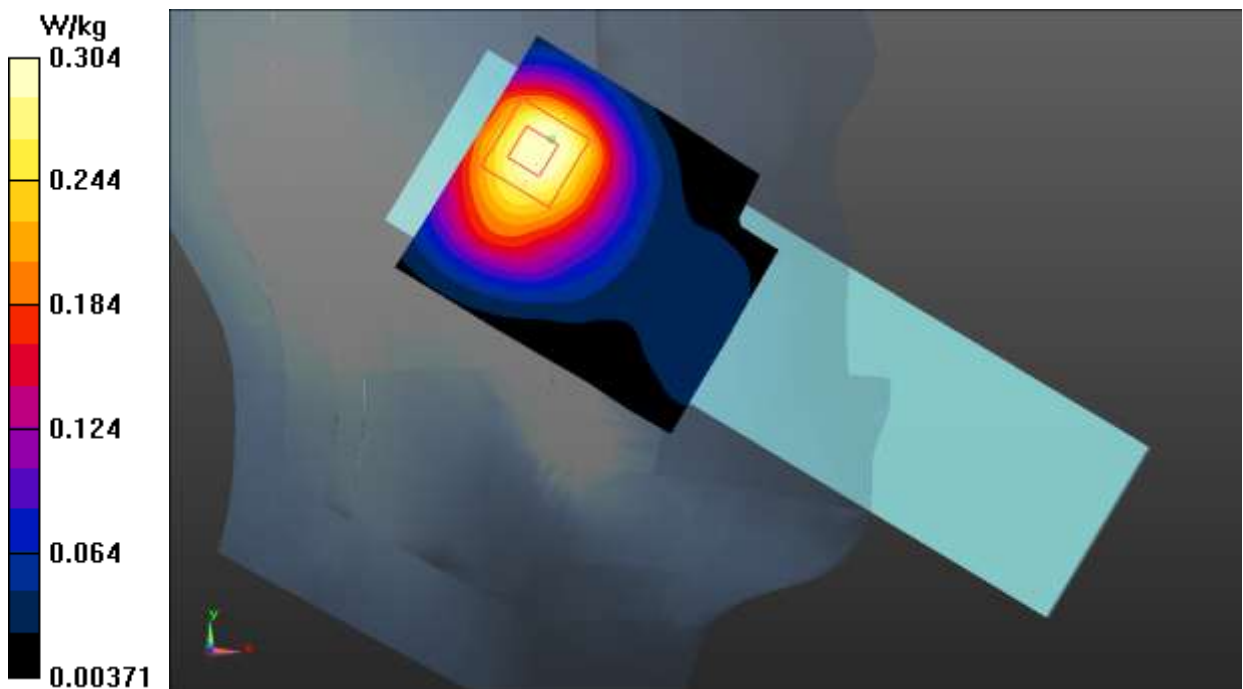
Electronics: DAE4 Sn786

Medium: Head 1750MHz

Medium parameters used:  $f = 1733$  MHz;  $\sigma = 1.37$  S/m;  $\epsilon_r = 39.65$ ;  $\rho = 1000$  kg/m<sup>3</sup>

Ambient Temperature: 22.0°C      Liquid Temperature: 21.5°C

Communication System: UID 0, WCDMA (0) Frequency: 1732.6 MHz Duty Cycle: 1:1

Probe: EX3DV4 – SN3633 ConvF (8.09, 8.09, 8.09);

**Rear Side Middle /Area Scan (51x61x1):** Interpolated grid: dx=1.500 mm, dy=1.500 mm

Maximum value of SAR (interpolated) = 1.09 W/kg

**Rear Side Middle/Zoom Scan (5x5x7)/Cube 0:** Measurement grid: dx=8mm, dy=8mm, dz=5mm

Reference Value = 9.869 V/m; Power Drift = -0.08 dB

Peak SAR (extrapolated) = 1.45 W/kg

**SAR(1 g) = 0.897 W/kg; SAR(10 g) = 0.523 W/kg**

Maximum value of SAR (measured) = 1.03 W/kg

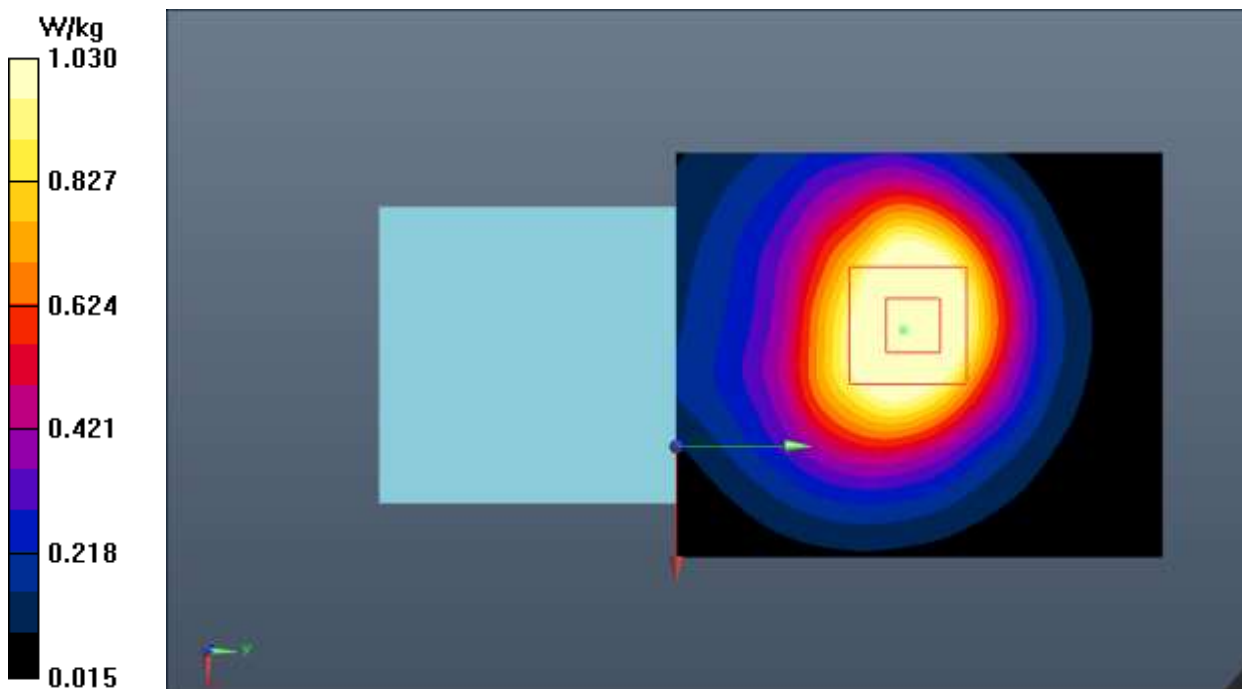

Fig.14 WCDMA Band 4

**WCDMA Band 5 Head**

Date: 2020-9-20

Electronics: DAE4 Sn786

Medium: Head 835MHz

Medium parameters used (interpolated):  $f = 836.4$  MHz;  $\sigma = 0.915$  S/m;  $\epsilon_r = 40.74$ ;  $\rho = 1000$  kg/m<sup>3</sup>

Ambient Temperature: 22.0°C      Liquid Temperature: 21.5°C

Communication System: UID 0, WCDMA (0) Frequency: 836.4 MHz Duty Cycle: 1:1

Probe: EX3DV4 – SN3633 ConvF (9.59, 9.59, 9.59);

**Right Cheek Middle/Area Scan (61x61x1):** Interpolated grid: dx=1.500 mm, dy=1.500 mm

Maximum value of SAR (interpolated) = 0.485 W/kg

**Right Cheek Middle/Zoom Scan (5x5x7)/Cube 0:** Measurement grid: dx=8mm, dy=8mm, dz=5mm

Reference Value = 3.312 V/m; Power Drift = 0.09 dB

Peak SAR (extrapolated) = 0.635 W/kg

**SAR(1 g) = 0.275 W/kg; SAR(10 g) = 0.186 W/kg**

Maximum value of SAR (measured) = 0.451 W/kg

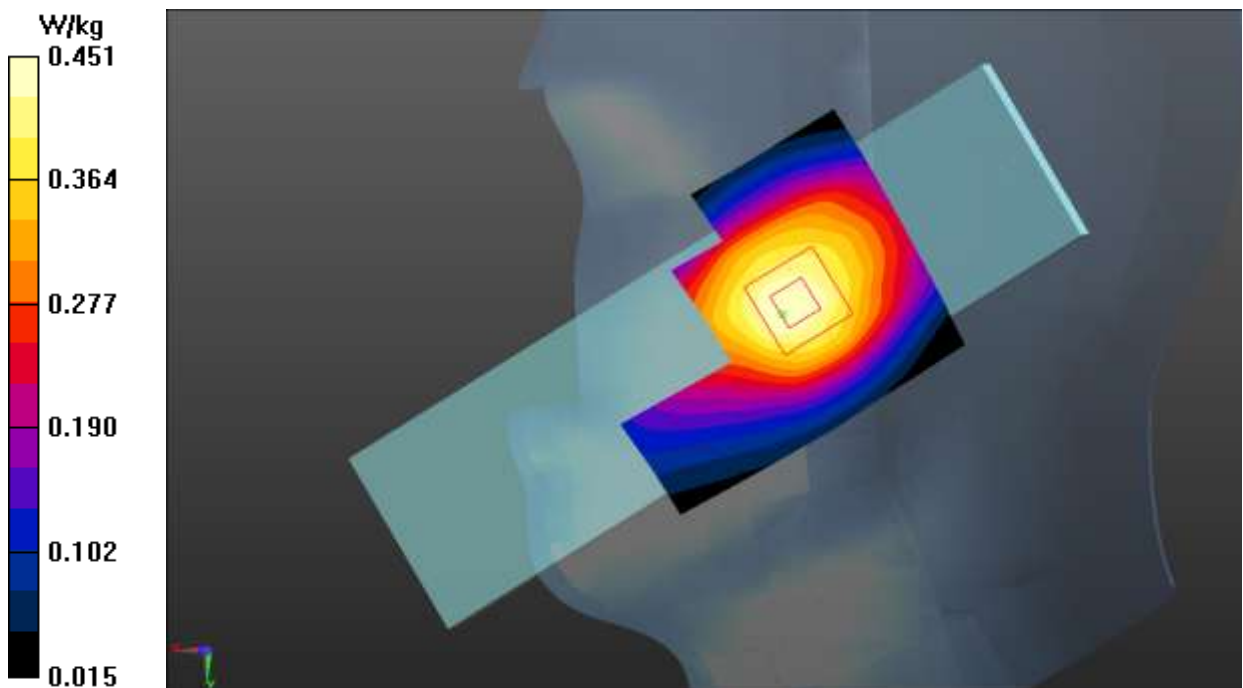
**Fig.15 WCDMA Band 5**

**WCDMA Band 5 Body**

Date: 2020-9-20

Electronics: DAE4 Sn786

Medium: Head 835MHz

Medium parameters used (interpolated):  $f = 836.4$  MHz;  $\sigma = 0.915$  S/m;  $\epsilon_r = 40.74$ ;  $\rho = 1000$  kg/m<sup>3</sup>

Ambient Temperature: 22.0°C      Liquid Temperature: 21.5°C

Communication System: UID 0, WCDMA (0) Frequency: 836.4 MHz Duty Cycle: 1:1

Probe: EX3DV4 – SN3633 ConvF (9.59, 9.59, 9.59);

**Rear Side Middle/Area Scan (51x91x1):** Interpolated grid: dx=1.500 mm, dy=1.500 mm

Maximum value of SAR (interpolated) = 0.563 W/kg

**Rear Side Middle/Zoom Scan (5x5x7)/Cube 0:** Measurement grid: dx=8mm, dy=8mm, dz=5mm

Reference Value = 19.35 V/m; Power Drift = 0.00 dB

Peak SAR (extrapolated) = 0.676 W/kg

**SAR(1 g) = 0.448 W/kg; SAR(10 g) = 0.298 W/kg**

Maximum value of SAR (measured) = 0.560 W/kg

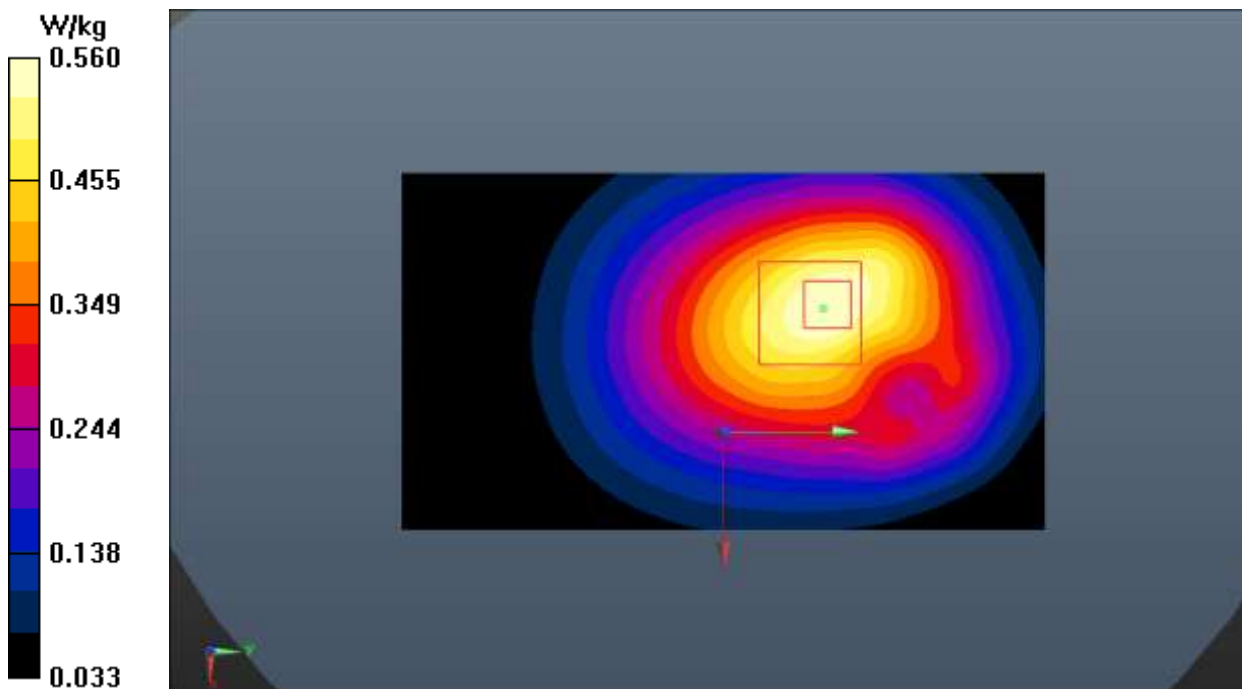

Fig.16 WCDMA Band 5

**LTE Band 5 Head**

Date: 2020-9-20

Electronics: DAE4 Sn786

Medium: Head 835MHz

Medium parameters used (interpolated):  $f = 836.5$  MHz;  $\sigma = 0.915$  S/m;  $\epsilon_r = 40.739$ ;  $\rho = 1000$  kg/m<sup>3</sup>

Ambient Temperature: 22.0°C      Liquid Temperature: 21.5°C

Communication System: UID 0, LTE\_FDD (0) Frequency: 836.5 MHz Duty Cycle: 1:1

Probe: EX3DV4 – SN3633 ConvF (9.59, 9.59, 9.59);

**Right Cheek Middle 1RB\_24/Area Scan (51x61x1):** Interpolated grid: dx=1.500 mm, dy=1.500 mm

Maximum value of SAR (interpolated) = 0.234 W/kg

**Right Cheek Middle 1RB\_24/Zoom Scan (5x5x7)/Cube 0:** Measurement grid: dx=8mm, dy=8mm, dz=5mm

Reference Value = 3.578 V/m; Power Drift = 0.09 dB

Peak SAR (extrapolated) = 0.316 W/kg

**SAR(1 g) = 0.209 W/kg; SAR(10 g) = 0.136 W/kg**

Maximum value of SAR (measured) = 0.244 W/kg

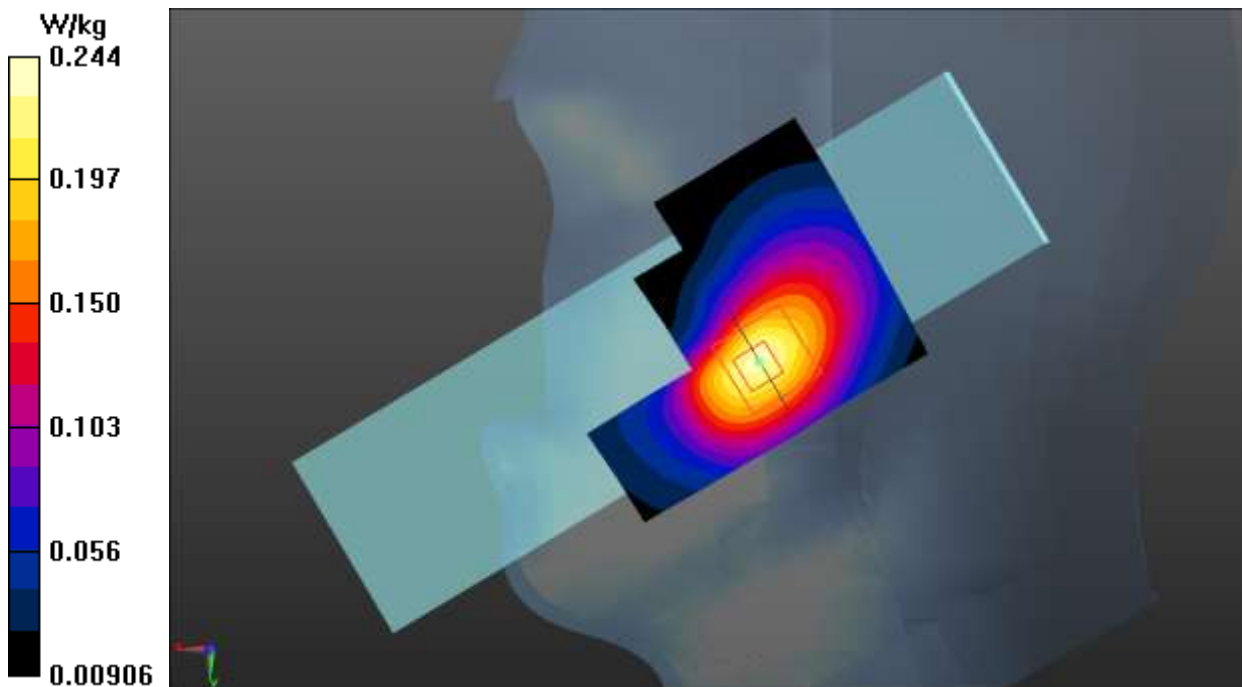

Fig.17 LTE Band 5

**LTE Band 5 Body**

Date: 2020-9-20

Electronics: DAE4 Sn786

Medium: Head 835MHz

Medium parameters used (interpolated):  $f = 836.5$  MHz;  $\sigma = 0.915$  S/m;  $\epsilon_r = 40.739$ ;  $\rho = 1000$  kg/m<sup>3</sup>

Ambient Temperature: 22.0°C      Liquid Temperature: 21.5°C

Communication System: UID 0, LTE\_FDD (0) Frequency: 836.5 MHz Duty Cycle: 1:1

Probe: EX3DV4 – SN3633 ConvF (9.59, 9.59, 9.59);

**Rear Side Middle 1RB\_24/Area Scan (51x91x1):** Interpolated grid: dx=1.500 mm, dy=1.500 mm

Maximum value of SAR (interpolated) = 0.678 W/kg

**Rear Side Middle 1RB\_24/Zoom Scan (5x5x7)/Cube 0:** Measurement grid: dx=8mm, dy=8mm, dz=5mm

Reference Value = 21.72 V/m; Power Drift = 0.06 dB

Peak SAR (extrapolated) = 0.806 W/kg

**SAR(1 g) = 0.538 W/kg; SAR(10 g) = 0.362 W/kg**

Maximum value of SAR (measured) = 0.675 W/kg

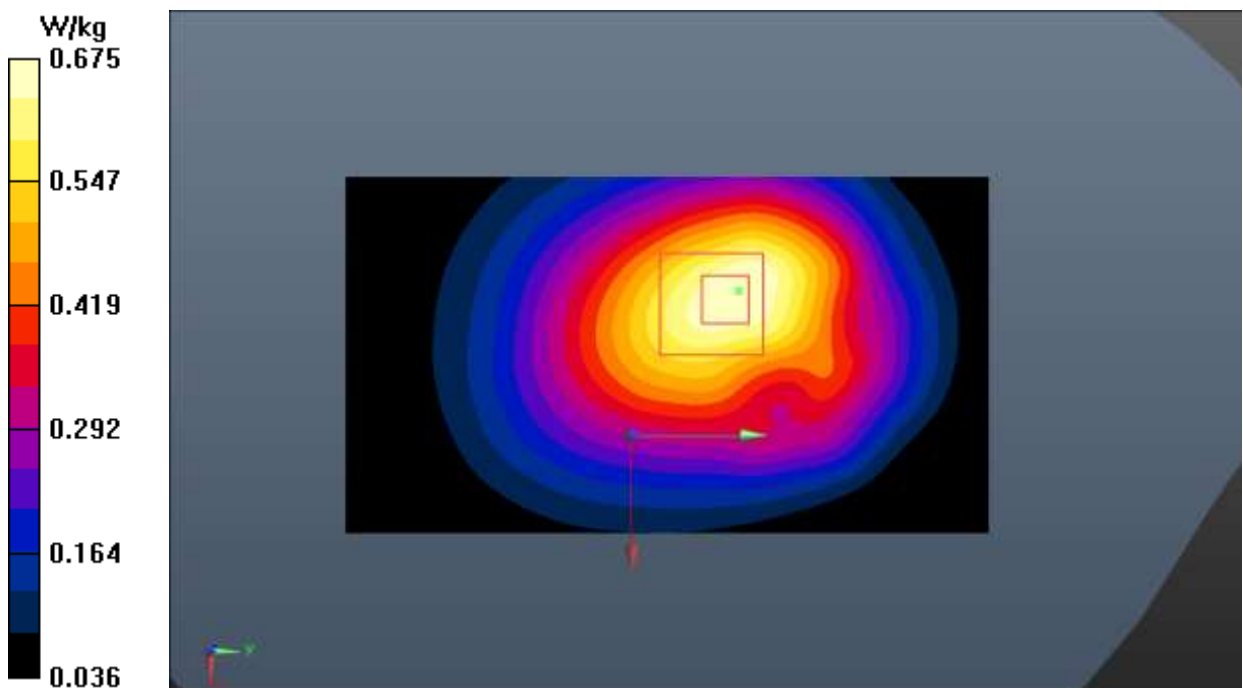

Fig.18 LTE Band 5

**LTE Band 12 Head**

Date: 2020-9-18

Electronics: DAE4 Sn786

Medium: Head 750MHz

Medium parameters used:  $f = 708 \text{ MHz}$ ;  $\sigma = 0.874 \text{ S/m}$ ;  $\epsilon_r = 41.756$ ;  $\rho = 1000 \text{ kg/m}^3$ Ambient Temperature:  $22.0^\circ\text{C}$       Liquid Temperature:  $21.5^\circ\text{C}$ 

Communication System: UID 0, LTE\_FDD (0) Frequency: 707.5 MHz Duty Cycle: 1:1

Probe: EX3DV4 – SN3633 ConvF (9.59, 9.59, 9.59);

**Left Cheek Middle 1RB\_24/Area Scan (51x61x1):** Interpolated grid:  $dx=1.500 \text{ mm}$ ,  $dy=1.500 \text{ mm}$ Maximum value of SAR (interpolated) =  $0.228 \text{ W/kg}$ **Left Cheek Middle 1RB\_24/Zoom Scan (5x5x7)/Cube 0:** Measurement grid:  $dx=8\text{mm}$ ,  $dy=8\text{mm}$ ,  $dz=5\text{mm}$ Reference Value =  $4.797 \text{ V/m}$ ; Power Drift =  $0.15 \text{ dB}$ Peak SAR (extrapolated) =  $0.319 \text{ W/kg}$ **SAR(1 g) =  $0.217 \text{ W/kg}$ ; SAR(10 g) =  $0.151 \text{ W/kg}$** Maximum value of SAR (measured) =  $0.248 \text{ W/kg}$ 

Fig.19 LTE Band 12

**LTE Band 12 Body**

Date: 2020-9-18

Electronics: DAE4 Sn786

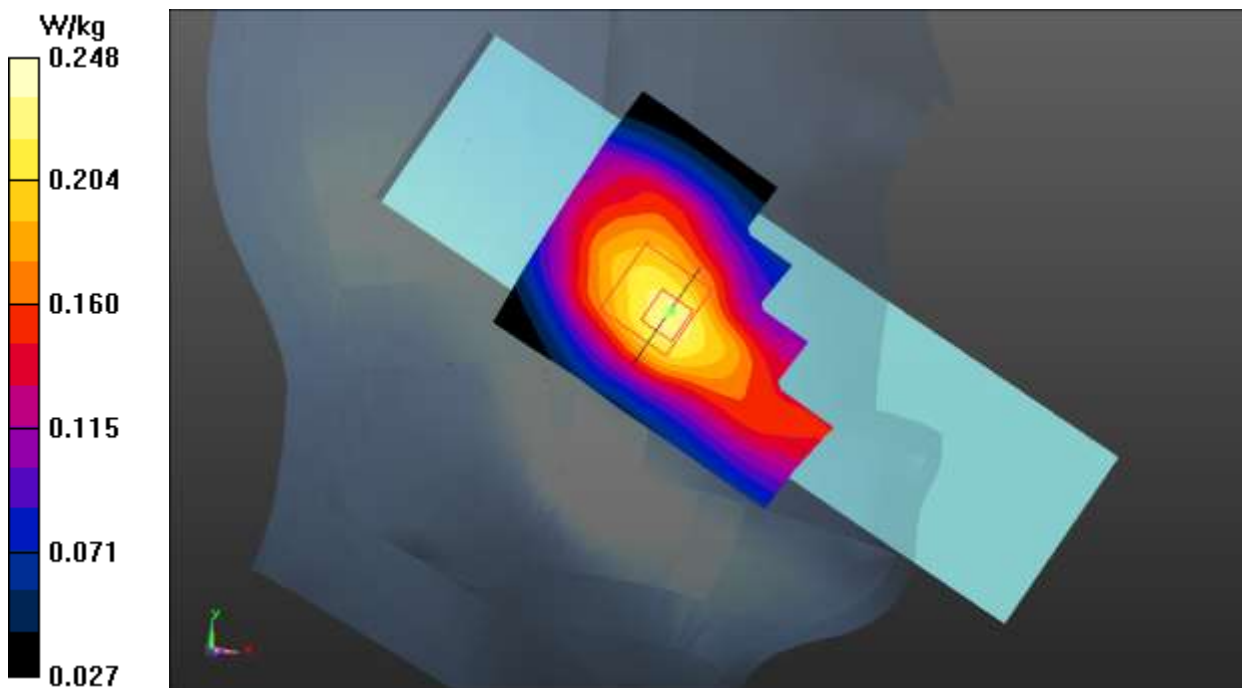
Medium: Head 750MHz

Medium parameters used:  $f = 708 \text{ MHz}$ ;  $\sigma = 0.874 \text{ S/m}$ ;  $\epsilon_r = 41.756$ ;  $\rho = 1000 \text{ kg/m}^3$ Ambient Temperature:  $22.0^\circ\text{C}$       Liquid Temperature:  $21.5^\circ\text{C}$ 

Communication System: UID 0, LTE\_FDD (0) Frequency: 707.5 MHz Duty Cycle: 1:1

Probe: EX3DV4 – SN3633 ConvF (9.59, 9.59, 9.59);

**Rear Side Middle 1RB\_24/Area Scan (51x91x1):** Interpolated grid:  $dx=1.500 \text{ mm}$ ,  $dy=1.500 \text{ mm}$ 

Maximum value of SAR (interpolated) = 0.403 W/kg

**Rear Side Middle 1RB\_24/Zoom Scan (5x5x7)/Cube 0:** Measurement grid:  $dx=8\text{mm}$ ,  $dy=8\text{mm}$ ,  $dz=5\text{mm}$ 

Reference Value = 16.74 V/m; Power Drift = 0.03 dB

Peak SAR (extrapolated) = 0.471 W/kg

**SAR(1 g) = 0.322 W/kg; SAR(10 g) = 0.219 W/kg**

Maximum value of SAR (measured) = 0.398 W/kg

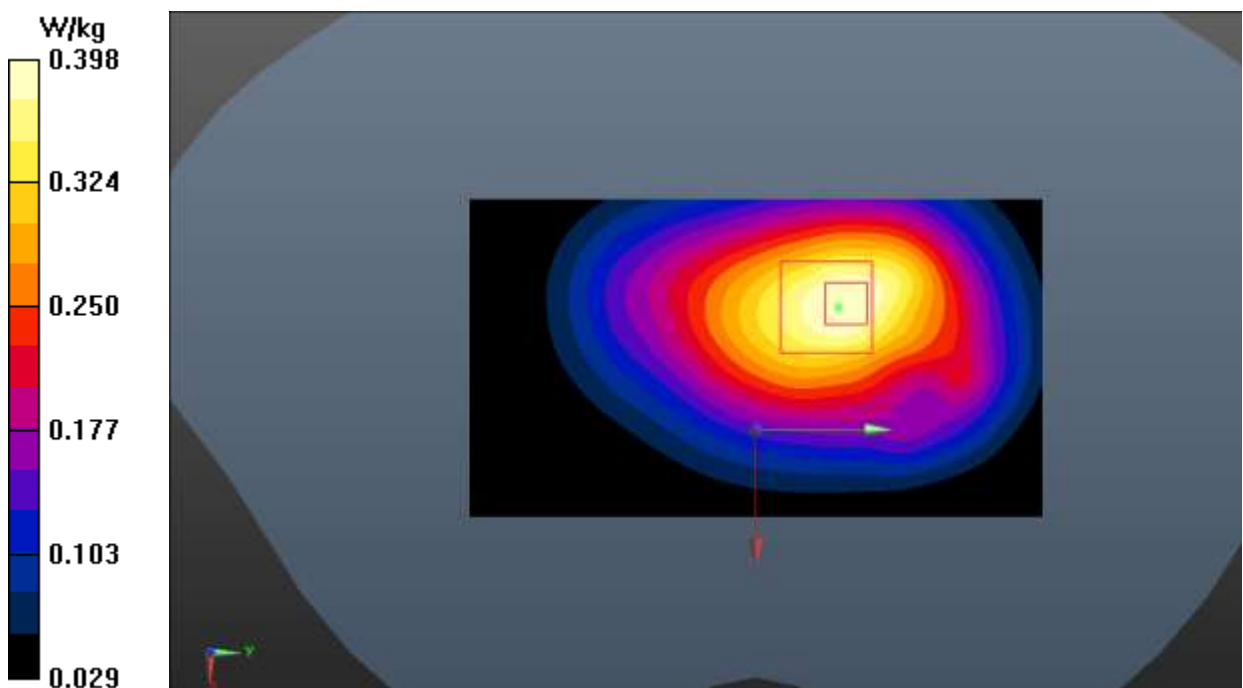

Fig.20 LTE Band 12

**LTE Band 13 Head**

Date: 2020-9-18

Electronics: DAE4 Sn786

Medium: Head 750MHz

Medium parameters used:  $f = 782 \text{ MHz}$ ;  $\sigma = 0.921 \text{ S/m}$ ;  $\epsilon_r = 40.868$ ;  $\rho = 1000 \text{ kg/m}^3$ Ambient Temperature:  $22.0^\circ\text{C}$       Liquid Temperature:  $21.5^\circ\text{C}$ 

Communication System: UID 0, LTE\_FDD (0) Frequency: 782 MHz Duty Cycle: 1:1

Probe: EX3DV4 – SN3633 ConvF (9.59, 9.59, 9.59);

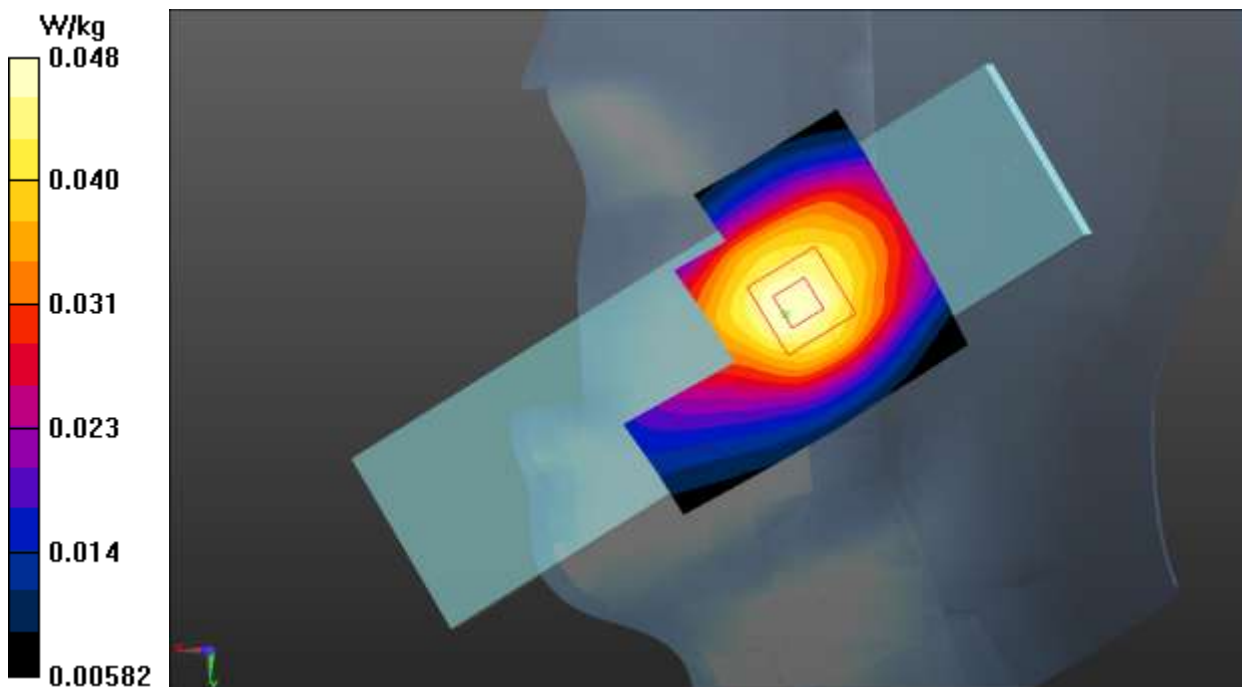
**Right Cheek Middle 1RB\_49/Area Scan (51x61x1):** Interpolated grid:  $dx=1.500 \text{ mm}$ ,  $dy=1.500 \text{ mm}$ Maximum value of SAR (interpolated) =  $0.0478 \text{ W/kg}$ **Right Cheek Middle 1RB\_49/Zoom Scan (5x5x7)/Cube 0:** Measurement grid:  $dx=8\text{mm}$ ,  $dy=8\text{mm}$ ,  $dz=5\text{mm}$ Reference Value =  $2.587 \text{ V/m}$ ; Power Drift =  $0.14 \text{ dB}$ Peak SAR (extrapolated) =  $0.0570 \text{ W/kg}$ **SAR(1 g) =  $0.044 \text{ W/kg}$ ; SAR(10 g) =  $0.032 \text{ W/kg}$** Maximum value of SAR (measured) =  $0.0480 \text{ W/kg}$ **Fig.21 LTE Band 13**



**LTE Band 13 Body**

Date: 2020-9-18

Electronics: DAE4 Sn786

Medium: Head 750MHz

Medium parameters used:  $f = 782 \text{ MHz}$ ;  $\sigma = 0.921 \text{ S/m}$ ;  $\epsilon_r = 40.868$ ;  $\rho = 1000 \text{ kg/m}^3$ Ambient Temperature:  $22.0^\circ\text{C}$       Liquid Temperature:  $21.5^\circ\text{C}$ 

Communication System: UID 0, LTE\_FDD (0) Frequency: 782 MHz Duty Cycle: 1:1

Probe: EX3DV4 – SN3633 ConvF (9.59, 9.59, 9.59);

**Rear Side Middle 1RB\_49/Area Scan (51x91x1):** Interpolated grid:  $dx=1.500 \text{ mm}$ ,  $dy=1.500 \text{ mm}$ 

Maximum value of SAR (interpolated) = 0.0980 W/kg

**Rear Side Middle 1RB\_49/Zoom Scan (5x5x7)/Cube 0:** Measurement grid:  $dx=8\text{mm}$ ,  $dy=8\text{mm}$ ,  $dz=5\text{mm}$ 

Reference Value = 7.554 V/m; Power Drift = 0.02 dB

Peak SAR (extrapolated) = 0.117 W/kg

**SAR(1 g) = 0.074 W/kg; SAR(10 g) = 0.049 W/kg**

Maximum value of SAR (measured) = 0.0957 W/kg

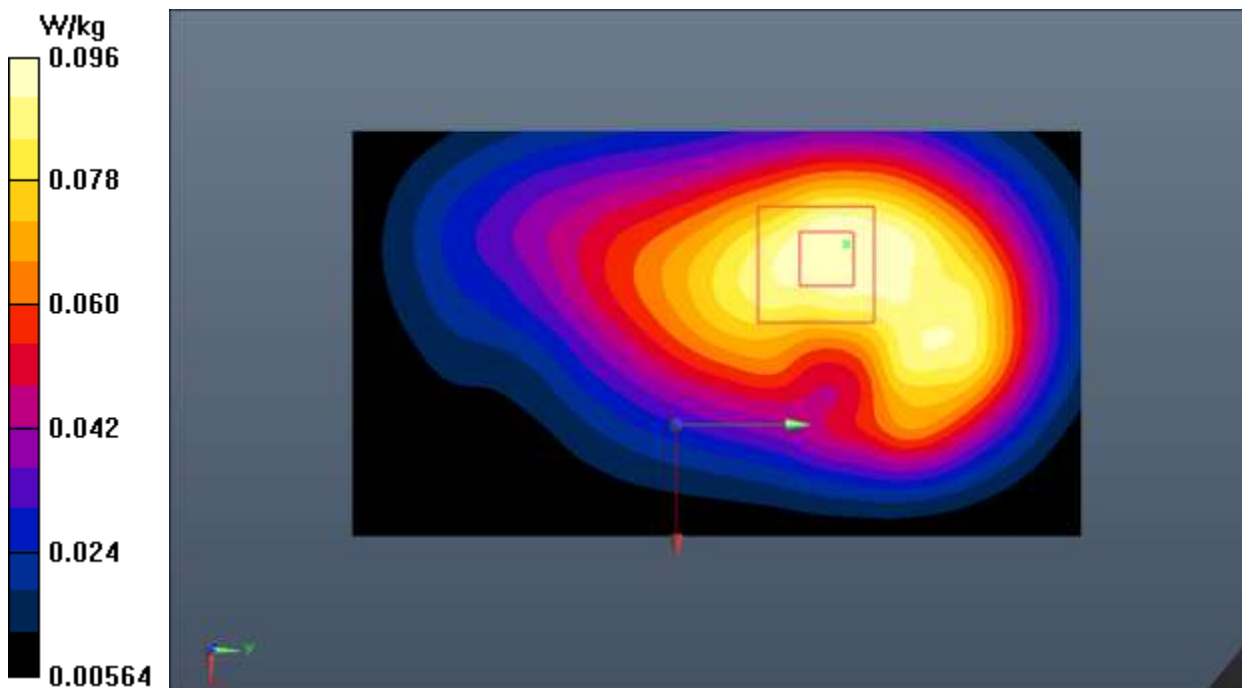

Fig.22 LTE Band 13

**LTE Band 25 Head**

Date: 2020-10-12

Electronics: DAE4 Sn786

Medium: Head 1900MHz

Medium parameters used:  $f = 1860$  MHz;  $\sigma = 1.382$  S/m;  $\epsilon_r = 39.149$ ;  $\rho = 1000$  kg/m<sup>3</sup>

Ambient Temperature: 22.0°C      Liquid Temperature: 21.5°C

Communication System: UID 0, LTE\_FDD (0) Frequency: 1860 MHz Duty Cycle: 1:1

Probe: EX3DV4 – SN3633 ConvF (7.76, 7.76, 7.76);

**Left Cheek Low 1RB\_50/Area Scan (51x61x1):** Interpolated grid: dx=1.500 mm, dy=1.500 mm

Maximum value of SAR (interpolated) = 0.323 W/kg

**Left Cheek Low 1RB\_50/Zoom Scan (5x5x7)/Cube 0:** Measurement grid: dx=8mm, dy=8mm, dz=5mm

Reference Value = 3.977 V/m; Power Drift = 0.08 dB

Peak SAR (extrapolated) = 0.375 W/kg

**SAR(1 g) = 0.248 W/kg; SAR(10 g) = 0.117 W/kg**

Maximum value of SAR (measured) = 0.311 W/kg

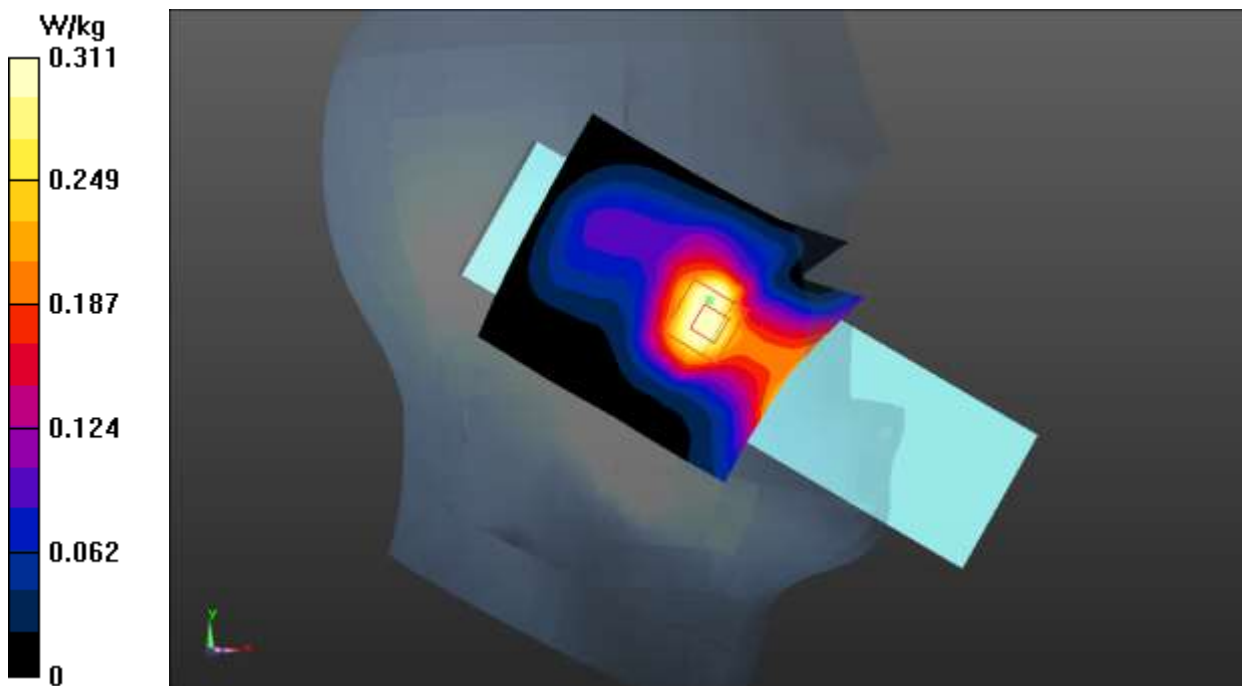

Fig.23 LTE Band 25

**LTE Band 25 Body**

Date: 2020-10-12

Electronics: DAE4 Sn786

Medium: Head 1900MHz

Medium parameters used:  $f = 1905 \text{ MHz}$ ;  $\sigma = 1.421 \text{ S/m}$ ;  $\epsilon_r = 38.974$ ;  $\rho = 1000 \text{ kg/m}^3$

Ambient Temperature:  $22.0^\circ\text{C}$       Liquid Temperature:  $21.5^\circ\text{C}$

Communication System: UID 0, LTE\_FDD (0) Frequency: 1905 MHz Duty Cycle: 1:1

Probe: EX3DV4 – SN3633 ConvF (7.76, 7.76, 7.76);

**Rear Side High 1RB\_50/Area Scan (51x61x1):** Interpolated grid:  $dx=1.500 \text{ mm}$ ,  $dy=1.500 \text{ mm}$

Maximum value of SAR (interpolated) =  $1.38 \text{ W/kg}$

**Rear Side High 1RB\_50/Zoom Scan (5x5x7)/Cube 0:** Measurement grid:  $dx=8\text{mm}$ ,  $dy=8\text{mm}$ ,  $dz=5\text{mm}$

Reference Value =  $8.422 \text{ V/m}$ ; Power Drift =  $0.03 \text{ dB}$

Peak SAR (extrapolated) =  $1.72 \text{ W/kg}$

**SAR(1 g) =  $0.980 \text{ W/kg}$ ; SAR(10 g) =  $0.529 \text{ W/kg}$**

Maximum value of SAR (measured) =  $1.35 \text{ W/kg}$

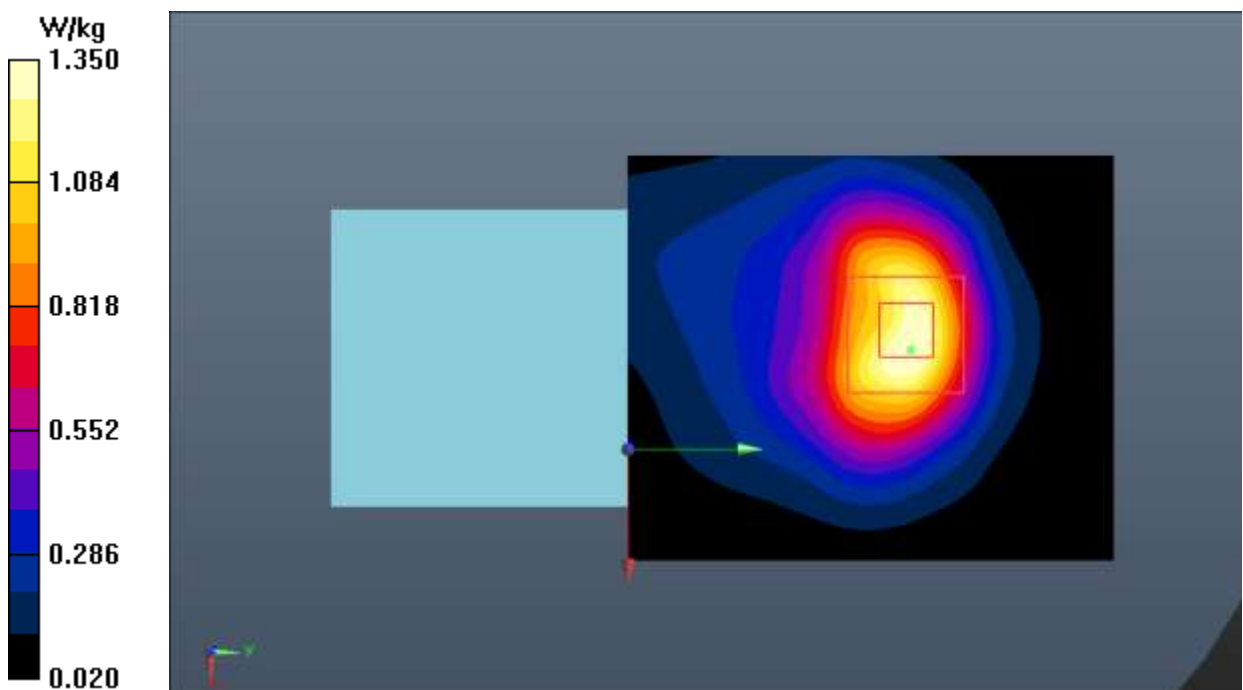

**Fig.24 LTE Band 25**

**LTE Band 26 Head**

Date: 2020-9-20

Electronics: DAE4 Sn786

Medium: Head 835MHz

Medium parameters used:  $f = 832 \text{ MHz}$ ;  $\sigma = 0.911 \text{ S/m}$ ;  $\epsilon_r = 40.794$ ;  $\rho = 1000 \text{ kg/m}^3$ Ambient Temperature:  $22.0^\circ\text{C}$       Liquid Temperature:  $21.5^\circ\text{C}$ Communication System: UID 0, LTE\_FDD (0) Frequency:  $831.5 \text{ MHz}$  Duty Cycle: 1:1

Probe: EX3DV4 – SN3633 ConvF (9.59, 9.59, 9.59);

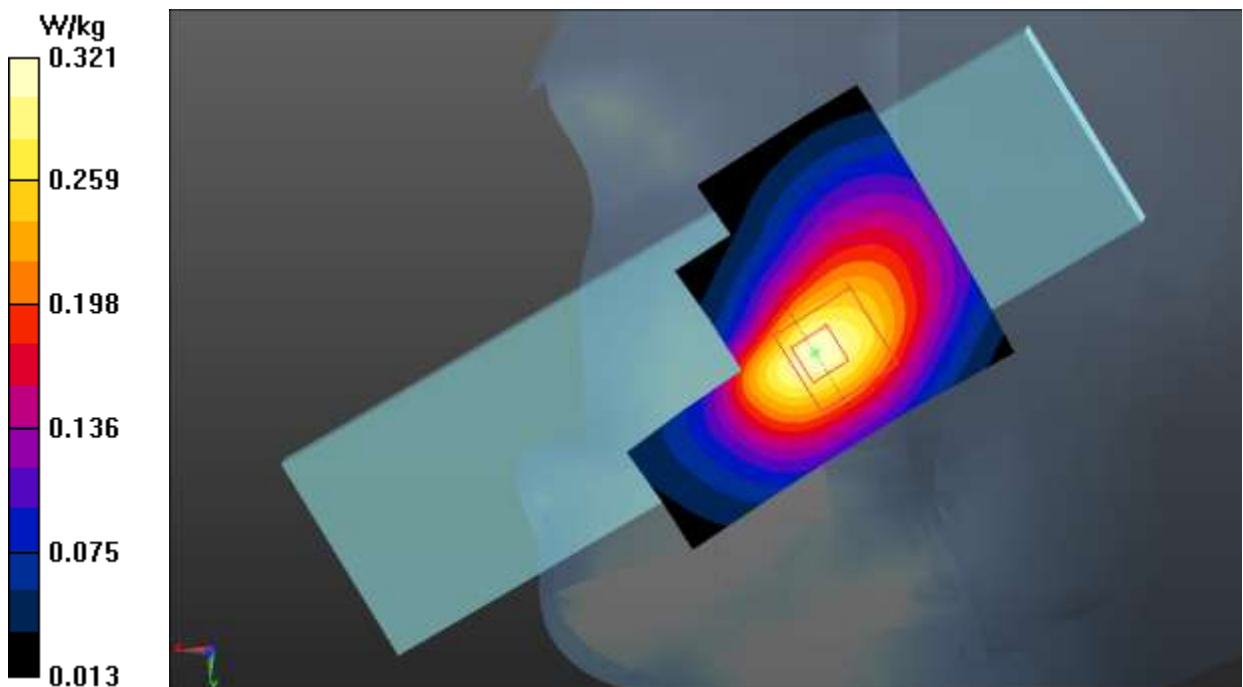
**Right Cheek Middle 1RB\_37/Area Scan (51x61x1):** Interpolated grid:  $dx=1.500 \text{ mm}$ ,  $dy=1.500 \text{ mm}$ Maximum value of SAR (interpolated) =  $0.318 \text{ W/kg}$ **Right Cheek Middle 1RB\_37/Zoom Scan (5x5x7)/Cube 0:** Measurement grid:  $dx=8\text{mm}$ ,  $dy=8\text{mm}$ ,  $dz=5\text{mm}$ Reference Value =  $5.285 \text{ V/m}$ ; Power Drift =  $0.09 \text{ dB}$ Peak SAR (extrapolated) =  $0.408 \text{ W/kg}$ **SAR(1 g) =  $0.271 \text{ W/kg}$ ; SAR(10 g) =  $0.177 \text{ W/kg}$** Maximum value of SAR (measured) =  $0.321 \text{ W/kg}$ **Fig.25 LTE Band 26**

**LTE Band 26 Body**

Date: 2020-9-20

Electronics: DAE4 Sn786

Medium: Head 835MHz

Medium parameters used:  $f = 832 \text{ MHz}$ ;  $\sigma = 0.911 \text{ S/m}$ ;  $\epsilon_r = 40.794$ ;  $\rho = 1000 \text{ kg/m}^3$ Ambient Temperature:  $22.0^\circ\text{C}$       Liquid Temperature:  $21.5^\circ\text{C}$ 

Communication System: UID 0, LTE\_FDD (0) Frequency: 831.5 MHz Duty Cycle: 1:1

Probe: EX3DV4 – SN3633 ConvF (9.59, 9.59, 9.59);

**Rear Side Middle 1RB\_37/Area Scan (51x91x1):** Interpolated grid:  $dx=1.500 \text{ mm}$ ,  $dy=1.500 \text{ mm}$ 

Maximum value of SAR (interpolated) = 0.721 W/kg

**Rear Side Middle 1RB\_37/Zoom Scan (5x5x7)/Cube 0:** Measurement grid:  $dx=8\text{mm}$ ,  $dy=8\text{mm}$ ,  $dz=5\text{mm}$ 

Reference Value = 21.60 V/m; Power Drift = 0.01 dB

Peak SAR (extrapolated) = 0.873 W/kg

**SAR(1 g) = 0.575 W/kg; SAR(10 g) = 0.381 W/kg**

Maximum value of SAR (measured) = 0.724 W/kg

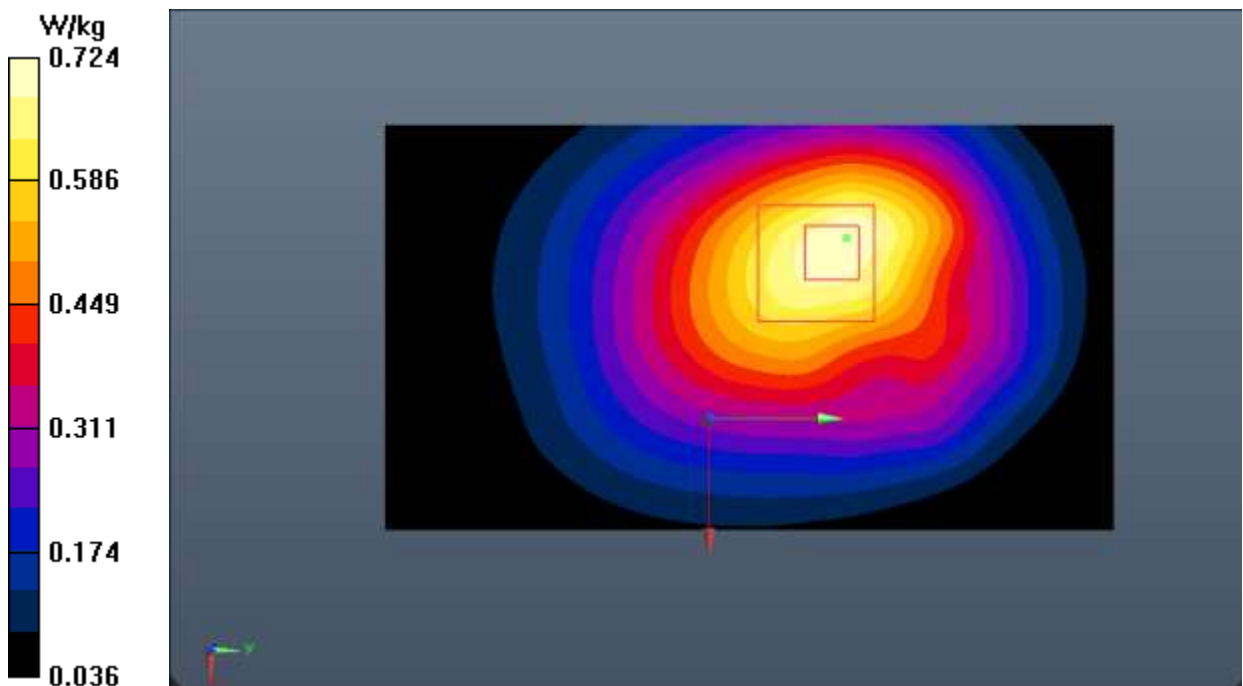

Fig.26 LTE Band 26

**LTE Band 41 Head**

Date: 2020-10-15

Electronics: DAE4 Sn786

Medium: Head 2550MHz

Medium parameters used:  $f = 2506$  MHz;  $\sigma = 1.897$  S/m;  $\epsilon_r = 38.256$ ;  $\rho = 1000$  kg/m<sup>3</sup>

Ambient Temperature: 22.0°C      Liquid Temperature: 21.5°C

Communication System: UID 0, LTE\_TDD (0) Frequency: 2506 MHz Duty Cycle: 1:2.31

Probe: EX3DV4 – SN3633 ConvF (7.43, 7.43, 7.43);

**Left Cheek Low 1RB\_50/Area Scan (91x91x1):** Interpolated grid: dx=1.000 mm, dy=1.000 mm

Maximum value of SAR (interpolated) = 0.310 W/kg

**Left Cheek Low 1RB\_50/Zoom Scan (7x8x7)/Cube 0:** Measurement grid: dx=5mm, dy=5mm, dz=5mm

Reference Value = 3.615 V/m; Power Drift = 0.05 dB

Peak SAR (extrapolated) = 0.396 W/kg

**SAR(1 g) = 0.286 W/kg; SAR(10 g) = 0.147 W/kg**

Maximum value of SAR (measured) = 0.338 W/kg

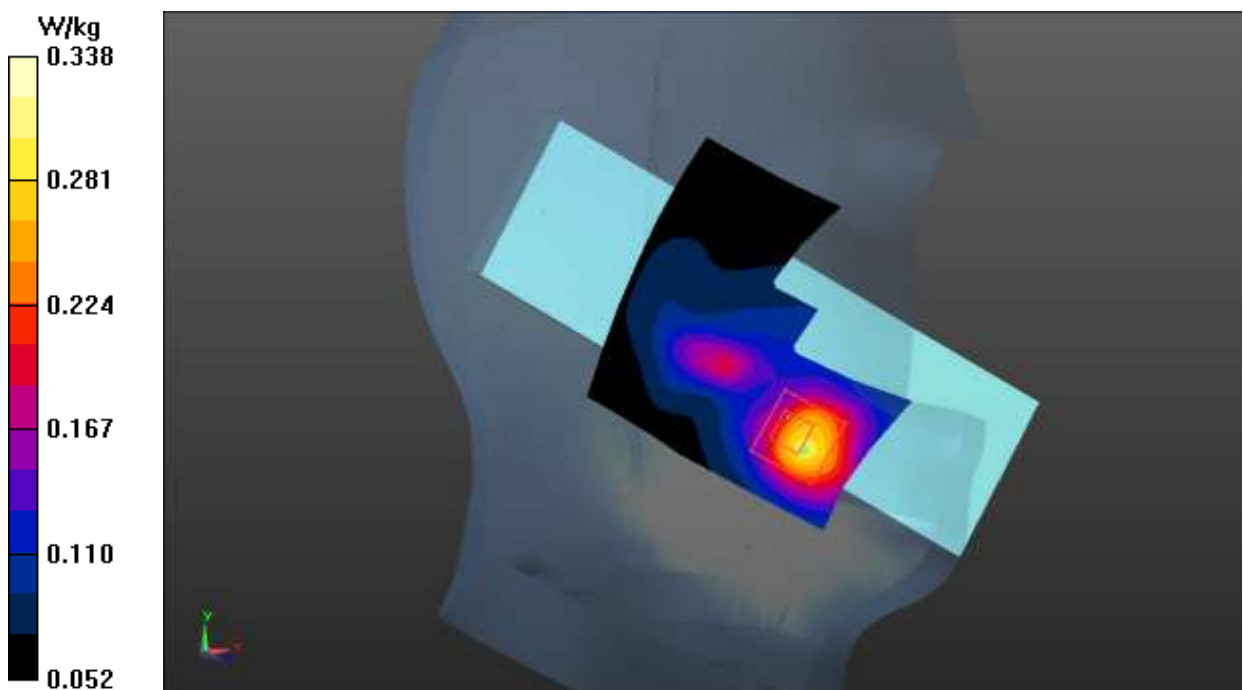
**Fig.27 LTE Band 41**

**LTE Band 41 Body**

Date: 2020-10-15

Electronics: DAE4 Sn786

Medium: Head 2550MHz

Medium parameters used:  $f = 2506$  MHz;  $\sigma = 1.897$  S/m;  $\epsilon_r = 38.256$ ;  $\rho = 1000$  kg/m<sup>3</sup>

Ambient Temperature: 22.0°C      Liquid Temperature: 21.5°C

Communication System: UID 0, LTE\_TDD (0) Frequency: 2506 MHz Duty Cycle: 1:2.31

Probe: EX3DV4 – SN3633 ConvF (7.43, 7.43, 7.43);

**Rear Side Low 1RB\_50 /Area Scan (81x91x1):** Interpolated grid: dx=1.000 mm, dy=1.000 mm

Maximum value of SAR (interpolated) = 1.22 W/kg

**Rear Side Low 1RB\_50 /Zoom Scan (7x7x7)/Cube 0:** Measurement grid: dx=5mm, dy=5mm, dz=5mm

Reference Value = 7.258 V/m; Power Drift = 0.19 dB

Peak SAR (extrapolated) = 1.97 W/kg

**SAR(1 g) = 0.979 W/kg; SAR(10 g) = 0.476 W/kg**

Maximum value of SAR (measured) = 1.26 W/kg

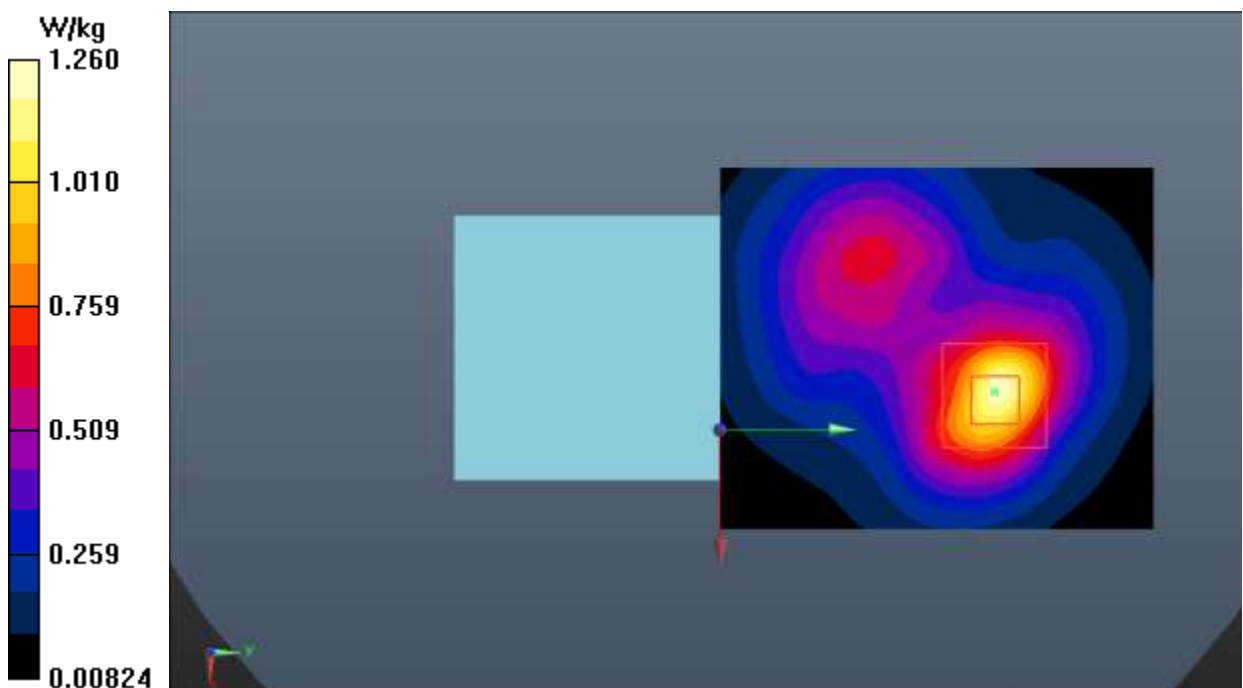
**Fig.28 LTE Band 41**

**LTE Band 66 Head**

Date: 2020-10-13

Electronics: DAE4 Sn786

Medium: Head 1750MHz

Medium parameters used:  $f = 1745 \text{ MHz}$ ;  $\sigma = 1.381 \text{ S/m}$ ;  $\epsilon_r = 39.604$ ;  $\rho = 1000 \text{ kg/m}^3$

Ambient Temperature:  $22.0^\circ\text{C}$       Liquid Temperature:  $21.5^\circ\text{C}$

Communication System: UID 0, LTE\_FDD (0) Frequency: 1745 MHz Duty Cycle: 1:1

Probe: EX3DV4 – SN3633 ConvF (8.09, 8.09, 8.09);

**Right Cheek Middle 1RB\_50/Area Scan (51x61x1):** Interpolated grid:  $dx=1.500 \text{ mm}$ ,  $dy=1.500 \text{ mm}$

Maximum value of SAR (interpolated) =  $0.276 \text{ W/kg}$

**Right Cheek Middle 1RB\_50/Zoom Scan (5x5x7)/Cube 0:** Measurement grid:  $dx=8\text{mm}$ ,  $dy=8\text{mm}$ ,  $dz=5\text{mm}$

Reference Value =  $4.355 \text{ V/m}$ ; Power Drift =  $0.13 \text{ dB}$

Peak SAR (extrapolated) =  $0.319 \text{ W/kg}$

**SAR(1 g) =  $0.226 \text{ W/kg}$ ; SAR(10 g) =  $0.142 \text{ W/kg}$**

Maximum value of SAR (measured) =  $0.252 \text{ W/kg}$

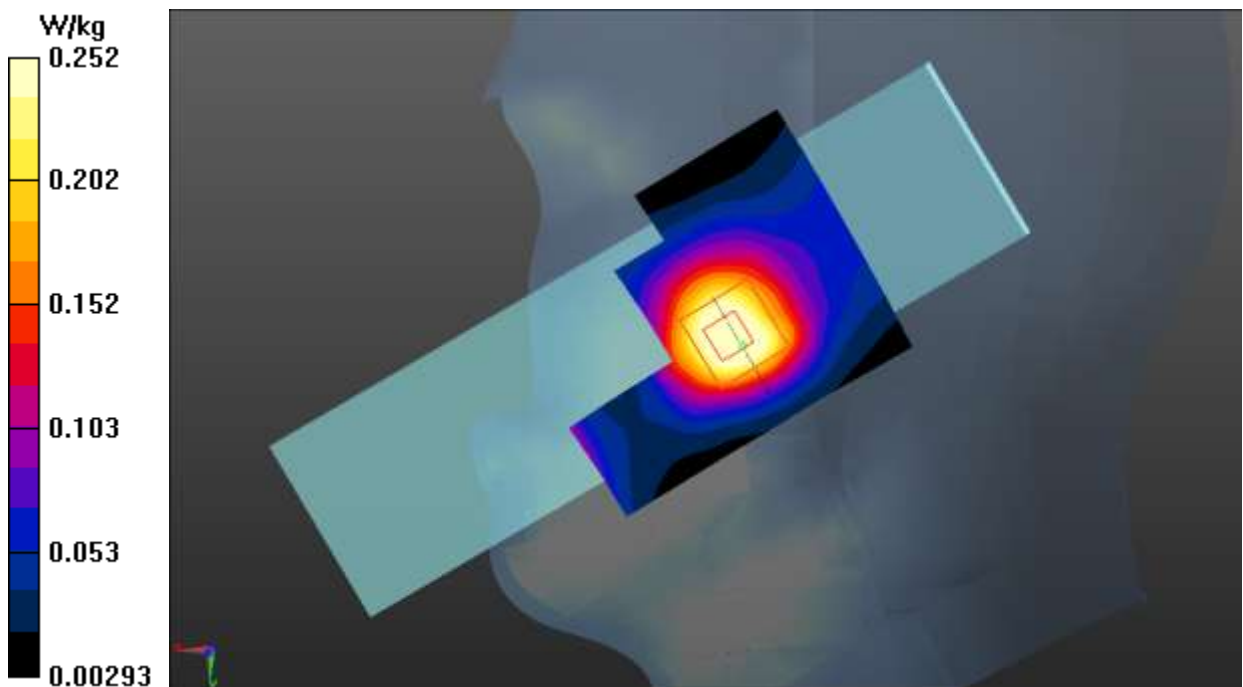

**Fig.29 LTE Band 66**



**LTE Band 66 Body**

Date: 2020-10-13

Electronics: DAE4 Sn786

Medium: Head 1750MHz

Medium parameters used:  $f = 1745$  MHz;  $\sigma = 1.381$  S/m;  $\epsilon_r = 39.604$ ;  $\rho = 1000$  kg/m<sup>3</sup>

Ambient Temperature: 22.0°C      Liquid Temperature: 21.5°C

Communication System: UID 0, LTE\_FDD (0) Frequency: 1745 MHz Duty Cycle: 1:1

Probe: EX3DV4 – SN3633 ConvF (8.09, 8.09, 8.09);

**Rear Side Middle 1RB\_50/Area Scan (51x61x1):** Interpolated grid: dx=1.500 mm, dy=1.500 mm

Maximum value of SAR (interpolated) = 1.48 W/kg

**Rear Side Middle 1RB\_50/Zoom Scan (5x5x7)/Cube 0:** Measurement grid: dx=8mm, dy=8mm, dz=5mm

Reference Value = 10.57 V/m; Power Drift = 0.04 dB

Peak SAR (extrapolated) = 1.78 W/kg

**SAR(1 g) = 1.05 W/kg; SAR(10 g) = 0.601 W/kg**

Maximum value of SAR (measured) = 1.38 W/kg

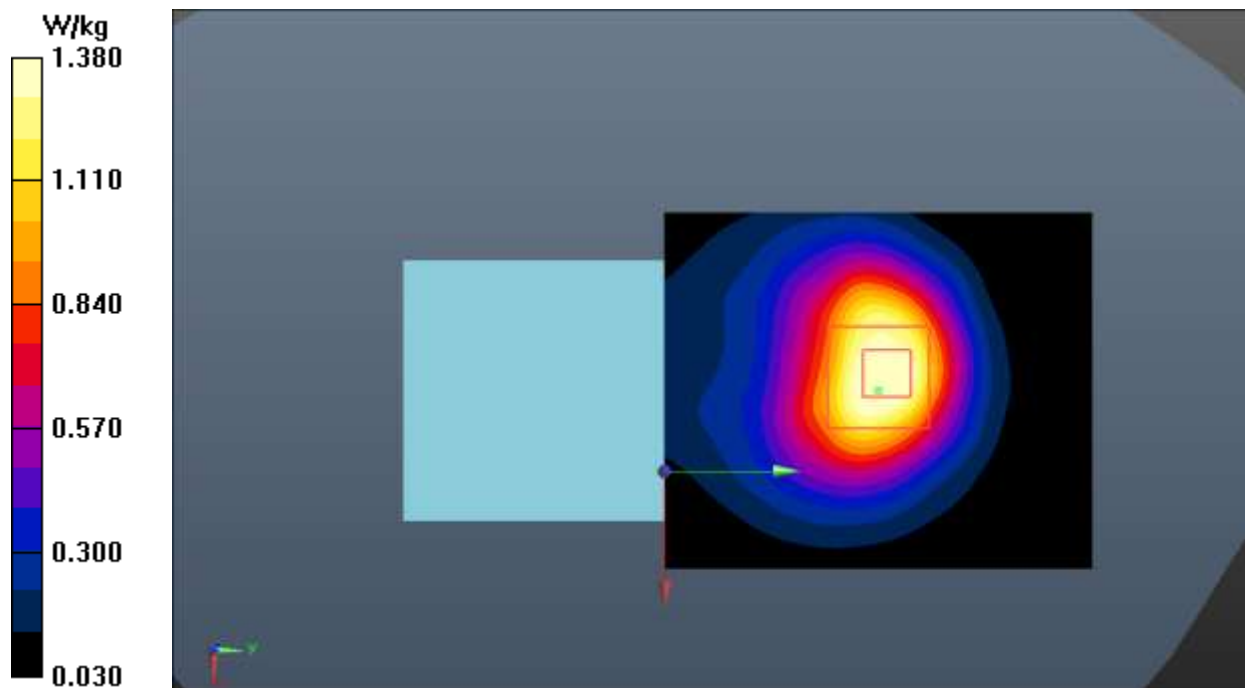
**Fig.30 LTE Band 66**

**LTE Band 71 Head**

Date: 2020-9-18

Electronics: DAE4 Sn786

Medium: Head 750MHz

Medium parameters used (extrapolated):  $f = 688 \text{ MHz}$ ;  $\sigma = 0.861 \text{ S/m}$ ;  $\epsilon_r = 41.996$ ;  $\rho = 1000 \text{ kg/m}^3$ Ambient Temperature:  $22.0^\circ\text{C}$       Liquid Temperature:  $21.5^\circ\text{C}$ 

Communication System: UID 0, LTE\_FDD (0) Frequency: 688 MHz Duty Cycle: 1:1

Probe: EX3DV4 – SN3633 ConvF (9.59, 9.59, 9.59);

**Right Cheek High 1RB\_50/Area Scan (51x61x1):** Interpolated grid:  $dx=1.500 \text{ mm}$ ,  $dy=1.500 \text{ mm}$ 

Maximum value of SAR (interpolated) = 0.0561 W/kg

**Right Cheek High 1RB\_50/Zoom Scan (5x5x7)/Cube 0:** Measurement grid:  $dx=8\text{mm}$ ,  $dy=8\text{mm}$ ,  $dz=5\text{mm}$ 

Reference Value = 1.888 V/m; Power Drift = 0.03 dB

Peak SAR (extrapolated) = 0.0730 W/kg

**SAR(1 g) = 0.049 W/kg; SAR(10 g) = 0.032 W/kg**

Maximum value of SAR (measured) = 0.0570 W/kg

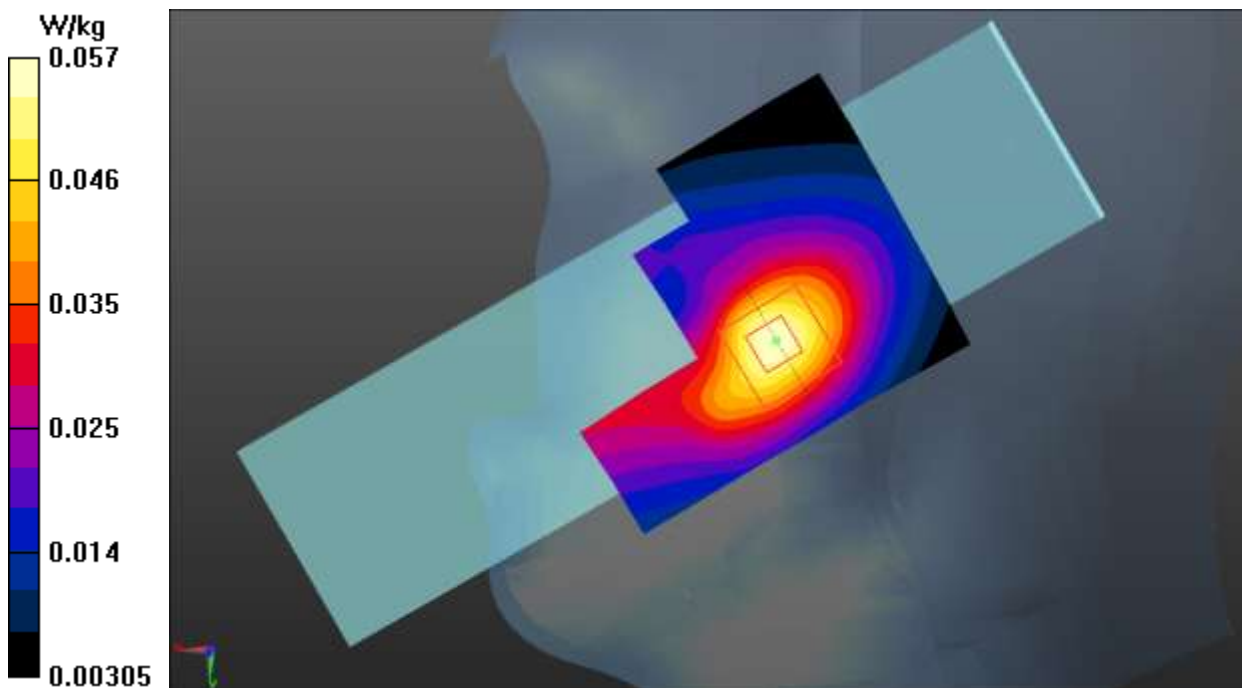

Fig.31 LTE Band 71

**LTE Band 71 Body**

Date: 2020-9-18

Electronics: DAE4 Sn786

Medium: Head 750MHz

Medium parameters used (extrapolated):  $f = 688$  MHz;  $\sigma = 0.861$  S/m;  $\epsilon_r = 41.996$ ;  $\rho = 1000$  kg/m<sup>3</sup>

Ambient Temperature: 22.0°C      Liquid Temperature: 21.5°C

Communication System: UID 0, LTE\_FDD (0) Frequency: 688 MHz Duty Cycle: 1:1

Probe: EX3DV4 – SN3633 ConvF (9.59, 9.59, 9.59);

**Rear Side High 1RB\_50/Area Scan (51x91x1):** Interpolated grid: dx=1.500 mm, dy=1.500 mm

Maximum value of SAR (interpolated) = 0.178 W/kg

**Rear Side High 1RB\_50/Zoom Scan (5x5x7)/Cube 0:** Measurement grid: dx=8mm, dy=8mm, dz=5mm

Reference Value = 9.686 V/m; Power Drift = 0.16 dB

Peak SAR (extrapolated) = 0.225 W/kg

**SAR(1 g) = 0.144 W/kg; SAR(10 g) = 0.093 W/kg**

Maximum value of SAR (measured) = 0.183 W/kg

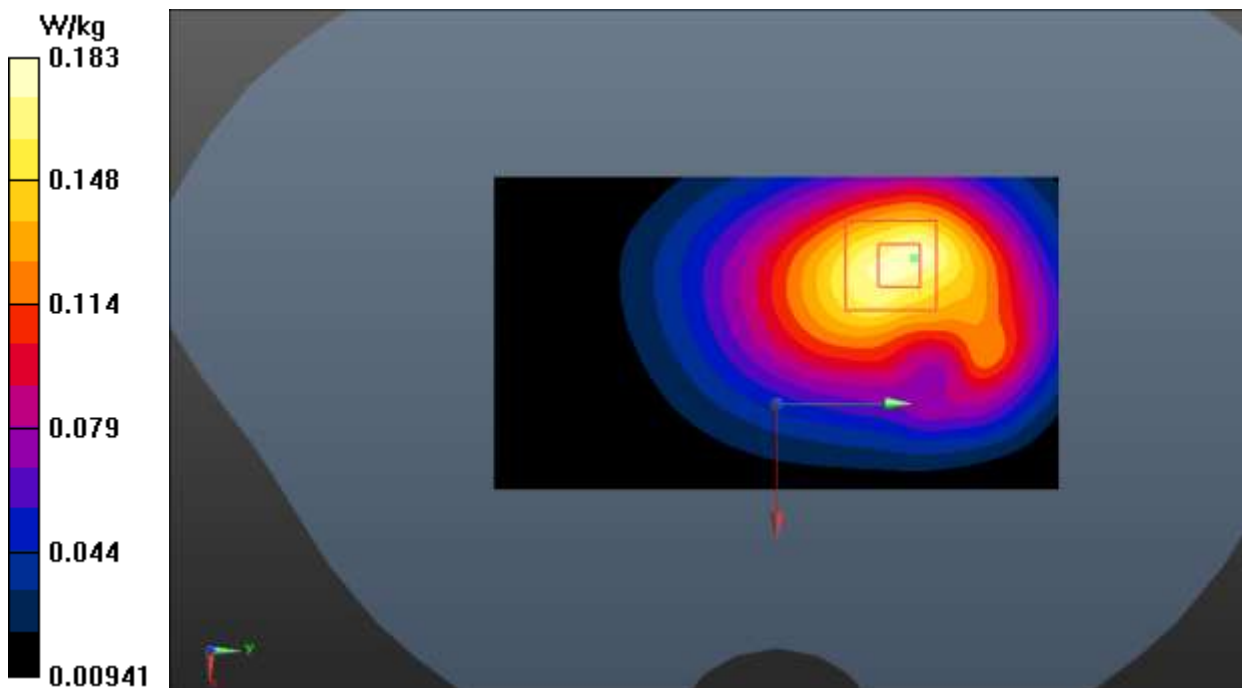

Fig.32 LTE Band 71

**WLAN 2.4G Head**

Date: 2020-9-22

Electronics: DAE4 Sn786

Medium: Head 2450MHz

Medium parameters used:  $f = 2462 \text{ MHz}$ ;  $\sigma = 1.84 \text{ S/m}$ ;  $\epsilon_r = 38.376$ ;  $\rho = 1000 \text{ kg/m}^3$

Ambient Temperature:  $22.0^\circ\text{C}$       Liquid Temperature:  $21.5^\circ\text{C}$

Communication System: UID 0, WiFi (0) Frequency: 2462 MHz Duty Cycle: 1:1

Probe: EX3DV4 – SN3633 ConvF (7.43, 7.43, 7.43);

**Left Cheek High/Area Scan (61x91x1):** Interpolated grid:  $dx=1.000 \text{ mm}$ ,  $dy=1.000 \text{ mm}$

Maximum value of SAR (interpolated) =  $0.107 \text{ W/kg}$

**Left Cheek High /Zoom Scan (7x7x7)/Cube 0:** Measurement grid:  $dx=5\text{mm}$ ,  $dy=5\text{mm}$ ,  $dz=5\text{mm}$

Reference Value =  $1.948 \text{ V/m}$ ; Power Drift =  $0.03 \text{ dB}$

Peak SAR (extrapolated) =  $0.153 \text{ W/kg}$

**SAR(1 g) =  $0.079 \text{ W/kg}$ ; SAR(10 g) =  $0.038 \text{ W/kg}$**

Maximum value of SAR (measured) =  $0.106 \text{ W/kg}$

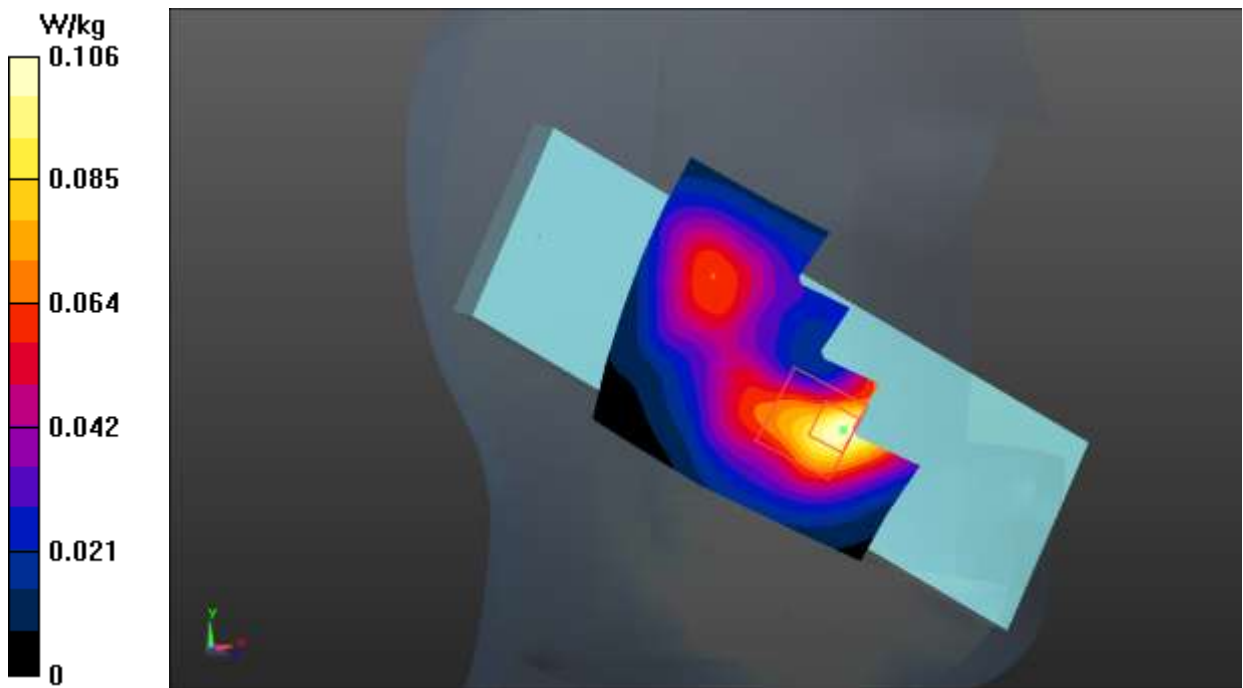

**Fig.33 WLAN 2.4G**

**WLAN 2.4G Body**

Date: 2020-9-22

Electronics: DAE4 Sn786

Medium: Head 2450MHz

Medium parameters used:  $f = 2462$  MHz;  $\sigma = 1.84$  S/m;  $\epsilon_r = 38.376$ ;  $\rho = 1000$  kg/m<sup>3</sup>

Ambient Temperature: 22.0°C      Liquid Temperature: 21.5°C

Communication System: UID 0, WiFi (0) Frequency: 2462 MHz Duty Cycle: 1:1

Probe: EX3DV4 – SN3633 ConvF (7.43, 7.43, 7.43);

**Right Side High/Area Scan (61x101x1):** Interpolated grid: dx=1.000 mm, dy=1.000 mm

Maximum value of SAR (interpolated) = 0.179 W/kg

**Right Side High/Zoom Scan (7x7x7)/Cube 0:** Measurement grid: dx=5mm, dy=5mm, dz=5mm

Reference Value = 4.744 V/m; Power Drift = 0.06 dB

Peak SAR (extrapolated) = 0.275 W/kg

**SAR(1 g) = 0.137 W/kg; SAR(10 g) = 0.071 W/kg**

Maximum value of SAR (measured) = 0.176 W/kg

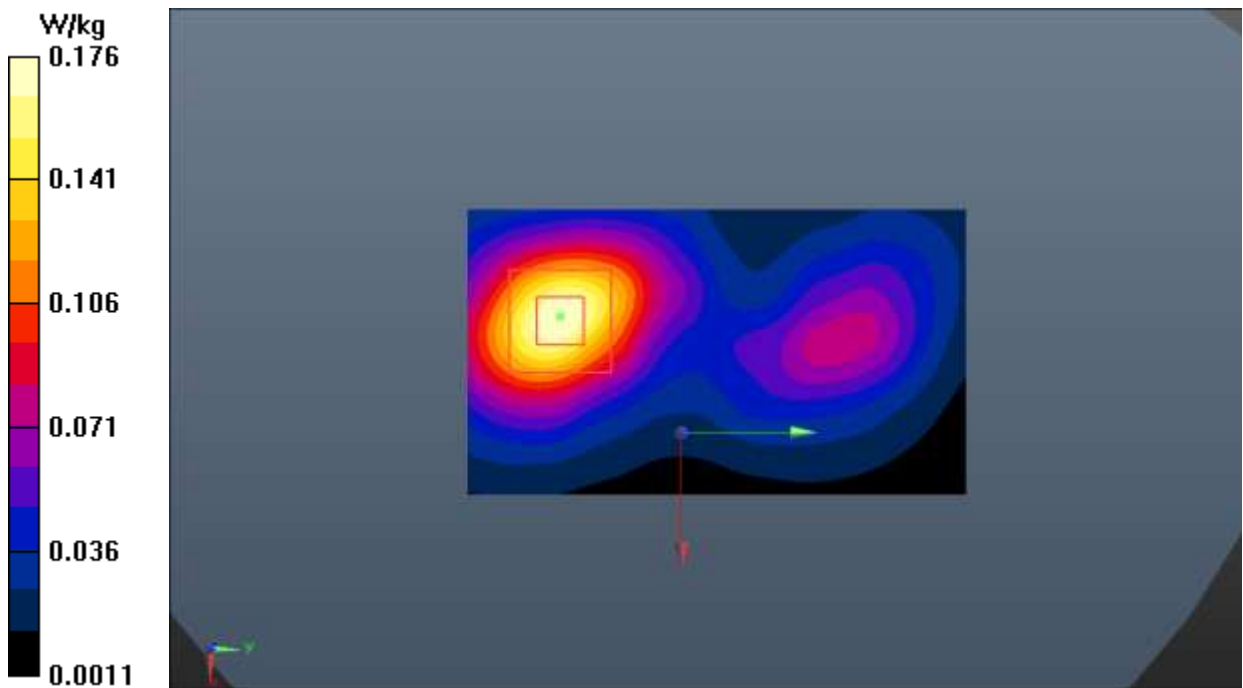

Fig.34 WLAN 2.4G

## ANNEX B: System Verification Results

### 750MHz

Date: 2020-9-18

Electronics: DAE4 Sn786

Medium: Head 750MHz

Medium parameters used:  $f = 750 \text{ MHz}$ ;  $\sigma = 0.901 \text{ S/m}$ ;  $\epsilon_r = 41.252$ ;  $\rho = 1000 \text{ kg/m}^3$

Ambient Temperature:  $22.5^\circ\text{C}$       Liquid Temperature:  $22.0^\circ\text{C}$

Communication System: CW Frequency: 750 MHz Duty Cycle: 1:1

Probe: EX3DV4 – SN3633 ConvF (9.59, 9.59, 9.59);

**System Validation /Area Scan (81x151x1):** Interpolated grid:  $dx=1.000 \text{ mm}$ ,  $dy=1.000 \text{ mm}$

Reference Value =  $60.744 \text{ V/m}$ ; Power Drift =  $0.02 \text{ dB}$

**SAR(1 g) = 2.12 W/kg; SAR(10 g) = 1.40 W/kg**

Maximum value of SAR (interpolated) =  $2.52 \text{ W/kg}$

**System Validation /Zoom Scan (7x7x7)/Cube 0:** Measurement grid:  $dx=5\text{mm}$ ,  $dy=5\text{mm}$ ,  $dz=5\text{mm}$

Reference Value =  $60.744 \text{ V/m}$ ; Power Drift =  $0.02 \text{ dB}$

Peak SAR (extrapolated) =  $3.03 \text{ W/kg}$

**SAR(1 g) = 2.18 W/kg; SAR(10 g) = 1.44 W/kg**

Maximum value of SAR (measured) =  $2.58 \text{ W/kg}$

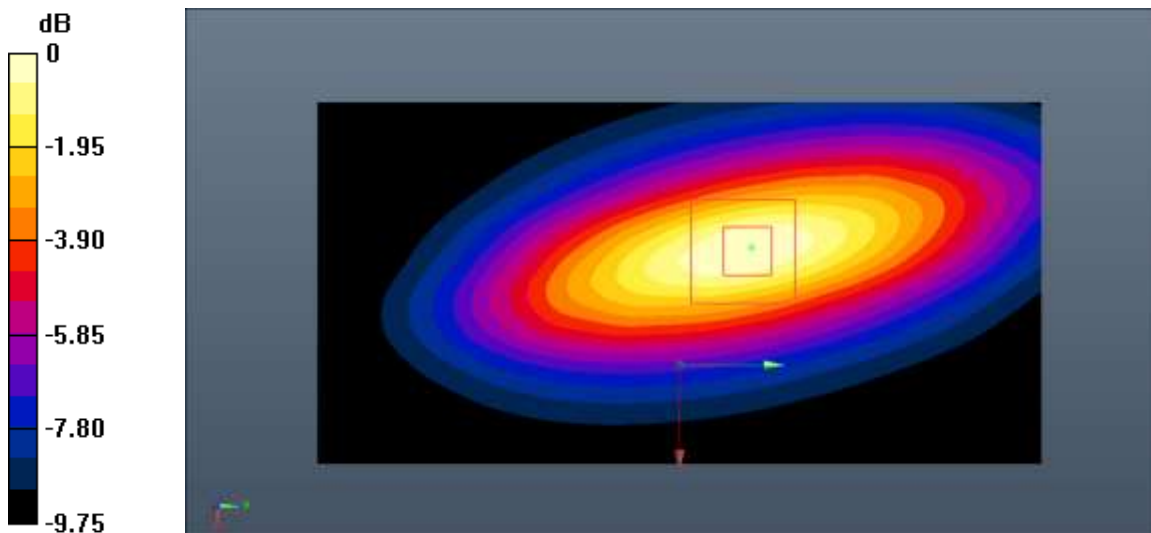

0 dB =  $2.58 \text{ W/kg} = 4.12 \text{ dB W/kg}$

**Fig.B.1. Validation 750MHz 250mW**

**835MHz**

Date: 2020-9-20

Electronics: DAE4 Sn786

Medium: Head 835MHz

Medium parameters used:  $f = 835 \text{ MHz}$ ;  $\sigma = 0.914 \text{ S/m}$ ;  $\epsilon_r = 40.758$ ;  $\rho = 1000 \text{ kg/m}^3$ Ambient Temperature:  $22.5^\circ\text{C}$       Liquid Temperature:  $22.0^\circ\text{C}$ 

Communication System: CW Frequency: 835 MHz Duty Cycle: 1:1

Probe: EX3DV4 – SN3633 ConvF (9.59, 9.59, 9.59);

**System Validation /Area Scan (81x151x1):** Interpolated grid:  $dx=1.000 \text{ mm}$ ,  $dy=1.000 \text{ mm}$ 

Reference Value = 62.046 V/m; Power Drift = 0.08 dB

**SAR(1 g) = 2.45 W/kg; SAR(10 g) = 1.59 W/kg**

Maximum value of SAR (interpolated) = 2.88 W/kg

**System Validation /Zoom Scan (7x7x7)/Cube 0:** Measurement grid:  $dx=5\text{mm}$ ,  $dy=5\text{mm}$ ,  $dz=5\text{mm}$ 

Reference Value = 62.046 V/m; Power Drift = 0.08 dB

Peak SAR (extrapolated) = 3.45 W/kg

**SAR(1 g) = 2.51 W/kg; SAR(10 g) = 1.63 W/kg**

Maximum value of SAR (measured) = 2.93 W/kg

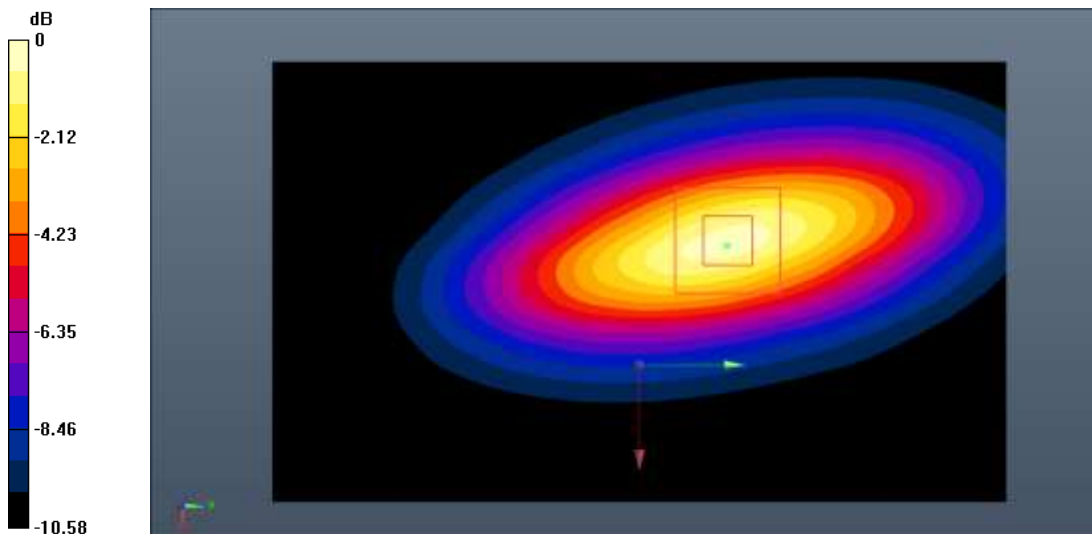

0 dB = 2.93 W/kg = 4.67 dB W/kg

**Fig.B.2. Validation 835MHz 250mW**

**1750MHz**

Date: 2020-10-13

Electronics: DAE4 Sn786

Medium: Head 1750MHz

Medium parameters used:  $f = 1750 \text{ MHz}$ ;  $\sigma = 1.385 \text{ S/m}$ ;  $\epsilon_r = 39.584$ ;  $\rho = 1000 \text{ kg/m}^3$

Ambient Temperature:  $22.5^\circ\text{C}$       Liquid Temperature:  $22.0^\circ\text{C}$

Communication System: CW Frequency: 1750 MHz Duty Cycle: 1:1

Probe: EX3DV4 – SN3633 ConvF (8.09, 8.09, 8.09);

**System Validation/Area Scan (71x121x1):** Interpolated grid:  $dx=1.000 \text{ mm}$ ,  $dy=1.000 \text{ mm}$

Reference Value =  $79.234 \text{ V/m}$ ; Power Drift =  $0.13 \text{ dB}$

**SAR(1 g) =  $9.25 \text{ W/kg}$ ; SAR(10 g) =  $4.83 \text{ W/kg}$**

Maximum value of SAR (interpolated) =  $11.3 \text{ W/kg}$

**System Validation/Zoom Scan (7x7x7)/Cube 0:** Measurement grid:  $dx=5\text{mm}$ ,  $dy=5\text{mm}$ ,  $dz=5\text{mm}$

Reference Value =  $79.234 \text{ V/m}$ ; Power Drift =  $0.13 \text{ dB}$

Peak SAR (extrapolated) =  $18.5 \text{ W/kg}$

**SAR(1 g) =  $9.47 \text{ W/kg}$ ; SAR(10 g) =  $4.95 \text{ W/kg}$**

Maximum value of SAR (measured) =  $11.6 \text{ W/kg}$

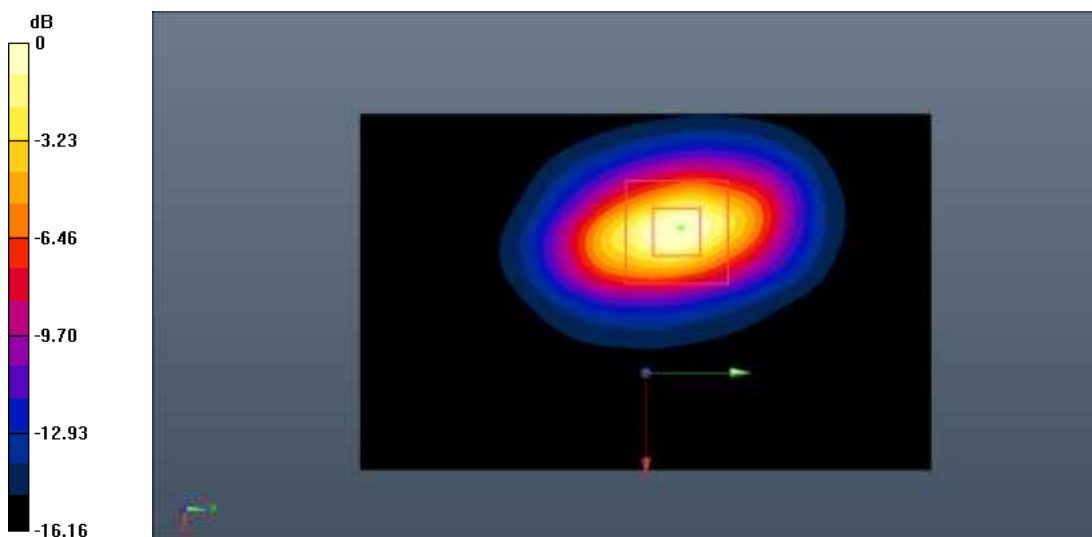

0 dB =  $11.6 \text{ W/kg}$  =  $10.64 \text{ dB W/kg}$

**Fig.B.3. Validation 1750MHz 250mW**



**1900MHz**

Date: 2020-10-12

Electronics: DAE4 Sn786

Medium: Head 1900MHz

Medium parameters used:  $f = 1900$  MHz;  $\sigma = 1.417$  S/m;  $\epsilon_r = 38.993$ ;  $\rho = 1000$  kg/m<sup>3</sup>

Ambient Temperature: 22.5°C      Liquid Temperature: 22.0°C

Communication System: CW Frequency: 1900 MHz Duty Cycle: 1:1

Probe: EX3DV4 – SN3633 ConvF (7.76, 7.76, 7.76);

**System Validation /Area Scan (81x81x1):** Interpolated grid: dx=1.000 mm, dy=1.000 mm

Reference Value = 91.108 V/m; Power Drift = 0.04 dB

**SAR(1 g) = 10.2 W/kg; SAR(10 g) = 5.20 W/kg**

Maximum value of SAR (interpolated) = 12.9 W/kg

**System Validation /Zoom Scan (7x7x7)/Cube 0:** Measurement grid: dx=5mm, dy=5mm, dz=5mm

Reference Value = 91.108 V/m; Power Drift = 0.04 dB

Peak SAR (extrapolated) = 22.2 W/kg

**SAR(1 g) = 10.4 W/kg; SAR(10 g) = 5.32 W/kg**

Maximum value of SAR (measured) = 13.2 W/kg

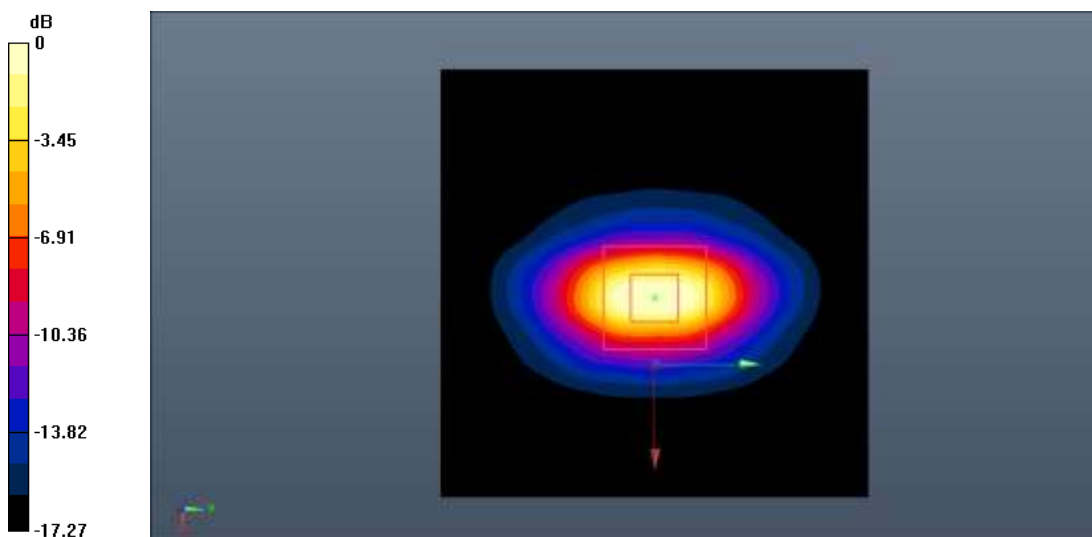

0 dB = 13.2 W/kg = 11.21 dB W/kg

**Fig.B.4. Validation 1900MHz 250mW**

**2450MHz**

Date: 2020-9-22

Electronics: DAE4 Sn786

Medium: Head 2450MHz

Medium parameters used:  $f = 2450 \text{ MHz}$ ;  $\sigma = 1.826 \text{ S/m}$ ;  $\epsilon_r = 38.416$ ;  $\rho = 1000 \text{ kg/m}^3$

Ambient Temperature:  $22.5^\circ\text{C}$       Liquid Temperature:  $22.0^\circ\text{C}$

Communication System: CW Frequency: 2450 MHz Duty Cycle: 1:1

Probe: EX3DV4 – SN3633 ConvF (7.43, 7.43, 7.43);

**System Validation /Area Scan (71x121x1):** Interpolated grid:  $dx=1.000 \text{ mm}$ ,  $dy=1.000 \text{ mm}$

Reference Value = 92.789 V/m; Power Drift = 0.10 dB

**SAR(1 g) = 13.3 W/kg; SAR(10 g) = 6.01 W/kg**

Maximum value of SAR (interpolated) = 15.2 W/kg

**System Validation /Zoom Scan (7x7x7)/Cube 0:** Measurement grid:  $dx=5\text{mm}$ ,  $dy=5\text{mm}$ ,  $dz=5\text{mm}$

Reference Value = 92.789 V/m; Power Drift = 0.10 dB

Peak SAR (extrapolated) = 26.8 W/kg

**SAR(1 g) = 13.5 W/kg; SAR(10 g) = 6.13 W/kg**

Maximum value of SAR (measured) = 15.4 W/kg

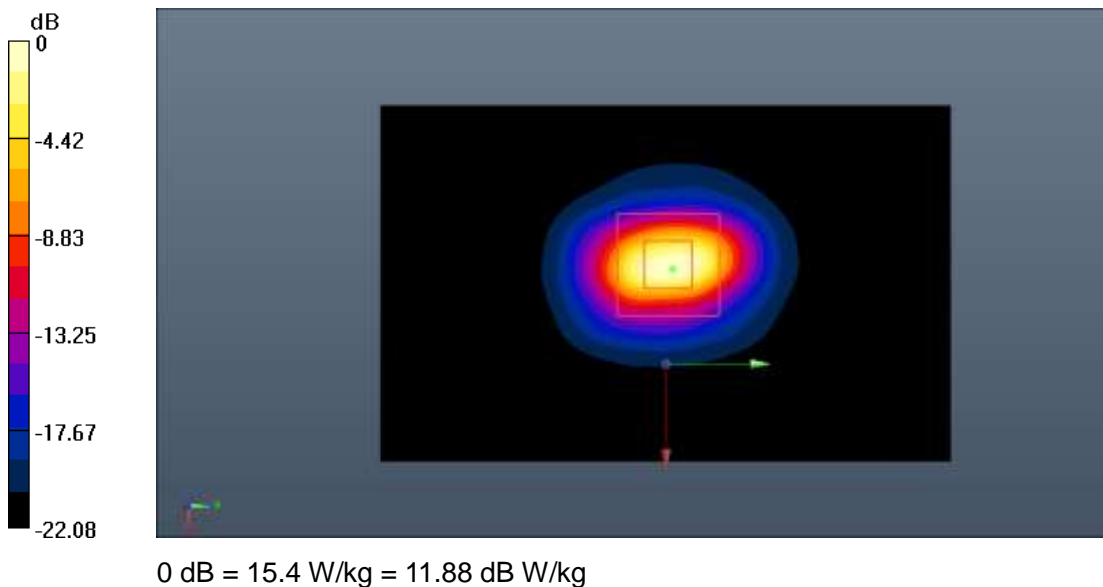

**Fig.B.5. Validation 2450MHz 250mW**

**2550MHz**

Date: 2020-10-15

Electronics: DAE4 Sn786

Medium: Head 2550MHz

Medium parameters used:  $f = 2550 \text{ MHz}$ ;  $\sigma = 1.949 \text{ S/m}$ ;  $\epsilon_r = 38.111$ ;  $\rho = 1000 \text{ kg/m}^3$ Ambient Temperature:  $22.5^\circ\text{C}$       Liquid Temperature:  $22.0^\circ\text{C}$ 

Communication System: CW\_TMC Frequency: 2550 MHz Duty Cycle: 1:1

Probe: EX3DV4 – SN3633 ConvF (7.20, 7.20, 7.20);

**System Validation/Area Scan (81x81x1):** Interpolated grid:  $dx=1.000 \text{ mm}$ ,  $dy=1.000 \text{ mm}$ 

Reference Value = 93.855 V/m; Power Drift = 0.06 dB

**SAR(1 g) = 14.7 W/kg; SAR(10 g) = 6.69 W/kg**

Maximum value of SAR (interpolated) = 16.4 W/kg

**System Validation/Zoom Scan (7x7x7)/Cube0:** Measurement grid:  $dx=5\text{mm}$ ,  $dy=5\text{mm}$ ,  $dz=5\text{mm}$ 

Reference Value = 93.855 V/m; Power Drift = 0.06 dB

Peak SAR (extrapolated) = 31.2 W/kg

**SAR(1 g) = 15.0 W/kg; SAR(10 g) = 6.76 W/kg**

Maximum value of SAR (measured) = 16.6 W/kg

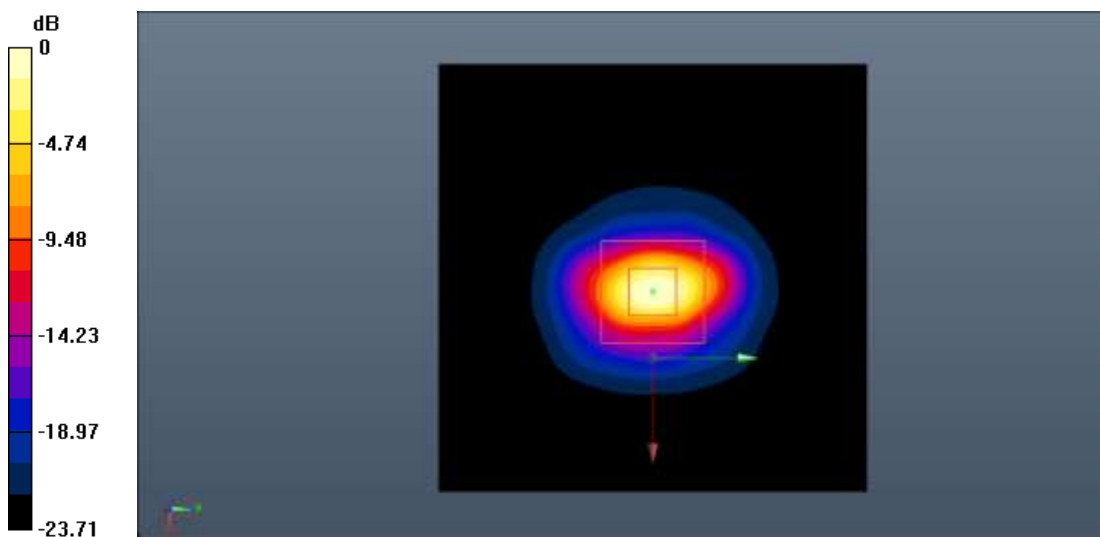

0 dB = 16.6 W/kg = 12.20 dB W/kg

**Fig.B.6. Validation 2550MHz 250mW**

## ANNEX C: SAR Measurement Setup

### C.1. Measurement Set-up

DASY5 system for performing compliance tests is illustrated above graphically. This system consists of the following items:

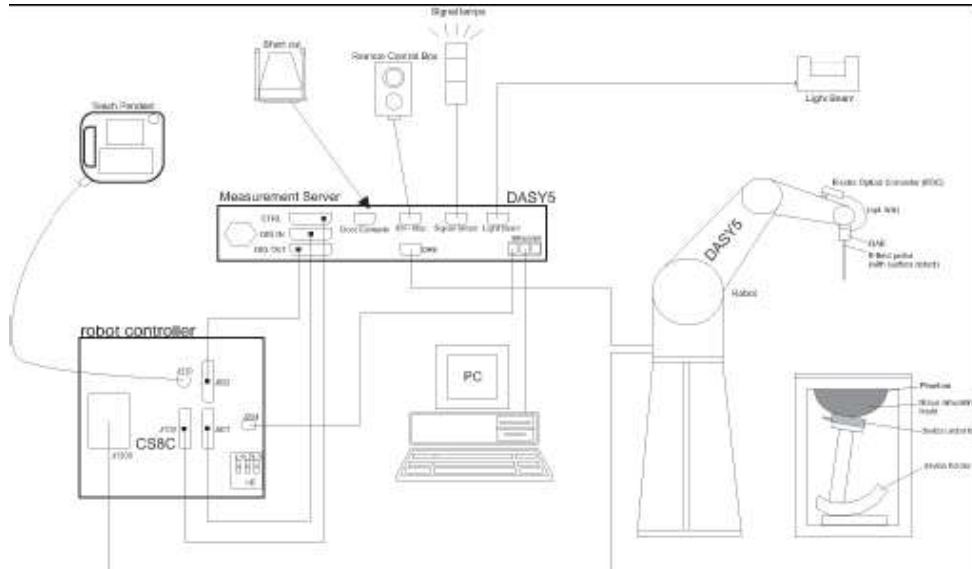

Picture C.1 SAR Lab Test Measurement Set-up

- A standard high precision 6-axis robot (Stäubli TX=RX family) with controller, teach pendant and software. An arm extension for accommodating the data acquisition electronics (DAE).
- An isotropic field probe optimized and calibrated for the targeted measurement.
- A data acquisition electronics (DAE) which performs the signal amplification, signal multiplexing, AD-conversion, offset measurements, mechanical surface detection, collision detection, etc. The unit is battery powered with standard or rechargeable batteries. The signal is optically transmitted to the EOC.
- The Electro-optical converter (EOC) performs the conversion from optical to electrical signals for the digital communication to the DAE. To use optical surface detection, a special version of the EOC is required. The EOC signal is transmitted to the measurement server.
- The function of the measurement server is to perform the time critical tasks such as signal filtering, control of the robot operation and fast movement interrupts.
- The Light Beam used is for probe alignment. This improves the (absolute) accuracy of the probe positioning.
- A computer running WinXP and the DASY5 software.
- Remote control and teach pendant as well as additional circuitry for robot safety such as
- warning lamps, etc.
- The phantom, the device holder and other accessories according to the targeted measurement.

## C.2. DASY5 E-field Probe System

The SAR measurements were conducted with the dosimetric probe designed in the classical triangular configuration and optimized for dosimetric evaluation. The probe is constructed using the thick film technique; with printed resistive lines on ceramic substrates. The probe is equipped with an optical multifiber line ending at the front of the probe tip. It is connected to the EOC box on the robot arm and provides an automatic detection of the phantom surface. Half of the fibers are connected to a pulsed infrared transmitter, the other half to a synchronized receiver. As the probe approaches the surface, the reflection from the surface produces a coupling from the transmitting to the receiving fibers. This reflection increases first during the approach, reaches maximum and then decreases. If the probe is flatly touching the surface, the coupling is zero. The distance of the coupling maximum to the surface is independent of the surface reflectivity and largely independent of the surface to probe angle. The DASY5 software reads the reflection during a software approach and looks for the maximum using 2<sup>nd</sup> order curve fitting. The approach is stopped at reaching the maximum.

### Probe Specifications:

<b>Model:</b>	ES3DV3, EX3DV4
<b>Frequency</b>	10MHz — 6.0GHz(EX3DV4)
<b>Range:</b>	10MHz — 4GHz(ES3DV3)
<b>Calibration:</b>	In head and body simulating tissue at Frequencies from 835 up to 5800MHz
<b>Linearity:</b>	± 0.2 dB(30 MHz to 6 GHz) for EX3DV4 ± 0.2 dB(30 MHz to 4 GHz) for ES3DV3
<b>Dynamic Range:</b>	10 mW/kg — 100W/kg
<b>Probe Length:</b>	330 mm
<b>Probe Tip</b>	
<b>Length:</b>	20 mm
<b>Body Diameter:</b>	12 mm
<b>Tip Diameter:</b>	2.5 mm (3.9 mm for ES3DV3)
<b>Tip-Center:</b>	1 mm (2.0mm for ES3DV3)
<b>Application:</b>	SAR Dosimetry Testing Compliance tests of mobile phones Dosimetry in strong gradient fields



Picture C.2 Near-field Probe



Picture C.3 E-field Probe

### C.3. E-field Probe Calibration

Each E-Probe/Probe Amplifier combination has unique calibration parameters. A TEM cell calibration procedure is conducted to determine the proper amplifier settings to enter in the probe parameters. The amplifier settings are determined for a given frequency by subjecting the probe to a known E-field density (1 mW/cm<sup>2</sup>) using an RF Signal generator, TEM cell, and RF Power Meter.

The free space E-field from amplified probe outputs is determined in a test chamber. This calibration can be performed in a TEM cell if the frequency is below 1 GHz and in a waveguide or other methodologies above 1 GHz for free space. For the free space calibration, the probe is placed in the volumetric center of the cavity and at the proper orientation with the field. The probe is then rotated 360 degrees until the three channels show the maximum reading. The power density readings equates to 1 mW/ cm<sup>2</sup>.

E-field temperature correlation calibration is performed in a flat phantom filled with the appropriate simulated brain tissue. The E-field in the medium correlates with the temperature rise in the dielectric medium. For temperature correlation calibration a RF transparent thermistor-based temperature probe is used in conjunction with the E-field probe.

$$SAR = C \frac{\Delta T}{\Delta t}$$

Where:

$\Delta t$  = Exposure time (30 seconds),

C = Heat capacity of tissue (brain or muscle),

$\Delta T$  = Temperature increase due to RF exposure.

$$SAR = \frac{|E|^2 \cdot \sigma}{\rho}$$

Where:

$\sigma$  = Simulated tissue conductivity,

$\rho$  = Tissue density (kg/m<sup>3</sup>).

## C.4. Other Test Equipment

### C.4.1. Data Acquisition Electronics (DAE)

The data acquisition electronics consist of a highly sensitive electrometer-grade preamplifier with auto-zeroing, a channel and gain-switching multiplexer, a fast 16 bit AD-converter and a command decoder with a control logic unit. Transmission to the measurement server is accomplished through an optical downlink for data and status information, as well as an optical uplink for commands and the clock.

The mechanical probe mounting device includes two different sensor systems for frontal and sideways probe contacts. They are used for mechanical surface detection and probe collision detection.

The input impedance of the DAE is 200 MOhm; the inputs are symmetrical and floating. Common mode rejection is above 80 dB.



PictureC.4: DAE

### C.4.2. Robot

The SPEAG DASY system uses the high precision robots (DASY5: RX160L) type from Stäubli SA (France). For the 6-axis controller system, the robot controller version from Stäubli is used. The Stäubli robot series have many features that are important for our application:

- High precision (repeatability 0.02mm)
- High reliability (industrial design)
- Low maintenance costs (virtually maintenance free due to direct drive gears; no belt drives)
- Jerk-free straight movements (brushless synchron motors; no stepper motors)
- Low ELF interference (motor control fields shielded via the closed metallic construction shields)



Picture C.5 DASY 5

### C.4.3. Measurement Server

The Measurement server is based on a PC/104 CPU board with CPU (DASY5: 400 MHz, Intel Celeron), chipdisk (DASY5:128MB), RAM (DASY5:128MB). The necessary circuits for communication with the DAE electronic box, as well as the 16 bit AD converter system for optical detection and digital I/O interface are contained on the DASY I/O board, which is directly connected to the PC/104 bus of the CPU board.

The measurement server performs all real-time data evaluation of field measurements and surface detection, controls robot movements and handles safety operation. The PC operating system cannot interfere with these time critical processes. All connections are supervised by a watchdog, and disconnection of any of the cables to the measurement server will automatically disarm the robot and disable all program-controlled robot movements. Furthermore, the measurement server is equipped with an expansion port which is reserved for future applications. Please note that this expansion port does not have a standardized pinout, and therefore only devices provided by SPEAG can be connected. Devices from any other supplier could seriously damage the measurement server.



Picture C.6 Server for DASY 5

### C.4.4. Device Holder for Phantom

The SAR in the phantom is approximately inversely proportional to the square of the distance between the source and the liquid surface. For a source at 5mm distance, a positioning uncertainty of  $\pm 0.5\text{mm}$  would produce a SAR uncertainty of  $\pm 20\%$ . Accurate device positioning is therefore crucial for accurate and repeatable measurements. The positions in which the devices must be measured are defined by the standards.

The DASY device holder is designed to cope with the different positions given in the standard. It has two scales for device rotation (with respect to the body axis) and device inclination (with respect to the line between the ear reference points). The rotation centers for both scales is the ear reference point (ERP). Thus the device needs no repositioning when changing the angles.

The DASY device holder is constructed of low-loss POM material having the following dielectric

parameters: relative permittivity  $\epsilon = 3$  and loss tangent  $\delta = 0.02$ . The amount of dielectric material has been reduced in the closest vicinity of the device, since measurements have suggested that the influence of the clamp on the test results could thus be lowered.

<Laptop Extension Kit>

The extension is lightweight and made of POM, acrylic glass and foam. It fits easily on the upper part of the Mounting Device in place of the phone positioner. The extension is fully compatible with the Twin-SAM and ELI phantoms.





Picture C.7-1: Device Holder

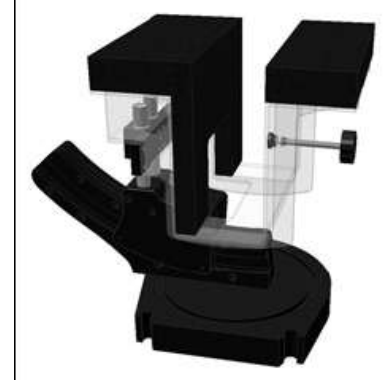

Picture C.7-2: Laptop Extension Kit

#### C.4.5. Phantom

The SAM Twin Phantom V4.0 is constructed of a fiberglass shell integrated in a table. The shape of the shell is based on data from an anatomical study designed to represent the 90<sup>th</sup> percentile of the population. The phantom enables the dissymmetric evaluation of SAR for both left and right handed handset usage, as well as body-worn usage using the flat phantom region. Reference markings on the Phantom allow the complete setup of all predefined phantom positions and measurement grids by manually teaching three points in the robot. The shell phantom has a 2mm shell thickness (except the ear region where shell thickness increases to 6 mm).

Shell Thickness:  $2 \pm 0.2$  mm

Filling Volume: Approx. 25 liters

Dimensions: 810 x 1000 x 500 mm (H x L x W)

Available: Special



Picture C.8: SAM Twin Phantom

## ANNEX D: Position of the wireless device in relation to the phantom

### D.1. General Considerations

This standard specifies two handset test positions against the head phantom – the “cheek” position and the “tilt” position.

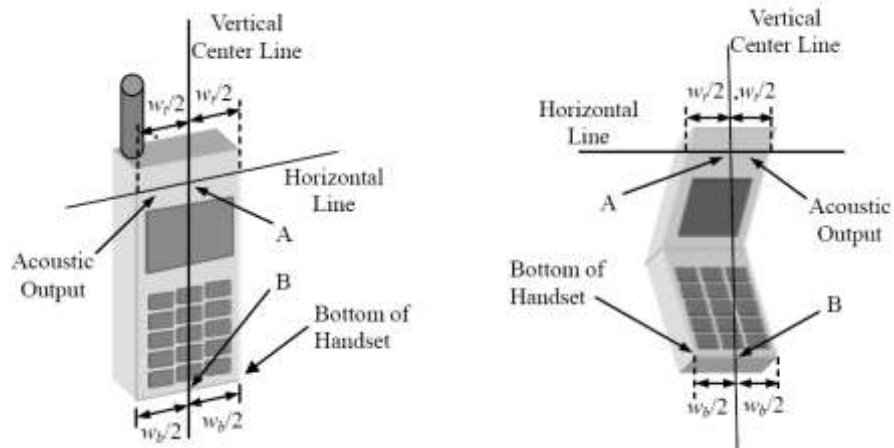

- $w_t$  Width of the handset at the level of the acoustic
- $w_b$  Width of the bottom of the handset
- A Midpoint of the width  $w_t$  of the handset at the level of the acoustic output
- B Midpoint of the width  $w_b$  of the bottom of the handset

Picture D.1-a Typical “fixed” case handset      Picture D.1-b Typical “clam-shell” case handset

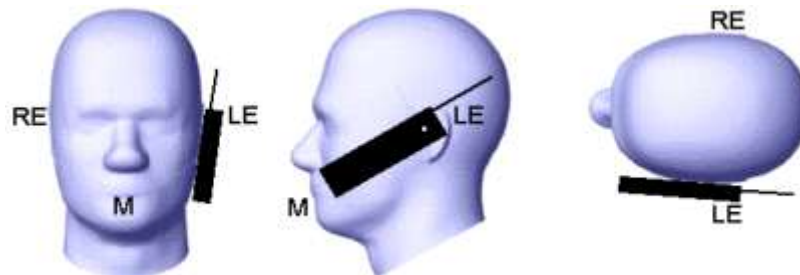

Picture D.2 Cheek position of the wireless device on the left side of SAM

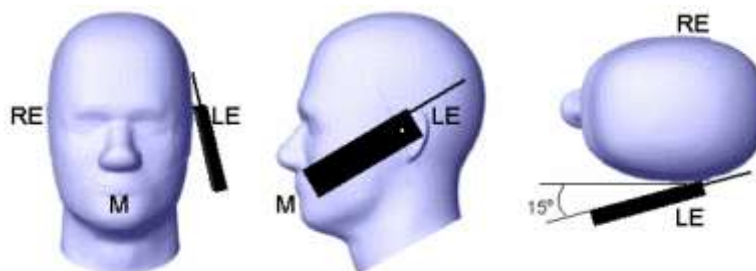

Picture D.3 Tilt position of the wireless device on the left side of SAM

## D.2. Body-worn device

A typical example of a body-worn device is a mobile phone, wireless enabled PDA or other battery operated wireless device with the ability to transmit while mounted on a person's body using a carry accessory approved by the wireless device manufacturer.

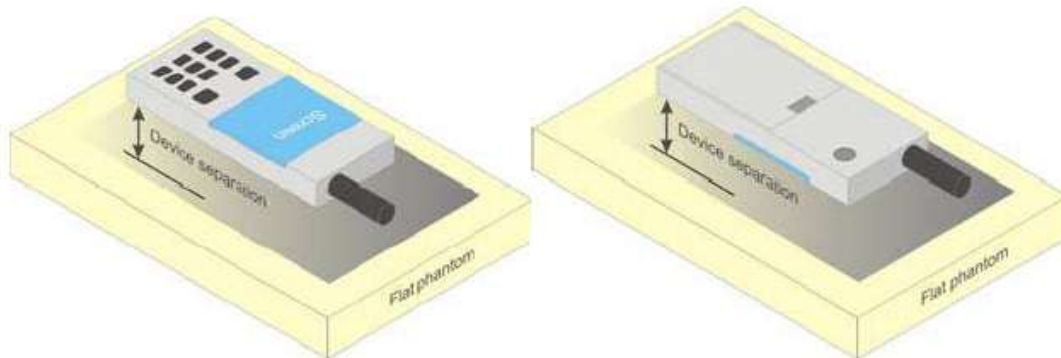

**Picture D.4 Test positions for body-worn devices**

## D.3. Desktop device

A typical example of a desktop device is a wireless enabled desktop computer placed on a table or desk when used.

The DUT shall be positioned at the distance and in the orientation to the phantom that corresponds to the intended use as specified by the manufacturer in the user instructions. For devices that employ an external antenna with variable positions, tests shall be performed for all antenna positions specified. Picture 8.5 show positions for desktop device SAR tests. If the intended use is not specified, the device shall be tested directly against the flat phantom.

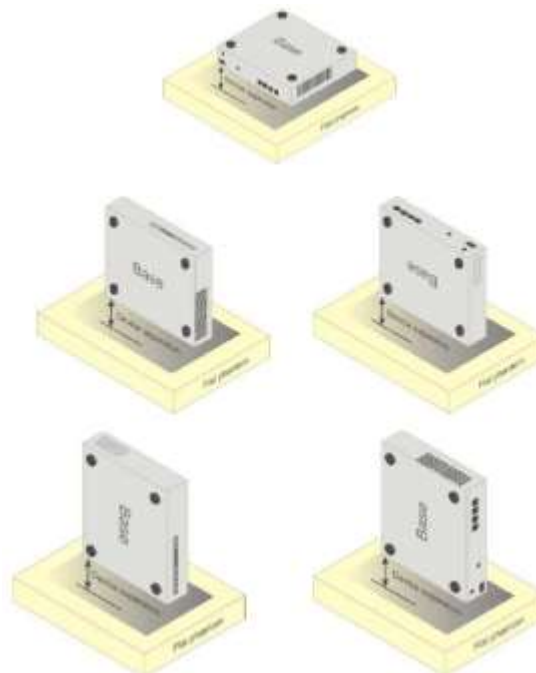

**Picture D.5 Test positions for desktop devices**

#### D.4. DUT Setup Photos



Picture D.6

## ANNEX E: Equivalent Media Recipes

The liquid used for the frequency range of 700-6000 MHz consisted of water, sugar, salt, preventol, glycol monobutyl and Cellulose. The liquid has been previously proven to be suited for worst-case. The Table E.1 shows the detail solution. It's satisfying the latest tissue dielectric parameters requirements proposed by the IEEE 1528 and IEC 62209.

**Table E.1: Composition of the Tissue Equivalent Matter**

Frequency (MHz)	835 Head	835 Body	1900 Head	1900 Body	2450 Head	2450 Body	5800 Head	5800 Body
Ingredients (% by weight)								
Water	41.45	52.5	55.242	69.91	58.79	72.60	65.53	65.53
Sugar	56.0	45.0	\	\	\	\	\	\
Salt	1.45	1.4	0.306	0.13	0.06	0.18	\	\
Preventol	0.1	0.1	\	\	\	\	\	\
Cellulose	1.0	1.0	\	\	\	\	\	\
Glycol Monobutyl	\	\	44.452	29.96	41.15	27.22	\	\
Diethylenglycol monohexylether	\	\	\	\	\	\	17.24	17.24
Triton X-100	\	\	\	\	\	\	17.24	17.24
Dielectric Parameters Target Value	$\epsilon=41.5$ $\sigma=0.90$	$\epsilon=55.2$ $\sigma=0.97$	$\epsilon=40.0$ $\sigma=1.40$	$\epsilon=53.3$ $\sigma=1.52$	$\epsilon=39.2$ $\sigma=1.80$	$\epsilon=52.7$ $\sigma=1.95$	$\epsilon=35.3$ $\sigma=5.27$	$\epsilon=48.2$ $\sigma=6.00$

**Note: There is a little adjustment respectively for 750, 1800, 2600, 5200, 5300, and 5600, based on the recipe of closest frequency in table E.1**

## ANNEX F: System Validation

The SAR system must be validated against its performance specifications before it is deployed. When SAR probes, system components or software are changed, upgraded or recalibrated, these must be validated with the SAR system(s) that operates with such components.

**Table F.1: System Validation**

Probe SN.	Liquid name	Validation date	Frequency point	Status (OK or Not)
3633	Head 750MHz	2020-04-03	750 MHz	OK
3633	Head 835MHz	2020-04-03	835 MHz	OK
3633	Head 1750MHz	2020-04-03	1750 MHz	OK
3633	Head 1900MHz	2020-04-03	1900 MHz	OK
3633	Head 2300MHz	2020-04-04	2300 MHz	OK
3633	Head 2450MHz	2020-04-04	2450 MHz	OK
3633	Head 2550MHz	2020-04-04	2550 MHz	OK
3633	Head 5200MHz	2020-04-05	5250 MHz	OK
3633	Head 5600MHz	2020-04-05	5600 MHz	OK
3633	Head 5750MHz	2020-04-05	5750 MHz	OK

## ANNEX G: LTE Band 41 Power Class 2 and Power Class 3 Linearity

This device supports Power Class 2 and Power Class 3 operations for LTE Band 41. The highest available duty cycle for Power Class 2 operations is 43.3 % using UL-DL configuration 1. Per May 2017 TCB Workshop Notes based on the device behavior, all SAR tests were performed using Power Class 3. SAR with Power Class 2 at the highest power and available duty factor was additionally performed for the Power Class 3 configuration with the highest SAR for each exposure condition. The linearity between the Power Class 2 and Power Class 3 SAR results and the respective frame averaged powers was calculated to determine that the results were linear. When ULCA is active, the device does not supports Power Class 2. Per May 2017 TCB Workshop, no additional SAR measurements were required since the linearity between power classes was < 10% and all reported SAR values were < 1.4 W/kg for 1g and < 3.5 W/kg for 10g.

LTE Band 41 SAR testing with power class 2 at the highest power and available duty factor was additionally performed for the power class 3 configuration with the highest SAR for each exposure condition.

**Table G.1 LTE Band 41 Single Carrier Head Linearity Data**

/	LTE Band 41 PC3	LTE Band 41 PC2
Maximum Tune up Power (dBm)	24.5	27.0
Reported 1g SAR (W/kg)	0.24	0.31
Duty Cycle	63.30%	43.30%
Frame Averaged (mW)	178.40	217.01
Linearity SAR (W/kg)	0.292	/
% deviation from expected linearity	/	6.19%

**Table G.2 LTE Band 41 Single Carrier Hotspot Linearity Data**

/	LTE Band 41 PC3	LTE Band 41 PC2
Maximum Tune up Power (dBm)	20.5	20.5
Reported 1g SAR (W/kg)	0.74	0.49
Duty Cycle	63.30%	43.30%
Frame Averaged (mW)	71.02	48.58
Linearity SAR (W/kg)	0.506	/
% deviation from expected linearity	/	-3.20%

**Table G.3 LTE Band 41 Single Carrier Body-Worn Linearity Data**

/	LTE Band 41 PC3	LTE Band 41 PC2
Maximum Tune up Power (dBm)	24.5	27.0
Reported 1g SAR (W/kg)	0.86	1.06
Duty Cycle	63.30%	43.30%
Frame Averaged (mW)	178.40	217.01
Linearity SAR (W/kg)	1.046	/
% deviation from expected linearity	/	1.33%





# ANNEX H: DAE Calibration Certificate

## DAE4 SN: 786 Calibration Certificate



Add: No.51 Xueyuan Road, Haidian District, Beijing, 100191, China  
Tel: +86-10-62304633-2512 Fax: +86-10-62304633-2504  
E-mail: cttl@chinattl.com <http://www.chinattl.cn>



中国认可  
国际互认  
校准  
CALIBRATION  
CNAS L0570

Client : CTTL(South Branch)

Certificate No: Z20-60101

### CALIBRATION CERTIFICATE

Object: DAE4 - SN: 786

Calibration Procedure(s): FF-Z11-002-01  
Calibration Procedure for the Data Acquisition Electronics (DAEx)

Calibration date: March 03, 2020

This calibration Certificate documents the traceability to national standards, which realize the physical units of measurements(SI). The measurements and the uncertainties with confidence probability are given on the following pages and are part of the certificate.

All calibrations have been conducted in the closed laboratory facility; environment temperature(22±3)°C and humidity<70%.

Calibration Equipment used (M&TE critical for calibration)

Primary Standards	ID #	Cal Date(Calibrated by, Certificate No.)	Scheduled Calibration
Process Calibrator 753	1971018	24-Jun-19 (CTTL, No.J19X05126)	Jun-20

	Name	Function	Signature
Calibrated by:	Yu Zongying	SAR Test Engineer	
Reviewed by:	Lin Hao	SAR Test Engineer	
Approved by:	Qi Diaryuan	SAR Project Leader	

Issued: March 05, 2020

This calibration certificate shall not be reproduced except in full without written approval of the laboratory.



Add: No.51 Xueyuan Road, Haidian District, Beijing, 100191, China  
Tel: +86-10-62304633-2512 Fax: +86-10-62304633-2504  
E-mail: cttl@chinattl.com Http://www.chinattl.cn

**Glossary:**

DAE data acquisition electronics  
Connector angle information used in DASY system to align probe sensor X to the robot coordinate system.

**Methods Applied and Interpretation of Parameters:**

- *DC Voltage Measurement:* Calibration Factor assessed for use in DASY system by comparison with a calibrated instrument traceable to national standards. The figure given corresponds to the full scale range of the voltmeter in the respective range.
- *Connector angle:* The angle of the connector is assessed measuring the angle mechanically by a tool inserted. Uncertainty is not required.
- The report provide only calibration results for DAE, it does not contain other performance test results.



Add: No.51 Xueyuan Road, Haidian District, Beijing, 100191, China
Tel: +86-10-62304633-2512 Fax: +86-10-62304633-2504
E-mail: cctl@chinaatl.com Http://www.chinaatl.cn

DC Voltage Measurement

A/D - Converter Resolution nominal
High Range: 1LSB = 6.1µV ; full range = -100...+300 mV
Low Range: 1LSB = 61nV ; full range = -1.....+3mV
DASY measurement parameters: Auto Zero Time: 3 sec; Measuring time: 3 sec

Table with 4 columns: Calibration Factors, X, Y, Z. Rows include High Range and Low Range with numerical values and error percentages.

Connector Angle

Table with 2 columns: Connector Angle to be used in DASY system, 229.5° ± 1°





# ANNEX I: Probe Calibration Certificate

## Probe EX3DV4-SN: 3633 Calibration Certificate



In Collaboration with  
**s p e a g**  
CALIBRATION LABORATORY

Add: No.51 Xueyuan Road, Haidian District, Beijing, 100191, China  
Tel: +86-10-62304633-2512 Fax: +86-10-62304633-2504  
E-mail: cctl@chinattl.com <http://www.chinattl.cn>

中国认可  
国际互认  
校准  
CALIBRATION  
CNAS L0570

Client **CTTL(South Branch)** Certificate No: **Z20-60108**

### CALIBRATION CERTIFICATE

Object: **EX3DV4 - SN : 3633**

Calibration Procedure(s): **FF-Z11-004-01  
Calibration Procedures for Dosimetric E-field Probes**

Calibration date: **April 01, 2020**

This calibration Certificate documents the traceability to national standards, which realize the physical units of measurements(SI). The measurements and the uncertainties with confidence probability are given on the following pages and are part of the certificate.



All calibrations have been conducted in the closed laboratory facility: environment temperature(22±3)℃ and humidity<70%.

Calibration Equipment used (M&TE critical for calibration)

Primary Standards	ID #	Cal Date(Calibrated by, Certificate No.)	Scheduled Calibration
Power Meter NRP2	101919	18-Jun-19(CTTL, No.J19X05125)	Jun-20
Power sensor NRP-Z91	101547	18-Jun-19(CTTL, No.J19X05125)	Jun-20
Power sensor NRP-Z91	101548	18-Jun-19(CTTL, No.J19X05125)	Jun-20
Reference 10dBAttenuator	18N50W-10dB	10-Feb-20(CTTL, No.J20X00525)	Feb-22
Reference 20dBAttenuator	18N50W-20dB	10-Feb-20(CTTL, No.J20X00526)	Feb-22
Reference Probe EX3DV4	SN 7307	24-May-19(SPEAG, No.EX3-7307_May19/2)	May-20
DAE4	SN 1525	26-Aug-19(SPEAG, No.DAE4-1525_Aug19)	Aug-20

Secondary Standards	ID #	Cal Date(Calibrated by, Certificate No.)	Scheduled Calibration
SignalGenerator MG3700A	6201052605	18-Jun-19(CTTL, No.J19X05127)	Jun-20
Network Analyzer E5071C	MY46110673	10-Feb-20(CTTL, No.J20X00515)	Feb-21

	Name	Function	Signature
Calibrated by:	Yu Zongying	SAR Test Engineer	
Reviewed by:	Lin Hao	SAR Test Engineer	
Approved by:	Qi Dianyuan	SAR Project Leader	

Issued: April 03, 2020

This calibration certificate shall not be reproduced except in full without written approval of the laboratory.

Certificate No: Z20-60108

Page 1 of 10



Add: No.51 Xueyuan Road, Haidian District, Beijing, 100191, China  
 Tel: +86-10-62304633-2512 Fax: +86-10-62304633-2504  
 E-mail: cti1@chinattl.com <http://www.chinattl.cn>

#### Glossary:

TSL	tissue simulating liquid
NORM <sub>x,y,z</sub>	sensitivity in free space
ConvF	sensitivity in TSL / NORM <sub>x,y,z</sub>
DCP	diode compression point
CF	crest factor (1/duty_cycle) of the RF signal
A, B, C, D	modulation dependent linearization parameters
Polarization $\Phi$	$\Phi$ rotation around probe axis
Polarization $\theta$	$\theta$ rotation around an axis that is in the plane normal to probe axis (at measurement center), $\theta=0$ is normal to probe axis

Connector Angle information used in DASY system to align probe sensor X to the robot coordinate system

#### Calibration is Performed According to the Following Standards:

- IEEE Std 1528-2013, "IEEE Recommended Practice for Determining the Peak Spatial-Averaged Specific Absorption Rate (SAR) in the Human Head from Wireless Communications Devices: Measurement Techniques", June 2013
- IEC 62209-1, "Measurement procedure for the assessment of Specific Absorption Rate (SAR) from hand-held and body-mounted devices used next to the ear (frequency range of 300 MHz to 6 GHz)", July 2016
- IEC 62209-2, "Procedure to determine the Specific Absorption Rate (SAR) for wireless communication devices used in close proximity to the human body (frequency range of 30 MHz to 6 GHz)", March 2010
- KDB 865664, "SAR Measurement Requirements for 100 MHz to 6 GHz"

#### Methods Applied and Interpretation of Parameters:

- NORM<sub>x,y,z</sub>:** Assessed for E-field polarization  $\theta=0$  ( $f \leq 900\text{MHz}$  in TEM-cell;  $f > 1800\text{MHz}$ ; waveguide). NORM<sub>x,y,z</sub> are only intermediate values, i.e., the uncertainties of NORM<sub>x,y,z</sub> does not effect the  $E^2$ -field uncertainty inside TSL (see below ConvF).
- NORM(f)<sub>x,y,z</sub> = NORM<sub>x,y,z</sub> \* frequency\_response** (see Frequency Response Chart). This linearization is implemented in DASY4 software versions later than 4.2. The uncertainty of the frequency response is included in the stated uncertainty of ConvF.
- DCP<sub>x,y,z</sub>:** DCP are numerical linearization parameters assessed based on the data of power sweep (no uncertainty required). DCP does not depend on frequency nor media.
- PAR:** PAR is the Peak to Average Ratio that is not calibrated but determined based on the signal characteristics.
- A<sub>x,y,z</sub>; B<sub>x,y,z</sub>; C<sub>x,y,z</sub>; VR<sub>x,y,z</sub>; A, B, C** are numerical linearization parameters assessed based on the data of power sweep for specific modulation signal. The parameters do not depend on frequency nor media. VR is the maximum calibration range expressed in RMS voltage across the diode.
- ConvF and Boundary Effect Parameters:** Assessed in flat phantom using E-field (or Temperature Transfer Standard for  $f \leq 800\text{MHz}$ ) and inside waveguide using analytical field distributions based on power measurements for  $f > 800\text{MHz}$ . The same setups are used for assessment of the parameters applied for boundary compensation (alpha, depth) of which typical uncertainty valued are given. These parameters are used in DASY4 software to improve probe accuracy close to the boundary. The sensitivity in TSL corresponds to NORM<sub>x,y,z</sub> \* ConvF whereby the uncertainty corresponds to that given for ConvF. A frequency dependent ConvF is used in DASY version 4.4 and higher which allows extending the validity from  $\pm 50\text{MHz}$  to  $\pm 100\text{MHz}$ .
- Spherical isotropy (3D deviation from isotropy):** in a field of low gradients realized using a flat phantom exposed by a patch antenna.
- Sensor Offset:** The sensor offset corresponds to the offset of virtual measurement center from the probe tip (on probe axis). No tolerance required.
- Connector Angle:** The angle is assessed using the information gained by determining the NORM<sub>x</sub> (no uncertainty required).



Add: No.51 Xueyuan Road, Haidian District, Beijing, 100191, China.  
 Tel: +86-10-62304633-2512 Fax: +86-10-62304633-2504  
 E-mail: cti@chinattl.com <http://www.chinattl.cn>

## DASY/EASY – Parameters of Probe: EX3DV4 – SN:3633

### Basic Calibration Parameters

	Sensor X	Sensor Y	Sensor Z	Unc (k=2)
Norm( $\mu\text{V}/(\text{V}/\text{m})^2$ ) <sup>A</sup>	0.37	0.37	0.39	±10.0%
DCP(mV) <sup>B</sup>	98.2	98.8	98.0	

### Modulation Calibration Parameters

UID	Communication System Name		A dB	B dB· $\mu\text{V}$	C	D dB	VR mV	Unc <sup>E</sup> (k=2)
0	CW	X	0.0	0.0	1.0	0.00	141.5	±2.3%
		Y	0.0	0.0	1.0		141.5	
		Z	0.0	0.0	1.0		141.9	

The reported uncertainty of measurement is stated as the standard uncertainty of Measurement multiplied by the coverage factor k=2, which for a normal distribution Corresponds to a coverage probability of approximately 95%.

- <sup>A</sup> The uncertainties of Norm X, Y, Z do not affect the E<sup>2</sup>-field uncertainty inside TSL (see Page 4 and Page 5).  
<sup>B</sup> Numerical linearization parameter: uncertainty not required.  
<sup>E</sup> Uncertainty is determined using the max. deviation from linear response applying rectangular distribution and is expressed for the square of the field value.



Add: No.51 Xueyuan Road, Haidian District, Beijing, 100191, China  
 Tel: +86-10-62304633-2512 Fax: +86-10-62304633-2504  
 E-mail: cttl@chinattl.com [Http://www.chinattl.cn](http://www.chinattl.cn)

## DASY/EASY – Parameters of Probe: EX3DV4 – SN: 3633

### Calibration Parameter Determined in Head Tissue Simulating Media

f [MHz] <sup>C</sup>	Relative Permittivity <sup>F</sup>	Conductivity (S/m) <sup>F</sup>	ConvF X	ConvF Y	ConvF Z	Alpha <sup>G</sup>	Depth <sup>G</sup> (mm)	Unct. (k=2)
750	41.9	0.89	9.59	9.59	9.59	0.40	0.75	±12.1%
900	41.5	0.97	9.33	9.33	9.33	0.21	1.14	±12.1%
1640	40.3	1.29	8.17	8.17	8.17	0.16	1.22	±12.1%
1750	40.1	1.37	8.09	8.09	8.09	0.15	1.42	±12.1%
1900	40.0	1.40	7.76	7.76	7.76	0.19	1.14	±12.1%
2100	39.8	1.49	7.73	7.73	7.73	0.18	1.26	±12.1%
2300	39.5	1.67	7.69	7.69	7.69	0.48	0.78	±12.1%
2450	39.2	1.80	7.43	7.43	7.43	0.50	0.77	±12.1%
2600	39.0	1.96	7.20	7.20	7.20	0.58	0.72	±12.1%
3500	37.9	2.91	6.88	6.88	6.88	0.35	1.23	±13.3%
3700	37.7	3.12	6.57	6.57	6.57	0.44	0.98	±13.3%
3900	37.5	3.32	6.51	6.51	6.51	0.35	1.40	±13.3%
4100	37.2	3.53	6.44	6.44	6.44	0.40	1.20	±13.3%
4400	36.9	3.84	6.30	6.30	6.30	0.35	1.35	±13.3%
4600	36.7	4.04	6.10	6.10	6.10	0.45	1.40	±13.3%
4800	36.4	4.25	5.98	5.98	5.98	0.45	1.60	±13.3%
4950	36.3	4.40	5.80	5.80	5.80	0.45	1.45	±13.3%
5250	35.9	4.71	5.47	5.47	5.47	0.45	1.25	±13.3%
5600	35.5	5.07	4.72	4.72	4.72	0.45	1.50	±13.3%
5750	35.4	5.22	4.73	4.73	4.73	0.45	1.50	±13.3%

<sup>C</sup> Frequency validity above 300 MHz of ±100MHz only applies for DASY v4.4 and higher (Page 2), else it is restricted to ±50MHz. The uncertainty is the RSS of ConvF uncertainty at calibration frequency and the uncertainty for the indicated frequency band. Frequency validity below 300 MHz is ± 10, 25, 40, 50 and 70 MHz for ConvF assessments at 30, 64, 128, 150 and 220 MHz respectively. Above 5 GHz frequency validity can be extended to ± 110 MHz.

<sup>F</sup> At frequency below 3 GHz, the validity of tissue parameters ( $\epsilon$  and  $\sigma$ ) can be relaxed to ±10% if liquid compensation formula is applied to measured SAR values. At frequencies above 3 GHz, the validity of tissue parameters ( $\epsilon$  and  $\sigma$ ) is restricted to ±5%. The uncertainty is the RSS of the ConvF uncertainty for indicated target tissue parameters.

<sup>G</sup> Alpha/Depth are determined during calibration. SPEAG warrants that the remaining deviation due to the boundary effect after compensation is always less than ± 1% for frequencies below 3 GHz and below ± 2% for the frequencies between 3-6 GHz at any distance larger than half the probe tip diameter from the boundary.



In Collaboration with  
**TTL** **s p e a g**  
 CALIBRATION LABORATORY  
 Add: No.51 Xueyuan Road, Haidian District, Beijing, 100191, China  
 Tel: +86-10-62304633-2512 Fax: +86-10-62304633-2504  
 E-mail: [cttl@chinattl.com](mailto:cttl@chinattl.com) <http://www.chinattl.cn>

## DASY/EASY – Parameters of Probe: EX3DV4 – SN: 3633

### Calibration Parameter Determined in Body Tissue Simulating Media

f [MHz] <sup>C</sup>	Relative Permittivity <sup>F</sup>	Conductivity (S/m) <sup>F</sup>	ConvF X	ConvF Y	ConvF Z	Alpha <sup>G</sup>	Depth <sup>G</sup> (mm)	Unct. (k=2)
750	55.5	0.96	9.57	9.57	9.57	0.40	0.80	±12.1%
900	55.0	1.05	9.34	9.34	9.34	0.25	1.11	±12.1%
1640	53.8	1.40	8.05	8.05	8.05	0.22	1.19	±12.1%
1750	53.4	1.49	7.85	7.85	7.85	0.16	1.35	±12.1%
1900	53.3	1.52	7.66	7.66	7.66	0.17	1.32	±12.1%
2100	53.2	1.62	7.69	7.69	7.69	0.21	1.30	±12.1%
2300	52.9	1.81	7.61	7.61	7.61	0.50	0.86	±12.1%
2450	52.7	1.95	7.56	7.56	7.56	0.50	0.83	±12.1%
2600	52.5	2.16	7.33	7.33	7.33	0.59	0.74	±12.1%
3500	52.3	3.31	6.28	6.28	6.28	0.40	1.30	±13.3%
3700	52.1	3.55	6.14	6.14	6.14	0.40	1.35	±13.3%
3900	50.8	3.78	6.13	6.13	6.13	0.40	1.45	±13.3%
4100	50.5	4.01	6.12	6.12	6.12	0.35	1.40	±13.3%
4400	50.1	4.37	5.93	5.93	5.93	0.35	1.70	±13.3%
4600	49.8	4.60	5.60	5.60	5.60	0.45	1.50	±13.3%
4800	49.6	4.83	5.42	5.42	5.42	0.45	1.60	±13.3%
4950	49.4	5.01	5.22	5.22	5.22	0.45	1.70	±13.3%
5250	48.9	5.36	5.04	5.04	5.04	0.50	1.45	±13.3%
5600	48.5	5.77	4.16	4.16	4.16	0.55	1.50	±13.3%
5750	48.3	5.94	4.26	4.26	4.26	0.55	1.60	±13.3%

<sup>C</sup> Frequency validity above 300 MHz of ±100MHz only applies for DASY v4.4 and higher (Page 2), else it is restricted to ±50MHz. The uncertainty is the RSS of ConvF uncertainty at calibration frequency and the uncertainty for the indicated frequency band. Frequency validity below 300 MHz is ± 10, 25, 40, 50 and 70 MHz for ConvF assessments at 30, 54, 128, 150 and 220 MHz respectively. Above 5 GHz frequency validity can be extended to ± 110 MHz.

<sup>F</sup> At frequency below 3 GHz, the validity of tissue parameters ( $\epsilon$  and  $\sigma$ ) can be relaxed to ±10% if liquid compensation formula is applied to measured SAR values. At frequencies above 3 GHz, the validity of tissue parameters ( $\epsilon$  and  $\sigma$ ) is restricted to ±5%. The uncertainty is the RSS of the ConvF uncertainty for indicated target tissue parameters.

<sup>G</sup> Alpha/Depth are determined during calibration. SPEAG warrants that the remaining deviation due to the boundary effect after compensation is always less than ± 1% for frequencies below 3 GHz and below ± 2% for the frequencies between 3-6 GHz at any distance larger than half the probe tip diameter from the boundary.





Add: No.51 Xueyuan Road, Haidian District, Beijing, 100191, China  
Tel: +86-10-62304633-2512 Fax: +86-10-62304633-2504  
E-mail: ttl@chinattl.com <http://www.chinattl.cn>

### Frequency Response of E-Field (TEM-Cell: ifi110 EXX, Waveguide: R22)

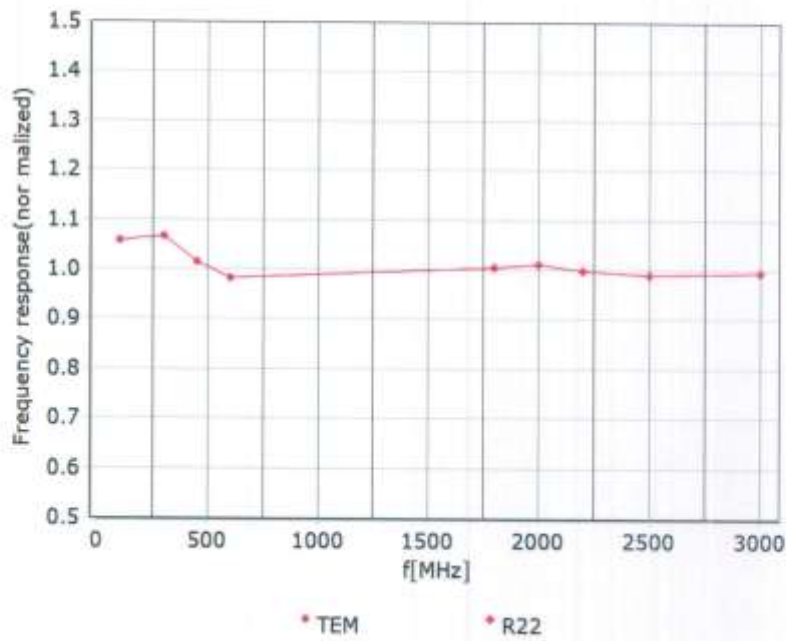

Uncertainty of Frequency Response of E-field:  $\pm 7.4\%$  (k=2)



Add: No.51 Xueyuan Road, Haidian District, Beijing, 100191, China  
 Tel: +86-10-62304633-2512 Fax: +86-10-62304633-2504  
 E-mail: ttl@chinatti.com <http://www.chinatti.cn>

### Receiving Pattern ( $\Phi$ ), $\theta=0^\circ$

**f=600 MHz, TEM**

**f=1800 MHz, R22**

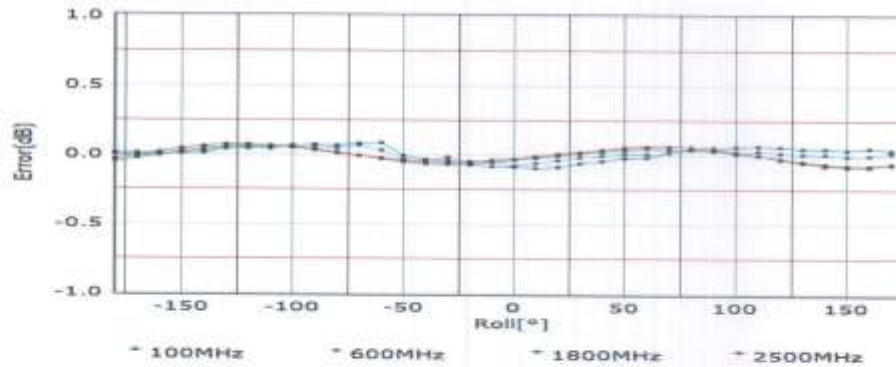
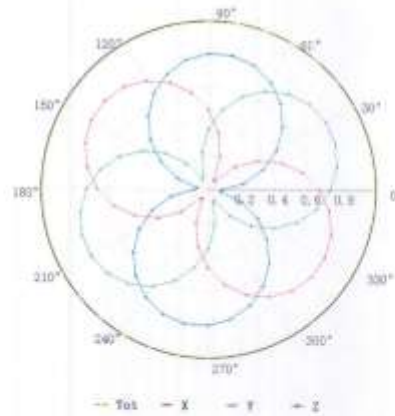
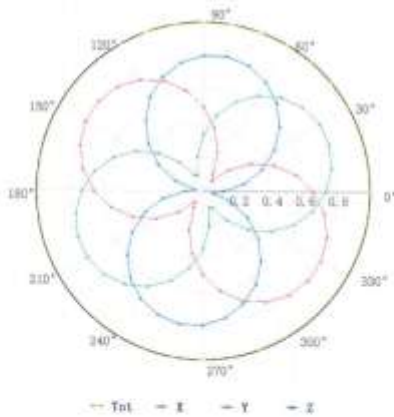

Uncertainty of Axial Isotropy Assessment:  $\pm 1.2\%$  ( $k=2$ )



Add: No.51 Xueyun Road, Haidian District, Beijing, 100191, China  
 Tel: +86-10-62304633-2512 Fax: +86-10-62304633-2504  
 E-mail: cttl@chinattl.com <http://www.chinattl.cn>

### Dynamic Range f(SAR<sub>head</sub>) (TEM cell, f = 900 MHz)

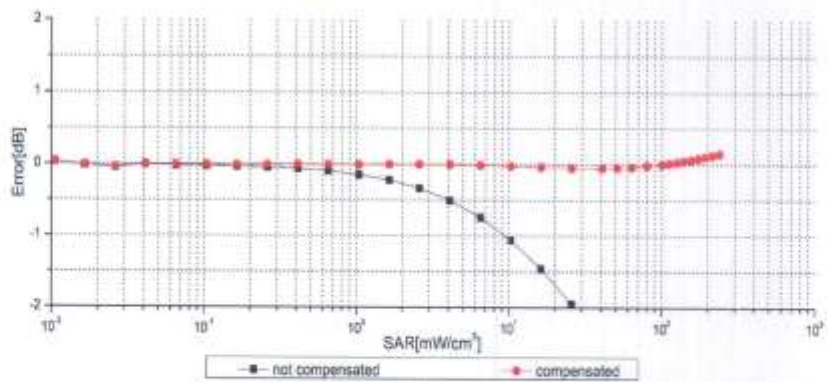
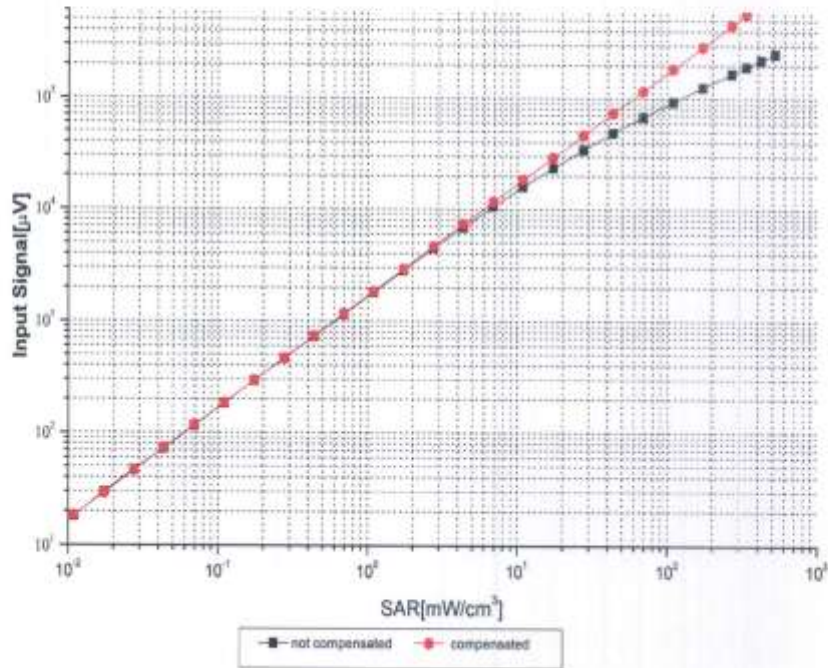

Uncertainty of Linearity Assessment: ±0.9% (k=2)



In Collaboration with  
 Add: No.51 Xueyuan Road, Haidian District, Beijing, 100191, China  
 Tel: +86-10-62304633-2512 Fax: +86-10-62304633-2504  
 E-mail: cttl@chinattl.com [Http://www.chinattl.cn](http://www.chinattl.cn)

### Conversion Factor Assessment

f=750 MHz,WGLS R9(H\_convF)

f=1750 MHz,WGLS R22(H\_convF)

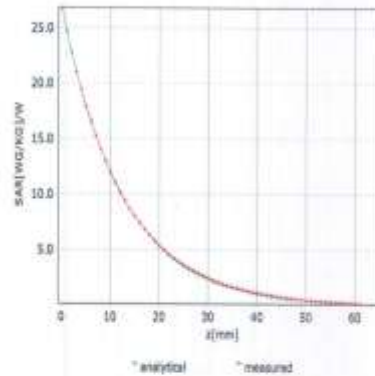
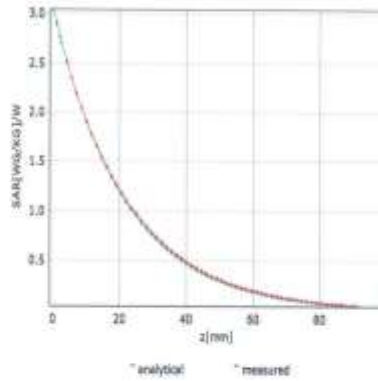

### Deviation from Isotropy in Liquid

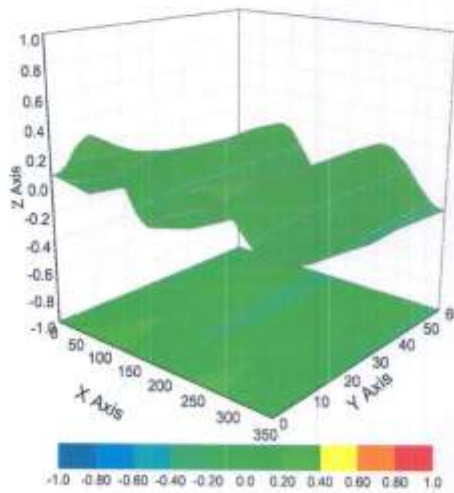

Uncertainty of Spherical Isotropy Assessment:  $\pm 3.2\%$  (K=2)



Add: No.51 Xueyuan Road, Haidian District, Beijing, 100191, China  
Tel: +86-10-62304633-2512 Fax: +86-10-62304633-2504  
E-mail: ctdl@chinatl.com [Http://www.chinatl.cn](http://www.chinatl.cn)

## DASY/EASY – Parameters of Probe: EX3DV4 – SN:3633

### Other Probe Parameters

Sensor Arrangement	Triangular
Connector Angle (°)	71.2
Mechanical Surface Detection Mode	enabled
Optical Surface Detection Mode	disable
Probe Overall Length	337mm
Probe Body Diameter	10mm
Tip Length	10mm
Tip Diameter	2.5mm
Probe Tip to Sensor X Calibration Point	1mm
Probe Tip to Sensor Y Calibration Point	1mm
Probe Tip to Sensor Z Calibration Point	1mm
Recommended Measurement Distance from Surface	1.4mm



# ANNEX J: Dipole Calibration Certificate

## 750 MHz Dipole Calibration Certificate



In Collaboration with  
**s p e a g**  
CALIBRATION LABORATORY



中国认可  
国际互认  
校准  
CALIBRATION  
CNAS L0570

Add: No.51 Xueyuan Road, Haidian District, Beijing, 100191, China  
Tel: +86-10-62304633-2079 Fax: +86-10-62304633-2504  
E-mail: ttl@chinattl.com http://www.chinattl.cn

Client **CTTL(South Branch)**Certificate No: **Z19-60291**

### CALIBRATION CERTIFICATE

Object: **D750V3 - SN: 1163**

Calibration Procedure(s): **FF-Z11-003-01**  
**Calibration Procedures for dipole validation kits**

Calibration date: **September 3, 2019**

This calibration Certificate documents the traceability to national standards, which realize the physical units of measurements(SI). The measurements and the uncertainties with confidence probability are given on the following pages and are part of the certificate.

All calibrations have been conducted in the closed laboratory facility; environment temperature(22±3)°C and humidity<70%.

Calibration Equipment used (M&TE critical for calibration)

Primary Standards	ID #	Cal Date(Calibrated by, Certificate No.)	Scheduled Calibration
Power Meter NRP2	106276	11-Apr-19 (CTTL, No.J19X02605)	Apr-20
Power sensor NRP6A	101369	11-Apr-19 (CTTL, No.J19X02605)	Apr-20
Reference Probe EX3DV4	SN 3617	31-Jan-19(SPEAG,No.EX3-3617_Jan19)	Jan-20
DAE4	SN 1555	22-Aug-19(CTTL-SPEAG,No.Z19-60295)	Aug-20
Secondary Standards	ID #	Cal Date(Calibrated by, Certificate No.)	Scheduled Calibration
Signal Generator E4438C	MY49071430	23-Jan-19 (CTTL, No.J19X00336)	Jan-20
NetworkAnalyzer E5071C	MY46110673	24-Jan-19 (CTTL, No.J19X00547)	Jan-20

	Name	Function	Signature
Calibrated by:	Zhao Jing	SAR Test Engineer	
Reviewed by:	Lin Hao	SAR Test Engineer	
Approved by:	Qi Dianyuan	SAR Project Leader	

Issued: September 6, 2019

This calibration certificate shall not be reproduced except in full without written approval of the laboratory.



Add: No.51 Xueyuan Road, Haidian District, Beijing, 100191, China  
Tel: +86-10-62304633-2079 Fax: +86-10-62304633-2504  
E-mail: cttf@chinattl.com http://www.chinattl.cn

**Glossary:**

TSL	tissue simulating liquid
ConvF	sensitivity in TSL / NORM <sub>x,y,z</sub>
N/A	not applicable or not measured

**Calibration is Performed According to the Following Standards:**

- IEEE Std 1528-2013, "IEEE Recommended Practice for Determining the Peak Spatial-Averaged Specific Absorption Rate (SAR) in the Human Head from Wireless Communications Devices: Measurement Techniques", June 2013
- IEC 62209-1, "Measurement procedure for assessment of specific absorption rate of human exposure to radio frequency fields from hand-held and body-mounted wireless communication devices- Part 1: Device used next to the ear (Frequency range of 300MHz to 6GHz)", July 2016
- IEC 62209-2, "Procedure to measure the Specific Absorption Rate (SAR) For wireless communication devices used in close proximity to the human body (frequency range of 30MHz to 6GHz)", March 2010
- KDB865664, SAR Measurement Requirements for 100 MHz to 6 GHz

**Additional Documentation:**

- DASY4/5 System Handbook

**Methods Applied and Interpretation of Parameters:**

- Measurement Conditions:** Further details are available from the Validation Report at the end of the certificate. All figures stated in the certificate are valid at the frequency indicated.
- Antenna Parameters with TSL:** The dipole is mounted with the spacer to position its feed point exactly below the center marking of the flat phantom section, with the arms oriented parallel to the body axis.
- Feed Point Impedance and Return Loss:** These parameters are measured with the dipole positioned under the liquid filled phantom. The impedance stated is transformed from the measurement at the SMA connector to the feed point. The Return Loss ensures low reflected power. No uncertainty required.
- Electrical Delay:** One-way delay between the SMA connector and the antenna feed point. No uncertainty required.
- SAR measured:** SAR measured at the stated antenna input power.
- SAR normalized:** SAR as measured, normalized to an input power of 1 W at the antenna connector.
- SAR for nominal TSL parameters:** The measured TSL parameters are used to calculate the nominal SAR result.

The reported uncertainty of measurement is stated as the standard uncertainty of Measurement multiplied by the coverage factor  $k=2$ , which for a normal distribution Corresponds to a coverage probability of approximately 95%.



Add: No.51 Xueyuan Road, Haidian District, Beijing, 100191, China  
 Tel: +86-10-62304633-2079 Fax: +86-10-62304633-2504  
 E-mail: ttl@chinattl.com http://www.chinattl.cn

### Measurement Conditions

DASY system configuration, as far as not given on page 1.

DASY Version	DASY52	V52.10.2
Extrapolation	Advanced Extrapolation	
Phantom	Triple Flat Phantom 5.1C	
Distance Dipole Center - TSL	15 mm	with Spacer
Zoom Scan Resolution	dx, dy, dz = 5 mm	
Frequency	750 MHz $\pm$ 1 MHz	

### Head TSL parameters

The following parameters and calculations were applied.

	Temperature	Permittivity	Conductivity
Nominal Head TSL parameters	22.0 °C	41.9	0.89 mho/m
Measured Head TSL parameters	(22.0 $\pm$ 0.2) °C	41.6 $\pm$ 6 %	0.90 mho/m $\pm$ 6 %
Head TSL temperature change during test	<1.0 °C	---	---

### SAR result with Head TSL

SAR averaged over 1 $cm^3$ (1 g) of Head TSL	Condition	
SAR measured	250 mW input power	2.16 W/kg
SAR for nominal Head TSL parameters	normalized to 1W	8.53 W/kg $\pm$ 18.8 % (k=2)
SAR averaged over 10 $cm^3$ (10 g) of Head TSL	Condition	
SAR measured	250 mW input power	1.44 W/kg
SAR for nominal Head TSL parameters	normalized to 1W	5.70 W/kg $\pm$ 18.7 % (k=2)

### Body TSL parameters

The following parameters and calculations were applied.

	Temperature	Permittivity	Conductivity
Nominal Body TSL parameters	22.0 °C	55.5	0.96 mho/m
Measured Body TSL parameters	(22.0 $\pm$ 0.2) °C	55.9 $\pm$ 6 %	0.94 mho/m $\pm$ 6 %
Body TSL temperature change during test	<1.0 °C	---	---

### SAR result with Body TSL

SAR averaged over 1 $cm^3$ (1 g) of Body TSL	Condition	
SAR measured	250 mW input power	2.16 W/kg
SAR for nominal Body TSL parameters	normalized to 1W	8.78 W/kg $\pm$ 18.8 % (k=2)
SAR averaged over 10 $cm^3$ (10 g) of Body TSL	Condition	
SAR measured	250 mW input power	1.45 W/kg
SAR for nominal Body TSL parameters	normalized to 1W	5.87 W/kg $\pm$ 18.7 % (k=2)





Add: No.51 Xueyuan Road, Haidian District, Beijing, 100191, China
Tel: +86-10-62304633-2079 Fax: +86-10-62304633-2504
E-mail: cttl@chinattl.com http://www.chinattl.cn

Appendix (Additional assessments outside the scope of CNAS L0570)

Antenna Parameters with Head TSL

Table with 2 columns: Parameter, Value. Rows: Impedance, transformed to feed point (50.5Ω- 4.53jΩ), Return Loss (- 26.9dB)

Antenna Parameters with Body TSL

Table with 2 columns: Parameter, Value. Rows: Impedance, transformed to feed point (48.5Ω- 3.38jΩ), Return Loss (- 28.5dB)

General Antenna Parameters and Design

Table with 2 columns: Parameter, Value. Row: Electrical Delay (one direction) (0.900 ns)

After long term use with 100W radiated power, only a slight warming of the dipole near the feedpoint can be measured.

The dipole is made of standard semirigid coaxial cable. The center conductor of the feeding line is directly connected to the second arm of the dipole. The antenna is therefore short-circuited for DC-signals. On some of the dipoles, small end caps are added to the dipole arms in order to improve matching when loaded according to the position as explained in the "Measurement Conditions" paragraph. The SAR data are not affected by this change. The overall dipole length is still according to the Standard. No excessive force must be applied to the dipole arms, because they might bend or the soldered connections near the feedpoint may be damaged.

Additional EUT Data

Table with 2 columns: Parameter, Value. Row: Manufactured by (SPEAG)



Add: No.51 Xueyuan Road, Haidian District, Beijing, 100191, China  
 Tel: +86-10-62304633-2079 Fax: +86-10-62304633-2504  
 E-mail: ctfl@chinattl.com http://www.chinattl.cn

**DASY5 Validation Report for Head TSL**

Date: 09.03.2019

Test Laboratory: CTTL, Beijing, China

**DUT: Dipole 750 MHz; Type: D750V3; Serial: D750V3 - SN: 1163**

Communication System: UID 0, CW; Frequency: 750 MHz; Duty Cycle: 1:1

Medium parameters used:  $f = 750$  MHz;  $\sigma = 0.904$  S/m;  $\epsilon_r = 41.62$ ;  $\rho = 1000$  kg/m<sup>3</sup>

Phantom section: Right Section

DASY5 Configuration:

- Probe: EX3DV4 - SN3617; ConvF(10.03, 10.03, 10.03) @ 750 MHz; Calibrated: 1/31/2019
- Sensor-Surface: 1.4mm (Mechanical Surface Detection)
- Electronics: DAE4 Sn1555; Calibrated: 8/22/2019
- Phantom: MFP\_V5.1C ; Type: QD 000 P51CA; Serial: 1062
- Measurement SW: DASY52, Version 52.10 (2); SEMCAD X Version 14.6.12 (7470)

**Dipole Calibration/Zoom Scan (7x7x7) (7x7x7)/Cube 0: Measurement grid: dx=5mm, dy=5mm, dz=5mm**

Reference Value = 55.16 V/m; Power Drift = -0.02 dB

Peak SAR (extrapolated) = 3.11 W/kg

**SAR(1 g) = 2.16 W/kg; SAR(10 g) = 1.44 W/kg**

Maximum value of SAR (measured) = 2.81 W/kg

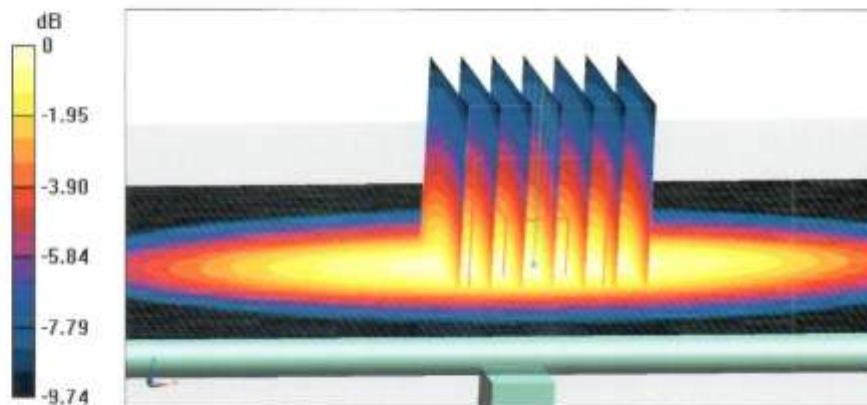



Add: No.51 Xueyuan Road, Haidian District, Beijing, 100191, China  
Tel: +86-10-62304633-2079 Fax: +86-10-62304633-2504  
E-mail: cttl@chinattl.com http://www.chinattl.cn

Impedance Measurement Plot for Head TSL

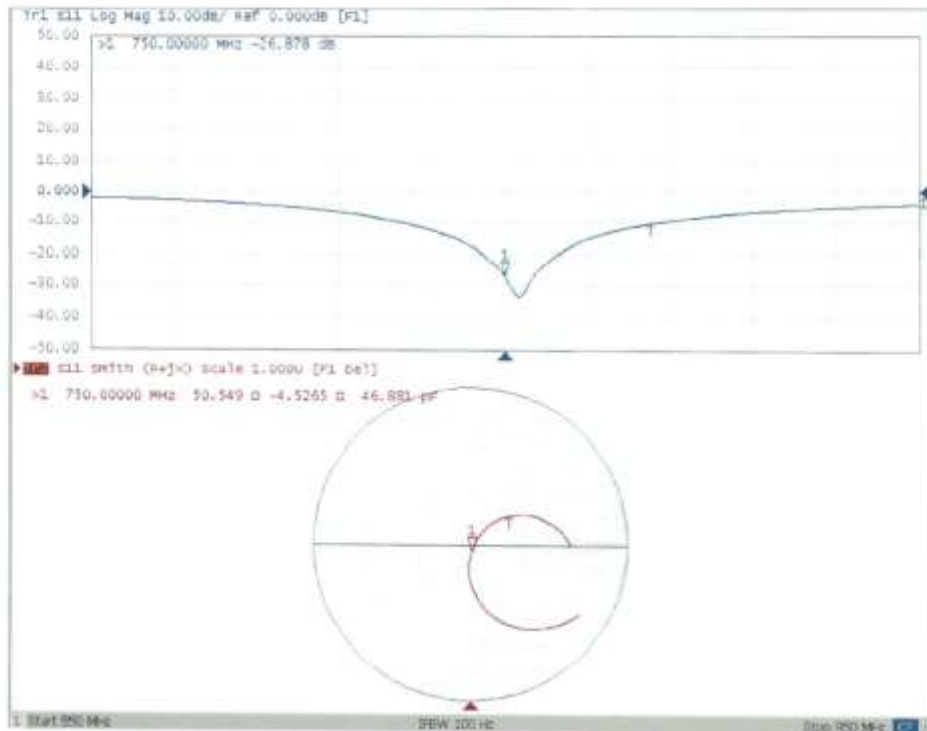



Add: No.51 Xueyuan Road, Haidian District, Beijing, 100191, China  
Tel: +86-10-62304633-2079 Fax: +86-10-62304633-2504  
E-mail: cttl@chinattl.com http://www.chinattl.cn

**DASY5 Validation Report for Body TSL**

Date: 09.03.2019

Test Laboratory: CTTL, Beijing, China

**DUT: Dipole 750 MHz; Type: D750V3; Serial: D750V3 - SN: 1163**

Communication System: UID 0, CW; Frequency: 750 MHz; Duty Cycle: 1:1

Medium parameters used:  $f = 750$  MHz;  $\sigma = 0.942$  S/m;  $\epsilon_r = 55.87$ ;  $\rho = 1000$  kg/m<sup>3</sup>

Phantom section: Center Section

DASY5 Configuration:

- Probe: EX3DV4 - SN3617; ConvF(9.85, 9.85, 9.85) @ 750 MHz; Calibrated: 1/31/2019
- Sensor-Surface: 1.4mm (Mechanical Surface Detection)
- Electronics: DAE4 Sn1555; Calibrated: 8/22/2019
- Phantom: MFP\_V5.1C ; Type: QD 000 P51CA; Serial: 1062
- Measurement SW: DASY52, Version 52.10 (2); SEMCAD X Version 14.6.12 (7470)

**Dipole Calibration/Zoom Scan (7x7x7) (7x7x7)/Cube 0:** Measurement grid: dx=5mm, dy=5mm, dz=5mm

Reference Value = 52.88 V/m; Power Drift = 0.03 dB

Peak SAR (extrapolated) = 3.20 W/kg

**SAR(1 g) = 2.16 W/kg; SAR(10 g) = 1.45 W/kg**

Maximum value of SAR (measured) = 2.85 W/kg

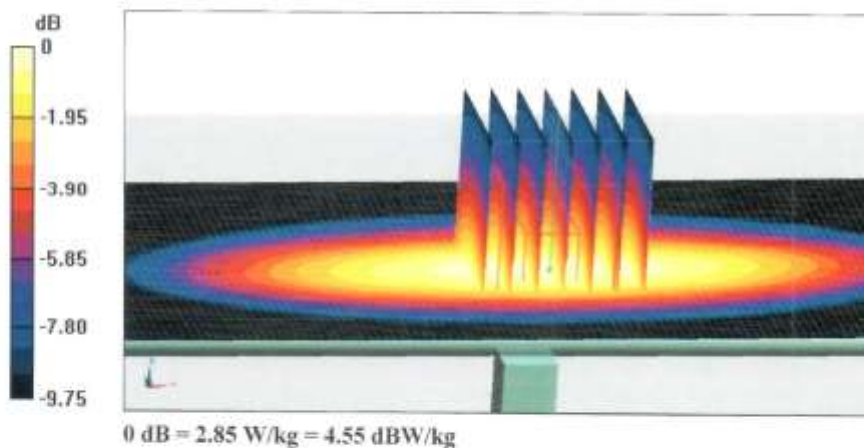



Add: No.51 Xueyuan Road, Haidian District, Beijing, 100191, China  
Tel: +86-10-62304633-2079 Fax: +86-10-62304633-2504  
E-mail: cntl@chinantl.com http://www.chinantl.cn

Impedance Measurement Plot for Body TSL

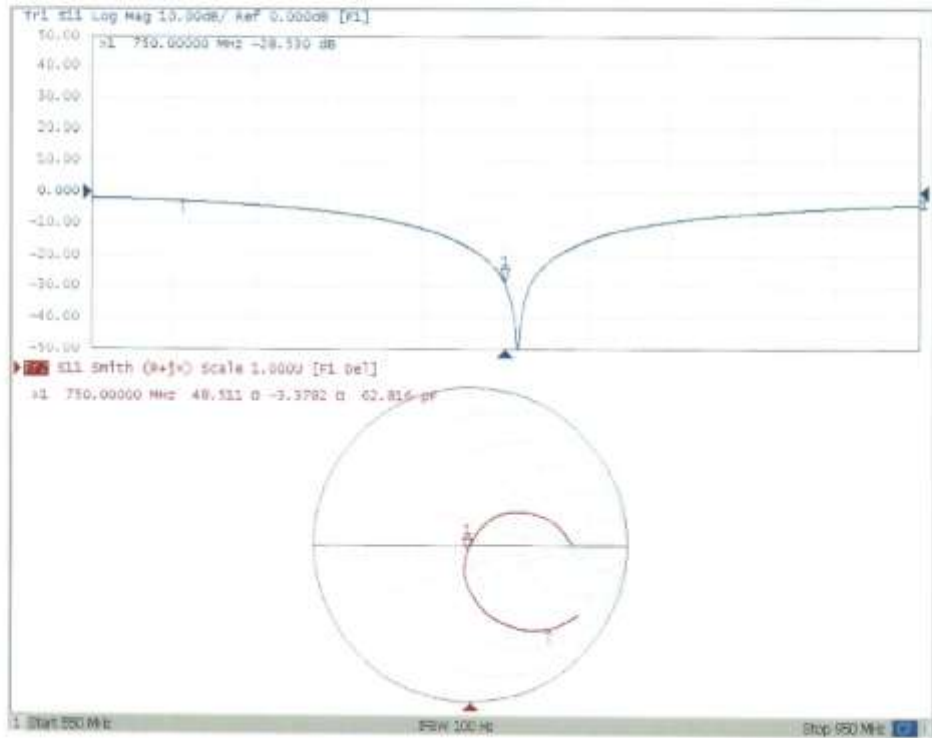



835 MHz Dipole Calibration Certificate



In Collaboration with  
**s p e a g**  
CALIBRATION LABORATORY



中国认可  
国际互认  
校准  
CALIBRATION  
CNAS LD570

Add: No.51 Xueyuan Road, Haidian District, Beijing, 100191, China  
Tel: +86-10-62304633-2079 Fax: +86-10-62304633-2504  
E-mail: cntl@chinattl.com http://www.chinattl.cn

Client **CTTL(South Branch)**

Certificate No: **Z18-60385**

**CALIBRATION CERTIFICATE**

Object **D835V2 - SN: 4d057**

Calibration Procedure(s) **FF-Z11-003-01**  
**Calibration Procedures for dipole validation kits**

Calibration date: **October 9, 2018**

This calibration Certificate documents the traceability to national standards, which realize the physical units of measurements(SI). The measurements and the uncertainties with confidence probability are given on the following pages and are part of the certificate.

All calibrations have been conducted in the closed laboratory facility: environment temperature(22±3)°C and humidity<70%.

Calibration Equipment used (M&TE critical for calibration)

Primary Standards	ID #	Cal Date(Calibrated by, Certificate No.)	Scheduled Calibration
Power Meter NRVD	102083	01-Nov-17 (CTTL, No.J17X08756)	Oct-18
Power sensor NRV-Z5	100542	01-Nov-17 (CTTL, No.J17X08756)	Oct-18
Reference Probe EX3DV4 DAE4	SN 7514	27-Aug-18(SPEAG,No.EX3-7514_Aug18)	Aug-19
	SN 1555	20-Aug-18(SPEAG,No.DAE4-1555_Aug18)	Aug-19
Secondary Standards	ID #	Cal Date(Calibrated by, Certificate No.)	Scheduled Calibration
Signal Generator E4438C	MY49071430	23-Jan-18 (CTTL, No.J18X00560)	Jan-19
NetworkAnalyzer E5071C	MY46110673	24-Jan-18 (CTTL, No.J18X00561)	Jan-19

	Name	Function	Signature
Calibrated by:	Zhao Jing	SAR Test Engineer	
Reviewed by:	Lin Hao	SAR Test Engineer	
Approved by:	Qi Dianyuan	SAR Project Leader	

Issued: October 11, 2018

This calibration certificate shall not be reproduced except in full without written approval of the laboratory.



Add: No.51 Xueyuan Road, Haidian District, Beijing, 100191, China  
Tel: +86-10-62304633-2079 Fax: +86-10-62304633-2504  
E-mail: ctf@chinattl.com http://www.chinattl.cn

**Glossary:**

TSL	tissue simulating liquid
ConvF	sensitivity in TSL / NORM <sub>x,y,z</sub>
N/A	not applicable or not measured

**Calibration is Performed According to the Following Standards:**

- IEEE Std 1528-2013, "IEEE Recommended Practice for Determining the Peak Spatial-Averaged Specific Absorption Rate (SAR) in the Human Head from Wireless Communications Devices: Measurement Techniques", June 2013
- IEC 62209-1, "Measurement procedure for assessment of specific absorption rate of human exposure to radio frequency fields from hand-held and body-mounted wireless communication devices- Part 1: Device used next to the ear (Frequency range of 300MHz to 6GHz)", July 2016
- IEC 62209-2, "Procedure to measure the Specific Absorption Rate (SAR) For wireless communication devices used in close proximity to the human body (frequency range of 30MHz to 6GHz)", March 2010
- KDB865664, SAR Measurement Requirements for 100 MHz to 6 GHz

**Additional Documentation:**

- DASY4/5 System Handbook

**Methods Applied and Interpretation of Parameters:**

- Measurement Conditions:** Further details are available from the Validation Report at the end of the certificate. All figures stated in the certificate are valid at the frequency indicated.
- Antenna Parameters with TSL:** The dipole is mounted with the spacer to position its feed point exactly below the center marking of the flat phantom section, with the arms oriented parallel to the body axis.
- Feed Point Impedance and Return Loss:** These parameters are measured with the dipole positioned under the liquid filled phantom. The impedance stated is transformed from the measurement at the SMA connector to the feed point. The Return Loss ensures low reflected power. No uncertainty required.
- Electrical Delay:** One-way delay between the SMA connector and the antenna feed point. No uncertainty required.
- SAR measured:** SAR measured at the stated antenna input power.
- SAR normalized:** SAR as measured, normalized to an input power of 1 W at the antenna connector.
- SAR for nominal TSL parameters:** The measured TSL parameters are used to calculate the nominal SAR result.

The reported uncertainty of measurement is stated as the standard uncertainty of Measurement multiplied by the coverage factor  $k=2$ , which for a normal distribution Corresponds to a coverage probability of approximately 95%.



Add: No.51 Xueyuan Road, Haidian District, Beijing, 100191, China  
 Tel: +86-10-62304633-2079 Fax: +86-10-62304633-2504  
 E-mail: cntf@chinattl.com http://www.chinattl.cn

### Measurement Conditions

DASY system configuration, as far as not given on page 1.

DASY Version	DASY52	52.10.1.1476
Extrapolation	Advanced Extrapolation	
Phantom	Triple Flat Phantom 5.1C	
Distance Dipole Center - TSL	15 mm	with Spacer
Zoom Scan Resolution	dx, dy, dz = 5 mm	
Frequency	835 MHz $\pm$ 1 MHz	

### Head TSL parameters

The following parameters and calculations were applied.

	Temperature	Permittivity	Conductivity
Nominal Head TSL parameters	22.0 °C	41.5	0.90 mho/m
Measured Head TSL parameters	(22.0 $\pm$ 0.2) °C	42.2 $\pm$ 6 %	0.91 mho/m $\pm$ 6 %
Head TSL temperature change during test	<1.0 °C	---	---

### SAR result with Head TSL

SAR averaged over 1 $cm^3$ (1 g) of Head TSL	Condition	
SAR measured	250 mW input power	2.42 mW / g
SAR for nominal Head TSL parameters	normalized to 1W	<b>9.62 mW / g <math>\pm</math> 18.8 % (k=2)</b>
SAR averaged over 10 $cm^3$ (10 g) of Head TSL	Condition	
SAR measured	250 mW input power	1.58 mW / g
SAR for nominal Head TSL parameters	normalized to 1W	<b>6.29 mW / g <math>\pm</math> 18.7 % (k=2)</b>

### Body TSL parameters

The following parameters and calculations were applied.

	Temperature	Permittivity	Conductivity
Nominal Body TSL parameters	22.0 °C	55.2	0.97 mho/m
Measured Body TSL parameters	(22.0 $\pm$ 0.2) °C	55.9 $\pm$ 6 %	0.99 mho/m $\pm$ 6 %
Body TSL temperature change during test	<1.0 °C	---	---

### SAR result with Body TSL

SAR averaged over 1 $cm^3$ (1 g) of Body TSL	Condition	
SAR measured	250 mW input power	2.51 mW / g
SAR for nominal Body TSL parameters	normalized to 1W	<b>9.90 mW / g <math>\pm</math> 18.8 % (k=2)</b>
SAR averaged over 10 $cm^3$ (10 g) of Body TSL	Condition	
SAR measured	250 mW input power	1.66 mW / g
SAR for nominal Body TSL parameters	normalized to 1W	<b>6.56 mW / g <math>\pm</math> 18.7 % (k=2)</b>





Add: No.51 Xueyuan Road, Haidian District, Beijing, 100191, China
Tel: +86-10-62304633-2079 Fax: +86-10-62304633-2504
E-mail: cttl@chinatl.com http://www.chinatl.cn

Appendix (Additional assessments outside the scope of CNAS L0570)

Antenna Parameters with Head TSL

Table with 2 columns: Parameter, Value. Rows: Impedance, transformed to feed point (49.6Ω- 4.08jΩ), Return Loss (- 27.7dB)

Antenna Parameters with Body TSL

Table with 2 columns: Parameter, Value. Rows: Impedance, transformed to feed point (46.8Ω- 4.96jΩ), Return Loss (- 24.3dB)

General Antenna Parameters and Design

Table with 2 columns: Parameter, Value. Row: Electrical Delay (one direction) (1.260 ns)

After long term use with 100W radiated power, only a slight warming of the dipole near the feedpoint can be measured.

The dipole is made of standard semirigid coaxial cable. The center conductor of the feeding line is directly connected to the second arm of the dipole. The antenna is therefore short-circuited for DC-signals. On some of the dipoles, small end caps are added to the dipole arms in order to improve matching when loaded according to the position as explained in the "Measurement Conditions" paragraph. The SAR data are not affected by this change. The overall dipole length is still according to the Standard. No excessive force must be applied to the dipole arms, because they might bend or the soldered connections near the feedpoint may be damaged.

Additional EUT Data

Table with 2 columns: Parameter, Value. Row: Manufactured by (SPEAG)



Add: No.51 Xueyuan Road, Haidian District, Beijing, 100191, China  
 Tel: +86-10-62304633-2079 Fax: +86-10-62304633-2504  
 E-mail: cttl@chinattl.com http://www.chinattl.cn

**DASY5 Validation Report for Head TSL**

Date: 10.08.2018

Test Laboratory: CTTL, Beijing, China

**DUT: Dipole 835 MHz; Type: D835V2; Serial: D835V2 - SN: 4d057**

Communication System: UID 0, CW; Frequency: 835 MHz; Duty Cycle: 1:1

Medium parameters used:  $f = 835$  MHz;  $\sigma = 0.912$  S/m;  $\epsilon_r = 42.22$ ;  $\rho = 1000$  kg/m<sup>3</sup>

Phantom section: Center Section

DASY5 Configuration:

- Probe: EX3DV4 - SN7514; ConvF(9.09, 9.09, 9.09) @ 835 MHz; Calibrated: 8/27/2018
- Sensor-Surface: 1.4mm (Mechanical Surface Detection)
- Electronics: DAE4 Sn1555; Calibrated: 8/20/2018
- Phantom: MFP\_V5.1C ; Type: QD 000 P51CA; Serial: 1062
- Measurement SW: DASY52, Version 52.10 (1); SEMCAD X Version 14.6.11 (7439)

**Dipole Calibration/Zoom Scan (7x7x7) (7x7x7)/Cube 0: Measurement grid: dx=5mm, dy=5mm, dz=5mm**

Reference Value = 55.57 V/m; Power Drift = -0.04 dB

Peak SAR (extrapolated) = 3.61 W/kg

**SAR(1 g) = 2.42 W/kg; SAR(10 g) = 1.58 W/kg**

Maximum value of SAR (measured) = 3.22 W/kg

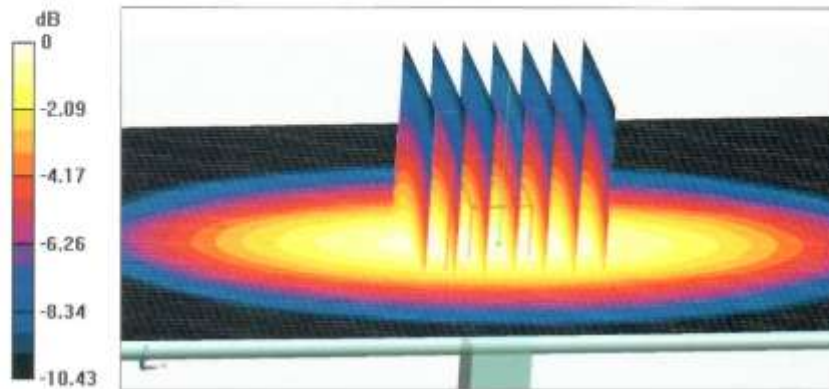

0 dB = 3.22 W/kg = 5.08 dBW/kg



Add: No.51 Xueyuan Road, Haidian District, Beijing, 100191, China  
Tel: +86-10-62304633-2079 Fax: +86-10-62304633-2504  
E-mail: ttl@chinatl.com http://www.chinatl.cn

Impedance Measurement Plot for Head TSL

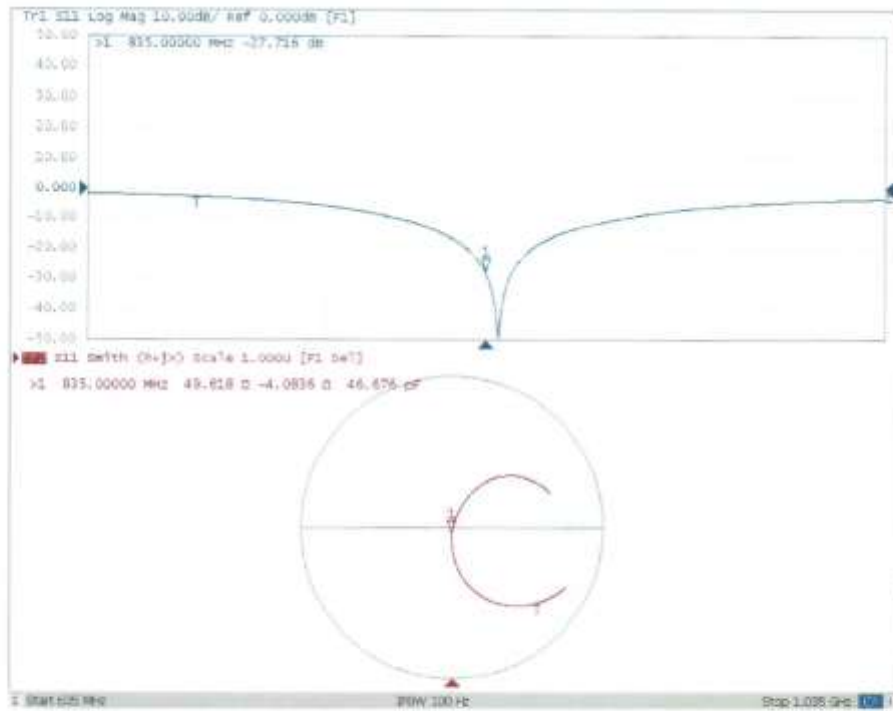



Add: No.51 Xueyuan Road, Haidian District, Beijing, 100191, China  
 Tel: +86-10-62304633-2079 Fax: +86-10-62304633-2504  
 E-mail: cttl@chinantl.com http://www.chinantl.cn

**DASY5 Validation Report for Body TSL**

Date: 10.08.2018

Test Laboratory: CTTL, Beijing, China

**DUT: Dipole 835 MHz; Type: D835V2; Serial: D835V2 - SN: 4d057**

Communication System: UID 0, CW; Frequency: 835 MHz; Duty Cycle: 1:1

Medium parameters used:  $f = 835$  MHz;  $\sigma = 0.992$  S/m;  $\epsilon_r = 55.93$ ;  $\rho = 1000$  kg/m<sup>3</sup>

Phantom section: Right Section

DASY5 Configuration:

- Probe: EX3DV4 - SN7514; ConvF(9.47, 9.47, 9.47) @ 835 MHz; Calibrated: 8/27/2018
- Sensor-Surface: 1.4mm (Mechanical Surface Detection)
- Electronics: DAE4 Sn1555; Calibrated: 8/20/2018
- Phantom: MFP\_V5.1C ; Type: QD 000 P51CA; Serial: 1062
- Measurement SW: DASY52, Version 52.10 (1); SEMCAD X Version 14.6.11 (7439)

**Dipole Calibration/Zoom Scan (7x7x7) (7x7x7)/Cube 0:** Measurement grid: dx=5mm, dy=5mm, dz=5mm

Reference Value = 56.64 V/m; Power Drift = -0.01 dB

Peak SAR (extrapolated) = 3.83 W/kg

**SAR(1 g) = 2.51 W/kg; SAR(10 g) = 1.66 W/kg**

Maximum value of SAR (measured) = 3.36 W/kg

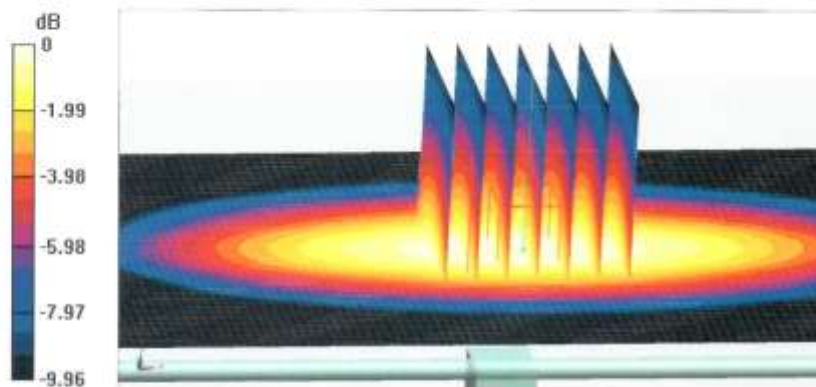

0 dB = 3,36 W/kg = 5,26 dBW/kg



Add: No.51 Xueyuan Road, Haidian District, Beijing, 100191, China  
Tel: +86-10-62304633-2079 Fax: +86-10-62304633-2504  
E-mail: cntl@chinattl.com http://www.chinattl.cn

Impedance Measurement Plot for Body TSL

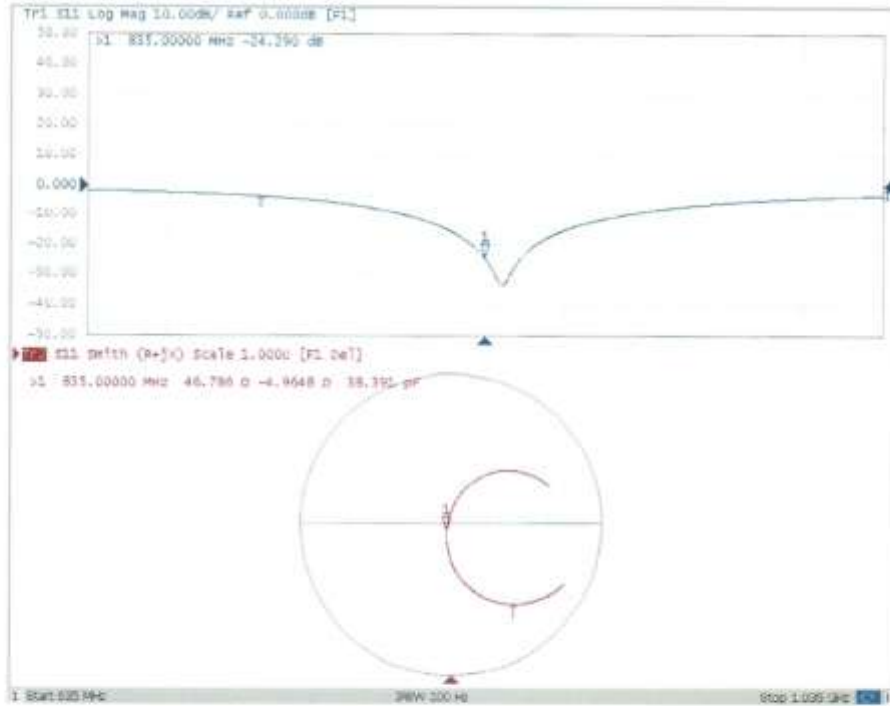



1750 MHz Dipole Calibration Certificate

In Collaboration with







中国认可  
国际互认  
校准  
CALIBRATION  
CNAS L0570

Address: No.51 Xueyuan Road, Haidian District, Beijing, 100191, China  
Tel: +86-10-62304633-2079 Fax: +86-10-62304633-2504  
E-mail: ctll@chinattl.com http://www.chinattl.cn

Client CTTL(South Branch) Certificate No: Z19-60292

CALIBRATION CERTIFICATE			
Object	D1750V2 - SN: 1152		
Calibration Procedure(s)	FF-Z11-003-01 Calibration Procedures for dipole validation kits		
Calibration date:	August 30, 2019		
<p>This calibration Certificate documents the traceability to national standards, which realize the physical units of measurements(SI). The measurements and the uncertainties with confidence probability are given on the following pages and are part of the certificate.</p> <p>All calibrations have been conducted in the closed laboratory facility: environment temperature(22±3)℃ and humidity&lt;70%.</p> <p>Calibration Equipment used (M&amp;TE critical for calibration)</p>			
Primary Standards	ID #	Cal Date(Calibrated by, Certificate No.)	Scheduled Calibration
Power Meter NRP2	106276	11-Apr-19 (CTTL, No.J19X02605)	Apr-20
Power sensor NRP6A	101369	11-Apr-19 (CTTL, No.J19X02605)	Apr-20
Reference Probe EX3DV4	SN 3617	31-Jan-19(SPEAG No.EX3-3617_Jan19)	Jan-20
DAE4	SN 1555	22-Aug-19(CTTL-SPEAG, No.Z19-60295)	Aug-20
Secondary Standards	ID #	Cal Date(Calibrated by, Certificate No.)	Scheduled Calibration
Signal Generator E4438C	MY49071430	23-Jan-19 (CTTL, No.J19X00336)	Jan-20
NetworkAnalyzer E5071C	MY46110673	24-Jan-19 (CTTL, No.J19X00547)	Jan-20
Calibrated by:	Name Zhao Jing	Function SAR Test Engineer	Signature 
Reviewed by:	Name Lin Hao	Function SAR Test Engineer	Signature 
Approved by:	Name Qi Dianyuan	Function SAR Project Leader	Signature 
Issued: September 2, 2019			
This calibration certificate shall not be reproduced except in full without written approval of the laboratory.			



Add: No.51 Xueyuan Road, Haidian District, Beijing, 100191, China  
Tel: +86-10-62304633-2079 Fax: +86-10-62304633-2504  
E-mail: cttf@chinantl.com http://www.chinantl.cn

**Glossary:**

TSL	tissue simulating liquid
ConvF	sensitivity in TSL / NORM <sub>x,y,z</sub>
N/A	not applicable or not measured

**Calibration is Performed According to the Following Standards:**

- IEEE Std 1528-2013, "IEEE Recommended Practice for Determining the Peak Spatial-Averaged Specific Absorption Rate (SAR) in the Human Head from Wireless Communications Devices: Measurement Techniques", June 2013
- IEC 62209-1, "Measurement procedure for assessment of specific absorption rate of human exposure to radio frequency fields from hand-held and body-mounted wireless communication devices- Part 1: Device used next to the ear (Frequency range of 300MHz to 6GHz)", July 2016
- IEC 62209-2, "Procedure to measure the Specific Absorption Rate (SAR) For wireless communication devices used in close proximity to the human body (frequency range of 30MHz to 6GHz)", March 2010
- KDB865664, SAR Measurement Requirements for 100 MHz to 6 GHz

**Additional Documentation:**

- DASY4/5 System Handbook

**Methods Applied and Interpretation of Parameters:**

- Measurement Conditions:* Further details are available from the Validation Report at the end of the certificate. All figures stated in the certificate are valid at the frequency indicated.
- Antenna Parameters with TSL:* The dipole is mounted with the spacer to position its feed point exactly below the center marking of the flat phantom section, with the arms oriented parallel to the body axis.
- Feed Point Impedance and Return Loss:* These parameters are measured with the dipole positioned under the liquid filled phantom. The impedance stated is transformed from the measurement at the SMA connector to the feed point. The Return Loss ensures low reflected power. No uncertainty required.
- Electrical Delay:* One-way delay between the SMA connector and the antenna feed point. No uncertainty required.
- SAR measured:* SAR measured at the stated antenna input power.
- SAR normalized:* SAR as measured, normalized to an input power of 1 W at the antenna connector.
- SAR for nominal TSL parameters:* The measured TSL parameters are used to calculate the nominal SAR result.

The reported uncertainty of measurement is stated as the standard uncertainty of Measurement multiplied by the coverage factor  $k=2$ , which for a normal distribution Corresponds to a coverage probability of approximately 95%.



Add: No.51 Xueyuan Road, Haidian District, Beijing, 100191, China  
 Tel: +86-10-62304633-2079 Fax: +86-10-62304633-2504  
 E-mail: ttl@chinattl.com http://www.chinattl.cn

### Measurement Conditions

DASY system configuration, as far as not given on page 1.

DASY Version	DASY52	V52.10.2
Extrapolation	Advanced Extrapolation	
Phantom	Triple Flat Phantom 5.1C	
Distance Dipole Center - TSL	10 mm	with Spacer
Zoom Scan Resolution	dx, dy, dz = 5 mm	
Frequency	1750 MHz ± 1 MHz	

### Head TSL parameters

The following parameters and calculations were applied.

	Temperature	Permittivity	Conductivity
Nominal Head TSL parameters	22.0 °C	40.1	1.37 mho/m
Measured Head TSL parameters	(22.0 ± 0.2) °C	39.9 ± 6 %	1.36 mho/m ± 6 %
Head TSL temperature change during test	<1.0 °C	---	---

### SAR result with Head TSL

SAR averaged over 1 cm <sup>3</sup> (1 g) of Head TSL	Condition	
SAR measured	250 mW input power	9.05 W/kg
SAR for nominal Head TSL parameters	normalized to 1W	<b>36.4 W/kg ± 18.8 % (k=2)</b>
SAR averaged over 10 cm <sup>3</sup> (10 g) of Head TSL	Condition	
SAR measured	250 mW input power	4.80 W/kg
SAR for nominal Head TSL parameters	normalized to 1W	<b>19.3 W/kg ± 18.7 % (k=2)</b>

### Body TSL parameters

The following parameters and calculations were applied.

	Temperature	Permittivity	Conductivity
Nominal Body TSL parameters	22.0 °C	53.4	1.49 mho/m
Measured Body TSL parameters	(22.0 ± 0.2) °C	53.1 ± 6 %	1.52 mho/m ± 6 %
Body TSL temperature change during test	<1.0 °C	---	---

### SAR result with Body TSL

SAR averaged over 1 cm <sup>3</sup> (1 g) of Body TSL	Condition	
SAR measured	250 mW input power	9.45 W/kg
SAR for nominal Body TSL parameters	normalized to 1W	<b>37.3 W/kg ± 18.8 % (k=2)</b>
SAR averaged over 10 cm <sup>3</sup> (10 g) of Body TSL	Condition	
SAR measured	250 mW input power	5.05 W/kg
SAR for nominal Body TSL parameters	normalized to 1W	<b>20.0 W/kg ± 18.7 % (k=2)</b>





Add: No.51 Xueyuan Road, Haidian District, Beijing, 100191, China  
 Tel: +86-10-62304633-2079 Fax: +86-10-62304633-2504  
 E-mail: ttl@chinantl.com http://www.chinantl.cn

**Appendix (Additional assessments outside the scope of CNAS L0570)**

**Antenna Parameters with Head TSL**

Impedance, transformed to feed point	49.1Ω- 0.84 jΩ
Return Loss	- 38.1 dB

**Antenna Parameters with Body TSL**

Impedance, transformed to feed point	45.2Ω- 1.37 jΩ
Return Loss	- 25.5 dB

**General Antenna Parameters and Design**

Electrical Delay (one direction)	1.084 ns
----------------------------------	----------

After long term use with 100W radiated power, only a slight warming of the dipole near the feedpoint can be measured.

The dipole is made of standard semirigid coaxial cable. The center conductor of the feeding line is directly connected to the second arm of the dipole. The antenna is therefore short-circuited for DC-signals. On some of the dipoles, small end caps are added to the dipole arms in order to improve matching when loaded according to the position as explained in the "Measurement Conditions" paragraph. The SAR data are not affected by this change. The overall dipole length is still according to the Standard. No excessive force must be applied to the dipole arms, because they might bend or the soldered connections near the feedpoint may be damaged.

**Additional EUT Data**

Manufactured by	SPEAG
-----------------	-------



In Collaboration with  
 Add: No.51 Xaoyuan Road, Haidian District, Beijing, 100191, China  
 Tel: +86-10-62304633-2079 Fax: +86-10-62304633-2504  
 E-mail: ctfl@chinattl.com http://www.chinattl.cn

**DASY5 Validation Report for Head TSL**

Date: 08.30.2019

Test Laboratory: CTTL, Beijing, China

**DUT: Dipole 1750 MHz; Type: D1750V2; Serial: D1750V2 - SN: 1152**

Communication System: UID 0, CW; Frequency: 1750 MHz; Duty Cycle: 1:1

Medium parameters used:  $f = 1750$  MHz;  $\sigma = 1.358$  S/m;  $\epsilon_r = 39.91$ ;  $\rho = 1000$  kg/m<sup>3</sup>

Phantom section: Right Section

DASY5 Configuration:

- Probe: EX3DV4 - SN3617; ConvF(8.38, 8.38, 8.38) @ 1750 MHz; Calibrated: 1/31/2019
- Sensor-Surface: 1.4mm (Mechanical Surface Detection)
- Electronics: DAE4 Sn1555; Calibrated: 8/22/2019
- Phantom: MFP\_V5.1C ; Type: QD 000 P51CA; Serial: 1062
- Measurement SW: DASY52, Version 52.10 (2); SEMCAD X Version 14.6.12 (7470)

**System Performance Check/Zoom Scan (7x7x7) (7x7x7)/Cube 0: Measurement grid:**

$dx=5$ mm,  $dy=5$ mm,  $dz=5$ mm

Reference Value = 97.38 V/m; Power Drift = -0.03 dB

Peak SAR (extrapolated) = 16.8 W/kg

**SAR(1 g) = 9.05 W/kg; SAR(10 g) = 4.8 W/kg**

Maximum value of SAR (measured) = 13.9 W/kg

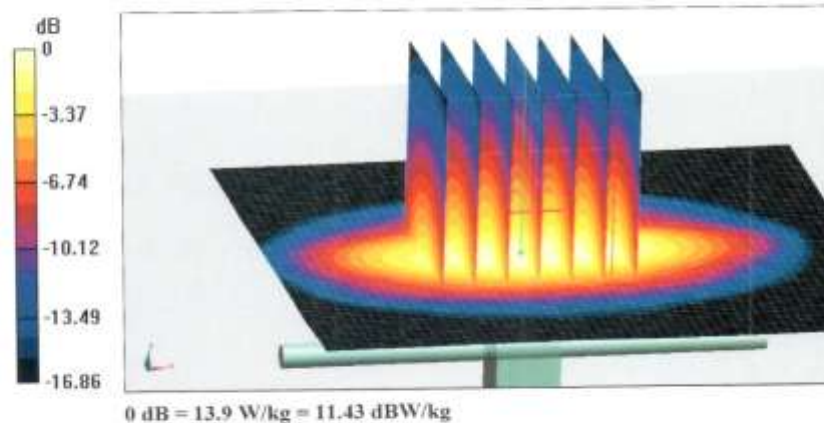



Add: No.51 Xueyuan Road, Haidian District, Beijing, 100191, China  
Tel: +86-10-62304633-2079 Fax: +86-10-62304633-2504  
E-mail: cntl@chinantl.com http://www.chinantl.cn

Impedance Measurement Plot for Head TSL

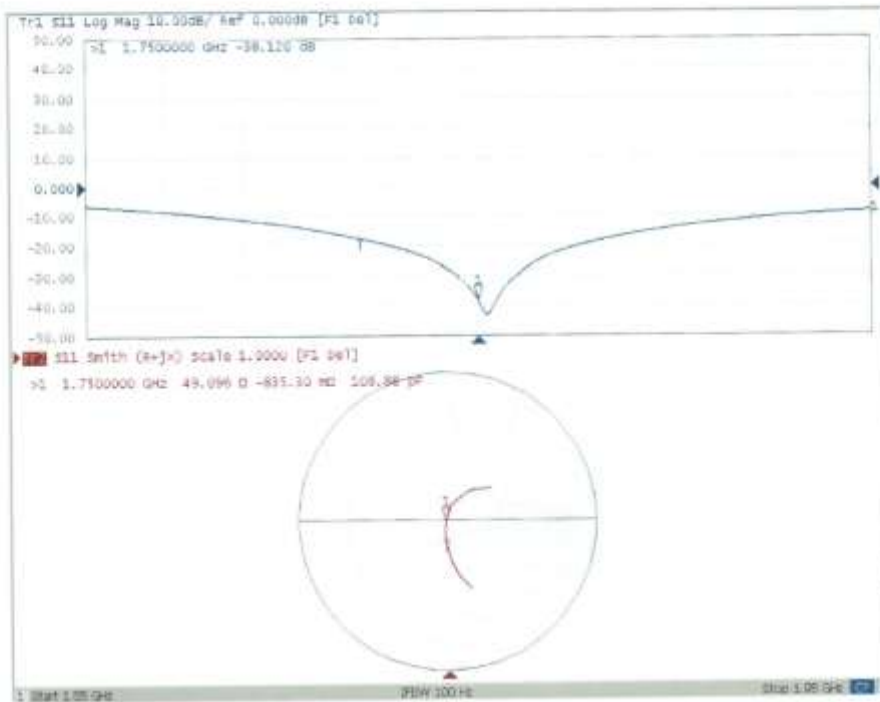



Add: No.51 Xueyuan Road, Haidian District, Beijing, 100191, China  
 Tel: +86-10-62304633-2079 Fax: +86-10-62304633-2504  
 E-mail: cttl@chinantl.com http://www.chinantl.cn

**DASY5 Validation Report for Body TSL**

Date: 08.30.2019

Test Laboratory: CTTL, Beijing, China

**DUT: Dipole 1750 MHz; Type: D1750V2; Serial: D1750V2 - SN: 1152**

Communication System: UID 0, CW; Frequency: 1750 MHz; Duty Cycle: 1:1

Medium parameters used:  $f = 1750$  MHz;  $\sigma = 1.516$  S/m;  $\epsilon_r = 53.05$ ;  $\rho = 1000$  kg/m<sup>3</sup>

Phantom section: Center Section

DASY5 Configuration:

- Probe: EX3DV4 - SN3617; ConvF(8.03, 8.03, 8.03) @ 1750 MHz; Calibrated: 1/31/2019
- Sensor-Surface: 1.4mm (Mechanical Surface Detection)
- Electronics: DAE4 Sn1555; Calibrated: 8/22/2019
- Phantom: MFP\_V5.1C ; Type: QD 000 P51CA; Serial: 1062
- Measurement SW: DASY52, Version 52.10 (2); SEMCAD X Version 14.6.12 (7470)

**System Performance Check/Zoom Scan (7x7x7) (7x7x7)/Cube 0: Measurement grid:**

$dx=5$ mm,  $dy=5$ mm,  $dz=5$ mm

Reference Value = 87.16 V/m; Power Drift = 0.06 dB

Peak SAR (extrapolated) = 17.0 W/kg

**SAR(1 g) = 9.45 W/kg; SAR(10 g) = 5.05 W/kg**

Maximum value of SAR (measured) = 14.4 W/kg

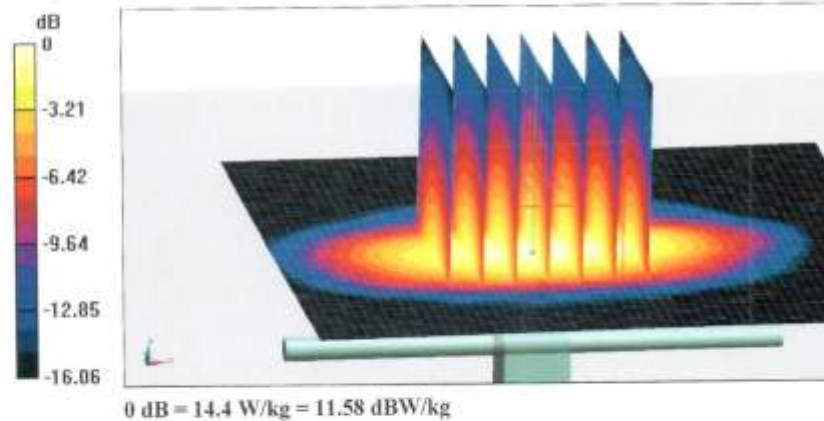



Add: No.51 Xueyuan Road, Haidian District, Beijing, 100191, China.  
Tel: +86-10-62304633-2079 Fax: +86-10-62304633-2504  
E-mail: cttl@chinattl.com http://www.chinattl.cn

Impedance Measurement Plot for Body TSL

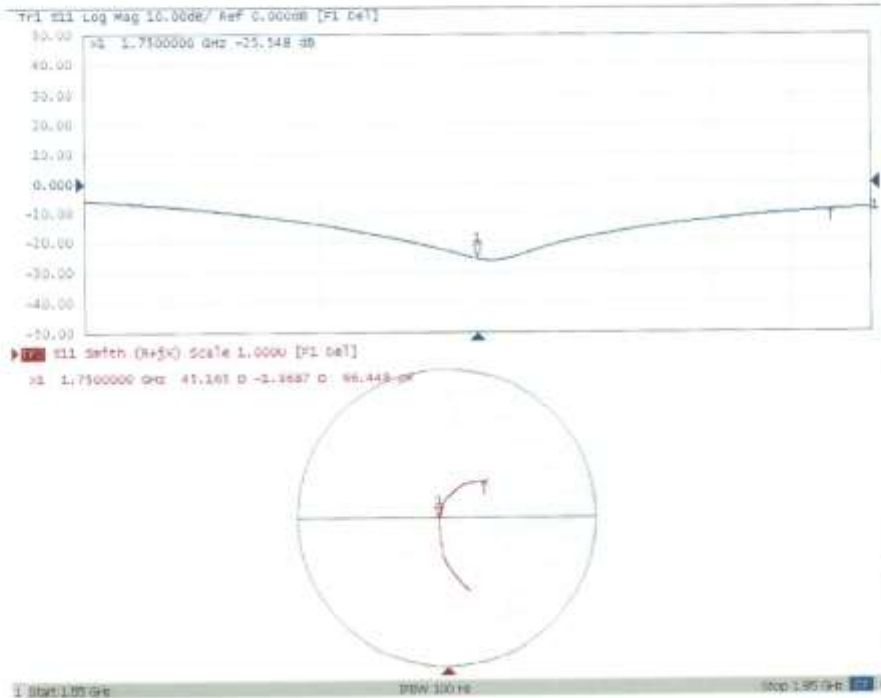



1900 MHz Dipole Calibration Certificate



In Collaboration with  
**s p e a g**  
CALIBRATION LABORATORY

Add: No.51 Xueyuan Road, Haidian District, Beijing, 100191, China  
Tel: +86-10-62304633-2079 Fax: +86-10-62304633-2504  
E-mail: cttl@chinattl.com http://www.chinattl.cn



中国认可  
国际互认  
校准  
CALIBRATION  
CNAS L0570

Client **CTTL(South Branch)**

Certificate No: **Z18-60387**

**CALIBRATION CERTIFICATE**

Object **D1900V2 - SN: 5d088**

Calibration Procedure(s) **FF-Z11-003-01**  
**Calibration Procedures for dipole validation kits**

Calibration date: **October 24, 2018**

This calibration Certificate documents the traceability to national standards, which realize the physical units of measurements(SI). The measurements and the uncertainties with confidence probability are given on the following pages and are part of the certificate.

All calibrations have been conducted in the closed laboratory facility: environment temperature(22±3)°C and humidity<70%.

Calibration Equipment used (M&TE critical for calibration)

Primary Standards	ID #	Cal Date(Calibrated by, Certificate No.)	Scheduled Calibration
Power Meter NRVD	102083	01-Nov-17 (CTTL, No.J17X08756)	Oct-18
Power sensor NRV-Z5	100542	01-Nov-17 (CTTL, No.J17X08756)	Oct-18
Reference Probe EX3DV4 DAE4	SN 7514	27-Aug-18(SPEAG No.EX3-7514_Aug18)	Aug-19
	SN 1555	20-Aug-18(SPEAG No.DAE4-1555_Aug18)	Aug-19
Secondary Standards	ID #	Cal Date(Calibrated by, Certificate No.)	Scheduled Calibration
Signal Generator E4438C	MY49071430	23-Jan-18 (CTTL, No.J18X00560)	Jan-19
NetworkAnalyzer E5071C	MY46110673	24-Jan-18 (CTTL, No.J18X00561)	Jan-19

	Name	Function	Signature
Calibrated by:	Zhao Jing	SAR Test Engineer	
Reviewed by:	Lin Hao	SAR Test Engineer	
Approved by:	Qi Dianyuan	SAR Project Leader	

Issued: October 28, 2018

This calibration certificate shall not be reproduced except in full without written approval of the laboratory.



Add: No.51 Xueyuan Road, Haidian District, Beijing, 100191, China  
Tel: +86-10-62304633-2079 Fax: +86-10-62304633-2504  
E-mail: ctf@chinattl.com http://www.chinattl.cn

**lossary:**

TSL	tissue simulating liquid
ConvF	sensitivity in TSL / NORM <sub>x,y,z</sub>
N/A	not applicable or not measured

**Calibration is Performed According to the Following Standards:**

- IEEE Std 1528-2013, "IEEE Recommended Practice for Determining the Peak Spatial-Averaged Specific Absorption Rate (SAR) in the Human Head from Wireless Communications Devices: Measurement Techniques", June 2013
- IEC 62209-1, "Measurement procedure for assessment of specific absorption rate of human exposure to radio frequency fields from hand-held and body-mounted wireless communication devices- Part 1: Device used next to the ear (Frequency range of 300MHz to 6GHz)", July 2016
- IEC 62209-2, "Procedure to measure the Specific Absorption Rate (SAR) For wireless communication devices used in close proximity to the human body (frequency range of 30MHz to 6GHz)", March 2010
- KDB865664, SAR Measurement Requirements for 100 MHz to 6 GHz

**Additional Documentation:**

- DASY4/5 System Handbook

**Methods Applied and Interpretation of Parameters:**

- Measurement Conditions:** Further details are available from the Validation Report at the end of the certificate. All figures stated in the certificate are valid at the frequency indicated.
- Antenna Parameters with TSL:** The dipole is mounted with the spacer to position its feed point exactly below the center marking of the flat phantom section, with the arms oriented parallel to the body axis.
- Feed Point Impedance and Return Loss:** These parameters are measured with the dipole positioned under the liquid filled phantom. The impedance stated is transformed from the measurement at the SMA connector to the feed point. The Return Loss ensures low reflected power. No uncertainty required.
- Electrical Delay:** One-way delay between the SMA connector and the antenna feed point. No uncertainty required.
- SAR measured:** SAR measured at the stated antenna input power.
- SAR normalized:** SAR as measured, normalized to an input power of 1 W at the antenna connector.
- SAR for nominal TSL parameters:** The measured TSL parameters are used to calculate the nominal SAR result.

The reported uncertainty of measurement is stated as the standard uncertainty of Measurement multiplied by the coverage factor  $k=2$ , which for a normal distribution corresponds to a coverage probability of approximately 95%.

**Measurement Conditions**

DASY system configuration, as far as not given on page 1.

DASY Version	DASY52	52.10.2.1495
Extrapolation	Advanced Extrapolation	
Phantom	Triple Flat Phantom 5.1C	
Distance Dipole Center - TSL	10 mm	with Spacer
Zoom Scan Resolution	dx, dy, dz = 5 mm	
Frequency	1900 MHz $\pm$ 1 MHz	

**Head TSL parameters**

The following parameters and calculations were applied.

	Temperature	Permittivity	Conductivity
Nominal Head TSL parameters	22.0 °C	40.0	1.40 mho/m
Measured Head TSL parameters	(22.0 $\pm$ 0.2) °C	41.1 $\pm$ 6 %	1.37 mho/m $\pm$ 6 %
Head TSL temperature change during test	<1.0 °C	---	---

**SAR result with Head TSL**

SAR averaged over 1 $cm^3$ (1 g) of Head TSL	Condition	
SAR measured	250 mW input power	9.92 mW / g
SAR for nominal Head TSL parameters	normalized to 1W	40.5 mW /g $\pm$ 18.8 % (k=2)
SAR averaged over 10 $cm^3$ (10 g) of Head TSL	Condition	
SAR measured	250 mW input power	5.17 mW / g
SAR for nominal Head TSL parameters	normalized to 1W	21.0 mW /g $\pm$ 18.7 % (k=2)

**Body TSL parameters**

The following parameters and calculations were applied.

	Temperature	Permittivity	Conductivity
Nominal Body TSL parameters	22.0 °C	53.3	1.52 mho/m
Measured Body TSL parameters	(22.0 $\pm$ 0.2) °C	52.6 $\pm$ 6 %	1.55 mho/m $\pm$ 6 %
Body TSL temperature change during test	<1.0 °C	---	---

**SAR result with Body TSL**

SAR averaged over 1 $cm^3$ (1 g) of Body TSL	Condition	
SAR measured	250 mW input power	10.3 mW / g
SAR for nominal Body TSL parameters	normalized to 1W	40.6 mW /g $\pm$ 18.8 % (k=2)
SAR averaged over 10 $cm^3$ (10 g) of Body TSL	Condition	
SAR measured	250 mW input power	5.41 mW / g
SAR for nominal Body TSL parameters	normalized to 1W	21.4 mW /g $\pm$ 18.7 % (k=2)





Add: No.51 Xueyuan Road, Haidian District, Beijing, 100191, China  
 Tel: +86-10-62304633-2079 Fax: +86-10-62304633-2504  
 E-mail: ctdl@chinattl.com http://www.chinattl.cn

#### Appendix (Additional assessments outside the scope of CNAS L0570)

##### Antenna Parameters with Head TSL

Impedance, transformed to feed point	52.7Ω+ 8.63jΩ
Return Loss	- 23.2dB

##### Antenna Parameters with Body TSL

Impedance, transformed to feed point	48.5Ω+ 7.40jΩ
Return Loss	- 22.3dB

##### General Antenna Parameters and Design

Electrical Delay (one direction)	1.058 ns
----------------------------------	----------

After long term use with 100W radiated power, only a slight warming of the dipole near the feedpoint can be measured.

The dipole is made of standard semirigid coaxial cable. The center conductor of the feeding line is directly connected to the second arm of the dipole. The antenna is therefore short-circuited for DC-signals. On some of the dipoles, small end caps are added to the dipole arms in order to improve matching when loaded according to the position as explained in the "Measurement Conditions" paragraph. The SAR data are not affected by this change. The overall dipole length is still according to the Standard. No excessive force must be applied to the dipole arms, because they might bend or the soldered connections near the feedpoint may be damaged.

##### Additional EUT Data

Manufactured by	SPEAG
-----------------	-------



Add: No.51 Xueyuan Road, Haidian District, Beijing, 100191, China  
 Tel: +86-10-62304633-2079 Fax: +86-10-62304633-2504  
 E-mail: cttl@chinatrl.com http://www.chinatrl.cn

**DASY5 Validation Report for Head TSL**

Date: 10.24.2018

Test Laboratory: CTTL, Beijing, China

**DUT: Dipole 1900 MHz; Type: D1900V2; Serial: D1900V2 - SN: 5d088**

Communication System: UID 0, CW; Frequency: 1900 MHz; Duty Cycle: 1:1

Medium parameters used:  $f = 1900$  MHz;  $\sigma = 1.367$  S/m;  $\epsilon_r = 41.1$ ;  $\rho = 1000$  kg/m<sup>3</sup>

Phantom section: Center Section

DASY5 Configuration:

- Probe: EX3DV4 - SN7514; ConvF(7.73, 7.73, 7.73) @ 1900 MHz; Calibrated: 8/27/2018
- Sensor-Surface: 1.4mm (Mechanical Surface Detection)
- Electronics: DAE4 Sn1555; Calibrated: 8/20/2018
- Phantom: MFP\_V5.1C ; Type: QD 000 P51CA; Serial: 1062
- Measurement SW: DASY32, Version 52.10 (2); SEMCAD X Version 14.6.12 (7450)

**System Performance Check/Zoom Scan (7x7x7) (7x7x7)/Cube 0; Measurement grid:**

$dx=5$ mm,  $dy=5$ mm,  $dz=5$ mm

Reference Value = 102.2 V/m; Power Drift = 0.05 dB

Peak SAR (extrapolated) = 19.0 W/kg

SAR(1 g) = 9.92 W/kg; SAR(10 g) = 5.17 W/kg

Maximum value of SAR (measured) = 15.7 W/kg

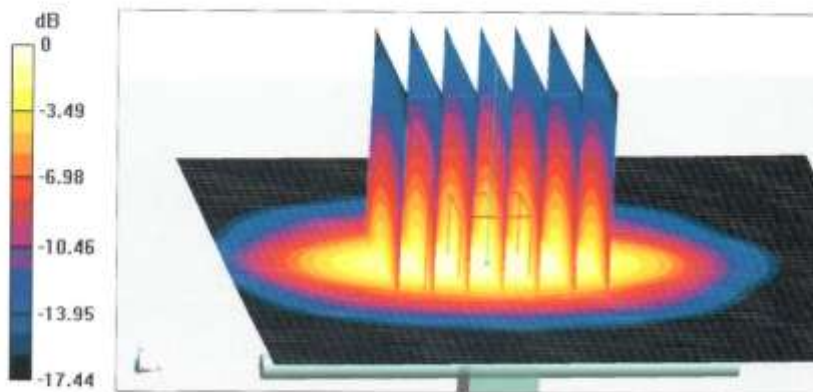

0 dB = 15.7 W/kg = 11.96 dBW/kg



Add: No.51 Xueyuan Road, Haidian District, Beijing, 100191, China  
Tel: +86-10-62304633-2079 Fax: +86-10-62304633-2504  
E-mail: cttl@chinattl.com http://www.chinattl.cn

Impedance Measurement Plot for Head TSL

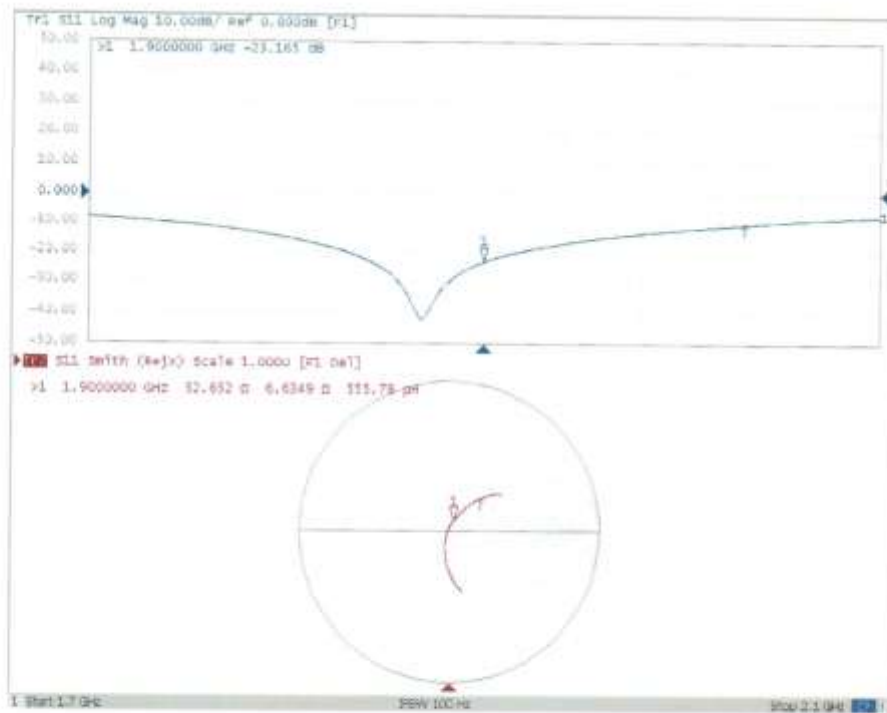



Add: No.51 Xueyuan Road, Haidian District, Beijing, 100191, China  
 Tel: +86-10-62304633-2079 Fax: +86-10-62304633-2504  
 E-mail: cttl@chinattl.com http://www.chinattl.cn

**DASY5 Validation Report for Body TSL**

Date: 10.24.2018

Test Laboratory: CTTL, Beijing, China

**DUT: Dipole 1900 MHz; Type: D1900V2; Serial: D1900V2 - SN: 5d088**

Communication System: UID 0, CW; Frequency: 1900 MHz; Duty Cycle: 1:1

Medium parameters used:  $f = 1900$  MHz;  $\sigma = 1.551$  S/m;  $\epsilon_r = 52.63$ ;  $\rho = 1000$  kg/m<sup>3</sup>

Phantom section: Right Section

DASY5 Configuration:

- Probe: EX3DV4 - SN7514; ConvF(7.53, 7.53, 7.53) @ 1900 MHz; Calibrated: 8/27/2018
- Sensor-Surface: 1.4mm (Mechanical Surface Detection)
- Electronics: DAE4 Sn1555; Calibrated: 8/20/2018
- Phantom: MFP V5.1C ; Type: QD 000 P51CA; Serial: 1062
- Measurement SW: DASY52, Version 52.10 (2); SEMCAD X Version 14.6.12 (7450)

**System Performance Check/Zoom Scan (7x7x7) (7x7x7)/Cube 0: Measurement grid:**

$dx=5$ mm,  $dy=5$ mm,  $dz=5$ mm

Reference Value = 97.60 V/m; Power Drift = -0.02 dB

Peak SAR (extrapolated) = 19.0 W/kg

SAR(1 g) = 10.3 W/kg; SAR(10 g) = 5.41 W/kg

Maximum value of SAR (measured) = 15.9 W/kg

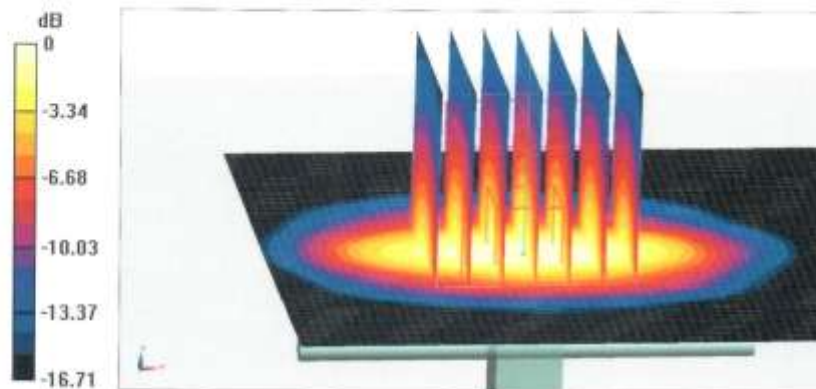

0 dB = 15.9 W/kg = 12.01 dBW/kg



Add: No.51 Xueyuan Road, Haidian District, Beijing, 100191, China  
Tel: +86-10-62304633-2079 Fax: +86-10-62304633-2504  
E-mail: ttl@chinattl.com http://www.chinattl.cn

Impedance Measurement Plot for Body TSL

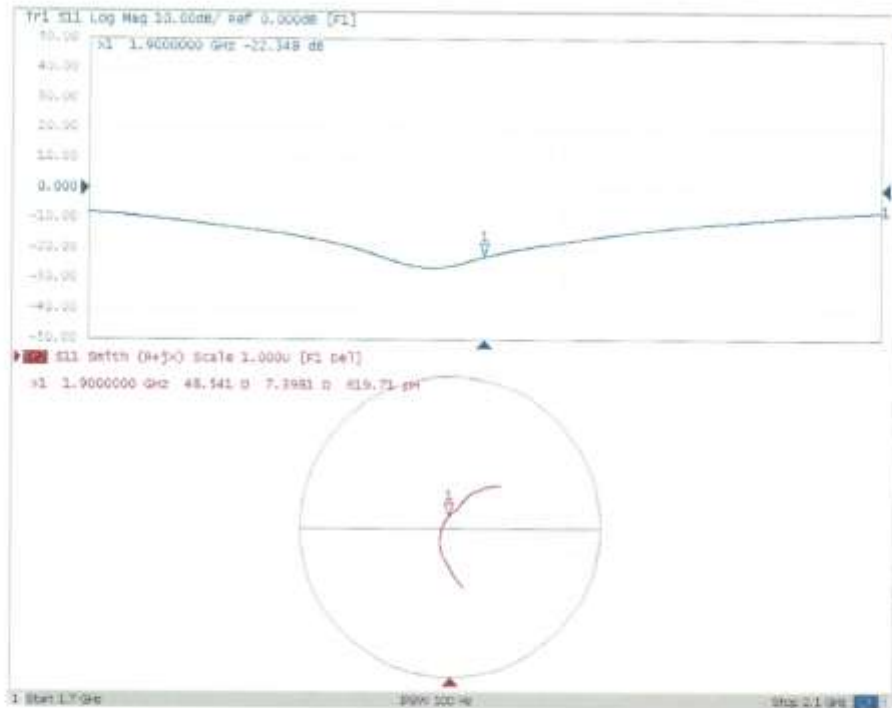



2450 MHz Dipole Calibration Certificate



In Collaboration with  
**s p e a g**  
CALIBRATION LABORATORY



中国认可  
国际互认  
校准  
CALIBRATION  
CNAS L0570

Add: No.51 Xueyuan Road, Haidian District, Beijing, 100191, China  
Tel: +86-10-62304633-2079 Fax: +86-10-62304633-2504  
E-mail: cttl@chinattl.com http://www.chinattl.cn

Client **CTTL(South Branch)**

Certificate No: **Z18-60388**

CALIBRATION CERTIFICATE			
Object	D2450V2 - SN: 873		
Calibration Procedure(s)	FF-Z11-003-01 Calibration Procedures for dipole validation kits		
Calibration date:	October 26, 2018		
This calibration Certificate documents the traceability to national standards, which realize the physical units of measurements(SI). The measurements and the uncertainties with confidence probability are given on the following pages and are part of the certificate.			
All calibrations have been conducted in the closed laboratory facility: environment temperature(22±3)°C and humidity<70%.			
Calibration Equipment used (M&TE critical for calibration)			
Primary Standards	ID #	Cal Date(Calibrated by, Certificate No.)	Scheduled Calibration
Power Meter NRVD	102083	01-Nov-17 (CTTL, No.J17X08756)	Oct-18
Power sensor NRV-Z5	100542	01-Nov-17 (CTTL, No.J17X08756)	Oct-18
Reference Probe EX3DV4	SN 7514	27-Aug-18(SPEAG,No.EX3-7514_Aug18)	Aug-19
DAE4	SN 1555	20-Aug-18(SPEAG,No.DAE4-1555_Aug18)	Aug-19
Secondary Standards	ID #	Cal Date(Calibrated by, Certificate No.)	Scheduled Calibration
Signal Generator E4438C	MY49071430	23-Jan-18 (CTTL, No.J18X00560)	Jan-19
NetworkAnalyzer E5071C	MY46110673	24-Jan-18 (CTTL, No.J18X00561)	Jan-19
Calibrated by:	Name Zhao Jing	Function SAR Test Engineer	Signature 
Reviewed by:	Name Lin Hao	Function SAR Test Engineer	Signature 
Approved by:	Name Qi Dianyuan	Function SAR Project Leader	Signature 
Issued: October 29, 2018			
This calibration certificate shall not be reproduced except in full without written approval of the laboratory.			



In Collaboration with  
**s p e a g**  
CALIBRATION LABORATORY

Add: No.51 Xueyuan Road, Haidian District, Beijing, 100191, China  
Tel: +86-10-62304633-2079 Fax: +86-10-62304633-2504  
E-mail: cttl@chinattl.com http://www.chinattl.cn

**Glossary:**

TSL	tissue simulating liquid
ConvF	sensitivity in TSL / NORM <sub>x,y,z</sub>
N/A	not applicable or not measured

**Calibration is Performed According to the Following Standards:**

- IEEE Std 1528-2013, "IEEE Recommended Practice for Determining the Peak Spatial-Averaged Specific Absorption Rate (SAR) in the Human Head from Wireless Communications Devices: Measurement Techniques", June 2013
- IEC 62209-1, "Measurement procedure for assessment of specific absorption rate of human exposure to radio frequency fields from hand-held and body-mounted wireless communication devices- Part 1: Device used next to the ear (Frequency range of 300MHz to 6GHz)", July 2016
- IEC 62209-2, "Procedure to measure the Specific Absorption Rate (SAR) For wireless communication devices used in close proximity to the human body (frequency range of 30MHz to 6GHz)", March 2010
- KDB865664, SAR Measurement Requirements for 100 MHz to 6 GHz

**Additional Documentation:**

- DASY4/5 System Handbook

**Methods Applied and Interpretation of Parameters:**

- Measurement Conditions:** Further details are available from the Validation Report at the end of the certificate. All figures stated in the certificate are valid at the frequency indicated.
- Antenna Parameters with TSL:** The dipole is mounted with the spacer to position its feed point exactly below the center marking of the flat phantom section, with the arms oriented parallel to the body axis.
- Feed Point Impedance and Return Loss:** These parameters are measured with the dipole positioned under the liquid filled phantom. The impedance stated is transformed from the measurement at the SMA connector to the feed point. The Return Loss ensures low reflected power. No uncertainty required.
- Electrical Delay:** One-way delay between the SMA connector and the antenna feed point. No uncertainty required.
- SAR measured:** SAR measured at the stated antenna input power.
- SAR normalized:** SAR as measured, normalized to an input power of 1 W at the antenna connector.
- SAR for nominal TSL parameters:** The measured TSL parameters are used to calculate the nominal SAR result.

The reported uncertainty of measurement is stated as the standard uncertainty of Measurement multiplied by the coverage factor  $k=2$ , which for a normal distribution Corresponds to a coverage probability of approximately 95%.



In Collaboration with  
**s p e a g**  
 CALIBRATION LABORATORY

Add: No.51 Xueyuan Road, Haidian District, Beijing, 100191, China  
 Tel: +86-10-62304633-2079 Fax: +86-10-62304633-2504  
 E-mail: ttl@chinattl.com http://www.chinattl.cn

### Measurement Conditions

DASY system configuration, as far as not given on page 1.

DASY Version	DASY52	52.10.2.1495
Extrapolation	Advanced Extrapolation	
Phantom	Triple Flat Phantom 5.1C	
Distance Dipole Center - TSL	10 mm	with Spacer
Zoom Scan Resolution	dx, dy, dz = 5 mm	
Frequency	2450 MHz $\pm$ 1 MHz	

### Head TSL parameters

The following parameters and calculations were applied.

	Temperature	Permittivity	Conductivity
Nominal Head TSL parameters	22.0 °C	38.2	1.80 mho/m
Measured Head TSL parameters	(22.0 $\pm$ 0.2) °C	39.2 $\pm$ 6 %	1.80 mho/m $\pm$ 6 %
Head TSL temperature change during test	<1.0 °C	---	---

### SAR result with Head TSL

SAR averaged over 1 $cm^3$ (1 g) of Head TSL	Condition	
SAR measured	250 mW input power	13.0 mW / g
SAR for nominal Head TSL parameters	normalized to 1W	<b>52.0 mW / g <math>\pm</math> 18.8 % (k=2)</b>
SAR averaged over 10 $cm^3$ (10 g) of Head TSL	Condition	
SAR measured	250 mW input power	6.02 mW / g
SAR for nominal Head TSL parameters	normalized to 1W	<b>24.1 mW / g <math>\pm</math> 18.7 % (k=2)</b>

### Body TSL parameters

The following parameters and calculations were applied.

	Temperature	Permittivity	Conductivity
Nominal Body TSL parameters	22.0 °C	52.7	1.95 mho/m
Measured Body TSL parameters	(22.0 $\pm$ 0.2) °C	52.8 $\pm$ 6 %	2.01 mho/m $\pm$ 6 %
Body TSL temperature change during test	<1.0 °C	---	---

### SAR result with Body TSL

SAR averaged over 1 $cm^3$ (1 g) of Body TSL	Condition	
SAR measured	250 mW input power	12.8 mW / g
SAR for nominal Body TSL parameters	normalized to 1W	<b>50.5 mW / g <math>\pm</math> 18.8 % (k=2)</b>
SAR averaged over 10 $cm^3$ (10 g) of Body TSL	Condition	
SAR measured	250 mW input power	5.91 mW / g
SAR for nominal Body TSL parameters	normalized to 1W	<b>23.5 mW / g <math>\pm</math> 18.7 % (k=2)</b>





In Collaboration with  
**s p e a g**  
CALIBRATION LABORATORY

Add: No.51 Xueyuan Road, Haidian District, Beijing, 100191, China  
Tel: +86-10-62304633-2079 Fax: +86-10-62304633-2504  
E-mail: cttl@chinattl.com http://www.chinattl.cn

**Appendix (Additional assessments outside the scope of CNAS L0570)**

**Antenna Parameters with Head TSL**

Impedance, transformed to feed point	53.5Ω+ 2.11 jΩ
Return Loss	- 28.0dB

**Antenna Parameters with Body TSL**

Impedance, transformed to feed point	51.3Ω+ 4.51 jΩ
Return Loss	- 26.7dB

**General Antenna Parameters and Design**

Electrical Delay (one direction)	1.024 ns
----------------------------------	----------

After long term use with 100W radiated power, only a slight warming of the dipole near the feedpoint can be measured.

The dipole is made of standard semirigid coaxial cable. The center conductor of the feeding line is directly connected to the second arm of the dipole. The antenna is therefore short-circuited for DC-signals. On some of the dipoles, small end caps are added to the dipole arms in order to improve matching when loaded according to the position as explained in the "Measurement Conditions" paragraph. The SAR data are not affected by this change. The overall dipole length is still according to the Standard. No excessive force must be applied to the dipole arms, because they might bend or the soldered connections near the feedpoint may be damaged.

**Additional EUT Data**

Manufactured by	SPEAG
-----------------	-------



In Collaboration with  
**s p e a q**  
 CALIBRATION LABORATORY

Add: No.51 Xueyuan Road, Haidian District, Beijing, 100191, China  
 Tel: +86-10-62304633-2079 Fax: +86-10-62304633-2504  
 E-mail: cttf@chinattl.com http://www.chinattl.cn

**DASY5 Validation Report for Head TSL**

Date: 10.26.2018

Test Laboratory: CTTL, Beijing, China

**DUT: Dipole 2450 MHz; Type: D2450V2; Serial: D2450V2 - SN: 873**

Communication System: UID 0, CW; Frequency: 2450 MHz; Duty Cycle: 1:1

Medium parameters used:  $f = 2450$  MHz;  $\sigma = 1.802$  S/m;  $\epsilon_r = 39.2$ ;  $\rho = 1000$  kg/m<sup>3</sup>

Phantom section: Right Section

DASY5 Configuration:

- Probe: EX3DV4 - SN7514; ConvF(6.95, 6.95, 6.95) @ 2450 MHz; Calibrated: 8/27/2018
- Sensor-Surface: 1.4mm (Mechanical Surface Detection)
- Electronics: DAE4 Sn1555; Calibrated: 8/20/2018
- Phantom: MFP\_V5.1C ; Type: QD 000 P51CA; Serial: 1062
- Measurement SW: DASY52, Version 52.10 (2); SEMCAD X Version 14.6.12 (7450)

**Dipole Calibration/Zoom Scan (7x7x7) (7x7x7)/Cube 0:** Measurement grid: dx=5mm, dy=5mm, dz=5mm

Reference Value = 105.0 V/m; Power Drift = 0.09 dB

Peak SAR (extrapolated) = 26.8 W/kg

**SAR(1 g) = 13 W/kg; SAR(10 g) = 6.02 W/kg**

Maximum value of SAR (measured) = 21.8 W/kg

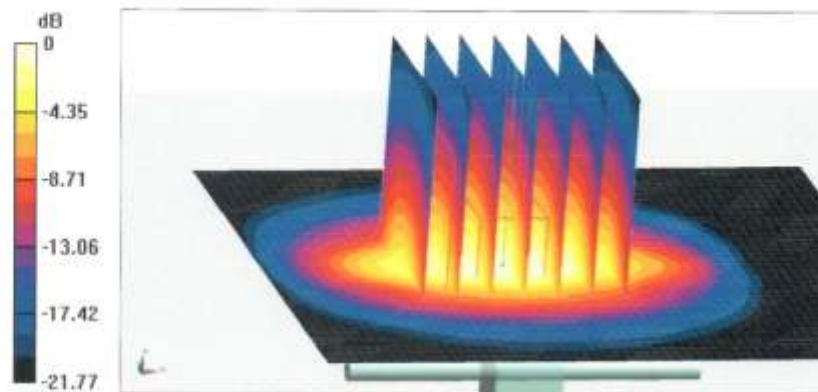

0 dB = 21.8 W/kg = 13.38 dBW/kg



In Collaboration with  
**s p e a g**  
CALIBRATION LABORATORY

Add: No.51 Xueyuan Road, Haidian District, Beijing, 100191, China  
Tel: +86-10-62304633-2079 Fax: +86-10-62304633-3504  
E-mail: cttl@chinattl.com http://www.chinattl.cn

### Impedance Measurement Plot for Head TSL

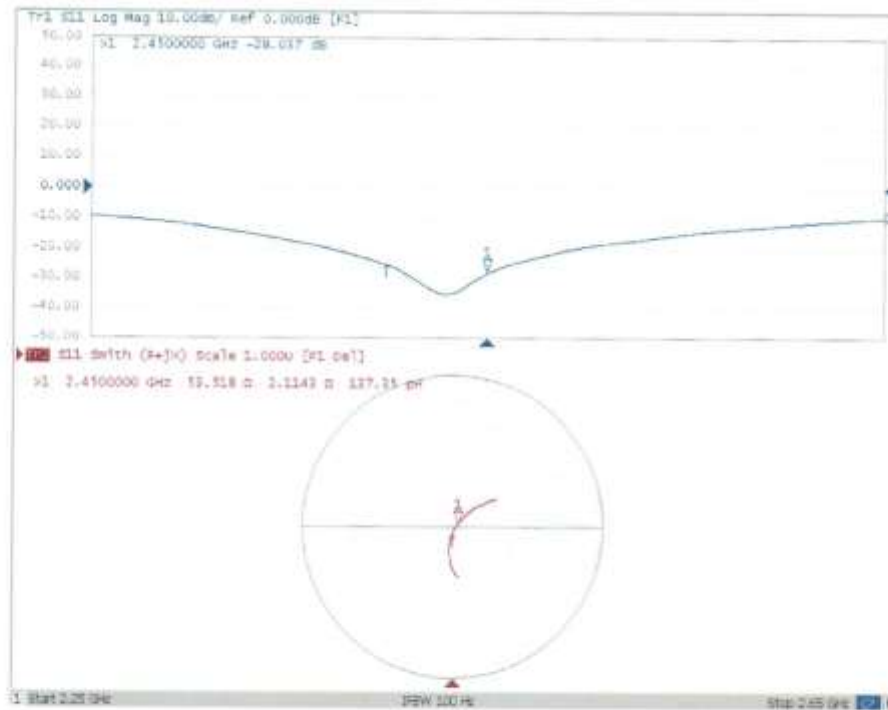



In Collaboration with  
**s p e a g**  
CALIBRATION LABORATORY

Add: No.51 Xueyuan Road, Haidian District, Beijing, 100191, China  
Tel: +86-10-62304633-2079 Fax: +86-10-62304633-2504  
E-mail: cttl@chinattl.com http://www.chinattl.cn

#### DASY5 Validation Report for Body TSL

Date: 10.26.2018

Test Laboratory: CTTL, Beijing, China

**DUT: Dipole 2450 MHz; Type: D2450V2; Serial: D2450V2 - SN: 873**

Communication System: UID 0, CW; Frequency: 2450 MHz; Duty Cycle: 1:1

Medium parameters used:  $f = 2450$  MHz;  $\sigma = 2.008$  S/m;  $\epsilon_r = 52.76$ ;  $\rho = 1000$  kg/m<sup>3</sup>

Phantom section: Center Section

DASY5 Configuration:

- Probe: EX3DV4 - SN7514; ConvF(7.13, 7.13, 7.13) @ 2450 MHz; Calibrated: 8/27/2018
- Sensor-Surface: 1.4mm (Mechanical Surface Detection)
- Electronics: DAE4 Sn1555; Calibrated: 8/20/2018
- Phantom: MFP\_V5.1C ; Type: QD 000 P51CA; Serial: 1062
- Measurement SW: DASY52, Version 52.10 (2); SEMCAD X Version 14.6.12 (7450)

**Dipole Calibration/Zoom Scan (7x7x7) (7x7x7)/Cube 0: Measurement grid: dx=5mm, dy=5mm, dz=5mm**

Reference Value = 98.89 V/m; Power Drift = -0.03 dB

Peak SAR (extrapolated) = 26.4 W/kg

**SAR(1 g) = 12.8 W/kg; SAR(10 g) = 5.91 W/kg**

Maximum value of SAR (measured) = 21.3 W/kg

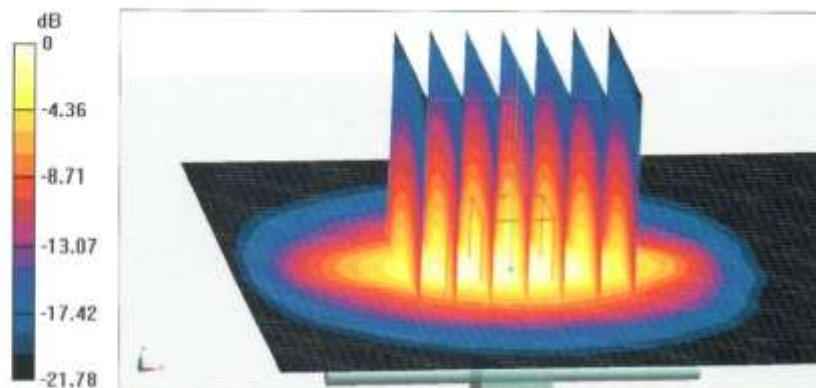

0 dB = 21.3 W/kg = 13.28 dBW/kg



In Collaboration with  
**s p e a g**  
CALIBRATION LABORATORY

Add: No.51 Xueyuan Road, Haidian District, Beijing, 100191, China  
Tel: +86-10-62304633-2079 Fax: +86-10-62304633-2504  
E-mail: cttl@chinattl.com http://www.chinattl.cn

Impedance Measurement Plot for Body TSL

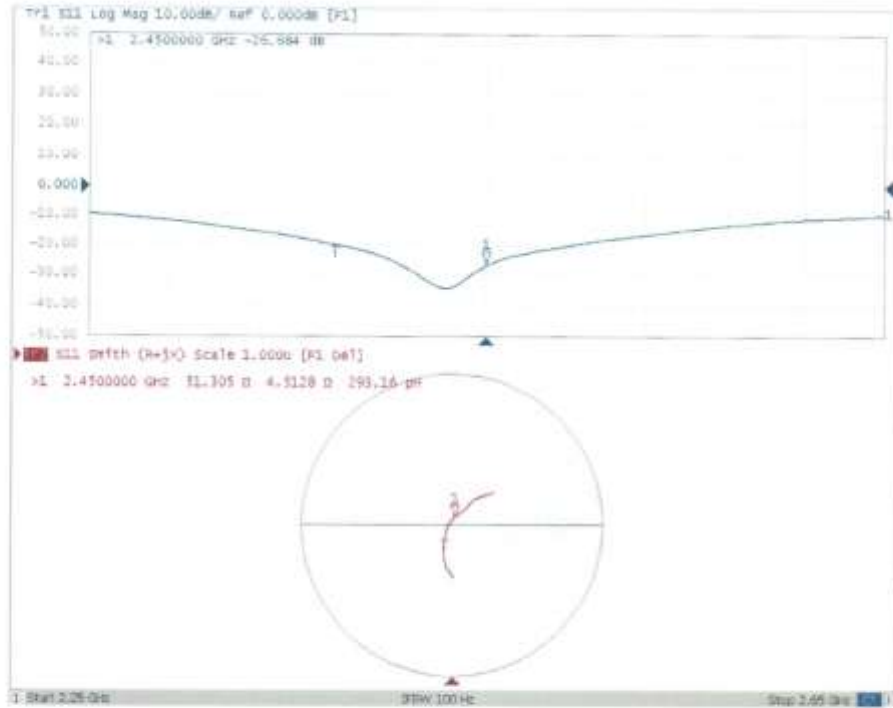

## 2550 MHz Dipole Calibration Certificate

**Calibration Laboratory of**  
**Schmid & Partner**  
**Engineering AG**  
 Zeughausstrasse 43, 8004 Zurich, Switzerland



**S** Schweizerischer Kalibrierdienst  
**C** Service suisse d'étalonnage  
**S** Servizio svizzero di taratura  
**S** Swiss Calibration Service

Accredited by the Swiss Accreditation Service (SAS)  
 The Swiss Accreditation Service is one of the signatories to the EA  
 Multilateral Agreement for the recognition of calibration certificates

Accreditation No.: SCS 0108

 Client **CTTL (Auden)**

 Certificate No: **D2550V2-1010\_Aug18**

CALIBRATION CERTIFICATE			
Object	D2550V2 - SN:1010		
Calibration procedure(s)	QA CAL-05.v10 Calibration procedure for dipole validation kits above 700 MHz		
Calibration date:	August 24, 2018		
This calibration certificate documents the traceability to national standards, which realize the physical units of measurements (SI). The measurements and the uncertainties with confidence probability are given on the following pages and are part of the certificate.			
All calibrations have been conducted in the closed laboratory facility: environment temperature (22 ± 3)°C and humidity < 70%.			
Calibration Equipment used (M&TE critical for calibration)			
Primary Standards	ID #	Cal Date (Certificate No.)	Scheduled Calibration
Power meter NRP	SN: 104778	04-Apr-18 (No. 217-02672/02673)	Apr-19
Power sensor NRP-Z91	SN: 103244	04-Apr-18 (No. 217-02672)	Apr-19
Power sensor NRP-Z91	SN: 103245	04-Apr-18 (No. 217-02673)	Apr-19
Reference 20 dB Attenuator	SN: 5058 (20k)	04-Apr-18 (No. 217-02682)	Apr-19
Type-N mismatch combination	SN: 5047,2 / 08327	04-Apr-18 (No. 217-02683)	Apr-19
Reference Probe EX3DV4	SN: 7349	30-Dec-17 (No. EX3-7349_Dec17)	Dec-18
DAE4	SN: 601	26-Oct-17 (No. DAE4-601_Oct17)	Oct-18
Secondary Standards	ID #	Check Date (in house)	Scheduled Check
Power meter EPM-442A	SN: GB37480704	07-Oct-15 (in house check Oct-16)	In house check: Oct-18
Power sensor HP 8481A	SN: US37292783	07-Oct-15 (in house check Oct-16)	In house check: Oct-18
Power sensor HP 8481A	SN: MY41092317	07-Oct-15 (in house check Oct-16)	In house check: Oct-18
RF generator R&S SMT-06	SN: 100972	15-Jun-15 (in house check Oct-16)	In house check: Oct-18
Network Analyzer Agilent E8358A	SN: US41080477	31-Mar-14 (in house check Oct-17)	In house check: Oct-18
Calibrated by:	Name Manu Seitz	Function Laboratory Technician	Signature 
Approved by:	Name Katja Pokovic	Function Technical Manager	Signature 
			Issued: August 24, 2018
This calibration certificate shall not be reproduced except in full without written approval of the laboratory.			

**Calibration Laboratory of**  
Schmid & Partner  
Engineering AG  
Zeughausstrasse 43, 8004 Zurich, Switzerland



S Schweizerischer Kalibrierdienst  
C Service suisse d'étalonnage  
C Servizio svizzero di taratura  
S Swiss Calibration Service

Accredited by the Swiss Accreditation Service (SAS).  
The Swiss Accreditation Service is one of the signatories to the EA  
Multilateral Agreement for the recognition of calibration certificates.

Accreditation No.: SCS 0108

#### Glossary:

TSL tissue simulating liquid  
ConvF sensitivity in TSL / NORM x,y,z  
N/A not applicable or not measured

#### Calibration is Performed According to the Following Standards:

- IEEE Std 1528-2013, "IEEE Recommended Practice for Determining the Peak Spatial-Averaged Specific Absorption Rate (SAR) in the Human Head from Wireless Communications Devices: Measurement Techniques", June 2013
- IEC 62209-1, "Measurement procedure for the assessment of Specific Absorption Rate (SAR) from hand-held and body-mounted devices used next to the ear (frequency range of 300 MHz to 6 GHz)", July 2016
- IEC 62209-2, "Procedure to determine the Specific Absorption Rate (SAR) for wireless communication devices used in close proximity to the human body (frequency range of 30 MHz to 6 GHz)", March 2010
- KDB 865664, "SAR Measurement Requirements for 100 MHz to 6 GHz"

#### Additional Documentation:

- DASY4/5 System Handbook

#### Methods Applied and Interpretation of Parameters:

- Measurement Conditions:** Further details are available from the Validation Report at the end of the certificate. All figures stated in the certificate are valid at the frequency indicated.
- Antenna Parameters with TSL:** The dipole is mounted with the spacer to position its feed point exactly below the center marking of the flat phantom section, with the arms oriented parallel to the body axis.
- Feed Point Impedance and Return Loss:** These parameters are measured with the dipole positioned under the liquid filled phantom. The impedance stated is transformed from the measurement at the SMA connector to the feed point. The Return Loss ensures low reflected power. No uncertainty required.
- Electrical Delay:** One-way delay between the SMA connector and the antenna feed point. No uncertainty required.
- SAR measured:** SAR measured at the stated antenna input power.
- SAR normalized:** SAR as measured, normalized to an input power of 1 W at the antenna connector.
- SAR for nominal TSL parameters:** The measured TSL parameters are used to calculate the nominal SAR result.

The reported uncertainty of measurement is stated as the standard uncertainty of measurement multiplied by the coverage factor  $k=2$ , which for a normal distribution corresponds to a coverage probability of approximately 95%.

**Measurement Conditions**

DASY system configuration, as far as not given on page 1.

DASY Version	DASY5	V52.10.1
Extrapolation	Advanced Extrapolation	
Phantom	Modular Flat Phantom	
Distance Dipole Center - TSL	10 mm	with Spacer
Zoom Scan Resolution	dx, dy, dz = 5 mm	
Frequency	2550 MHz $\pm$ 1 MHz	

**Head TSL parameters**

The following parameters and calculations were applied.

	Temperature	Permittivity	Conductivity
Nominal Head TSL parameters	22.0 °C	39.1	1.91 mho/m
Measured Head TSL parameters	(22.0 $\pm$ 0.2) °C	37.3 $\pm$ 6 %	1.97 mho/m $\pm$ 6 %
Head TSL temperature change during test	< 0.5 °C	----	----

**SAR result with Head TSL**

SAR averaged over 1 cm <sup>3</sup> (1 g) of Head TSL	Condition	
SAR measured	250 mW input power	14.8 W/kg
SAR for nominal Head TSL parameters	normalized to 1W	<b>57.8 W/kg <math>\pm</math> 17.0 % (k=2)</b>

SAR averaged over 10 cm <sup>3</sup> (10 g) of Head TSL	condition	
SAR measured	250 mW input power	6.73 W/kg
SAR for nominal Head TSL parameters	normalized to 1W	<b>26.5 W/kg <math>\pm</math> 16.5 % (k=2)</b>

**Body TSL parameters**

The following parameters and calculations were applied.

	Temperature	Permittivity	Conductivity
Nominal Body TSL parameters	22.0 °C	52.6	2.09 mho/m
Measured Body TSL parameters	(22.0 $\pm$ 0.2) °C	51.5 $\pm$ 6 %	2.14 mho/m $\pm$ 6 %
Body TSL temperature change during test	< 0.5 °C	----	----

**SAR result with Body TSL**

SAR averaged over 1 cm <sup>3</sup> (1 g) of Body TSL	Condition	
SAR measured	250 mW input power	13.7 W/kg
SAR for nominal Body TSL parameters	normalized to 1W	<b>54.0 W/kg <math>\pm</math> 17.0 % (k=2)</b>

SAR averaged over 10 cm <sup>3</sup> (10 g) of Body TSL	condition	
SAR measured	250 mW input power	6.22 W/kg
SAR for nominal Body TSL parameters	normalized to 1W	<b>24.7 W/kg <math>\pm</math> 16.5 % (k=2)</b>



**Appendix (Additional assessments outside the scope of SCS 0108)****Antenna Parameters with Head TSL**

Impedance, transformed to feed point	54.9 $\Omega$ - 2.3 j $\Omega$
Return Loss	- 25.7 dB

**Antenna Parameters with Body TSL**

Impedance, transformed to feed point	49.6 $\Omega$ - 2.0 j $\Omega$
Return Loss	- 33.8 dB

**General Antenna Parameters and Design**

Electrical Delay (one direction)	1.151 ns
----------------------------------	----------

After long term use with 100W radiated power, only a slight warming of the dipole near the feedpoint can be measured.

The dipole is made of standard semirigid coaxial cable. The center conductor of the feeding line is directly connected to the second arm of the dipole. The antenna is therefore short-circuited for DC-signals. On some of the dipoles, small end caps are added to the dipole arms in order to improve matching when loaded according to the position as explained in the "Measurement Conditions" paragraph. The SAR data are not affected by this change. The overall dipole length is still according to the Standard.

No excessive force must be applied to the dipole arms, because they might bend or the soldered connections near the feedpoint may be damaged.

**Additional EUT Data**

Manufactured by	SPEAG
Manufactured on	August 03, 2012

**DASY5 Validation Report for Head TSL**

Date: 24.08.2018

Test Laboratory: SPEAG, Zurich, Switzerland

**DUT: Dipole 2550 MHz; Type: D2550V2; Serial: D2550V2 - SN:1010**

Communication System: UID 0 - CW; Frequency: 2550 MHz

Medium parameters used:  $f = 2550$  MHz;  $\sigma = 1.97$  S/m;  $\epsilon_r = 37.3$ ;  $\rho = 1000$  kg/m<sup>3</sup>

Phantom section: Flat Section

Measurement Standard: DASY5 (IEEE/IEC/ANSI C63.19-2011)

DASY52 Configuration:

- Probe: EX3DV4 - SN7349; ConvF(7.43, 7.43, 7.43) @ 2550 MHz; Calibrated: 30.12.2017
- Sensor-Surface: 1.4mm (Mechanical Surface Detection)
- Electronics: DAE4 Sn601; Calibrated: 26.10.2017
- Phantom: Flat Phantom 5.0 (front); Type: QD 000 P50 AA; Serial: 1001
- DASY52 52.10.1(1476); SEMCAD X 14.6.11(7439)

**Dipole Calibration for Head Tissue/Pin=250 mW, d=10mm/Zoom Scan (7x7x7)/Cube 0:**

Measurement grid: dx=5mm, dy=5mm, dz=5mm

Reference Value = 119.6 V/m; Power Drift = -0.07 dB

Peak SAR (extrapolated) = 30.5 W/kg

**SAR(1 g) = 14.8 W/kg; SAR(10 g) = 6.73 W/kg**

Maximum value of SAR (measured) = 24.9 W/kg

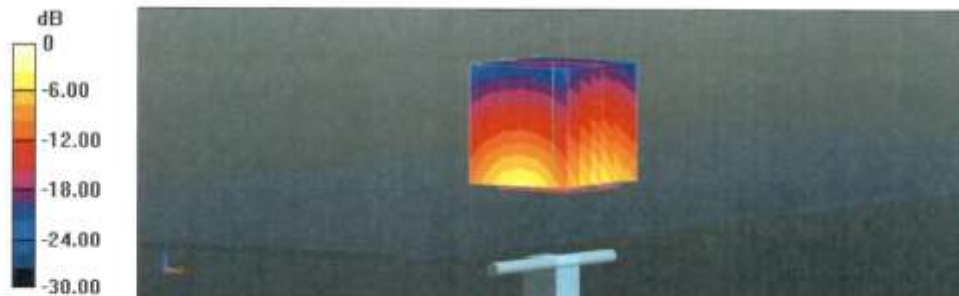

0 dB = 24.9 W/kg = 13.96 dBW/kg

Impedance Measurement Plot for Head TSL

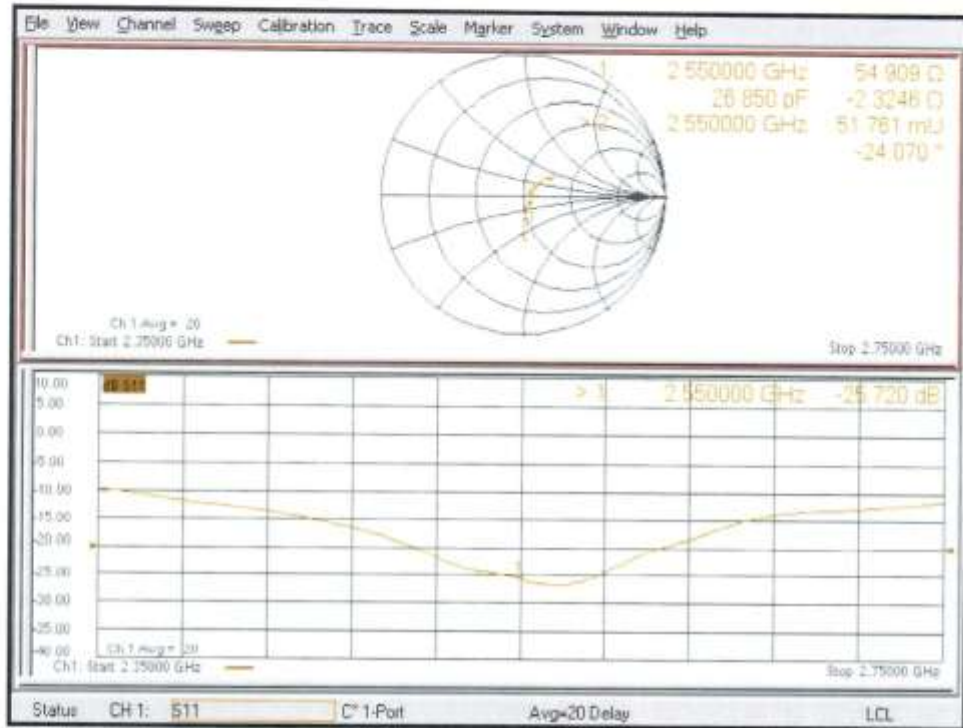

**DASY5 Validation Report for Body TSL**

Date: 24.08.2018

Test Laboratory: SPEAG, Zurich, Switzerland

**DUT: Dipole 2550 MHz; Type: D2550V2; Serial: D2550V2 - SN:1010**

Communication System: UID 0 - CW; Frequency: 2550 MHz

Medium parameters used:  $f = 2550$  MHz;  $\sigma = 2.14$  S/m;  $\epsilon_r = 51.5$ ;  $\rho = 1000$  kg/m<sup>3</sup>

Phantom section: Flat Section

Measurement Standard: DASY5 (IEEE/IEC/ANSI C63.19-2011)

DASY52 Configuration:

- Probe: EX3DV4 - SN7349; ConvF(7.68, 7.68, 7.68) @ 2550 MHz; Calibrated: 30.12.2017
- Sensor-Surface: 1.4mm (Mechanical Surface Detection)
- Electronics: DAE4 Sn601; Calibrated: 26.10.2017
- Phantom: Flat Phantom 5.0 (back); Type: QD 000 P50 AA; Serial: 1002
- DASY52 52.10.1(1476); SEMCAD X 14.6.11(7439)

**Dipole Calibration for Body Tissue/Pin=250 mW, d=10mm/Zoom Scan (7x7x7)/Cube 0:**

Measurement grid: dx=5mm, dy=5mm, dz=5mm

Reference Value = 109.2 V/m; Power Drift = -0.03 dB

Peak SAR (extrapolated) = 27.9 W/kg

**SAR(1 g) = 13.7 W/kg; SAR(10 g) = 6.22 W/kg**

Maximum value of SAR (measured) = 22.9 W/kg

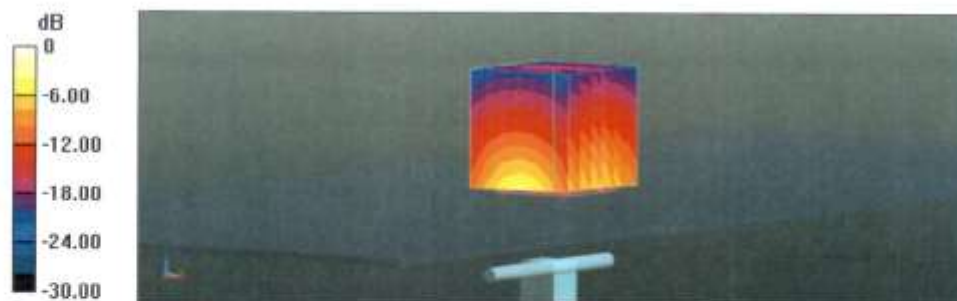

0 dB = 22.9 W/kg = 13.60 dBW/kg

Impedance Measurement Plot for Body TSL

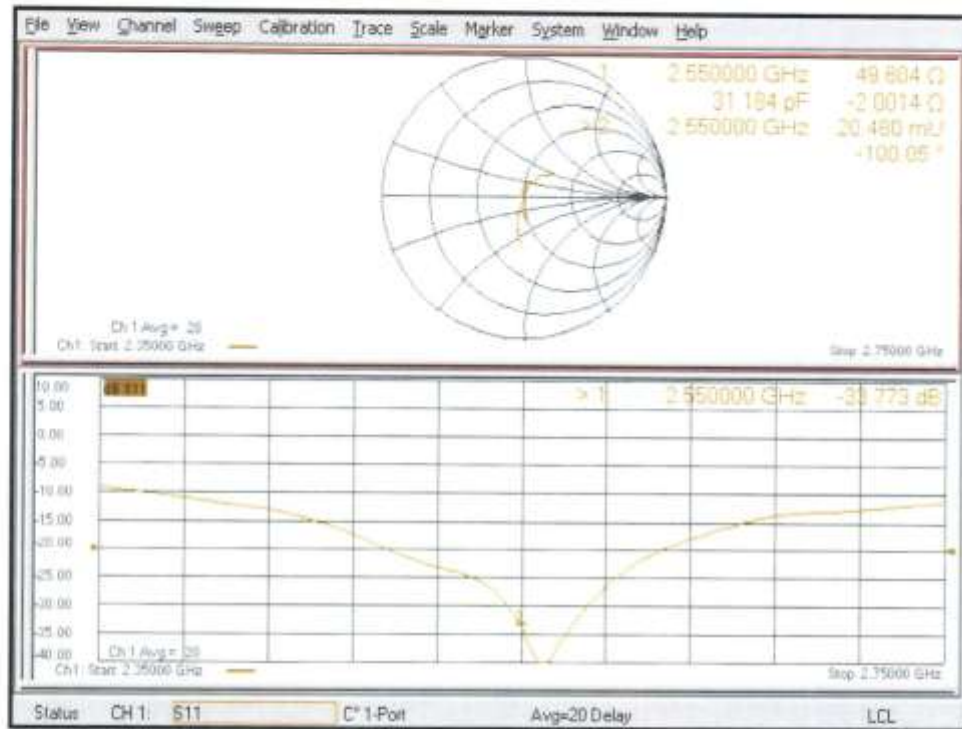

## ANNEX K: Extended Calibration SAR Dipole

Referring to KDB865664 D01, if dipoles are verified in return loss ( $< -20\text{dBm}$ , within 20% of prior calibration), and in impedance (within 5 ohm of prior calibration), the annual calibration is not necessary and the calibration interval can be extended.

Justification of Extended Calibration SAR Dipole D750V3– serial no.1163

Head						
Date of Measurement	Return-Loss (dB)	Delta (%)	Real Impedance (ohm)	Delta (ohm)	Imaginary Impedance (johm)	Delta (johm)
2019-09-03	-26.9	/	50.5	/	-4.53	/
2020-09-01	-25.8	4.1	51.2	0.7	-4.29	0.24

Justification of Extended Calibration SAR Dipole D835V2– serial no.4d057

Head						
Date of Measurement	Return-Loss (dB)	Delta (%)	Real Impedance (ohm)	Delta (ohm)	Imaginary Impedance (johm)	Delta (johm)
2018-10-09	-27.7	/	54.9	/	-2.30	/
2019-10-06	-26.9	2.9	55.8	0.9	-2.22	0.08
2020-10-05	-25.4	8.3	56.7	1.8	-2.15	0.15

Justification of Extended Calibration SAR Dipole D1750V2– serial no.1152

Head						
Date of Measurement	Return-Loss (dB)	Delta (%)	Real Impedance (ohm)	Delta (ohm)	Imaginary Impedance (johm)	Delta (johm)
2019-08-30	-38.1	/	49.1	/	-0.84	/
2020-08-28	-36.5	4.2	50.2	1.1	-0.49	0.35

Justification of Extended Calibration SAR Dipole D1900V2– serial no. 5d088

Head						
Date of Measurement	Return-Loss (dB)	Delta (%)	Real Impedance (ohm)	Delta (ohm)	Imaginary Impedance (johm)	Delta (johm)
2018-10-24	-23.2	/	52.7	/	6.63	/
2019-10-22	-22.9	1.3	53.5	0.8	6.86	0.23
2020-10-20	-20.7	10.8	54.4	1.7	6.95	0.32

## Justification of Extended Calibration SAR Dipole D2450V2– serial no. 873

Head						
Date of Measurement	Return-Loss (dB)	Delta (%)	Real Impedance (ohm)	Delta (ohm)	Imaginary Impedance (johm)	Delta (johm)
2018-10-26	-28.0	/	53.5	/	2.11	/
2019-10-22	-27.3	2.5	54.4	0.9	2.29	0.18
2020-10-20	-24.9	11.1	55.1	1.6	2.46	0.35

## Justification of Extended Calibration SAR Dipole D2550V2– serial no.1010

Head						
Date of Measurement	Return-Loss (dB)	Delta (%)	Real Impedance (ohm)	Delta (ohm)	Imaginary Impedance (johm)	Delta (johm)
2018-08-24	-25.7	/	54.9	/	-2.30	/
2019-08-22	-24.8	3.5	55.8	0.9	-2.22	0.08
2020-08-20	-23.2	9.7	56.4	1.5	-2.13	0.17

The Return-Loss is <-20dB, and within 20% of prior calibration; the impedance is within 5 ohm of prior calibration. Therefore the value result should support extended cabration.

## ANNEX L: Accreditation Certificate

  
**Accredited Laboratory**  
A2LA has accredited  
**SHENZHEN ACADEMY OF INFORMATION AND COMMUNICATIONS TECHNOLOGY**  
*Shenzhen, People's Republic of China*  
for technical competence in the field of  
**Electrical Testing**  

This laboratory is accredited in accordance with the recognized International Standard ISO/IEC 17025:2017 *General requirements for the competence of testing and calibration laboratories*. This accreditation demonstrates technical competence for a defined scope and the operation of a laboratory quality management system (refer to joint ISO-ILAC-IAF Communiqué dated April 2017).

  
Presented this 30<sup>th</sup> day of October 2019.  
  
Vice President, Accreditation Services  
For the Accreditation Council  
Certificate Number 4353.01  
Valid to November 30, 2021  

*For the tests to which this accreditation applies, please refer to the laboratory's Electrical Scope of Accreditation.*

\*\*\*END OF REPORT\*\*\*