

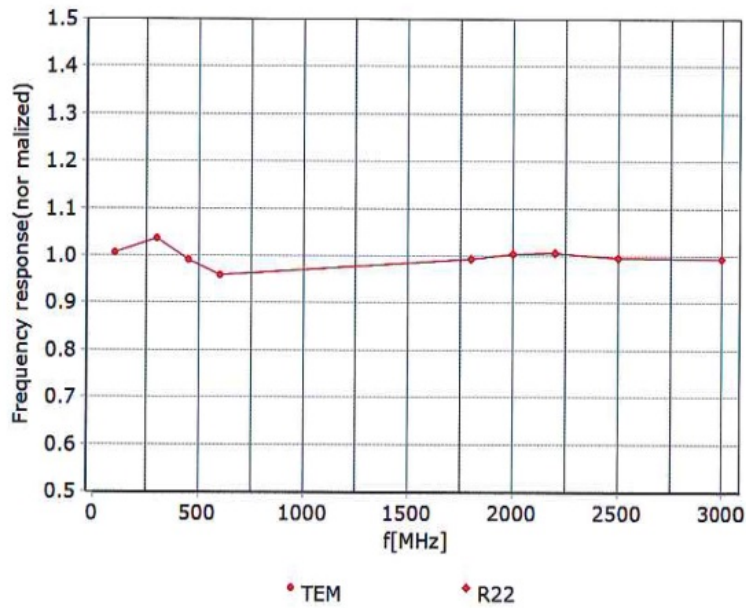

### Frequency Response of E-Field (TEM-Cell: ifi110 EXX, Waveguide: R22)



Uncertainty of Frequency Response of E-field:  $\pm 7.4\%$  ( $k=2$ )



Add: No.51 Xueyuan Road, Haidian District, Beijing, 100191, China  
Tel: +86-10-62304633-2512 Fax: +86-10-62304633-2504  
E-mail: cttl@chinattl.com [Http://www.chinattl.cn](http://www.chinattl.cn)

### Receiving Pattern ( $\Phi$ ), $\theta=0^\circ$

**f=600 MHz, TEM**

**f=1800 MHz, R22**

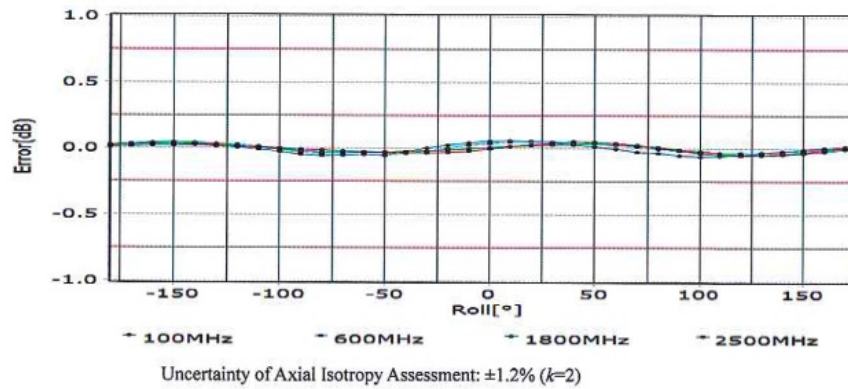
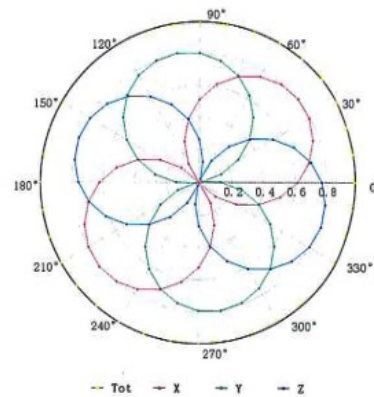
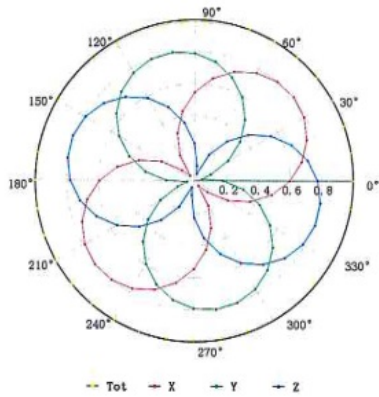

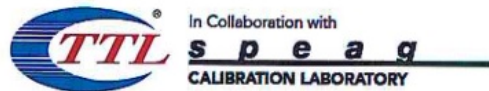

Add: No.51 Xueyuan Road, Haidian District, Beijing, 100191, China  
Tel: +86-10-62304633-2512 Fax: +86-10-62304633-2504  
E-mail: cttl@chinattl.com [Http://www.chinattl.cn](http://www.chinattl.cn)

### Dynamic Range f(SAR<sub>head</sub>) (TEM cell, f = 900 MHz)

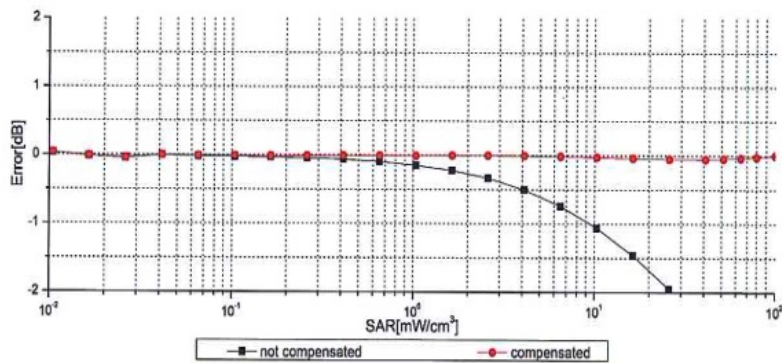
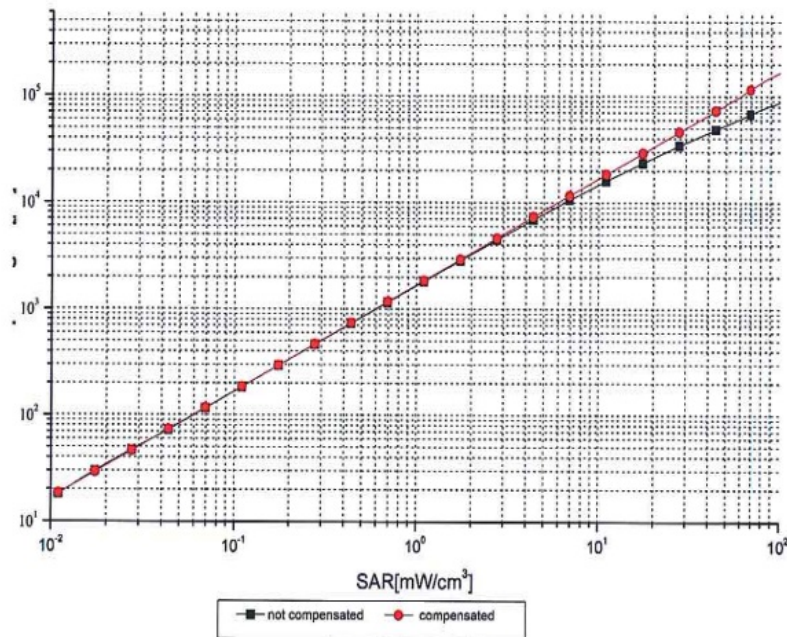

Uncertainty of Linearity Assessment: ±0.9% (k=2)



Add: No.51 Xueyuan Road, Haidian District, Beijing, 100191, China  
Tel: +86-10-62304633-2512 Fax: +86-10-62304633-2504  
E-mail: cttl@chinattl.com [Http://www.chinattl.cn](http://www.chinattl.cn)

### Conversion Factor Assessment

f=750 MHz,WGLS R9(H\_convF)

f=1810 MHz,WGLS R22(H\_convF)

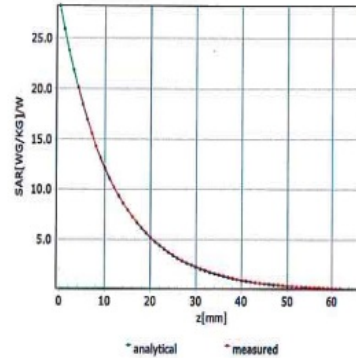
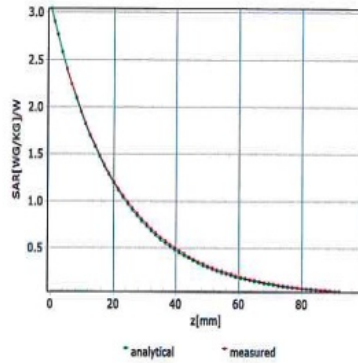

### Deviation from Isotropy in Liquid

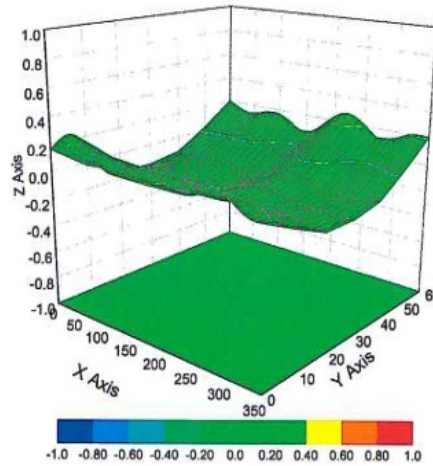

Uncertainty of Spherical Isotropy Assessment:  $\pm 3.2\%$  ( $k=2$ )



Add: No.51 Xueyuan Road, Haidian District, Beijing, 100191, China  
Tel: +86-10-62304633-2512 Fax: +86-10-62304633-2504  
E-mail: cttl@chinattl.com [Http://www.chinattl.cn](http://www.chinattl.cn)

## DASY/EASY – Parameters of Probe: ES3DV3 – SN:3127

### Other Probe Parameters

|   |            |
|---|------------|
| Sensor Arrangement                            | Triangular |
| Connector Angle (°)                           | 160.8      |
| Mechanical Surface Detection Mode             | enabled    |
| Optical Surface Detection Mode                | disable    |
| Probe Overall Length                          | 337mm      |
| Probe Body Diameter                           | 10mm       |
| Tip Length                                    | 10mm       |
| Tip Diameter                                  | 4mm        |
| Probe Tip to Sensor X Calibration Point       | 2mm        |
| Probe Tip to Sensor Y Calibration Point       | 2mm        |
| Probe Tip to Sensor Z Calibration Point       | 2mm        |
| Recommended Measurement Distance from Surface | 3mm        |

D750V3 Sn:1101



In Collaboration with  
**s p e a g**  
CALIBRATION LABORATORY



中国认可  
国际互认  
校准  
CALIBRATION  
CNAS L0570

Add: No.51 Xueyuan Road, Haidian District, Beijing, 100191, China  
Tel: +86-10-62304633-2079 Fax: +86-10-62304633-2504  
E-mail: cttl@chinattl.com http://www.chinattl.cn

Client **SRTC**

Certificate No: **Z17-97134**

**CALIBRATION CERTIFICATE**

Object **D750V3 - SN: 1101**

Calibration Procedure(s) **FF-Z11-003-01**  
**Calibration Procedures for dipole validation kits**

Calibration date: **September 13, 2017**

This calibration Certificate documents the traceability to national standards, which realize the physical units of measurements(SI). The measurements and the uncertainties with confidence probability are given on the following pages and are part of the certificate.

All calibrations have been conducted in the closed laboratory facility: environment temperature(22±3)°C and humidity<70%.

Calibration Equipment used (M&TE critical for calibration)

| Primary Standards       | ID #       | Cal Date(Calibrated by, Certificate No.) | Scheduled Calibration |
|-------------------------|------------|--|-----------------------|
| Power Meter NRVD        | 102196     | 02-Mar-17 (CTTL, No.J17X01254)           | Mar-18                |
| Power sensor NRV-Z5     | 100596     | 02-Mar-17 (CTTL, No.J17X01254)           | Mar-18                |
| Reference Probe EX3DV4  | SN 7433    | 26-Sep-16(SPEAG,No.EX3-7433_Sep16)       | Sep-17                |
| DAE4                    | SN 1331    | 19-Jan-17(CTTL-SPEAG,No.Z17-97015)       | Jan-18                |
| Secondary Standards     | ID #       | Cal Date(Calibrated by, Certificate No.) | Scheduled Calibration |
| Signal Generator E4438C | MY49071430 | 13-Jan-17 (CTTL, No.J17X00286)           | Jan-18                |
| Network Analyzer E5071C | MY46111013 | 13-Jan-17 (CTTL, No.J17X00285)           | Jan-18                |

|                | Name        | Function           | Signature |
|----------------|-------------|--------------------|-----------|
| Calibrated by: | Zhao Jing   | SAR Test Engineer  |           |
| Reviewed by:   | Yu Zongying | SAR Test Engineer  |           |
| Approved by:   | Qi Dianyuan | SAR Project Leader |           |

Issued: September 16, 2017

This calibration certificate shall not be reproduced except in full without written approval of the laboratory.

Certificate No: Z17-97134

Page 1 of 8

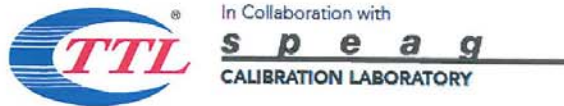

Add: No.51 Xueyuan Road, Haidian District, Beijing, 100191, China  
Tel: +86-10-62304633-2079 Fax: +86-10-62304633-2504  
E-mail: cttl@chinattl.com http://www.chinattl.cn

**Glossary:**

|       |  |
|-------|--|
| TSL   | tissue simulating liquid                   |
| ConvF | sensitivity in TSL / NORM <sub>x,y,z</sub> |
| N/A   | not applicable or not measured             |

**Calibration is Performed According to the Following Standards:**

- IEEE Std 1528-2013, "IEEE Recommended Practice for Determining the Peak Spatial-Averaged Specific Absorption Rate (SAR) in the Human Head from Wireless Communications Devices: Measurement Techniques", June 2013
- IEC 62209-1, "Measurement procedure for assessment of specific absorption rate of human exposure to radio frequency fields from hand-held and body-mounted wireless communication devices- Part 1: Device used next to the ear (Frequency range of 300MHz to 6GHz)", July 2016
- IEC 62209-2, "Procedure to measure the Specific Absorption Rate (SAR) For wireless communication devices used in close proximity to the human body (frequency range of 30MHz to 6GHz)", March 2010
- KDB865664, SAR Measurement Requirements for 100 MHz to 6 GHz

**Additional Documentation:**

- DASY4/5 System Handbook

**Methods Applied and Interpretation of Parameters:**

- Measurement Conditions:* Further details are available from the Validation Report at the end of the certificate. All figures stated in the certificate are valid at the frequency indicated.
- Antenna Parameters with TSL:* The dipole is mounted with the spacer to position its feed point exactly below the center marking of the flat phantom section, with the arms oriented parallel to the body axis.
- Feed Point Impedance and Return Loss:* These parameters are measured with the dipole positioned under the liquid filled phantom. The impedance stated is transformed from the measurement at the SMA connector to the feed point. The Return Loss ensures low reflected power. No uncertainty required.
- Electrical Delay:* One-way delay between the SMA connector and the antenna feed point. No uncertainty required.
- SAR measured:* SAR measured at the stated antenna input power.
- SAR normalized:* SAR as measured, normalized to an input power of 1 W at the antenna connector.
- SAR for nominal TSL parameters:* The measured TSL parameters are used to calculate the nominal SAR result.

The reported uncertainty of measurement is stated as the standard uncertainty of Measurement multiplied by the coverage factor  $k=2$ , which for a normal distribution Corresponds to a coverage probability of approximately 95%.



Add: No.51 Xueyuan Road, Haidian District, Beijing, 100191, China  
Tel: +86-10-62304633-2079 Fax: +86-10-62304633-2504  
E-mail: cttl@chinattl.com http://www.chinattl.cn

### Measurement Conditions

DASY system configuration, as far as not given on page 1.

|                              |                          |              |
|------------------------------|--------------------------|--------------|
| DASY Version                 | DASY52                   | 52.10.0.1446 |
| Extrapolation                | Advanced Extrapolation   |              |
| Phantom                      | Triple Flat Phantom 5.1C |              |
| Distance Dipole Center - TSL | 15 mm                    | with Spacer  |
| Zoom Scan Resolution         | dx, dy, dz = 5 mm        |              |
| Frequency                    | 750 MHz ± 1 MHz          |              |

### Head TSL parameters

The following parameters and calculations were applied.

|   | Temperature     | Permittivity | Conductivity     |
|---|-----------------|--------------|------------------|
| Nominal Head TSL parameters             | 22.0 °C         | 41.9         | 0.89 mho/m       |
| Measured Head TSL parameters            | (22.0 ± 0.2) °C | 41.5 ± 6 %   | 0.88 mho/m ± 6 % |
| Head TSL temperature change during test | <1.0 °C         | ----         | ----             |

### SAR result with Head TSL

|   |                    |                            |
|---|--------------------|----------------------------|
| SAR averaged over 1 cm <sup>3</sup> (1 g) of Head TSL   | Condition          |                            |
| SAR measured  | 250 mW input power | 2.05 mW / g                |
| SAR for nominal Head TSL parameters                     | normalized to 1W   | 8.26 mW / g ± 18.8 % (k=2) |
| SAR averaged over 10 cm <sup>3</sup> (10 g) of Head TSL | Condition          |                            |
| SAR measured  | 250 mW input power | 1.34 mW / g                |
| SAR for nominal Head TSL parameters                     | normalized to 1W   | 5.39 mW / g ± 18.7 % (k=2) |

### Body TSL parameters

The following parameters and calculations were applied.

|   | Temperature     | Permittivity | Conductivity     |
|---|-----------------|--------------|------------------|
| Nominal Body TSL parameters             | 22.0 °C         | 55.5         | 0.96 mho/m       |
| Measured Body TSL parameters            | (22.0 ± 0.2) °C | 55.4 ± 6 %   | 0.95 mho/m ± 6 % |
| Body TSL temperature change during test | <1.0 °C         | ----         | ----             |

### SAR result with Body TSL

|   |                    |                            |
|---|--------------------|----------------------------|
| SAR averaged over 1 cm <sup>3</sup> (1 g) of Body TSL   | Condition          |                            |
| SAR measured  | 250 mW input power | 2.15 mW / g                |
| SAR for nominal Body TSL parameters                     | normalized to 1W   | 8.69 mW / g ± 18.8 % (k=2) |
| SAR averaged over 10 cm <sup>3</sup> (10 g) of Body TSL | Condition          |                            |
| SAR measured  | 250 mW input power | 1.42 mW / g                |
| SAR for nominal Body TSL parameters                     | normalized to 1W   | 5.73 mW / g ± 18.7 % (k=2) |





Add: No.51 Xueyuan Road, Haidian District, Beijing, 100191, China  
Tel: +86-10-62304633-2079 Fax: +86-10-62304633-2504  
E-mail: cttl@chinattl.com http://www.chinattl.cn

### Appendix (Additional assessments outside the scope of CNAS L0570)

#### Antenna Parameters with Head TSL

|                                      |               |
|--------------------------------------|---------------|
| Impedance, transformed to feed point | 53.9Ω+ 0.24jΩ |
| Return Loss                          | - 28.4dB      |

#### Antenna Parameters with Body TSL

|                                      |               |
|--------------------------------------|---------------|
| Impedance, transformed to feed point | 52.0Ω- 2.22jΩ |
| Return Loss                          | - 30.6dB      |

#### General Antenna Parameters and Design

|                                  |          |
|----------------------------------|----------|
| Electrical Delay (one direction) | 1.136 ns |
|----------------------------------|----------|

After long term use with 100W radiated power, only a slight warming of the dipole near the feedpoint can be measured.

The dipole is made of standard semirigid coaxial cable. The center conductor of the feeding line is directly connected to the second arm of the dipole. The antenna is therefore short-circuited for DC-signals. On some of the dipoles, small end caps are added to the dipole arms in order to improve matching when loaded according to the position as explained in the "Measurement Conditions" paragraph. The SAR data are not affected by this change. The overall dipole length is still according to the Standard. No excessive force must be applied to the dipole arms, because they might bend or the soldered connections near the feedpoint may be damaged.

#### Additional EUT Data

|                 |       |
|-----------------|-------|
| Manufactured by | SPEAG |
|-----------------|-------|



Add: No.51 Xueyuan Road, Haidian District, Beijing, 100191, China  
Tel: +86-10-62304633-2079 Fax: +86-10-62304633-2504  
E-mail: cttl@chinattl.com http://www.chinattl.cn

**DASY5 Validation Report for Head TSL**

Date: 09.13.2017

Test Laboratory: CTTL, Beijing, China

**DUT: Dipole 750 MHz; Type: D750V3; Serial: D750V3 - SN: 1101**

Communication System: UID 0, CW; Frequency: 750 MHz; Duty Cycle: 1:1

Medium parameters used:  $f = 750 \text{ MHz}$ ;  $\sigma = 0.879 \text{ S/m}$ ;  $\epsilon_r = 41.54$ ;  $\rho = 1000 \text{ kg/m}^3$

Phantom section: Left Section

Measurement Standard: DASY5 (IEEE/IEC/ANSI C63.19-2007)

DASY5 Configuration:

- Probe: EX3DV4 - SN7433; ConvF(10.01, 10.01, 10.01); Calibrated: 9/26/2016;
- Sensor-Surface: 1.4mm (Mechanical Surface Detection)
- Electronics: DAE4 Sn1331; Calibrated: 1/19/2017
- Phantom: Triple Flat Phantom 5.1C; Type: QD 000 P51 CA; Serial: 1161/1
- Measurement SW: DASY52, Version 52.10 (0); SEMCAD X Version 14.6.10 (7417)

**Dipole Calibration/Zoom Scan (7x7x7) (7x7x7)/Cube 0:** Measurement grid: dx=5mm, dy=5mm, dz=5mm

Reference Value = 53.10 V/m; Power Drift = -0.05 dB

Peak SAR (extrapolated) = 3.17 W/kg

**SAR(1 g) = 2.05 W/kg; SAR(10 g) = 1.34 W/kg**

Maximum value of SAR (measured) = 2.77 W/kg

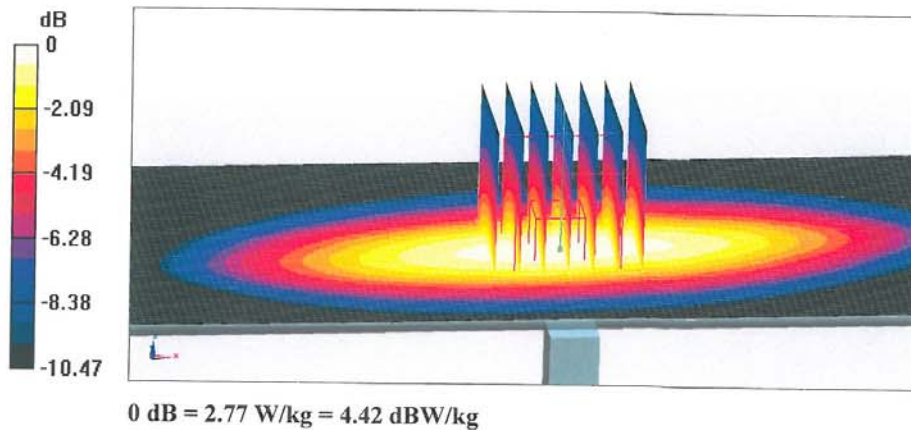

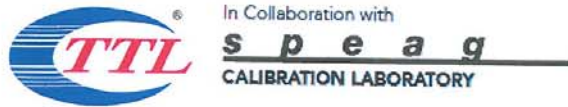

Add: No.51 Xueyuan Road, Haidian District, Beijing, 100191, China  
Tel: +86-10-62304633-2079 Fax: +86-10-62304633-2504  
E-mail: cttl@chinattl.com http://www.chinattl.cn

**Impedance Measurement Plot for Head TSL**

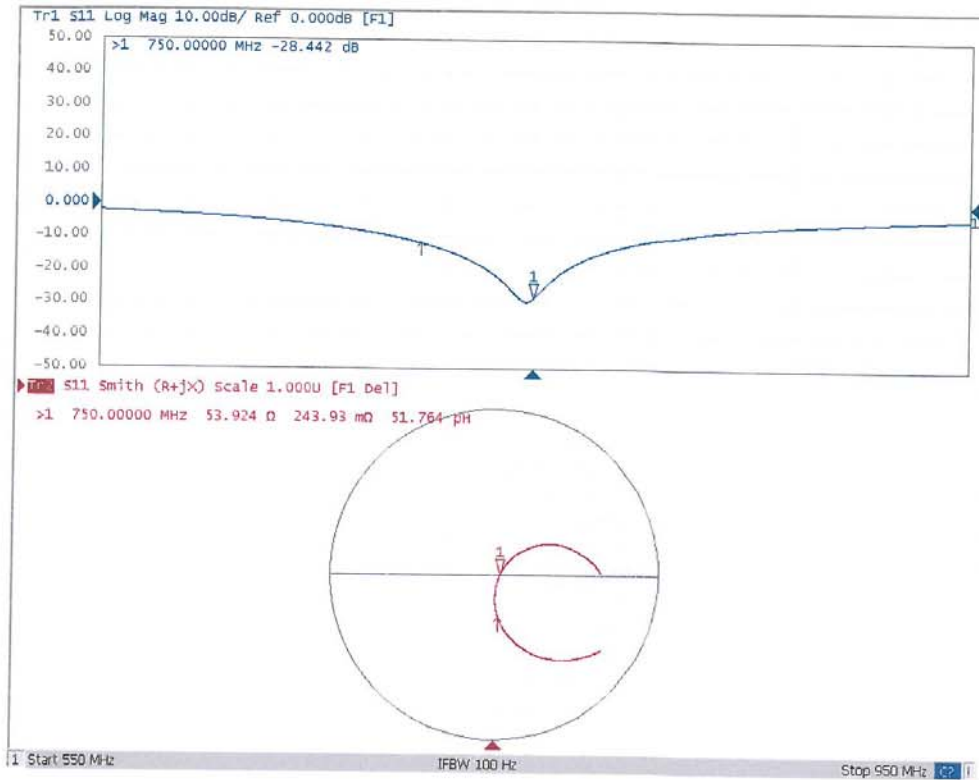



Add: No.51 Xueyuan Road, Haidian District, Beijing, 100191, China  
Tel: +86-10-62304633-2079 Fax: +86-10-62304633-2504  
E-mail: ctatl@chinattl.com http://www.chinattl.cn

**DASY5 Validation Report for Body TSL**

Date: 09.13.2017

Test Laboratory: CTTL, Beijing, China

**DUT: Dipole 750 MHz; Type: D750V3; Serial: D750V3 - SN: 1101**

Communication System: UID 0, CW; Frequency: 750 MHz; Duty Cycle: 1:1

Medium parameters used:  $f = 750 \text{ MHz}$ ;  $\sigma = 0.946 \text{ S/m}$ ;  $\epsilon_r = 55.41$ ;  $\rho = 1000 \text{ kg/m}^3$

Phantom section: Center Section

Measurement Standard: DASY5 (IEEE/IEC/ANSI C63.19-2007)

DASY5 Configuration:

- Probe: EX3DV4 - SN7433; ConvF(9.83, 9.83, 9.83); Calibrated: 9/26/2016;
- Sensor-Surface: 1.4mm (Mechanical Surface Detection)
- Electronics: DAE4 Sn1331; Calibrated: 1/19/2017
- Phantom: Triple Flat Phantom 5.1C; Type: QD 000 P51 CA; Serial: 1161/1
- Measurement SW: DASY52, Version 52.10 (0); SEMCAD X Version 14.6.10 (7417)

**Dipole Calibration/Zoom Scan (7x7x7) (7x7x7)/Cube 0:** Measurement grid: dx=5mm, dy=5mm, dz=5mm

Reference Value = 53.35 V/m; Power Drift = -0.02 dB

Peak SAR (extrapolated) = 3.27 W/kg

**SAR(1 g) = 2.15 W/kg; SAR(10 g) = 1.42 W/kg**

Maximum value of SAR (measured) = 2.88 W/kg

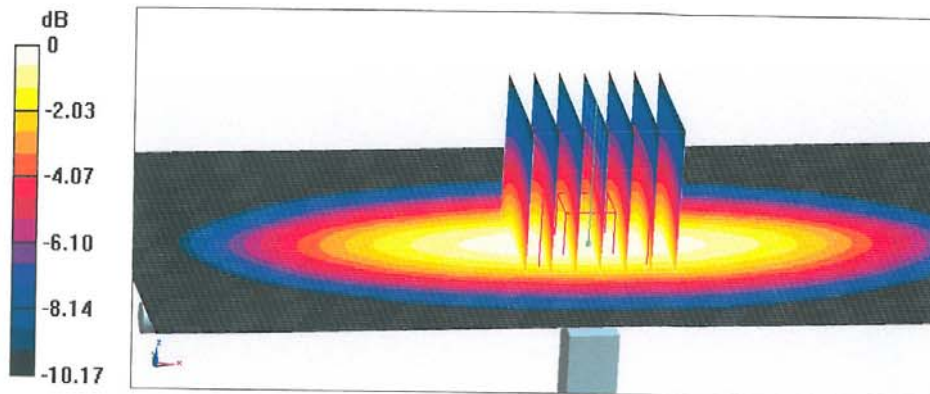

0 dB = 2.88 W/kg = 4.59 dBW/kg

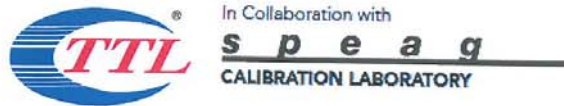

Add: No.51 Xueyuan Road, Haidian District, Beijing, 100191, China  
Tel: +86-10-62304633-2079 Fax: +86-10-62304633-2504  
E-mail: cttl@chinattl.com http://www.chinattl.cn

**Impedance Measurement Plot for Body TSL**

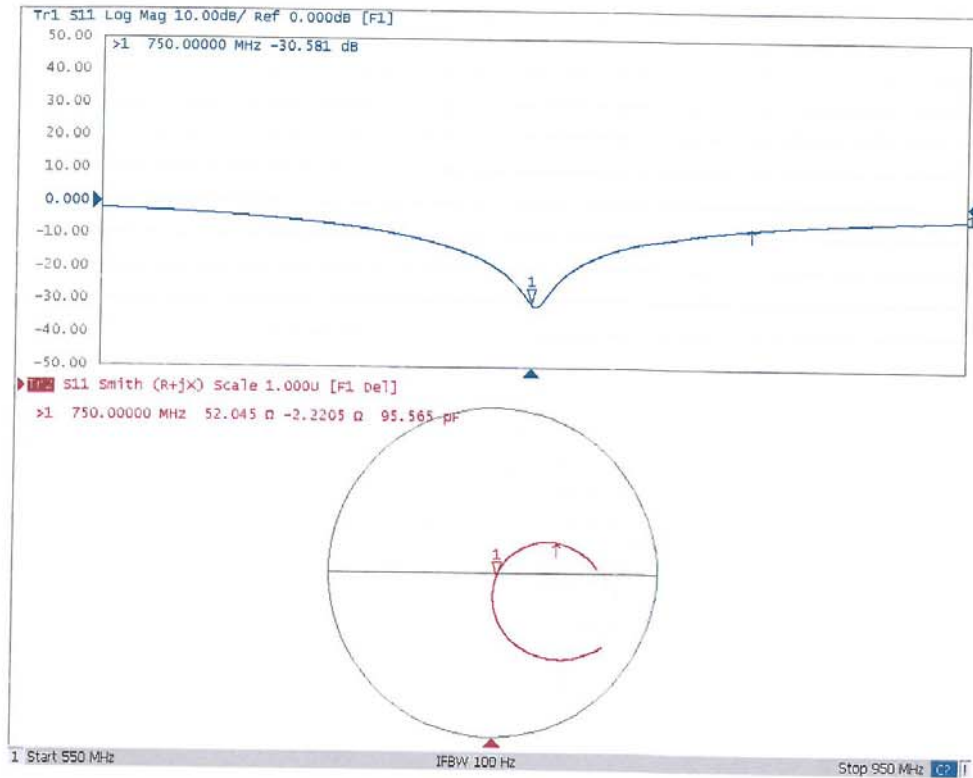

D835V2 Sn:4d023



In Collaboration with  
**s p e a g**  
CALIBRATION LABORATORY

Add: No.31 Xueyuan Road, Haidian District, Beijing, 100191, China  
Tel: +86-10-62304633-2079 Fax: +86-10-62304633-3504  
E-mail: crtl@chinattl.com http://www.chinattl.cn



中国认可  
国际互认  
校准  
CALIBRATION  
CNAS L0570

Client **SRTC**

Certificate No: **Z17-97135**

**CALIBRATION CERTIFICATE**

Object: D835V2 - SN: 4d023  
Calibration Procedure(s): FF-Z11-003-01  
Calibration Procedures for dipole validation kits  
Calibration date: September 13, 2017

This calibration Certificate documents the traceability to national standards, which realize the physical units of measurements(SI). The measurements and the uncertainties with confidence probability are given on the following pages and are part of the certificate.

All calibrations have been conducted in the closed laboratory facility: environment temperature:(22±3)°C and humidity<70%.

Calibration Equipment used (M&TE critical for calibration)

| Primary Standards              | ID #       | Cal Date/(Calibrated by, Certificate No.) | Scheduled Calibration |
|--------------------------------|------------|---|-----------------------|
| Power Meter NRVD               | 102196     | 02-Mar-17 (CTTL, No.J17X01254)            | Mar-18                |
| Power sensor NRV-Z5            | 100596     | 02-Mar-17 (CTTL, No.J17X01254)            | Mar-18                |
| Reference Probe EX3DV4<br>DAL4 | SN 7433    | 26-Sep-16(SPEAG,No.EX3-7433_Sep16)        | Sep-17                |
|                                | SN 1331    | 19-Jan-17(CTTL-SPEAG,No.Z17-97015)        | Jan-18                |
| Secondary Standards            | ID #       | Cal Date/(Calibrated by, Certificate No.) | Scheduled Calibration |
| Signal Generator E4438C        | MY49071430 | 13-Jan-17 (CTTL, No.J17X00286)            | Jan-18                |
| Network Analyzer E5071C        | MY46110673 | 13-Jan-17 (CTTL, No.J17X00285)            | Jan-18                |

|                | Name        | Function           | Signature |
|----------------|-------------|--------------------|-----------|
| Calibrated by: | Zhao Jing   | SAR Test Engineer  |           |
| Reviewed by:   | Yu Zongying | SAR Test Engineer  |           |
| Approved by:   | Qi Dianyuan | SAR Project Leader |           |

Issued: September 16, 2017

This calibration certificate shall not be reproduced except in full without written approval of the laboratory.



Address: No. 51 Xueyuan Road, Haidian District, Beijing, 100191, China  
Tel: +86-10-62304633-2079 Fax: +86-10-62304633-2504  
E-mail: crl@chinard.com http://www.chinard.cn

**Glossary:**

|       |  |
|-------|--|
| TSL   | tissue simulating liquid                   |
| ConvF | sensitivity in TSL / NORM <sub>x,y,z</sub> |
| N/A   | not applicable or not measured             |

**Calibration is Performed According to the Following Standards:**

- IEEE Std 1528-2013, "IEEE Recommended Practice for Determining the Peak Spatial-Averaged Specific Absorption Rate (SAR) in the Human Head from Wireless Communications Devices: Measurement Techniques", June 2013
- IEC 62209-1, "Measurement procedure for assessment of specific absorption rate of human exposure to radio frequency fields from hand-held and body-mounted wireless communication devices- Part 1: Device used next to the ear (Frequency range of 300MHz to 6GHz)", July 2016
- IEC 62209-2, "Procedure to measure the Specific Absorption Rate (SAR) For wireless communication devices used in close proximity to the human body (frequency range of 30MHz to 6GHz)", March 2010
- KDB865664, SAR Measurement Requirements for 100 MHz to 6 GHz

**Additional Documentation:**

- DASY4/5 System Handbook

**Methods Applied and Interpretation of Parameters:**

- Measurement Conditions:** Further details are available from the Validation Report at the end of the certificate. All figures stated in the certificate are valid at the frequency indicated.
- Antenna Parameters with TSL:** The dipole is mounted with the spacer to position its feed point exactly below the center marking of the flat phantom section, with the arms oriented parallel to the body axis.
- Feed Point Impedance and Return Loss:** These parameters are measured with the dipole positioned under the liquid filled phantom. The impedance stated is transformed from the measurement at the SMA connector to the feed point. The Return Loss ensures low reflected power. No uncertainty required.
- Electrical Delay:** One-way delay between the SMA connector and the antenna feed point. No uncertainty required.
- SAR measured:** SAR measured at the stated antenna input power.
- SAR normalized:** SAR as measured, normalized to an input power of 1 W at the antenna connector.
- SAR for nominal TSL parameters:** The measured TSL parameters are used to calculate the nominal SAR result.

The reported uncertainty of measurement is stated as the standard uncertainty of Measurement multiplied by the coverage factor  $k=2$ , which for a normal distribution corresponds to a coverage probability of approximately 95%.



Add: No.51 Xueyuan Road, Haidian District, Beijing, 100191, China  
Tel: +86-10-62304633-2079 Fax: +86-10-62304633-2504  
E-mail: srtg@chinanet.com http://www.shinettl.cn

**Measurement Conditions**

DASY system configuration, as far as not given on page 1

|                              |                          |              |
|------------------------------|--------------------------|--------------|
| DASY Version                 | DASY52                   | 52.10.0.1446 |
| Extrapolation                | Advanced Extrapolation   |              |
| Phantom                      | Triple Flat Phantom 5.1C |              |
| Distance Dipole Center - TSL | 15 mm                    | with Spacer  |
| Zoom Scan Resolution         | dx, dy, dz = 5 mm        |              |
| Frequency                    | 835 MHz ± 1 MHz          |              |

**Head TSL parameters**

The following parameters and calculations were applied.

|   | Temperature     | Permittivity | Conductivity     |
|---|-----------------|--------------|------------------|
| Nominal Head TSL parameters             | 22.0 °C         | 41.5         | 0.90 mho/m       |
| Measured Head TSL parameters            | (22.0 ± 0.2) °C | 41.3 ± 6 %   | 0.90 mho/m ± 8 % |
| Head TSL temperature change during test | <1.0 °C         | ----         | ----             |

**SAR result with Head TSL**

| SAR averaged over 1 $cm^3$ (1 g) of Head TSL   | Condition          |                           |
|--|--------------------|---------------------------|
| SAR measured                                   | 250 mW input power | 2.35 mW / g               |
| SAR for nominal Head TSL parameters            | normalized to 1W   | 9.37 mW /g ± 18.8 % (k=2) |
| SAR averaged over 10 $cm^3$ (10 g) of Head TSL | Condition          |                           |
| SAR measured                                   | 250 mW input power | 1.52 mW / g               |
| SAR for nominal Head TSL parameters            | normalized to 1W   | 6.06 mW /g ± 18.7 % (k=2) |

**Body TSL parameters**

The following parameters and calculations were applied.

|   | Temperature     | Permittivity | Conductivity     |
|---|-----------------|--------------|------------------|
| Nominal Body TSL parameters             | 22.0 °C         | 55.2         | 0.97 mho/m       |
| Measured Body TSL parameters            | (22.0 ± 0.2) °C | 55.7 ± 6 %   | 0.96 mho/m ± 5 % |
| Body TSL temperature change during test | <1.0 °C         | ----         | ----             |

**SAR result with Body TSL**

| SAR averaged over 1 $cm^3$ (1 g) of Body TSL   | Condition          |                           |
|--|--------------------|---------------------------|
| SAR measured                                   | 250 mW input power | 2.34 mW / g               |
| SAR for nominal Body TSL parameters            | normalized to 1W   | 9.47 mW /g ± 18.8 % (k=2) |
| SAR averaged over 10 $cm^3$ (10 g) of Body TSL | Condition          |                           |
| SAR measured                                   | 250 mW input power | 1.53 mW / g               |
| SAR for nominal Body TSL parameters            | normalized to 1W   | 6.17 mW /g ± 18.7 % (k=2) |





In Collaboration with  
 Add: No.51 Xueyuan Road, Haidian District, Beijing, 100191, China  
 Tel: +86-10-62304633-2079 Fax: +86-10-62304633-2504  
 E-mail: crli@china.ttl.com.cn http://www.chinatit.com

**Appendix (Additional assessments outside the scope of CNAS L0570)**

**Antenna Parameters with Head TSL**

|                                      |               |
|--------------------------------------|---------------|
| Impedance, transformed to feed point | 51.0Ω- 2.79jΩ |
| Return Loss                          | - 30.7dB      |

**Antenna Parameters with Body TSL**

|                                      |               |
|--------------------------------------|---------------|
| Impedance, transformed to feed point | 46.6Ω- 3.61jΩ |
| Return Loss                          | - 25.8dB      |

**General Antenna Parameters and Design**

|                                  |          |
|----------------------------------|----------|
| Electrical Delay (one direction) | 1.485 ns |
|----------------------------------|----------|

After long term use with 100W radiated power, only a slight warming of the dipole near the feedpoint can be measured.

The dipole is made of standard semirigid coaxial cable. The center conductor of the feeding line is directly connected to the second arm of the dipole. The antenna is therefore short-circuited for DC-signals. On some of the dipoles, small end caps are added to the dipole arms in order to improve matching when loaded according to the position as explained in the "Measurement Conditions" paragraph. The SAR data are not affected by this change. The overall dipole length is still according to the Standard. No excessive force must be applied to the dipole arms, because they might bend or the soldered connections near the feedpoint may be damaged.

**Additional EUT Data**

|                 |       |
|-----------------|-------|
| Manufactured by | SPEAG |
|-----------------|-------|



Address: No.51 Xueyuan Road, Haidian District, Beijing, 100191, China  
Tel: +86-10-62304633-2079 Fax: +86-10-62304633-2504  
E-mail: cttl@chinaatl.com http://www.chinaatl.cn

**DASY5 Validation Report for Head TSL**

Date: 09.13.2017

Test Laboratory: CTTI, Beijing, China

**DUT: Dipole 835 MHz; Type: D835V2; Serial: D835V2 - SN: 4d023**

Communication System: UID 0, CW; Frequency: 835 MHz; Duty Cycle: 1:1

Medium parameters used:  $f = 835 \text{ MHz}$ ;  $\sigma = 0.903 \text{ S/m}$ ;  $\epsilon_r = 41.34$ ;  $\rho = 1000 \text{ kg/m}^3$

Phantom section: Left Section

Measurement Standard: DASY5 (IEEE/IEC/ANSI C63.19-2007)

DASY5 Configuration:

- Probe: EX3DV4 - SN7433; ConvF(9.82, 9.82, 9.82); Calibrated: 9/26/2016;
- Sensor-Surface: 1.4mm (Mechanical Surface Detection)
- Electronics: DAE4 Sn1331; Calibrated: 1/19/2017
- Phantom: Triple Flat Phantom 5.1C; Type: QD 000 P51 CA; Serial: 1161/1
- Measurement SW: DASY52, Version 52.10 (0); SEMCAD X Version 14.6.10 (7417)

**Dipole Calibration/Zoom Scan (7x7x7) (7x7x7)/Cube 0:** Measurement grid: dx=5mm, dy=5mm, dz=5mm

Reference Value = 56.28V/m; Power Drift = -0.02 dB

Peak SAR (extrapolated) = 3.66 W/kg

SAR(1 g) = 2.35 W/kg; SAR(10 g) = 1.52 W/kg

Maximum value of SAR (measured) = 3.21 W/kg

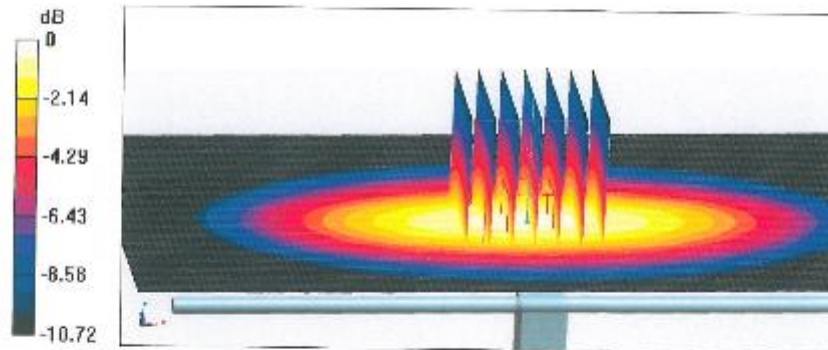

0 dB = 3.21 W/kg = 5.07 dBW/kg



In Collaboration with  
Add: No.51 Xueyuan Road, Haidian District, Beijing, 100191, China  
Tel: +86-10-62314633-2079 Fax: +86-10-62314633-2504  
E-mail: ccl@chinaT.com http://www.chinaT.com

**Impedance Measurement Plot for Head TSL**

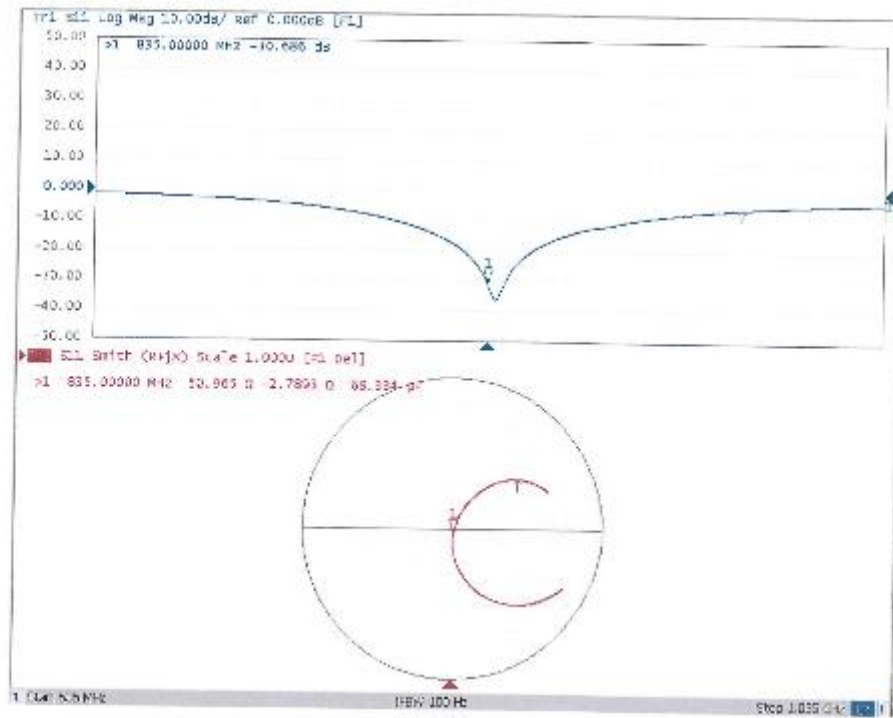



Ad: No.51 Xueyuan Road, Hedian District, Beijing, 100191, China  
Tel: +86-10-62304633-2079 Fax: +86-10-62304633-2504  
E-mail: ent@chinattt.com http://www.chinattt.com

**DASY5 Validation Report for Body TSL**

Date: 09.13.2017

Test Laboratory: CTTT, Beijing, China

**DUT: Dipole 835 MHz; Type: D835V2; Serial: D835V2 - SN: 4d023**

Communication System: UID 0, CW; Frequency: 835 MHz; Duty Cycle: 1:1

Medium parameters used:  $f = 835 \text{ MHz}$ ;  $\sigma = 0.958 \text{ S/m}$ ;  $\epsilon_r = 55.68$ ;  $\rho = 1000 \text{ kg/m}^3$

Phantom section: Center Section

Measurement Standard: DASY5 (IEEE/IEC/ANSI C63.19-2007)

DASY5 Configuration:

- Probe: FX3DV4 - SN7433; ConvF(9.5,9.5, 9.5); Calibrated: 9/26/2016;
- Sensor-Surface: 1.4mm (Mechanical Surface Detection)
- Electronics: DAB4 Sn1331; Calibrated: 1/19/2017
- Phantom: Triple Flat Phantom 5.1C; Type: QD 000 P51 CA; Serial: 1161/1
- Measurement SW: DASY52, Version 52.10 (0); SEMCAD X Version 14.6.10 (7417)

**Dipole Calibration/Zoom Scan (7x7x7) (7x7x7)/Cube 0:** Measurement grid:  $dx=5\text{mm}$ ,  $dy=5\text{mm}$ ,  $dz=5\text{mm}$

Reference Value = 56.17 V/m; Power Drift = -0.01 dB

Peak SAR (extrapolated) = 3.57 W/kg

SAR(1 g) = 2.34 W/kg; SAR(10 g) = 1.53 W/kg

Maximum value of SAR (measured) = 3.15 W/kg

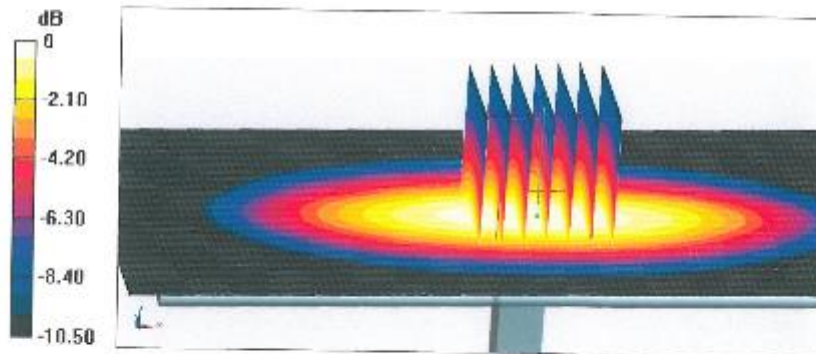

0 dB = 3.15 W/kg = 4.98 dBW/kg



Address: No. 31 Xueyuan Road, Haidian District, Beijing, 100191, China  
Tel: +86-10-62304633-3079 Fax: +86-10-62304633-2504  
E-mail: csl@chinart.com http://www.chinart.com

### Impedance Measurement Plot for Body TSL

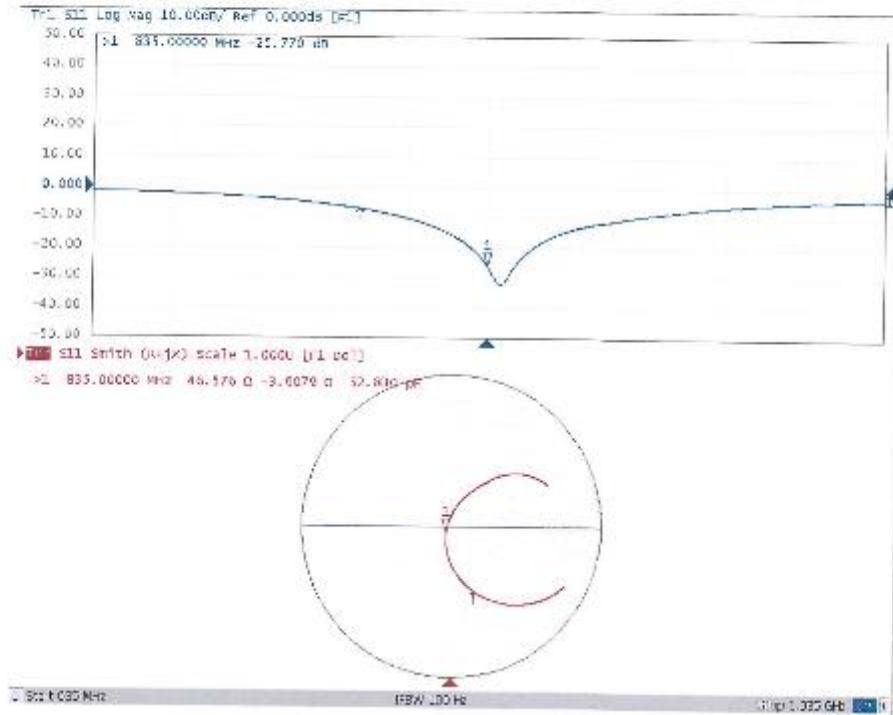

D1800V2 Sn:2d084



In Collaboration with  
**s p e a g**  
CALIBRATION LABORATORY



中国认可  
国际互认  
校准  
CALIBRATION  
CNAS L0570

Add: No.51 Xueyuan Road, Haidian District, Beijing, 100191, China  
Tel: +86-10-62304633-2079 Fax: +86-10-62304633-2504  
E-mail: ctt@chinattl.com http://www.chinattl.cn

Client **SRTC** Certificate No: **Z17-97138**

| CALIBRATION CERTIFICATE   |  |  |                       |
|---|--|--|-----------------------|
| Object  | D1800V2 - SN: 2d084  |  |                       |
| Calibration Procedure(s)  | FF-Z11-003-01<br>Calibration Procedures for dipole validation kits |  |                       |
| Calibration date:   | September 15, 2017   |  |                       |
| This calibration Certificate documents the traceability to national standards, which realize the physical units of measurements(SI). The measurements and the uncertainties with confidence probability are given on the following pages and are part of the certificate. |  |  |                       |
| All calibrations have been conducted in the closed laboratory facility: environment temperature(22±3)°C and humidity<70%.   |  |  |                       |
| Calibration Equipment used (M&TE critical for calibration)  |  |  |                       |
| Primary Standards   | ID #   | Cal Date(Calibrated by: Certificate No.) | Scheduled Calibration |
| Power Meter NRP2  | 102198   | 02-Mar-17 (CTTL, No.J17X01254)           | Mar-18                |
| Power sensor NRP-Z91  | 100596   | 02-Mar-17 (CTTL, No.J17X01254)           | Mar-18                |
| Reference Probe EX3DV4  | SN 7433  | 28-Sep-16(SPEAG,No.EX3-7433_Sep16)       | Sep-17                |
| DAE4  | SN 1331  | 19-Jan-17(CTTL-SPEAG,No.Z17-97015)       | Jan-18                |
| Secondary Standards   | ID #   | Cal Date(Calibrated by: Certificate No.) | Scheduled Calibration |
| Signal Generator E4438C   | MY49071430   | 13-Jan-17 (CTTL, No.J17X00286)           | Jan-18                |
| Network Analyzer E5071C   | MY46110873   | 13-Jan-17 (CTTL, No.J17X00285)           | Jan-18                |
| Calibrated by:  | Name   | Function                                 | Signature             |
|   | Zhao Jing  | SAR Test Engineer                        |                       |
| Reviewed by:  | Yu Zongying  | SAR Test Engineer                        |                       |
| Approved by:  | Qi Dianyuan  | SAR Project Leader                       |                       |
| Issued: September 18, 2017  |  |  |                       |
| This calibration certificate shall not be reproduced except in full without written approval of the laboratory  |  |  |                       |

Certificate No: Z17-97138

Page 1 of 8



Add: No.51 Xueyuan Road, Haidian District, Beijing, 100191, China  
Tel: +86-10-62104633-2079 Fax: +86-10-62104633-2504  
E-mail: cctl@chinaetl.com http://www.clinatd.cn

**Glossary:**

|       |                                |
|-------|--------------------------------|
| TSL   | tissue simulating liquid       |
| ConvF | sensitivity in TSL / NORMx,y,z |
| N/A   | not applicable or not measured |

**Calibration is Performed According to the Following Standards:**

- IEEE Std 1528-2013, "IEEE Recommended Practice for Determining the Peak Spatial-Averaged Specific Absorption Rate (SAR) in the Human Head from Wireless Communications Devices: Measurement Techniques", June 2013
- IEC 62209-1, "Procedure to measure the Specific Absorption Rate (SAR) For hand-held devices used in close proximity to the ear (frequency range of 300MHz to 3GHz)", February 2005
- IEC 62209-2, "Procedure to measure the Specific Absorption Rate (SAR) For wireless communication devices used in close proximity to the human body (frequency range of 30MHz to 6GHz)", March 2010
- KDB865864, SAR Measurement Requirements for 100 MHz to 6 GHz

**Additional Documentation:**

- DASY4/5 System Handbook

**Methods Applied and Interpretation of Parameters:**

- Measurement Conditions:** Further details are available from the Validation Report at the end of the certificate. All figures stated in the certificate are valid at the frequency indicated.
- Antenna Parameters with TSL:** The dipole is mounted with the spacer to position its feed point exactly below the center marking of the flat phantom section, with the arms oriented parallel to the body axis.
- Feed Point Impedance and Return Loss:** These parameters are measured with the dipole positioned under the liquid filled phantom. The impedance stated is transformed from the measurement at the SMA connector to the feed point. The Return Loss ensures low reflected power. No uncertainty required.
- Electrical Delay:** One-way delay between the SMA connector and the antenna feed point. No uncertainty required.
- SAR measured:** SAR measured at the stated antenna input power.
- SAR normalized:** SAR as measured, normalized to an input power of 1 W at the antenna connector.
- SAR for nominal TSL parameters:** The measured TSL parameters are used to calculate the nominal SAR result.

The reported uncertainty of measurement is stated as the standard uncertainty of Measurement multiplied by the coverage factor k=2, which for a normal distribution corresponds to a coverage probability of approximately 95%.



Add: No.51 Xueyuan Road, Haidian District, Beijing, 100191, China  
Tel: +86-10-62304633-2079 Fax: +86-10-62304633-2504  
E-mail: srl@chinanet.com http://www.chinanet.cn

### Measurement Conditions

DASY system configuration, as far as not given on page 1.

|                              |                          |              |
|------------------------------|--------------------------|--------------|
| DASY Version                 | DASY52                   | 52.10.0.1448 |
| Extrapolation                | Advanced Extrapolation   |              |
| Phantom                      | Triple Flat Phantom 5.1C |              |
| Distance Dipole Center - TSL | 10 mm                    | with Spacer  |
| Zoom Scan Resolution         | dx, dy, dz = 5 mm        |              |
| Frequency                    | 1800 MHz ± 1 MHz         |              |

### Head TSL parameters

The following parameters and calculations were applied.

|   | Temperature     | Permittivity | Conductivity     |
|---|-----------------|--------------|------------------|
| Nominal Head TSL parameters             | 22.0 °C         | 40.0         | 1.40 mho/m       |
| Measured Head TSL parameters            | (22.0 ± 0.2) °C | 40.4 ± 6 %   | 1.42 mho/m ± 6 % |
| Head TSL temperature change during test | <1.0 °C         | ---          | ---              |

### SAR result with Head TSL

| SAR averaged over 1 $cm^3$ (1 g) of Head TSL   | Condition          |                            |
|--|--------------------|----------------------------|
| SAR measured                                   | 250 mW input power | 9.79 mW / g                |
| SAR for nominal Head TSL parameters            | normalized to 1W   | 38.9 mW / g ± 18.8 % (k=2) |
| SAR averaged over 10 $cm^3$ (10 g) of Head TSL | Condition          |                            |
| SAR measured                                   | 250 mW input power | 5.12 mW / g                |
| SAR for nominal Head TSL parameters            | normalized to 1W   | 20.4 mW / g ± 18.7 % (k=2) |

### Body TSL parameters

The following parameters and calculations were applied.

|   | Temperature     | Permittivity | Conductivity     |
|---|-----------------|--------------|------------------|
| Nominal Body TSL parameters             | 22.0 °C         | 53.3         | 1.52 mho/m       |
| Measured Body TSL parameters            | (22.0 ± 0.2) °C | 53.8 ± 6 %   | 1.50 mho/m ± 6 % |
| Body TSL temperature change during test | <1.0 °C         | ---          | ---              |

### SAR result with Body TSL

| SAR averaged over 1 $cm^3$ (1 g) of Body TSL   | Condition          |                            |
|--|--------------------|----------------------------|
| SAR measured                                   | 250 mW input power | 9.84 mW / g                |
| SAR for nominal Body TSL parameters            | normalized to 1W   | 39.7 mW / g ± 18.8 % (k=2) |
| SAR averaged over 10 $cm^3$ (10 g) of Body TSL | Condition          |                            |
| SAR measured                                   | 250 mW input power | 5.18 mW / g                |
| SAR for nominal Body TSL parameters            | normalized to 1W   | 20.8 mW / g ± 18.7 % (k=2) |





Add: No 51 Xueyuan Road, Haidian District, Beijing, 100191, China  
Tel: +86-10-62304633-2079 Fax: +86-10-62304633-2504  
E-mail: ctri@chinanetl.com http://www.chinanetl.cn

**Appendix (Additional assessments outside the scope of CNAS L0570)**

**Antenna Parameters with Head TSL**

|                                      |               |
|--------------------------------------|---------------|
| Impedance, transformed to feed point | 49.3Ω- 1.55jΩ |
| Return Loss                          | - 35.4dB      |

**Antenna Parameters with Body TSL**

|                                      |               |
|--------------------------------------|---------------|
| Impedance, transformed to feed point | 46.0Ω- 1.32jΩ |
| Return Loss                          | - 27.1dB      |

**General Antenna Parameters and Design**

|                                  |          |
|----------------------------------|----------|
| Electrical Delay (one direction) | 1.315 ns |
|----------------------------------|----------|

After long term use with 100W radiated power, only a slight warming of the dipole near the feedpoint can be measured.

The dipole is made of standard semirigid coaxial cable. The center conductor of the feeding line is directly connected to the second arm of the dipole. The antenna is therefore short-circuited for DC-signals. On some of the dipoles, small end caps are added to the dipole arms in order to improve matching when loaded according to the position as explained in the "Measurement Conditions" paragraph. The SAR data are not affected by this change. The overall dipole length is still according to the Standard. No excessive force must be applied to the dipole arms, because they might bend or the soldered connections near the feedpoint may be damaged.

**Additional EUT Data**

|                 |       |
|-----------------|-------|
| Manufactured by | SPEAG |
|-----------------|-------|



Add: No.51 Xueyuan Road, Haidian District, Beijing, 100191, China  
Tel: +86-10-62104633-2079 Fax: +86-10-62104633-2504  
E-mail: ctD@china.ttl.com http://www.chinasttl.cn

**DASY5 Validation Report for Head TSL**

Date: 09.15.2017

Test Laboratory: CTTL, Beijing, China

**DUT: Dipole 1800 MHz; Type: D1800V2; Serial: D1800V2 - SN: 2d084**

Communication System: UID 0, CW; Frequency: 1800 MHz; Duty Cycle: 1:1

Medium parameters used:  $f = 1800 \text{ MHz}$ ;  $\sigma = 1.423 \text{ S/m}$ ;  $\epsilon_r = 40.37$ ;  $\rho = 1000 \text{ kg/m}^3$

Phantom section: Left Section

Measurement Standard: DASY5 (IEEE/IEC/ANSI C63.19-2007)

DASY5 Configuration:

- Probe: EX3DV4 - SN7433; ConvF(7.97, 7.97, 7.97); Calibrated: 9/26/2016;
- Sensor-Surface: 1.4mm (Mechanical Surface Detection)
- Electronics: DAB4 Sn1331; Calibrated: 1/19/2017
- Phantom: Triple Flat Phantom 5.1C; Type: QD 000 P51 CA; Serial: 1161/1
- Measurement SW: DASY52, Version 52.10 (0); SEMCAD X Version 14.6.10 (7417)

**System Performance Check/Zoom Scan (7x7x7) (7x7x7)/Cube 0: Measurement grid:**

$dx=5\text{mm}$ ,  $dy=5\text{mm}$ ,  $dz=5\text{mm}$

Reference Value = 93.90 V/m; Power Drift = 0.01 dB

Peak SAR (extrapolated) = 18.7 W/kg

SAR(1 g) = 9.79 W/kg; SAR(10 g) = 5.12 W/kg

Maximum value of SAR (measured) = 15.5 W/kg

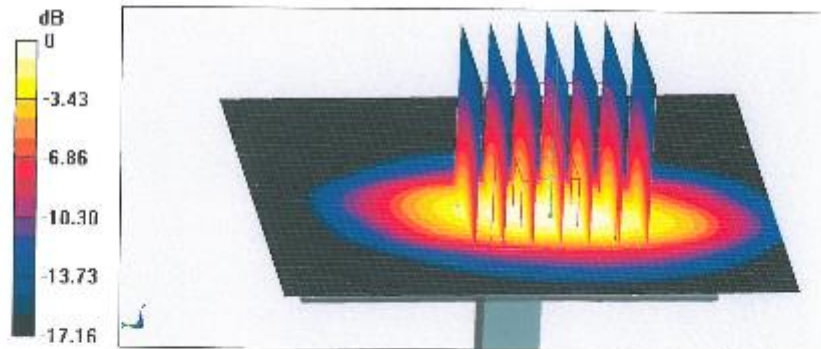

0 dB = 15.5 W/kg = 11.90 dBW/kg



In Collaboration with  
 Add: No. 51 Xueyuan Road, Haidian District, Beijing, 100191, China  
 Tel: +86-10-62504633-2079 Fax: +86-10-62504633-2504  
 E-mail: ccl@china.ttl.com http://www.chinartl.cn

**Impedance Measurement Plot for Head TSL**

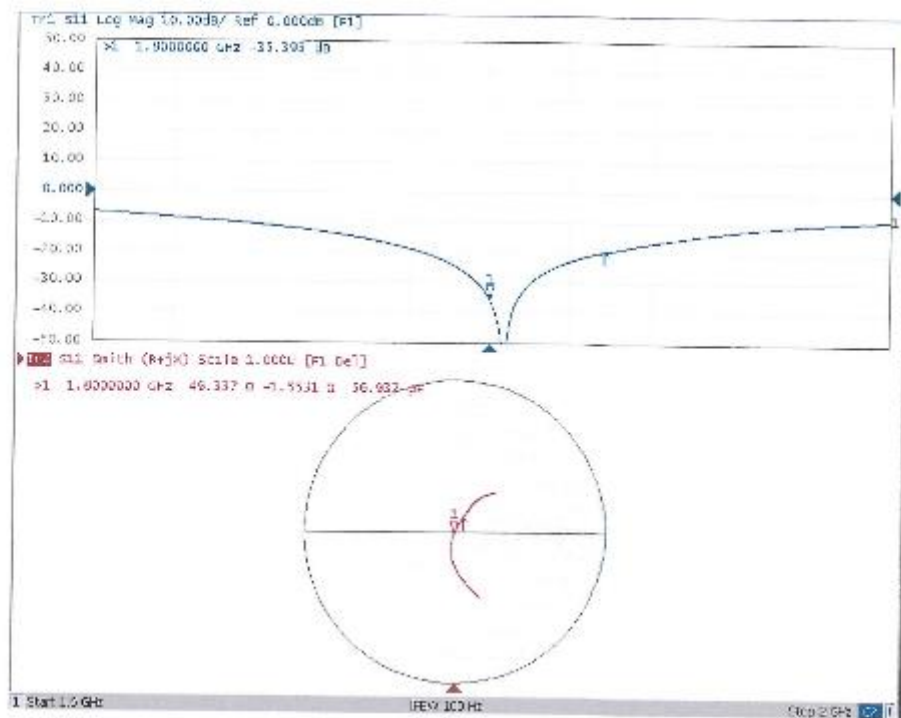



Add: No.51 Xueyuan Road, Haidian District, Beijing, 100191, China  
Tel: +86-10-62304633-2079 Fax: +86-10-62304633-2504  
E-mail: cti@chinaatl.com http://www.chinaatl.cn

**DASY5 Validation Report for Body TSL**

Date: 09.14.2017

Test Laboratory: CTTL, Beijing, China

**DUT: Dipole 1800 MHz; Type: D1800V2; Serial: D1800V2 - SN: 2d084**

Communication System: UID 0, CW; Frequency: 1800 MHz; Duty Cycle: 1:1

Medium parameters used:  $f = 1800$  MHz;  $\sigma = 1.503$  S/m;  $\epsilon_r = 53.79$ ;  $\rho = 1000$  kg/m<sup>3</sup>

Phantom section: Center Section

Measurement Standard: DASY5 (IEFE/IEC/ANSI C63.19-2007)

DASY5 Configuration:

- Probe: EX3DV4 - SN7433; ConvF(7.75, 7.75, 7.75); Calibrated: 9/26/2016;
- Sensor-Surface: 1.4mm (Mechanical Surface Detection)
- Electronics: DAE4 Sn1331; Calibrated: 1/19/2017
- Phantom: Triple Flat Phantom S.1C; Type: QD 000 P51 CA; Serial: 1161/1
- Measurement SW: DASY52, Version 52.10 (0); SEMCAD X Version 14.6.10 (7413)

**System Performance Check/Zoom Scan (7x7x7) (7x7x7)/Cube 0:** Measurement grid:

$dx=5$ mm,  $dy=5$ mm,  $dz=5$ mm

Reference Value = 97.57 V/m; Power Drift = -0.02 dB

Peak SAR (extrapolated) = 18.0 W/kg

**SAR(1 g) = 9.84 W/kg; SAR(10 g) = 5.18 W/kg**

Maximum value of SAR (measured) = 15.2 W/kg

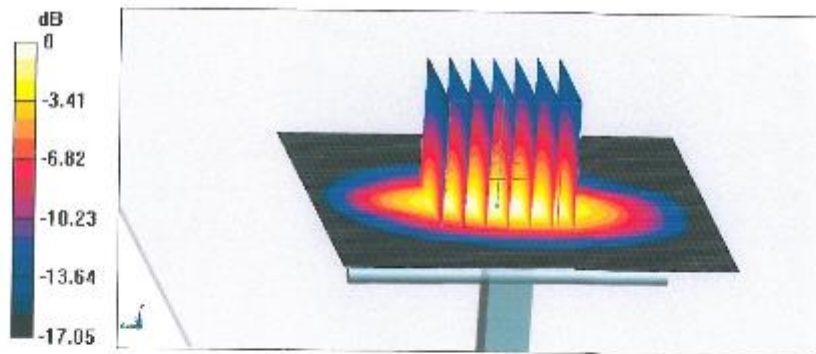



Add: No. 51 Xueyuan Road, Haidian District, Beijing, 100191, China  
Tel: +86-10-62304633-2079 Fax: +86-10-62304633-2504  
E-mail: ctrl@cmtrtl.com http://www.chinactrl.com

**Impedance Measurement Plot for Body TSL**

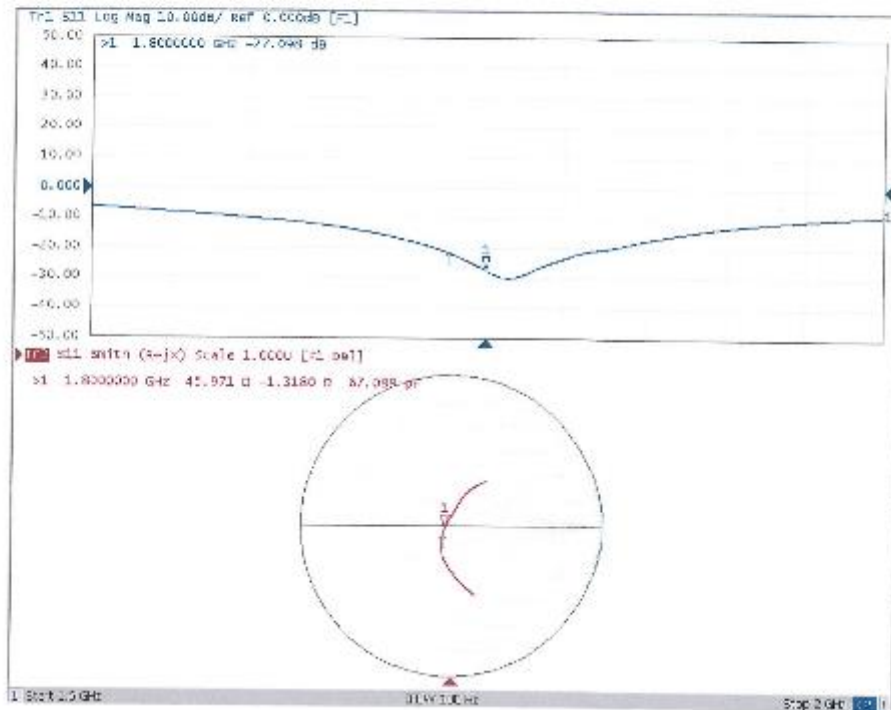

D2000V2 Sn:1009



In Collaboration with  
**s p e a g**  
CALIBRATION LABORATORY



中国认可  
国际互认  
校准  
CALIBRATION  
CNAS L0570

Add: No.51 Xueyuan Road, Haidian District, Beijing, 100191, China  
Tel: +86-10-62304633-2079 Fax: +86-10-62304633-2504  
E-mail: cttl@chinatll.com http://www.chinatll.cn

Client **SRTC**

Certificate No: **Z18-97021**

| CALIBRATION CERTIFICATE   |  |  |                       |
|---|--|--|-----------------------|
| Object  | D2000V2 - SN: 1009   |  |                       |
| Calibration Procedure(s)  | FF-Z11-003-01<br>Calibration Procedures for dipole validation kits |  |                       |
| Calibration date:   | February 1, 2018   |  |                       |
| <p>This calibration Certificate documents the traceability to national standards, which realize the physical units of measurements(SI). The measurements and the uncertainties with confidence probability are given on the following pages and are part of the certificate.</p> <p>All calibrations have been conducted in the closed laboratory facility: environment temperature(22±3)℃ and humidity&lt;70%.</p> <p>Calibration Equipment used (M&amp;TE critical for calibration)</p> |  |  |                       |
| Primary Standards   | ID #   | Cal Date(Calibrated by, Certificate No.) | Scheduled Calibration |
| Power Meter NRVD  | 102196   | 02-Mar-17 (CTTL, No.J17X01254)           | Mar-18                |
| Power sensor NRV-Z5   | 100596   | 02-Mar-17 (CTTL, No.J17X01254)           | Mar-18                |
| Reference Probe EX3DV4  | SN 7464  | 12-Sep-17(SPEAG No.EX3-7464_Sep17)       | Sep-18                |
| DAE4  | SN 1525  | 02-Oct-17(SPEAG No.DAE4-1525_Oct17)      | Oct-18                |
| Secondary Standards   | ID #   | Cal Date(Calibrated by, Certificate No.) | Scheduled Calibration |
| Signal Generator E4438C   | MY49071430   | 23-Jan-18 (CTTL, No.J18X00560)           | Jan-19                |
| Network Analyzer E5071C   | MY46110673   | 24-Jan-18 (CTTL, No.J18X00561)           | Jan-19                |
| Calibrated by:  | Name<br>Zhao Jing  | Function<br>SAR Test Engineer            | Signature<br>         |
| Reviewed by:  | Name<br>Lin Hao  | Function<br>SAR Test Engineer            | Signature<br>         |
| Approved by:  | Name<br>Qi Dianyuan  | Function<br>SAR Project Leader           | Signature<br>         |
| Issued: February 4, 2018  |  |  |                       |
| This calibration certificate shall not be reproduced except in full without written approval of the laboratory.   |  |  |                       |

Certificate No: Z18-97021

Page 1 of 8



Add: No.51 Xueyuan Road, Huidian District, Beijing, 100191, China  
Tel: +86-10-62304633-2079 Fax: +86-10-62304633-2504  
E-mail: cttl@chinattl.com http://www.chinattl.cn

**Glossary:**

|       |  |
|-------|--|
| TSL   | tissue simulating liquid                   |
| ConvF | sensitivity in TSL / NORM <sub>x,y,z</sub> |
| N/A   | not applicable or not measured             |

**Calibration is Performed According to the Following Standards:**

- IEEE Std 1528-2013, "IEEE Recommended Practice for Determining the Peak Spatial-Averaged Specific Absorption Rate (SAR) in the Human Head from Wireless Communications Devices: Measurement Techniques", June 2013
- IEC 62209-1, "Measurement procedure for assessment of specific absorption rate of human exposure to radio frequency fields from hand-held and body-mounted wireless communication devices- Part 1: Device used next to the ear (Frequency range of 300MHz to 6GHz)", July 2016
- IEC 62209-2, "Procedure to measure the Specific Absorption Rate (SAR) For wireless communication devices used in close proximity to the human body (frequency range of 30MHz to 6GHz)", March 2010
- KDB865664, SAR Measurement Requirements for 100 MHz to 6 GHz

**Additional Documentation:**

- DASY4/5 System Handbook

**Methods Applied and Interpretation of Parameters:**

- Measurement Conditions:** Further details are available from the Validation Report at the end of the certificate. All figures stated in the certificate are valid at the frequency indicated.
- Antenna Parameters with TSL:** The dipole is mounted with the spacer to position its feed point exactly below the center marking of the flat phantom section, with the arms oriented parallel to the body axis.
- Feed Point Impedance and Return Loss:** These parameters are measured with the dipole positioned under the liquid filled phantom. The impedance stated is transformed from the measurement at the SMA connector to the feed point. The Return Loss ensures low reflected power. No uncertainty required.
- Electrical Delay:** One-way delay between the SMA connector and the antenna feed point. No uncertainty required.
- SAR measured:** SAR measured at the stated antenna input power.
- SAR normalized:** SAR as measured, normalized to an input power of 1 W at the antenna connector.
- SAR for nominal TSL parameters:** The measured TSL parameters are used to calculate the nominal SAR result.

The reported uncertainty of measurement is stated as the standard uncertainty of Measurement multiplied by the coverage factor  $k=2$ , which for a normal distribution corresponds to a coverage probability of approximately 95%.



Add: No.51 Xueyuan Road, Haidian District, Beijing, 100191, China  
Tel: +86-10-62304633-2879 Fax: +86-10-62304633-2504  
E-mail: cttl@chinattl.com http://www.chinattl.cn

### Measurement Conditions

DASY system configuration, as far as not given on page 1.

|                              |                          |              |
|------------------------------|--------------------------|--------------|
| DASY Version                 | DASY52                   | 52.10.0.1446 |
| Extrapolation                | Advanced Extrapolation   |              |
| Phantom                      | Triple Flat Phantom 5.1C |              |
| Distance Dipole Center - TSL | 10 mm                    | with Spacer  |
| Zoom Scan Resolution         | dx, dy, dz = 5 mm        |              |
| Frequency                    | 2000 MHz ± 1 MHz         |              |

### Head TSL parameters

The following parameters and calculations were applied.

|   | Temperature     | Permittivity | Conductivity     |
|---|-----------------|--------------|------------------|
| Nominal Head TSL parameters             | 22.0 °C         | 40.0         | 1.40 mho/m       |
| Measured Head TSL parameters            | (22.0 ± 0.2) °C | 38.9 ± 6 %   | 1.42 mho/m ± 6 % |
| Head TSL temperature change during test | <1.0 °C         | ---          | ---              |

### SAR result with Head TSL

| SAR averaged over 1 cm <sup>3</sup> (1 g) of Head TSL   | Condition          |                           |
|---|--------------------|---------------------------|
| SAR measured  | 250 mW input power | 10.2 mW / g               |
| SAR for nominal Head TSL parameters                     | normalized to 1W   | 40.3 mW /g ± 18.8 % (k=2) |
| SAR averaged over 10 cm <sup>3</sup> (10 g) of Head TSL | Condition          |                           |
| SAR measured  | 250 mW input power | 5.17 mW / g               |
| SAR for nominal Head TSL parameters                     | normalized to 1W   | 20.5 mW /g ± 18.7 % (k=2) |

### Body TSL parameters

The following parameters and calculations were applied.

|   | Temperature     | Permittivity | Conductivity     |
|---|-----------------|--------------|------------------|
| Nominal Body TSL parameters             | 22.0 °C         | 53.3         | 1.52 mho/m       |
| Measured Body TSL parameters            | (22.0 ± 0.2) °C | 51.8 ± 6 %   | 1.56 mho/m ± 6 % |
| Body TSL temperature change during test | <1.0 °C         | ---          | ---              |

### SAR result with Body TSL

| SAR averaged over 1 cm <sup>3</sup> (1 g) of Body TSL   | Condition          |                           |
|---|--------------------|---------------------------|
| SAR measured  | 250 mW input power | 10.3 mW / g               |
| SAR for nominal Body TSL parameters                     | normalized to 1W   | 40.3 mW /g ± 18.8 % (k=2) |
| SAR averaged over 10 cm <sup>3</sup> (10 g) of Body TSL | Condition          |                           |
| SAR measured  | 250 mW input power | 5.18 mW / g               |
| SAR for nominal Body TSL parameters                     | normalized to 1W   | 20.4 mW /g ± 18.7 % (k=2) |





Add: No.51 Xueyuan Road, Haidian District, Beijing, 100191, China  
Tel: +86-10-62304633-2079 Fax: +86-10-62304633-2504  
E-mail: cttl@chinattl.com http://www.chinattl.cn

**Appendix (Additional assessments outside the scope of CNAS L0570)**

**Antenna Parameters with Head TSL**

|                                      |               |
|--------------------------------------|---------------|
| Impedance, transformed to feed point | 49.8Ω- 2.08jΩ |
| Return Loss                          | - 33.6dB      |

**Antenna Parameters with Body TSL**

|                                      |               |
|--------------------------------------|---------------|
| Impedance, transformed to feed point | 46.3Ω- 1.63jΩ |
| Return Loss                          | - 27.6dB      |

**General Antenna Parameters and Design**

|                                  |          |
|----------------------------------|----------|
| Electrical Delay (one direction) | 1.047 ns |
|----------------------------------|----------|

After long term use with 100W radiated power, only a slight warming of the dipole near the feedpoint can be measured.

The dipole is made of standard semirigid coaxial cable. The center conductor of the feeding line is directly connected to the second arm of the dipole. The antenna is therefore short-circuited for DC-signals. On some of the dipoles, small end caps are added to the dipole arms in order to improve matching when loaded according to the position as explained in the "Measurement Conditions" paragraph. The SAR data are not affected by this change. The overall dipole length is still according to the Standard. No excessive force must be applied to the dipole arms, because they might bend or the soldered connections near the feedpoint may be damaged.

**Additional EUT Data**

|                 |       |
|-----------------|-------|
| Manufactured by | SPEAG |
|-----------------|-------|



Add: No.51 Xueyuan Road, Haidian District, Beijing, 100191, China  
Tel: +86-10-62304633-2079 Fax: +86-10-62304633-2504  
E-mail: ttatl@chinattl.com http://www.chinattl.cn

**DASY5 Validation Report for Head TSL**

Date: 02.01.2018

Test Laboratory: CTTL, Beijing, China

**DUT: Dipole 2000 MHz; Type: D2000V2; Serial: D2000V2 - SN: 1009**

Communication System: UID 0, CW; Frequency: 2000 MHz; Duty Cycle: 1:1

Medium parameters used:  $f = 2000$  MHz;  $\sigma = 1.416$  S/m;  $\epsilon_r = 38.89$ ;  $\rho = 1000$  kg/m<sup>3</sup>

Phantom section: Left Section

Measurement Standard: DASY5 (IEEE/IEC/ANSI C63.19-2007)

DASY5 Configuration:

- Probe: EX3DV4 - SN7464; ConvF(8.39, 8.39, 8.39); Calibrated: 9/12/2017,
- Sensor-Surface: 1.4mm (Mechanical Surface Detection)
- Electronics: DAE4 Sn1525; Calibrated: 10/2/2017
- Phantom: Triple Flat Phantom 5.1C; Type: QD 000 P51 CA; Serial: 1161/1
- Measurement SW: DASY52, Version 52.10 (0); SEMCAD X Version 14.6.10 (7417)

**System Performance Check/Zoom Scan (7x7x7) (7x7x7)/Cube 0: Measurement grid:**

dx=5mm, dy=5mm, dz=5mm

Reference Value = 95.98 V/m; Power Drift = -0.03 dB

Peak SAR (extrapolated) = 19.7 W/kg

**SAR(1 g) = 10.2 W/kg; SAR(10 g) = 5.17 W/kg**

Maximum value of SAR (measured) = 16.2 W/kg

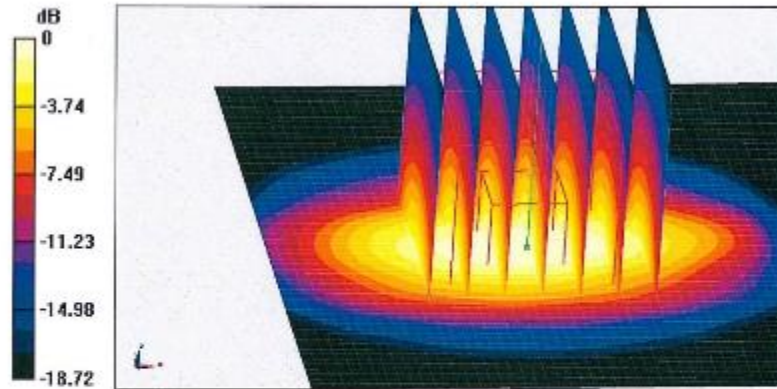

0 dB = 16.2 W/kg = 12.10 dBW/kg



Add: No.51 Xueyuan Road, Haidian District, Beijing, 100191, China  
Tel: +86-10-62304633-2079 Fax: +86-10-62304633-2504  
E-mail: ttl@chinattl.com http://www.chinattl.cn

**Impedance Measurement Plot for Head TSL**

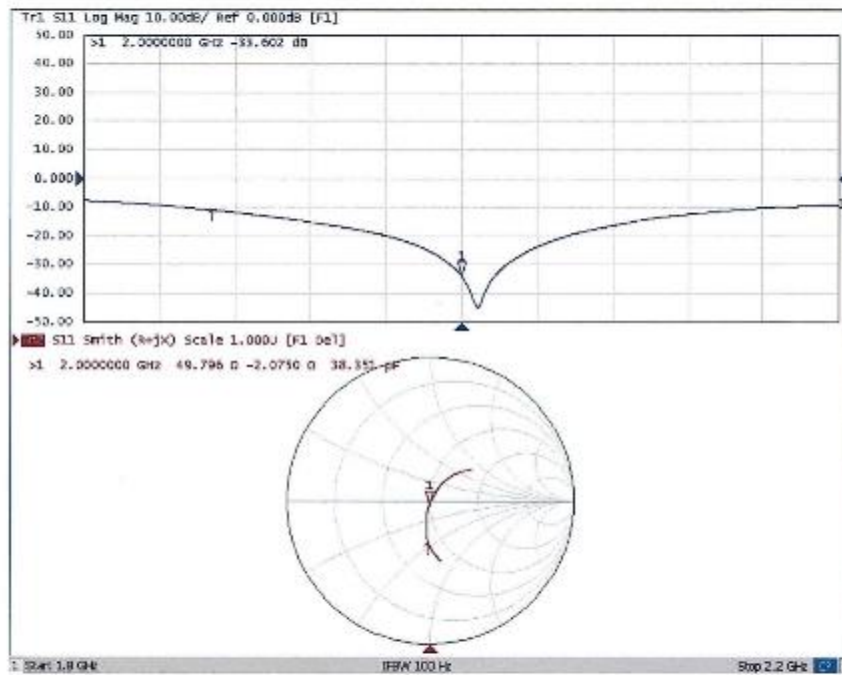



Add: No.51 Xueyuan Road, Haidian District, Beijing, 100191, China  
Tel: +86-10-62304633-2079 Fax: +86-10-62304633-2504  
E-mail: ettl@chinattl.com http://www.chinattl.cn

**DASY5 Validation Report for Body TSL**

Date: 02.01.2018

Test Laboratory: CTTL, Beijing, China

**DUT: Dipole 2000 MHz; Type: D2000V2; Serial: D2000V2 - SN: 1009**

Communication System: UID 0, CW; Frequency: 2000 MHz; Duty Cycle: 1:1

Medium parameters used:  $f = 2000$  MHz;  $\sigma = 1.564$  S/m;  $\epsilon_r = 51.83$ ;  $\rho = 1000$  kg/m<sup>3</sup>

Phantom section: Center Section

Measurement Standard: DASY5 (IEEE/IEC/ANSI C63.19-2007)

DASY5 Configuration:

- Probe: EX3DV4 - SN7464; ConvF(8.24,8.24,8.24); Calibrated: 9/12/2017,
- Sensor-Surface: 1.4mm (Mechanical Surface Detection)
- Electronics: DAE4 Sn1525; Calibrated: 10/2/2017
- Phantom: Triple Flat Phantom 5.1C; Type: QD 000 P51 CA; Serial: 1161/1
- Measurement SW: DASY52, Version 52.10 (0); SEMCAD X Version 14.6.10 (7417)

**System Performance Check/Zoom Scan (7x7x7) (7x7x7)/Cube 0:** Measurement grid:

$dx=5$ mm,  $dy=5$ mm,  $dz=5$ mm

Reference Value = 93.84 V/m; Power Drift = 0.02 dB

Peak SAR (extrapolated) = 19.7 W/kg

**SAR(1 g) = 10.3 W/kg; SAR(10 g) = 5.18 W/kg**

Maximum value of SAR (measured) = 16.3 W/kg

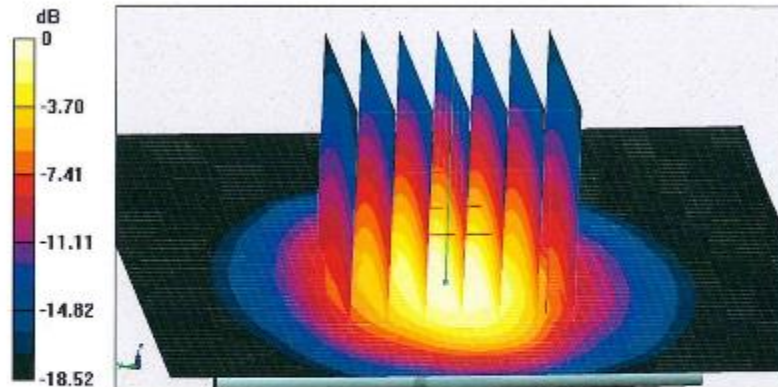

**0 dB = 16.3 W/kg = 12.12 dBW/kg**



In Collaboration with  
 Add: No.51 Xueyuan Road, Haidian District, Beijing, 100191, China  
 Tel: +86-10-62304633-2079 Fax: +86-10-62304633-2504  
 E-mail: ttl@chinartl.com http://www.chinartl.cn

**Impedance Measurement Plot for Body TSL**

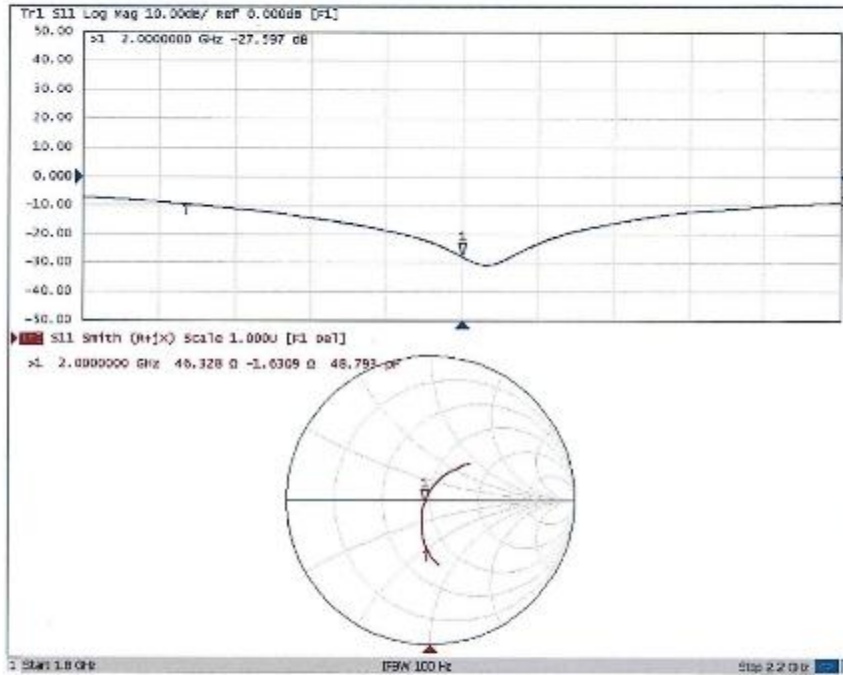

D2450V2 Sn:738



In Collaboration with  
**s p e a g**  
CALIBRATION LABORATORY



中国认可  
国际互认  
校准  
CALIBRATION  
CNAS L0570

Add: No.51 Xueyuan Road, Haidian District, Beijing, 100191, China  
Tel: +86-10-62304633-2099 Fax: +86-10-62304633-2504  
E-mail: ctli@china.ttl.com http://www.chinatl.cn

Client **SRTC**

Certificate No: **Z17-97140**

**CALIBRATION CERTIFICATE**

Object: D2450V2 - SN: 738  
Calibration Procedure(s): FF-Z11-003-01  
Calibration Procedures for dipole validation kits  
Calibration date: September 18, 2017

This calibration Certificate documents the traceability to national standards, which realize the physical units of measurements(SI). The measurements and the uncertainties with confidence probability are given on the following pages and are part of the certificate.

All calibrations have been conducted in the closed laboratory facility: environment temperature(22±3)℃ and humidity<70%.

Calibration Equipment used (M&TE critical for calibration)

| Primary Standards       | ID #       | Cal Date(Calibrated by, Certificate No.) | Scheduled Calibration |
|-------------------------|------------|--|-----------------------|
| Power Meter NRVD        | 102196     | 02-Mar-17 (CTTL, No.J17X01254)           | Mar-18                |
| Power sensor NRV-Z5     | 100596     | 02-Mar-17 (CTTL, No.J17X01254)           | Mar-18                |
| Reference Probe EX3DV4  | SN 7433    | 28-Sep-16(SPEAG,No.EX3-7433_Sep16)       | Sep-17                |
| DAE4                    | SN 1331    | 19-Jan-17(CTTL-SPEAG No.Z17-97015)       | Jan-18                |
| Secondary Standards     | ID #       | Cal Date(Calibrated by, Certificate No.) | Scheduled Calibration |
| Signal Generator E4438C | MY49071430 | 13-Jan-17 (CTTL, No.J17X00286)           | Jan-18                |
| Network Analyzer E5071C | MY46110673 | 13-Jan-17 (CTTL, No.J17X00285)           | Jan-18                |

|                | Name        | Function           | Signature |
|----------------|-------------|--------------------|-----------|
| Calibrated by: | Zhao Jing   | SAR Test Engineer  |           |
| Reviewed by:   | Yu Zongying | SAR Test Engineer  |           |
| Approved by:   | Qi Dianyuan | SAR Project Leader |           |

Issued: September 21, 2017

This calibration certificate shall not be reproduced except in full without written approval of the laboratory.



In Collaboration with  
**s p e a g**  
CALIBRATION LABORATORY

Add: No.51 Xueyuan Road, Haidian District, Beijing, 100191, China  
Tel: +86-10-62304633-2079 Fax: +86-10-62304633-2504  
E-mail: ccl@chinaatl.com http://www.chinaatl.cn

**Glossary:**

|       |  |
|-------|--|
| TSL   | tissue simulating liquid                   |
| ConvF | sensitivity in TSL / NORM <sub>x,y,z</sub> |
| N/A   | not applicable or not measured             |

**Calibration is Performed According to the Following Standards:**

- IEEE Std 1528-2013, "IEEE Recommended Practice for Determining the Peak Spatial-Averaged Specific Absorption Rate (SAR) in the Human Head from Wireless Communications Devices: Measurement Techniques", June 2013
- IEC 62209-1, "Measurement procedure for assessment of specific absorption rate of human exposure to radio frequency fields from hand-held and body-mounted wireless communication devices- Part 1: Device used next to the ear (Frequency range of 300MHz to 6GHz)", July 2016
- IEC 62209-2, "Procedure to measure the Specific Absorption Rate (SAR) For wireless communication devices used in close proximity to the human body (frequency range of 30MHz to 6GHz)", March 2010
- KDB865864, SAR Measurement Requirements for 100 MHz to 6 GHz

**Additional Documentation:**

- DASY4/5 System Handbook

**Methods Applied and Interpretation of Parameters:**

- Measurement Conditions:** Further details are available from the Validation Report at the end of the certificate. All figures stated in the certificate are valid at the frequency indicated.
- Antenna Parameters with TSL:** The dipole is mounted with the spacer to position its feed point exactly below the center marking of the flat phantom section, with the arms oriented parallel to the body axis.
- Feed Point Impedance and Return Loss:** These parameters are measured with the dipole positioned under the liquid filled phantom. The impedance stated is transformed from the measurement at the SMA connector to the feed point. The Return Loss ensures low reflected power. No uncertainty required.
- Electrical Delay:** One-way delay between the SMA connector and the antenna feed point. No uncertainty required.
- SAR measured:** SAR measured at the stated antenna input power.
- SAR normalized:** SAR as measured, normalized to an input power of 1 W at the antenna connector.
- SAR for nominal TSL parameters:** The measured TSL parameters are used to calculate the nominal SAR result.

The reported uncertainty of measurement is stated as the standard uncertainty of Measurement multiplied by the coverage factor  $k=2$ , which for a normal distribution corresponds to a coverage probability of approximately 95%.



Add: No.51 Xueyuan Road, Haiclan District, Beijing, 100191, China.  
Tel: +86-10-62304633-2079 Fax: +86-10-62304633-3504  
E-mail: ctt@china.ttl.com http://www.chinat.tl.cn

### Measurement Conditions

DASY system configuration, as far as not given on page 1.

|                              |                         |              |
|------------------------------|-------------------------|--------------|
| DASY Version                 | DASY52                  | 52.10.0.1448 |
| Extrapolation                | Advanced Extrapolation  |              |
| Phantom                      | Tripe Flat Phantom 5 1C |              |
| Distance Dipole Center - TSL | 10 mm                   | with Spacer  |
| Zoom Scan Resolution         | dx, dy, dz = 5 mm       |              |
| Frequency                    | 2450 MHz ± 1 MHz        |              |

### Head TSL parameters

The following parameters and calculations were applied.

|   | Temperature     | Permittivity | Conductivity     |
|---|-----------------|--------------|------------------|
| Nominal Head TSL parameters             | 22.0 °C         | 39.2         | 1.80 mho/m       |
| Measured Head TSL parameters            | (22.0 ± 0.2) °C | 38.7 ± 6 %   | 1.79 mho/m ± 6 % |
| Head TSL temperature change during test | <1.0 °C         | ---          | ---              |

### SAR result with Head TSL

|  |                    |                            |
|--|--------------------|----------------------------|
| SAR averaged over 1 $cm^3$ (1 g) of Head TSL   | Condition          |                            |
| SAR measured                                   | 250 mW input power | 13.1 mW / g                |
| SAR for nominal Head TSL parameters            | normalized to 1W   | 52.4 mW / g ± 18.8 % (k=2) |
| SAR averaged over 10 $cm^3$ (10 g) of Head TSL | Condition          |                            |
| SAR measured                                   | 250 mW input power | 6.10 mW / g                |
| SAR for nominal Head TSL parameters            | normalized to 1W   | 24.4 mW / g ± 18.7 % (k=2) |

### Body TSL parameters

The following parameters and calculations were applied.

|   | Temperature     | Permittivity | Conductivity     |
|---|-----------------|--------------|------------------|
| Nominal Body TSL parameters             | 22.0 °C         | 52.7         | 1.95 mho/m       |
| Measured Body TSL parameters            | (22.0 ± 0.2) °C | 52.5 ± 6 %   | 1.98 mho/m ± 6 % |
| Body TSL temperature change during test | <1.0 °C         | ---          | ---              |

### SAR result with Body TSL

|  |                    |                            |
|--|--------------------|----------------------------|
| SAR averaged over 1 $cm^3$ (1 g) of Body TSL   | Condition          |                            |
| SAR measured                                   | 250 mW input power | 13.2 mW / g                |
| SAR for nominal Body TSL parameters            | normalized to 1W   | 52.3 mW / g ± 18.8 % (k=2) |
| SAR averaged over 10 $cm^3$ (10 g) of Body TSL | Condition          |                            |
| SAR measured                                   | 250 mW input power | 6.10 mW / g                |
| SAR for nominal Body TSL parameters            | normalized to 1W   | 24.3 mW / g ± 18.7 % (k=2) |





In Collaboration with  
**s p e a g**  
CALIBRATION LABORATORY

Addr: No.51 Xueyuan Road, Haidian District, Beijing, 100191, China  
Tel: +86-10-62504633-2079 Fax: +86-10-62504633-2504  
E-mail: ctri@chinaatl.com http://www.chinaatl.com

**Appendix (Additional assessments outside the scope of CNAS L0570)**

**Antenna Parameters with Head TSL**

|                                      |               |
|--------------------------------------|---------------|
| Impedance, transformed to feed point | 51.3Ω+ 5.92jΩ |
| Return Loss                          | - 24.5dB      |

**Antenna Parameters with Body TSL**

|                                      |               |
|--------------------------------------|---------------|
| Impedance, transformed to feed point | 47.6Ω+ 6.39jΩ |
| Return Loss                          | - 23.1dB      |

**General Antenna Parameters and Design**

|                                  |          |
|----------------------------------|----------|
| Electrical Delay (one direction) | 1.268 ns |
|----------------------------------|----------|

After long term use with 100W radiated power, only a slight warming of the dipole near the feedpoint can be measured.

The dipole is made of standard semirigid coaxial cable. The center conductor of the feeding line is directly connected to the second arm of the dipole. The antenna is therefore short-circuited for DC-signals. On some of the dipoles, small end caps are added to the dipole arms in order to improve matching when loaded according to the position as explained in the "Measurement Conditions" paragraph. The SAR data are not affected by this change. The overall dipole length is still according to the Standard. No excessive force must be applied to the dipole arms, because they might bend or the soldered connections near the feedpoint may be damaged.

**Additional EUT Data**

|                 |       |
|-----------------|-------|
| Manufactured by | SPEAG |
|-----------------|-------|



In Collaboration with  
**s p e a g**  
CALIBRATION LABORATORY

Addr: No.31 Xueyuan Road, Haidian, District, Beijing, 100191, China  
Tel: +86-10-62304633-2079 Fax: +86-10-62304633-2504  
E-mail: crtl@china.ttl.com http://www.chinattl.com

**DASY5 Validation Report for Head TSL**

Date: 09.18.2017

Test Laboratory: CTTI, Beijing, China

**DUT: Dipole 2450 MHz; Type: D2450V2; Serial: D2450V2 - SN: 738**

Communication System: UTD 0, CW; Frequency: 2450 MHz; Duty Cycle: 1:1

Medium parameters used:  $f = 2450$  MHz;  $\sigma = 1.788$  S/m;  $\epsilon_r = 38.67$ ;  $\rho = 1000$  kg/m<sup>3</sup>

Phantom section: Left Section

Measurement Standard: DASY5 (IEEE/IBC/ANSI C63.19-2007)

DASY5 Configuration:

- Probe: EX3DV4 - SN7433; ConvF(7.45, 7.45, 7.45); Calibrated: 9/26/2016;
- Sensor-Surface: 1.4mm (Mechanical Surface Detection)
- Electronics: DAE4 Sn1331; Calibrated: 1/19/2017
- Phantom: Triple Flat Phantom 5.1C; Type: QD 000 P51 CA; Serial: 1161/1
- Measurement SW: DASY52, Version 52.10 (0); SEMCAD X Version 14.6.10 (7417)

**Dipole Calibration/Zoom Scan (7x7x7) (7x7x7):** Cube 0: Measurement grid: dx=5mm, dy=5mm, dz=5mm

Reference Value = 102.1 V/m; Power Drift = -0.01 dB

Peak SAR (extrapolated) = 27.8 W/kg

**SAR(1 g) = 13.1 W/kg; SAR(10 g) = 6.1 W/kg**

Maximum value of SAR (measured) = 22.0 W/kg

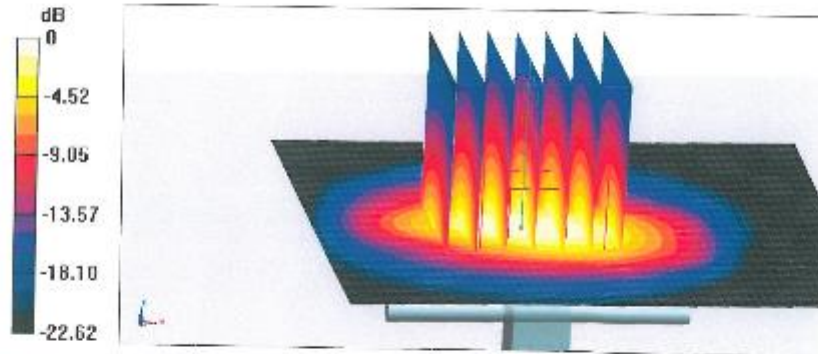

0 dB = 22.0 W/kg = 13.42 dBW/kg



In Collaboration with  
**s p e a g**  
CALIBRATION LABORATORY

Add: No.51 Xueyuan Road, Haidian District, Beijing, 100191, China  
Tel: +86-10-62304633-2079 Fax: +86-10-62304633-2504  
E-mail: ttl@chinatl.com http://www.chinatl.cn

### Impedance Measurement Plot for Head TSL

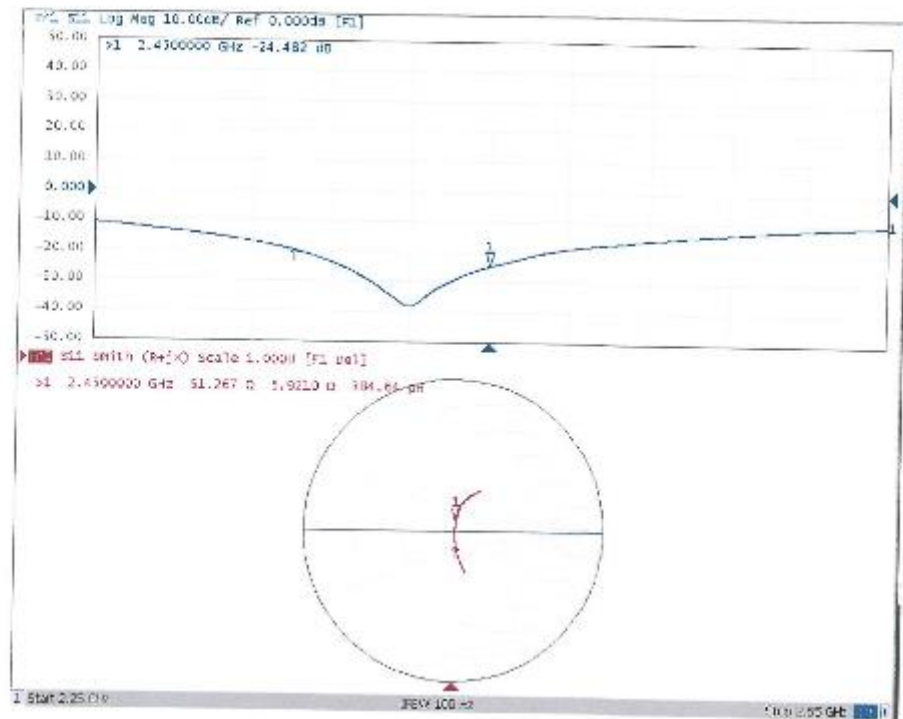



In Collaboration with  
**s p e a g**  
CALIBRATION LABORATORY

Add: No 51 Xueyuan Road, Haidian District, Beijing, 100191, China  
Tel: +86-10-62304633-2079 Fax: +86-10-62304633-2504  
E-mail: ctcl@chinattl.com http://www.chinattl.cn

**DASYS Validation Report for Body TSL**

Date: 09.18.2017

Test Laboratory: CTTL, Beijing, China

**DUT: Dipole 2450 MHz; Type: D2450V2; Serial: D2450V2 - SN: 738**

Communication System: UID 0, CW; Frequency: 2450 MHz; Duty Cycle: 1:1

Medium parameters used:  $f = 2450$  MHz;  $\sigma = 1.983$  S/m;  $\epsilon_r = 52.51$ ;  $\rho = 1000$  kg/m<sup>3</sup>

Phantom section: Center Section

Measurement Standard: DASYS (IEEE/IEC/ANSI C63.19-2007)

DASYS Configuration:

- Probe: EX3DV4 - SN7433; ConvF(7.46, 7.46, 7.46); Calibrated: 9/26/2016;
- Sensor-Surface: 1.4mm (Mechanical Surface Detection)
- Electronics: DAE4 Sn1331; Calibrated: 1/19/2017
- Phantom: Triple Flat Phantom 5.1C; Type: QD 000 P51 CA; Serial: 1161/1
- Measurement SW: DASYS2, Version 52.10 (0); SFMCAD X Version 14.6.10 (7417)

**Dipole Calibration/Zoom Scan (7x7x7) (7x7x7)/Cube 0:** Measurement grid: dx=5mm, dy=5mm, dz=5mm

Reference Value = 96.41 V/m; Power Drift = -0.03 dB

Peak SAR (extrapolated) = 27.8 W/kg

**SAR(1 g) = 13.2 W/kg; SAR(10 g) = 6.1 W/kg**

Maximum value of SAR (measured) = 22.3 W/kg

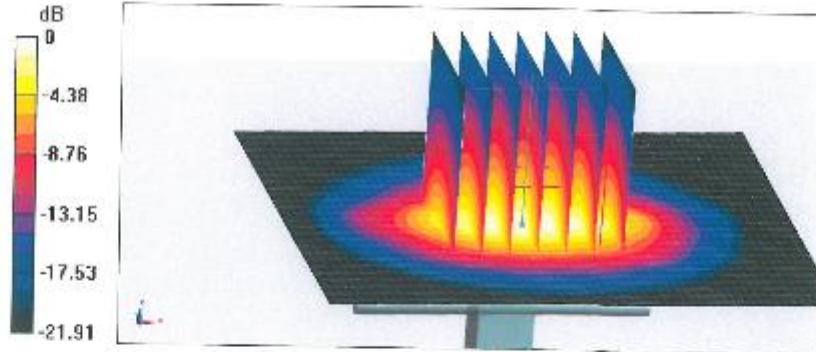

0 dB = 22.3 W/kg = 13.48 dBW/kg



In Collaboration with  
**s p e a g**  
CALIBRATION LABORATORY

Add: No.51 Xueyuan Road, Haidian District, Beijing, 100191, China  
Tel: +86-10-62304633-2079 Fax: +86-10-62304633-2504  
E-mail: ctdl@chinaatl.com http://www.chinaatl.cn

### Impedance Measurement Plot for Body TSL

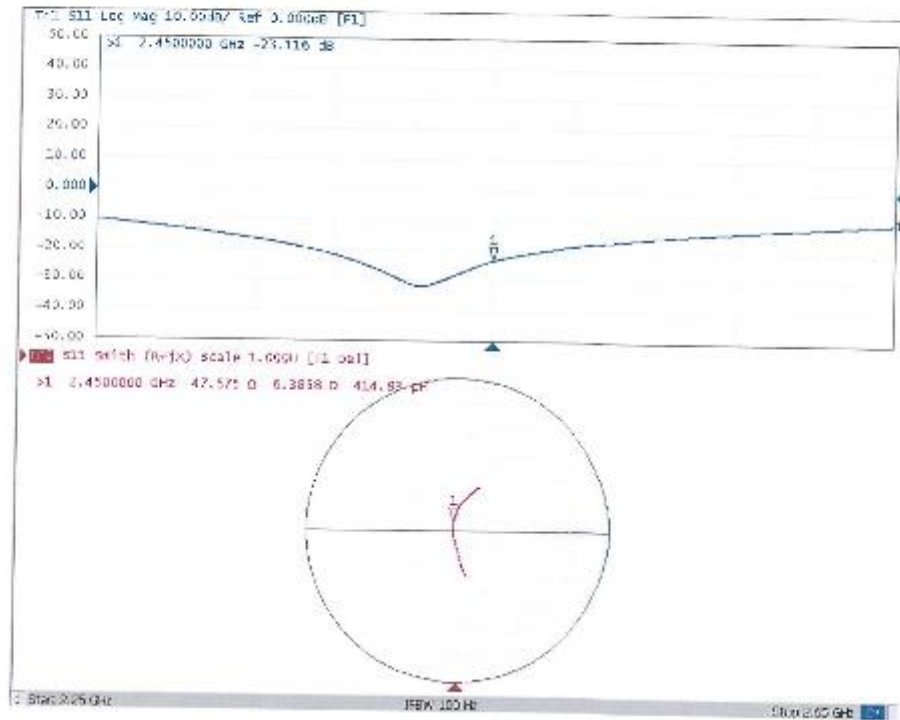

D2600V2 Sn:1166

**Calibration Laboratory of  
Schmid & Partner  
Engineering AG**  
Zeughausstrasse 43, 8004 Zurich, Switzerland



**S** Schweizerischer Kalibrierdienst  
**C** Service suisse d'étalonnage  
**S** Servizio svizzero di taratura  
**S** Swiss Calibration Service

Accredited by the Swiss Accreditation Service (SAS)  
The Swiss Accreditation Service is one of the signatories to the EA  
Multilateral Agreement for the recognition of calibration certificates

Accreditation No.: **SCS 0108**

Client **SRTC-BJ (Auden)**

Certificate No: **D2600V2-1166\_Nov19**

**CALIBRATION CERTIFICATE**

Object: **D2600V2 - SN:1166**

Calibration procedure(s): **QA CAL-05.v11  
Calibration Procedure for SAR Validation Sources between 0.7-3 GHz**

Calibration date: **November 08, 2019**

This calibration certificate documents the traceability to national standards, which realize the physical units of measurements (SI).  
The measurements and the uncertainties with confidence probability are given on the following pages and are part of the certificate.

All calibrations have been conducted in the closed laboratory facility: environment temperature (22 ± 3)°C and humidity < 70%.

Calibration Equipment used (M&TE critical for calibration)

| Primary Standards               | ID #               | Cal Date (Certificate No.)        | Scheduled Calibration  |
|---------------------------------|--------------------|-----------------------------------|------------------------|
| Power meter NRP                 | SN: 104778         | 03-Apr-19 (No. 217-02892/02893)   | Apr-20                 |
| Power sensor NRP-Z91            | SN: 103244         | 03-Apr-19 (No. 217-02892)         | Apr-20                 |
| Power sensor NRP-Z91            | SN: 103245         | 03-Apr-19 (No. 217-02893)         | Apr-20                 |
| Reference 20 dB Attenuator      | SN: 5058 (20k)     | 04-Apr-19 (No. 217-02894)         | Apr-20                 |
| Type-N mismatch combination     | SN: 5047.2 / 05327 | 04-Apr-19 (No. 217-02895)         | Apr-20                 |
| Reference Probe EX3DV4          | SN: 7349           | 29-May-19 (No. EX3-7349_May19)    | May-20                 |
| DAE4                            | SN: 601            | 30-Apr-19 (No. DAE4-601_Apr19)    | Apr-20                 |
| Secondary Standards             | ID #               | Check Date (in house)             | Scheduled Check        |
| Power meter E4419B              | SN: GB39512475     | 30-Oct-14 (in house check Feb-19) | In house check: Oct-20 |
| Power sensor HP 8481A           | SN: US37292783     | 07-Oct-15 (in house check Oct-18) | In house check: Oct-20 |
| Power sensor HP 8481A           | SN: MY41092317     | 07-Oct-15 (in house check Oct-18) | In house check: Oct-20 |
| RF generator R&S SMT-06         | SN: 100972         | 15-Jun-15 (in house check Oct-18) | In house check: Oct-20 |
| Network Analyzer Agilent E8358A | SN: US41060477     | 31-Mar-14 (in house check Oct-19) | In house check: Oct-20 |

Calibrated by: **Claudio Leubler** (Name), **Laboratory Technician** (Function), *[Signature]* (Signature)

Approved by: **Katja Pokovic** (Name), **Technical Manager** (Function), *[Signature]* (Signature)

Issued: November 12, 2019

This calibration certificate shall not be reproduced except in full without written approval of the laboratory.

**Calibration Laboratory of  
Schmid & Partner  
Engineering AG**  
Zeughausstrasse 43, 8004 Zurich, Switzerland



**S** Schweizerischer Kalibrierdienst  
**C** Service suisse d'étalonnage  
**S** Servizio svizzero di taratura  
**S** Swiss Calibration Service

Accredited by the Swiss Accreditation Service (SAS)  
The Swiss Accreditation Service is one of the signatories to the EA  
Multilateral Agreement for the recognition of calibration certificates

Accreditation No.: **SCS 0108**

**Glossary:**

|       |                                 |
|-------|---------------------------------|
| TSL   | tissue simulating liquid        |
| ConvF | sensitivity in TSL / NORM x,y,z |
| N/A   | not applicable or not measured  |

**Calibration is Performed According to the Following Standards:**

- IEEE Std 1528-2013, "IEEE Recommended Practice for Determining the Peak Spatial-Averaged Specific Absorption Rate (SAR) in the Human Head from Wireless Communications Devices: Measurement Techniques", June 2013
- IEC 62209-1, "Measurement procedure for the assessment of Specific Absorption Rate (SAR) from hand-held and body-mounted devices used next to the ear (frequency range of 300 MHz to 6 GHz)", July 2016
- IEC 62209-2, "Procedure to determine the Specific Absorption Rate (SAR) for wireless communication devices used in close proximity to the human body (frequency range of 30 MHz to 6 GHz)", March 2010
- KDB 865664, "SAR Measurement Requirements for 100 MHz to 6 GHz"

**Additional Documentation:**

- DASY4/5 System Handbook

**Methods Applied and Interpretation of Parameters:**

- Measurement Conditions:** Further details are available from the Validation Report at the end of the certificate. All figures stated in the certificate are valid at the frequency indicated.
- Antenna Parameters with TSL:** The dipole is mounted with the spacer to position its feed point exactly below the center marking of the flat phantom section, with the arms oriented parallel to the body axis.
- Feed Point Impedance and Return Loss:** These parameters are measured with the dipole positioned under the liquid filled phantom. The impedance stated is transformed from the measurement at the SMA connector to the feed point. The Return Loss ensures low reflected power. No uncertainty required.
- Electrical Delay:** One-way delay between the SMA connector and the antenna feed point. No uncertainty required.
- SAR measured:** SAR measured at the stated antenna input power.
- SAR normalized:** SAR as measured, normalized to an input power of 1 W at the antenna connector.
- SAR for nominal TSL parameters:** The measured TSL parameters are used to calculate the nominal SAR result.

The reported uncertainty of measurement is stated as the standard uncertainty of measurement multiplied by the coverage factor  $k=2$ , which for a normal distribution corresponds to a coverage probability of approximately 95%.

DASY system configuration, as far as not given on page 1.

|                              |                        |             |
|------------------------------|------------------------|-------------|
| DASY Version                 | DASY5                  | V52.10.3    |
| Extrapolation                | Advanced Extrapolation |             |
| Phantom                      | Modular Flat Phantom   |             |
| Distance Dipole Center - TSL | 10 mm                  | with Spacer |
| Zoom Scan Resolution         | dx, dy, dz = 5 mm      |             |
| Frequency                    | 2600 MHz ± 1 MHz       |             |

### Head TSL parameters

The following parameters and calculations were applied.

|   | Temperature     | Permittivity | Conductivity     |
|---|-----------------|--------------|------------------|
| Nominal Head TSL parameters             | 22.0 °C         | 39.0         | 1.96 mho/m       |
| Measured Head TSL parameters            | (22.0 ± 0.2) °C | 37.7 ± 6 %   | 2.01 mho/m ± 6 % |
| Head TSL temperature change during test | < 0.5 °C        | ----         | ----             |

### SAR result with Head TSL

| SAR averaged over 1 cm <sup>3</sup> (1 g) of Head TSL | Condition          |                          |
|---|--------------------|--------------------------|
| SAR measured  | 250 mW input power | 14.4 W/kg                |
| SAR for nominal Head TSL parameters                   | normalized to 1W   | 56.5 W/kg ± 17.0 % (k=2) |

| SAR averaged over 10 cm <sup>3</sup> (10 g) of Head TSL | condition          |                          |
|---|--------------------|--------------------------|
| SAR measured  | 250 mW input power | 6.43 W/kg                |
| SAR for nominal Head TSL parameters                     | normalized to 1W   | 25.4 W/kg ± 16.5 % (k=2) |



**Appendix (Additional assessments outside the scope of SCS 0108)**

**Antenna Parameters with Head TSL**

|                                      |                                |
|--------------------------------------|--------------------------------|
| Impedance, transformed to feed point | 47.9 $\Omega$ - 7.8 j $\Omega$ |
| Return Loss                          | - 21.7 dB                      |

**General Antenna Parameters and Design**

|                                  |          |
|----------------------------------|----------|
| Electrical Delay (one direction) | 1.148 ns |
|----------------------------------|----------|

After long term use with 100W radiated power, only a slight warming of the dipole near the feedpoint can be measured.

The dipole is made of standard semirigid coaxial cable. The center conductor of the feeding line is directly connected to the second arm of the dipole. The antenna is therefore short-circuited for DC-signals. On some of the dipoles, small end caps are added to the dipole arms in order to improve matching when loaded according to the position as explained in the "Measurement Conditions" paragraph. The SAR data are not affected by this change. The overall dipole length is still according to the Standard.

No excessive force must be applied to the dipole arms, because they might bend or the soldered connections near the feedpoint may be damaged.

**Additional EUT Data**

|                 |       |
|-----------------|-------|
| Manufactured by | SPEAG |
|-----------------|-------|