



RF TEST REPORT

Product Name: Smart Phone

Model Name: CP12s

FCC ID: R38YLCP12S

Issued For : Yulong Computer Telecommunication Scientific (Shenzhen) Co., Ltd

Floor 20, Block C, Coolpad Building North High-Tech Industrial Park,
Nanshan District, Shenzhen, China

Issued By : Shenzhen LGT Test Service Co., Ltd.

Room 205, Building 13, Zone B, Zhenxiong Industrial Park, No.177,
Renmin West Road, Jinsha, Kengzi Street, Pingshan District,
Shenzhen, Guangdong, China

Report Number: LGT24B033RF06

Sample Received Date: Feb. 26, 2024

Date of Test: Feb. 26, 2024 – Mar. 27, 2024

Date of Issue: Mar. 27, 2024

The test report is effective only with both signature and specialized stamp. This report shall not be reproduced except in full without the written approval of the Laboratory. The results in this report only apply to the tested sample.

TEST REPORT CERTIFICATION

Applicant: Yulong Computer Telecommunication Scientific (Shenzhen) Co., Ltd
Address: Floor 20, Block C, Coolpad Building North High-Tech Industrial Park, Nanshan District, Shenzhen, China

Manufacturer: Yulong Computer Telecommunication Scientific (Shenzhen) Co., Ltd
Address: Floor 20, Block C, Coolpad Building North High-Tech Industrial Park, Nanshan District, Shenzhen, China

Product Name: Smart Phone

Trademark: coolpad

Model Name: CP12s

Sample Status: Normal

APPLICABLE STANDARDS	
STANDARD	TEST RESULTS
FCC Part 22, 24, 27, 90 KDB 971168 D01 v03r01, ANSI C63.26(2015)	PASS

Prepared by:

Zane Shan

Zane Shan
Engineer

Approved by:

Vita Li

Vita Li
Technical Director



Table of Contents

Page

1. TEST FACTORY & MEASUREMENT UNCERTAINTY	5
2. GENERAL INFORMATION	6
3. CONDUCTED OUTPUT POWER	13
4. PEAK-TO-AVERAGE RATIO	14
5. RADIATED POWER AND EFFECTIVE ISOTROPIC RADIATED POWER	15
6. OCCUPIED BANDWIDTH	17
7. CONDUCTED BAND EDGE	18
8. CONDUCTED SPURIOUS EMISSION	20
9. RADIATED SPURIOUS EMISSION	21
10. FREQUENCY STABILITY	23
APPENDIX I - TEST DATA	24
CONDUCTED OUTPUT POWER	24
FREQUENCY STABILITY	58
PEAK-TO-AVERAGE RATIO	68
OCCUPIED BANDWIDTH	166
BAND EDGE	264
OUT-OF-BAND EMISSIONS	374
RADIATED SPURIOUS EMISSION	472

Revision History

Rev.	Issue Date	Revisions
00	Mar. 27, 2024	Initial Issue

1. TEST FACTORY & MEASUREMENT UNCERTAINTY

1.1 TEST FACTORY

Company Name:	Shenzhen LGT Test Service Co., Ltd.
Address:	Room 205, Building 13, Zone B, Zhenxiong Industrial Park, No.177, Renmin West Road, Jinsha, Kengzi Street, Pingshan District, Shenzhen, Guangdong, China
Accreditation Certificate	A2LA Certificate No.: 6727.01
	FCC Registration No.: 746540
	CAB ID: CN0136

1.2 MEASUREMENT UNCERTAINTY

The reported uncertainty of measurement $y \pm U$, where expanded uncertainty U is based on a standard uncertainty multiplied by a coverage factor of $k=2$, providing a level of confidence of approximately 95 %.

Parameter	Uncertainty
Occupied Channel Bandwidth	$\pm 3.2 \%$
RF Output Power, Conducted	$\pm 0.87\text{dB}$
Power Spectral Density, Conducted	$\pm 2.11 \text{ dB}$
Unwanted Emission, Conducted	$\pm 0.86\text{dB}$
All Emissions, Radiated (Below 1GHz)	$\pm 3.54\text{dB}$
All Emissions, Radiated (1GHz-18GHz)	$\pm 4.22\text{dB}$
All Emissions, Radiated (18GHz-25GHz)	$\pm 4.81\text{dB}$
Temperature	$\pm 0.5^\circ\text{C}$
Humidity	$\pm 2\%$

Note: The measurement uncertainty is not included in the test result.

2. GENERAL INFORMATION

2.1 TECHNICAL SPECIFICATIONS AND REGULATIONS

2.1.1 PRODUCT DESCRIPTION

A major technical description of EUT is described as following:

Product Name:	Smart Phone
Trademark:	coolpad
Model Name:	CP12s
Series Model:	N/A
Model Difference:	N/A
Frequency Bands:	U.S. Bands: LTE FDD Band 2 LTE FDD Band 4 LTE FDD Band 5 LTE FDD Band 7 LTE FDD Band 12 LTE FDD Band 17 LTE FDD Band 25 LTE FDD Band 26 LTE FDD Band 66
SIM Card:	SIM 1 and SIM 2 is a chipset unit and tested as single chipset, SIM 1 is used to tested.
Antenna:	FPC
Antenna gain:	LTE B2: -0.2dBi, LTE B4: 0.1dBi, LTE B5: -2.8dBi, LTE B7: -1.9dBi, LTE B12: -3.2dBi, LTE B17: -3.2dBi, LTE B25: 0.3dBi, LTE B26: -2.8dBi, LTE B66: 0.1dBi
Adapter:	Input: 100-240V, 50/60Hz, 0.5A Output: 5V, 3A;9V,2.22A;12V,1.67A
Battery:	Capacity: 4900mAh Rated Voltage: 3.85V
Extreme Vol. Limits:	3.6V to 4.35V (Nominal 3.85V)
Extreme Temp. Tolerance:	-20°C to + 55°C
Hardware Version:	V1.0
Software Version:	full_k62v1_64bsp-userdebug 12 SP1A.210812.016mp1V14105 test-keys

Note: The antenna information refer the manufacturer provide report, applicable only to the tested sample identified in the report.

2.1.2 PRODUCT SPECIFICATION SUBJECTIVE TO THIS STANDARD

Product Specification Subjective To This Standard	
Tx Frequency	LTE Band 2:1850~1910MHz LTE Band 4:1710~1755MHz LTE Band 5: 824~849MHz LTE Band 7:2500~2570MHz LTE Band 12: 699-716MHz LTE Band 17: 704~716MHz LTE Band 25: 1850-1915MHz LTE Band 26: 814-824MHz 824-849MHz LTE Band 66: 1710-1780MHz
Rx Frequency	LTE Band 2: 1930-1990MHz LTE Band 4: 2110-2155MHz LTE Band 5: 869-894MHz LTE Band 7: 2620-2690MHz LTE Band 12: 729-746MHz LTE Band 17: 734-746MHz LTE Band 25: 1930-1995MHz LTE Band 26: 859-869MHz 869-894MHz LTE Band 66: 2110-2200MHz
Bandwidth	LTE Band 2: 1.4MHz / 3MHz / 5MHz / 10MHz / 15MHz / 20MHz LTE Band 4: 1.4MHz / 3MHz / 5MHz / 10MHz / 15MHz /20MHz LTE Band 5: 1.4MHz / 3MHz / 5MHz / 10MHz LTE Band 7: 1.4MHz / 3MHz / 5MHz / 10MHz LTE Band 12: 1.4MHz / 3MHz / 5MHz / 10MHz LTE Band 17: 5MHz / 10MHz LTE Band 25: 1.4MHz / 3MHz / 5MHz / 10MHz / 15MHz /20MHz LTE Band 26: 1.4MHz / 3MHz / 5MHz / 10MHz/15MHz LTE Band 66: 1.4MHz / 3MHz / 5MHz / 10MHz / 15MHz /20MHz
Type of Modulation	QPSK /16QAM/64QAM

2.1.3 TEST CONFIGURATION OF EQUIPMENT UNDER TEST

Antenna port conducted and radiated test items listed below are performed according to KDB 971168 D01 v03r01 and ANSI C63.26 2015 Power Meas. License Digital Systems with maximum output power. Radiated measurements are performed by rotating the EUT in three different orthogonal test planes to find the maximum emission.

Remark:

1. The mark 'v' means that this configuration is chosen for testing
2. The mark '-' means that this bandwidth is not supported.
3. The device is investigated from 30MHz to 10 times of fundamental signal for radiated.

ITEMS	Band	Bandwidth (MHz)						Modulation		RB #			Test Channel		
		1.4	3	5	10	15	20	QPSK	16QAM	1	Half	Full	L	M	H
E.R.P.& E.I.R.P.	2	v	v	v	v	v	v	v	v	v	v	v	v	v	v
	4	v	v	v	v	v	v	v	v	v	v	v	v	v	v
	5	v	v	v	v			v	v	v	v	v	v	v	v
	7			v	v	v	v	v	v	v	v	v	v	v	v
	12	v	v	v	v			v	v	v	v	v	v	v	v
	17			v	v			v	v	v	v	v	v	v	v
	25	v	v	v	v	v	v	v	v	v	v	v	v	v	v
	26	v	v	v	v	v		v	v	v	v	v	v	v	v
	66	v	v	v	v	v	v	v	v	v	v	v	v	v	v
Peak&Avera Ratio	2	v	v	v	v	v	v	v	v	v			v	v	v
	4	v	v	v	v	v	v	v	v	v			v	v	v
	5	v	v	v	v			v	v	v			v	v	v
	7			v	v	v	v	v	v	v			v	v	v
	12	v	v	v	v			v	v	v			v	v	v
	17			v	v			v	v	v			v	v	v
	25	v	v	v	v	v	v	v	v	v			v	v	v
	26	v	v	v	v	v		v	v	v			v	v	v
	66	v	v	v	v	v	v	v	v	v			v	v	v
26dB&99% Bandwidth	2	v	v	v	v	v	v	v	v			v	v	v	v
	4	v	v	v	v	v	v	v	v			v	v	v	v
	5	v	v	v	v			v	v			v	v	v	v
	7			v	v	v	v	v	v			v	v	v	v
	12	v	v	v	v			v	v			v	v	v	v
	17			v	v			v	v			v	v	v	v
	25	v	v	v	v	v	v	v	v			v	v	v	v
	26	v	v	v	v	v		v	v			v	v	v	v
	66	v	v	v	v	v	v	v	v			v	v	v	v
Conducted Band Edge	2	v	v	v	v	v	v	v	v	v		v	v	v	v
	4	v	v	v	v	v	v	v	v	v		v	v	v	v
	5	v	v	v	v			v	v	v		v	v	v	v
	7			v	v	v	v	v	v	v		v	v	v	v
	12	v	v	v	v			v	v	v		v	v	v	v
	17			v	v			v	v	v		v	v	v	v
	25	v	v	v	v	v	v	v	v	v		v	v	v	v

	26	v	v	v	v	v		v	v	v		v	v	v	v
	66	v	v	v	v	v	v	v	v	v		v	v	v	v
Conducted Spurious Emission	2	v	v	v	v	v	v	v	v			v	v	v	v
	4	v	v	v	v	v	v	v	v			v	v	v	v
	5	v	v	v	v			v	v			v	v	v	v
	7			v	v	v	v	v	v			v	v	v	v
	12	v	v	v	v			v	v			v	v	v	v
	17			v	v			v	v			v	v	v	v
	25	v	v	v	v	v	v	v	v			v	v	v	v
	26	v	v	v	v	v		v	v			v	v	v	v
	66	v	v	v	v	v	v	v	v			v	v	v	v
		2					v	v	v			v		v	
Frequency Stability	4					v	v	v			v		v		
	5				v		v	v			v		v		
	7					v	v	v			v		v		
	12				v		v	v			v		v		
	17				v		v	v			v		v		
	25					v	v	v			v		v		
	26				v	v		v	v		v		v		
	66					v	v	v			v		v		
		2	v	v	v	v	v	v		v			v	v	v
Radiated Spurious Emission	4	v	v	v	v	v	v	v		v			v	v	v
	5	v	v	v	v			v		v			v	v	v
	7			v	v	v	v	v		v			v	v	v
	12	v	v	v	v			v		v			v	v	v
	17			v	v			v		v			v	v	v
	25	v	v	v	v	v	v	v		v			v	v	v
	26	v	v	v	v	v		v		v			v	v	v
	66	v	v	v	v	v	v	v		v			v	v	v

2.1.4 RELATED SUBMITTAL(S) / GRANT (S)

This submittal(s) (test report) is intended for filing to comply with the 47 CFR Part 2, 22, 24, 27.

2.1.5 SPECIAL ACCESSORIES

The battery and the charger, earphone supplied by the applicant were used as accessories and being tested with eut intended for fcc grant together.

2.1.6 EUT CONFIGURATION

The EUT configuration for testing is installed on RF field strength measurement to meet the Commission's requirement and operating in a manner which intends to maximize its emission characteristics in a continuous normal application.

2.1.7 EUT EXERCISE

The Transmitter was operated in the maximum output power mode through Communication Tester. The TX frequency was fixed which was for the purpose of the measurements.

2.1.8 CONFIGURATION OF EUT SYSTEM

The EUT configuration for testing is installed on RF field strength measurement to meet the Commission's requirement and operating in a manner which intends to maximize its emission characteristics in a continuous normal application.



Table 2-1 Equipment Used in EUT System

Item	Equipment	Model No.	Length	Note
N/A				N/A

Note:

- (1) For detachable type I/O cable should be specified the length in cm in 『Length』 column.
- (2) "YES" is means "with core"; "NO" is means "without core".

2.1.9 MEASUREMENT INSTRUMENTS

The radiated emission testing was performed according to the procedures of ANSI C63.26 2015 and FCC CFR 47 rules of 2.1046, 2.1047, 2.1049, 2.1051, 2.1053, 2.1055, 2.1057.

Radiation Test equipment					
Equipment	Manufacturer	Model No.	Serial No.	Cal. Date	Cal. Until
EMI Test Receiver	R&S	ESU	100372	2023.04.13	2024.04.12
Spectrum Analyzer	Keysight	N9010B	MY60242508	2023.04.10	2024.04.09
Active loop Antenna	ETS	6502	00049544	2023.04.10	2024.04.09
Bilog Antenna	SCHWARZBECK	VULB 9168	01447	2022.06.05	2025.06.04
Horn Antenna	SCHWARZBECK	3115	10SL0060	2022.06.02	2025.06.01
Pre-amplifier (9kHz-1GHz)	EMtrace	RP01A	02017	2023.04.07	2024.04.06
Pre-amplifier(1-26.5G)	Agilent	8449B	3008A4722	2023.04.07	2024.04.06
RE Cable (9K-1G)	N.A	R01	N.A	2023.04.07	2024.04.06
RE Cable (1-26G)	N.A	R02	N.A	2023.04.07	2024.04.06
Temperature & Humidity	KTJ	TA218B	N.A	2023.04.24	2024.04.23
Testing Software	EMC-I_V1.4.0.3_SKET				

RF Connected Test equipment					
Equipment	Manufacturer	Model No.	Serial No.	Cal. Date	Cal. Until
Signal Generator	Keysight	N5182B	MY59100717	2023.04.10	2024.04.09
Signal Analyzer	Keysight	N9010B	MY60242508	2023.04.13	2024.04.12
Wireless Communications Test Set	R&S	CMW 500	137737	2023.04.13	2024.04.12
Temperature & Humidity	KTJ	TA218B	N/A	2023.04.24	2024.04.23
Temperature & Humidity test chamber	AISRY	LX-1000L	171200018	2023.05.10	2024.05.09
Attenuator	eastsheep	90db	N/A	2023.04.10	2024.04.09
Testing Software	MTS 8310_2.0.0.0_MWRF-TEST				

3. CONDUCTED OUTPUT POWER

3.1 DESCRIPTION OF THE CONDUCTED OUTPUT POWER MEASUREMENT

3.1.1 MEASUREMENT METHOD

A system simulator was used to establish communication with the eut. Its parameters were set to force the eut transmitting at maximum output power. The measured power in the radio frequency on the transmitter output terminals shall be reported.

Configuration follows KDB 971168 D01 v03r01.

3.1.2 TEST SETUP



3.1.3 TEST PROCEDURES

1. The transmitter output port was connected to system simulator.
2. Set EUT at maximum power through the system simulator.
3. Select lowest/middle/highest channels for each band and different modulation.
4. Measure and record the power level from the system simulator.

3.1.4 TEST RESULTS

Note: Test chart See Appendix I

4. PEAK-TO-AVERAGE RATIO

4.1 DESCRIPTION OF THE CONDUCTED OUTPUT POWER MEASUREMENT

4.1.1 MEASUREMENT METHOD

Use one of the procedures presented in 4.1.3 to measure the total peak power and record as PPk. Use one of the applicable procedures presented 4.1.3 to measure the total average power and record as PAvg. Both the peak and average power levels must be expressed in the same logarithmic units (e.g., dBm). Determine the PAPR from:

$$\text{PAPR (dB)} = \text{PPk (dBm)} - \text{PAvg (dBm)}.$$

4.1.2 TEST SETUP

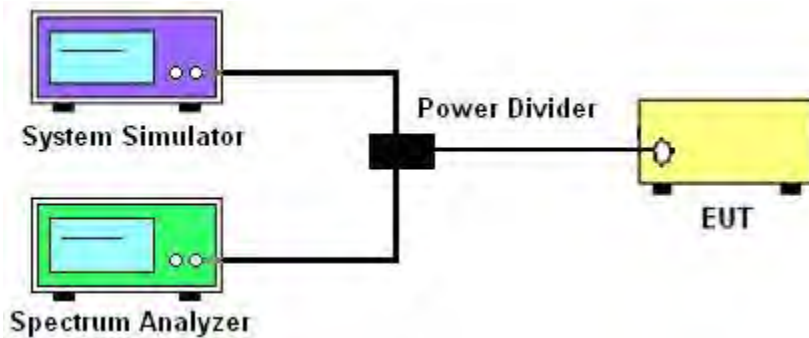

4.1.3 TEST PROCEDURES

1. The testing follows FCC KDB 971168 D01 v03r01 Section 5.7 and ANSI C63.26 2015 Section 5.2.6.
2. The EUT was connected to spectrum and system simulator via a power divider
3. Select lowest, middle, and highest channels for each band and different modulation.
4. Set the test probe and measure the peak and average power of the spectrum analyzer
5. Record the deviation as Peak to Average Ratio.

	LTE					
LTE BW	1.4M	3M	5M	10M	15M	20M
Span	3MHz	6MHz	10MHz	20MHz	30MHz	40MHz
RBW	30kHz	30kHz	100kHz	100kHz	300kHz	300kHz
VBW	100kHz	100kHz	300kHz	300kHz	1000kHz	1000kHz
Detector	PK/AVG	PK/AVG	PK/AVG	PK/AVG	PK/AVG	PK/AVG
Trace	Max	Max	Max	Max	Max	Max
Sweep Count	Auto	Auto	Auto	Auto	Auto	Auto

4.1.4 TEST RESULTS

Note: Test chart See Appendix I

5. RADIATED POWER AND EFFECTIVE ISOTROPIC RADIATED POWER

5.1 DESCRIPTION OF THE ERP/EIRP MEASUREMENT

5.1.1 MEASUREMENT METHOD

Effective radiated power output measurements by substitution method according to ANSI C63.26 2015, and the spectrum analyzer configuration follows KDB 971168 D01 Power Meas. License Digital Systems. Mobile and portable (hand-held) stations operating are limited to average ERP, Equivalent isotropic radiated power output measurements by substitution method according to ANSI C63.26 2015, and the spectrum analyzer configuration follows KDB 971168 D01 Power Meas, Mobile and portable (hand-held) stations operating are limited to average EIRP.

5.1.2 TEST SETUP

The procedure of radiated spurious emissions is as follows:

a) Pre-calibration With pre-calibration method, the Radiated Spurious Emissions(RSE) is calculated as, $RSE = R_x \text{ (dBuV)} + CL \text{ (dB)} + SA \text{ (dB)} + Gain \text{ (dBi)} - 107 \text{ (dBuV to dBm)}$ The SA is calibrated using following setup.

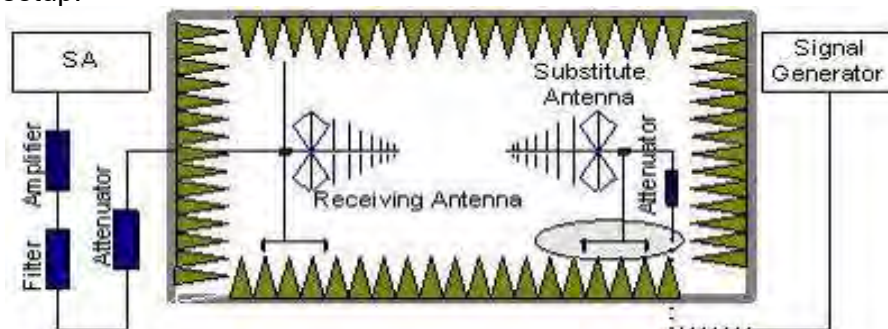

b) EUT was placed on a 1.5m non-conductive stand at a 3 m test distance from the receive antenna. A receiving antenna was placed on the antenna mast 3 m from the test item for emission measurements. The height of receiving antenna is 0.8m. The test setup refers to figure below. Detected emissions were maximized at each frequency by rotating the test item and adjusting the receiving antenna polarization. The radiated emission measurements of all non-harmonic and harmonics of the transmit frequency through the 10th harmonic measured with peak detector and 1MHz bandwidth.

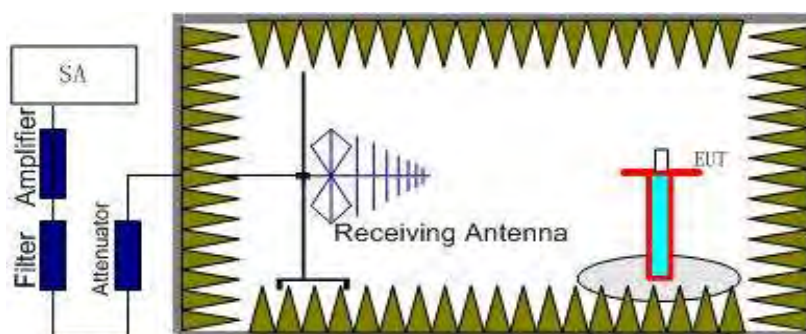

Radiated emissions measurements were made only at the upper, middle, and lower carrier frequencies. It was decided that measurements at these three carrier frequencies would be sufficient to demonstrate compliance with emissions limits because it was seen that all the significant spurs occur well outside the band and no radiation was seen from a carrier in one block of any band into any of the other blocks.

The substitution method is used. Substitution values at each frequency are measured before and saved to the test software. A "reference path loss" is established and the ARpl is the attenuation of "reference path loss", and including the gain of receive antenna, the gain of the preamplifier, the cable loss and the air loss. The measurement results are obtained as described below:
 $Power = P_{Mea} + AR_{pl}$

5.1.3 TEST PROCEDURES

1. The testing follows FCC KDB 971168 D01v03r01 Section 5.6 and ANSI C63.26 2015 Section 5.2.
2. The EUT was placed on a non-conductive rotating platform 1.5 meters high in a semi-anechoic chamber. The radiated emission at the fundamental frequency was measured at 3 m with a test antenna and a spectrum analyzer with Peak detector.
3. During the measurement, the system simulator parameters were set to force the EUT transmitting at maximum output power. The maximum emission was recorded from analyzer power level (LVL) from the 360 degrees rotation of the turntable and the test antenna raised and lowered over a range from 1 to 4 m in both horizontally and vertically polarized orientations.
4. Effective Isotropic Radiated Power (EIRP) was measured by substitution method according to ANSI C63.26 2015. The EUT was replaced by dipole antenna (substitution antenna) at same location and then a known power from S.G. was applied into the dipole antenna through a Tx cable, and then recorded the maximum Analyzer reading through raised and lowered the test antenna. $EIRP = S.G \text{ Level} + \text{Gain} - \text{Cable loss}$; $ERP = S.G \text{ Level} + \text{Gain} - \text{Cable loss} - 2.15$.
5. RB Set greater than bandwidth, VB Set spectrum analyzer Maximum support.

5.1.4 TEST RESULTS

Note: Test is divided into three directions, X/Y/Z. X pattern for the worst.

Note: Test chart See Appendix I

6. OCCUPIED BANDWIDTH

6.1 DESCRIPTION OF OCCUPIED BANDWIDTH MEASUREMENT

6.1.1 MEASUREMENT METHOD

1.The occupied bandwidth is the width of a frequency band such that, below the lower and above the upper frequency limits, the mean powers emitted are each equal to a specified percentage 0.5% of the total mean transmitted power.

2.The 26 db emission bandwidth is defined as the frequency range between two points, one above and one below the carrier frequency, at which the spectral density of the emission is attenuated 26 db below the maximum in-band spectral density of the modulated signal. spectral density (power per unit bandwidth) is to be measured with a detector of resolution bandwidth equal to approximately 1.0% of the emission bandwidth.

6.1.2 TEST SETUP

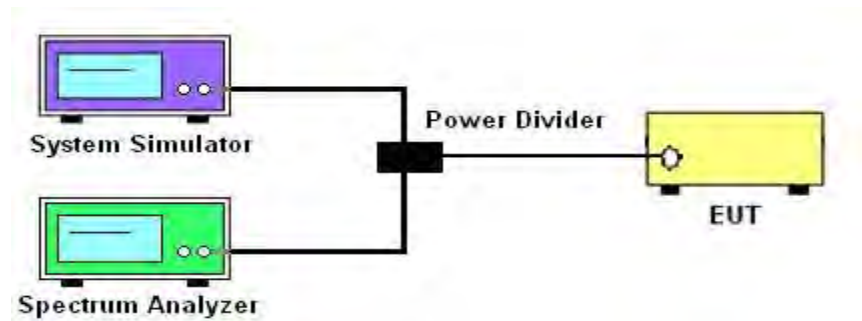

6.1.3 TEST PROCEDURES

1. The testing follows FCC KDB 971168 D01 v03r01 Section 4.2 and 4.3.
2. The EUT was connected to spectrum and system simulator via a power divider.
3. Select lowest, middle, and highest channels for each band and different modulation.
4. Set the test probe and measure the Occupied Bandwidth of the spectrum analyzer.
5. Measure and record the Occupied Bandwidth from the Spectrum Analyzer.

	LTE					
LTE BW	1.4M	3M	5M	10M	15M	20M
Span	3MHz	6MHz	10MHz	20MHz	30MHz	40MHz
RBW	30kHz	30kHz	100kHz	100kHz	300kHz	300kHz
VBW	100kHz	100kHz	300kHz	300kHz	1000kHz	1000kHz
Detector	PK	PK	PK	PK	PK	PK
Trace	Max	Max	Max	Max	Max	Max
Sweep Count	Auto	Auto	Auto	Auto	Auto	Auto

6.1.4 MEASUREMENT RESULT

Note: Test chart See Appendix I

7. CONDUCTED BAND EDGE

7.1 DESCRIPTION OF CONDUCTED BAND EDGE MEASUREMENT

7.1.1 MEASUREMENT METHOD

1. §22.917(a)

For operations in the 824 – 849 MHz band, the FCC limit is $43 + 10\log_{10}(P[\text{Watts}])$ dB below the transmitter power $P(\text{Watts})$ in a 100kHz bandwidth. However, in the 1MHz bands immediately outside and adjacent to the licensee's frequency block, a resolution bandwidth of at least one percent of the emission bandwidth of the fundamental emission of the transmitter may be employed.

2. §24.238 (a)

For operations in the 1850-1910 and 1930-1990 MHz band, the FCC limit is $43 + 10\log_{10}(P[\text{Watts}])$ dB below the transmitter power $P(\text{Watts})$ in a 1MHz bandwidth. However, in the 1 MHz bands immediately outside and adjacent to the frequency block a resolution bandwidth of at least one percent of the emission bandwidth of the fundamental emission of the transmitter may be employed

3. §27.53 (h)

For operations in the 1710 – 1755 MHz band, the FCC limit is $43 + 10\log_{10}(P[\text{Watts}])$ dB below the transmitter power $P(\text{Watts})$ in a 1 MHz bandwidth. However, in the 1MHz bands immediately outside and adjacent to the licensee's frequency block, a resolution bandwidth of at least one percent of the emission bandwidth of the fundamental emission of the transmitter may be employed.

4. §27.53(m)(4)

For operations in the 2500 MHz ~ 2570 MHz band this section, the attenuation factor shall be not less than $40 + 10 \log (P)$ dB on all frequencies between the channel edge and 5 megahertz from the channel edge, $43 + 10 \log (P)$ dB on all frequencies between 5 megahertz and X megahertz from the channel edge, and $55 + 10 \log (P)$ dB on all frequencies more than X megahertz from the channel edge, where X is the greater of 6 megahertz or the actual emission bandwidth as defined in paragraph (m)(6) of this section. In addition, the attenuation factor shall not be less that $43 + 10 \log (P)$ dB on all frequencies between 2490.5 MHz and 2496 MHz and $55 + 10 \log (P)$ dB at or below 2490.5 MHz. Mobile Satellite Service licensees operating on frequencies below 2495 MHz may also submit a documented interference complaint against BRS licensees operating on channel BRS Channel 1 on the same terms and conditions as adjacent channel BRS or EBS licensees.

5. §27.53 (g)

For operations in the 698 -746 MHz band, the FCC limit is $43 + 10\log_{10}(P[\text{Watts}])$ dB below the transmitter power $P(\text{Watts})$ in a 100 kHz bandwidth. However, in the 100 kilohertz bands immediately outside and adjacent to a licensee's frequency block, a resolution bandwidth of at least 30 kHz may be employed.

7.1.2 TEST SETUP

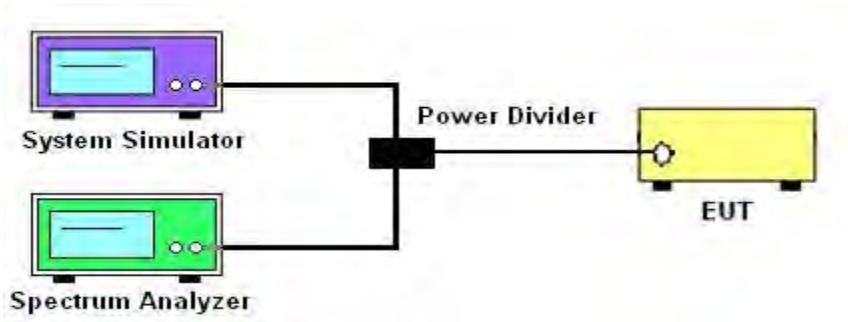

7.1.3 TEST PROCEDURES

1. The testing FCC KDB 971168 D01 v03r01 Section 6.0 and ANSI C63.26 2015 Section 5.7.
2. The EUT was connected to spectrum analyzer and system simulator via a power divider.
3. The band edges of low and high channels for the highest RF powers were measured. Set RBW \geq 1% EBW in the 1MHz band immediately outside and adjacent to the band edge.
4. Set spectrum analyzer with RMS/AVG detector.
5. The RF fundamental frequency should be excluded against the limit line in the operating frequency band.
6. The limit line is derived from $43 + 10\log(P)$ dB below the transmitter power P(Watts)
 - = $P(W) - [43 + 10\log(P)]$ (dB)
 - = $[30 + 10\log(P)]$ (dBm) - $[43 + 10\log(P)]$ (dB)
 - = -13dBm.

Band 7:

- = $P(W) - [55 + 10\log(P)]$ (dB)
- = $[30 + 10\log(P)]$ (dBm) - $[55 + 10\log(P)]$ (dB)
- = -25dBm.

	LTE					
LTE BW	1.4M	3M	5M	10M	15M	20M
Span	12MHz	13MHz	15MHz	20MHz	25MHz	30MHz
RBW	30kHz	30kHz	100kHz	100kHz	300kHz	300kHz
VBW	100kHz	100kHz	300kHz	300kHz	1000kHz	1000kHz
Detector	RMS	RMS	RMS	RMS	RMS	RMS
Trace	Max	Max	Max	Max	Max	Max
Sweep Count	Auto	Auto	Auto	Auto	Auto	Auto

7.1.4 MEASUREMENT RESULT

Note: Test chart See Appendix I

8. CONDUCTED SPURIOUS EMISSION

8.1 DESCRIPTION OF CONDUCTED SPURIOUS EMISSION MEASUREMENT

8.1.1 MEASUREMENT METHOD

The power of any emission outside of the authorized operating frequency ranges must be lower than the transmitter power (P) by a factor of at least $43 + 10 \log (P)$ dB.

For Band 7:

The power of any emission outside of the authorized operating frequency ranges must be lower than the transmitter power (P) by a factor of at least $55 + 10 \log (P)$ dB.

It is measured by means of a calibrated spectrum analyzer and scanned from 30 MHz up to a frequency including its 10th harmonic.

8.1.2 TEST SETUP

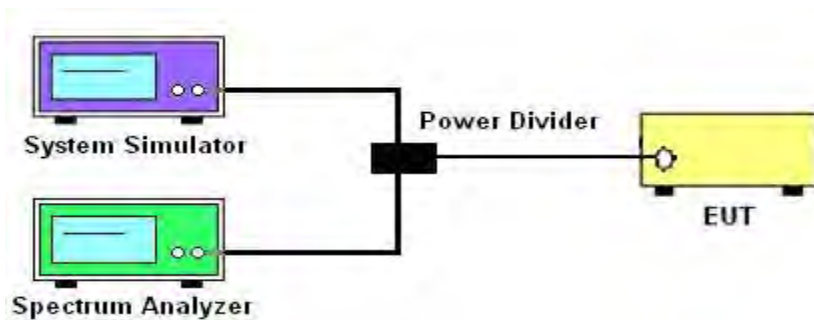

8.1.3 TEST PROCEDURES

1. The testing FCC KDB 971168 D01 v03r01 Section 6.0 and ANSI C63.26 2015 Section 5.7.
2. The EUT was connected to spectrum analyzer and system simulator via a power divider.
3. The RF output of EUT was connected to the spectrum analyzer by RF cable and attenuator. The path loss was compensated to the results for each measurement
4. Make the measurement with the spectrum analyzer's RBW = 1MHz, VBW = 3MHz, taking the record of maximum spurious emission.
5. The RF fundamental frequency should be excluded against the limit line in the operating frequency band.
6. The limit line is derived from $43 + 10\log(P)$ dB below the transmitter power P(Watts)
 $= P(W) - [43 + 10\log(P)]$ (dB) = $[30 + 10\log(P)]$ (dBm) - $[43 + 10\log(P)]$ (dB)
 $= -13$ dBm.

For Band 7: $P(W) - [43 + 10\log(P)]$ (dB) = -25 dBm

	LTE					
LTE BW	1.4M	3M	5M	10M	15M	20M
Span	Auto	Auto	Auto	Auto	Auto	Auto
RBW	1000kHz	1000kHz	1000kHz	1000kHz	1000kHz	1000kHz
VBW	3000kHz	3000kHz	3000kHz	3000kHz	3000kHz	3000kHz
Detector	PK	PK	PK	PK	PK	PK
Trace	Max	Max	Max	Max	Max	Max

8.1.4 TEST RESULTS

Note: Test chart See Appendix I

9. RADIATED SPURIOUS EMISSION

9.1 DESCRIPTION OF RADIATED SPURIOUS EMISSION

9.1.1 MEASUREMENT METHOD

The radiated spurious emission was measured by substitution method according to ANSI C63.26 2015. The power of any emission outside of the authorized operating frequency ranges must be attenuated below the transmitter power (P) by a factor of at least $43 + 10 \log (P)$ dB.

For Band 7 The power of any emission outside of the authorized operating frequency ranges must be attenuated below the transmitter power (P) by a factor of at least $55 + 10 \log (P)$ dB. The spectrum is scanned from 30 MHz up to a frequency including its 10th harmonic.

9.1.2 TEST SETUP

The procedure of radiated spurious emissions is as follows:

a) Pre-calibration With pre-calibration method, the Radiated Spurious Emissions(RSE) is calculated as, $RSE = Rx \text{ (dBuV)} + CL \text{ (dB)} + SA \text{ (dB)} + Gain \text{ (dBi)} - 107 \text{ (dBuV to dBm)}$ The SA is calibrated using following setup.

b) EUT was placed on 1.5 m non-conductive stand at a 3 m test distance from the receive antenna. A receiving antenna was placed on the antenna mast 3 m from the test item for emission measurements. The height of receiving antenna is 0.8m. The test setup refers to figure below. Detected emissions were maximized at each frequency by rotating the test item and adjusting the receiving antenna polarization. The radiated emission measurements of all non-harmonic and harmonics of the transmit frequency through the 10th harmonic measured with peak detector and 1MHz bandwidth. Radiated emissions measurements were made only at the upper, middle, and lower carrier frequencies It was decided that measurements at these three carrier frequencies would be sufficient to demonstrate compliance with emissions limits because it was seen that all the significant spurs occur well outside the band and no radiation was seen from a carrier in one block of any band into any of the other blocks.

The substitution method is used. Substitution values at each frequency are measured before and saved to the test software. A "reference path loss" is established and the ARpl is the attenuation of "reference path loss", and including the gain of receive antenna, the gain of the preamplifier, the cable loss and the air loss. The measurement results are obtained as described below: $Power = P_{Mea} + AR_{pl}$ For radiated test from 30MHz to 1GHz

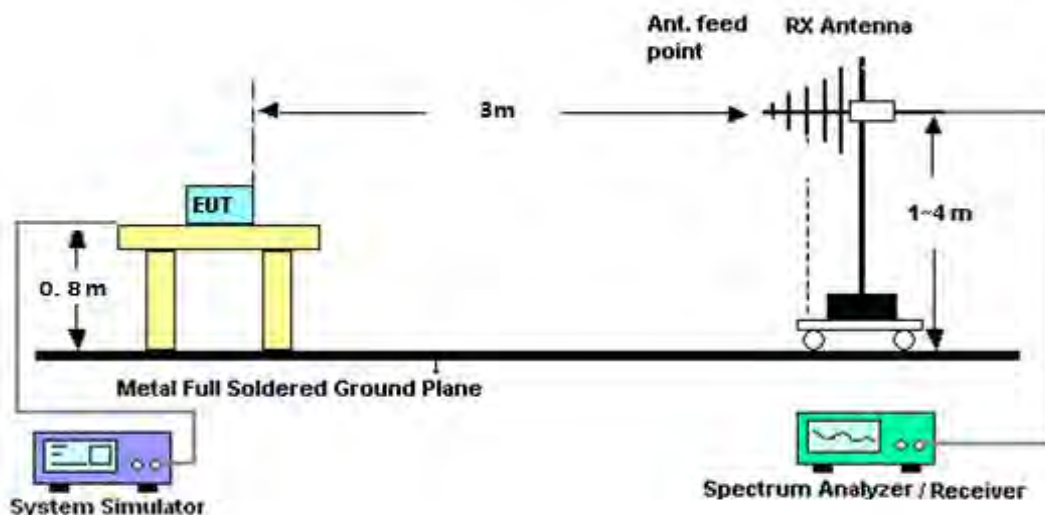

For radiated test from above 1GHz

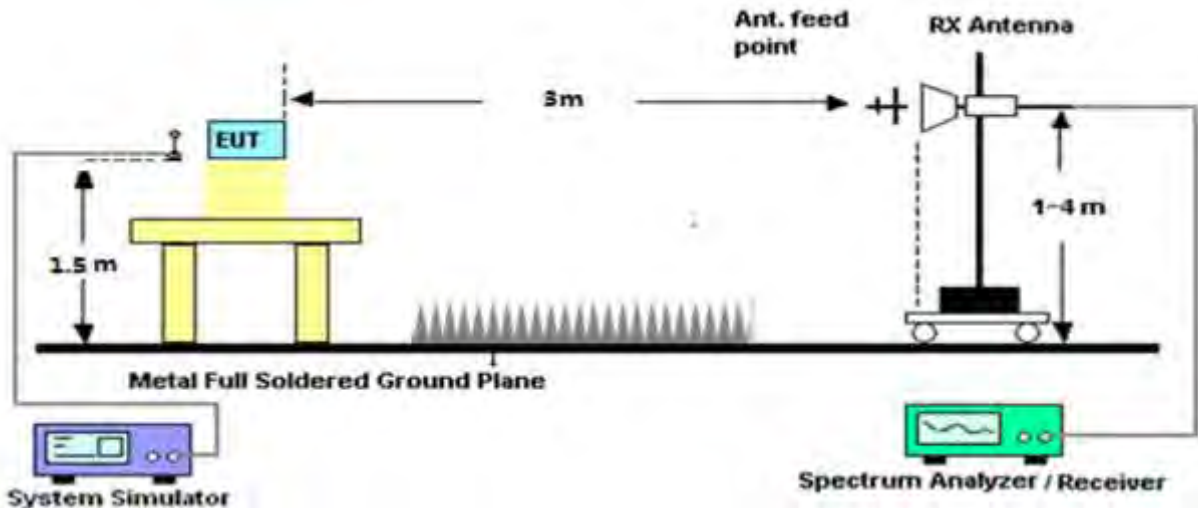

9.1.3 TEST PROCEDURES

1. The testing FCC KDB 971168 D01 Section 7 and ANSI C63.26 2015 Section 5.5.
2. The EUT was placed on a rotatable wooden table with 1.5 meter above ground.
3. The EUT was set 3 meters from the receiving antenna, which was mounted on the antenna tower.
4. The table was rotated 360 degrees to determine the position of the highest spurious emission.
5. The height of the receiving antenna is varied between one meter and four meters to search the maximum spurious emission for both horizontal and vertical polarizations
6. Make the measurement with the spectrum analyzer's RBW = 1MHz, VBW = 3MHz, taking the record of maximum spurious emission.
7. A horn antenna was substituted in place of the EUT and was driven by a signal generator.
8. Tune the output power of signal generator to the same emission level with EUT maximum spurious emission.
9. Taking the record of output power at antenna port.
10. Repeat step 7 to step 8 for another polarization.
11. The RF fundamental frequency should be excluded against the limit line in the operating frequency band.

The limit line is derived from $43 + 10\log(P)$ dB below the transmitter power P(Watts)
 $= P(W) - [43 + 10\log(P)]$ (dB)
 $= [30 + 10\log(P)]$ (dBm) - $[43 + 10\log(P)]$ (dB)
 $= -13$ dBm

For Band 7:

The limit line is derived from $55 + 10\log(P)$ dB below the transmitter power P(Watts)
 $= [30 + 10\log(P)]$ (dBm) - $[55 + 10\log(P)]$ (dB)
 $= -25$ dBm

$P_{Mea} = S.G \text{ Level} + \text{Ant-Cable loss}$; $\text{Margin} = P_{Mea} - \text{Limit}$.

9.1.4 TEST RESULTS

Note: Test chart See Appendix I

10. FREQUENCY STABILITY

10.1 DESCRIPTION OF FREQUENCY STABILITY MEASUREMENT

10.1.1 MEASUREMENT METHOD

The frequency stability shall be measured by variation of ambient temperature and variation of primary supply voltage to ensure that the fundamental emission stays within the authorized frequency block. The frequency stability of the transmitter shall be maintained within $\pm 0.00025\%$ ($\pm 2.5\text{ppm}$) of the center frequency.

10.1.2 TEST SETUP

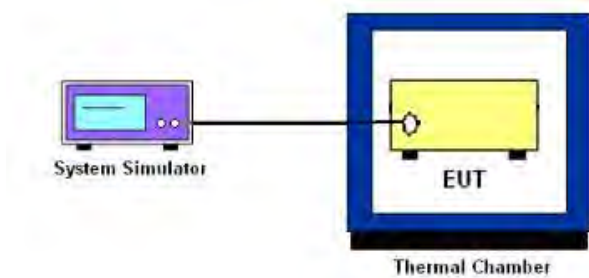

10.1.3 TEST PROCEDURES FOR TEMPERATURE VARIATION

1. The EUT was set up in the thermal chamber and connected with the system simulator.
2. With power OFF, the temperature was decreased to -30°C and the EUT was stabilized before testing. Power was applied and the maximum change in frequency was recorded within one minute.
3. With power OFF, the temperature was raised in 10°C step up to 50°C . The EUT was stabilized at each step for at least half an hour. Power was applied and the maximum frequency change was recorded within one minute.

10.1.4 TEST PROCEDURES FOR VOLTAGE VARIATION

1. The testing follows FCC KDB 971168 D01v01r03 Section 9.
2. The EUT was placed in a temperature chamber at $25\pm 5^{\circ}\text{C}$ and connected with the system simulator.
3. The power supply voltage to the EUT was varied from 85% to 115% of the nominal value measured at the input to the EUT.
4. The variation in frequency was measured for the worst case.

10.1.5 TEST RESULTS

Note: Test chart See Appendix I

APPENDIX I - TEST DATA

Conducted output power

Band	Bandwidth (MHz)	UL Channel	RB Size	RB Position	Modulation	Power (dBm)	Gain (dB)	EIRP (dBm)	EIRP Limit (dBm)	Verdict
Band2	1.4	18607	1	#0	QPSK	24.35	-0.2	24.15	33.01	PASS
Band2	1.4	18607	1	#Mid	QPSK	24.45	-0.2	24.25	33.01	PASS
Band2	1.4	18607	1	#Max	QPSK	24.46	-0.2	24.26	33.01	PASS
Band2	1.4	18607	3	#0	QPSK	24.36	-0.2	24.16	33.01	PASS
Band2	1.4	18607	3	#Mid	QPSK	24.32	-0.2	24.12	33.01	PASS
Band2	1.4	18607	3	#Max	QPSK	24.29	-0.2	24.09	33.01	PASS
Band2	1.4	18607	6	#0	QPSK	23.95	-0.2	23.75	33.01	PASS
Band2	1.4	18607	1	#0	16QAM	24.28	-0.2	24.08	33.01	PASS
Band2	1.4	18607	1	#Mid	16QAM	24.29	-0.2	24.09	33.01	PASS
Band2	1.4	18607	1	#Max	16QAM	24.27	-0.2	24.07	33.01	PASS
Band2	1.4	18607	3	#0	16QAM	23.51	-0.2	23.31	33.01	PASS
Band2	1.4	18607	3	#Mid	16QAM	23.51	-0.2	23.31	33.01	PASS
Band2	1.4	18607	3	#Max	16QAM	23.49	-0.2	23.29	33.01	PASS
Band2	1.4	18607	6	#0	16QAM	22.42	-0.2	22.22	33.01	PASS
Band2	1.4	18900	1	#0	QPSK	23.57	-0.2	23.37	33.01	PASS
Band2	1.4	18900	1	#Mid	QPSK	23.55	-0.2	23.35	33.01	PASS
Band2	1.4	18900	1	#Max	QPSK	23.67	-0.2	23.47	33.01	PASS
Band2	1.4	18900	3	#0	QPSK	23.63	-0.2	23.43	33.01	PASS
Band2	1.4	18900	3	#Mid	QPSK	23.70	-0.2	23.50	33.01	PASS
Band2	1.4	18900	3	#Max	QPSK	23.66	-0.2	23.46	33.01	PASS
Band2	1.4	18900	6	#0	QPSK	23.20	-0.2	23.00	33.01	PASS
Band2	1.4	18900	1	#0	16QAM	22.75	-0.2	22.55	33.01	PASS
Band2	1.4	18900	1	#Mid	16QAM	22.77	-0.2	22.57	33.01	PASS
Band2	1.4	18900	1	#Max	16QAM	22.64	-0.2	22.44	33.01	PASS
Band2	1.4	18900	3	#0	16QAM	22.72	-0.2	22.52	33.01	PASS
Band2	1.4	18900	3	#Mid	16QAM	22.67	-0.2	22.47	33.01	PASS
Band2	1.4	18900	3	#Max	16QAM	22.66	-0.2	22.46	33.01	PASS
Band2	1.4	18900	6	#0	16QAM	21.68	-0.2	21.48	33.01	PASS
Band2	1.4	19193	1	#0	QPSK	23.61	-0.2	23.41	33.01	PASS
Band2	1.4	19193	1	#Mid	QPSK	23.72	-0.2	23.52	33.01	PASS
Band2	1.4	19193	1	#Max	QPSK	23.70	-0.2	23.50	33.01	PASS
Band2	1.4	19193	3	#0	QPSK	23.63	-0.2	23.43	33.01	PASS
Band2	1.4	19193	3	#Mid	QPSK	23.68	-0.2	23.48	33.01	PASS
Band2	1.4	19193	3	#Max	QPSK	23.75	-0.2	23.55	33.01	PASS
Band2	1.4	19193	6	#0	QPSK	23.27	-0.2	23.07	33.01	PASS
Band2	1.4	19193	1	#0	16QAM	23.07	-0.2	22.87	33.01	PASS
Band2	1.4	19193	1	#Mid	16QAM	22.98	-0.2	22.78	33.01	PASS
Band2	1.4	19193	1	#Max	16QAM	22.99	-0.2	22.79	33.01	PASS
Band2	1.4	19193	3	#0	16QAM	23.14	-0.2	22.94	33.01	PASS
Band2	1.4	19193	3	#Mid	16QAM	23.14	-0.2	22.94	33.01	PASS
Band2	1.4	19193	3	#Max	16QAM	23.11	-0.2	22.91	33.01	PASS
Band2	1.4	19193	6	#0	16QAM	21.93	-0.2	21.73	33.01	PASS
Band2	3	18615	1	#0	QPSK	24.31	-0.2	24.11	33.01	PASS
Band2	3	18615	1	#Mid	QPSK	24.33	-0.2	24.13	33.01	PASS
Band2	3	18615	1	#Max	QPSK	24.22	-0.2	24.02	33.01	PASS
Band2	3	18615	8	#0	QPSK	23.90	-0.2	23.70	33.01	PASS
Band2	3	18615	8	#Mid	QPSK	23.85	-0.2	23.65	33.01	PASS
Band2	3	18615	8	#Max	QPSK	23.67	-0.2	23.47	33.01	PASS
Band2	3	18615	15	#0	QPSK	23.92	-0.2	23.72	33.01	PASS
Band2	3	18615	1	#0	16QAM	24.45	-0.2	24.25	33.01	PASS
Band2	3	18615	1	#Mid	16QAM	24.43	-0.2	24.23	33.01	PASS
Band2	3	18615	1	#Max	16QAM	24.35	-0.2	24.15	33.01	PASS
Band2	3	18615	8	#0	16QAM	22.31	-0.2	22.11	33.01	PASS
Band2	3	18615	8	#Mid	16QAM	22.25	-0.2	22.05	33.01	PASS
Band2	3	18615	8	#Max	16QAM	22.14	-0.2	21.94	33.01	PASS
Band2	3	18615	15	#0	16QAM	22.50	-0.2	22.30	33.01	PASS
Band2	3	18900	1	#0	QPSK	23.57	-0.2	23.37	33.01	PASS
Band2	3	18900	1	#Mid	QPSK	23.65	-0.2	23.45	33.01	PASS
Band2	3	18900	1	#Max	QPSK	23.58	-0.2	23.38	33.01	PASS
Band2	3	18900	8	#0	QPSK	23.16	-0.2	22.96	33.01	PASS
Band2	3	18900	8	#Mid	QPSK	23.25	-0.2	23.05	33.01	PASS

Band2	3	18900	8	#Max	QPSK	23.26	-0.2	23.06	33.01	PASS
Band2	3	18900	15	#0	QPSK	23.22	-0.2	23.02	33.01	PASS
Band2	3	18900	1	#0	16QAM	22.70	-0.2	22.50	33.01	PASS
Band2	3	18900	1	#Mid	16QAM	22.73	-0.2	22.53	33.01	PASS
Band2	3	18900	1	#Max	16QAM	22.68	-0.2	22.48	33.01	PASS
Band2	3	18900	8	#0	16QAM	21.83	-0.2	21.63	33.01	PASS
Band2	3	18900	8	#Mid	16QAM	21.82	-0.2	21.62	33.01	PASS
Band2	3	18900	8	#Max	16QAM	21.79	-0.2	21.59	33.01	PASS
Band2	3	18900	15	#0	16QAM	21.73	-0.2	21.53	33.01	PASS
Band2	3	19185	1	#0	QPSK	23.68	-0.2	23.48	33.01	PASS
Band2	3	19185	1	#Mid	QPSK	23.72	-0.2	23.52	33.01	PASS
Band2	3	19185	1	#Max	QPSK	23.67	-0.2	23.47	33.01	PASS
Band2	3	19185	8	#0	QPSK	23.29	-0.2	23.09	33.01	PASS
Band2	3	19185	8	#Mid	QPSK	23.32	-0.2	23.12	33.01	PASS
Band2	3	19185	8	#Max	QPSK	23.24	-0.2	23.04	33.01	PASS
Band2	3	19185	15	#0	QPSK	23.27	-0.2	23.07	33.01	PASS
Band2	3	19185	1	#0	16QAM	23.08	-0.2	22.88	33.01	PASS
Band2	3	19185	1	#Mid	16QAM	22.99	-0.2	22.79	33.01	PASS
Band2	3	19185	1	#Max	16QAM	23.05	-0.2	22.85	33.01	PASS
Band2	3	19185	8	#0	16QAM	21.74	-0.2	21.54	33.01	PASS
Band2	3	19185	8	#Mid	16QAM	21.76	-0.2	21.56	33.01	PASS
Band2	3	19185	8	#Max	16QAM	21.73	-0.2	21.53	33.01	PASS
Band2	3	19185	15	#0	16QAM	21.85	-0.2	21.65	33.01	PASS
Band2	5	18625	1	#0	QPSK	24.27	-0.2	24.07	33.01	PASS
Band2	5	18625	1	#Mid	QPSK	24.17	-0.2	23.97	33.01	PASS
Band2	5	18625	1	#Max	QPSK	24.33	-0.2	24.13	33.01	PASS
Band2	5	18625	12	#0	QPSK	23.80	-0.2	23.60	33.01	PASS
Band2	5	18625	12	#Mid	QPSK	23.86	-0.2	23.66	33.01	PASS
Band2	5	18625	12	#Max	QPSK	23.74	-0.2	23.54	33.01	PASS
Band2	5	18625	25	#0	QPSK	23.72	-0.2	23.52	33.01	PASS
Band2	5	18625	1	#0	16QAM	23.43	-0.2	23.23	33.01	PASS
Band2	5	18625	1	#Mid	16QAM	23.35	-0.2	23.15	33.01	PASS
Band2	5	18625	1	#Max	16QAM	23.41	-0.2	23.21	33.01	PASS
Band2	5	18625	12	#0	16QAM	22.32	-0.2	22.12	33.01	PASS
Band2	5	18625	12	#Mid	16QAM	22.24	-0.2	22.04	33.01	PASS
Band2	5	18625	12	#Max	16QAM	22.26	-0.2	22.06	33.01	PASS
Band2	5	18625	25	#0	16QAM	22.43	-0.2	22.23	33.01	PASS
Band2	5	18900	1	#0	QPSK	23.60	-0.2	23.40	33.01	PASS
Band2	5	18900	1	#Mid	QPSK	23.66	-0.2	23.46	33.01	PASS
Band2	5	18900	1	#Max	QPSK	23.64	-0.2	23.44	33.01	PASS
Band2	5	18900	12	#0	QPSK	23.23	-0.2	23.03	33.01	PASS
Band2	5	18900	12	#Mid	QPSK	23.13	-0.2	22.93	33.01	PASS
Band2	5	18900	12	#Max	QPSK	23.07	-0.2	22.87	33.01	PASS
Band2	5	18900	25	#0	QPSK	23.24	-0.2	23.04	33.01	PASS
Band2	5	18900	1	#0	16QAM	22.30	-0.2	22.10	33.01	PASS
Band2	5	18900	1	#Mid	16QAM	22.38	-0.2	22.18	33.01	PASS
Band2	5	18900	1	#Max	16QAM	22.28	-0.2	22.08	33.01	PASS
Band2	5	18900	12	#0	16QAM	21.53	-0.2	21.33	33.01	PASS
Band2	5	18900	12	#Mid	16QAM	21.56	-0.2	21.36	33.01	PASS
Band2	5	18900	12	#Max	16QAM	21.52	-0.2	21.32	33.01	PASS
Band2	5	18900	25	#0	16QAM	21.78	-0.2	21.58	33.01	PASS
Band2	5	19175	1	#0	QPSK	23.67	-0.2	23.47	33.01	PASS
Band2	5	19175	1	#Mid	QPSK	23.63	-0.2	23.43	33.01	PASS
Band2	5	19175	1	#Max	QPSK	23.72	-0.2	23.52	33.01	PASS
Band2	5	19175	12	#0	QPSK	23.19	-0.2	22.99	33.01	PASS
Band2	5	19175	12	#Mid	QPSK	23.28	-0.2	23.08	33.01	PASS
Band2	5	19175	12	#Max	QPSK	23.26	-0.2	23.06	33.01	PASS
Band2	5	19175	25	#0	QPSK	23.25	-0.2	23.05	33.01	PASS
Band2	5	19175	1	#0	16QAM	22.68	-0.2	22.48	33.01	PASS
Band2	5	19175	1	#Mid	16QAM	22.74	-0.2	22.54	33.01	PASS
Band2	5	19175	1	#Max	16QAM	22.68	-0.2	22.48	33.01	PASS
Band2	5	19175	12	#0	16QAM	21.68	-0.2	21.48	33.01	PASS
Band2	5	19175	12	#Mid	16QAM	21.65	-0.2	21.45	33.01	PASS
Band2	5	19175	12	#Max	16QAM	21.65	-0.2	21.45	33.01	PASS
Band2	5	19175	25	#0	16QAM	21.70	-0.2	21.50	33.01	PASS
Band2	10	18650	1	#0	QPSK	24.29	-0.2	24.09	33.01	PASS
Band2	10	18650	1	#Mid	QPSK	24.25	-0.2	24.05	33.01	PASS
Band2	10	18650	1	#Max	QPSK	24.20	-0.2	24.00	33.01	PASS

Band2	10	18650	25	#0	QPSK	23.75	-0.2	23.55	33.01	PASS
Band2	10	18650	25	#Mid	QPSK	23.88	-0.2	23.68	33.01	PASS
Band2	10	18650	25	#Max	QPSK	23.86	-0.2	23.66	33.01	PASS
Band2	10	18650	50	#0	QPSK	23.89	-0.2	23.69	33.01	PASS
Band2	10	18650	1	#0	16QAM	24.35	-0.2	24.15	33.01	PASS
Band2	10	18650	1	#Mid	16QAM	24.24	-0.2	24.04	33.01	PASS
Band2	10	18650	1	#Max	16QAM	24.22	-0.2	24.02	33.01	PASS
Band2	10	18650	25	#0	16QAM	22.32	-0.2	22.12	33.01	PASS
Band2	10	18650	25	#Mid	16QAM	22.34	-0.2	22.14	33.01	PASS
Band2	10	18650	25	#Max	16QAM	22.38	-0.2	22.18	33.01	PASS
Band2	10	18650	50	#0	16QAM	22.34	-0.2	22.14	33.01	PASS
Band2	10	18900	1	#0	QPSK	23.66	-0.2	23.46	33.01	PASS
Band2	10	18900	1	#Mid	QPSK	23.62	-0.2	23.42	33.01	PASS
Band2	10	18900	1	#Max	QPSK	23.60	-0.2	23.40	33.01	PASS
Band2	10	18900	25	#0	QPSK	23.25	-0.2	23.05	33.01	PASS
Band2	10	18900	25	#Mid	QPSK	23.25	-0.2	23.05	33.01	PASS
Band2	10	18900	25	#Max	QPSK	23.07	-0.2	22.87	33.01	PASS
Band2	10	18900	50	#0	QPSK	23.26	-0.2	23.06	33.01	PASS
Band2	10	18900	1	#0	16QAM	22.68	-0.2	22.48	33.01	PASS
Band2	10	18900	1	#Mid	16QAM	22.68	-0.2	22.48	33.01	PASS
Band2	10	18900	1	#Max	16QAM	22.63	-0.2	22.43	33.01	PASS
Band2	10	18900	25	#0	16QAM	21.67	-0.2	21.47	33.01	PASS
Band2	10	18900	25	#Mid	16QAM	21.72	-0.2	21.52	33.01	PASS
Band2	10	18900	25	#Max	16QAM	21.70	-0.2	21.50	33.01	PASS
Band2	10	18900	50	#0	16QAM	21.76	-0.2	21.56	33.01	PASS
Band2	10	19150	1	#0	QPSK	23.67	-0.2	23.47	33.01	PASS
Band2	10	19150	1	#Mid	QPSK	23.74	-0.2	23.54	33.01	PASS
Band2	10	19150	1	#Max	QPSK	23.79	-0.2	23.59	33.01	PASS
Band2	10	19150	25	#0	QPSK	23.13	-0.2	22.93	33.01	PASS
Band2	10	19150	25	#Mid	QPSK	23.22	-0.2	23.02	33.01	PASS
Band2	10	19150	25	#Max	QPSK	23.21	-0.2	23.01	33.01	PASS
Band2	10	19150	50	#0	QPSK	23.30	-0.2	23.10	33.01	PASS
Band2	10	19150	1	#0	16QAM	22.58	-0.2	22.38	33.01	PASS
Band2	10	19150	1	#Mid	16QAM	22.72	-0.2	22.52	33.01	PASS
Band2	10	19150	1	#Max	16QAM	22.72	-0.2	22.52	33.01	PASS
Band2	10	19150	25	#0	16QAM	21.69	-0.2	21.49	33.01	PASS
Band2	10	19150	25	#Mid	16QAM	21.70	-0.2	21.50	33.01	PASS
Band2	10	19150	25	#Max	16QAM	21.76	-0.2	21.56	33.01	PASS
Band2	10	19150	50	#0	16QAM	21.65	-0.2	21.45	33.01	PASS
Band2	15	18675	1	#0	QPSK	24.27	-0.2	24.07	33.01	PASS
Band2	15	18675	1	#Mid	QPSK	24.24	-0.2	24.04	33.01	PASS
Band2	15	18675	1	#Max	QPSK	24.06	-0.2	23.86	33.01	PASS
Band2	15	18675	36	#0	QPSK	23.83	-0.2	23.63	33.01	PASS
Band2	15	18675	36	#Mid	QPSK	23.79	-0.2	23.59	33.01	PASS
Band2	15	18675	36	#Max	QPSK	23.75	-0.2	23.55	33.01	PASS
Band2	15	18675	75	#0	QPSK	23.87	-0.2	23.67	33.01	PASS
Band2	15	18675	1	#0	16QAM	24.35	-0.2	24.15	33.01	PASS
Band2	15	18675	1	#Mid	16QAM	24.29	-0.2	24.09	33.01	PASS
Band2	15	18675	1	#Max	16QAM	24.15	-0.2	23.95	33.01	PASS
Band2	15	18675	36	#0	16QAM	22.38	-0.2	22.18	33.01	PASS
Band2	15	18675	36	#Mid	16QAM	22.33	-0.2	22.13	33.01	PASS
Band2	15	18675	36	#Max	16QAM	22.33	-0.2	22.13	33.01	PASS
Band2	15	18675	75	#0	16QAM	22.24	-0.2	22.04	33.01	PASS
Band2	15	18900	1	#0	QPSK	23.91	-0.2	23.71	33.01	PASS
Band2	15	18900	1	#Mid	QPSK	23.82	-0.2	23.62	33.01	PASS
Band2	15	18900	1	#Max	QPSK	23.77	-0.2	23.57	33.01	PASS
Band2	15	18900	36	#0	QPSK	23.15	-0.2	22.95	33.01	PASS
Band2	15	18900	36	#Mid	QPSK	23.17	-0.2	22.97	33.01	PASS
Band2	15	18900	36	#Max	QPSK	23.13	-0.2	22.93	33.01	PASS
Band2	15	18900	75	#0	QPSK	23.25	-0.2	23.05	33.01	PASS
Band2	15	18900	1	#0	16QAM	22.80	-0.2	22.60	33.01	PASS
Band2	15	18900	1	#Mid	16QAM	22.73	-0.2	22.53	33.01	PASS
Band2	15	18900	1	#Max	16QAM	22.73	-0.2	22.53	33.01	PASS
Band2	15	18900	36	#0	16QAM	21.77	-0.2	21.57	33.01	PASS
Band2	15	18900	36	#Mid	16QAM	21.82	-0.2	21.62	33.01	PASS
Band2	15	18900	36	#Max	16QAM	21.82	-0.2	21.62	33.01	PASS
Band2	15	18900	75	#0	16QAM	21.66	-0.2	21.46	33.01	PASS
Band2	15	19125	1	#0	QPSK	23.61	-0.2	23.41	33.01	PASS

Band2	15	19125	1	#Mid	QPSK	23.62	-0.2	23.42	33.01	PASS
Band2	15	19125	1	#Max	QPSK	23.73	-0.2	23.53	33.01	PASS
Band2	15	19125	36	#0	QPSK	23.18	-0.2	22.98	33.01	PASS
Band2	15	19125	36	#Mid	QPSK	23.19	-0.2	22.99	33.01	PASS
Band2	15	19125	36	#Max	QPSK	23.30	-0.2	23.10	33.01	PASS
Band2	15	19125	75	#0	QPSK	23.11	-0.2	22.91	33.01	PASS
Band2	15	19125	1	#0	16QAM	23.18	-0.2	22.98	33.01	PASS
Band2	15	19125	1	#Mid	16QAM	23.20	-0.2	23.00	33.01	PASS
Band2	15	19125	1	#Max	16QAM	23.35	-0.2	23.15	33.01	PASS
Band2	15	19125	36	#0	16QAM	21.72	-0.2	21.52	33.01	PASS
Band2	15	19125	36	#Mid	16QAM	21.73	-0.2	21.53	33.01	PASS
Band2	15	19125	36	#Max	16QAM	21.76	-0.2	21.56	33.01	PASS
Band2	15	19125	75	#0	16QAM	21.85	-0.2	21.65	33.01	PASS
Band2	20	18700	1	#0	QPSK	24.83	-0.2	24.63	33.01	PASS
Band2	20	18700	1	#Mid	QPSK	24.77	-0.2	24.57	33.01	PASS
Band2	20	18700	1	#Max	QPSK	24.36	-0.2	24.16	33.01	PASS
Band2	20	18700	50	#0	QPSK	24.27	-0.2	24.07	33.01	PASS
Band2	20	18700	50	#Mid	QPSK	24.16	-0.2	23.96	33.01	PASS
Band2	20	18700	50	#Max	QPSK	24.05	-0.2	23.85	33.01	PASS
Band2	20	18700	100	#0	QPSK	24.3	-0.2	24.10	33.01	PASS
Band2	20	18700	1	#0	16QAM	23.51	-0.2	23.31	33.01	PASS
Band2	20	18700	1	#Mid	16QAM	23.33	-0.2	23.13	33.01	PASS
Band2	20	18700	1	#Max	16QAM	23.13	-0.2	22.93	33.01	PASS
Band2	20	18700	50	#0	16QAM	22.81	-0.2	22.61	33.01	PASS
Band2	20	18700	50	#Mid	16QAM	22.74	-0.2	22.54	33.01	PASS
Band2	20	18700	50	#Max	16QAM	22.56	-0.2	22.36	33.01	PASS
Band2	20	18700	100	#0	16QAM	22.68	-0.2	22.48	33.01	PASS
Band2	20	18900	1	#0	QPSK	24.55	-0.2	24.35	33.01	PASS
Band2	20	18900	1	#Mid	QPSK	24.48	-0.2	24.28	33.01	PASS
Band2	20	18900	1	#Max	QPSK	24.49	-0.2	24.29	33.01	PASS
Band2	20	18900	50	#0	QPSK	23.87	-0.2	23.67	33.01	PASS
Band2	20	18900	50	#Mid	QPSK	23.79	-0.2	23.59	33.01	PASS
Band2	20	18900	50	#Max	QPSK	23.63	-0.2	23.43	33.01	PASS
Band2	20	18900	100	#0	QPSK	23.78	-0.2	23.58	33.01	PASS
Band2	20	18900	1	#0	16QAM	22.85	-0.2	22.65	33.01	PASS
Band2	20	18900	1	#Mid	16QAM	22.78	-0.2	22.58	33.01	PASS
Band2	20	18900	1	#Max	16QAM	22.78	-0.2	22.58	33.01	PASS
Band2	20	18900	50	#0	16QAM	22.7	-0.2	22.50	33.01	PASS
Band2	20	18900	50	#Mid	16QAM	22.34	-0.2	22.14	33.01	PASS
Band2	20	18900	50	#Max	16QAM	22.18	-0.2	21.98	33.01	PASS
Band2	20	18900	100	#0	16QAM	22.34	-0.2	22.14	33.01	PASS
Band2	20	19100	1	#0	QPSK	24.16	-0.2	23.96	33.01	PASS
Band2	20	19100	1	#Mid	QPSK	24.29	-0.2	24.09	33.01	PASS
Band2	20	19100	1	#Max	QPSK	24.36	-0.2	24.16	33.01	PASS
Band2	20	19100	50	#0	QPSK	23.59	-0.2	23.39	33.01	PASS
Band2	20	19100	50	#Mid	QPSK	23.74	-0.2	23.54	33.01	PASS
Band2	20	19100	50	#Max	QPSK	23.89	-0.2	23.69	33.01	PASS
Band2	20	19100	100	#0	QPSK	23.77	-0.2	23.57	33.01	PASS
Band2	20	19100	1	#0	16QAM	23.43	-0.2	23.23	33.01	PASS
Band2	20	19100	1	#Mid	16QAM	23.54	-0.2	23.34	33.01	PASS
Band2	20	19100	1	#Max	16QAM	23.6	-0.2	23.40	33.01	PASS
Band2	20	19100	50	#0	16QAM	22.64	-0.2	22.44	33.01	PASS
Band2	20	19100	50	#Mid	16QAM	22.3	-0.2	22.10	33.01	PASS
Band2	20	19100	50	#Max	16QAM	22.31	-0.2	22.11	33.01	PASS
Band2	20	19100	100	#0	16QAM	22.27	-0.2	22.07	33.01	PASS

Band	Bandwidth (MHz)	UL Channel	RB Size	RB Position	Modulation	Power (dBm)	Gain (dB)	EIRP (dBm)	EIRP Limit (dBm)	Verdict
Band4	1.4	19957	1	#0	QPSK	24.7	0.1	24.80	30	PASS
Band4	1.4	19957	1	#Mid	QPSK	24.72	0.1	24.82	30	PASS
Band4	1.4	19957	1	#Max	QPSK	24.71	0.1	24.81	30	PASS
Band4	1.4	19957	3	#0	QPSK	24.48	0.1	24.58	30	PASS
Band4	1.4	19957	3	#Mid	QPSK	24.55	0.1	24.65	30	PASS
Band4	1.4	19957	3	#Max	QPSK	24.51	0.1	24.61	30	PASS
Band4	1.4	19957	6	#0	QPSK	24.19	0.1	24.29	30	PASS
Band4	1.4	19957	1	#0	16QAM	24.67	0.1	24.77	30	PASS
Band4	1.4	19957	1	#Mid	16QAM	24.57	0.1	24.67	30	PASS
Band4	1.4	19957	1	#Max	16QAM	24.61	0.1	24.71	30	PASS
Band4	1.4	19957	3	#0	16QAM	23.78	0.1	23.88	30	PASS
Band4	1.4	19957	3	#Mid	16QAM	23.78	0.1	23.88	30	PASS
Band4	1.4	19957	3	#Max	16QAM	23.75	0.1	23.85	30	PASS
Band4	1.4	19957	6	#0	16QAM	22.77	0.1	22.87	30	PASS
Band4	1.4	20175	1	#0	QPSK	24.5	0.1	24.60	30	PASS
Band4	1.4	20175	1	#Mid	QPSK	24.55	0.1	24.65	30	PASS
Band4	1.4	20175	1	#Max	QPSK	24.57	0.1	24.67	30	PASS
Band4	1.4	20175	3	#0	QPSK	24.44	0.1	24.54	30	PASS
Band4	1.4	20175	3	#Mid	QPSK	24.38	0.1	24.48	30	PASS
Band4	1.4	20175	3	#Max	QPSK	24.45	0.1	24.55	30	PASS
Band4	1.4	20175	6	#0	QPSK	23.93	0.1	24.03	30	PASS
Band4	1.4	20175	1	#0	16QAM	23.45	0.1	23.55	30	PASS
Band4	1.4	20175	1	#Mid	16QAM	23.65	0.1	23.75	30	PASS
Band4	1.4	20175	1	#Max	16QAM	23.51	0.1	23.61	30	PASS
Band4	1.4	20175	3	#0	16QAM	23.41	0.1	23.51	30	PASS
Band4	1.4	20175	3	#Mid	16QAM	23.4	0.1	23.50	30	PASS
Band4	1.4	20175	3	#Max	16QAM	23.45	0.1	23.55	30	PASS
Band4	1.4	20175	6	#0	16QAM	22.71	0.1	22.81	30	PASS
Band4	1.4	20393	1	#0	QPSK	24.34	0.1	24.44	30	PASS
Band4	1.4	20393	1	#Mid	QPSK	24.35	0.1	24.45	30	PASS
Band4	1.4	20393	1	#Max	QPSK	24.32	0.1	24.42	30	PASS
Band4	1.4	20393	3	#0	QPSK	24.2	0.1	24.30	30	PASS
Band4	1.4	20393	3	#Mid	QPSK	24.25	0.1	24.35	30	PASS
Band4	1.4	20393	3	#Max	QPSK	24.19	0.1	24.29	30	PASS
Band4	1.4	20393	6	#0	QPSK	23.73	0.1	23.83	30	PASS
Band4	1.4	20393	1	#0	16QAM	22.85	0.1	22.95	30	PASS
Band4	1.4	20393	1	#Mid	16QAM	22.8	0.1	22.90	30	PASS
Band4	1.4	20393	1	#Max	16QAM	22.87	0.1	22.97	30	PASS
Band4	1.4	20393	3	#0	16QAM	23.18	0.1	23.28	30	PASS
Band4	1.4	20393	3	#Mid	16QAM	23.07	0.1	23.17	30	PASS
Band4	1.4	20393	3	#Max	16QAM	23.23	0.1	23.33	30	PASS
Band4	1.4	20393	6	#0	16QAM	22.27	0.1	22.37	30	PASS
Band4	3	19965	1	#0	QPSK	24.56	0.1	24.66	30	PASS
Band4	3	19965	1	#Mid	QPSK	24.56	0.1	24.66	30	PASS
Band4	3	19965	1	#Max	QPSK	24.61	0.1	24.71	30	PASS
Band4	3	19965	8	#0	QPSK	23.98	0.1	24.08	30	PASS
Band4	3	19965	8	#Mid	QPSK	24.05	0.1	24.15	30	PASS
Band4	3	19965	8	#Max	QPSK	24.05	0.1	24.15	30	PASS
Band4	3	19965	15	#0	QPSK	24	0.1	24.10	30	PASS
Band4	3	19965	1	#0	16QAM	24.75	0.1	24.85	30	PASS
Band4	3	19965	1	#Mid	16QAM	24.72	0.1	24.82	30	PASS
Band4	3	19965	1	#Max	16QAM	24.66	0.1	24.76	30	PASS
Band4	3	19965	8	#0	16QAM	22.62	0.1	22.72	30	PASS
Band4	3	19965	8	#Mid	16QAM	22.57	0.1	22.67	30	PASS
Band4	3	19965	8	#Max	16QAM	22.47	0.1	22.57	30	PASS
Band4	3	19965	15	#0	16QAM	22.75	0.1	22.85	30	PASS
Band4	3	20175	1	#0	QPSK	24.53	0.1	24.63	30	PASS
Band4	3	20175	1	#Mid	QPSK	24.56	0.1	24.66	30	PASS
Band4	3	20175	1	#Max	QPSK	24.55	0.1	24.65	30	PASS
Band4	3	20175	8	#0	QPSK	23.9	0.1	24.00	30	PASS
Band4	3	20175	8	#Mid	QPSK	23.97	0.1	24.07	30	PASS
Band4	3	20175	8	#Max	QPSK	23.96	0.1	24.06	30	PASS
Band4	3	20175	15	#0	QPSK	23.94	0.1	24.04	30	PASS
Band4	3	20175	1	#0	16QAM	23.51	0.1	23.61	30	PASS
Band4	3	20175	1	#Mid	16QAM	23.54	0.1	23.64	30	PASS

Band4	3	20175	1	#Max	16QAM	23.54	0.1	23.64	30	PASS
Band4	3	20175	8	#0	16QAM	22.52	0.1	22.62	30	PASS
Band4	3	20175	8	#Mid	16QAM	22.58	0.1	22.68	30	PASS
Band4	3	20175	8	#Max	16QAM	22.57	0.1	22.67	30	PASS
Band4	3	20175	15	#0	16QAM	22.5	0.1	22.60	30	PASS
Band4	3	20385	1	#0	QPSK	24.37	0.1	24.47	30	PASS
Band4	3	20385	1	#Mid	QPSK	24.37	0.1	24.47	30	PASS
Band4	3	20385	1	#Max	QPSK	24.42	0.1	24.52	30	PASS
Band4	3	20385	8	#0	QPSK	23.74	0.1	23.84	30	PASS
Band4	3	20385	8	#Mid	QPSK	23.78	0.1	23.88	30	PASS
Band4	3	20385	8	#Max	QPSK	23.72	0.1	23.82	30	PASS
Band4	3	20385	15	#0	QPSK	23.75	0.1	23.85	30	PASS
Band4	3	20385	1	#0	16QAM	22.87	0.1	22.97	30	PASS
Band4	3	20385	1	#Mid	16QAM	22.84	0.1	22.94	30	PASS
Band4	3	20385	1	#Max	16QAM	22.86	0.1	22.96	30	PASS
Band4	3	20385	8	#0	16QAM	22.4	0.1	22.50	30	PASS
Band4	3	20385	8	#Mid	16QAM	22.4	0.1	22.50	30	PASS
Band4	3	20385	8	#Max	16QAM	22.42	0.1	22.52	30	PASS
Band4	3	20385	15	#0	16QAM	22.25	0.1	22.35	30	PASS
Band4	5	19975	1	#0	QPSK	24.52	0.1	24.62	30	PASS
Band4	5	19975	1	#Mid	QPSK	24.49	0.1	24.59	30	PASS
Band4	5	19975	1	#Max	QPSK	24.42	0.1	24.52	30	PASS
Band4	5	19975	12	#0	QPSK	24.14	0.1	24.24	30	PASS
Band4	5	19975	12	#Mid	QPSK	23.98	0.1	24.08	30	PASS
Band4	5	19975	12	#Max	QPSK	24.03	0.1	24.13	30	PASS
Band4	5	19975	25	#0	QPSK	23.96	0.1	24.06	30	PASS
Band4	5	19975	1	#0	16QAM	23.67	0.1	23.77	30	PASS
Band4	5	19975	1	#Mid	16QAM	23.63	0.1	23.73	30	PASS
Band4	5	19975	1	#Max	16QAM	23.61	0.1	23.71	30	PASS
Band4	5	19975	12	#0	16QAM	22.58	0.1	22.68	30	PASS
Band4	5	19975	12	#Mid	16QAM	22.49	0.1	22.59	30	PASS
Band4	5	19975	12	#Max	16QAM	22.55	0.1	22.65	30	PASS
Band4	5	19975	25	#0	16QAM	22.72	0.1	22.82	30	PASS
Band4	5	20175	1	#0	QPSK	24.45	0.1	24.55	30	PASS
Band4	5	20175	1	#Mid	QPSK	24.5	0.1	24.60	30	PASS
Band4	5	20175	1	#Max	QPSK	24.53	0.1	24.63	30	PASS
Band4	5	20175	12	#0	QPSK	23.97	0.1	24.07	30	PASS
Band4	5	20175	12	#Mid	QPSK	23.96	0.1	24.06	30	PASS
Band4	5	20175	12	#Max	QPSK	23.96	0.1	24.06	30	PASS
Band4	5	20175	25	#0	QPSK	23.93	0.1	24.03	30	PASS
Band4	5	20175	1	#0	16QAM	23.48	0.1	23.58	30	PASS
Band4	5	20175	1	#Mid	16QAM	23.49	0.1	23.59	30	PASS
Band4	5	20175	1	#Max	16QAM	23.53	0.1	23.63	30	PASS
Band4	5	20175	12	#0	16QAM	22.34	0.1	22.44	30	PASS
Band4	5	20175	12	#Mid	16QAM	22.28	0.1	22.38	30	PASS
Band4	5	20175	12	#Max	16QAM	22.35	0.1	22.45	30	PASS
Band4	5	20175	25	#0	16QAM	22.55	0.1	22.65	30	PASS
Band4	5	20375	1	#0	QPSK	23.94	0.1	24.04	30	PASS
Band4	5	20375	1	#Mid	QPSK	23.87	0.1	23.97	30	PASS
Band4	5	20375	1	#Max	QPSK	24.02	0.1	24.12	30	PASS
Band4	5	20375	12	#0	QPSK	23.66	0.1	23.76	30	PASS
Band4	5	20375	12	#Mid	QPSK	23.57	0.1	23.67	30	PASS
Band4	5	20375	12	#Max	QPSK	23.65	0.1	23.75	30	PASS
Band4	5	20375	25	#0	QPSK	23.67	0.1	23.77	30	PASS
Band4	5	20375	1	#0	16QAM	23.72	0.1	23.82	30	PASS
Band4	5	20375	1	#Mid	16QAM	23.64	0.1	23.74	30	PASS
Band4	5	20375	1	#Max	16QAM	23.74	0.1	23.84	30	PASS
Band4	5	20375	12	#0	16QAM	22.15	0.1	22.25	30	PASS
Band4	5	20375	12	#Mid	16QAM	22.17	0.1	22.27	30	PASS
Band4	5	20375	12	#Max	16QAM	22.2	0.1	22.30	30	PASS
Band4	5	20375	25	#0	16QAM	22.3	0.1	22.40	30	PASS
Band4	10	20000	1	#0	QPSK	24.51	0.1	24.61	30	PASS
Band4	10	20000	1	#Mid	QPSK	24.37	0.1	24.47	30	PASS
Band4	10	20000	1	#Max	QPSK	24.42	0.1	24.52	30	PASS
Band4	10	20000	25	#0	QPSK	24.04	0.1	24.14	30	PASS
Band4	10	20000	25	#Mid	QPSK	24.07	0.1	24.17	30	PASS
Band4	10	20000	25	#Max	QPSK	23.99	0.1	24.09	30	PASS
Band4	10	20000	50	#0	QPSK	23.98	0.1	24.08	30	PASS

Band4	10	20000	1	#0	16QAM	24.69	0.1	24.79	30	PASS
Band4	10	20000	1	#Mid	16QAM	24.6	0.1	24.70	30	PASS
Band4	10	20000	1	#Max	16QAM	24.52	0.1	24.62	30	PASS
Band4	10	20000	25	#0	16QAM	22.61	0.1	22.71	30	PASS
Band4	10	20000	25	#Mid	16QAM	22.54	0.1	22.64	30	PASS
Band4	10	20000	25	#Max	16QAM	22.54	0.1	22.64	30	PASS
Band4	10	20000	50	#0	16QAM	22.59	0.1	22.69	30	PASS
Band4	10	20175	1	#0	QPSK	24.42	0.1	24.52	30	PASS
Band4	10	20175	1	#Mid	QPSK	24.42	0.1	24.52	30	PASS
Band4	10	20175	1	#Max	QPSK	24.44	0.1	24.54	30	PASS
Band4	10	20175	25	#0	QPSK	23.91	0.1	24.01	30	PASS
Band4	10	20175	25	#Mid	QPSK	24.01	0.1	24.11	30	PASS
Band4	10	20175	25	#Max	QPSK	24.01	0.1	24.11	30	PASS
Band4	10	20175	50	#0	QPSK	24.05	0.1	24.15	30	PASS
Band4	10	20175	1	#0	16QAM	24.13	0.1	24.23	30	PASS
Band4	10	20175	1	#Mid	16QAM	24.26	0.1	24.36	30	PASS
Band4	10	20175	1	#Max	16QAM	24.17	0.1	24.27	30	PASS
Band4	10	20175	25	#0	16QAM	22.55	0.1	22.65	30	PASS
Band4	10	20175	25	#Mid	16QAM	22.62	0.1	22.72	30	PASS
Band4	10	20175	25	#Max	16QAM	22.5	0.1	22.60	30	PASS
Band4	10	20175	50	#0	16QAM	22.56	0.1	22.66	30	PASS
Band4	10	20350	1	#0	QPSK	24.24	0.1	24.34	30	PASS
Band4	10	20350	1	#Mid	QPSK	24.22	0.1	24.32	30	PASS
Band4	10	20350	1	#Max	QPSK	24.3	0.1	24.40	30	PASS
Band4	10	20350	25	#0	QPSK	23.77	0.1	23.87	30	PASS
Band4	10	20350	25	#Mid	QPSK	23.75	0.1	23.85	30	PASS
Band4	10	20350	25	#Max	QPSK	23.62	0.1	23.72	30	PASS
Band4	10	20350	50	#0	QPSK	23.78	0.1	23.88	30	PASS
Band4	10	20350	1	#0	16QAM	23.32	0.1	23.42	30	PASS
Band4	10	20350	1	#Mid	16QAM	23.37	0.1	23.47	30	PASS
Band4	10	20350	1	#Max	16QAM	23.36	0.1	23.46	30	PASS
Band4	10	20350	25	#0	16QAM	22.32	0.1	22.42	30	PASS
Band4	10	20350	25	#Mid	16QAM	22.29	0.1	22.39	30	PASS
Band4	10	20350	25	#Max	16QAM	22.22	0.1	22.32	30	PASS
Band4	10	20350	50	#0	16QAM	22.3	0.1	22.40	30	PASS
Band4	15	20025	1	#0	QPSK	24.42	0.1	24.52	30	PASS
Band4	15	20025	1	#Mid	QPSK	24.39	0.1	24.49	30	PASS
Band4	15	20025	1	#Max	QPSK	24.36	0.1	24.46	30	PASS
Band4	15	20025	36	#0	QPSK	24.09	0.1	24.19	30	PASS
Band4	15	20025	36	#Mid	QPSK	23.97	0.1	24.07	30	PASS
Band4	15	20025	36	#Max	QPSK	23.88	0.1	23.98	30	PASS
Band4	15	20025	75	#0	QPSK	24.03	0.1	24.13	30	PASS
Band4	15	20025	1	#0	16QAM	24.68	0.1	24.78	30	PASS
Band4	15	20025	1	#Mid	16QAM	24.53	0.1	24.63	30	PASS
Band4	15	20025	1	#Max	16QAM	24.5	0.1	24.60	30	PASS
Band4	15	20025	36	#0	16QAM	22.54	0.1	22.64	30	PASS
Band4	15	20025	36	#Mid	16QAM	22.65	0.1	22.75	30	PASS
Band4	15	20025	36	#Max	16QAM	22.5	0.1	22.60	30	PASS
Band4	15	20025	75	#0	16QAM	22.49	0.1	22.59	30	PASS
Band4	15	20175	1	#0	QPSK	24.33	0.1	24.43	30	PASS
Band4	15	20175	1	#Mid	QPSK	24.37	0.1	24.47	30	PASS
Band4	15	20175	1	#Max	QPSK	24.3	0.1	24.40	30	PASS
Band4	15	20175	36	#0	QPSK	23.94	0.1	24.04	30	PASS
Band4	15	20175	36	#Mid	QPSK	24.02	0.1	24.12	30	PASS
Band4	15	20175	36	#Max	QPSK	24.03	0.1	24.13	30	PASS
Band4	15	20175	75	#0	QPSK	23.87	0.1	23.97	30	PASS
Band4	15	20175	1	#0	16QAM	24.13	0.1	24.23	30	PASS
Band4	15	20175	1	#Mid	16QAM	24.2	0.1	24.30	30	PASS
Band4	15	20175	1	#Max	16QAM	24.1	0.1	24.20	30	PASS
Band4	15	20175	36	#0	16QAM	22.51	0.1	22.61	30	PASS
Band4	15	20175	36	#Mid	16QAM	22.6	0.1	22.70	30	PASS
Band4	15	20175	36	#Max	16QAM	22.6	0.1	22.70	30	PASS
Band4	15	20175	75	#0	16QAM	22.51	0.1	22.61	30	PASS
Band4	15	20325	1	#0	QPSK	24.23	0.1	24.33	30	PASS
Band4	15	20325	1	#Mid	QPSK	24.17	0.1	24.27	30	PASS
Band4	15	20325	1	#Max	QPSK	24.19	0.1	24.29	30	PASS
Band4	15	20325	36	#0	QPSK	23.73	0.1	23.83	30	PASS
Band4	15	20325	36	#Mid	QPSK	23.82	0.1	23.92	30	PASS

Band4	15	20325	36	#Max	QPSK	23.67	0.1	23.77	30	PASS
Band4	15	20325	75	#0	QPSK	23.67	0.1	23.77	30	PASS
Band4	15	20325	1	#0	16QAM	24.24	0.1	24.34	30	PASS
Band4	15	20325	1	#Mid	16QAM	24.17	0.1	24.27	30	PASS
Band4	15	20325	1	#Max	16QAM	24.2	0.1	24.30	30	PASS
Band4	15	20325	36	#0	16QAM	22.2	0.1	22.30	30	PASS
Band4	15	20325	36	#Mid	16QAM	22.17	0.1	22.27	30	PASS
Band4	15	20325	36	#Max	16QAM	22.16	0.1	22.26	30	PASS
Band4	15	20325	75	#0	16QAM	22.38	0.1	22.48	30	PASS
Band4	20	20050	1	#0	QPSK	25.16	0.1	25.26	30	PASS
Band4	20	20050	1	#Mid	QPSK	25.01	0.1	25.11	30	PASS
Band4	20	20050	1	#Max	QPSK	25.01	0.1	25.11	30	PASS
Band4	20	20050	50	#0	QPSK	24.5	0.1	24.60	30	PASS
Band4	20	20050	50	#Mid	QPSK	24.55	0.1	24.65	30	PASS
Band4	20	20050	50	#Max	QPSK	24.52	0.1	24.62	30	PASS
Band4	20	20050	100	#0	QPSK	24.55	0.1	24.65	30	PASS
Band4	20	20050	1	#0	16QAM	24.22	0.1	24.32	30	PASS
Band4	20	20050	1	#Mid	16QAM	24.01	0.1	24.11	30	PASS
Band4	20	20050	1	#Max	16QAM	24.1	0.1	24.20	30	PASS
Band4	20	20050	50	#0	16QAM	23.11	0.1	23.21	30	PASS
Band4	20	20050	50	#Mid	16QAM	23.02	0.1	23.12	30	PASS
Band4	20	20050	50	#Max	16QAM	23.06	0.1	23.16	30	PASS
Band4	20	20050	100	#0	16QAM	23.06	0.1	23.16	30	PASS
Band4	20	20175	1	#0	QPSK	25.18	0.1	25.28	30	PASS
Band4	20	20175	1	#Mid	QPSK	25.18	0.1	25.28	30	PASS
Band4	20	20175	1	#Max	QPSK	25.09	0.1	25.19	30	PASS
Band4	20	20175	50	#0	QPSK	24.5	0.1	24.60	30	PASS
Band4	20	20175	50	#Mid	QPSK	24.41	0.1	24.51	30	PASS
Band4	20	20175	50	#Max	QPSK	24.5	0.1	24.60	30	PASS
Band4	20	20175	100	#0	QPSK	24.44	0.1	24.54	30	PASS
Band4	20	20175	1	#0	16QAM	23.98	0.1	24.08	30	PASS
Band4	20	20175	1	#Mid	16QAM	24.09	0.1	24.19	30	PASS
Band4	20	20175	1	#Max	16QAM	23.97	0.1	24.07	30	PASS
Band4	20	20175	50	#0	16QAM	23.06	0.1	23.16	30	PASS
Band4	20	20175	50	#Mid	16QAM	23.04	0.1	23.14	30	PASS
Band4	20	20175	50	#Max	16QAM	22.93	0.1	23.03	30	PASS
Band4	20	20175	100	#0	16QAM	23.04	0.1	23.14	30	PASS
Band4	20	20300	1	#0	QPSK	24.99	0.1	25.09	30	PASS
Band4	20	20300	1	#Mid	QPSK	24.81	0.1	24.91	30	PASS
Band4	20	20300	1	#Max	QPSK	24.79	0.1	24.89	30	PASS
Band4	20	20300	50	#0	QPSK	24.4	0.1	24.50	30	PASS
Band4	20	20300	50	#Mid	QPSK	24.32	0.1	24.42	30	PASS
Band4	20	20300	50	#Max	QPSK	24.3	0.1	24.40	30	PASS
Band4	20	20300	100	#0	QPSK	24.24	0.1	24.34	30	PASS
Band4	20	20300	1	#0	16QAM	24.43	0.1	24.53	30	PASS
Band4	20	20300	1	#Mid	16QAM	24.24	0.1	24.34	30	PASS
Band4	20	20300	1	#Max	16QAM	24.29	0.1	24.39	30	PASS
Band4	20	20300	50	#0	16QAM	23.03	0.1	23.13	30	PASS
Band4	20	20300	50	#Mid	16QAM	22.86	0.1	22.96	30	PASS
Band4	20	20300	50	#Max	16QAM	22.94	0.1	23.04	30	PASS
Band4	20	20300	100	#0	16QAM	22.82	0.1	22.92	30	PASS

Band	Bandwidth (MHz)	UL Channel	RB Size	RB Position	Modulation	Power (dBm)	Gain (dB)	ERP (dBm)	ERP Limit (dBm)	Verdict
Band5	1.4	20407	1	#0	QPSK	23.45	-2.8	18.50	38.45	PASS
Band5	1.4	20407	1	#Mid	QPSK	23.51	-2.8	18.56	38.45	PASS
Band5	1.4	20407	1	#Max	QPSK	23.46	-2.8	18.51	38.45	PASS
Band5	1.4	20407	3	#0	QPSK	23.19	-2.8	18.24	38.45	PASS
Band5	1.4	20407	3	#Mid	QPSK	23.25	-2.8	18.30	38.45	PASS
Band5	1.4	20407	3	#Max	QPSK	23.39	-2.8	18.44	38.45	PASS
Band5	1.4	20407	6	#0	QPSK	22.93	-2.8	17.98	38.45	PASS
Band5	1.4	20407	1	#0	16QAM	23.51	-2.8	18.56	38.45	PASS
Band5	1.4	20407	1	#Mid	16QAM	23.50	-2.8	18.55	38.45	PASS
Band5	1.4	20407	1	#Max	16QAM	23.39	-2.8	18.44	38.45	PASS
Band5	1.4	20407	3	#0	16QAM	22.66	-2.8	17.71	38.45	PASS
Band5	1.4	20407	3	#Mid	16QAM	22.65	-2.8	17.70	38.45	PASS
Band5	1.4	20407	3	#Max	16QAM	22.74	-2.8	17.79	38.45	PASS
Band5	1.4	20407	6	#0	16QAM	21.64	-2.8	16.69	38.45	PASS
Band5	1.4	20525	1	#0	QPSK	23.70	-2.8	18.75	38.45	PASS
Band5	1.4	20525	1	#Mid	QPSK	23.74	-2.8	18.79	38.45	PASS
Band5	1.4	20525	1	#Max	QPSK	23.79	-2.8	18.84	38.45	PASS
Band5	1.4	20525	3	#0	QPSK	23.79	-2.8	18.84	38.45	PASS
Band5	1.4	20525	3	#Mid	QPSK	23.69	-2.8	18.74	38.45	PASS
Band5	1.4	20525	3	#Max	QPSK	23.81	-2.8	18.86	38.45	PASS
Band5	1.4	20525	6	#0	QPSK	23.33	-2.8	18.38	38.45	PASS
Band5	1.4	20525	1	#0	16QAM	23.42	-2.8	18.47	38.45	PASS
Band5	1.4	20525	1	#Mid	16QAM	23.80	-2.8	18.85	38.45	PASS
Band5	1.4	20525	1	#Max	16QAM	23.81	-2.8	18.86	38.45	PASS
Band5	1.4	20525	3	#0	16QAM	23.10	-2.8	18.15	38.45	PASS
Band5	1.4	20525	3	#Mid	16QAM	23.05	-2.8	18.10	38.45	PASS
Band5	1.4	20525	3	#Max	16QAM	23.09	-2.8	18.14	38.45	PASS
Band5	1.4	20525	6	#0	16QAM	21.98	-2.8	17.03	38.45	PASS
Band5	1.4	20643	1	#0	QPSK	24.06	-2.8	19.11	38.45	PASS
Band5	1.4	20643	1	#Mid	QPSK	24.13	-2.8	19.18	38.45	PASS
Band5	1.4	20643	1	#Max	QPSK	24.08	-2.8	19.13	38.45	PASS
Band5	1.4	20643	3	#0	QPSK	24.10	-2.8	19.15	38.45	PASS
Band5	1.4	20643	3	#Mid	QPSK	24.06	-2.8	19.11	38.45	PASS
Band5	1.4	20643	3	#Max	QPSK	24.13	-2.8	19.18	38.45	PASS
Band5	1.4	20643	6	#0	QPSK	23.60	-2.8	18.65	38.45	PASS
Band5	1.4	20643	1	#0	16QAM	24.07	-2.8	19.12	38.45	PASS
Band5	1.4	20643	1	#Mid	16QAM	24.07	-2.8	19.12	38.45	PASS
Band5	1.4	20643	1	#Max	16QAM	24.04	-2.8	19.09	38.45	PASS
Band5	1.4	20643	3	#0	16QAM	23.44	-2.8	18.49	38.45	PASS
Band5	1.4	20643	3	#Mid	16QAM	23.36	-2.8	18.41	38.45	PASS
Band5	1.4	20643	3	#Max	16QAM	23.36	-2.8	18.41	38.45	PASS
Band5	1.4	20643	6	#0	16QAM	22.54	-2.8	17.59	38.45	PASS
Band5	3	20415	1	#0	QPSK	23.15	-2.8	18.20	38.45	PASS
Band5	3	20415	1	#Mid	QPSK	23.32	-2.8	18.37	38.45	PASS
Band5	3	20415	1	#Max	QPSK	23.33	-2.8	18.38	38.45	PASS
Band5	3	20415	8	#0	QPSK	22.90	-2.8	17.95	38.45	PASS
Band5	3	20415	8	#Mid	QPSK	22.94	-2.8	17.99	38.45	PASS
Band5	3	20415	8	#Max	QPSK	22.91	-2.8	17.96	38.45	PASS
Band5	3	20415	15	#0	QPSK	22.90	-2.8	17.95	38.45	PASS
Band5	3	20415	1	#0	16QAM	23.29	-2.8	18.34	38.45	PASS
Band5	3	20415	1	#Mid	16QAM	23.27	-2.8	18.32	38.45	PASS
Band5	3	20415	1	#Max	16QAM	23.25	-2.8	18.30	38.45	PASS
Band5	3	20415	8	#0	16QAM	21.35	-2.8	16.40	38.45	PASS
Band5	3	20415	8	#Mid	16QAM	21.33	-2.8	16.38	38.45	PASS
Band5	3	20415	8	#Max	16QAM	21.37	-2.8	16.42	38.45	PASS
Band5	3	20415	15	#0	16QAM	21.43	-2.8	16.48	38.45	PASS
Band5	3	20525	1	#0	QPSK	23.67	-2.8	18.72	38.45	PASS
Band5	3	20525	1	#Mid	QPSK	23.75	-2.8	18.80	38.45	PASS
Band5	3	20525	1	#Max	QPSK	23.74	-2.8	18.79	38.45	PASS
Band5	3	20525	8	#0	QPSK	23.11	-2.8	18.16	38.45	PASS
Band5	3	20525	8	#Mid	QPSK	23.15	-2.8	18.20	38.45	PASS
Band5	3	20525	8	#Max	QPSK	23.26	-2.8	18.31	38.45	PASS
Band5	3	20525	15	#0	QPSK	23.28	-2.8	18.33	38.45	PASS
Band5	3	20525	1	#0	16QAM	23.30	-2.8	18.35	38.45	PASS
Band5	3	20525	1	#Mid	16QAM	23.70	-2.8	18.75	38.45	PASS

Band5	3	20525	1	#Max	16QAM	23.77	-2.8	18.82	38.45	PASS
Band5	3	20525	8	#0	16QAM	22.25	-2.8	17.30	38.45	PASS
Band5	3	20525	8	#Mid	16QAM	22.28	-2.8	17.33	38.45	PASS
Band5	3	20525	8	#Max	16QAM	22.29	-2.8	17.34	38.45	PASS
Band5	3	20525	15	#0	16QAM	22.10	-2.8	17.15	38.45	PASS
Band5	3	20635	1	#0	QPSK	24.09	-2.8	19.14	38.45	PASS
Band5	3	20635	1	#Mid	QPSK	24.08	-2.8	19.13	38.45	PASS
Band5	3	20635	1	#Max	QPSK	24.17	-2.8	19.22	38.45	PASS
Band5	3	20635	8	#0	QPSK	23.62	-2.8	18.67	38.45	PASS
Band5	3	20635	8	#Mid	QPSK	23.59	-2.8	18.64	38.45	PASS
Band5	3	20635	8	#Max	QPSK	23.59	-2.8	18.64	38.45	PASS
Band5	3	20635	15	#0	QPSK	23.67	-2.8	18.72	38.45	PASS
Band5	3	20635	1	#0	16QAM	23.94	-2.8	18.99	38.45	PASS
Band5	3	20635	1	#Mid	16QAM	23.95	-2.8	19.00	38.45	PASS
Band5	3	20635	1	#Max	16QAM	23.97	-2.8	19.02	38.45	PASS
Band5	3	20635	8	#0	16QAM	22.45	-2.8	17.50	38.45	PASS
Band5	3	20635	8	#Mid	16QAM	22.50	-2.8	17.55	38.45	PASS
Band5	3	20635	8	#Max	16QAM	22.46	-2.8	17.51	38.45	PASS
Band5	3	20635	15	#0	16QAM	22.50	-2.8	17.55	38.45	PASS
Band5	5	20425	1	#0	QPSK	23.17	-2.8	18.22	38.45	PASS
Band5	5	20425	1	#Mid	QPSK	23.23	-2.8	18.28	38.45	PASS
Band5	5	20425	1	#Max	QPSK	23.29	-2.8	18.34	38.45	PASS
Band5	5	20425	12	#0	QPSK	22.86	-2.8	17.91	38.45	PASS
Band5	5	20425	12	#Mid	QPSK	22.77	-2.8	17.82	38.45	PASS
Band5	5	20425	12	#Max	QPSK	22.83	-2.8	17.88	38.45	PASS
Band5	5	20425	25	#0	QPSK	22.94	-2.8	17.99	38.45	PASS
Band5	5	20425	1	#0	16QAM	22.47	-2.8	17.52	38.45	PASS
Band5	5	20425	1	#Mid	16QAM	22.44	-2.8	17.49	38.45	PASS
Band5	5	20425	1	#Max	16QAM	22.44	-2.8	17.49	38.45	PASS
Band5	5	20425	12	#0	16QAM	21.35	-2.8	16.40	38.45	PASS
Band5	5	20425	12	#Mid	16QAM	21.38	-2.8	16.43	38.45	PASS
Band5	5	20425	12	#Max	16QAM	21.35	-2.8	16.40	38.45	PASS
Band5	5	20425	25	#0	16QAM	21.46	-2.8	16.51	38.45	PASS
Band5	5	20525	1	#0	QPSK	23.55	-2.8	18.60	38.45	PASS
Band5	5	20525	1	#Mid	QPSK	23.61	-2.8	18.66	38.45	PASS
Band5	5	20525	1	#Max	QPSK	23.91	-2.8	18.96	38.45	PASS
Band5	5	20525	12	#0	QPSK	23.13	-2.8	18.18	38.45	PASS
Band5	5	20525	12	#Mid	QPSK	23.24	-2.8	18.29	38.45	PASS
Band5	5	20525	12	#Max	QPSK	23.25	-2.8	18.30	38.45	PASS
Band5	5	20525	25	#0	QPSK	23.15	-2.8	18.20	38.45	PASS
Band5	5	20525	1	#0	16QAM	22.17	-2.8	17.22	38.45	PASS
Band5	5	20525	1	#Mid	16QAM	22.70	-2.8	17.75	38.45	PASS
Band5	5	20525	1	#Max	16QAM	22.87	-2.8	17.92	38.45	PASS
Band5	5	20525	12	#0	16QAM	21.88	-2.8	16.93	38.45	PASS
Band5	5	20525	12	#Mid	16QAM	21.97	-2.8	17.02	38.45	PASS
Band5	5	20525	12	#Max	16QAM	22.05	-2.8	17.10	38.45	PASS
Band5	5	20525	25	#0	16QAM	22.15	-2.8	17.20	38.45	PASS
Band5	5	20625	1	#0	QPSK	23.98	-2.8	19.03	38.45	PASS
Band5	5	20625	1	#Mid	QPSK	23.96	-2.8	19.01	38.45	PASS
Band5	5	20625	1	#Max	QPSK	24.00	-2.8	19.05	38.45	PASS
Band5	5	20625	12	#0	QPSK	23.64	-2.8	18.69	38.45	PASS
Band5	5	20625	12	#Mid	QPSK	23.55	-2.8	18.60	38.45	PASS
Band5	5	20625	12	#Max	QPSK	23.49	-2.8	18.54	38.45	PASS
Band5	5	20625	25	#0	QPSK	23.63	-2.8	18.68	38.45	PASS
Band5	5	20625	1	#0	16QAM	23.07	-2.8	18.12	38.45	PASS
Band5	5	20625	1	#Mid	16QAM	22.96	-2.8	18.01	38.45	PASS
Band5	5	20625	1	#Max	16QAM	23.00	-2.8	18.05	38.45	PASS
Band5	5	20625	12	#0	16QAM	22.06	-2.8	17.11	38.45	PASS
Band5	5	20625	12	#Mid	16QAM	22.40	-2.8	17.45	38.45	PASS
Band5	5	20625	12	#Max	16QAM	22.43	-2.8	17.48	38.45	PASS
Band5	5	20625	25	#0	16QAM	22.39	-2.8	17.44	38.45	PASS
Band5	10	20450	1	#0	QPSK	23.80	-2.8	18.85	38.45	PASS
Band5	10	20450	1	#Mid	QPSK	23.90	-2.8	18.95	38.45	PASS
Band5	10	20450	1	#Max	QPSK	24.09	-2.8	19.14	38.45	PASS
Band5	10	20450	25	#0	QPSK	23.30	-2.8	18.35	38.45	PASS
Band5	10	20450	25	#Mid	QPSK	23.50	-2.8	18.55	38.45	PASS
Band5	10	20450	25	#Max	QPSK	23.52	-2.8	18.57	38.45	PASS
Band5	10	20450	50	#0	QPSK	23.51	-2.8	18.56	38.45	PASS

Band5	10	20450	1	#0	16QAM	23.96	-2.8	19.01	38.45	PASS
Band5	10	20450	1	#Mid	16QAM	23.87	-2.8	18.92	38.45	PASS
Band5	10	20450	1	#Max	16QAM	24.02	-2.8	19.07	38.45	PASS
Band5	10	20450	25	#0	16QAM	21.87	-2.8	16.92	38.45	PASS
Band5	10	20450	25	#Mid	16QAM	22.19	-2.8	17.24	38.45	PASS
Band5	10	20450	25	#Max	16QAM	22.28	-2.8	17.33	38.45	PASS
Band5	10	20450	50	#0	16QAM	22.26	-2.8	17.31	38.45	PASS
Band5	10	20525	1	#0	QPSK	24.17	-2.8	19.22	38.45	PASS
Band5	10	20525	1	#Mid	QPSK	24.33	-2.8	19.38	38.45	PASS
Band5	10	20525	1	#Max	QPSK	24.57	-2.8	19.62	38.45	PASS
Band5	10	20525	25	#0	QPSK	23.51	-2.8	18.56	38.45	PASS
Band5	10	20525	25	#Mid	QPSK	23.66	-2.8	18.71	38.45	PASS
Band5	10	20525	25	#Max	QPSK	23.85	-2.8	18.90	38.45	PASS
Band5	10	20525	50	#0	QPSK	23.65	-2.8	18.70	38.45	PASS
Band5	10	20525	1	#0	16QAM	23.76	-2.8	18.81	38.45	PASS
Band5	10	20525	1	#Mid	16QAM	24.25	-2.8	19.30	38.45	PASS
Band5	10	20525	1	#Max	16QAM	24.19	-2.8	19.24	38.45	PASS
Band5	10	20525	25	#0	16QAM	22.49	-2.8	17.54	38.45	PASS
Band5	10	20525	25	#Mid	16QAM	22.62	-2.8	17.67	38.45	PASS
Band5	10	20525	25	#Max	16QAM	22.86	-2.8	17.91	38.45	PASS
Band5	10	20525	50	#0	16QAM	22.69	-2.8	17.74	38.45	PASS
Band5	10	20600	1	#0	QPSK	24.39	-2.8	19.44	38.45	PASS
Band5	10	20600	1	#Mid	QPSK	24.58	-2.8	19.63	38.45	PASS
Band5	10	20600	1	#Max	QPSK	24.57	-2.8	19.62	38.45	PASS
Band5	10	20600	25	#0	QPSK	24.00	-2.8	19.05	38.45	PASS
Band5	10	20600	25	#Mid	QPSK	23.97	-2.8	19.02	38.45	PASS
Band5	10	20600	25	#Max	QPSK	24.00	-2.8	19.05	38.45	PASS
Band5	10	20600	50	#0	QPSK	24.01	-2.8	19.06	38.45	PASS
Band5	10	20600	1	#0	16QAM	23.97	-2.8	19.02	38.45	PASS
Band5	10	20600	1	#Mid	16QAM	23.68	-2.8	18.73	38.45	PASS
Band5	10	20600	1	#Max	16QAM	23.87	-2.8	18.92	38.45	PASS
Band5	10	20600	25	#0	16QAM	22.50	-2.8	17.55	38.45	PASS
Band5	10	20600	25	#Mid	16QAM	22.88	-2.8	17.93	38.45	PASS
Band5	10	20600	25	#Max	16QAM	23.05	-2.8	18.10	38.45	PASS
Band5	10	20600	50	#0	16QAM	22.82	-2.8	17.87	38.45	PASS

Band	Bandwidth (MHz)	UL Channel	RB Size	RB Position	Modulation	Power (dBm)	Gain (dB)	EIRP (dBm)	EIRP Limit (dBm)	Verdict
Band7	5	20775	1	#0	QPSK	23.47	-1.9	21.57	33.01	PASS
Band7	5	20775	1	#Mid	QPSK	23.46	-1.9	21.56	33.01	PASS
Band7	5	20775	1	#Max	QPSK	23.42	-1.9	21.52	33.01	PASS
Band7	5	20775	12	#0	QPSK	23.07	-1.9	21.17	33.01	PASS
Band7	5	20775	12	#Mid	QPSK	23.03	-1.9	21.13	33.01	PASS
Band7	5	20775	12	#Max	QPSK	23.05	-1.9	21.15	33.01	PASS
Band7	5	20775	25	#0	QPSK	23.07	-1.9	21.17	33.01	PASS
Band7	5	20775	1	#0	16QAM	22.68	-1.9	20.78	33.01	PASS
Band7	5	20775	1	#Mid	16QAM	22.64	-1.9	20.74	33.01	PASS
Band7	5	20775	1	#Max	16QAM	22.67	-1.9	20.77	33.01	PASS
Band7	5	20775	12	#0	16QAM	21.44	-1.9	19.54	33.01	PASS
Band7	5	20775	12	#Mid	16QAM	21.43	-1.9	19.53	33.01	PASS
Band7	5	20775	12	#Max	16QAM	21.41	-1.9	19.51	33.01	PASS
Band7	5	20775	25	#0	16QAM	21.79	-1.9	19.89	33.01	PASS
Band7	5	21100	1	#0	QPSK	23.67	-1.9	21.77	33.01	PASS
Band7	5	21100	1	#Mid	QPSK	23.75	-1.9	21.85	33.01	PASS
Band7	5	21100	1	#Max	QPSK	23.83	-1.9	21.93	33.01	PASS
Band7	5	21100	12	#0	QPSK	23.23	-1.9	21.33	33.01	PASS
Band7	5	21100	12	#Mid	QPSK	23.28	-1.9	21.38	33.01	PASS
Band7	5	21100	12	#Max	QPSK	23.43	-1.9	21.53	33.01	PASS
Band7	5	21100	25	#0	QPSK	23.43	-1.9	21.53	33.01	PASS
Band7	5	21100	1	#0	16QAM	22.45	-1.9	20.55	33.01	PASS
Band7	5	21100	1	#Mid	16QAM	22.51	-1.9	20.61	33.01	PASS
Band7	5	21100	1	#Max	16QAM	22.56	-1.9	20.66	33.01	PASS
Band7	5	21100	12	#0	16QAM	21.65	-1.9	19.75	33.01	PASS
Band7	5	21100	12	#Mid	16QAM	21.73	-1.9	19.83	33.01	PASS
Band7	5	21100	12	#Max	16QAM	21.80	-1.9	19.90	33.01	PASS
Band7	5	21100	25	#0	16QAM	21.93	-1.9	20.03	33.01	PASS
Band7	5	21425	1	#0	QPSK	24.34	-1.9	22.44	33.01	PASS
Band7	5	21425	1	#Mid	QPSK	24.24	-1.9	22.34	33.01	PASS
Band7	5	21425	1	#Max	QPSK	24.29	-1.9	22.39	33.01	PASS
Band7	5	21425	12	#0	QPSK	23.89	-1.9	21.99	33.01	PASS
Band7	5	21425	12	#Mid	QPSK	24.00	-1.9	22.10	33.01	PASS
Band7	5	21425	12	#Max	QPSK	23.99	-1.9	22.09	33.01	PASS
Band7	5	21425	25	#0	QPSK	24.03	-1.9	22.13	33.01	PASS
Band7	5	21425	1	#0	16QAM	24.01	-1.9	22.11	33.01	PASS
Band7	5	21425	1	#Mid	16QAM	23.93	-1.9	22.03	33.01	PASS
Band7	5	21425	1	#Max	16QAM	24.08	-1.9	22.18	33.01	PASS
Band7	5	21425	12	#0	16QAM	22.49	-1.9	20.59	33.01	PASS
Band7	5	21425	12	#Mid	16QAM	22.50	-1.9	20.60	33.01	PASS
Band7	5	21425	12	#Max	16QAM	22.54	-1.9	20.64	33.01	PASS
Band7	5	21425	25	#0	16QAM	22.66	-1.9	20.76	33.01	PASS
Band7	10	20800	1	#0	QPSK	23.47	-1.9	21.57	33.01	PASS
Band7	10	20800	1	#Mid	QPSK	23.55	-1.9	21.65	33.01	PASS
Band7	10	20800	1	#Max	QPSK	23.51	-1.9	21.61	33.01	PASS
Band7	10	20800	25	#0	QPSK	23.07	-1.9	21.17	33.01	PASS
Band7	10	20800	25	#Mid	QPSK	22.95	-1.9	21.05	33.01	PASS
Band7	10	20800	25	#Max	QPSK	23.03	-1.9	21.13	33.01	PASS
Band7	10	20800	50	#0	QPSK	23.01	-1.9	21.11	33.01	PASS
Band7	10	20800	1	#0	16QAM	23.67	-1.9	21.77	33.01	PASS
Band7	10	20800	1	#Mid	16QAM	23.65	-1.9	21.75	33.01	PASS
Band7	10	20800	1	#Max	16QAM	23.62	-1.9	21.72	33.01	PASS
Band7	10	20800	25	#0	16QAM	21.40	-1.9	19.50	33.01	PASS
Band7	10	20800	25	#Mid	16QAM	21.47	-1.9	19.57	33.01	PASS
Band7	10	20800	25	#Max	16QAM	21.59	-1.9	19.69	33.01	PASS
Band7	10	20800	50	#0	16QAM	21.56	-1.9	19.66	33.01	PASS
Band7	10	21100	1	#0	QPSK	23.76	-1.9	21.86	33.01	PASS
Band7	10	21100	1	#Mid	QPSK	23.92	-1.9	22.02	33.01	PASS
Band7	10	21100	1	#Max	QPSK	24.01	-1.9	22.11	33.01	PASS
Band7	10	21100	25	#0	QPSK	23.26	-1.9	21.36	33.01	PASS
Band7	10	21100	25	#Mid	QPSK	23.40	-1.9	21.50	33.01	PASS
Band7	10	21100	25	#Max	QPSK	23.38	-1.9	21.48	33.01	PASS
Band7	10	21100	50	#0	QPSK	23.44	-1.9	21.54	33.01	PASS
Band7	10	21100	1	#0	16QAM	22.68	-1.9	20.78	33.01	PASS
Band7	10	21100	1	#Mid	16QAM	22.93	-1.9	21.03	33.01	PASS

Band7	10	21100	1	#Max	16QAM	23.07	-1.9	21.17	33.01	PASS
Band7	10	21100	25	#0	16QAM	21.83	-1.9	19.93	33.01	PASS
Band7	10	21100	25	#Mid	16QAM	21.98	-1.9	20.08	33.01	PASS
Band7	10	21100	25	#Max	16QAM	22.01	-1.9	20.11	33.01	PASS
Band7	10	21100	50	#0	16QAM	21.97	-1.9	20.07	33.01	PASS
Band7	10	21400	1	#0	QPSK	24.43	-1.9	22.53	33.01	PASS
Band7	10	21400	1	#Mid	QPSK	24.47	-1.9	22.57	33.01	PASS
Band7	10	21400	1	#Max	QPSK	24.63	-1.9	22.73	33.01	PASS
Band7	10	21400	25	#0	QPSK	23.88	-1.9	21.98	33.01	PASS
Band7	10	21400	25	#Mid	QPSK	23.95	-1.9	22.05	33.01	PASS
Band7	10	21400	25	#Max	QPSK	23.95	-1.9	22.05	33.01	PASS
Band7	10	21400	50	#0	QPSK	23.99	-1.9	22.09	33.01	PASS
Band7	10	21400	1	#0	16QAM	23.36	-1.9	21.46	33.01	PASS
Band7	10	21400	1	#Mid	16QAM	23.42	-1.9	21.52	33.01	PASS
Band7	10	21400	1	#Max	16QAM	23.60	-1.9	21.70	33.01	PASS
Band7	10	21400	25	#0	16QAM	22.57	-1.9	20.67	33.01	PASS
Band7	10	21400	25	#Mid	16QAM	22.56	-1.9	20.66	33.01	PASS
Band7	10	21400	25	#Max	16QAM	22.65	-1.9	20.75	33.01	PASS
Band7	10	21400	50	#0	16QAM	22.58	-1.9	20.68	33.01	PASS
Band7	15	20825	1	#0	QPSK	23.50	-1.9	21.60	33.01	PASS
Band7	15	20825	1	#Mid	QPSK	23.37	-1.9	21.47	33.01	PASS
Band7	15	20825	1	#Max	QPSK	23.40	-1.9	21.50	33.01	PASS
Band7	15	20825	36	#0	QPSK	23.15	-1.9	21.25	33.01	PASS
Band7	15	20825	36	#Mid	QPSK	23.06	-1.9	21.16	33.01	PASS
Band7	15	20825	36	#Max	QPSK	22.95	-1.9	21.05	33.01	PASS
Band7	15	20825	75	#0	QPSK	23.00	-1.9	21.10	33.01	PASS
Band7	15	20825	1	#0	16QAM	23.69	-1.9	21.79	33.01	PASS
Band7	15	20825	1	#Mid	16QAM	23.55	-1.9	21.65	33.01	PASS
Band7	15	20825	1	#Max	16QAM	23.60	-1.9	21.70	33.01	PASS
Band7	15	20825	36	#0	16QAM	21.64	-1.9	19.74	33.01	PASS
Band7	15	20825	36	#Mid	16QAM	21.53	-1.9	19.63	33.01	PASS
Band7	15	20825	36	#Max	16QAM	21.55	-1.9	19.65	33.01	PASS
Band7	15	20825	75	#0	16QAM	21.54	-1.9	19.64	33.01	PASS
Band7	15	21100	1	#0	QPSK	23.77	-1.9	21.87	33.01	PASS
Band7	15	21100	1	#Mid	QPSK	23.93	-1.9	22.03	33.01	PASS
Band7	15	21100	1	#Max	QPSK	24.06	-1.9	22.16	33.01	PASS
Band7	15	21100	36	#0	QPSK	23.18	-1.9	21.28	33.01	PASS
Band7	15	21100	36	#Mid	QPSK	23.34	-1.9	21.44	33.01	PASS
Band7	15	21100	36	#Max	QPSK	23.55	-1.9	21.65	33.01	PASS
Band7	15	21100	75	#0	QPSK	23.32	-1.9	21.42	33.01	PASS
Band7	15	21100	1	#0	16QAM	23.52	-1.9	21.62	33.01	PASS
Band7	15	21100	1	#Mid	16QAM	23.58	-1.9	21.68	33.01	PASS
Band7	15	21100	1	#Max	16QAM	23.76	-1.9	21.86	33.01	PASS
Band7	15	21100	36	#0	16QAM	21.93	-1.9	20.03	33.01	PASS
Band7	15	21100	36	#Mid	16QAM	22.08	-1.9	20.18	33.01	PASS
Band7	15	21100	36	#Max	16QAM	22.17	-1.9	20.27	33.01	PASS
Band7	15	21100	75	#0	16QAM	21.87	-1.9	19.97	33.01	PASS
Band7	15	21375	1	#0	QPSK	24.30	-1.9	22.40	33.01	PASS
Band7	15	21375	1	#Mid	QPSK	24.44	-1.9	22.54	33.01	PASS
Band7	15	21375	1	#Max	QPSK	24.59	-1.9	22.69	33.01	PASS
Band7	15	21375	36	#0	QPSK	23.90	-1.9	22.00	33.01	PASS
Band7	15	21375	36	#Mid	QPSK	24.02	-1.9	22.12	33.01	PASS
Band7	15	21375	36	#Max	QPSK	24.10	-1.9	22.20	33.01	PASS
Band7	15	21375	75	#0	QPSK	23.91	-1.9	22.01	33.01	PASS
Band7	15	21375	1	#0	16QAM	24.39	-1.9	22.49	33.01	PASS
Band7	15	21375	1	#Mid	16QAM	24.55	-1.9	22.65	33.01	PASS
Band7	15	21375	1	#Max	16QAM	24.69	-1.9	22.79	33.01	PASS
Band7	15	21375	36	#0	16QAM	22.43	-1.9	20.53	33.01	PASS
Band7	15	21375	36	#Mid	16QAM	22.40	-1.9	20.50	33.01	PASS
Band7	15	21375	36	#Max	16QAM	22.50	-1.9	20.60	33.01	PASS
Band7	15	21375	75	#0	16QAM	22.55	-1.9	20.65	33.01	PASS
Band7	20	20850	1	#0	QPSK	23.49	-1.9	21.59	33.01	PASS
Band7	20	20850	1	#Mid	QPSK	23.34	-1.9	21.44	33.01	PASS
Band7	20	20850	1	#Max	QPSK	23.40	-1.9	21.50	33.01	PASS
Band7	20	20850	50	#0	QPSK	23.08	-1.9	21.18	33.01	PASS
Band7	20	20850	50	#Mid	QPSK	22.98	-1.9	21.08	33.01	PASS
Band7	20	20850	50	#Max	QPSK	23.02	-1.9	21.12	33.01	PASS
Band7	20	20850	100	#0	QPSK	23.01	-1.9	21.11	33.01	PASS

Band7	20	20850	1	#0	16QAM	22.81	-1.9	20.91	33.01	PASS
Band7	20	20850	1	#Mid	16QAM	22.70	-1.9	20.80	33.01	PASS
Band7	20	20850	1	#Max	16QAM	22.74	-1.9	20.84	33.01	PASS
Band7	20	20850	50	#0	16QAM	21.63	-1.9	19.73	33.01	PASS
Band7	20	20850	50	#Mid	16QAM	21.64	-1.9	19.74	33.01	PASS
Band7	20	20850	50	#Max	16QAM	21.62	-1.9	19.72	33.01	PASS
Band7	20	20850	100	#0	16QAM	21.57	-1.9	19.67	33.01	PASS
Band7	20	21100	1	#0	QPSK	24.03	-1.9	22.13	33.01	PASS
Band7	20	21100	1	#Mid	QPSK	24.36	-1.9	22.46	33.01	PASS
Band7	20	21100	1	#Max	QPSK	24.55	-1.9	22.65	33.01	PASS
Band7	20	21100	50	#0	QPSK	23.23	-1.9	21.33	33.01	PASS
Band7	20	21100	50	#Mid	QPSK	23.44	-1.9	21.54	33.01	PASS
Band7	20	21100	50	#Max	QPSK	23.52	-1.9	21.62	33.01	PASS
Band7	20	21100	100	#0	QPSK	23.47	-1.9	21.57	33.01	PASS
Band7	20	21100	1	#0	16QAM	22.60	-1.9	20.70	33.01	PASS
Band7	20	21100	1	#Mid	16QAM	22.90	-1.9	21.00	33.01	PASS
Band7	20	21100	1	#Max	16QAM	23.15	-1.9	21.25	33.01	PASS
Band7	20	21100	50	#0	16QAM	21.83	-1.9	19.93	33.01	PASS
Band7	20	21100	50	#Mid	16QAM	22.03	-1.9	20.13	33.01	PASS
Band7	20	21100	50	#Max	16QAM	22.13	-1.9	20.23	33.01	PASS
Band7	20	21100	100	#0	16QAM	21.98	-1.9	20.08	33.01	PASS
Band7	20	21350	1	#0	QPSK	24.41	-1.9	22.51	33.01	PASS
Band7	20	21350	1	#Mid	QPSK	24.55	-1.9	22.65	33.01	PASS
Band7	20	21350	1	#Max	QPSK	24.85	-1.9	22.95	33.01	PASS
Band7	20	21350	50	#0	QPSK	23.75	-1.9	21.85	33.01	PASS
Band7	20	21350	50	#Mid	QPSK	23.78	-1.9	21.88	33.01	PASS
Band7	20	21350	50	#Max	QPSK	23.96	-1.9	22.06	33.01	PASS
Band7	20	21350	100	#0	QPSK	23.91	-1.9	22.01	33.01	PASS
Band7	20	21350	1	#0	16QAM	23.08	-1.9	21.18	33.01	PASS
Band7	20	21350	1	#Mid	16QAM	23.29	-1.9	21.39	33.01	PASS
Band7	20	21350	1	#Max	16QAM	23.56	-1.9	21.66	33.01	PASS
Band7	20	21350	50	#0	16QAM	22.35	-1.9	20.45	33.01	PASS
Band7	20	21350	50	#Mid	16QAM	22.45	-1.9	20.55	33.01	PASS
Band7	20	21350	50	#Max	16QAM	22.63	-1.9	20.73	33.01	PASS
Band7	20	21350	100	#0	16QAM	22.53	-1.9	20.63	33.01	PASS

Band	Bandwidth (MHz)	UL Channel	RB Size	RB Position	Modulation	Power (dBm)	Gain (dB)	ERP (dBm)	ERP Limit (dBm)	Verdict
Band12	1.4	23017	1	#0	QPSK	23.88	-3.2	18.53	34.77	PASS
Band12	1.4	23017	1	#Mid	QPSK	23.72	-3.2	18.37	34.77	PASS
Band12	1.4	23017	1	#Max	QPSK	23.85	-3.2	18.50	34.77	PASS
Band12	1.4	23017	3	#0	QPSK	23.72	-3.2	18.37	34.77	PASS
Band12	1.4	23017	3	#Mid	QPSK	23.76	-3.2	18.41	34.77	PASS
Band12	1.4	23017	3	#Max	QPSK	23.77	-3.2	18.42	34.77	PASS
Band12	1.4	23017	6	#0	QPSK	23.32	-3.2	17.97	34.77	PASS
Band12	1.4	23017	1	#0	16QAM	23.63	-3.2	18.28	34.77	PASS
Band12	1.4	23017	1	#Mid	16QAM	23.62	-3.2	18.27	34.77	PASS
Band12	1.4	23017	1	#Max	16QAM	23.80	-3.2	18.45	34.77	PASS
Band12	1.4	23017	3	#0	16QAM	22.98	-3.2	17.63	34.77	PASS
Band12	1.4	23017	3	#Mid	16QAM	22.99	-3.2	17.64	34.77	PASS
Band12	1.4	23017	3	#Max	16QAM	22.89	-3.2	17.54	34.77	PASS
Band12	1.4	23017	6	#0	16QAM	21.84	-3.2	16.49	34.77	PASS
Band12	1.4	23095	1	#0	QPSK	23.29	-3.2	17.94	34.77	PASS
Band12	1.4	23095	1	#Mid	QPSK	23.70	-3.2	18.35	34.77	PASS
Band12	1.4	23095	1	#Max	QPSK	23.76	-3.2	18.41	34.77	PASS
Band12	1.4	23095	3	#0	QPSK	23.71	-3.2	18.36	34.77	PASS
Band12	1.4	23095	3	#Mid	QPSK	23.81	-3.2	18.46	34.77	PASS
Band12	1.4	23095	3	#Max	QPSK	23.80	-3.2	18.45	34.77	PASS
Band12	1.4	23095	6	#0	QPSK	23.18	-3.2	17.83	34.77	PASS
Band12	1.4	23095	1	#0	16QAM	22.90	-3.2	17.55	34.77	PASS
Band12	1.4	23095	1	#Mid	16QAM	22.82	-3.2	17.47	34.77	PASS
Band12	1.4	23095	1	#Max	16QAM	22.77	-3.2	17.42	34.77	PASS
Band12	1.4	23095	3	#0	16QAM	22.74	-3.2	17.39	34.77	PASS
Band12	1.4	23095	3	#Mid	16QAM	22.84	-3.2	17.49	34.77	PASS
Band12	1.4	23095	3	#Max	16QAM	22.83	-3.2	17.48	34.77	PASS
Band12	1.4	23095	6	#0	16QAM	22.03	-3.2	16.68	34.77	PASS
Band12	1.4	23173	1	#0	QPSK	23.95	-3.2	18.60	34.77	PASS
Band12	1.4	23173	1	#Mid	QPSK	23.69	-3.2	18.34	34.77	PASS
Band12	1.4	23173	1	#Max	QPSK	23.76	-3.2	18.41	34.77	PASS
Band12	1.4	23173	3	#0	QPSK	23.92	-3.2	18.57	34.77	PASS
Band12	1.4	23173	3	#Mid	QPSK	23.68	-3.2	18.33	34.77	PASS
Band12	1.4	23173	3	#Max	QPSK	23.77	-3.2	18.42	34.77	PASS
Band12	1.4	23173	6	#0	QPSK	23.18	-3.2	17.83	34.77	PASS
Band12	1.4	23173	1	#0	16QAM	23.66	-3.2	18.31	34.77	PASS
Band12	1.4	23173	1	#Mid	16QAM	23.15	-3.2	17.80	34.77	PASS
Band12	1.4	23173	1	#Max	16QAM	23.24	-3.2	17.89	34.77	PASS
Band12	1.4	23173	3	#0	16QAM	23.33	-3.2	17.98	34.77	PASS
Band12	1.4	23173	3	#Mid	16QAM	22.83	-3.2	17.48	34.77	PASS
Band12	1.4	23173	3	#Max	16QAM	22.85	-3.2	17.50	34.77	PASS
Band12	1.4	23173	6	#0	16QAM	22.15	-3.2	16.80	34.77	PASS
Band12	3	23025	1	#0	QPSK	23.75	-3.2	18.40	34.77	PASS
Band12	3	23025	1	#Mid	QPSK	23.72	-3.2	18.37	34.77	PASS
Band12	3	23025	1	#Max	QPSK	23.72	-3.2	18.37	34.77	PASS
Band12	3	23025	8	#0	QPSK	23.27	-3.2	17.92	34.77	PASS
Band12	3	23025	8	#Mid	QPSK	23.29	-3.2	17.94	34.77	PASS
Band12	3	23025	8	#Max	QPSK	23.39	-3.2	18.04	34.77	PASS
Band12	3	23025	15	#0	QPSK	23.22	-3.2	17.87	34.77	PASS
Band12	3	23025	1	#0	16QAM	23.53	-3.2	18.18	34.77	PASS
Band12	3	23025	1	#Mid	16QAM	23.56	-3.2	18.21	34.77	PASS
Band12	3	23025	1	#Max	16QAM	23.55	-3.2	18.20	34.77	PASS
Band12	3	23025	8	#0	16QAM	21.67	-3.2	16.32	34.77	PASS
Band12	3	23025	8	#Mid	16QAM	21.66	-3.2	16.31	34.77	PASS
Band12	3	23025	8	#Max	16QAM	21.67	-3.2	16.32	34.77	PASS
Band12	3	23025	15	#0	16QAM	21.75	-3.2	16.40	34.77	PASS
Band12	3	23095	1	#0	QPSK	23.33	-3.2	17.98	34.77	PASS
Band12	3	23095	1	#Mid	QPSK	23.74	-3.2	18.39	34.77	PASS
Band12	3	23095	1	#Max	QPSK	23.68	-3.2	18.33	34.77	PASS
Band12	3	23095	8	#0	QPSK	22.92	-3.2	17.57	34.77	PASS
Band12	3	23095	8	#Mid	QPSK	23.25	-3.2	17.90	34.77	PASS
Band12	3	23095	8	#Max	QPSK	23.27	-3.2	17.92	34.77	PASS
Band12	3	23095	15	#0	QPSK	23.33	-3.2	17.98	34.77	PASS
Band12	3	23095	1	#0	16QAM	23.40	-3.2	18.05	34.77	PASS
Band12	3	23095	1	#Mid	16QAM	23.45	-3.2	18.10	34.77	PASS

Band12	3	23095	1	#Max	16QAM	23.42	-3.2	18.07	34.77	PASS
Band12	3	23095	8	#0	16QAM	21.95	-3.2	16.60	34.77	PASS
Band12	3	23095	8	#Mid	16QAM	21.99	-3.2	16.64	34.77	PASS
Band12	3	23095	8	#Max	16QAM	22.02	-3.2	16.67	34.77	PASS
Band12	3	23095	15	#0	16QAM	21.79	-3.2	16.44	34.77	PASS
Band12	3	23165	1	#0	QPSK	23.86	-3.2	18.51	34.77	PASS
Band12	3	23165	1	#Mid	QPSK	24.00	-3.2	18.65	34.77	PASS
Band12	3	23165	1	#Max	QPSK	23.74	-3.2	18.39	34.77	PASS
Band12	3	23165	8	#0	QPSK	23.46	-3.2	18.11	34.77	PASS
Band12	3	23165	8	#Mid	QPSK	23.49	-3.2	18.14	34.77	PASS
Band12	3	23165	8	#Max	QPSK	23.05	-3.2	17.70	34.77	PASS
Band12	3	23165	15	#0	QPSK	23.50	-3.2	18.15	34.77	PASS
Band12	3	23165	1	#0	16QAM	23.78	-3.2	18.43	34.77	PASS
Band12	3	23165	1	#Mid	16QAM	23.72	-3.2	18.37	34.77	PASS
Band12	3	23165	1	#Max	16QAM	23.23	-3.2	17.88	34.77	PASS
Band12	3	23165	8	#0	16QAM	21.93	-3.2	16.58	34.77	PASS
Band12	3	23165	8	#Mid	16QAM	21.89	-3.2	16.54	34.77	PASS
Band12	3	23165	8	#Max	16QAM	21.87	-3.2	16.52	34.77	PASS
Band12	3	23165	15	#0	16QAM	21.97	-3.2	16.62	34.77	PASS
Band12	5	23035	1	#0	QPSK	23.58	-3.2	18.23	34.77	PASS
Band12	5	23035	1	#Mid	QPSK	23.66	-3.2	18.31	34.77	PASS
Band12	5	23035	1	#Max	QPSK	23.33	-3.2	17.98	34.77	PASS
Band12	5	23035	12	#0	QPSK	23.33	-3.2	17.98	34.77	PASS
Band12	5	23035	12	#Mid	QPSK	23.31	-3.2	17.96	34.77	PASS
Band12	5	23035	12	#Max	QPSK	23.26	-3.2	17.91	34.77	PASS
Band12	5	23035	25	#0	QPSK	23.26	-3.2	17.91	34.77	PASS
Band12	5	23035	1	#0	16QAM	22.93	-3.2	17.58	34.77	PASS
Band12	5	23035	1	#Mid	16QAM	22.90	-3.2	17.55	34.77	PASS
Band12	5	23035	1	#Max	16QAM	22.62	-3.2	17.27	34.77	PASS
Band12	5	23035	12	#0	16QAM	21.65	-3.2	16.30	34.77	PASS
Band12	5	23035	12	#Mid	16QAM	21.70	-3.2	16.35	34.77	PASS
Band12	5	23035	12	#Max	16QAM	21.69	-3.2	16.34	34.77	PASS
Band12	5	23035	25	#0	16QAM	21.93	-3.2	16.58	34.77	PASS
Band12	5	23095	1	#0	QPSK	23.27	-3.2	17.92	34.77	PASS
Band12	5	23095	1	#Mid	QPSK	23.65	-3.2	18.30	34.77	PASS
Band12	5	23095	1	#Max	QPSK	23.31	-3.2	17.96	34.77	PASS
Band12	5	23095	12	#0	QPSK	22.90	-3.2	17.55	34.77	PASS
Band12	5	23095	12	#Mid	QPSK	23.31	-3.2	17.96	34.77	PASS
Band12	5	23095	12	#Max	QPSK	23.30	-3.2	17.95	34.77	PASS
Band12	5	23095	25	#0	QPSK	23.19	-3.2	17.84	34.77	PASS
Band12	5	23095	1	#0	16QAM	22.44	-3.2	17.09	34.77	PASS
Band12	5	23095	1	#Mid	16QAM	22.45	-3.2	17.10	34.77	PASS
Band12	5	23095	1	#Max	16QAM	22.50	-3.2	17.15	34.77	PASS
Band12	5	23095	12	#0	16QAM	21.60	-3.2	16.25	34.77	PASS
Band12	5	23095	12	#Mid	16QAM	21.70	-3.2	16.35	34.77	PASS
Band12	5	23095	12	#Max	16QAM	21.68	-3.2	16.33	34.77	PASS
Band12	5	23095	25	#0	16QAM	21.85	-3.2	16.50	34.77	PASS
Band12	5	23155	1	#0	QPSK	23.73	-3.2	18.38	34.77	PASS
Band12	5	23155	1	#Mid	QPSK	23.80	-3.2	18.45	34.77	PASS
Band12	5	23155	1	#Max	QPSK	23.61	-3.2	18.26	34.77	PASS
Band12	5	23155	12	#0	QPSK	23.43	-3.2	18.08	34.77	PASS
Band12	5	23155	12	#Mid	QPSK	23.34	-3.2	17.99	34.77	PASS
Band12	5	23155	12	#Max	QPSK	23.36	-3.2	18.01	34.77	PASS
Band12	5	23155	25	#0	QPSK	23.49	-3.2	18.14	34.77	PASS
Band12	5	23155	1	#0	16QAM	22.76	-3.2	17.41	34.77	PASS
Band12	5	23155	1	#Mid	16QAM	22.81	-3.2	17.46	34.77	PASS
Band12	5	23155	1	#Max	16QAM	22.43	-3.2	17.08	34.77	PASS
Band12	5	23155	12	#0	16QAM	21.76	-3.2	16.41	34.77	PASS
Band12	5	23155	12	#Mid	16QAM	21.87	-3.2	16.52	34.77	PASS
Band12	5	23155	12	#Max	16QAM	21.81	-3.2	16.46	34.77	PASS
Band12	5	23155	25	#0	16QAM	21.84	-3.2	16.49	34.77	PASS
Band12	10	23060	1	#0	QPSK	23.79	-3.2	18.44	34.77	PASS
Band12	10	23060	1	#Mid	QPSK	23.43	-3.2	18.08	34.77	PASS
Band12	10	23060	1	#Max	QPSK	23.74	-3.2	18.39	34.77	PASS
Band12	10	23060	25	#0	QPSK	23.28	-3.2	17.93	34.77	PASS
Band12	10	23060	25	#Mid	QPSK	23.03	-3.2	17.68	34.77	PASS
Band12	10	23060	25	#Max	QPSK	22.93	-3.2	17.58	34.77	PASS
Band12	10	23060	50	#0	QPSK	22.96	-3.2	17.61	34.77	PASS

Band12	10	23060	1	#0	16QAM	23.76	-3.2	18.41	34.77	PASS
Band12	10	23060	1	#Mid	16QAM	23.31	-3.2	17.96	34.77	PASS
Band12	10	23060	1	#Max	16QAM	23.75	-3.2	18.40	34.77	PASS
Band12	10	23060	25	#0	16QAM	21.72	-3.2	16.37	34.77	PASS
Band12	10	23060	25	#Mid	16QAM	21.74	-3.2	16.39	34.77	PASS
Band12	10	23060	25	#Max	16QAM	21.66	-3.2	16.31	34.77	PASS
Band12	10	23060	50	#0	16QAM	21.80	-3.2	16.45	34.77	PASS
Band12	10	23095	1	#0	QPSK	23.82	-3.2	18.47	34.77	PASS
Band12	10	23095	1	#Mid	QPSK	23.84	-3.2	18.49	34.77	PASS
Band12	10	23095	1	#Max	QPSK	24.13	-3.2	18.78	34.77	PASS
Band12	10	23095	25	#0	QPSK	22.89	-3.2	17.54	34.77	PASS
Band12	10	23095	25	#Mid	QPSK	23.25	-3.2	17.90	34.77	PASS
Band12	10	23095	25	#Max	QPSK	23.42	-3.2	18.07	34.77	PASS
Band12	10	23095	50	#0	QPSK	23.26	-3.2	17.91	34.77	PASS
Band12	10	23095	1	#0	16QAM	22.72	-3.2	17.37	34.77	PASS
Band12	10	23095	1	#Mid	16QAM	22.78	-3.2	17.43	34.77	PASS
Band12	10	23095	1	#Max	16QAM	22.91	-3.2	17.56	34.77	PASS
Band12	10	23095	25	#0	16QAM	21.86	-3.2	16.51	34.77	PASS
Band12	10	23095	25	#Mid	16QAM	21.93	-3.2	16.58	34.77	PASS
Band12	10	23095	25	#Max	16QAM	21.97	-3.2	16.62	34.77	PASS
Band12	10	23095	50	#0	16QAM	21.94	-3.2	16.59	34.77	PASS
Band12	10	23130	1	#0	QPSK	23.36	-3.2	18.01	34.77	PASS
Band12	10	23130	1	#Mid	QPSK	23.47	-3.2	18.12	34.77	PASS
Band12	10	23130	1	#Max	QPSK	23.71	-3.2	18.36	34.77	PASS
Band12	10	23130	25	#0	QPSK	23.25	-3.2	17.90	34.77	PASS
Band12	10	23130	25	#Mid	QPSK	23.38	-3.2	18.03	34.77	PASS
Band12	10	23130	25	#Max	QPSK	23.45	-3.2	18.10	34.77	PASS
Band12	10	23130	50	#0	QPSK	23.39	-3.2	18.04	34.77	PASS
Band12	10	23130	1	#0	16QAM	22.61	-3.2	17.26	34.77	PASS
Band12	10	23130	1	#Mid	16QAM	22.74	-3.2	17.39	34.77	PASS
Band12	10	23130	1	#Max	16QAM	22.50	-3.2	17.15	34.77	PASS
Band12	10	23130	25	#0	16QAM	21.88	-3.2	16.53	34.77	PASS
Band12	10	23130	25	#Mid	16QAM	21.94	-3.2	16.59	34.77	PASS
Band12	10	23130	25	#Max	16QAM	21.96	-3.2	16.61	34.77	PASS
Band12	10	23130	50	#0	16QAM	21.94	-3.2	16.59	34.77	PASS

Band	Bandwidth (MHz)	UL Channel	RB Size	RB Position	Modulation	Power (dBm)	Gain (dB)	ERP (dBm)	ERP Limit (dBm)	Verdict
Band17	5	23755	1	#0	QPSK	23.39	-3.2	18.04	34.77	PASS
Band17	5	23755	1	#Mid	QPSK	23.37	-3.2	18.02	34.77	PASS
Band17	5	23755	1	#Max	QPSK	23.73	-3.2	18.38	34.77	PASS
Band17	5	23755	12	#0	QPSK	22.92	-3.2	17.57	34.77	PASS
Band17	5	23755	12	#Mid	QPSK	22.85	-3.2	17.50	34.77	PASS
Band17	5	23755	12	#Max	QPSK	23.32	-3.2	17.97	34.77	PASS
Band17	5	23755	25	#0	QPSK	22.92	-3.2	17.57	34.77	PASS
Band17	5	23755	1	#0	16QAM	22.49	-3.2	17.14	34.77	PASS
Band17	5	23755	1	#Mid	16QAM	22.86	-3.2	17.51	34.77	PASS
Band17	5	23755	1	#Max	16QAM	22.85	-3.2	17.50	34.77	PASS
Band17	5	23755	12	#0	16QAM	21.69	-3.2	16.34	34.77	PASS
Band17	5	23755	12	#Mid	16QAM	21.72	-3.2	16.37	34.77	PASS
Band17	5	23755	12	#Max	16QAM	21.67	-3.2	16.32	34.77	PASS
Band17	5	23755	25	#0	16QAM	21.92	-3.2	16.57	34.77	PASS
Band17	5	23790	1	#0	QPSK	23.62	-3.2	18.27	34.77	PASS
Band17	5	23790	1	#Mid	QPSK	23.33	-3.2	17.98	34.77	PASS
Band17	5	23790	1	#Max	QPSK	23.79	-3.2	18.44	34.77	PASS
Band17	5	23790	12	#0	QPSK	23.22	-3.2	17.87	34.77	PASS
Band17	5	23790	12	#Mid	QPSK	23.24	-3.2	17.89	34.77	PASS
Band17	5	23790	12	#Max	QPSK	23.37	-3.2	18.02	34.77	PASS
Band17	5	23790	25	#0	QPSK	23.34	-3.2	17.99	34.77	PASS
Band17	5	23790	1	#0	16QAM	22.37	-3.2	17.02	34.77	PASS
Band17	5	23790	1	#Mid	16QAM	22.46	-3.2	17.11	34.77	PASS
Band17	5	23790	1	#Max	16QAM	22.65	-3.2	17.30	34.77	PASS
Band17	5	23790	12	#0	16QAM	21.62	-3.2	16.27	34.77	PASS
Band17	5	23790	12	#Mid	16QAM	21.75	-3.2	16.40	34.77	PASS
Band17	5	23790	12	#Max	16QAM	21.74	-3.2	16.39	34.77	PASS
Band17	5	23790	25	#0	16QAM	21.95	-3.2	16.60	34.77	PASS
Band17	5	23825	1	#0	QPSK	23.75	-3.2	18.40	34.77	PASS
Band17	5	23825	1	#Mid	QPSK	23.80	-3.2	18.45	34.77	PASS
Band17	5	23825	1	#Max	QPSK	23.63	-3.2	18.28	34.77	PASS
Band17	5	23825	12	#0	QPSK	23.32	-3.2	17.97	34.77	PASS
Band17	5	23825	12	#Mid	QPSK	23.30	-3.2	17.95	34.77	PASS
Band17	5	23825	12	#Max	QPSK	23.39	-3.2	18.04	34.77	PASS
Band17	5	23825	25	#0	QPSK	23.44	-3.2	18.09	34.77	PASS
Band17	5	23825	1	#0	16QAM	22.80	-3.2	17.45	34.77	PASS
Band17	5	23825	1	#Mid	16QAM	22.77	-3.2	17.42	34.77	PASS
Band17	5	23825	1	#Max	16QAM	22.45	-3.2	17.10	34.77	PASS
Band17	5	23825	12	#0	16QAM	21.80	-3.2	16.45	34.77	PASS
Band17	5	23825	12	#Mid	16QAM	21.82	-3.2	16.47	34.77	PASS
Band17	5	23825	12	#Max	16QAM	21.93	-3.2	16.58	34.77	PASS
Band17	5	23825	25	#0	16QAM	21.85	-3.2	16.50	34.77	PASS
Band17	10	23780	1	#0	QPSK	23.36	-3.2	18.01	34.77	PASS
Band17	10	23780	1	#Mid	QPSK	23.65	-3.2	18.30	34.77	PASS
Band17	10	23780	1	#Max	QPSK	23.96	-3.2	18.61	34.77	PASS
Band17	10	23780	25	#0	QPSK	22.93	-3.2	17.58	34.77	PASS
Band17	10	23780	25	#Mid	QPSK	23.26	-3.2	17.91	34.77	PASS
Band17	10	23780	25	#Max	QPSK	23.37	-3.2	18.02	34.77	PASS
Band17	10	23780	50	#0	QPSK	23.34	-3.2	17.99	34.77	PASS
Band17	10	23780	1	#0	16QAM	23.24	-3.2	17.89	34.77	PASS
Band17	10	23780	1	#Mid	16QAM	23.72	-3.2	18.37	34.77	PASS
Band17	10	23780	1	#Max	16QAM	23.90	-3.2	18.55	34.77	PASS
Band17	10	23780	25	#0	16QAM	21.67	-3.2	16.32	34.77	PASS
Band17	10	23780	25	#Mid	16QAM	21.72	-3.2	16.37	34.77	PASS
Band17	10	23780	25	#Max	16QAM	21.75	-3.2	16.40	34.77	PASS
Band17	10	23780	50	#0	16QAM	21.78	-3.2	16.43	34.77	PASS
Band17	10	23790	1	#0	QPSK	23.47	-3.2	18.12	34.77	PASS
Band17	10	23790	1	#Mid	QPSK	23.48	-3.2	18.13	34.77	PASS
Band17	10	23790	1	#Max	QPSK	24.04	-3.2	18.69	34.77	PASS
Band17	10	23790	25	#0	QPSK	23.26	-3.2	17.91	34.77	PASS
Band17	10	23790	25	#Mid	QPSK	23.33	-3.2	17.98	34.77	PASS
Band17	10	23790	25	#Max	QPSK	23.33	-3.2	17.98	34.77	PASS
Band17	10	23790	50	#0	QPSK	23.32	-3.2	17.97	34.77	PASS
Band17	10	23790	1	#0	16QAM	22.70	-3.2	17.35	34.77	PASS
Band17	10	23790	1	#Mid	16QAM	22.88	-3.2	17.53	34.77	PASS

Band17	10	23790	1	#Max	16QAM	22.89	-3.2	17.54	34.77	PASS
Band17	10	23790	25	#0	16QAM	21.82	-3.2	16.47	34.77	PASS
Band17	10	23790	25	#Mid	16QAM	21.96	-3.2	16.61	34.77	PASS
Band17	10	23790	25	#Max	16QAM	21.93	-3.2	16.58	34.77	PASS
Band17	10	23790	50	#0	16QAM	21.97	-3.2	16.62	34.77	PASS
Band17	10	23800	1	#0	QPSK	23.38	-3.2	18.03	34.77	PASS
Band17	10	23800	1	#Mid	QPSK	23.46	-3.2	18.11	34.77	PASS
Band17	10	23800	1	#Max	QPSK	23.74	-3.2	18.39	34.77	PASS
Band17	10	23800	25	#0	QPSK	23.25	-3.2	17.90	34.77	PASS
Band17	10	23800	25	#Mid	QPSK	23.39	-3.2	18.04	34.77	PASS
Band17	10	23800	25	#Max	QPSK	23.47	-3.2	18.12	34.77	PASS
Band17	10	23800	50	#0	QPSK	23.40	-3.2	18.05	34.77	PASS
Band17	10	23800	1	#0	16QAM	22.60	-3.2	17.25	34.77	PASS
Band17	10	23800	1	#Mid	16QAM	22.77	-3.2	17.42	34.77	PASS
Band17	10	23800	1	#Max	16QAM	22.48	-3.2	17.13	34.77	PASS
Band17	10	23800	25	#0	16QAM	21.88	-3.2	16.53	34.77	PASS
Band17	10	23800	25	#Mid	16QAM	21.94	-3.2	16.59	34.77	PASS
Band17	10	23800	25	#Max	16QAM	21.97	-3.2	16.62	34.77	PASS
Band17	10	23800	50	#0	16QAM	21.95	-3.2	16.60	34.77	PASS

Band	Bandwidth (MHz)	UL Channel	RB Size	RB Position	Modulation	Power (dBm)	Gain (dB)	EIRP (dBm)	EIRP Limit (dBm)	Verdict
Band25	1.4	26047	1	#0	QPSK	24.42	0.3	24.72	33.01	PASS
Band25	1.4	26047	1	#Mid	QPSK	24.45	0.3	24.75	33.01	PASS
Band25	1.4	26047	1	#Max	QPSK	24.47	0.3	24.77	33.01	PASS
Band25	1.4	26047	3	#0	QPSK	24.27	0.3	24.57	33.01	PASS
Band25	1.4	26047	3	#Mid	QPSK	24.34	0.3	24.64	33.01	PASS
Band25	1.4	26047	3	#Max	QPSK	24.31	0.3	24.61	33.01	PASS
Band25	1.4	26047	6	#0	QPSK	23.86	0.3	24.16	33.01	PASS
Band25	1.4	26047	1	#0	16QAM	24.25	0.3	24.55	33.01	PASS
Band25	1.4	26047	1	#Mid	16QAM	24.30	0.3	24.60	33.01	PASS
Band25	1.4	26047	1	#Max	16QAM	24.32	0.3	24.62	33.01	PASS
Band25	1.4	26047	3	#0	16QAM	23.51	0.3	23.81	33.01	PASS
Band25	1.4	26047	3	#Mid	16QAM	23.47	0.3	23.77	33.01	PASS
Band25	1.4	26047	3	#Max	16QAM	23.51	0.3	23.81	33.01	PASS
Band25	1.4	26047	6	#0	16QAM	22.41	0.3	22.71	33.01	PASS
Band25	1.4	26365	1	#0	QPSK	23.61	0.3	23.91	33.01	PASS
Band25	1.4	26365	1	#Mid	QPSK	23.59	0.3	23.89	33.01	PASS
Band25	1.4	26365	1	#Max	QPSK	23.54	0.3	23.84	33.01	PASS
Band25	1.4	26365	3	#0	QPSK	23.71	0.3	24.01	33.01	PASS
Band25	1.4	26365	3	#Mid	QPSK	23.77	0.3	24.07	33.01	PASS
Band25	1.4	26365	3	#Max	QPSK	23.72	0.3	24.02	33.01	PASS
Band25	1.4	26365	6	#0	QPSK	23.21	0.3	23.51	33.01	PASS
Band25	1.4	26365	1	#0	16QAM	22.81	0.3	23.11	33.01	PASS
Band25	1.4	26365	1	#Mid	16QAM	22.68	0.3	22.98	33.01	PASS
Band25	1.4	26365	1	#Max	16QAM	22.73	0.3	23.03	33.01	PASS
Band25	1.4	26365	3	#0	16QAM	22.64	0.3	22.94	33.01	PASS
Band25	1.4	26365	3	#Mid	16QAM	22.70	0.3	23.00	33.01	PASS
Band25	1.4	26365	3	#Max	16QAM	22.66	0.3	22.96	33.01	PASS
Band25	1.4	26365	6	#0	16QAM	21.72	0.3	22.02	33.01	PASS
Band25	1.4	26683	1	#0	QPSK	23.78	0.3	24.08	33.01	PASS
Band25	1.4	26683	1	#Mid	QPSK	23.84	0.3	24.14	33.01	PASS
Band25	1.4	26683	1	#Max	QPSK	23.86	0.3	24.16	33.01	PASS
Band25	1.4	26683	3	#0	QPSK	23.81	0.3	24.11	33.01	PASS
Band25	1.4	26683	3	#Mid	QPSK	23.83	0.3	24.13	33.01	PASS
Band25	1.4	26683	3	#Max	QPSK	23.82	0.3	24.12	33.01	PASS
Band25	1.4	26683	6	#0	QPSK	23.35	0.3	23.65	33.01	PASS
Band25	1.4	26683	1	#0	16QAM	22.82	0.3	23.12	33.01	PASS
Band25	1.4	26683	1	#Mid	16QAM	22.79	0.3	23.09	33.01	PASS
Band25	1.4	26683	1	#Max	16QAM	22.84	0.3	23.14	33.01	PASS
Band25	1.4	26683	3	#0	16QAM	22.81	0.3	23.11	33.01	PASS
Band25	1.4	26683	3	#Mid	16QAM	22.68	0.3	22.98	33.01	PASS
Band25	1.4	26683	3	#Max	16QAM	22.83	0.3	23.13	33.01	PASS
Band25	1.4	26683	6	#0	16QAM	21.88	0.3	22.18	33.01	PASS
Band25	3	26055	1	#0	QPSK	24.22	0.3	24.52	33.01	PASS
Band25	3	26055	1	#Mid	QPSK	24.29	0.3	24.59	33.01	PASS
Band25	3	26055	1	#Max	QPSK	24.23	0.3	24.53	33.01	PASS
Band25	3	26055	8	#0	QPSK	23.73	0.3	24.03	33.01	PASS
Band25	3	26055	8	#Mid	QPSK	23.81	0.3	24.11	33.01	PASS
Band25	3	26055	8	#Max	QPSK	23.81	0.3	24.11	33.01	PASS
Band25	3	26055	15	#0	QPSK	23.76	0.3	24.06	33.01	PASS
Band25	3	26055	1	#0	16QAM	24.32	0.3	24.62	33.01	PASS
Band25	3	26055	1	#Mid	16QAM	24.36	0.3	24.66	33.01	PASS
Band25	3	26055	1	#Max	16QAM	24.30	0.3	24.60	33.01	PASS
Band25	3	26055	8	#0	16QAM	22.27	0.3	22.57	33.01	PASS
Band25	3	26055	8	#Mid	16QAM	22.26	0.3	22.56	33.01	PASS
Band25	3	26055	8	#Max	16QAM	22.24	0.3	22.54	33.01	PASS
Band25	3	26055	15	#0	16QAM	22.45	0.3	22.75	33.01	PASS
Band25	3	26365	1	#0	QPSK	23.59	0.3	23.89	33.01	PASS
Band25	3	26365	1	#Mid	QPSK	23.57	0.3	23.87	33.01	PASS
Band25	3	26365	1	#Max	QPSK	23.57	0.3	23.87	33.01	PASS
Band25	3	26365	8	#0	QPSK	23.22	0.3	23.52	33.01	PASS
Band25	3	26365	8	#Mid	QPSK	23.15	0.3	23.45	33.01	PASS
Band25	3	26365	8	#Max	QPSK	23.26	0.3	23.56	33.01	PASS
Band25	3	26365	15	#0	QPSK	23.24	0.3	23.54	33.01	PASS
Band25	3	26365	1	#0	16QAM	22.79	0.3	23.09	33.01	PASS
Band25	3	26365	1	#Mid	16QAM	22.64	0.3	22.94	33.01	PASS

Band25	3	26365	1	#Max	16QAM	22.76	0.3	23.06	33.01	PASS
Band25	3	26365	8	#0	16QAM	21.88	0.3	22.18	33.01	PASS
Band25	3	26365	8	#Mid	16QAM	21.79	0.3	22.09	33.01	PASS
Band25	3	26365	8	#Max	16QAM	21.74	0.3	22.04	33.01	PASS
Band25	3	26365	15	#0	16QAM	21.70	0.3	22.00	33.01	PASS
Band25	3	26675	1	#0	QPSK	23.77	0.3	24.07	33.01	PASS
Band25	3	26675	1	#Mid	QPSK	23.81	0.3	24.11	33.01	PASS
Band25	3	26675	1	#Max	QPSK	23.84	0.3	24.14	33.01	PASS
Band25	3	26675	8	#0	QPSK	23.27	0.3	23.57	33.01	PASS
Band25	3	26675	8	#Mid	QPSK	23.30	0.3	23.60	33.01	PASS
Band25	3	26675	8	#Max	QPSK	23.30	0.3	23.60	33.01	PASS
Band25	3	26675	15	#0	QPSK	23.39	0.3	23.69	33.01	PASS
Band25	3	26675	1	#0	16QAM	23.18	0.3	23.48	33.01	PASS
Band25	3	26675	1	#Mid	16QAM	23.06	0.3	23.36	33.01	PASS
Band25	3	26675	1	#Max	16QAM	23.17	0.3	23.47	33.01	PASS
Band25	3	26675	8	#0	16QAM	21.91	0.3	22.21	33.01	PASS
Band25	3	26675	8	#Mid	16QAM	21.84	0.3	22.14	33.01	PASS
Band25	3	26675	8	#Max	16QAM	21.90	0.3	22.20	33.01	PASS
Band25	3	26675	15	#0	16QAM	21.94	0.3	22.24	33.01	PASS
Band25	5	26065	1	#0	QPSK	24.20	0.3	24.50	33.01	PASS
Band25	5	26065	1	#Mid	QPSK	24.24	0.3	24.54	33.01	PASS
Band25	5	26065	1	#Max	QPSK	24.25	0.3	24.55	33.01	PASS
Band25	5	26065	12	#0	QPSK	23.87	0.3	24.17	33.01	PASS
Band25	5	26065	12	#Mid	QPSK	23.86	0.3	24.16	33.01	PASS
Band25	5	26065	12	#Max	QPSK	23.87	0.3	24.17	33.01	PASS
Band25	5	26065	25	#0	QPSK	23.85	0.3	24.15	33.01	PASS
Band25	5	26065	1	#0	16QAM	23.45	0.3	23.75	33.01	PASS
Band25	5	26065	1	#Mid	16QAM	23.44	0.3	23.74	33.01	PASS
Band25	5	26065	1	#Max	16QAM	23.48	0.3	23.78	33.01	PASS
Band25	5	26065	12	#0	16QAM	22.30	0.3	22.60	33.01	PASS
Band25	5	26065	12	#Mid	16QAM	22.27	0.3	22.57	33.01	PASS
Band25	5	26065	12	#Max	16QAM	22.28	0.3	22.58	33.01	PASS
Band25	5	26065	25	#0	16QAM	22.33	0.3	22.63	33.01	PASS
Band25	5	26365	1	#0	QPSK	23.62	0.3	23.92	33.01	PASS
Band25	5	26365	1	#Mid	QPSK	23.68	0.3	23.98	33.01	PASS
Band25	5	26365	1	#Max	QPSK	23.71	0.3	24.01	33.01	PASS
Band25	5	26365	12	#0	QPSK	23.22	0.3	23.52	33.01	PASS
Band25	5	26365	12	#Mid	QPSK	23.16	0.3	23.46	33.01	PASS
Band25	5	26365	12	#Max	QPSK	23.18	0.3	23.48	33.01	PASS
Band25	5	26365	25	#0	QPSK	23.17	0.3	23.47	33.01	PASS
Band25	5	26365	1	#0	16QAM	22.40	0.3	22.70	33.01	PASS
Band25	5	26365	1	#Mid	16QAM	22.32	0.3	22.62	33.01	PASS
Band25	5	26365	1	#Max	16QAM	22.41	0.3	22.71	33.01	PASS
Band25	5	26365	12	#0	16QAM	21.63	0.3	21.93	33.01	PASS
Band25	5	26365	12	#Mid	16QAM	21.59	0.3	21.89	33.01	PASS
Band25	5	26365	12	#Max	16QAM	21.65	0.3	21.95	33.01	PASS
Band25	5	26365	25	#0	16QAM	21.76	0.3	22.06	33.01	PASS
Band25	5	26665	1	#0	QPSK	23.80	0.3	24.10	33.01	PASS
Band25	5	26665	1	#Mid	QPSK	23.77	0.3	24.07	33.01	PASS
Band25	5	26665	1	#Max	QPSK	23.79	0.3	24.09	33.01	PASS
Band25	5	26665	12	#0	QPSK	23.37	0.3	23.67	33.01	PASS
Band25	5	26665	12	#Mid	QPSK	23.36	0.3	23.66	33.01	PASS
Band25	5	26665	12	#Max	QPSK	23.39	0.3	23.69	33.01	PASS
Band25	5	26665	25	#0	QPSK	23.34	0.3	23.64	33.01	PASS
Band25	5	26665	1	#0	16QAM	22.84	0.3	23.14	33.01	PASS
Band25	5	26665	1	#Mid	16QAM	22.84	0.3	23.14	33.01	PASS
Band25	5	26665	1	#Max	16QAM	22.78	0.3	23.08	33.01	PASS
Band25	5	26665	12	#0	16QAM	21.86	0.3	22.16	33.01	PASS
Band25	5	26665	12	#Mid	16QAM	21.82	0.3	22.12	33.01	PASS
Band25	5	26665	12	#Max	16QAM	21.77	0.3	22.07	33.01	PASS
Band25	5	26665	25	#0	16QAM	21.79	0.3	22.09	33.01	PASS
Band25	10	26090	1	#0	QPSK	24.30	0.3	24.60	33.01	PASS
Band25	10	26090	1	#Mid	QPSK	24.34	0.3	24.64	33.01	PASS
Band25	10	26090	1	#Max	QPSK	24.36	0.3	24.66	33.01	PASS
Band25	10	26090	25	#0	QPSK	23.83	0.3	24.13	33.01	PASS
Band25	10	26090	25	#Mid	QPSK	23.93	0.3	24.23	33.01	PASS
Band25	10	26090	25	#Max	QPSK	23.88	0.3	24.18	33.01	PASS
Band25	10	26090	50	#0	QPSK	23.81	0.3	24.11	33.01	PASS

Band25	10	26090	1	#0	16QAM	24.42	0.3	24.72	33.01	PASS
Band25	10	26090	1	#Mid	16QAM	24.42	0.3	24.72	33.01	PASS
Band25	10	26090	1	#Max	16QAM	24.50	0.3	24.80	33.01	PASS
Band25	10	26090	25	#0	16QAM	22.24	0.3	22.54	33.01	PASS
Band25	10	26090	25	#Mid	16QAM	22.60	0.3	22.90	33.01	PASS
Band25	10	26090	25	#Max	16QAM	22.33	0.3	22.63	33.01	PASS
Band25	10	26090	50	#0	16QAM	22.75	0.3	23.05	33.01	PASS
Band25	10	26365	1	#0	QPSK	23.80	0.3	24.10	33.01	PASS
Band25	10	26365	1	#Mid	QPSK	23.66	0.3	23.96	33.01	PASS
Band25	10	26365	1	#Max	QPSK	23.76	0.3	24.06	33.01	PASS
Band25	10	26365	25	#0	QPSK	23.15	0.3	23.45	33.01	PASS
Band25	10	26365	25	#Mid	QPSK	23.11	0.3	23.41	33.01	PASS
Band25	10	26365	25	#Max	QPSK	23.23	0.3	23.53	33.01	PASS
Band25	10	26365	50	#0	QPSK	23.25	0.3	23.55	33.01	PASS
Band25	10	26365	1	#0	16QAM	23.47	0.3	23.77	33.01	PASS
Band25	10	26365	1	#Mid	16QAM	23.44	0.3	23.74	33.01	PASS
Band25	10	26365	1	#Max	16QAM	23.41	0.3	23.71	33.01	PASS
Band25	10	26365	25	#0	16QAM	21.78	0.3	22.08	33.01	PASS
Band25	10	26365	25	#Mid	16QAM	21.70	0.3	22.00	33.01	PASS
Band25	10	26365	25	#Max	16QAM	21.79	0.3	22.09	33.01	PASS
Band25	10	26365	50	#0	16QAM	21.74	0.3	22.04	33.01	PASS
Band25	10	26640	1	#0	QPSK	23.73	0.3	24.03	33.01	PASS
Band25	10	26640	1	#Mid	QPSK	23.76	0.3	24.06	33.01	PASS
Band25	10	26640	1	#Max	QPSK	23.96	0.3	24.26	33.01	PASS
Band25	10	26640	25	#0	QPSK	23.26	0.3	23.56	33.01	PASS
Band25	10	26640	25	#Mid	QPSK	23.30	0.3	23.60	33.01	PASS
Band25	10	26640	25	#Max	QPSK	23.44	0.3	23.74	33.01	PASS
Band25	10	26640	50	#0	QPSK	23.27	0.3	23.57	33.01	PASS
Band25	10	26640	1	#0	16QAM	22.74	0.3	23.04	33.01	PASS
Band25	10	26640	1	#Mid	16QAM	22.80	0.3	23.10	33.01	PASS
Band25	10	26640	1	#Max	16QAM	22.88	0.3	23.18	33.01	PASS
Band25	10	26640	25	#0	16QAM	21.79	0.3	22.09	33.01	PASS
Band25	10	26640	25	#Mid	16QAM	22.20	0.3	22.50	33.01	PASS
Band25	10	26640	25	#Max	16QAM	21.92	0.3	22.22	33.01	PASS
Band25	10	26640	50	#0	16QAM	22.24	0.3	22.54	33.01	PASS
Band25	15	26115	1	#0	QPSK	24.28	0.3	24.58	33.01	PASS
Band25	15	26115	1	#Mid	QPSK	24.36	0.3	24.66	33.01	PASS
Band25	15	26115	1	#Max	QPSK	24.1	0.3	24.40	33.01	PASS
Band25	15	26115	36	#0	QPSK	23.89	0.3	24.19	33.01	PASS
Band25	15	26115	36	#Mid	QPSK	23.87	0.3	24.17	33.01	PASS
Band25	15	26115	36	#Max	QPSK	23.71	0.3	24.01	33.01	PASS
Band25	15	26115	75	#0	QPSK	23.94	0.3	24.24	33.01	PASS
Band25	15	26115	1	#0	16QAM	24.45	0.3	24.75	33.01	PASS
Band25	15	26115	1	#Mid	16QAM	24.42	0.3	24.72	33.01	PASS
Band25	15	26115	1	#Max	16QAM	24.13	0.3	24.43	33.01	PASS
Band25	15	26115	36	#0	16QAM	22.8	0.3	23.10	33.01	PASS
Band25	15	26115	36	#Mid	16QAM	22.42	0.3	22.72	33.01	PASS
Band25	15	26115	36	#Max	16QAM	22.32	0.3	22.62	33.01	PASS
Band25	15	26115	75	#0	16QAM	22.36	0.3	22.66	33.01	PASS
Band25	15	26365	1	#0	QPSK	23.99	0.3	24.29	33.01	PASS
Band25	15	26365	1	#Mid	QPSK	23.83	0.3	24.13	33.01	PASS
Band25	15	26365	1	#Max	QPSK	23.92	0.3	24.22	33.01	PASS
Band25	15	26365	36	#0	QPSK	23.32	0.3	23.62	33.01	PASS
Band25	15	26365	36	#Mid	QPSK	23.21	0.3	23.51	33.01	PASS
Band25	15	26365	36	#Max	QPSK	23.21	0.3	23.51	33.01	PASS
Band25	15	26365	75	#0	QPSK	23.13	0.3	23.43	33.01	PASS
Band25	15	26365	1	#0	16QAM	22.86	0.3	23.16	33.01	PASS
Band25	15	26365	1	#Mid	16QAM	22.71	0.3	23.01	33.01	PASS
Band25	15	26365	1	#Max	16QAM	22.78	0.3	23.08	33.01	PASS
Band25	15	26365	36	#0	16QAM	21.87	0.3	22.17	33.01	PASS
Band25	15	26365	36	#Mid	16QAM	21.82	0.3	22.12	33.01	PASS
Band25	15	26365	36	#Max	16QAM	21.79	0.3	22.09	33.01	PASS
Band25	15	26365	75	#0	16QAM	21.77	0.3	22.07	33.01	PASS
Band25	15	26615	1	#0	QPSK	23.6	0.3	23.90	33.01	PASS
Band25	15	26615	1	#Mid	QPSK	23.73	0.3	24.03	33.01	PASS
Band25	15	26615	1	#Max	QPSK	23.79	0.3	24.09	33.01	PASS
Band25	15	26615	36	#0	QPSK	23.31	0.3	23.61	33.01	PASS
Band25	15	26615	36	#Mid	QPSK	23.32	0.3	23.62	33.01	PASS

Band25	15	26615	36	#Max	QPSK	23.44	0.3	23.74	33.01	PASS
Band25	15	26615	75	#0	QPSK	23.26	0.3	23.56	33.01	PASS
Band25	15	26615	1	#0	16QAM	23.57	0.3	23.87	33.01	PASS
Band25	15	26615	1	#Mid	16QAM	23.6	0.3	23.90	33.01	PASS
Band25	15	26615	1	#Max	16QAM	23.74	0.3	24.04	33.01	PASS
Band25	15	26615	36	#0	16QAM	21.72	0.3	22.02	33.01	PASS
Band25	15	26615	36	#Mid	16QAM	21.69	0.3	21.99	33.01	PASS
Band25	15	26615	36	#Max	16QAM	21.89	0.3	22.19	33.01	PASS
Band25	15	26615	75	#0	16QAM	21.76	0.3	22.06	33.01	PASS
Band25	20	26140	1	#0	QPSK	24.87	0.3	25.17	33.01	PASS
Band25	20	26140	1	#Mid	QPSK	24.91	0.3	25.21	33.01	PASS
Band25	20	26140	1	#Max	QPSK	24.51	0.3	24.81	33.01	PASS
Band25	20	26140	50	#0	QPSK	24.3	0.3	24.60	33.01	PASS
Band25	20	26140	50	#Mid	QPSK	24.31	0.3	24.61	33.01	PASS
Band25	20	26140	50	#Max	QPSK	24.05	0.3	24.35	33.01	PASS
Band25	20	26140	100	#0	QPSK	24.34	0.3	24.64	33.01	PASS
Band25	20	26140	1	#0	16QAM	23.9	0.3	24.20	33.01	PASS
Band25	20	26140	1	#Mid	16QAM	23.9	0.3	24.20	33.01	PASS
Band25	20	26140	1	#Max	16QAM	23.56	0.3	23.86	33.01	PASS
Band25	20	26140	50	#0	16QAM	23.25	0.3	23.55	33.01	PASS
Band25	20	26140	50	#Mid	16QAM	22.96	0.3	23.26	33.01	PASS
Band25	20	26140	50	#Max	16QAM	23.23	0.3	23.53	33.01	PASS
Band25	20	26140	100	#0	16QAM	22.92	0.3	23.22	33.01	PASS
Band25	20	26365	1	#0	QPSK	24.54	0.3	24.84	33.01	PASS
Band25	20	26365	1	#Mid	QPSK	24.42	0.3	24.72	33.01	PASS
Band25	20	26365	1	#Max	QPSK	24.54	0.3	24.84	33.01	PASS
Band25	20	26365	50	#0	QPSK	23.76	0.3	24.06	33.01	PASS
Band25	20	26365	50	#Mid	QPSK	23.72	0.3	24.02	33.01	PASS
Band25	20	26365	50	#Max	QPSK	23.72	0.3	24.02	33.01	PASS
Band25	20	26365	100	#0	QPSK	23.79	0.3	24.09	33.01	PASS
Band25	20	26365	1	#0	16QAM	22.95	0.3	23.25	33.01	PASS
Band25	20	26365	1	#Mid	16QAM	22.76	0.3	23.06	33.01	PASS
Band25	20	26365	1	#Max	16QAM	22.82	0.3	23.12	33.01	PASS
Band25	20	26365	50	#0	16QAM	22.3	0.3	22.60	33.01	PASS
Band25	20	26365	50	#Mid	16QAM	22.33	0.3	22.63	33.01	PASS
Band25	20	26365	50	#Max	16QAM	22.28	0.3	22.58	33.01	PASS
Band25	20	26365	100	#0	16QAM	22.23	0.3	22.53	33.01	PASS
Band25	20	26590	1	#0	QPSK	24.3	0.3	24.60	33.01	PASS
Band25	20	26590	1	#Mid	QPSK	24.32	0.3	24.62	33.01	PASS
Band25	20	26590	1	#Max	QPSK	24.54	0.3	24.84	33.01	PASS
Band25	20	26590	50	#0	QPSK	23.64	0.3	23.94	33.01	PASS
Band25	20	26590	50	#Mid	QPSK	23.74	0.3	24.04	33.01	PASS
Band25	20	26590	50	#Max	QPSK	23.84	0.3	24.14	33.01	PASS
Band25	20	26590	100	#0	QPSK	23.78	0.3	24.08	33.01	PASS
Band25	20	26590	1	#0	16QAM	23.68	0.3	23.98	33.01	PASS
Band25	20	26590	1	#Mid	16QAM	23.6	0.3	23.90	33.01	PASS
Band25	20	26590	1	#Max	16QAM	23.72	0.3	24.02	33.01	PASS
Band25	20	26590	50	#0	16QAM	22.25	0.3	22.55	33.01	PASS
Band25	20	26590	50	#Mid	16QAM	22.31	0.3	22.61	33.01	PASS
Band25	20	26590	50	#Max	16QAM	22.79	0.3	23.09	33.01	PASS
Band25	20	26590	100	#0	16QAM	22.34	0.3	22.64	33.01	PASS

Band	Bandwidth (MHz)	UL Channel	RB Size	RB Position	Modulation	Power (dBm)	Gain (dB)	ERP (dBm)	ERP Limit (dBm)	Verdict
Band26(814-824)	1.4	26697	1	#0	QPSK	23.74	-2.8	18.79	50	PASS
Band26(814-824)	1.4	26697	1	#Mid	QPSK	23.74	-2.8	18.79	50	PASS
Band26(814-824)	1.4	26697	1	#Max	QPSK	23.69	-2.8	18.74	50	PASS
Band26(814-824)	1.4	26697	3	#0	QPSK	23.19	-2.8	18.24	50	PASS
Band26(814-824)	1.4	26697	3	#Mid	QPSK	23.21	-2.8	18.26	50	PASS
Band26(814-824)	1.4	26697	3	#Max	QPSK	23.17	-2.8	18.22	50	PASS
Band26(814-824)	1.4	26697	6	#0	QPSK	22.66	-2.8	17.71	50	PASS
Band26(814-824)	1.4	26697	1	#0	16QAM	24.01	-2.8	19.06	50	PASS
Band26(814-824)	1.4	26697	1	#Mid	16QAM	23.93	-2.8	18.98	50	PASS
Band26(814-824)	1.4	26697	1	#Max	16QAM	24.11	-2.8	19.16	50	PASS
Band26(814-824)	1.4	26697	3	#0	16QAM	22.77	-2.8	17.82	50	PASS
Band26(814-824)	1.4	26697	3	#Mid	16QAM	22.75	-2.8	17.80	50	PASS
Band26(814-824)	1.4	26697	3	#Max	16QAM	22.84	-2.8	17.89	50	PASS
Band26(814-824)	1.4	26697	6	#0	16QAM	21.75	-2.8	16.80	50	PASS
Band26(814-824)	1.4	26740	1	#0	QPSK	23.59	-2.8	18.64	50	PASS
Band26(814-824)	1.4	26740	1	#Mid	QPSK	23.61	-2.8	18.66	50	PASS
Band26(814-824)	1.4	26740	1	#Max	QPSK	23.59	-2.8	18.64	50	PASS
Band26(814-824)	1.4	26740	3	#0	QPSK	23.11	-2.8	18.16	50	PASS
Band26(814-824)	1.4	26740	3	#Mid	QPSK	23.12	-2.8	18.17	50	PASS
Band26(814-824)	1.4	26740	3	#Max	QPSK	23.07	-2.8	18.12	50	PASS
Band26(814-824)	1.4	26740	6	#0	QPSK	22.54	-2.8	17.59	50	PASS
Band26(814-824)	1.4	26740	1	#0	16QAM	23.16	-2.8	18.21	50	PASS
Band26(814-824)	1.4	26740	1	#Mid	16QAM	23.13	-2.8	18.18	50	PASS
Band26(814-824)	1.4	26740	1	#Max	16QAM	23.13	-2.8	18.18	50	PASS
Band26(814-824)	1.4	26740	3	#0	16QAM	22.11	-2.8	17.16	50	PASS
Band26(814-824)	1.4	26740	3	#Mid	16QAM	22.08	-2.8	17.13	50	PASS
Band26(814-824)	1.4	26740	3	#Max	16QAM	22.05	-2.8	17.10	50	PASS
Band26(814-824)	1.4	26740	6	#0	16QAM	21.39	-2.8	16.44	50	PASS
Band26(814-824)	1.4	26783	1	#0	QPSK	23.35	-2.8	18.40	50	PASS
Band26(814-824)	1.4	26783	1	#Mid	QPSK	23.31	-2.8	18.36	50	PASS
Band26(814-824)	1.4	26783	1	#Max	QPSK	23.39	-2.8	18.44	50	PASS
Band26(814-824)	1.4	26783	3	#0	QPSK	22.89	-2.8	17.94	50	PASS
Band26(814-824)	1.4	26783	3	#Mid	QPSK	22.89	-2.8	17.94	50	PASS
Band26(814-824)	1.4	26783	3	#Max	QPSK	22.84	-2.8	17.89	50	PASS
Band26(814-824)	1.4	26783	6	#0	QPSK	22.42	-2.8	17.47	50	PASS
Band26(814-824)	1.4	26783	1	#0	16QAM	22.72	-2.8	17.77	50	PASS
Band26(814-824)	1.4	26783	1	#Mid	16QAM	22.86	-2.8	17.91	50	PASS
Band26(814-824)	1.4	26783	1	#Max	16QAM	22.92	-2.8	17.97	50	PASS
Band26(814-824)	1.4	26783	3	#0	16QAM	22.34	-2.8	17.39	50	PASS
Band26(814-824)	1.4	26783	3	#Mid	16QAM	22.28	-2.8	17.33	50	PASS
Band26(814-824)	1.4	26783	3	#Max	16QAM	22.19	-2.8	17.24	50	PASS
Band26(814-824)	1.4	26783	6	#0	16QAM	21.56	-2.8	16.61	50	PASS
Band26(814-824)	3	26705	1	#0	QPSK	23.63	-2.8	18.68	50	PASS
Band26(814-824)	3	26705	1	#Mid	QPSK	23.62	-2.8	18.67	50	PASS
Band26(814-824)	3	26705	1	#Max	QPSK	23.68	-2.8	18.73	50	PASS
Band26(814-824)	3	26705	8	#0	QPSK	22.69	-2.8	17.74	50	PASS
Band26(814-824)	3	26705	8	#Mid	QPSK	22.77	-2.8	17.82	50	PASS
Band26(814-824)	3	26705	8	#Max	QPSK	22.71	-2.8	17.76	50	PASS
Band26(814-824)	3	26705	15	#0	QPSK	22.59	-2.8	17.64	50	PASS
Band26(814-824)	3	26705	1	#0	16QAM	24.04	-2.8	19.09	50	PASS
Band26(814-824)	3	26705	1	#Mid	16QAM	23.96	-2.8	19.01	50	PASS
Band26(814-824)	3	26705	1	#Max	16QAM	23.64	-2.8	18.69	50	PASS
Band26(814-824)	3	26705	8	#0	16QAM	21.47	-2.8	16.52	50	PASS
Band26(814-824)	3	26705	8	#Mid	16QAM	21.48	-2.8	16.53	50	PASS
Band26(814-824)	3	26705	8	#Max	16QAM	21.44	-2.8	16.49	50	PASS
Band26(814-824)	3	26705	15	#0	16QAM	21.61	-2.8	16.66	50	PASS
Band26(814-824)	3	26740	1	#0	QPSK	23.60	-2.8	18.65	50	PASS
Band26(814-824)	3	26740	1	#Mid	QPSK	23.54	-2.8	18.59	50	PASS
Band26(814-824)	3	26740	1	#Max	QPSK	23.51	-2.8	18.56	50	PASS
Band26(814-824)	3	26740	8	#0	QPSK	22.59	-2.8	17.64	50	PASS
Band26(814-824)	3	26740	8	#Mid	QPSK	22.54	-2.8	17.59	50	PASS
Band26(814-824)	3	26740	8	#Max	QPSK	22.49	-2.8	17.54	50	PASS
Band26(814-824)	3	26740	15	#0	QPSK	22.63	-2.8	17.68	50	PASS
Band26(814-824)	3	26740	1	#0	16QAM	23.09	-2.8	18.14	50	PASS
Band26(814-824)	3	26740	1	#Mid	16QAM	23.10	-2.8	18.15	50	PASS

Band26(814-824)	3	26740	1	#Max	16QAM	23.13	-2.8	18.18	50	PASS
Band26(814-824)	3	26740	8	#0	16QAM	21.69	-2.8	16.74	50	PASS
Band26(814-824)	3	26740	8	#Mid	16QAM	21.70	-2.8	16.75	50	PASS
Band26(814-824)	3	26740	8	#Max	16QAM	21.62	-2.8	16.67	50	PASS
Band26(814-824)	3	26740	15	#0	16QAM	21.45	-2.8	16.50	50	PASS
Band26(814-824)	3	26775	1	#0	QPSK	23.35	-2.8	18.40	50	PASS
Band26(814-824)	3	26775	1	#Mid	QPSK	23.35	-2.8	18.40	50	PASS
Band26(814-824)	3	26775	1	#Max	QPSK	23.36	-2.8	18.41	50	PASS
Band26(814-824)	3	26775	8	#0	QPSK	22.46	-2.8	17.51	50	PASS
Band26(814-824)	3	26775	8	#Mid	QPSK	22.44	-2.8	17.49	50	PASS
Band26(814-824)	3	26775	8	#Max	QPSK	22.37	-2.8	17.42	50	PASS
Band26(814-824)	3	26775	15	#0	QPSK	22.40	-2.8	17.45	50	PASS
Band26(814-824)	3	26775	1	#0	16QAM	22.79	-2.8	17.84	50	PASS
Band26(814-824)	3	26775	1	#Mid	16QAM	22.84	-2.8	17.89	50	PASS
Band26(814-824)	3	26775	1	#Max	16QAM	22.91	-2.8	17.96	50	PASS
Band26(814-824)	3	26775	8	#0	16QAM	21.36	-2.8	16.41	50	PASS
Band26(814-824)	3	26775	8	#Mid	16QAM	21.44	-2.8	16.49	50	PASS
Band26(814-824)	3	26775	8	#Max	16QAM	21.41	-2.8	16.46	50	PASS
Band26(814-824)	3	26775	15	#0	16QAM	21.46	-2.8	16.51	50	PASS
Band26(814-824)	5	26715	1	#0	QPSK	23.65	-2.8	18.70	50	PASS
Band26(814-824)	5	26715	1	#Mid	QPSK	23.55	-2.8	18.60	50	PASS
Band26(814-824)	5	26715	1	#Max	QPSK	23.53	-2.8	18.58	50	PASS
Band26(814-824)	5	26715	12	#0	QPSK	22.64	-2.8	17.69	50	PASS
Band26(814-824)	5	26715	12	#Mid	QPSK	22.60	-2.8	17.65	50	PASS
Band26(814-824)	5	26715	12	#Max	QPSK	22.57	-2.8	17.62	50	PASS
Band26(814-824)	5	26715	25	#0	QPSK	22.65	-2.8	17.70	50	PASS
Band26(814-824)	5	26715	1	#0	16QAM	23.16	-2.8	18.21	50	PASS
Band26(814-824)	5	26715	1	#Mid	16QAM	22.65	-2.8	17.70	50	PASS
Band26(814-824)	5	26715	1	#Max	16QAM	22.64	-2.8	17.69	50	PASS
Band26(814-824)	5	26715	12	#0	16QAM	21.50	-2.8	16.55	50	PASS
Band26(814-824)	5	26715	12	#Mid	16QAM	21.48	-2.8	16.53	50	PASS
Band26(814-824)	5	26715	12	#Max	16QAM	21.42	-2.8	16.47	50	PASS
Band26(814-824)	5	26715	25	#0	16QAM	21.69	-2.8	16.74	50	PASS
Band26(814-824)	5	26740	1	#0	QPSK	23.50	-2.8	18.55	50	PASS
Band26(814-824)	5	26740	1	#Mid	QPSK	23.46	-2.8	18.51	50	PASS
Band26(814-824)	5	26740	1	#Max	QPSK	23.39	-2.8	18.44	50	PASS
Band26(814-824)	5	26740	12	#0	QPSK	22.56	-2.8	17.61	50	PASS
Band26(814-824)	5	26740	12	#Mid	QPSK	22.43	-2.8	17.48	50	PASS
Band26(814-824)	5	26740	12	#Max	QPSK	22.55	-2.8	17.60	50	PASS
Band26(814-824)	5	26740	25	#0	QPSK	22.52	-2.8	17.57	50	PASS
Band26(814-824)	5	26740	1	#0	16QAM	22.57	-2.8	17.62	50	PASS
Band26(814-824)	5	26740	1	#Mid	16QAM	22.44	-2.8	17.49	50	PASS
Band26(814-824)	5	26740	1	#Max	16QAM	22.43	-2.8	17.48	50	PASS
Band26(814-824)	5	26740	12	#0	16QAM	21.27	-2.8	16.32	50	PASS
Band26(814-824)	5	26740	12	#Mid	16QAM	21.34	-2.8	16.39	50	PASS
Band26(814-824)	5	26740	12	#Max	16QAM	21.31	-2.8	16.36	50	PASS
Band26(814-824)	5	26740	25	#0	16QAM	21.48	-2.8	16.53	50	PASS
Band26(814-824)	5	26765	1	#0	QPSK	23.34	-2.8	18.39	50	PASS
Band26(814-824)	5	26765	1	#Mid	QPSK	23.25	-2.8	18.30	50	PASS
Band26(814-824)	5	26765	1	#Max	QPSK	23.23	-2.8	18.28	50	PASS
Band26(814-824)	5	26765	12	#0	QPSK	22.45	-2.8	17.50	50	PASS
Band26(814-824)	5	26765	12	#Mid	QPSK	22.44	-2.8	17.49	50	PASS
Band26(814-824)	5	26765	12	#Max	QPSK	22.42	-2.8	17.47	50	PASS
Band26(814-824)	5	26765	25	#0	QPSK	22.39	-2.8	17.44	50	PASS
Band26(814-824)	5	26765	1	#0	16QAM	23.06	-2.8	18.11	50	PASS
Band26(814-824)	5	26765	1	#Mid	16QAM	23.01	-2.8	18.06	50	PASS
Band26(814-824)	5	26765	1	#Max	16QAM	22.89	-2.8	17.94	50	PASS
Band26(814-824)	5	26765	12	#0	16QAM	21.36	-2.8	16.41	50	PASS
Band26(814-824)	5	26765	12	#Mid	16QAM	21.29	-2.8	16.34	50	PASS
Band26(814-824)	5	26765	12	#Max	16QAM	21.34	-2.8	16.39	50	PASS
Band26(814-824)	5	26765	25	#0	16QAM	21.47	-2.8	16.52	50	PASS
Band26(814-824)	10	26740	1	#0	QPSK	24.60	-2.8	19.65	50	PASS
Band26(814-824)	10	26740	1	#Mid	QPSK	23.93	-2.8	18.98	50	PASS
Band26(814-824)	10	26740	1	#Max	QPSK	23.87	-2.8	18.92	50	PASS
Band26(814-824)	10	26740	25	#0	QPSK	23.56	-2.8	18.61	50	PASS
Band26(814-824)	10	26740	25	#Mid	QPSK	23.45	-2.8	18.50	50	PASS
Band26(814-824)	10	26740	25	#Max	QPSK	23.40	-2.8	18.45	50	PASS
Band26(814-824)	10	26740	50	#0	QPSK	23.59	-2.8	18.64	50	PASS

Band26(814-824)	10	26740	1	#0	16QAM	23.86	-2.8	18.91	50	PASS
Band26(814-824)	10	26740	1	#Mid	16QAM	23.46	-2.8	18.51	50	PASS
Band26(814-824)	10	26740	1	#Max	16QAM	23.42	-2.8	18.47	50	PASS
Band26(814-824)	10	26740	25	#0	16QAM	21.85	-2.8	16.90	50	PASS
Band26(814-824)	10	26740	25	#Mid	16QAM	21.84	-2.8	16.89	50	PASS
Band26(814-824)	10	26740	25	#Max	16QAM	21.72	-2.8	16.77	50	PASS
Band26(814-824)	10	26740	50	#0	16QAM	21.89	-2.8	16.94	50	PASS

Band	Bandwidth (MHz)	UL Channel	RB Size	RB Position	Modulation	Power (dBm)	Gain (dB)	ERP (dBm)	ERP Limit (dBm)	Verdict
Band26(824-849)	1.4	26797	1	#0	QPSK	23.52	-2.8	18.57	38.45	PASS
Band26(824-849)	1.4	26797	1	#Mid	QPSK	23.39	-2.8	18.44	38.45	PASS
Band26(824-849)	1.4	26797	1	#Max	QPSK	23.56	-2.8	18.61	38.45	PASS
Band26(824-849)	1.4	26797	3	#0	QPSK	22.89	-2.8	17.94	38.45	PASS
Band26(824-849)	1.4	26797	3	#Mid	QPSK	22.91	-2.8	17.96	38.45	PASS
Band26(824-849)	1.4	26797	3	#Max	QPSK	22.87	-2.8	17.92	38.45	PASS
Band26(824-849)	1.4	26797	6	#0	QPSK	22.38	-2.8	17.43	38.45	PASS
Band26(824-849)	1.4	26797	1	#0	16QAM	23.22	-2.8	18.27	38.45	PASS
Band26(824-849)	1.4	26797	1	#Mid	16QAM	23.27	-2.8	18.32	38.45	PASS
Band26(824-849)	1.4	26797	1	#Max	16QAM	23.20	-2.8	18.25	38.45	PASS
Band26(824-849)	1.4	26797	3	#0	16QAM	22.02	-2.8	17.07	38.45	PASS
Band26(824-849)	1.4	26797	3	#Mid	16QAM	21.99	-2.8	17.04	38.45	PASS
Band26(824-849)	1.4	26797	3	#Max	16QAM	22.02	-2.8	17.07	38.45	PASS
Band26(824-849)	1.4	26797	6	#0	16QAM	21.54	-2.8	16.59	38.45	PASS
Band26(824-849)	1.4	26915	1	#0	QPSK	23.72	-2.8	18.77	38.45	PASS
Band26(824-849)	1.4	26915	1	#Mid	QPSK	23.83	-2.8	18.88	38.45	PASS
Band26(824-849)	1.4	26915	1	#Max	QPSK	23.77	-2.8	18.82	38.45	PASS
Band26(824-849)	1.4	26915	3	#0	QPSK	23.24	-2.8	18.29	38.45	PASS
Band26(824-849)	1.4	26915	3	#Mid	QPSK	23.29	-2.8	18.34	38.45	PASS
Band26(824-849)	1.4	26915	3	#Max	QPSK	23.22	-2.8	18.27	38.45	PASS
Band26(824-849)	1.4	26915	6	#0	QPSK	22.75	-2.8	17.80	38.45	PASS
Band26(824-849)	1.4	26915	1	#0	16QAM	23.76	-2.8	18.81	38.45	PASS
Band26(824-849)	1.4	26915	1	#Mid	16QAM	23.93	-2.8	18.98	38.45	PASS
Band26(824-849)	1.4	26915	1	#Max	16QAM	23.93	-2.8	18.98	38.45	PASS
Band26(824-849)	1.4	26915	3	#0	16QAM	22.68	-2.8	17.73	38.45	PASS
Band26(824-849)	1.4	26915	3	#Mid	16QAM	22.61	-2.8	17.66	38.45	PASS
Band26(824-849)	1.4	26915	3	#Max	16QAM	22.69	-2.8	17.74	38.45	PASS
Band26(824-849)	1.4	26915	6	#0	16QAM	21.65	-2.8	16.70	38.45	PASS
Band26(824-849)	1.4	27033	1	#0	QPSK	24.11	-2.8	19.16	38.45	PASS
Band26(824-849)	1.4	27033	1	#Mid	QPSK	24.06	-2.8	19.11	38.45	PASS
Band26(824-849)	1.4	27033	1	#Max	QPSK	24.07	-2.8	19.12	38.45	PASS
Band26(824-849)	1.4	27033	3	#0	QPSK	23.61	-2.8	18.66	38.45	PASS
Band26(824-849)	1.4	27033	3	#Mid	QPSK	23.60	-2.8	18.65	38.45	PASS
Band26(824-849)	1.4	27033	3	#Max	QPSK	23.57	-2.8	18.62	38.45	PASS
Band26(824-849)	1.4	27033	6	#0	QPSK	23.05	-2.8	18.10	38.45	PASS
Band26(824-849)	1.4	27033	1	#0	16QAM	23.12	-2.8	18.17	38.45	PASS
Band26(824-849)	1.4	27033	1	#Mid	16QAM	23.12	-2.8	18.17	38.45	PASS
Band26(824-849)	1.4	27033	1	#Max	16QAM	23.16	-2.8	18.21	38.45	PASS
Band26(824-849)	1.4	27033	3	#0	16QAM	22.44	-2.8	17.49	38.45	PASS
Band26(824-849)	1.4	27033	3	#Mid	16QAM	22.40	-2.8	17.45	38.45	PASS
Band26(824-849)	1.4	27033	3	#Max	16QAM	22.41	-2.8	17.46	38.45	PASS
Band26(824-849)	1.4	27033	6	#0	16QAM	21.62	-2.8	16.67	38.45	PASS
Band26(824-849)	3	26805	1	#0	QPSK	23.38	-2.8	18.43	38.45	PASS
Band26(824-849)	3	26805	1	#Mid	QPSK	23.18	-2.8	18.23	38.45	PASS
Band26(824-849)	3	26805	1	#Max	QPSK	23.39	-2.8	18.44	38.45	PASS
Band26(824-849)	3	26805	8	#0	QPSK	22.36	-2.8	17.41	38.45	PASS
Band26(824-849)	3	26805	8	#Mid	QPSK	22.39	-2.8	17.44	38.45	PASS
Band26(824-849)	3	26805	8	#Max	QPSK	22.54	-2.8	17.59	38.45	PASS
Band26(824-849)	3	26805	15	#0	QPSK	22.27	-2.8	17.32	38.45	PASS
Band26(824-849)	3	26805	1	#0	16QAM	23.23	-2.8	18.28	38.45	PASS
Band26(824-849)	3	26805	1	#Mid	16QAM	23.21	-2.8	18.26	38.45	PASS
Band26(824-849)	3	26805	1	#Max	16QAM	23.22	-2.8	18.27	38.45	PASS
Band26(824-849)	3	26805	8	#0	16QAM	21.28	-2.8	16.33	38.45	PASS
Band26(824-849)	3	26805	8	#Mid	16QAM	21.14	-2.8	16.19	38.45	PASS
Band26(824-849)	3	26805	8	#Max	16QAM	21.28	-2.8	16.33	38.45	PASS
Band26(824-849)	3	26805	15	#0	16QAM	21.32	-2.8	16.37	38.45	PASS
Band26(824-849)	3	26915	1	#0	QPSK	23.67	-2.8	18.72	38.45	PASS
Band26(824-849)	3	26915	1	#Mid	QPSK	23.84	-2.8	18.89	38.45	PASS
Band26(824-849)	3	26915	1	#Max	QPSK	23.83	-2.8	18.88	38.45	PASS
Band26(824-849)	3	26915	8	#0	QPSK	22.77	-2.8	17.82	38.45	PASS
Band26(824-849)	3	26915	8	#Mid	QPSK	22.79	-2.8	17.84	38.45	PASS
Band26(824-849)	3	26915	8	#Max	QPSK	22.88	-2.8	17.93	38.45	PASS
Band26(824-849)	3	26915	15	#0	QPSK	22.75	-2.8	17.80	38.45	PASS
Band26(824-849)	3	26915	1	#0	16QAM	23.80	-2.8	18.85	38.45	PASS
Band26(824-849)	3	26915	1	#Mid	16QAM	23.92	-2.8	18.97	38.45	PASS

Band26(824-849)	3	26915	1	#Max	16QAM	23.93	-2.8	18.98	38.45	PASS
Band26(824-849)	3	26915	8	#0	16QAM	21.84	-2.8	16.89	38.45	PASS
Band26(824-849)	3	26915	8	#Mid	16QAM	22.00	-2.8	17.05	38.45	PASS
Band26(824-849)	3	26915	8	#Max	16QAM	22.02	-2.8	17.07	38.45	PASS
Band26(824-849)	3	26915	15	#0	16QAM	21.80	-2.8	16.85	38.45	PASS
Band26(824-849)	3	27025	1	#0	QPSK	24.21	-2.8	19.26	38.45	PASS
Band26(824-849)	3	27025	1	#Mid	QPSK	24.09	-2.8	19.14	38.45	PASS
Band26(824-849)	3	27025	1	#Max	QPSK	24.11	-2.8	19.16	38.45	PASS
Band26(824-849)	3	27025	8	#0	QPSK	23.22	-2.8	18.27	38.45	PASS
Band26(824-849)	3	27025	8	#Mid	QPSK	23.11	-2.8	18.16	38.45	PASS
Band26(824-849)	3	27025	8	#Max	QPSK	23.10	-2.8	18.15	38.45	PASS
Band26(824-849)	3	27025	15	#0	QPSK	23.16	-2.8	18.21	38.45	PASS
Band26(824-849)	3	27025	1	#0	16QAM	23.79	-2.8	18.84	38.45	PASS
Band26(824-849)	3	27025	1	#Mid	16QAM	23.98	-2.8	19.03	38.45	PASS
Band26(824-849)	3	27025	1	#Max	16QAM	23.97	-2.8	19.02	38.45	PASS
Band26(824-849)	3	27025	8	#0	16QAM	22.15	-2.8	17.20	38.45	PASS
Band26(824-849)	3	27025	8	#Mid	16QAM	22.14	-2.8	17.19	38.45	PASS
Band26(824-849)	3	27025	8	#Max	16QAM	21.56	-2.8	16.61	38.45	PASS
Band26(824-849)	3	27025	15	#0	16QAM	22.17	-2.8	17.22	38.45	PASS
Band26(824-849)	5	26815	1	#0	QPSK	23.26	-2.8	18.31	38.45	PASS
Band26(824-849)	5	26815	1	#Mid	QPSK	23.28	-2.8	18.33	38.45	PASS
Band26(824-849)	5	26815	1	#Max	QPSK	23.34	-2.8	18.39	38.45	PASS
Band26(824-849)	5	26815	12	#0	QPSK	22.43	-2.8	17.48	38.45	PASS
Band26(824-849)	5	26815	12	#Mid	QPSK	22.41	-2.8	17.46	38.45	PASS
Band26(824-849)	5	26815	12	#Max	QPSK	22.49	-2.8	17.54	38.45	PASS
Band26(824-849)	5	26815	25	#0	QPSK	22.42	-2.8	17.47	38.45	PASS
Band26(824-849)	5	26815	1	#0	16QAM	22.40	-2.8	17.45	38.45	PASS
Band26(824-849)	5	26815	1	#Mid	16QAM	22.49	-2.8	17.54	38.45	PASS
Band26(824-849)	5	26815	1	#Max	16QAM	22.46	-2.8	17.51	38.45	PASS
Band26(824-849)	5	26815	12	#0	16QAM	21.26	-2.8	16.31	38.45	PASS
Band26(824-849)	5	26815	12	#Mid	16QAM	21.29	-2.8	16.34	38.45	PASS
Band26(824-849)	5	26815	12	#Max	16QAM	21.26	-2.8	16.31	38.45	PASS
Band26(824-849)	5	26815	25	#0	16QAM	21.36	-2.8	16.41	38.45	PASS
Band26(824-849)	5	26915	1	#0	QPSK	23.59	-2.8	18.64	38.45	PASS
Band26(824-849)	5	26915	1	#Mid	QPSK	23.71	-2.8	18.76	38.45	PASS
Band26(824-849)	5	26915	1	#Max	QPSK	23.83	-2.8	18.88	38.45	PASS
Band26(824-849)	5	26915	12	#0	QPSK	22.59	-2.8	17.64	38.45	PASS
Band26(824-849)	5	26915	12	#Mid	QPSK	22.70	-2.8	17.75	38.45	PASS
Band26(824-849)	5	26915	12	#Max	QPSK	22.75	-2.8	17.80	38.45	PASS
Band26(824-849)	5	26915	25	#0	QPSK	22.83	-2.8	17.88	38.45	PASS
Band26(824-849)	5	26915	1	#0	16QAM	22.68	-2.8	17.73	38.45	PASS
Band26(824-849)	5	26915	1	#Mid	16QAM	22.87	-2.8	17.92	38.45	PASS
Band26(824-849)	5	26915	1	#Max	16QAM	22.55	-2.8	17.60	38.45	PASS
Band26(824-849)	5	26915	12	#0	16QAM	21.57	-2.8	16.62	38.45	PASS
Band26(824-849)	5	26915	12	#Mid	16QAM	21.61	-2.8	16.66	38.45	PASS
Band26(824-849)	5	26915	12	#Max	16QAM	21.67	-2.8	16.72	38.45	PASS
Band26(824-849)	5	26915	25	#0	16QAM	21.79	-2.8	16.84	38.45	PASS
Band26(824-849)	5	27015	1	#0	QPSK	24.10	-2.8	19.15	38.45	PASS
Band26(824-849)	5	27015	1	#Mid	QPSK	24.00	-2.8	19.05	38.45	PASS
Band26(824-849)	5	27015	1	#Max	QPSK	23.97	-2.8	19.02	38.45	PASS
Band26(824-849)	5	27015	12	#0	QPSK	23.24	-2.8	18.29	38.45	PASS
Band26(824-849)	5	27015	12	#Mid	QPSK	23.02	-2.8	18.07	38.45	PASS
Band26(824-849)	5	27015	12	#Max	QPSK	23.13	-2.8	18.18	38.45	PASS
Band26(824-849)	5	27015	25	#0	QPSK	23.06	-2.8	18.11	38.45	PASS
Band26(824-849)	5	27015	1	#0	16QAM	23.10	-2.8	18.15	38.45	PASS
Band26(824-849)	5	27015	1	#Mid	16QAM	23.03	-2.8	18.08	38.45	PASS
Band26(824-849)	5	27015	1	#Max	16QAM	22.93	-2.8	17.98	38.45	PASS
Band26(824-849)	5	27015	12	#0	16QAM	21.64	-2.8	16.69	38.45	PASS
Band26(824-849)	5	27015	12	#Mid	16QAM	22.09	-2.8	17.14	38.45	PASS
Band26(824-849)	5	27015	12	#Max	16QAM	22.04	-2.8	17.09	38.45	PASS
Band26(824-849)	5	27015	25	#0	16QAM	22.09	-2.8	17.14	38.45	PASS
Band26(824-849)	10	26840	1	#0	QPSK	23.51	-2.8	18.56	38.45	PASS
Band26(824-849)	10	26840	1	#Mid	QPSK	23.46	-2.8	18.51	38.45	PASS
Band26(824-849)	10	26840	1	#Max	QPSK	23.71	-2.8	18.76	38.45	PASS
Band26(824-849)	10	26840	25	#0	QPSK	22.82	-2.8	17.87	38.45	PASS
Band26(824-849)	10	26840	25	#Mid	QPSK	22.87	-2.8	17.92	38.45	PASS
Band26(824-849)	10	26840	25	#Max	QPSK	22.98	-2.8	18.03	38.45	PASS
Band26(824-849)	10	26840	50	#0	QPSK	22.92	-2.8	17.97	38.45	PASS

Band26(824-849)	10	26840	1	#0	16QAM	22.17	-2.8	17.22	38.45	PASS
Band26(824-849)	10	26840	1	#Mid	16QAM	22.26	-2.8	17.31	38.45	PASS
Band26(824-849)	10	26840	1	#Max	16QAM	22.55	-2.8	17.60	38.45	PASS
Band26(824-849)	10	26840	25	#0	16QAM	21.77	-2.8	16.82	38.45	PASS
Band26(824-849)	10	26840	25	#Mid	16QAM	21.84	-2.8	16.89	38.45	PASS
Band26(824-849)	10	26840	25	#Max	16QAM	21.93	-2.8	16.98	38.45	PASS
Band26(824-849)	10	26840	50	#0	16QAM	21.91	-2.8	16.96	38.45	PASS
Band26(824-849)	10	26915	1	#0	QPSK	23.49	-2.8	18.54	38.45	PASS
Band26(824-849)	10	26915	1	#Mid	QPSK	23.66	-2.8	18.71	38.45	PASS
Band26(824-849)	10	26915	1	#Max	QPSK	23.98	-2.8	19.03	38.45	PASS
Band26(824-849)	10	26915	25	#0	QPSK	23.04	-2.8	18.09	38.45	PASS
Band26(824-849)	10	26915	25	#Mid	QPSK	23.18	-2.8	18.23	38.45	PASS
Band26(824-849)	10	26915	25	#Max	QPSK	23.44	-2.8	18.49	38.45	PASS
Band26(824-849)	10	26915	50	#0	QPSK	23.26	-2.8	18.31	38.45	PASS
Band26(824-849)	10	26915	1	#0	16QAM	23.48	-2.8	18.53	38.45	PASS
Band26(824-849)	10	26915	1	#Mid	16QAM	24.19	-2.8	19.24	38.45	PASS
Band26(824-849)	10	26915	1	#Max	16QAM	23.92	-2.8	18.97	38.45	PASS
Band26(824-849)	10	26915	25	#0	16QAM	22.12	-2.8	17.17	38.45	PASS
Band26(824-849)	10	26915	25	#Mid	16QAM	22.20	-2.8	17.25	38.45	PASS
Band26(824-849)	10	26915	25	#Max	16QAM	22.39	-2.8	17.44	38.45	PASS
Band26(824-849)	10	26915	50	#0	16QAM	22.18	-2.8	17.23	38.45	PASS
Band26(824-849)	10	26990	1	#0	QPSK	23.98	-2.8	19.03	38.45	PASS
Band26(824-849)	10	26990	1	#Mid	QPSK	24.08	-2.8	19.13	38.45	PASS
Band26(824-849)	10	26990	1	#Max	QPSK	24.20	-2.8	19.25	38.45	PASS
Band26(824-849)	10	26990	25	#0	QPSK	23.49	-2.8	18.54	38.45	PASS
Band26(824-849)	10	26990	25	#Mid	QPSK	23.47	-2.8	18.52	38.45	PASS
Band26(824-849)	10	26990	25	#Max	QPSK	23.66	-2.8	18.71	38.45	PASS
Band26(824-849)	10	26990	50	#0	QPSK	23.65	-2.8	18.70	38.45	PASS
Band26(824-849)	10	26990	1	#0	16QAM	22.98	-2.8	18.03	38.45	PASS
Band26(824-849)	10	26990	1	#Mid	16QAM	23.02	-2.8	18.07	38.45	PASS
Band26(824-849)	10	26990	1	#Max	16QAM	23.07	-2.8	18.12	38.45	PASS
Band26(824-849)	10	26990	25	#0	16QAM	22.45	-2.8	17.50	38.45	PASS
Band26(824-849)	10	26990	25	#Mid	16QAM	22.13	-2.8	17.18	38.45	PASS
Band26(824-849)	10	26990	25	#Max	16QAM	22.61	-2.8	17.66	38.45	PASS
Band26(824-849)	10	26990	50	#0	16QAM	22.08	-2.8	17.13	38.45	PASS
Band26(824-849)	15	26865	1	#0	QPSK	23.87	-2.8	18.92	38.45	PASS
Band26(824-849)	15	26865	1	#Mid	QPSK	24.08	-2.8	19.13	38.45	PASS
Band26(824-849)	15	26865	1	#Max	QPSK	24.46	-2.8	19.51	38.45	PASS
Band26(824-849)	15	26865	36	#0	QPSK	23.42	-2.8	18.47	38.45	PASS
Band26(824-849)	15	26865	36	#Mid	QPSK	23.57	-2.8	18.62	38.45	PASS
Band26(824-849)	15	26865	36	#Max	QPSK	23.60	-2.8	18.65	38.45	PASS
Band26(824-849)	15	26865	75	#0	QPSK	23.52	-2.8	18.57	38.45	PASS
Band26(824-849)	15	26865	1	#0	16QAM	23.79	-2.8	18.84	38.45	PASS
Band26(824-849)	15	26865	1	#Mid	16QAM	24.02	-2.8	19.07	38.45	PASS
Band26(824-849)	15	26865	1	#Max	16QAM	24.39	-2.8	19.44	38.45	PASS
Band26(824-849)	15	26865	36	#0	16QAM	22.35	-2.8	17.40	38.45	PASS
Band26(824-849)	15	26865	36	#Mid	16QAM	22.49	-2.8	17.54	38.45	PASS
Band26(824-849)	15	26865	36	#Max	16QAM	22.75	-2.8	17.80	38.45	PASS
Band26(824-849)	15	26865	75	#0	16QAM	22.51	-2.8	17.56	38.45	PASS
Band26(824-849)	15	26915	1	#0	QPSK	24.01	-2.8	19.06	38.45	PASS
Band26(824-849)	15	26915	1	#Mid	QPSK	24.39	-2.8	19.44	38.45	PASS
Band26(824-849)	15	26915	1	#Max	QPSK	24.68	-2.8	19.73	38.45	PASS
Band26(824-849)	15	26915	36	#0	QPSK	23.62	-2.8	18.67	38.45	PASS
Band26(824-849)	15	26915	36	#Mid	QPSK	23.74	-2.8	18.79	38.45	PASS
Band26(824-849)	15	26915	36	#Max	QPSK	23.99	-2.8	19.04	38.45	PASS
Band26(824-849)	15	26915	75	#0	QPSK	23.74	-2.8	18.79	38.45	PASS
Band26(824-849)	15	26915	1	#0	16QAM	22.87	-2.8	17.92	38.45	PASS
Band26(824-849)	15	26915	1	#Mid	16QAM	23.60	-2.8	18.65	38.45	PASS
Band26(824-849)	15	26915	1	#Max	16QAM	23.55	-2.8	18.60	38.45	PASS
Band26(824-849)	15	26915	36	#0	16QAM	22.61	-2.8	17.66	38.45	PASS
Band26(824-849)	15	26915	36	#Mid	16QAM	22.85	-2.8	17.90	38.45	PASS
Band26(824-849)	15	26915	36	#Max	16QAM	23.10	-2.8	18.15	38.45	PASS
Band26(824-849)	15	26915	75	#0	16QAM	22.66	-2.8	17.71	38.45	PASS
Band26(824-849)	15	26965	1	#0	QPSK	24.00	-2.8	19.05	38.45	PASS
Band26(824-849)	15	26965	1	#Mid	QPSK	24.41	-2.8	19.46	38.45	PASS
Band26(824-849)	15	26965	1	#Max	QPSK	24.54	-2.8	19.59	38.45	PASS
Band26(824-849)	15	26965	36	#0	QPSK	23.78	-2.8	18.83	38.45	PASS
Band26(824-849)	15	26965	36	#Mid	QPSK	24.03	-2.8	19.08	38.45	PASS

Band26(824-849)	15	26965	36	#Max	QPSK	24.04	-2.8	19.09	38.45	PASS
Band26(824-849)	15	26965	75	#0	QPSK	24.02	-2.8	19.07	38.45	PASS
Band26(824-849)	15	26965	1	#0	16QAM	23.94	-2.8	18.99	38.45	PASS
Band26(824-849)	15	26965	1	#Mid	16QAM	23.87	-2.8	18.92	38.45	PASS
Band26(824-849)	15	26965	1	#Max	16QAM	24.10	-2.8	19.15	38.45	PASS
Band26(824-849)	15	26965	36	#0	16QAM	22.80	-2.8	17.85	38.45	PASS
Band26(824-849)	15	26965	36	#Mid	16QAM	22.89	-2.8	17.94	38.45	PASS
Band26(824-849)	15	26965	36	#Max	16QAM	22.58	-2.8	17.63	38.45	PASS
Band26(824-849)	15	26965	75	#0	16QAM	22.96	-2.8	18.01	38.45	PASS

Band	Bandwidth (MHz)	UL Channel	RB Size	RB Position	Modulation	Power (dBm)	Gain (dB)	EIRP (dBm)	EIRP Limit (dBm)	Verdict
Band66	1.4	131979	1	#0	QPSK	24.68	0.1	24.78	30	PASS
Band66	1.4	131979	1	#Mid	QPSK	24.63	0.1	24.73	30	PASS
Band66	1.4	131979	1	#Max	QPSK	24.61	0.1	24.71	30	PASS
Band66	1.4	131979	3	#0	QPSK	24.53	0.1	24.63	30	PASS
Band66	1.4	131979	3	#Mid	QPSK	24.43	0.1	24.53	30	PASS
Band66	1.4	131979	3	#Max	QPSK	24.56	0.1	24.66	30	PASS
Band66	1.4	131979	6	#0	QPSK	24.17	0.1	24.27	30	PASS
Band66	1.4	131979	1	#0	16QAM	24.60	0.1	24.70	30	PASS
Band66	1.4	131979	1	#Mid	16QAM	24.62	0.1	24.72	30	PASS
Band66	1.4	131979	1	#Max	16QAM	24.57	0.1	24.67	30	PASS
Band66	1.4	131979	3	#0	16QAM	23.86	0.1	23.96	30	PASS
Band66	1.4	131979	3	#Mid	16QAM	23.89	0.1	23.99	30	PASS
Band66	1.4	131979	3	#Max	16QAM	23.89	0.1	23.99	30	PASS
Band66	1.4	131979	6	#0	16QAM	22.83	0.1	22.93	30	PASS
Band66	1.4	132322	1	#0	QPSK	24.17	0.1	24.27	30	PASS
Band66	1.4	132322	1	#Mid	QPSK	24.19	0.1	24.29	30	PASS
Band66	1.4	132322	1	#Max	QPSK	24.27	0.1	24.37	30	PASS
Band66	1.4	132322	3	#0	QPSK	24.22	0.1	24.32	30	PASS
Band66	1.4	132322	3	#Mid	QPSK	24.18	0.1	24.28	30	PASS
Band66	1.4	132322	3	#Max	QPSK	24.22	0.1	24.32	30	PASS
Band66	1.4	132322	6	#0	QPSK	23.80	0.1	23.90	30	PASS
Band66	1.4	132322	1	#0	16QAM	23.33	0.1	23.43	30	PASS
Band66	1.4	132322	1	#Mid	16QAM	23.34	0.1	23.44	30	PASS
Band66	1.4	132322	1	#Max	16QAM	23.32	0.1	23.42	30	PASS
Band66	1.4	132322	3	#0	16QAM	23.01	0.1	23.11	30	PASS
Band66	1.4	132322	3	#Mid	16QAM	23.04	0.1	23.14	30	PASS
Band66	1.4	132322	3	#Max	16QAM	23.02	0.1	23.12	30	PASS
Band66	1.4	132322	6	#0	16QAM	22.43	0.1	22.53	30	PASS
Band66	1.4	132665	1	#0	QPSK	24.96	0.1	25.06	30	PASS
Band66	1.4	132665	1	#Mid	QPSK	24.88	0.1	24.98	30	PASS
Band66	1.4	132665	1	#Max	QPSK	24.93	0.1	25.03	30	PASS
Band66	1.4	132665	3	#0	QPSK	24.88	0.1	24.98	30	PASS
Band66	1.4	132665	3	#Mid	QPSK	24.93	0.1	25.03	30	PASS
Band66	1.4	132665	3	#Max	QPSK	24.84	0.1	24.94	30	PASS
Band66	1.4	132665	6	#0	QPSK	24.51	0.1	24.61	30	PASS
Band66	1.4	132665	1	#0	16QAM	24.18	0.1	24.28	30	PASS
Band66	1.4	132665	1	#Mid	16QAM	24.24	0.1	24.34	30	PASS
Band66	1.4	132665	1	#Max	16QAM	24.23	0.1	24.33	30	PASS
Band66	1.4	132665	3	#0	16QAM	24.28	0.1	24.38	30	PASS
Band66	1.4	132665	3	#Mid	16QAM	24.30	0.1	24.40	30	PASS
Band66	1.4	132665	3	#Max	16QAM	24.28	0.1	24.38	30	PASS
Band66	1.4	132665	6	#0	16QAM	23.18	0.1	23.28	30	PASS
Band66	3	131987	1	#0	QPSK	24.47	0.1	24.57	30	PASS
Band66	3	131987	1	#Mid	QPSK	24.46	0.1	24.56	30	PASS
Band66	3	131987	1	#Max	QPSK	24.52	0.1	24.62	30	PASS
Band66	3	131987	8	#0	QPSK	24.16	0.1	24.26	30	PASS
Band66	3	131987	8	#Mid	QPSK	24.11	0.1	24.21	30	PASS
Band66	3	131987	8	#Max	QPSK	24.12	0.1	24.22	30	PASS
Band66	3	131987	15	#0	QPSK	24.07	0.1	24.17	30	PASS
Band66	3	131987	1	#0	16QAM	24.69	0.1	24.79	30	PASS
Band66	3	131987	1	#Mid	16QAM	24.69	0.1	24.79	30	PASS
Band66	3	131987	1	#Max	16QAM	24.59	0.1	24.69	30	PASS
Band66	3	131987	8	#0	16QAM	22.60	0.1	22.70	30	PASS
Band66	3	131987	8	#Mid	16QAM	22.55	0.1	22.65	30	PASS
Band66	3	131987	8	#Max	16QAM	22.38	0.1	22.48	30	PASS
Band66	3	131987	15	#0	16QAM	22.77	0.1	22.87	30	PASS
Band66	3	132322	1	#0	QPSK	24.25	0.1	24.35	30	PASS
Band66	3	132322	1	#Mid	QPSK	24.18	0.1	24.28	30	PASS
Band66	3	132322	1	#Max	QPSK	24.21	0.1	24.31	30	PASS
Band66	3	132322	8	#0	QPSK	23.77	0.1	23.87	30	PASS
Band66	3	132322	8	#Mid	QPSK	23.81	0.1	23.91	30	PASS
Band66	3	132322	8	#Max	QPSK	23.78	0.1	23.88	30	PASS
Band66	3	132322	15	#0	QPSK	23.84	0.1	23.94	30	PASS
Band66	3	132322	1	#0	16QAM	23.38	0.1	23.48	30	PASS
Band66	3	132322	1	#Mid	16QAM	23.31	0.1	23.41	30	PASS

Band66	3	132322	1	#Max	16QAM	23.26	0.1	23.36	30	PASS
Band66	3	132322	8	#0	16QAM	22.38	0.1	22.48	30	PASS
Band66	3	132322	8	#Mid	16QAM	22.42	0.1	22.52	30	PASS
Band66	3	132322	8	#Max	16QAM	22.39	0.1	22.49	30	PASS
Band66	3	132322	15	#0	16QAM	22.36	0.1	22.46	30	PASS
Band66	3	132657	1	#0	QPSK	24.92	0.1	25.02	30	PASS
Band66	3	132657	1	#Mid	QPSK	24.90	0.1	25.00	30	PASS
Band66	3	132657	1	#Max	QPSK	24.94	0.1	25.04	30	PASS
Band66	3	132657	8	#0	QPSK	24.52	0.1	24.62	30	PASS
Band66	3	132657	8	#Mid	QPSK	24.35	0.1	24.45	30	PASS
Band66	3	132657	8	#Max	QPSK	24.41	0.1	24.51	30	PASS
Band66	3	132657	15	#0	QPSK	24.43	0.1	24.53	30	PASS
Band66	3	132657	1	#0	16QAM	24.28	0.1	24.38	30	PASS
Band66	3	132657	1	#Mid	16QAM	24.23	0.1	24.33	30	PASS
Band66	3	132657	1	#Max	16QAM	24.23	0.1	24.33	30	PASS
Band66	3	132657	8	#0	16QAM	23.00	0.1	23.10	30	PASS
Band66	3	132657	8	#Mid	16QAM	22.96	0.1	23.06	30	PASS
Band66	3	132657	8	#Max	16QAM	22.92	0.1	23.02	30	PASS
Band66	3	132657	15	#0	16QAM	23.00	0.1	23.10	30	PASS
Band66	5	131997	1	#0	QPSK	24.44	0.1	24.54	30	PASS
Band66	5	131997	1	#Mid	QPSK	24.42	0.1	24.52	30	PASS
Band66	5	131997	1	#Max	QPSK	24.46	0.1	24.56	30	PASS
Band66	5	131997	12	#0	QPSK	24.19	0.1	24.29	30	PASS
Band66	5	131997	12	#Mid	QPSK	23.93	0.1	24.03	30	PASS
Band66	5	131997	12	#Max	QPSK	24.11	0.1	24.21	30	PASS
Band66	5	131997	25	#0	QPSK	24.05	0.1	24.15	30	PASS
Band66	5	131997	1	#0	16QAM	23.81	0.1	23.91	30	PASS
Band66	5	131997	1	#Mid	16QAM	23.67	0.1	23.77	30	PASS
Band66	5	131997	1	#Max	16QAM	23.71	0.1	23.81	30	PASS
Band66	5	131997	12	#0	16QAM	22.48	0.1	22.58	30	PASS
Band66	5	131997	12	#Mid	16QAM	22.40	0.1	22.50	30	PASS
Band66	5	131997	12	#Max	16QAM	22.36	0.1	22.46	30	PASS
Band66	5	131997	25	#0	16QAM	22.55	0.1	22.65	30	PASS
Band66	5	132322	1	#0	QPSK	24.25	0.1	24.35	30	PASS
Band66	5	132322	1	#Mid	QPSK	24.28	0.1	24.38	30	PASS
Band66	5	132322	1	#Max	QPSK	24.17	0.1	24.27	30	PASS
Band66	5	132322	12	#0	QPSK	23.68	0.1	23.78	30	PASS
Band66	5	132322	12	#Mid	QPSK	23.82	0.1	23.92	30	PASS
Band66	5	132322	12	#Max	QPSK	23.69	0.1	23.79	30	PASS
Band66	5	132322	25	#0	QPSK	23.71	0.1	23.81	30	PASS
Band66	5	132322	1	#0	16QAM	22.97	0.1	23.07	30	PASS
Band66	5	132322	1	#Mid	16QAM	22.96	0.1	23.06	30	PASS
Band66	5	132322	1	#Max	16QAM	22.93	0.1	23.03	30	PASS
Band66	5	132322	12	#0	16QAM	22.13	0.1	22.23	30	PASS
Band66	5	132322	12	#Mid	16QAM	22.13	0.1	22.23	30	PASS
Band66	5	132322	12	#Max	16QAM	22.15	0.1	22.25	30	PASS
Band66	5	132322	25	#0	16QAM	22.31	0.1	22.41	30	PASS
Band66	5	132647	1	#0	QPSK	24.86	0.1	24.96	30	PASS
Band66	5	132647	1	#Mid	QPSK	24.91	0.1	25.01	30	PASS
Band66	5	132647	1	#Max	QPSK	24.87	0.1	24.97	30	PASS
Band66	5	132647	12	#0	QPSK	24.47	0.1	24.57	30	PASS
Band66	5	132647	12	#Mid	QPSK	24.55	0.1	24.65	30	PASS
Band66	5	132647	12	#Max	QPSK	24.45	0.1	24.55	30	PASS
Band66	5	132647	25	#0	QPSK	24.42	0.1	24.52	30	PASS
Band66	5	132647	1	#0	16QAM	23.83	0.1	23.93	30	PASS
Band66	5	132647	1	#Mid	16QAM	23.90	0.1	24.00	30	PASS
Band66	5	132647	1	#Max	16QAM	23.82	0.1	23.92	30	PASS
Band66	5	132647	12	#0	16QAM	22.99	0.1	23.09	30	PASS
Band66	5	132647	12	#Mid	16QAM	22.97	0.1	23.07	30	PASS
Band66	5	132647	12	#Max	16QAM	22.97	0.1	23.07	30	PASS
Band66	5	132647	25	#0	16QAM	22.98	0.1	23.08	30	PASS
Band66	10	132022	1	#0	QPSK	24.59	0.1	24.69	30	PASS
Band66	10	132022	1	#Mid	QPSK	24.51	0.1	24.61	30	PASS
Band66	10	132022	1	#Max	QPSK	24.47	0.1	24.57	30	PASS
Band66	10	132022	25	#0	QPSK	24.14	0.1	24.24	30	PASS
Band66	10	132022	25	#Mid	QPSK	24.13	0.1	24.23	30	PASS
Band66	10	132022	25	#Max	QPSK	24.07	0.1	24.17	30	PASS
Band66	10	132022	50	#0	QPSK	24.15	0.1	24.25	30	PASS

Band66	10	132022	1	#0	16QAM	24.67	0.1	24.77	30	PASS
Band66	10	132022	1	#Mid	16QAM	24.66	0.1	24.76	30	PASS
Band66	10	132022	1	#Max	16QAM	24.58	0.1	24.68	30	PASS
Band66	10	132022	25	#0	16QAM	22.56	0.1	22.66	30	PASS
Band66	10	132022	25	#Mid	16QAM	22.58	0.1	22.68	30	PASS
Band66	10	132022	25	#Max	16QAM	22.59	0.1	22.69	30	PASS
Band66	10	132022	50	#0	16QAM	22.64	0.1	22.74	30	PASS
Band66	10	132322	1	#0	QPSK	24.36	0.1	24.46	30	PASS
Band66	10	132322	1	#Mid	QPSK	24.24	0.1	24.34	30	PASS
Band66	10	132322	1	#Max	QPSK	24.28	0.1	24.38	30	PASS
Band66	10	132322	25	#0	QPSK	23.84	0.1	23.94	30	PASS
Band66	10	132322	25	#Mid	QPSK	23.87	0.1	23.97	30	PASS
Band66	10	132322	25	#Max	QPSK	23.78	0.1	23.88	30	PASS
Band66	10	132322	50	#0	QPSK	23.82	0.1	23.92	30	PASS
Band66	10	132322	1	#0	16QAM	23.96	0.1	24.06	30	PASS
Band66	10	132322	1	#Mid	16QAM	23.90	0.1	24.00	30	PASS
Band66	10	132322	1	#Max	16QAM	23.85	0.1	23.95	30	PASS
Band66	10	132322	25	#0	16QAM	22.37	0.1	22.47	30	PASS
Band66	10	132322	25	#Mid	16QAM	22.36	0.1	22.46	30	PASS
Band66	10	132322	25	#Max	16QAM	22.37	0.1	22.47	30	PASS
Band66	10	132322	50	#0	16QAM	22.33	0.1	22.43	30	PASS
Band66	10	132622	1	#0	QPSK	24.74	0.1	24.84	30	PASS
Band66	10	132622	1	#Mid	QPSK	24.90	0.1	25.00	30	PASS
Band66	10	132622	1	#Max	QPSK	25.09	0.1	25.19	30	PASS
Band66	10	132622	25	#0	QPSK	24.37	0.1	24.47	30	PASS
Band66	10	132622	25	#Mid	QPSK	24.33	0.1	24.43	30	PASS
Band66	10	132622	25	#Max	QPSK	24.47	0.1	24.57	30	PASS
Band66	10	132622	50	#0	QPSK	24.40	0.1	24.50	30	PASS
Band66	10	132622	1	#0	16QAM	23.70	0.1	23.80	30	PASS
Band66	10	132622	1	#Mid	16QAM	23.84	0.1	23.94	30	PASS
Band66	10	132622	1	#Max	16QAM	23.87	0.1	23.97	30	PASS
Band66	10	132622	25	#0	16QAM	22.91	0.1	23.01	30	PASS
Band66	10	132622	25	#Mid	16QAM	22.93	0.1	23.03	30	PASS
Band66	10	132622	25	#Max	16QAM	23.04	0.1	23.14	30	PASS
Band66	10	132622	50	#0	16QAM	22.91	0.1	23.01	30	PASS
Band66	15	132047	1	#0	QPSK	24.55	0.1	24.65	30	PASS
Band66	15	132047	1	#Mid	QPSK	24.43	0.1	24.53	30	PASS
Band66	15	132047	1	#Max	QPSK	24.43	0.1	24.53	30	PASS
Band66	15	132047	36	#0	QPSK	23.93	0.1	24.03	30	PASS
Band66	15	132047	36	#Mid	QPSK	24.03	0.1	24.13	30	PASS
Band66	15	132047	36	#Max	QPSK	24.05	0.1	24.15	30	PASS
Band66	15	132047	75	#0	QPSK	23.97	0.1	24.07	30	PASS
Band66	15	132047	1	#0	16QAM	24.77	0.1	24.87	30	PASS
Band66	15	132047	1	#Mid	16QAM	24.64	0.1	24.74	30	PASS
Band66	15	132047	1	#Max	16QAM	24.58	0.1	24.68	30	PASS
Band66	15	132047	36	#0	16QAM	22.55	0.1	22.65	30	PASS
Band66	15	132047	36	#Mid	16QAM	22.50	0.1	22.60	30	PASS
Band66	15	132047	36	#Max	16QAM	22.50	0.1	22.60	30	PASS
Band66	15	132047	75	#0	16QAM	22.58	0.1	22.68	30	PASS
Band66	15	132322	1	#0	QPSK	24.43	0.1	24.53	30	PASS
Band66	15	132322	1	#Mid	QPSK	24.34	0.1	24.44	30	PASS
Band66	15	132322	1	#Max	QPSK	24.26	0.1	24.36	30	PASS
Band66	15	132322	36	#0	QPSK	23.90	0.1	24.00	30	PASS
Band66	15	132322	36	#Mid	QPSK	23.85	0.1	23.95	30	PASS
Band66	15	132322	36	#Max	QPSK	23.62	0.1	23.72	30	PASS
Band66	15	132322	75	#0	QPSK	23.75	0.1	23.85	30	PASS
Band66	15	132322	1	#0	16QAM	23.29	0.1	23.39	30	PASS
Band66	15	132322	1	#Mid	16QAM	23.15	0.1	23.25	30	PASS
Band66	15	132322	1	#Max	16QAM	23.10	0.1	23.20	30	PASS
Band66	15	132322	36	#0	16QAM	22.51	0.1	22.61	30	PASS
Band66	15	132322	36	#Mid	16QAM	22.36	0.1	22.46	30	PASS
Band66	15	132322	36	#Max	16QAM	22.36	0.1	22.46	30	PASS
Band66	15	132322	75	#0	16QAM	22.23	0.1	22.33	30	PASS
Band66	15	132597	1	#0	QPSK	24.48	0.1	24.58	30	PASS
Band66	15	132597	1	#Mid	QPSK	24.75	0.1	24.85	30	PASS
Band66	15	132597	1	#Max	QPSK	25.01	0.1	25.11	30	PASS
Band66	15	132597	36	#0	QPSK	24.13	0.1	24.23	30	PASS
Band66	15	132597	36	#Mid	QPSK	24.32	0.1	24.42	30	PASS

Band66	15	132597	36	#Max	QPSK	24.41	0.1	24.51	30	PASS
Band66	15	132597	75	#0	QPSK	24.23	0.1	24.33	30	PASS
Band66	15	132597	1	#0	16QAM	24.07	0.1	24.17	30	PASS
Band66	15	132597	1	#Mid	16QAM	24.47	0.1	24.57	30	PASS
Band66	15	132597	1	#Max	16QAM	24.61	0.1	24.71	30	PASS
Band66	15	132597	36	#0	16QAM	22.66	0.1	22.76	30	PASS
Band66	15	132597	36	#Mid	16QAM	22.82	0.1	22.92	30	PASS
Band66	15	132597	36	#Max	16QAM	23.01	0.1	23.11	30	PASS
Band66	15	132597	75	#0	16QAM	22.92	0.1	23.02	30	PASS
Band66	20	132072	1	#0	QPSK	25.14	0.1	25.24	30	PASS
Band66	20	132072	1	#Mid	QPSK	25.07	0.1	25.17	30	PASS
Band66	20	132072	1	#Max	QPSK	25.08	0.1	25.18	30	PASS
Band66	20	132072	50	#0	QPSK	24.47	0.1	24.57	30	PASS
Band66	20	132072	50	#Mid	QPSK	24.53	0.1	24.63	30	PASS
Band66	20	132072	50	#Max	QPSK	24.40	0.1	24.50	30	PASS
Band66	20	132072	100	#0	QPSK	24.43	0.1	24.53	30	PASS
Band66	20	132072	1	#0	16QAM	24.22	0.1	24.32	30	PASS
Band66	20	132072	1	#Mid	16QAM	24.09	0.1	24.19	30	PASS
Band66	20	132072	1	#Max	16QAM	24.08	0.1	24.18	30	PASS
Band66	20	132072	50	#0	16QAM	23.18	0.1	23.28	30	PASS
Band66	20	132072	50	#Mid	16QAM	23.05	0.1	23.15	30	PASS
Band66	20	132072	50	#Max	16QAM	23.13	0.1	23.23	30	PASS
Band66	20	132072	100	#0	16QAM	22.95	0.1	23.05	30	PASS
Band66	20	132322	1	#0	QPSK	25.23	0.1	25.33	30	PASS
Band66	20	132322	1	#Mid	QPSK	25.16	0.1	25.26	30	PASS
Band66	20	132322	1	#Max	QPSK	25.07	0.1	25.17	30	PASS
Band66	20	132322	50	#0	QPSK	24.42	0.1	24.52	30	PASS
Band66	20	132322	50	#Mid	QPSK	24.29	0.1	24.39	30	PASS
Band66	20	132322	50	#Max	QPSK	24.20	0.1	24.30	30	PASS
Band66	20	132322	100	#0	QPSK	24.32	0.1	24.42	30	PASS
Band66	20	132322	1	#0	16QAM	23.43	0.1	23.53	30	PASS
Band66	20	132322	1	#Mid	16QAM	23.38	0.1	23.48	30	PASS
Band66	20	132322	1	#Max	16QAM	23.31	0.1	23.41	30	PASS
Band66	20	132322	50	#0	16QAM	22.93	0.1	23.03	30	PASS
Band66	20	132322	50	#Mid	16QAM	22.84	0.1	22.94	30	PASS
Band66	20	132322	50	#Max	16QAM	22.80	0.1	22.90	30	PASS
Band66	20	132322	100	#0	16QAM	22.76	0.1	22.86	30	PASS
Band66	20	132572	1	#0	QPSK	24.82	0.1	24.92	30	PASS
Band66	20	132572	1	#Mid	QPSK	25.20	0.1	25.30	30	PASS
Band66	20	132572	1	#Max	QPSK	25.51	0.1	25.61	30	PASS
Band66	20	132572	50	#0	QPSK	24.47	0.1	24.57	30	PASS
Band66	20	132572	50	#Mid	QPSK	24.71	0.1	24.81	30	PASS
Band66	20	132572	50	#Max	QPSK	24.84	0.1	24.94	30	PASS
Band66	20	132572	100	#0	QPSK	24.56	0.1	24.66	30	PASS
Band66	20	132572	1	#0	16QAM	24.07	0.1	24.17	30	PASS
Band66	20	132572	1	#Mid	16QAM	24.42	0.1	24.52	30	PASS
Band66	20	132572	1	#Max	16QAM	24.75	0.1	24.85	30	PASS
Band66	20	132572	50	#0	16QAM	22.95	0.1	23.05	30	PASS
Band66	20	132572	50	#Mid	16QAM	23.22	0.1	23.32	30	PASS
Band66	20	132572	50	#Max	16QAM	23.46	0.1	23.56	30	PASS
Band66	20	132572	100	#0	16QAM	23.16	0.1	23.26	30	PASS

Frequency stability

LTE Band 2 (QPSK) / 1880MHz / BW20M					
Temperature (°C)	Voltage (Volt)	Freq. Dev. (Hz)	Freq. Dev. (ppm)	Limit	Result
	50	Normal Voltage	-7.90		
40	-7.52		-0.004		
30	-7.54		-0.004		
20	13.70		0.007		
10	7.48		0.004		
0	-7.49		-0.004		
-10	-7.70		-0.004		
-20	7.61		0.004		
-30	7.77		0.004		
20	Maximum Voltage		11.64	0.006	
20	BEP	-3.94	-0.002		

LTE Band 2 (16QAM) / 1880MHz / BW20M					
Temperature (°C)	Voltage (Volt)	Freq. Dev. (Hz)	Freq. Dev. (ppm)	Limit	Result
	50	Normal Voltage	9.41		
40	9.52		0.005		
30	9.52		0.005		
20	17.32		0.009		
10	9.43		0.005		
0	9.37		0.005		
-10	9.33		0.005		
-20	-9.33		-0.005		
-30	9.52		0.005		
20	Maximum Voltage		14.57	0.008	
20	BEP	-4.62	-0.002		

LTE Band 4 (QPSK) / 1733MHz / BW20M					
Temperature (°C)	Voltage (Volt)	Freq. Dev. (Hz)	Freq. Dev. (ppm)	Limit	Result
	50	Normal Voltage	0.01		
40	0.27		0.000		
30	0.26		0.000		
20	-2.07		-0.001		
10	0.37		0.000		
0	0.08		0.000		
-10	-0.12		0.000		
-20	-0.37		0.000		
-30	-0.43		0.000		
20	Maximum Voltage		-0.32	0.000	
20	BEP	0.03	0.000		

LTE Band 4 (16QAM) / 1733MHz / BW20M					
Temperature (°C)	Voltage (Volt)	Freq. Dev. (Hz)	Freq. Dev. (ppm)	Limit	Result
	50	Normal Voltage	2.18		
40	1.98		0.001		
30	1.99		0.001		
20	-6.14		-0.004		
10	-2.51		-0.001		
0	2.22		0.001		
-10	2.24		0.001		
-20	-2.15		-0.001		
-30	-2.52		-0.001		
20	Maximum Voltage		-2.97	-0.002	
20	BEP	-3.54	-0.002		

LTE Band 5 (QPSK) / 836.5MHz / BW10M					
Temperature (°C)	Voltage (Volt)	Freq. Dev. (Hz)	Freq. Dev. (ppm)	Limit	Result
	50	Normal Voltage	-9.48		
40	-9.38		-0.011		
30	-9.52		-0.011		
20	16.91		0.020		
10	9.45		0.011		
0	-9.09		-0.011		
-10	9.33		0.011		
-20	9.31		0.011		
-30	-9.52		-0.011		
20	Maximum Voltage		-4.59	-0.005	
20	BEP	13.69	0.016		

LTE Band 5 (16QAM) / 836.5MHz / BW10M					
Temperature (°C)	Voltage (Volt)	Freq. Dev. (Hz)	Freq. Dev. (ppm)	Limit	Result
	50	Normal Voltage	12.32		
40	12.17		0.015		
30	-12.38		-0.015		
20	23.12		0.028		
10	12.28		0.015		
0	-12.25		-0.015		
-10	-12.35		-0.015		
-20	12.22		0.015		
-30	12.16		0.015		
20	Maximum Voltage		18.89	0.023	
20	BEP	-6.29	-0.008		

LTE Band 7 (QPSK) / 2535MHz / BW20M					
Temperature (°C)	Voltage (Volt)	Freq. Dev. (Hz)	Freq. Dev. (ppm)	Limit	Result
	50	Normal Voltage	-2.94		
40	2.85		0.001		
30	2.97		0.001		
20	4.32		0.002		
10	-3.05		-0.001		
0	-3.07		-0.001		
-10	-3.09		-0.001		
-20	3.26		0.001		
-30	-2.70		-0.001		
20	Maximum Voltage		4.87	0.002	
20	BEP	4.16	0.002		

LTE Band 7 (16QAM) / 2535MHz / BW20M					
Temperature (°C)	Voltage (Volt)	Freq. Dev. (Hz)	Freq. Dev. (ppm)	Limit	Result
	50	Normal Voltage	-9.25		
40	-9.31		-0.004		
30	-9.51		-0.004		
20	17.44		0.007		
10	9.33		0.004		
0	9.32		0.004		
-10	-9.54		-0.004		
-20	-9.64		-0.004		
-30	-9.66		-0.004		
20	Maximum Voltage		-4.69	-0.002	
20	BEP	13.92	0.005		

LTE Band 12 (QPSK) / 707.5MHz / BW10M					
Temperature (°C)	Voltage (Volt)	Freq. Dev. (Hz)	Freq. Dev. (ppm)	Limit	Result
	50	Normal Voltage	3.53		
40	3.50		0.005		
30	3.09		0.004		
20	4.94		0.007		
10	-3.32		-0.005		
0	-3.27		-0.005		
-10	-3.00		-0.004		
-20	3.19		0.005		
-30	-3.17		-0.004		
20	Maximum Voltage		-1.77	-0.002	
20	BEP	4.96	0.007		

LTE Band 12 (16QAM) / 707.5MHz / BW10M					
Temperature (°C)	Voltage (Volt)	Freq. Dev. (Hz)	Freq. Dev. (ppm)	Limit	Result
	50	Normal Voltage	3.09		
40	-3.03		-0.004		
30	2.94		0.004		
20	4.49		0.006		
10	3.08		0.004		
0	-3.01		-0.004		
-10	3.01		0.004		
-20	-2.89		-0.004		
-30	3.09		0.004		
20	Maximum Voltage		-1.68	-0.002	
20	BEP	4.58	0.006		

LTE Band 17 (QPSK) / 710MHz / BW10M					
Temperature (°C)	Voltage (Volt)	Freq. Dev. (Hz)	Freq. Dev. (ppm)	Limit	Result
	50	Normal Voltage	1.52		
40	1.68		0.002		
30	-1.57		-0.002		
20	1.95		0.003		
10	-1.88		-0.003		
0	1.80		0.003		
-10	1.74		0.002		
-20	-1.53		-0.002		
-30	-1.98		-0.003		
20	Maximum Voltage		-0.83	-0.001	
20	BEP	2.31	0.003		

LTE Band 17 (16QAM) / 710MHz / BW10M					
Temperature (°C)	Voltage (Volt)	Freq. Dev. (Hz)	Freq. Dev. (ppm)	Limit	Result
	50	Normal Voltage	2.75		
40	-2.52		-0.004		
30	2.88		0.004		
20	3.75		0.005		
10	-2.82		-0.004		
0	2.78		0.004		
-10	-2.53		-0.004		
-20	-2.64		-0.004		
-30	-2.81		-0.004		
20	Maximum Voltage		3.76	0.005	
20	BEP	-1.36	-0.002		

LTE Band 25 (QPSK) / 1882.5MHz / BW20M					
Temperature (°C)	Voltage (Volt)	Freq. Dev. (Hz)	Freq. Dev. (ppm)	Limit	Result
	50	Normal Voltage	0.23		
40	-0.31		0.000		
30	-0.60		0.000		
20	-0.62		0.000		
10	0.31		0.000		
0	0.76		0.000		
-10	0.74		0.000		
-20	-0.22		0.000		
-30	-0.38		0.000		
20	Maximum Voltage		0.91	0.000	
20	BEP	1.06	0.001		

LTE Band 25 (16QAM) / 1882.5MHz / BW20M					
Temperature (°C)	Voltage (Volt)	Freq. Dev. (Hz)	Freq. Dev. (ppm)	Limit	Result
	50	Normal Voltage	-6.16		
40	5.91		0.003		
30	5.94		0.003		
20	10.53		0.006		
10	-6.06		-0.003		
0	5.99		0.003		
-10	5.87		0.003		
-20	6.25		0.003		
-30	6.07		0.003		
20	Maximum Voltage		-3.14	-0.002	
20	BEP	-3.08	-0.002		

LTE Band 26 (QPSK) / 819MHz / BW10M					
Temperature (°C)	Voltage (Volt)	Freq. Dev. (Hz)	Freq. Dev. (ppm)	Limit	Result
	50	Normal Voltage	-6.42		
40	-6.62		-0.008		
30	6.74		0.008		
20	-14.96		-0.018		
10	-6.54		-0.008		
0	6.37		0.008		
-10	6.51		0.008		
-20	6.55		0.008		
-30	6.41		0.008		
20	Maximum Voltage		3.30	0.004	
20	BEP	-10.09	-0.012		

LTE Band 26 (16QAM) / 819MHz / BW10M					
Temperature (°C)	Voltage (Volt)	Freq. Dev. (Hz)	Freq. Dev. (ppm)	Limit	Result
	50	Normal Voltage	-8.05		
40	8.33		0.010		
30	8.34		0.010		
20	-18.12		-0.022		
10	7.97		0.010		
0	8.17		0.010		
-10	-8.11		-0.010		
-20	-8.31		-0.010		
-30	8.03		0.010		
20	Maximum Voltage		4.22	0.005	
20	BEP	4.00	0.005		

LTE Band 26 (QPSK) / 836.5MHz / BW15M					
Temperature (°C)	Voltage (Volt)	Freq. Dev. (Hz)	Freq. Dev. (ppm)	Limit	Result
	50	Normal Voltage	-4.97		
40	4.87		0.006		
30	4.65		0.006		
20	-11.32		-0.014		
10	4.73		0.006		
0	-4.84		-0.006		
-10	-4.81		-0.006		
-20	-4.75		-0.006		
-30	-4.71		-0.006		
20	Maximum Voltage		2.50	0.003	
20	BEP	2.43	0.003		

LTE Band 26 (16QAM) / 836.5MHz / BW15M					
Temperature (°C)	Voltage (Volt)	Freq. Dev. (Hz)	Freq. Dev. (ppm)	Limit	Result
	50	Normal Voltage	-10.27		
40	10.30		0.012		
30	10.36		0.012		
20	-22.79		-0.027		
10	-10.44		-0.012		
0	-10.64		-0.013		
-10	-10.65		-0.013		
-20	-10.28		-0.012		
-30	-10.34		-0.012		
20	Maximum Voltage		5.26	0.006	
20	BEP	5.43	0.006		

LTE Band 66 (QPSK) / 1745MHz / BW20M					
Temperature (°C)	Voltage (Volt)	Freq. Dev. (Hz)	Freq. Dev. (ppm)	Limit	Result
	50	Normal Voltage	-6.57		
40	-6.95		-0.004		
30	-6.63		-0.004		
20	12.06		0.007		
10	6.56		0.004		
0	-6.67		-0.004		
-10	-6.94		-0.004		
-20	6.68		0.004		
-30	6.64		0.004		
20	Maximum Voltage		9.94	0.006	
20	BEP	10.49	0.006		

LTE Band 66 (16QAM) / 1745MHz / BW20M					
Temperature (°C)	Voltage (Volt)	Freq. Dev. (Hz)	Freq. Dev. (ppm)	Limit	Result
	50	Normal Voltage	-15.82		
40	15.42		0.009		
30	-15.66		-0.009		
20	29.63		0.017		
10	15.39		0.009		
0	-15.55		-0.009		
-10	15.90		0.009		
-20	15.35		0.009		
-30	-15.45		-0.009		
20	Maximum Voltage		23.46	0.013	
20	BEP	-7.77	-0.004		

Peak-to-Average Ratio

Band	Bandwidth (MHz)	UL Channel	RB Size	RB Position	Modulation	Result (dB)	high Limit (dB)	Verdict
Band2	1.4	18607	1	#0	QPSK	4.01	13	PASS
Band2	1.4	18607	1	#0	16QAM	4.85	13	PASS
Band2	1.4	18900	1	#0	QPSK	5.18	13	PASS
Band2	1.4	18900	1	#0	16QAM	5.61	13	PASS
Band2	1.4	19193	1	#0	QPSK	4.97	13	PASS
Band2	1.4	19193	1	#0	16QAM	5.56	13	PASS
Band2	3	18615	1	#0	QPSK	3.96	13	PASS
Band2	3	18615	1	#0	16QAM	5.02	13	PASS
Band2	3	18900	1	#0	QPSK	5.31	13	PASS
Band2	3	18900	1	#0	16QAM	6.25	13	PASS
Band2	3	19185	1	#0	QPSK	5.35	13	PASS
Band2	3	19185	1	#0	16QAM	5.99	13	PASS
Band2	5	18625	1	#0	QPSK	4.00	13	PASS
Band2	5	18625	1	#0	16QAM	5.21	13	PASS
Band2	5	18900	1	#0	QPSK	5.40	13	PASS
Band2	5	18900	1	#0	16QAM	5.96	13	PASS
Band2	5	19175	1	#0	QPSK	6.00	13	PASS
Band2	5	19175	1	#0	16QAM	6.28	13	PASS
Band2	10	18650	1	#0	QPSK	3.88	13	PASS
Band2	10	18650	1	#0	16QAM	4.87	13	PASS
Band2	10	18900	1	#0	QPSK	5.80	13	PASS
Band2	10	18900	1	#0	16QAM	6.66	13	PASS
Band2	10	19150	1	#0	QPSK	5.40	13	PASS
Band2	10	19150	1	#0	16QAM	6.21	13	PASS
Band2	15	18675	1	#0	QPSK	3.86	13	PASS
Band2	15	18675	1	#0	16QAM	4.84	13	PASS
Band2	15	18900	1	#0	QPSK	5.86	13	PASS
Band2	15	18900	1	#0	16QAM	6.80	13	PASS
Band2	15	19125	1	#0	QPSK	5.31	13	PASS
Band2	15	19125	1	#0	16QAM	5.92	13	PASS
Band2	20	18700	1	#0	QPSK	3.62	13	PASS
Band2	20	18700	1	#0	16QAM	4.49	13	PASS
Band2	20	18900	1	#0	QPSK	5.77	13	PASS
Band2	20	18900	1	#0	16QAM	6.58	13	PASS
Band2	20	19100	1	#0	QPSK	5.58	13	PASS
Band2	20	19100	1	#0	16QAM	6.62	13	PASS
Band4	1.4	19957	1	#0	QPSK	4.14	13	PASS
Band4	1.4	19957	1	#0	16QAM	4.42	13	PASS
Band4	1.4	20175	1	#0	QPSK	4.70	13	PASS
Band4	1.4	20175	1	#0	16QAM	5.65	13	PASS
Band4	1.4	20393	1	#0	QPSK	4.69	13	PASS
Band4	1.4	20393	1	#0	16QAM	5.52	13	PASS
Band4	3	19965	1	#0	QPSK	4.01	13	PASS
Band4	3	19965	1	#0	16QAM	4.93	13	PASS
Band4	3	20175	1	#0	QPSK	4.75	13	PASS
Band4	3	20175	1	#0	16QAM	5.35	13	PASS
Band4	3	20385	1	#0	QPSK	4.73	13	PASS
Band4	3	20385	1	#0	16QAM	5.59	13	PASS
Band4	5	19975	1	#0	QPSK	4.15	13	PASS
Band4	5	19975	1	#0	16QAM	5.26	13	PASS
Band4	5	20175	1	#0	QPSK	4.67	13	PASS
Band4	5	20175	1	#0	16QAM	5.34	13	PASS
Band4	5	20375	1	#0	QPSK	4.77	13	PASS
Band4	5	20375	1	#0	16QAM	5.61	13	PASS
Band4	10	20000	1	#0	QPSK	4.13	13	PASS
Band4	10	20000	1	#0	16QAM	4.99	13	PASS
Band4	10	20175	1	#0	QPSK	4.50	13	PASS
Band4	10	20175	1	#0	16QAM	5.54	13	PASS
Band4	10	20350	1	#0	QPSK	4.03	13	PASS
Band4	10	20350	1	#0	16QAM	5.13	13	PASS
Band4	15	20025	1	#0	QPSK	4.25	13	PASS
Band4	15	20025	1	#0	16QAM	5.14	13	PASS
Band4	15	20175	1	#0	QPSK	4.46	13	PASS
Band4	15	20175	1	#0	16QAM	5.50	13	PASS

Band4	15	20325	1	#0	QPSK	4.33	13	PASS
Band4	15	20325	1	#0	16QAM	5.15	13	PASS
Band4	20	20050	1	#0	QPSK	4.22	13	PASS
Band4	20	20050	1	#0	16QAM	5.02	13	PASS
Band4	20	20175	1	#0	QPSK	4.65	13	PASS
Band4	20	20175	1	#0	16QAM	5.50	13	PASS
Band4	20	20300	1	#0	QPSK	4.67	13	PASS
Band4	20	20300	1	#0	16QAM	5.61	13	PASS
Band5	1.4	20407	1	#0	QPSK	6.02	13	PASS
Band5	1.4	20407	1	#0	16QAM	6.52	13	PASS
Band5	1.4	20525	1	#0	QPSK	6.08	13	PASS
Band5	1.4	20525	1	#0	16QAM	6.90	13	PASS
Band5	1.4	20643	1	#0	QPSK	4.56	13	PASS
Band5	1.4	20643	1	#0	16QAM	5.49	13	PASS
Band5	3	20415	1	#0	QPSK	5.85	13	PASS
Band5	3	20415	1	#0	16QAM	6.91	13	PASS
Band5	3	20525	1	#0	QPSK	5.84	13	PASS
Band5	3	20525	1	#0	16QAM	6.75	13	PASS
Band5	3	20635	1	#0	QPSK	4.80	13	PASS
Band5	3	20635	1	#0	16QAM	5.66	13	PASS
Band5	5	20425	1	#0	QPSK	6.27	13	PASS
Band5	5	20425	1	#0	16QAM	6.55	13	PASS
Band5	5	20525	1	#0	QPSK	5.67	13	PASS
Band5	5	20525	1	#0	16QAM	6.02	13	PASS
Band5	5	20625	1	#0	QPSK	4.48	13	PASS
Band5	5	20625	1	#0	16QAM	5.36	13	PASS
Band5	10	20450	1	#0	QPSK	5.84	13	PASS
Band5	10	20450	1	#0	16QAM	6.62	13	PASS
Band5	10	20525	1	#0	QPSK	4.99	13	PASS
Band5	10	20525	1	#0	16QAM	6.15	13	PASS
Band5	10	20600	1	#0	QPSK	4.77	13	PASS
Band5	10	20600	1	#0	16QAM	5.57	13	PASS
Band7	5	20775	1	#0	QPSK	5.70	13	PASS
Band7	5	20775	1	#0	16QAM	6.31	13	PASS
Band7	5	21100	1	#0	QPSK	4.47	13	PASS
Band7	5	21100	1	#0	16QAM	5.31	13	PASS
Band7	5	21425	1	#0	QPSK	3.91	13	PASS
Band7	5	21425	1	#0	16QAM	4.87	13	PASS
Band7	10	20800	1	#0	QPSK	5.46	13	PASS
Band7	10	20800	1	#0	16QAM	6.45	13	PASS
Band7	10	21100	1	#0	QPSK	4.95	13	PASS
Band7	10	21100	1	#0	16QAM	5.93	13	PASS
Band7	10	21400	1	#0	QPSK	4.89	13	PASS
Band7	10	21400	1	#0	16QAM	5.64	13	PASS
Band7	15	20825	1	#0	QPSK	5.35	13	PASS
Band7	15	20825	1	#0	16QAM	6.25	13	PASS
Band7	15	21100	1	#0	QPSK	5.35	13	PASS
Band7	15	21100	1	#0	16QAM	6.33	13	PASS
Band7	15	21375	1	#0	QPSK	5.31	13	PASS
Band7	15	21375	1	#0	16QAM	5.80	13	PASS
Band7	20	20850	1	#0	QPSK	5.14	13	PASS
Band7	20	20850	1	#0	16QAM	5.81	13	PASS
Band7	20	21100	1	#0	QPSK	5.55	13	PASS
Band7	20	21100	1	#0	16QAM	6.32	13	PASS
Band7	20	21350	1	#0	QPSK	5.43	13	PASS
Band7	20	21350	1	#0	16QAM	6.25	13	PASS
Band12	1.4	23017	1	#0	QPSK	5.08	13	PASS
Band12	1.4	23017	1	#0	16QAM	5.63	13	PASS
Band12	1.4	23095	1	#0	QPSK	5.29	13	PASS
Band12	1.4	23095	1	#0	16QAM	6.31	13	PASS
Band12	1.4	23173	1	#0	QPSK	5.00	13	PASS
Band12	1.4	23173	1	#0	16QAM	5.99	13	PASS
Band12	3	23025	1	#0	QPSK	4.99	13	PASS
Band12	3	23025	1	#0	16QAM	6.18	13	PASS
Band12	3	23095	1	#0	QPSK	5.50	13	PASS
Band12	3	23095	1	#0	16QAM	6.06	13	PASS
Band12	3	23165	1	#0	QPSK	5.52	13	PASS
Band12	3	23165	1	#0	16QAM	6.27	13	PASS

Band12	5	23035	1	#0	QPSK	5.12	13	PASS
Band12	5	23035	1	#0	16QAM	6.17	13	PASS
Band12	5	23095	1	#0	QPSK	5.55	13	PASS
Band12	5	23095	1	#0	16QAM	5.95	13	PASS
Band12	5	23155	1	#0	QPSK	5.73	13	PASS
Band12	5	23155	1	#0	16QAM	6.37	13	PASS
Band12	10	23060	1	#0	QPSK	4.94	13	PASS
Band12	10	23060	1	#0	16QAM	6.17	13	PASS
Band12	10	23095	1	#0	QPSK	5.30	13	PASS
Band12	10	23095	1	#0	16QAM	6.44	13	PASS
Band12	10	23130	1	#0	QPSK	5.33	13	PASS
Band12	10	23130	1	#0	16QAM	5.89	13	PASS
Band17	5	23755	1	#0	QPSK	5.70	13	PASS
Band17	5	23755	1	#0	16QAM	6.40	13	PASS
Band17	5	23790	1	#0	QPSK	5.35	13	PASS
Band17	5	23790	1	#0	16QAM	5.94	13	PASS
Band17	5	23825	1	#0	QPSK	5.43	13	PASS
Band17	5	23825	1	#0	16QAM	6.08	13	PASS
Band17	10	23780	1	#0	QPSK	5.88	13	PASS
Band17	10	23780	1	#0	16QAM	6.58	13	PASS
Band17	10	23790	1	#0	QPSK	5.97	13	PASS
Band17	10	23790	1	#0	16QAM	6.56	13	PASS
Band17	10	23800	1	#0	QPSK	5.38	13	PASS
Band17	10	23800	1	#0	16QAM	6.06	13	PASS
Band25	1.4	26047	1	#0	QPSK	4.12	13	PASS
Band25	1.4	26047	1	#0	16QAM	5.11	13	PASS
Band25	1.4	26365	1	#0	QPSK	4.79	13	PASS
Band25	1.4	26365	1	#0	16QAM	5.40	13	PASS
Band25	1.4	26683	1	#0	QPSK	4.86	13	PASS
Band25	1.4	26683	1	#0	16QAM	5.46	13	PASS
Band25	3	26055	1	#0	QPSK	4.18	13	PASS
Band25	3	26055	1	#0	16QAM	5.13	13	PASS
Band25	3	26365	1	#0	QPSK	4.93	13	PASS
Band25	3	26365	1	#0	16QAM	5.75	13	PASS
Band25	3	26675	1	#0	QPSK	4.59	13	PASS
Band25	3	26675	1	#0	16QAM	5.32	13	PASS
Band25	5	26065	1	#0	QPSK	4.19	13	PASS
Band25	5	26065	1	#0	16QAM	5.32	13	PASS
Band25	5	26365	1	#0	QPSK	5.01	13	PASS
Band25	5	26365	1	#0	16QAM	5.50	13	PASS
Band25	5	26665	1	#0	QPSK	4.68	13	PASS
Band25	5	26665	1	#0	16QAM	5.57	13	PASS
Band25	10	26090	1	#0	QPSK	4.03	13	PASS
Band25	10	26090	1	#0	16QAM	4.94	13	PASS
Band25	10	26365	1	#0	QPSK	5.40	13	PASS
Band25	10	26365	1	#0	16QAM	6.51	13	PASS
Band25	10	26640	1	#0	QPSK	5.68	13	PASS
Band25	10	26640	1	#0	16QAM	6.17	13	PASS
Band25	15	26115	1	#0	QPSK	3.96	13	PASS
Band25	15	26115	1	#0	16QAM	4.89	13	PASS
Band25	15	26365	1	#0	QPSK	5.74	13	PASS
Band25	15	26365	1	#0	16QAM	6.75	13	PASS
Band25	15	26615	1	#0	QPSK	5.71	13	PASS
Band25	15	26615	1	#0	16QAM	6.46	13	PASS
Band25	20	26140	1	#0	QPSK	3.76	13	PASS
Band25	20	26140	1	#0	16QAM	4.62	13	PASS
Band25	20	26365	1	#0	QPSK	5.76	13	PASS
Band25	20	26365	1	#0	16QAM	6.61	13	PASS
Band25	20	26590	1	#0	QPSK	5.29	13	PASS
Band25	20	26590	1	#0	16QAM	6.25	13	PASS
Band26(814-824)	1.4	26697	1	#0	QPSK	4.91	13	PASS
Band26(814-824)	1.4	26697	1	#0	16QAM	5.38	13	PASS
Band26(814-824)	1.4	26740	1	#0	QPSK	3.98	13	PASS
Band26(814-824)	1.4	26740	1	#0	16QAM	4.55	13	PASS
Band26(814-824)	1.4	26783	1	#0	QPSK	5.43	13	PASS
Band26(814-824)	1.4	26783	1	#0	16QAM	6.10	13	PASS
Band26(814-824)	3	26705	1	#0	QPSK	4.86	13	PASS
Band26(814-824)	3	26705	1	#0	16QAM	5.75	13	PASS

Band26(814-824)	3	26740	1	#0	QPSK	4.14	13	PASS
Band26(814-824)	3	26740	1	#0	16QAM	4.73	13	PASS
Band26(814-824)	3	26775	1	#0	QPSK	4.91	13	PASS
Band26(814-824)	3	26775	1	#0	16QAM	5.67	13	PASS
Band26(814-824)	5	26715	1	#0	QPSK	5.07	13	PASS
Band26(814-824)	5	26715	1	#0	16QAM	5.81	13	PASS
Band26(814-824)	5	26740	1	#0	QPSK	4.41	13	PASS
Band26(814-824)	5	26740	1	#0	16QAM	5.21	13	PASS
Band26(814-824)	5	26765	1	#0	QPSK	4.12	13	PASS
Band26(814-824)	5	26765	1	#0	16QAM	5.08	13	PASS
Band26(814-824)	10	26740	1	#0	QPSK	5.00	13	PASS
Band26(814-824)	10	26740	1	#0	16QAM	5.86	13	PASS
Band26(824-849)	1.4	26797	1	#0	QPSK	5.92	13	PASS
Band26(824-849)	1.4	26797	1	#0	16QAM	6.58	13	PASS
Band26(824-849)	1.4	26915	1	#0	QPSK	5.96	13	PASS
Band26(824-849)	1.4	26915	1	#0	16QAM	6.83	13	PASS
Band26(824-849)	1.4	27033	1	#0	QPSK	4.57	13	PASS
Band26(824-849)	1.4	27033	1	#0	16QAM	5.51	13	PASS
Band26(824-849)	3	26805	1	#0	QPSK	5.84	13	PASS
Band26(824-849)	3	26805	1	#0	16QAM	6.76	13	PASS
Band26(824-849)	3	26915	1	#0	QPSK	5.85	13	PASS
Band26(824-849)	3	26915	1	#0	16QAM	6.35	13	PASS
Band26(824-849)	3	27025	1	#0	QPSK	4.95	13	PASS
Band26(824-849)	3	27025	1	#0	16QAM	5.89	13	PASS
Band26(824-849)	5	26815	1	#0	QPSK	6.20	13	PASS
Band26(824-849)	5	26815	1	#0	16QAM	6.50	13	PASS
Band26(824-849)	5	26915	1	#0	QPSK	5.69	13	PASS
Band26(824-849)	5	26915	1	#0	16QAM	6.13	13	PASS
Band26(824-849)	5	27015	1	#0	QPSK	4.47	13	PASS
Band26(824-849)	5	27015	1	#0	16QAM	5.32	13	PASS
Band26(824-849)	10	26840	1	#0	QPSK	5.74	13	PASS
Band26(824-849)	10	26840	1	#0	16QAM	6.62	13	PASS
Band26(824-849)	10	26915	1	#0	QPSK	4.95	13	PASS
Band26(824-849)	10	26915	1	#0	16QAM	5.99	13	PASS
Band26(824-849)	10	26990	1	#0	QPSK	4.80	13	PASS
Band26(824-849)	10	26990	1	#0	16QAM	5.76	13	PASS
Band26(824-849)	15	26865	1	#0	QPSK	5.86	13	PASS
Band26(824-849)	15	26865	1	#0	16QAM	6.78	13	PASS
Band26(824-849)	15	26915	1	#0	QPSK	4.51	13	PASS
Band26(824-849)	15	26915	1	#0	16QAM	5.52	13	PASS
Band26(824-849)	15	26965	1	#0	QPSK	5.93	13	PASS
Band26(824-849)	15	26965	1	#0	16QAM	6.49	13	PASS
Band66	1.4	131979	1	#0	QPSK	3.99	13	PASS
Band66	1.4	131979	1	#0	16QAM	4.85	13	PASS
Band66	1.4	132322	1	#0	QPSK	4.15	13	PASS
Band66	1.4	132322	1	#0	16QAM	4.69	13	PASS
Band66	1.4	132665	1	#0	QPSK	4.46	13	PASS
Band66	1.4	132665	1	#0	16QAM	5.44	13	PASS
Band66	3	131987	1	#0	QPSK	3.97	13	PASS
Band66	3	131987	1	#0	16QAM	4.95	13	PASS
Band66	3	132322	1	#0	QPSK	4.16	13	PASS
Band66	3	132322	1	#0	16QAM	4.69	13	PASS
Band66	3	132657	1	#0	QPSK	4.79	13	PASS
Band66	3	132657	1	#0	16QAM	5.41	13	PASS
Band66	5	131997	1	#0	QPSK	4.09	13	PASS
Band66	5	131997	1	#0	16QAM	5.14	13	PASS
Band66	5	132322	1	#0	QPSK	4.13	13	PASS
Band66	5	132322	1	#0	16QAM	4.84	13	PASS
Band66	5	132647	1	#0	QPSK	4.99	13	PASS
Band66	5	132647	1	#0	16QAM	5.76	13	PASS
Band66	10	132022	1	#0	QPSK	4.12	13	PASS
Band66	10	132022	1	#0	16QAM	4.93	13	PASS
Band66	10	132322	1	#0	QPSK	4.28	13	PASS
Band66	10	132322	1	#0	16QAM	5.12	13	PASS
Band66	10	132622	1	#0	QPSK	4.56	13	PASS
Band66	10	132622	1	#0	16QAM	5.51	13	PASS
Band66	15	132047	1	#0	QPSK	4.14	13	PASS
Band66	15	132047	1	#0	16QAM	5.05	13	PASS

Band66	15	132322	1	#0	QPSK	4.57	13	PASS
Band66	15	132322	1	#0	16QAM	5.41	13	PASS
Band66	15	132597	1	#0	QPSK	3.87	13	PASS
Band66	15	132597	1	#0	16QAM	4.64	13	PASS
Band66	20	132072	1	#0	QPSK	4.16	13	PASS
Band66	20	132072	1	#0	16QAM	5.01	13	PASS
Band66	20	132322	1	#0	QPSK	4.77	13	PASS
Band66	20	132322	1	#0	16QAM	5.70	13	PASS
Band66	20	132572	1	#0	QPSK	4.17	13	PASS
Band66	20	132572	1	#0	16QAM	5.07	13	PASS

Band2 16QAM BW=1.4MHz Channel=18607 RB Size=1 Position=#0



Band2 16QAM BW=1.4MHz Channel=18900 RB Size=1 Position=#0



Band2 16QAM BW=1.4MHz Channel=19193 RB Size=1 Position=#0

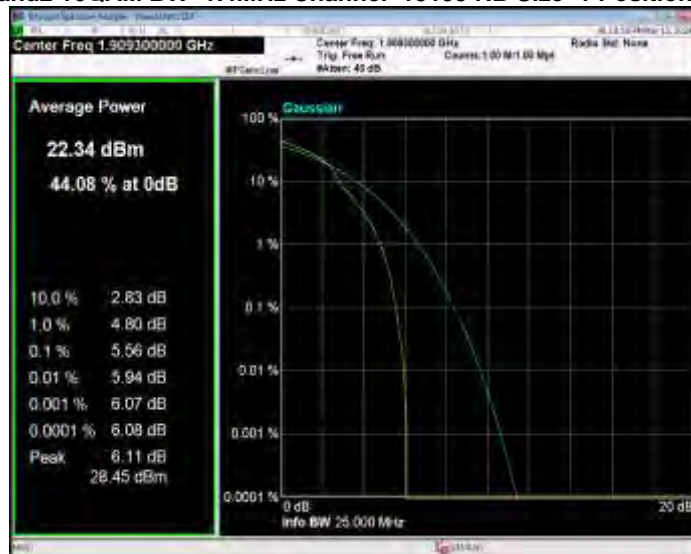

Band2 16QAM BW=10MHz Channel=18650 RB Size=1 Position=#0



Band2 16QAM BW=10MHz Channel=18900 RB Size=1 Position=#0



Band2 16QAM BW=10MHz Channel=19150 RB Size=1 Position=#0



Band2 16QAM BW=15MHz Channel=18675 RB Size=1 Position=#0



Band2 16QAM BW=15MHz Channel=18900 RB Size=1 Position=#0



Band2 16QAM BW=15MHz Channel=19125 RB Size=1 Position=#0



Band2 16QAM BW=20MHz Channel=18700 RB Size=1 Position=#0



Band2 16QAM BW=20MHz Channel=18900 RB Size=1 Position=#0

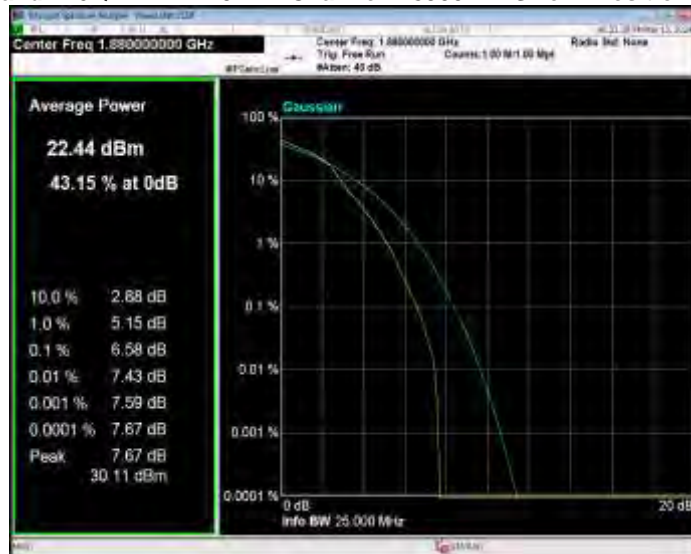

Band2 16QAM BW=20MHz Channel=19100 RB Size=1 Position=#0



Band2 16QAM BW=3MHz Channel=18615 RB Size=1 Position=#0



Band2 16QAM BW=3MHz Channel=18900 RB Size=1 Position=#0



Band2 16QAM BW=3MHz Channel=19185 RB Size=1 Position=#0



Band2 16QAM BW=5MHz Channel=18625 RB Size=1 Position=#0



Band2 16QAM BW=5MHz Channel=18900 RB Size=1 Position=#0

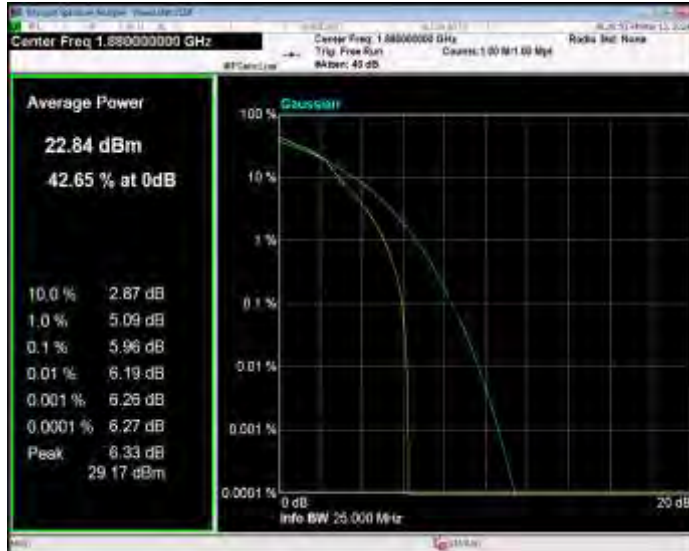

Band2 16QAM BW=5MHz Channel=19175 RB Size=1 Position=#0



Band2 QPSK BW=1.4MHz Channel=18607 RB Size=1 Position=#0

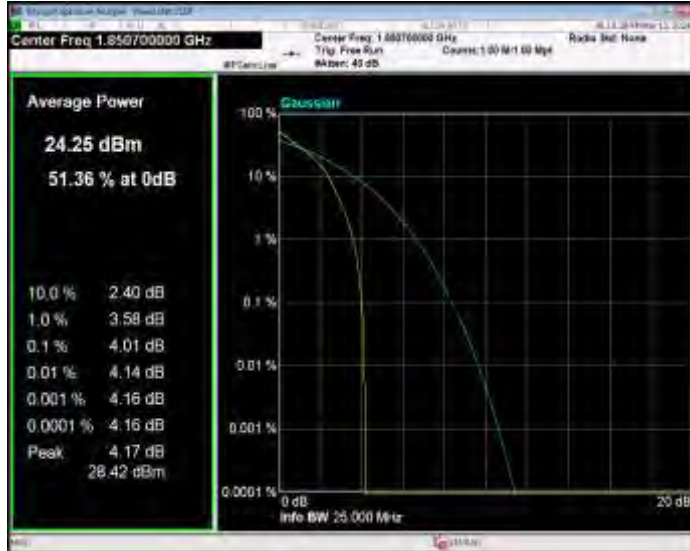

Band2 QPSK BW=1.4MHz Channel=18900 RB Size=1 Position=#0

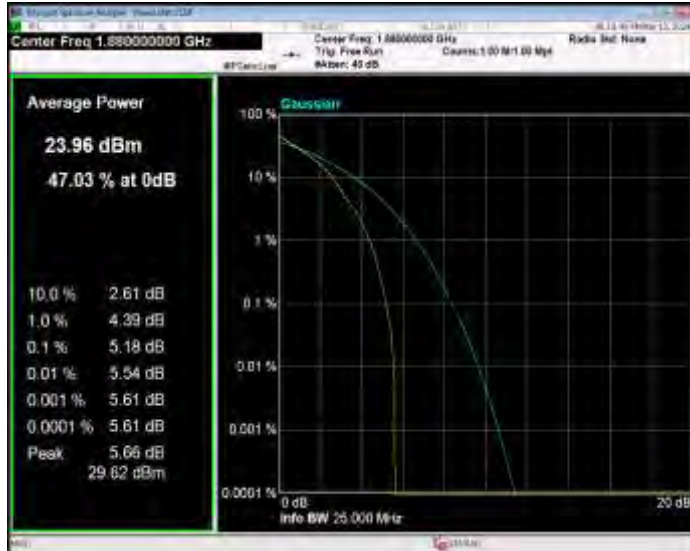

Band2 QPSK BW=1.4MHz Channel=19193 RB Size=1 Position=#0



Band2 QPSK BW=10MHz Channel=18650 RB Size=1 Position=#0



Band2 QPSK BW=10MHz Channel=18900 RB Size=1 Position=#0



Band2 QPSK BW=10MHz Channel=19150 RB Size=1 Position=#0



Band2 QPSK BW=15MHz Channel=18675 RB Size=1 Position=#0

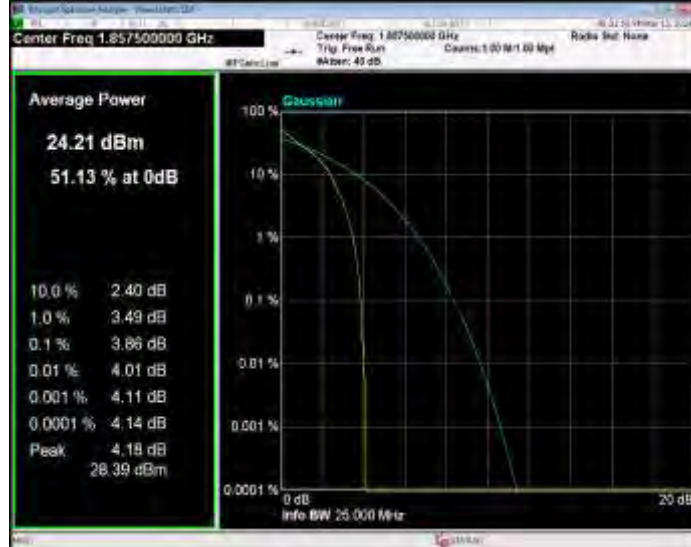

Band2 QPSK BW=15MHz Channel=18900 RB Size=1 Position=#0



Band2 QPSK BW=15MHz Channel=19125 RB Size=1 Position=#0



Band2 QPSK BW=20MHz Channel=18700 RB Size=1 Position=#0



Band2 QPSK BW=20MHz Channel=18900 RB Size=1 Position=#0



Band2 QPSK BW=20MHz Channel=19100 RB Size=1 Position=#0



Band2 QPSK BW=3MHz Channel=18615 RB Size=1 Position=#0



Band2 QPSK BW=3MHz Channel=18900 RB Size=1 Position=#0

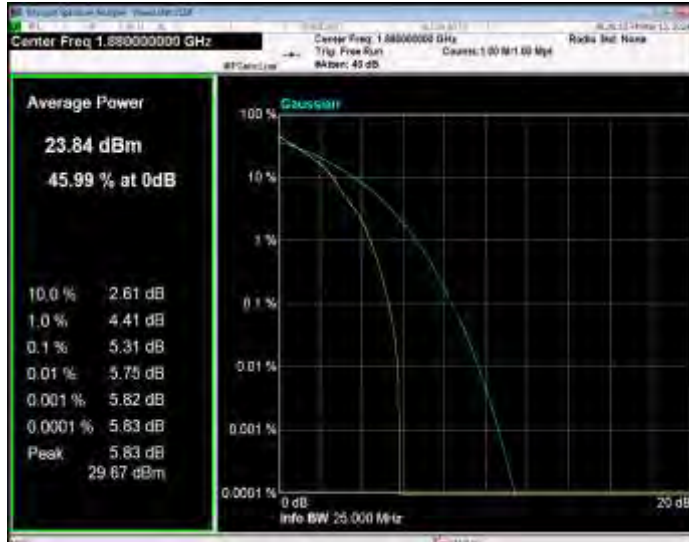

Band2 QPSK BW=3MHz Channel=19185 RB Size=1 Position=#0

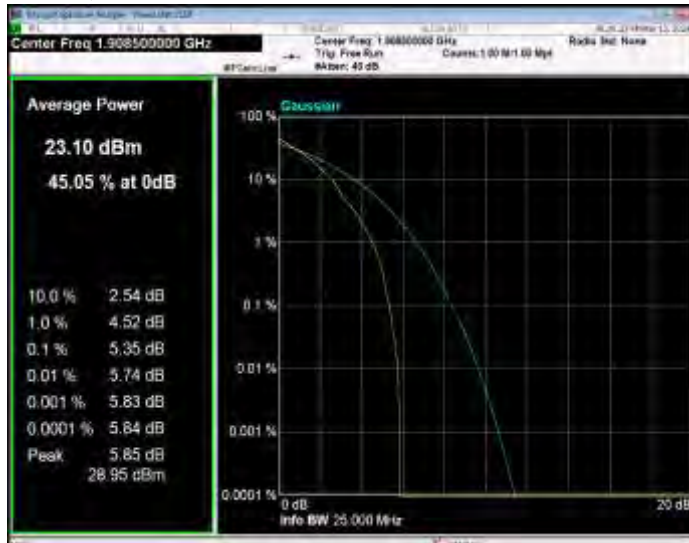

Band2 QPSK BW=5MHz Channel=18625 RB Size=1 Position=#0

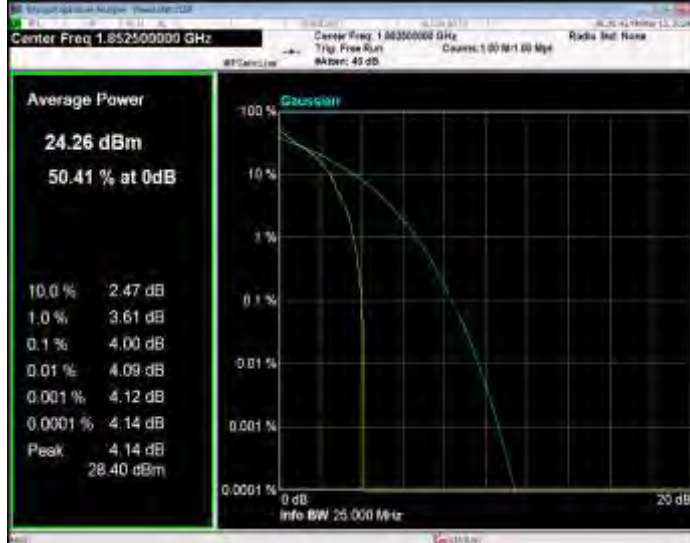

Band2 QPSK BW=5MHz Channel=18900 RB Size=1 Position=#0



Band2 QPSK BW=5MHz Channel=19175 RB Size=1 Position=#0



Band4 16QAM BW=1.4MHz Channel=19957 RB Size=1 Position=#0



Band4 16QAM BW=1.4MHz Channel=20175 RB Size=1 Position=#0



Band4 16QAM BW=1.4MHz Channel=20393 RB Size=1 Position=#0



Band4 16QAM BW=10MHz Channel=20000 RB Size=1 Position=#0



Band4 16QAM BW=10MHz Channel=20175 RB Size=1 Position=#0



Band4 16QAM BW=10MHz Channel=20350 RB Size=1 Position=#0



Band4 16QAM BW=15MHz Channel=20025 RB Size=1 Position=#0



Band4 16QAM BW=15MHz Channel=20175 RB Size=1 Position=#0



Band4 16QAM BW=15MHz Channel=20325 RB Size=1 Position=#0



Band4 16QAM BW=20MHz Channel=20050 RB Size=1 Position=#0



Band4 16QAM BW=20MHz Channel=20175 RB Size=1 Position=#0



Band4 16QAM BW=20MHz Channel=20300 RB Size=1 Position=#0



Band4 16QAM BW=3MHz Channel=19965 RB Size=1 Position=#0



Band4 16QAM BW=3MHz Channel=20175 RB Size=1 Position=#0



Band4 16QAM BW=3MHz Channel=20385 RB Size=1 Position=#0



Band4 16QAM BW=5MHz Channel=19975 RB Size=1 Position=#0

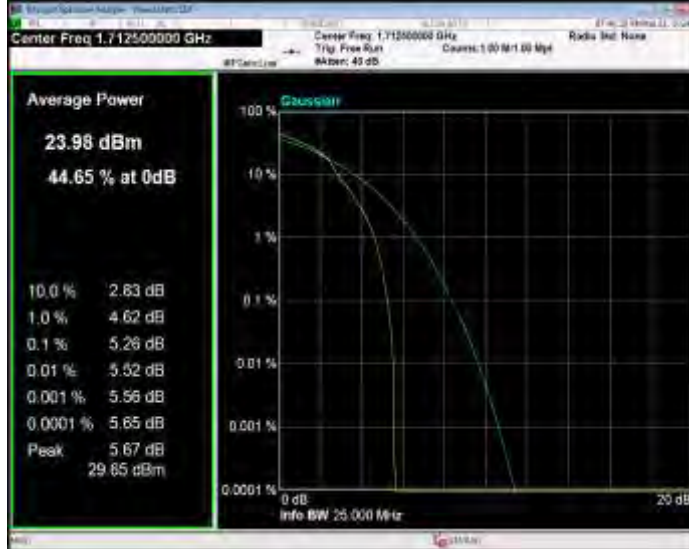

Band4 16QAM BW=5MHz Channel=20175 RB Size=1 Position=#0



Band4 16QAM BW=5MHz Channel=20375 RB Size=1 Position=#0



Band4 QPSK BW=1.4MHz Channel=19957 RB Size=1 Position=#0



Band4 QPSK BW=1.4MHz Channel=20175 RB Size=1 Position=#0



Band4 QPSK BW=1.4MHz Channel=20393 RB Size=1 Position=#0



Band4 QPSK BW=10MHz Channel=20000 RB Size=1 Position=#0

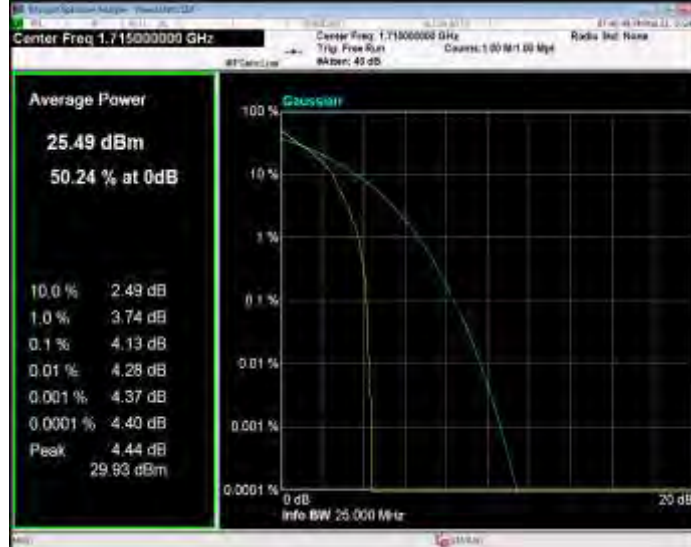

Band4 QPSK BW=10MHz Channel=20175 RB Size=1 Position=#0



Band4 QPSK BW=10MHz Channel=20350 RB Size=1 Position=#0



Band4 QPSK BW=15MHz Channel=20025 RB Size=1 Position=#0



Band4 QPSK BW=15MHz Channel=20175 RB Size=1 Position=#0



Band4 QPSK BW=15MHz Channel=20325 RB Size=1 Position=#0

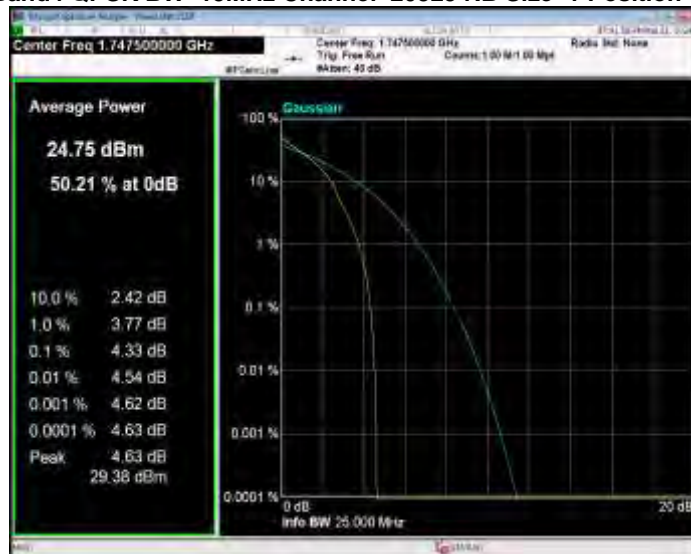

Band4 QPSK BW=20MHz Channel=20050 RB Size=1 Position=#0



Band4 QPSK BW=20MHz Channel=20175 RB Size=1 Position=#0



Band4 QPSK BW=20MHz Channel=20300 RB Size=1 Position=#0



Band4 QPSK BW=3MHz Channel=19965 RB Size=1 Position=#0

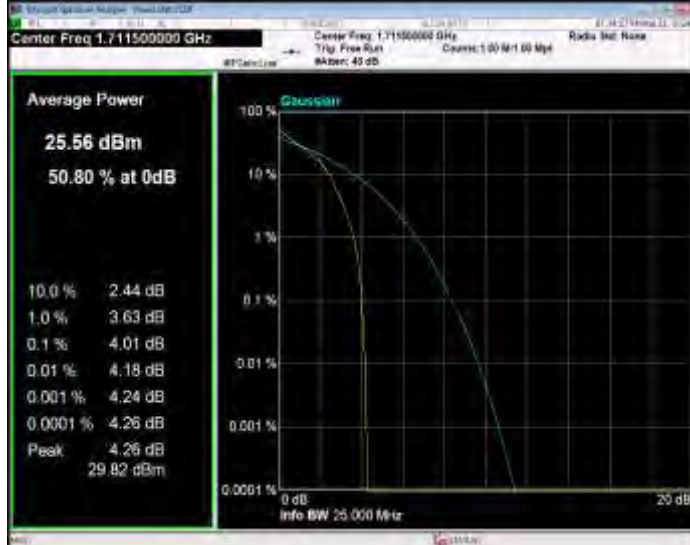

Band4 QPSK BW=3MHz Channel=20175 RB Size=1 Position=#0

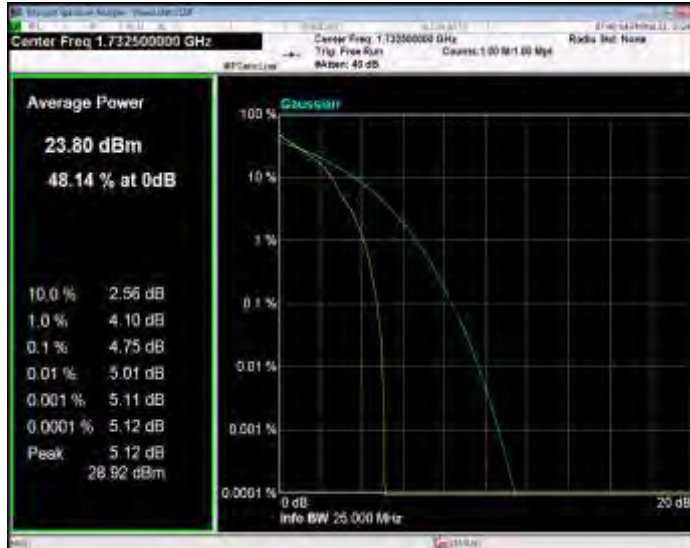

Band4 QPSK BW=3MHz Channel=20385 RB Size=1 Position=#0



Band4 QPSK BW=5MHz Channel=19975 RB Size=1 Position=#0

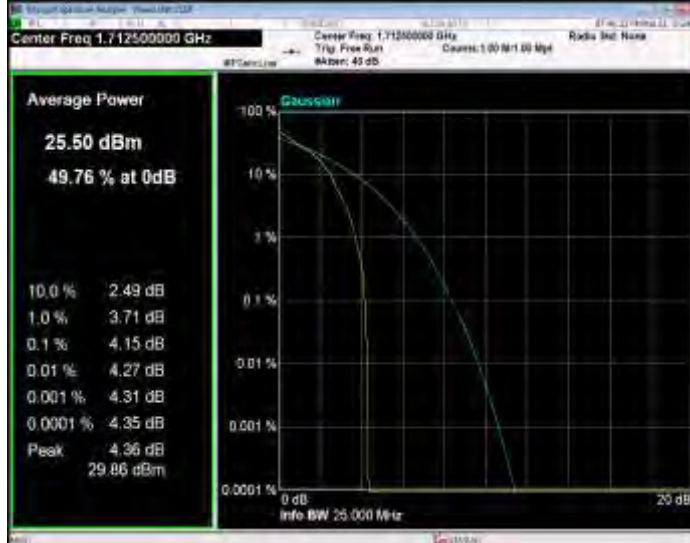

Band4 QPSK BW=5MHz Channel=20175 RB Size=1 Position=#0



Band4 QPSK BW=5MHz Channel=20375 RB Size=1 Position=#0



Band5 16QAM BW=1.4MHz Channel=20407 RB Size=1 Position=#0



Band5 16QAM BW=1.4MHz Channel=20525 RB Size=1 Position=#0



Band5 16QAM BW=1.4MHz Channel=20643 RB Size=1 Position=#0



Band5 16QAM BW=10MHz Channel=20450 RB Size=1 Position=#0

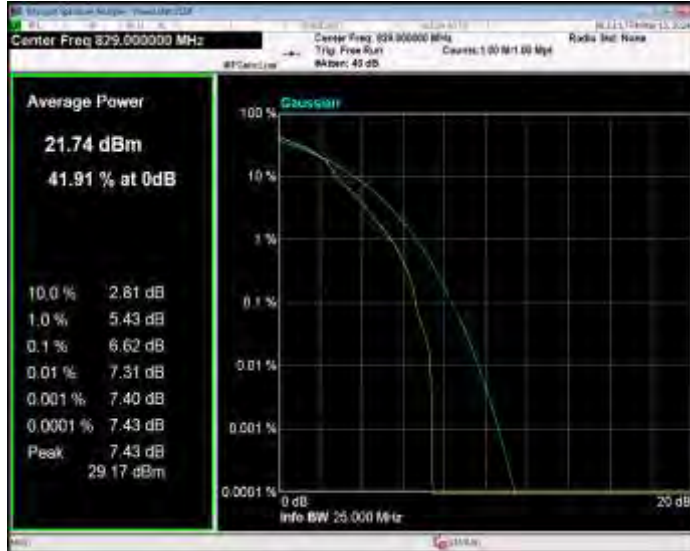

Band5 16QAM BW=10MHz Channel=20525 RB Size=1 Position=#0

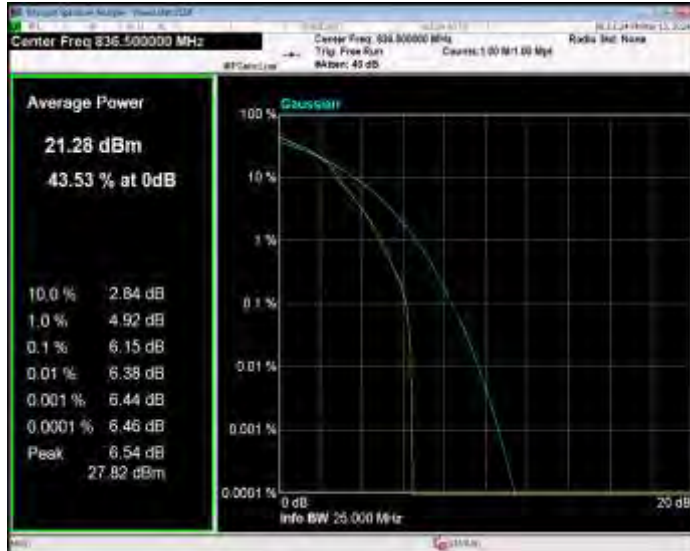

Band5 16QAM BW=10MHz Channel=20600 RB Size=1 Position=#0



Band5 16QAM BW=3MHz Channel=20415 RB Size=1 Position=#0

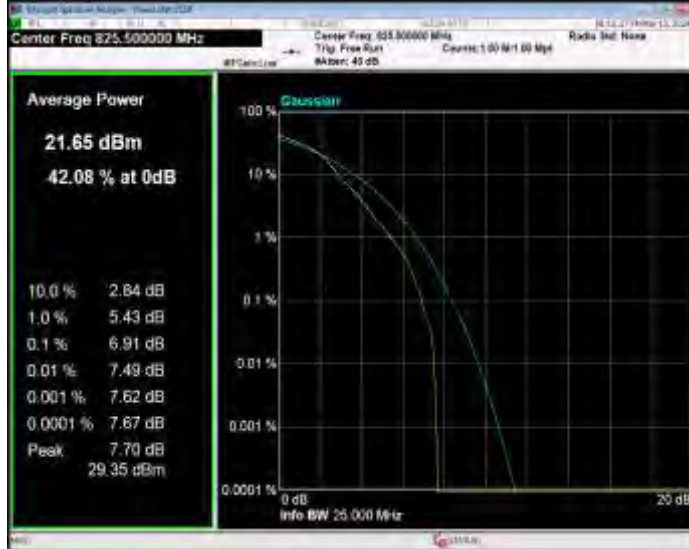

Band5 16QAM BW=3MHz Channel=20525 RB Size=1 Position=#0

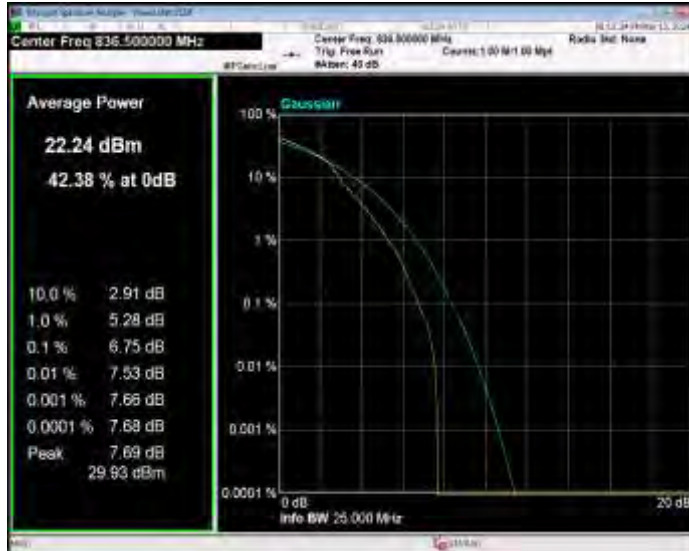

Band5 16QAM BW=3MHz Channel=20635 RB Size=1 Position=#0



Band5 16QAM BW=5MHz Channel=20425 RB Size=1 Position=#0



Band5 16QAM BW=5MHz Channel=20525 RB Size=1 Position=#0

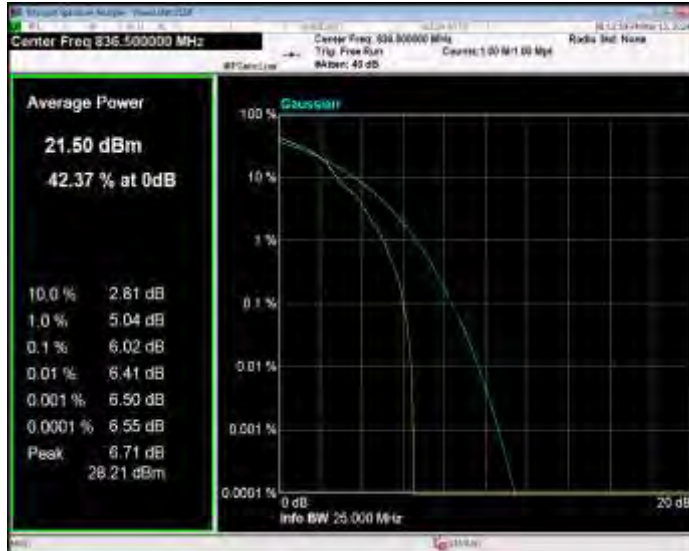

Band5 16QAM BW=5MHz Channel=20625 RB Size=1 Position=#0



Band5 QPSK BW=1.4MHz Channel=20407 RB Size=1 Position=#0

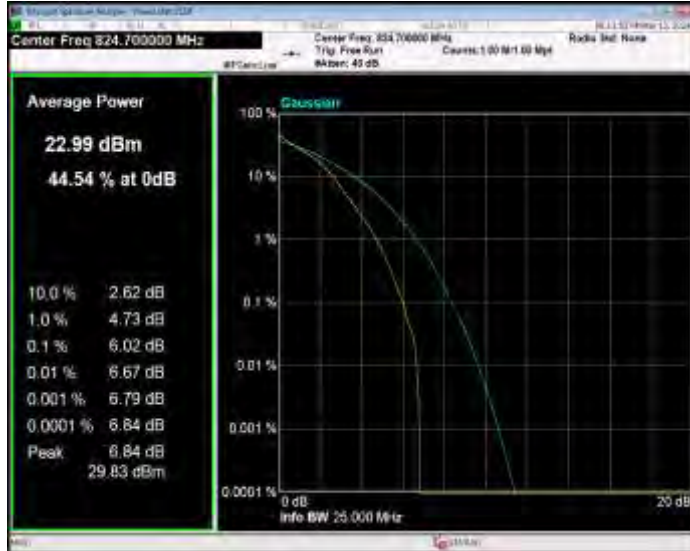

Band5 QPSK BW=1.4MHz Channel=20525 RB Size=1 Position=#0



Band5 QPSK BW=1.4MHz Channel=20643 RB Size=1 Position=#0



Band5 QPSK BW=10MHz Channel=20450 RB Size=1 Position=#0



Band5 QPSK BW=10MHz Channel=20525 RB Size=1 Position=#0



Band5 QPSK BW=10MHz Channel=20600 RB Size=1 Position=#0



Band5 QPSK BW=3MHz Channel=20415 RB Size=1 Position=#0



Band5 QPSK BW=3MHz Channel=20525 RB Size=1 Position=#0

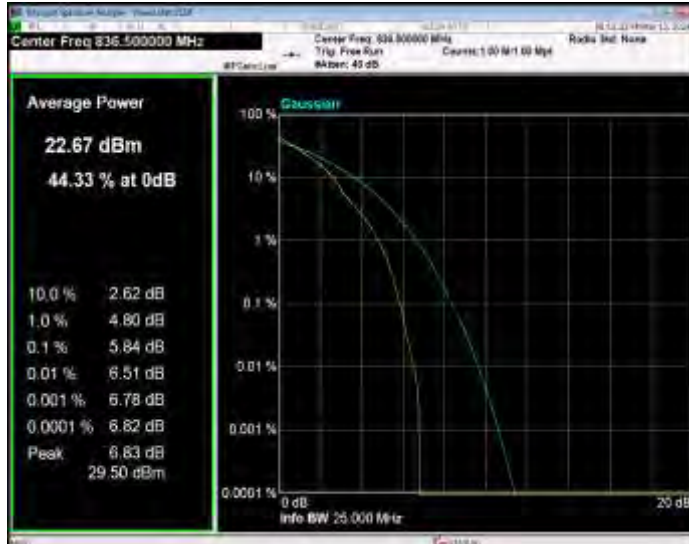

Band5 QPSK BW=3MHz Channel=20635 RB Size=1 Position=#0



Band5 QPSK BW=5MHz Channel=20425 RB Size=1 Position=#0

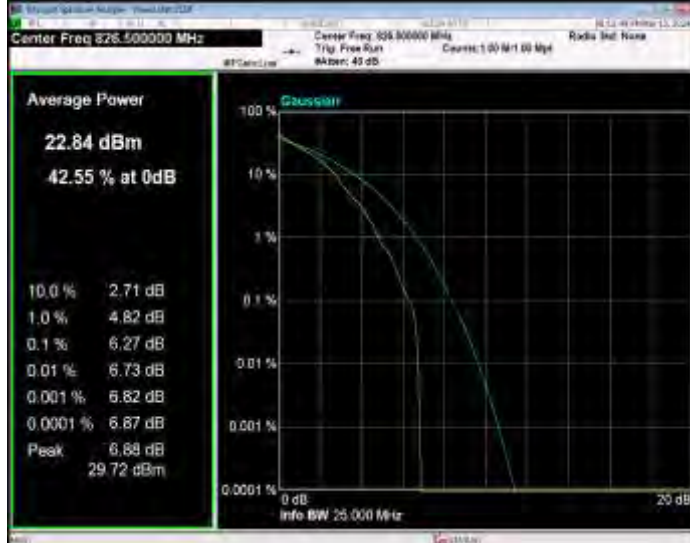

Band5 QPSK BW=5MHz Channel=20525 RB Size=1 Position=#0



Band5 QPSK BW=5MHz Channel=20625 RB Size=1 Position=#0



Band7 16QAM BW=10MHz Channel=20800 RB Size=1 Position=#0



Band7 16QAM BW=10MHz Channel=21100 RB Size=1 Position=#0



Band7 16QAM BW=10MHz Channel=21400 RB Size=1 Position=#0



Band7 16QAM BW=15MHz Channel=20825 RB Size=1 Position=#0



Band7 16QAM BW=15MHz Channel=21100 RB Size=1 Position=#0



Band7 16QAM BW=15MHz Channel=21375 RB Size=1 Position=#0



Band7 16QAM BW=20MHz Channel=20850 RB Size=1 Position=#0



Band7 16QAM BW=20MHz Channel=21100 RB Size=1 Position=#0



Band7 16QAM BW=20MHz Channel=21350 RB Size=1 Position=#0



Band7 16QAM BW=5MHz Channel=20775 RB Size=1 Position=#0



Band7 16QAM BW=5MHz Channel=21100 RB Size=1 Position=#0

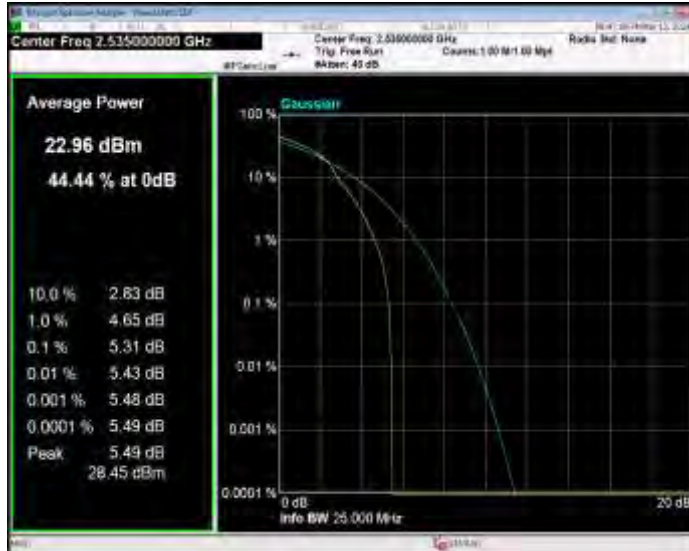

Band7 16QAM BW=5MHz Channel=21425 RB Size=1 Position=#0



Band7 QPSK BW=10MHz Channel=20800 RB Size=1 Position=#0



Band7 QPSK BW=10MHz Channel=21100 RB Size=1 Position=#0



Band7 QPSK BW=10MHz Channel=21400 RB Size=1 Position=#0



Band7 QPSK BW=15MHz Channel=20825 RB Size=1 Position=#0



Band7 QPSK BW=15MHz Channel=21100 RB Size=1 Position=#0



Band7 QPSK BW=15MHz Channel=21375 RB Size=1 Position=#0



Band7 QPSK BW=20MHz Channel=20850 RB Size=1 Position=#0



Band7 QPSK BW=20MHz Channel=21100 RB Size=1 Position=#0



Band7 QPSK BW=20MHz Channel=21350 RB Size=1 Position=#0



Band7 QPSK BW=5MHz Channel=20775 RB Size=1 Position=#0

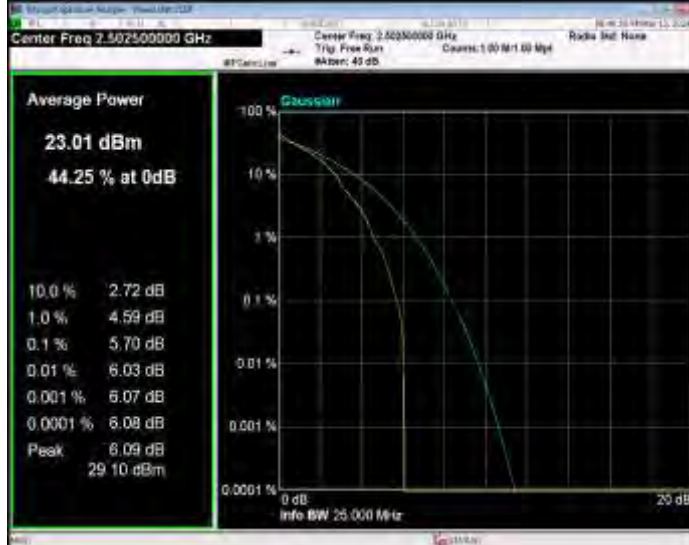

Band7 QPSK BW=5MHz Channel=21100 RB Size=1 Position=#0

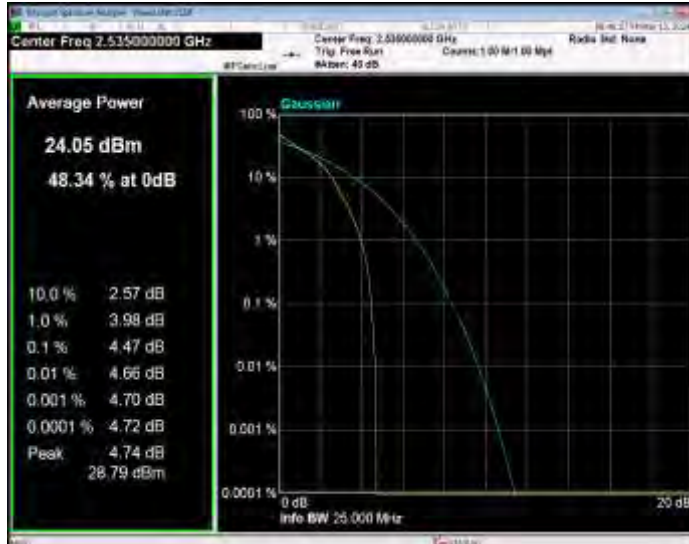

Band7 QPSK BW=5MHz Channel=21425 RB Size=1 Position=#0

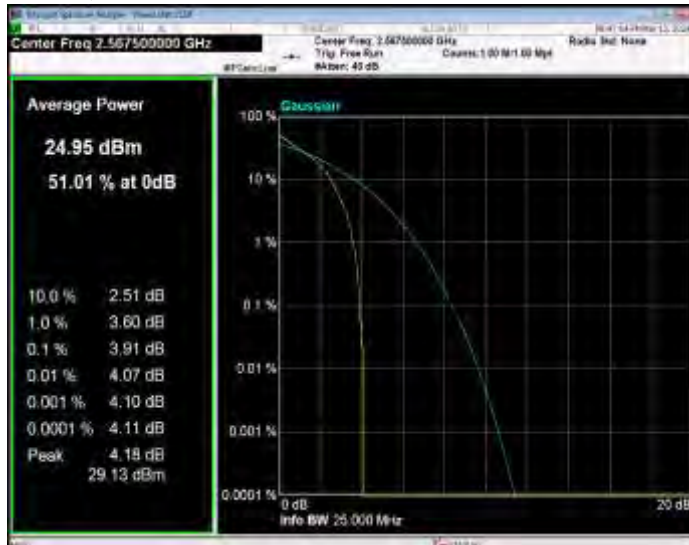

Band12 16QAM BW=1.4MHz Channel=23017 RB Size=1 Position=#0

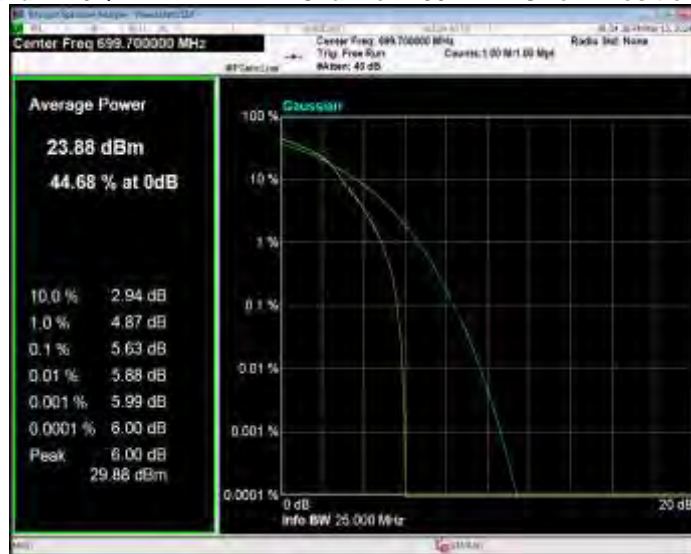

Band12 16QAM BW=1.4MHz Channel=23095 RB Size=1 Position=#0

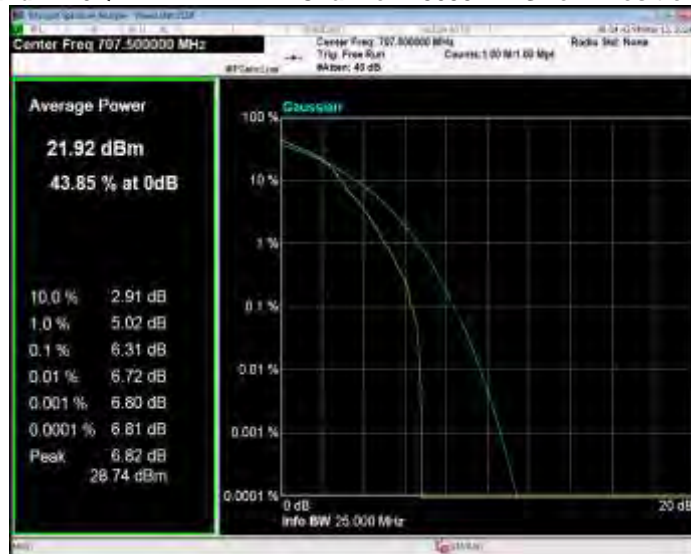

Band12 16QAM BW=1.4MHz Channel=23173 RB Size=1 Position=#0



Band12 16QAM BW=10MHz Channel=23060 RB Size=1 Position=#0



Band12 16QAM BW=10MHz Channel=23095 RB Size=1 Position=#0

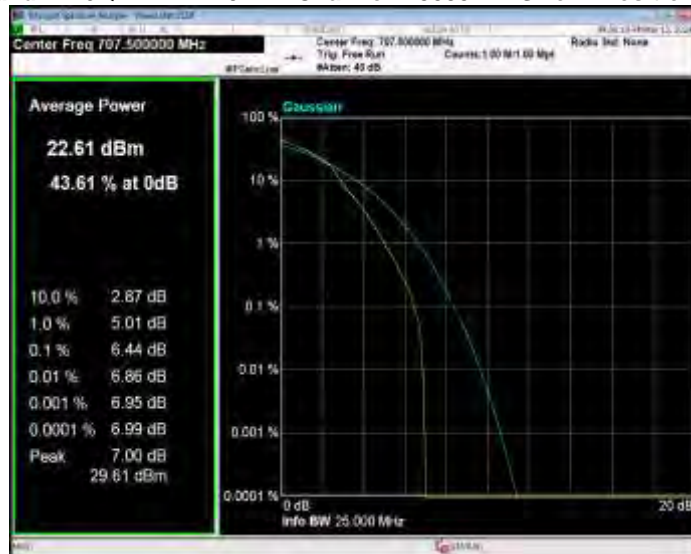

Band12 16QAM BW=10MHz Channel=23130 RB Size=1 Position=#0



Band12 16QAM BW=3MHz Channel=23025 RB Size=1 Position=#0



Band12 16QAM BW=3MHz Channel=23095 RB Size=1 Position=#0



Band12 16QAM BW=3MHz Channel=23165 RB Size=1 Position=#0



Band12 16QAM BW=5MHz Channel=23035 RB Size=1 Position=#0



Band12 16QAM BW=5MHz Channel=23095 RB Size=1 Position=#0



Band12 16QAM BW=5MHz Channel=23155 RB Size=1 Position=#0



Band12 QPSK BW=1.4MHz Channel=23017 RB Size=1 Position=#0

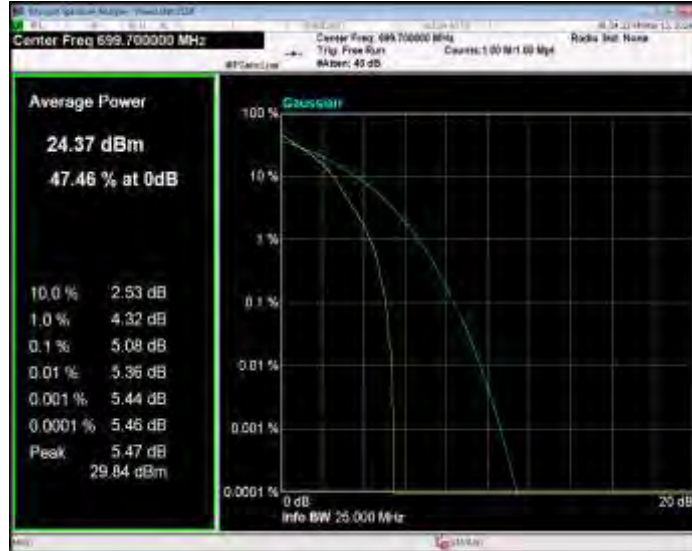

Band12 QPSK BW=1.4MHz Channel=23095 RB Size=1 Position=#0



Band12 QPSK BW=1.4MHz Channel=23173 RB Size=1 Position=#0



Band12 QPSK BW=10MHz Channel=23060 RB Size=1 Position=#0



Band12 QPSK BW=10MHz Channel=23095 RB Size=1 Position=#0



Band12 QPSK BW=10MHz Channel=23130 RB Size=1 Position=#0



Band12 QPSK BW=3MHz Channel=23025 RB Size=1 Position=#0

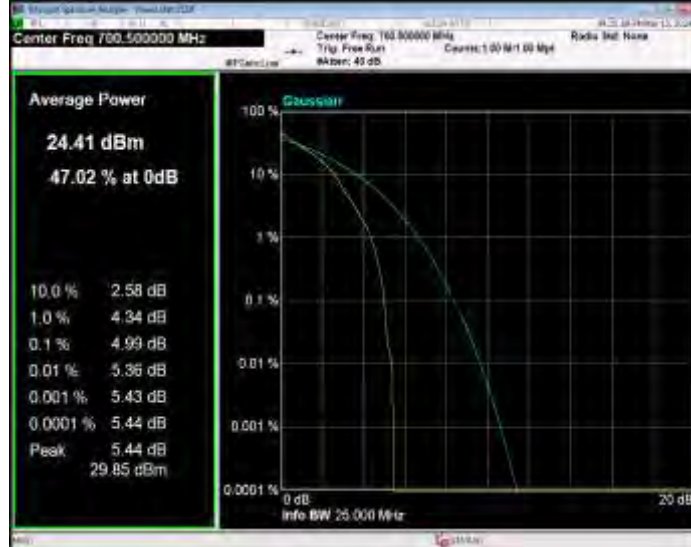

Band12 QPSK BW=3MHz Channel=23095 RB Size=1 Position=#0



Band12 QPSK BW=3MHz Channel=23165 RB Size=1 Position=#0



Band12 QPSK BW=5MHz Channel=23035 RB Size=1 Position=#0



Band12 QPSK BW=5MHz Channel=23095 RB Size=1 Position=#0

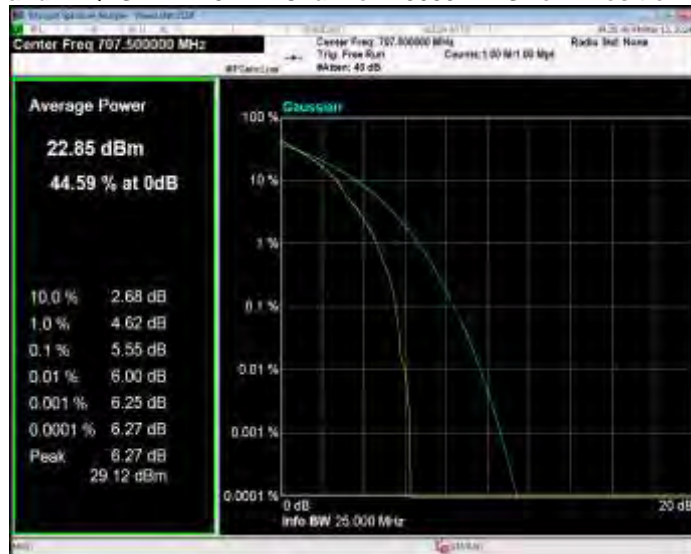

Band12 QPSK BW=5MHz Channel=23155 RB Size=1 Position=#0

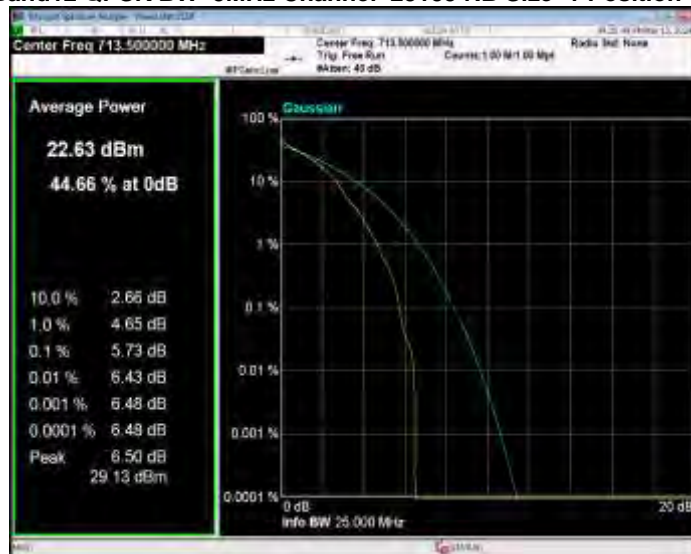

Band17 16QAM BW=10MHz Channel=23780 RB Size=1 Position=#0

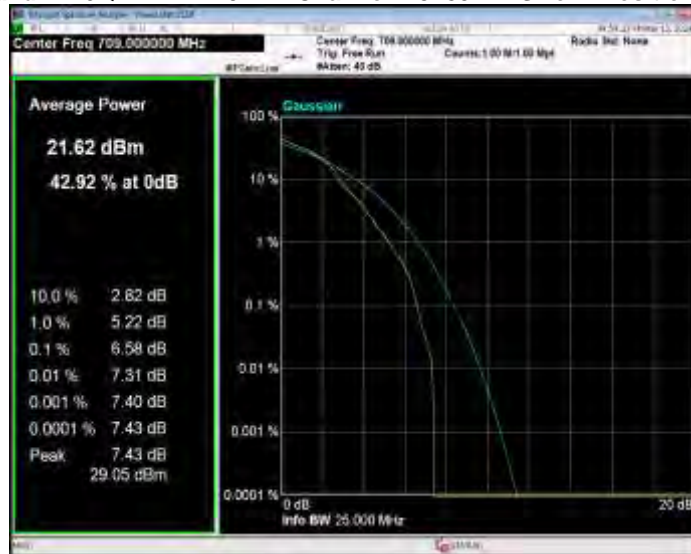

Band17 16QAM BW=10MHz Channel=23790 RB Size=1 Position=#0



Band17 16QAM BW=10MHz Channel=23800 RB Size=1 Position=#0



Band17 16QAM BW=5MHz Channel=23755 RB Size=1 Position=#0



Band17 16QAM BW=5MHz Channel=23790 RB Size=1 Position=#0



Band17 16QAM BW=5MHz Channel=23825 RB Size=1 Position=#0

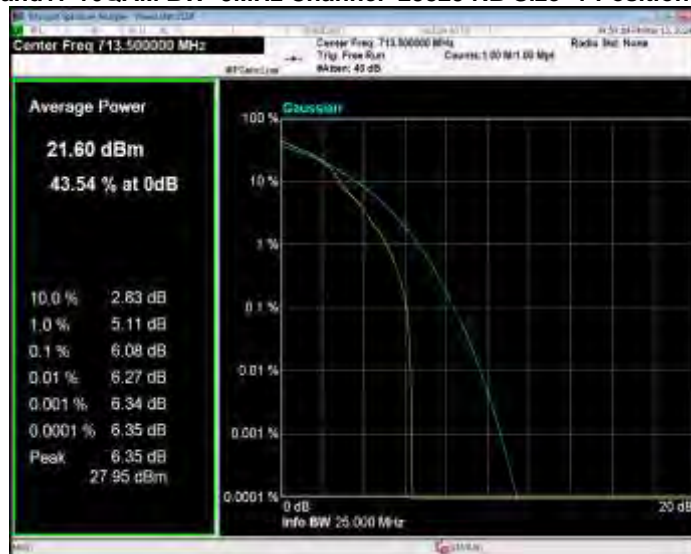

Band17 QPSK BW=10MHz Channel=23780 RB Size=1 Position=#0



Band17 QPSK BW=10MHz Channel=23790 RB Size=1 Position=#0



Band17 QPSK BW=10MHz Channel=23800 RB Size=1 Position=#0

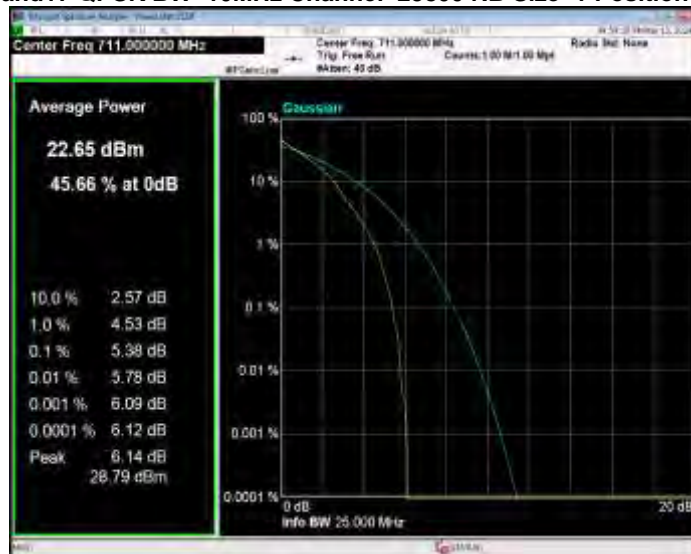

Band17 QPSK BW=5MHz Channel=23755 RB Size=1 Position=#0



Band17 QPSK BW=5MHz Channel=23790 RB Size=1 Position=#0



Band17 QPSK BW=5MHz Channel=23825 RB Size=1 Position=#0

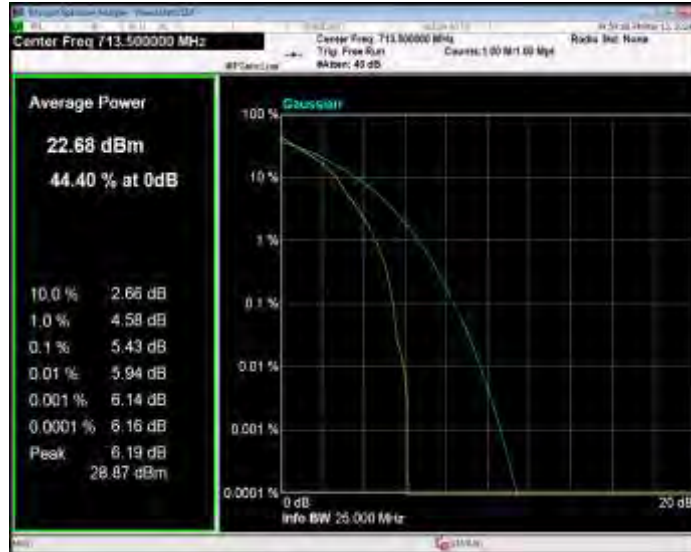

Band25 16QAM BW=1.4MHz Channel=26047 RB Size=1 Position=#0



Band25 16QAM BW=1.4MHz Channel=26365 RB Size=1 Position=#0



Band25 16QAM BW=1.4MHz Channel=26683 RB Size=1 Position=#0



Band25 16QAM BW=10MHz Channel=26090 RB Size=1 Position=#0



Band25 16QAM BW=10MHz Channel=26365 RB Size=1 Position=#0

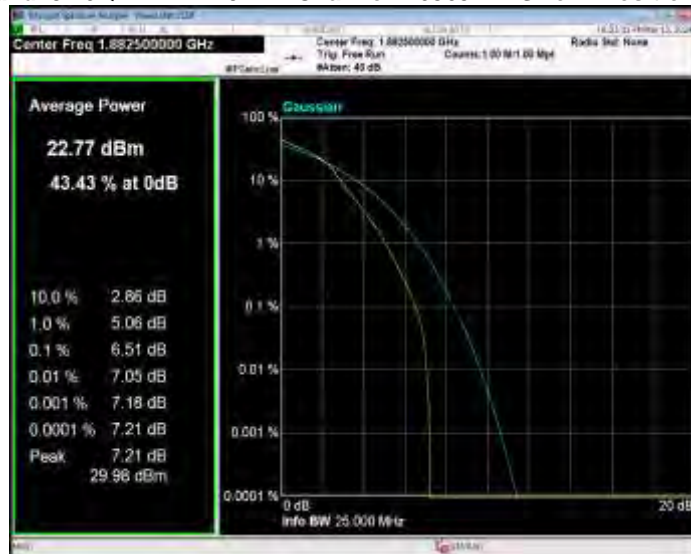

Band25 16QAM BW=10MHz Channel=26640 RB Size=1 Position=#0

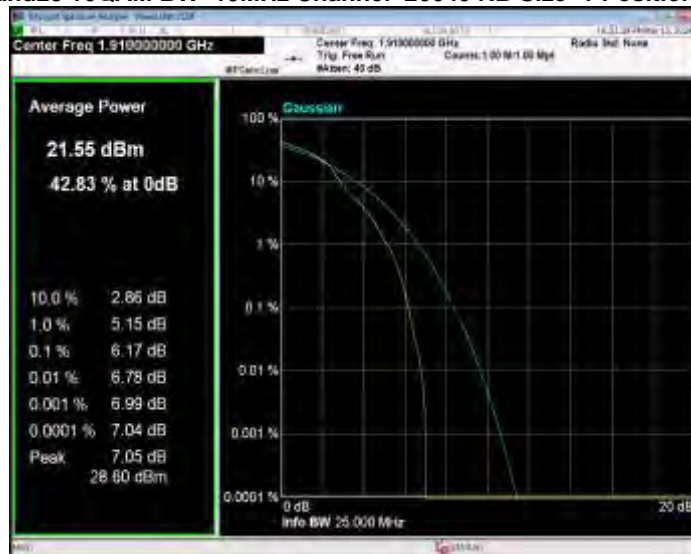

Band25 16QAM BW=15MHz Channel=26115 RB Size=1 Position=#0



Band25 16QAM BW=15MHz Channel=26365 RB Size=1 Position=#0



Band25 16QAM BW=15MHz Channel=26615 RB Size=1 Position=#0



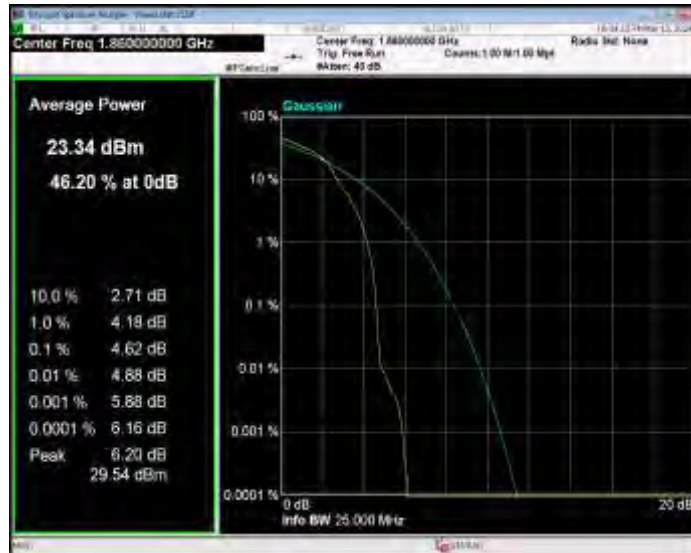

Band25 16QAM BW=20MHz Channel=26365 RB Size=1 Position=#0

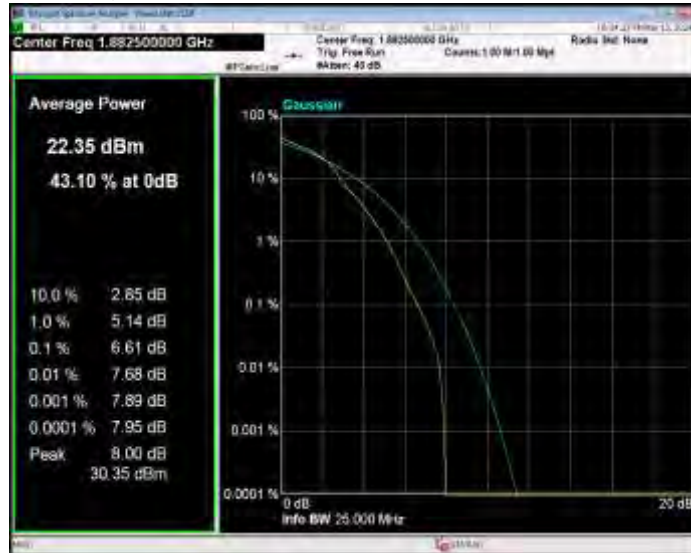

Band25 16QAM BW=20MHz Channel=26590 RB Size=1 Position=#0



Band25 16QAM BW=3MHz Channel=26055 RB Size=1 Position=#0



Band25 16QAM BW=3MHz Channel=26365 RB Size=1 Position=#0



Band25 16QAM BW=3MHz Channel=26675 RB Size=1 Position=#0



Band25 16QAM BW=5MHz Channel=26065 RB Size=1 Position=#0



Band25 16QAM BW=5MHz Channel=26365 RB Size=1 Position=#0



Band25 16QAM BW=5MHz Channel=26665 RB Size=1 Position=#0



Band25 QPSK BW=1.4MHz Channel=26047 RB Size=1 Position=#0



Band25 QPSK BW=1.4MHz Channel=26365 RB Size=1 Position=#0



Band25 QPSK BW=1.4MHz Channel=26683 RB Size=1 Position=#0



Band25 QPSK BW=10MHz Channel=26090 RB Size=1 Position=#0



Band25 QPSK BW=10MHz Channel=26365 RB Size=1 Position=#0



Band25 QPSK BW=10MHz Channel=26640 RB Size=1 Position=#0



Band25 QPSK BW=15MHz Channel=26365 RB Size=1 Position=#0



Band25 QPSK BW=15MHz Channel=26115 RB Size=1 Position=#0



Band25 QPSK BW=15MHz Channel=26615 RB Size=1 Position=#0



Band25 QPSK BW=20MHz Channel=26140 RB Size=1 Position=#0



Band25 QPSK BW=20MHz Channel=26365 RB Size=1 Position=#0



Band25 QPSK BW=20MHz Channel=26590 RB Size=1 Position=#0



Band25 QPSK BW=3MHz Channel=26055 RB Size=1 Position=#0



Band25 QPSK BW=3MHz Channel=26365 RB Size=1 Position=#0



Band25 QPSK BW=3MHz Channel=26675 RB Size=1 Position=#0



Band25 QPSK BW=5MHz Channel=26065 RB Size=1 Position=#0



Band25 QPSK BW=5MHz Channel=26365 RB Size=1 Position=#0



Band25 QPSK BW=5MHz Channel=26665 RB Size=1 Position=#0



Band26(814-824) 16QAM BW=1.4MHz Channel=26697 RB Size=1 Position=#0



Band26(814-824) 16QAM BW=1.4MHz Channel=26740 RB Size=1 Position=#0



Band26(814-824) 16QAM BW=1.4MHz Channel=26783 RB Size=1 Position=#0



Band26(814-824) 16QAM BW=10MHz Channel=26740 RB Size=1 Position=#0

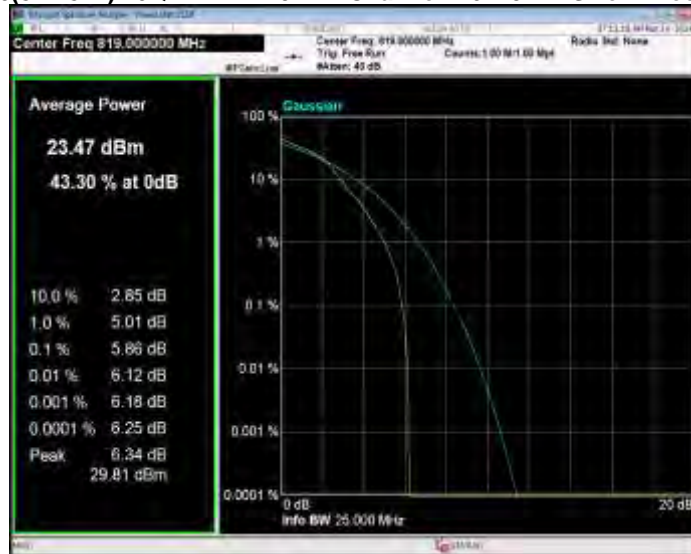

Band26(814-824) 16QAM BW=3MHz Channel=26705 RB Size=1 Position=#0



Band26(814-824) 16QAM BW=3MHz Channel=26740 RB Size=1 Position=#0



Band26(814-824) 16QAM BW=3MHz Channel=26775 RB Size=1 Position=#0



Band26(814-824) 16QAM BW=5MHz Channel=26715 RB Size=1 Position=#0



Band26(814-824) 16QAM BW=5MHz Channel=26740 RB Size=1 Position=#0



Band26(814-824) 16QAM BW=5MHz Channel=26765 RB Size=1 Position=#0

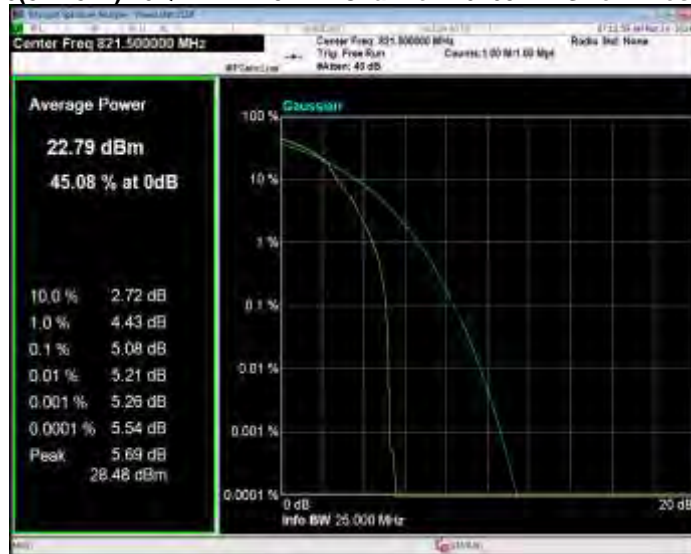

Band26(814-824) QPSK BW=1.4MHz Channel=26697 RB Size=1 Position=#0



Band26(814-824) QPSK BW=1.4MHz Channel=26740 RB Size=1 Position=#0



Band26(814-824) QPSK BW=1.4MHz Channel=26783 RB Size=1 Position=#0



Band26(814-824) QPSK BW=10MHz Channel=26740 RB Size=1 Position=#0

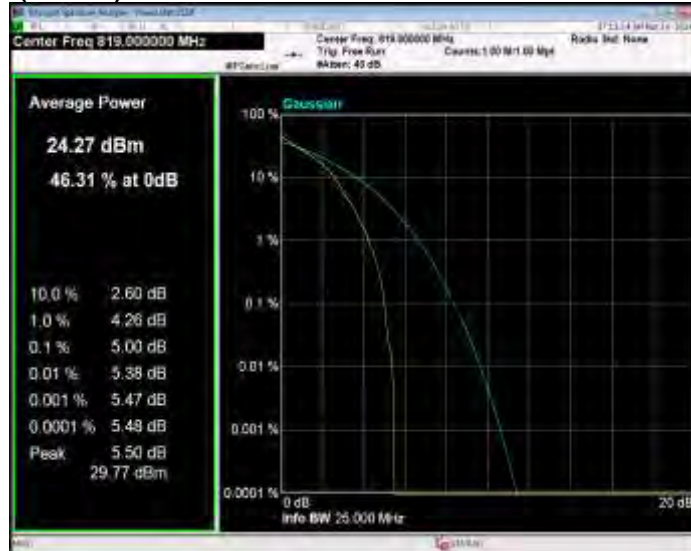

Band26(814-824) QPSK BW=3MHz Channel=26705 RB Size=1 Position=#0



Band26(814-824) QPSK BW=3MHz Channel=26740 RB Size=1 Position=#0

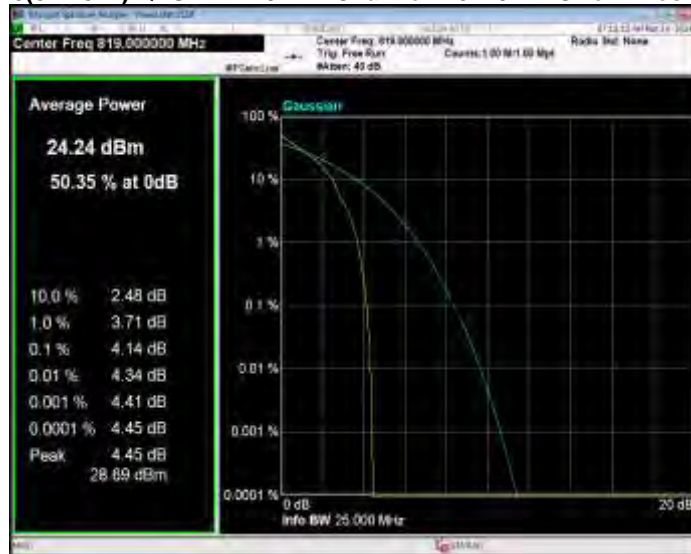

Band26(814-824) QPSK BW=3MHz Channel=26775 RB Size=1 Position=#0



Band26(814-824) QPSK BW=5MHz Channel=26715 RB Size=1 Position=#0



Band26(814-824) QPSK BW=5MHz Channel=26740 RB Size=1 Position=#0



Band26(814-824) QPSK BW=5MHz Channel=26765 RB Size=1 Position=#0



Band26(824-849) 16QAM BW=1.4MHz Channel=26797 RB Size=1 Position=#0



Band26(824-849) 16QAM BW=1.4MHz Channel=26915 RB Size=1 Position=#0



Band26(824-849) 16QAM BW=1.4MHz Channel=27033 RB Size=1 Position=#0



Band26(824-849) 16QAM BW=10MHz Channel=26840 RB Size=1 Position=#0



Band26(824-849) 16QAM BW=10MHz Channel=26915 RB Size=1 Position=#0



Band26(824-849) 16QAM BW=10MHz Channel=26990 RB Size=1 Position=#0



Band26(824-849) 16QAM BW=15MHz Channel=26865 RB Size=1 Position=#0



Band26(824-849) 16QAM BW=15MHz Channel=26915 RB Size=1 Position=#0



Band26(824-849) 16QAM BW=15MHz Channel=26965 RB Size=1 Position=#0



Band26(824-849) 16QAM BW=3MHz Channel=26805 RB Size=1 Position=#0



Band26(824-849) 16QAM BW=3MHz Channel=26915 RB Size=1 Position=#0

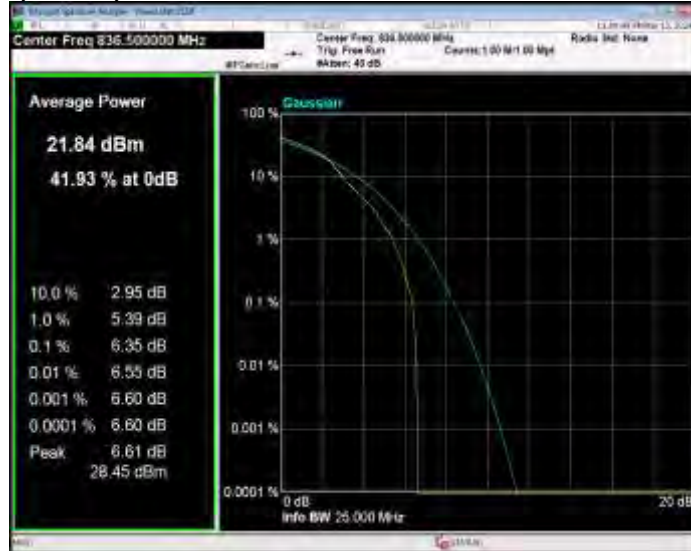

Band26(824-849) 16QAM BW=3MHz Channel=27025 RB Size=1 Position=#0



Band26(824-849) 16QAM BW=5MHz Channel=26815 RB Size=1 Position=#0



Band26(824-849) 16QAM BW=5MHz Channel=26915 RB Size=1 Position=#0

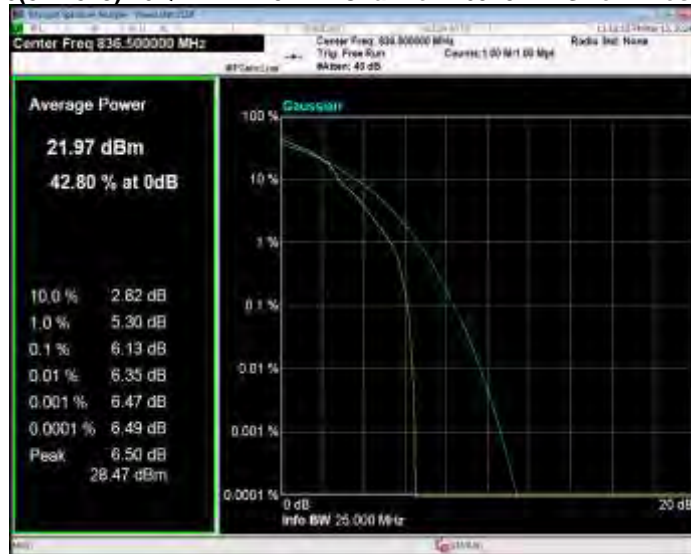

Band26(824-849) 16QAM BW=5MHz Channel=27015 RB Size=1 Position=#0



Band26(824-849) QPSK BW=1.4MHz Channel=26797 RB Size=1 Position=#0



Band26(824-849) QPSK BW=1.4MHz Channel=26915 RB Size=1 Position=#0



Band26(824-849) QPSK BW=1.4MHz Channel=27033 RB Size=1 Position=#0



Band26(824-849) QPSK BW=10MHz Channel=26840 RB Size=1 Position=#0



Band26(824-849) QPSK BW=10MHz Channel=26915 RB Size=1 Position=#0



Band26(824-849) QPSK BW=10MHz Channel=26990 RB Size=1 Position=#0



Band26(824-849) QPSK BW=15MHz Channel=26865 RB Size=1 Position=#0



Band26(824-849) QPSK BW=15MHz Channel=26915 RB Size=1 Position=#0



Band26(824-849) QPSK BW=15MHz Channel=26965 RB Size=1 Position=#0



Band26(824-849) QPSK BW=3MHz Channel=26805 RB Size=1 Position=#0



Band26(824-849) QPSK BW=3MHz Channel=26915 RB Size=1 Position=#0

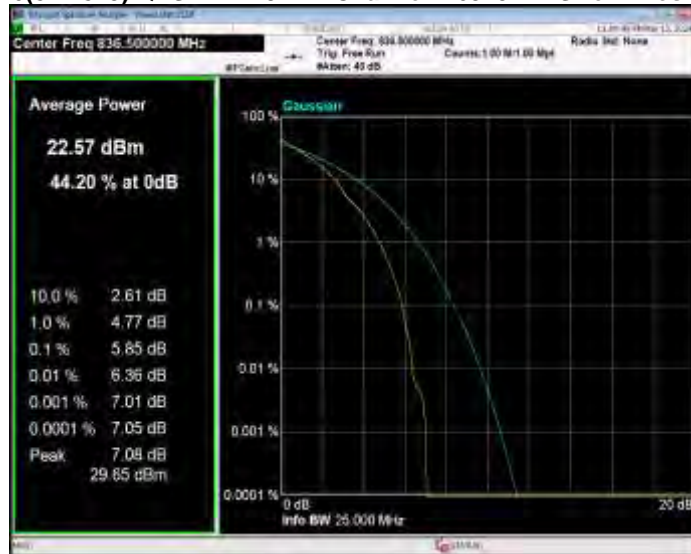

Band26(824-849) QPSK BW=3MHz Channel=27025 RB Size=1 Position=#0



Band26(824-849) QPSK BW=5MHz Channel=26815 RB Size=1 Position=#0



Band26(824-849) QPSK BW=5MHz Channel=26915 RB Size=1 Position=#0



Band26(824-849) QPSK BW=5MHz Channel=27015 RB Size=1 Position=#0



Band66 16QAM BW=1.4MHz Channel=131979 RB Size=1 Position=#0



Band66 16QAM BW=1.4MHz Channel=132322 RB Size=1 Position=#0



Band66 16QAM BW=1.4MHz Channel=132665 RB Size=1 Position=#0



Band66 16QAM BW=10MHz Channel=132022 RB Size=1 Position=#0



Band66 16QAM BW=10MHz Channel=132322 RB Size=1 Position=#0



Band66 16QAM BW=10MHz Channel=132622 RB Size=1 Position=#0



Band66 16QAM BW=15MHz Channel=132047 RB Size=1 Position=#0



Band66 16QAM BW=15MHz Channel=132322 RB Size=1 Position=#0



Band66 16QAM BW=15MHz Channel=132597 RB Size=1 Position=#0



Band66 16QAM BW=20MHz Channel=132072 RB Size=1 Position=#0



Band66 16QAM BW=20MHz Channel=132322 RB Size=1 Position=#0



Band66 16QAM BW=20MHz Channel=132572 RB Size=1 Position=#0



Band66 16QAM BW=3MHz Channel=131987 RB Size=1 Position=#0



Band66 16QAM BW=3MHz Channel=132322 RB Size=1 Position=#0



Band66 16QAM BW=3MHz Channel=132657 RB Size=1 Position=#0



Band66 16QAM BW=5MHz Channel=131997 RB Size=1 Position=#0



Band66 16QAM BW=5MHz Channel=132322 RB Size=1 Position=#0



Band66 16QAM BW=5MHz Channel=132647 RB Size=1 Position=#0



Band66 QPSK BW=1.4MHz Channel=131979 RB Size=1 Position=#0



Band66 QPSK BW=1.4MHz Channel=132322 RB Size=1 Position=#0



Band66 QPSK BW=1.4MHz Channel=132665 RB Size=1 Position=#0



Band66 QPSK BW=10MHz Channel=132022 RB Size=1 Position=#0



Band66 QPSK BW=10MHz Channel=132322 RB Size=1 Position=#0



Band66 QPSK BW=10MHz Channel=132622 RB Size=1 Position=#0



Band66 QPSK BW=15MHz Channel=132047 RB Size=1 Position=#0



Band66 QPSK BW=15MHz Channel=132322 RB Size=1 Position=#0



Band66 QPSK BW=15MHz Channel=132597 RB Size=1 Position=#0



Band66 QPSK BW=20MHz Channel=132072 RB Size=1 Position=#0



Band66 QPSK BW=20MHz Channel=132322 RB Size=1 Position=#0



Band66 QPSK BW=20MHz Channel=132572 RB Size=1 Position=#0



Band66 QPSK BW=3MHz Channel=131987 RB Size=1 Position=#0



Band66 QPSK BW=3MHz Channel=132322 RB Size=1 Position=#0



Band66 QPSK BW=3MHz Channel=132657 RB Size=1 Position=#0



Band66 QPSK BW=5MHz Channel=131997 RB Size=1 Position=#0



Band66 QPSK BW=5MHz Channel=132322 RB Size=1 Position=#0



Band66 QPSK BW=5MHz Channel=132647 RB Size=1 Position=#0



Occupied bandwidth

Band	Bandwidth (MHz)	UL Channel	RB Size	RB Position	Modulation	99% OBW (MHz)	-26dB EBW (MHz)	Verdict
Band2	1.4	18607	6	#0	QPSK	1.097	1.249	PASS
Band2	1.4	18607	6	#0	16QAM	1.104	1.253	PASS
Band2	1.4	18900	6	#0	QPSK	1.097	1.250	PASS
Band2	1.4	18900	6	#0	16QAM	1.090	1.240	PASS
Band2	1.4	19193	6	#0	QPSK	1.102	1.251	PASS
Band2	1.4	19193	6	#0	16QAM	1.097	1.240	PASS
Band2	3	18615	15	#0	QPSK	2.722	3.027	PASS
Band2	3	18615	15	#0	16QAM	2.704	3.057	PASS
Band2	3	18900	15	#0	QPSK	2.715	3.029	PASS
Band2	3	18900	15	#0	16QAM	2.703	3.062	PASS
Band2	3	19185	15	#0	QPSK	2.710	3.041	PASS
Band2	3	19185	15	#0	16QAM	2.704	3.044	PASS
Band2	5	18625	25	#0	QPSK	4.505	5.015	PASS
Band2	5	18625	25	#0	16QAM	4.506	4.945	PASS
Band2	5	18900	25	#0	QPSK	4.508	4.938	PASS
Band2	5	18900	25	#0	16QAM	4.520	4.951	PASS
Band2	5	19175	25	#0	QPSK	4.508	4.948	PASS
Band2	5	19175	25	#0	16QAM	4.509	4.970	PASS
Band2	10	18650	50	#0	QPSK	8.989	9.871	PASS
Band2	10	18650	50	#0	16QAM	9.011	9.932	PASS
Band2	10	18900	50	#0	QPSK	8.977	9.821	PASS
Band2	10	18900	50	#0	16QAM	8.977	9.871	PASS
Band2	10	19150	50	#0	QPSK	8.999	9.856	PASS
Band2	10	19150	50	#0	16QAM	9.006	9.838	PASS
Band2	15	18675	75	#0	QPSK	13.494	15.026	PASS
Band2	15	18675	75	#0	16QAM	13.487	14.734	PASS
Band2	15	18900	75	#0	QPSK	13.450	14.767	PASS
Band2	15	18900	75	#0	16QAM	13.470	14.901	PASS
Band2	15	19125	75	#0	QPSK	13.542	14.782	PASS
Band2	15	19125	75	#0	16QAM	13.521	14.847	PASS
Band2	20	18700	100	#0	QPSK	17.995	19.504	PASS
Band2	20	18700	100	#0	16QAM	17.975	19.472	PASS
Band2	20	18900	100	#0	QPSK	18.037	19.676	PASS
Band2	20	18900	100	#0	16QAM	17.991	19.629	PASS
Band2	20	19100	100	#0	QPSK	18.005	19.664	PASS
Band2	20	19100	100	#0	16QAM	18.061	19.780	PASS
Band4	1.4	19957	6	#0	QPSK	1.092	1.259	PASS
Band4	1.4	19957	6	#0	16QAM	1.108	1.263	PASS
Band4	1.4	20175	6	#0	QPSK	1.099	1.249	PASS
Band4	1.4	20175	6	#0	16QAM	1.093	1.248	PASS
Band4	1.4	20393	6	#0	QPSK	1.097	1.248	PASS
Band4	1.4	20393	6	#0	16QAM	1.099	1.250	PASS
Band4	3	19965	15	#0	QPSK	2.706	3.023	PASS
Band4	3	19965	15	#0	16QAM	2.709	3.042	PASS
Band4	3	20175	15	#0	QPSK	2.706	3.021	PASS
Band4	3	20175	15	#0	16QAM	2.702	3.045	PASS
Band4	3	20385	15	#0	QPSK	2.712	3.041	PASS
Band4	3	20385	15	#0	16QAM	2.721	3.065	PASS
Band4	5	19975	25	#0	QPSK	4.506	4.955	PASS
Band4	5	19975	25	#0	16QAM	4.518	4.977	PASS
Band4	5	20175	25	#0	QPSK	4.512	4.946	PASS
Band4	5	20175	25	#0	16QAM	4.529	4.980	PASS
Band4	5	20375	25	#0	QPSK	4.507	4.946	PASS
Band4	5	20375	25	#0	16QAM	4.524	4.973	PASS
Band4	10	20000	50	#0	QPSK	8.990	9.826	PASS
Band4	10	20000	50	#0	16QAM	8.977	9.917	PASS
Band4	10	20175	50	#0	QPSK	8.977	9.779	PASS
Band4	10	20175	50	#0	16QAM	8.986	9.901	PASS
Band4	10	20350	50	#0	QPSK	9.016	9.903	PASS
Band4	10	20350	50	#0	16QAM	9.004	9.865	PASS
Band4	15	20025	75	#0	QPSK	13.489	14.850	PASS
Band4	15	20025	75	#0	16QAM	13.458	14.844	PASS
Band4	15	20175	75	#0	QPSK	13.464	14.846	PASS
Band4	15	20175	75	#0	16QAM	13.481	14.717	PASS