



RF TEST REPORT

Product Name: Smart Phone

Model Name: CP12Q

FCC ID: R38YLCP12Q

Issued For : Yulong Computer Telecommunication Scientific (Shenzhen)
Co., Ltd
Floor 20, Block C, Coolpad Building North High-Tech Industrial
Park, Nanshan District, Shenzhen, China

Issued By : Shenzhen LGT Test Service Co., Ltd.
Room 205, Building 13, Zone B, Zhenxiong Industrial Park,
No.177, Renmin West Road, Jinsha, Kengzi Street, Pingshan
District, Shenzhen, Guangdong, China

Report Number: LGT24B032RF05

Sample Received Date: Feb. 26, 2024

Date of Test: Feb. 26, 2024 – Mar. 26, 2024

Date of Issue: Mar. 26, 2024

The test report is effective only with both signature and specialized stamp. This report shall not be reproduced except in full without the written approval of the Laboratory. The results in this report only apply to the tested sample.

TEST REPORT CERTIFICATION

Applicant: Yulong Computer Telecommunication Scientific (Shenzhen) Co., Ltd
Address: Floor 20, Block C, Coolpad Building North High-Tech Industrial Park, Nanshan District, Shenzhen, China

Manufacturer: Yulong Computer Telecommunication Scientific (Shenzhen) Co., Ltd
Address: Floor 20, Block C, Coolpad Building North High-Tech Industrial Park, Nanshan District, Shenzhen, China

Product Name: Smart Phone

Trademark: coolpad

Model Name: CP12Q

Sample Status: Normal

APPLICABLE STANDARDS	
STANDARD	TEST RESULTS
FCC Part 22H and 24E, 27 KDB 971168 D01 v03r01, ANSI C63.26(2015)	PASS

Prepared by:

Zane Shan

Zane Shan
Engineer

Approved by:

Vita Li

Vita Li
Technical Director



Table of Contents

Page

1 SUMMARY OF TEST RESULTS	5
2 INTRODUCTION	6
2.1 TEST FACTORY	6
2.2 MEASUREMENT UNCERTAINTY	6
3. PRODUCT INFORMATION	7
4 TEST CONFIGURATION OF EQUIPMENT UNDER TEST	8
5 MEASUREMENT INSTRUMENTS	9
6 TEST ITEMS	10
6.1 CONDUCTED OUTPUT POWER	10
6.2 PEAK TO AVERAGE RATIO	11
6.3 TRANSMITTER RADIATED POWER (EIRP/ERP)	12
6.4 OCCUPIED BANDWIDTH	13
6.5 FREQUENCY STABILITY	14
6.6 SPURIOUS EMISSIONS AT ANTENNA TERMINALS	15
6.7 BAND EDGE	16
6.8 FIELD STRENGTH OF SPURIOUS RADIATION MEASUREMENT	17
APPENDIX I - TESTRESULT	19
2G	19
CONDUCTED OUTPUT POWER	19
FREQUENCY STABILITY	20
PEAK-TO-AVERAGE RATIO	23
OCCUPIED BANDWIDTH	30
BAND EDGE	37
OUT-OF-BAND EMISSIONS	42
RADIATED SPURIOUS EMISSION	49
3G	55
CONDUCTED OUTPUT POWER	55
FREQUENCY STABILITY	58
PEAK-TO-AVERAGE RATIO	60
OCCUPIED BANDWIDTH	64
BAND EDGE	68
OUT-OF-BAND EMISSIONS	71
RADIATED SPURIOUS EMISSION	75
APPENDIX II - PHOTOS OF TEST SETUP	84

Revision History

Rev.	Issue Date	Revisions
00	Mar. 26, 2024	Initial Issue

1 SUMMARY OF TEST RESULTS

Test procedures according to the technical standards:

The radiated emission testing was performed according to the procedures of KDB 971168 D01 v03r01 and ANSI C63.26-2015

FCC Rules	Test Description	Test Limit	Test Result	Reference
2.1046	Conducted Output Power	Reporting Only	PASS	
22.913d 24.232d	Peak-to-Average Ratio	< 13 dB	PASS	
2.1046 22.913 24.232 27.50	Effective Radiated Power/Equivalent Isotropic Radiated Power	< 7 Watts max. ERP(Part 22) < 2 Watts max. EIRP(Part 24) <1 Watts max. EIRP(Part 27)	PASS	
2.1049 22.917 24.238 27.53	Occupied Bandwidth	Reporting Only	PASS	
2.1055 22.355 24.235 27.54	Frequency Stability	< 2.5 ppm (Part 22) Emission must remain in band (Part 24) Emission must remain in band (Part 27)	PASS	
2.1051 22.917 24.238 27.53	Spurious Emission at Antenna Terminals	< 43+10log ₁₀ (P[Watts])	PASS	
2.1053 22.917 24.238 27.53	Field Strength of Spurious Radiation	< 43+10log ₁₀ (P[Watts])	PASS	
2.1051 22.917 24.238 27.53	Band Edge	< 43+10log ₁₀ (P[Watts])	PASS	

2 INTRODUCTION

2.1 TEST FACTORY

Company Name:	Shenzhen LGT Test Service Co., Ltd.
Address:	Room 205, Building 13, Zone B, Zhenxiong Industrial Park, No.177, Renmin West Road, Jinsha, Kengzi Street, Pingshan District, Shenzhen, Guangdong, China
Accreditation Certificate	A2LA Certificate No.: 6727.01
	FCC Registration No.: 746540
	CAB ID: CN0136

2.2 MEASUREMENT UNCERTAINTY

The measurement uncertainties shown below were calculated in accordance with the requirements of ANSI C63.26. All measurement uncertainty values are shown with a coverage factor of $k = 2$ to indicate a 95% level of confidence. The measurement data shown herein meets or exceeds the UCISPR measurement uncertainty values specified in CISPR 16-4-2 and, thus, can be compared directly to specified limits to determine compliance.

No.	Item	Uncertainty
1	RF output power, conducted	$\pm 0.68\text{dB}$
2	Unwanted Emissions, conducted	$\pm 2.988\text{dB}$
3	All emissions, radiated 9K-30MHz	$\pm 2.84\text{dB}$
4	All emissions, radiated 30M-1GHz	$\pm 4.39\text{dB}$
5	All emissions, radiated 1G-6GHz	$\pm 5.10\text{dB}$
6	All emissions, radiated >6G	$\pm 5.48\text{dB}$
7	Conducted Emission (9KHz-150KHz)	$\pm 2.79\text{dB}$
8	Conducted Emission (150KHz-30MHz)	$\pm 2.80\text{dB}$

Note: The measurement uncertainty is not included in the test result.

3. PRODUCT INFORMATION

Product Name:	Smart Phone
Trademark:	coolpad
Model Name:	CP12Q
Series Model:	N/A
Model Difference:	N/A
Tx Frequency:	GSM/GPRS/EDGE: 850: 824 MHz ~ 849MHz 1900: 1850 MHz ~ 1910MHz WCDMA: Band V: 824 MHz ~ 849 MHz Band II: 1850 MHz ~ 1910 MHz Band IV: 1710 MHz ~ 1755 MHz
Rx Frequency:	GSM/GPRS/EDGE: 850: 869 MHz ~ 894 MHz 1900: 1930 MHz ~ 1990MHz WCDMA: Band V: 869 MHz ~ 894 MHz Band II: 1930 MHz ~ 1990 MHz Band IV: 2110 MHz ~ 2155 MHz
Modulation Characteristics:	GMSK for GSM/GPRS; GMSK and 8PSK for EDGE WCDMA: QPSK; HSDPA: QPSK/16QAM; HSUPA: BPSK
SIM Card:	SIM 1 and SIM 2 is a chipset unit and tested as single chipset, SIM 1 is used to tested.
Antenna:	FPC
Antenna gain:	2G 850: -5.6dBi, 2G 1900: -0.6dBi 3G WCDMA BAND 2: -0.6dBi 3G WCDMA BAND 4: --1.6dBi 3G WCDMA BAND 5: -5.6dBi
Adapter:	Input: 100-240V, 50-60Hz, 0.3A Output: 5V, 2A
Battery:	Capacity: 4500mAh Rated Voltage: 3.85V
EGPRS Class:	Multi-Class12
Extreme Vol. Limits:	3.6V to 4.35V (Nominal 3.85V)
Extreme Temp. Tolerance:	-20°C to + 55°C
Hardware version:	V1.0
Software version:	full_k62v1_64bsp-userdebug 12 SP1A.210812.016mp1V14105 test-keys

**** Note: The High Voltage 4.35V and Low Voltage 3.6V was declared by manufacturer, The EUT couldn't be operate normally with higher or lower voltage, the antenna information refer the manufacturer provide report, applicable only to the tested sample identified in the report.**

4 TEST CONFIGURATION OF EQUIPMENT UNDER TEST

Antenna port conducted and radiated test items were performed according to KDB 971168 D01 and ANSI C63.26 2015 Power Meas. License Digital Systems with maximum output power.

Radiated measurements were performed with rotating EUT in different three orthogonal test planes to find the maximum emission.

Radiated emissions were investigated as following frequency range:

1. 30 MHz to 10th harmonic for GSM850/WCDMA Band V.
2. 30 MHz to 10th harmonic for GSM1900 and WCDMA Band II/ WCDMA Band IV.

All modes and data rates and positions were investigated.

Test modes are chosen to be reported as the worst-case configuration below:

BAND	TEST MODES	
	RADIATED TCS	CONDUCTED TCS
GSM 850	GSM LINK GPRS/EDGE CLASS 12 LINK	GSM LINK GPRS/EDGE CLASS 12 LINK
GSM 1900	GSM LINK GPRS/EDGE CLASS 12 LINK	GSM LINK GPRS/EDGE CLASS 12 LINK
WCDMA BAND V	RMC 12.2KBPS LINK	RMC 12.2KBPS LINK
WCDMA BAND IV	RMC 12.2KBPS LINK	RMC 12.2KBPS LINK
WCDMA BAND II	RMC 12.2KBPS LINK	RMC 12.2KBPS LINK

5 MEASUREMENT INSTRUMENTS

Radiation Test equipment					
Equipment	Manufacturer	Model No.	Serial No.	Cal. Date	Cal. Until
EMI Test Receiver	R&S	ESU	100372	2023.04.13	2024.04.12
Spectrum Analyzer	Keysight	N9010B	MY60242508	2023.08.14	2024.08.13
Active loop Antenna	ETS	6502	00049544	2022.06.02	2025.06.01
Bilog Antenna	SCHWARZBECK	VULB 9168	01447	2022.12.12	2025.12.11
Horn Antenna	SCHWARZBECK	3115	10SL0060	2022.06.02	2025.06.01
Pre-amplifier (9kHz-1GHz)	EMtrace	RP01A	02017	2023.04.07	2024.04.06
Pre-amplifier(1-26.5G)	Agilent	8449B	3008A4722	2023.04.07	2024.04.06
RE Cable (9K-1G)	N.A	R01	N.A	2023.04.07	2024.04.06
RE Cable (1-26G)	N.A	R02	N.A	2023.04.07	2024.04.06
Temperature & Humidity	KTJ	TA218B	N.A	2023.04.24	2024.04.23
Testing Software	EMC-I_V1.4.0.3_SKET				

RF Connected Test equipment					
Equipment	Manufacturer	Model No.	Serial No.	Cal. Date	Cal. Until
Signal Generator	Keysight	N5182B	MY59100717	2023.04.07	2024.04.06
Signal Analyzer	Keysight	N9010B	MY60242508	2023.08.14	2024.08.13
Wireless Communications Test Set	R&S	CMW 500	137737	2023.04.13	2024.04.12
Temperature & Humidity	KTJ	TA218B	N/A	2023.04.24	2024.04.23
Temperature & Humidity test chamber	AISRY	LX-1000L	171200018	2023.08.14	2024.08.13
Attenuator	eastsheep	90db	N/A	2023.04.10	2024.04.09
Testing Software	MTS 8310_2.0.0.0_MWRF-TEST				

Equipment with a calibration date of “NCR” shown in this list was not used to make direct calibrated measurements.

6 TEST ITEMS

6.1 CONDUCTED OUTPUT POWER

TEST OVERVIEW

A system simulator was used to establish communication with the EUT. Its parameters were set to enforce EUT transmitting at the maximum power. The measured power in the radio frequency on the transmitter output terminals shall be reported.

TEST PROCEDURES

1. The transmitter output port was connected to the system simulator.
2. Set eut at maximum power through the system simulator.
3. Select lowest, middle, and highest channels for each band and different modulation.
4. Measure and record the power level from the system simulator.

TEST SETUP



TEST RESULT

Note: Test data See APPENDIX I.

6.2 PEAK TO AVERAGE RATIO

TEST OVERVIEW

According to §24.232(d), power measurements for transmissions by stations authorized under this section may be made either in accordance with a commission-approved average power technique or in compliance with paragraph (e) of this section. In both instances, equipment employed must be authorized in accordance with the provisions of §24.51. In measuring transmissions in this band using an average power technique, the peak-to-average ratio (PAR) of the transmission may not exceed 13 db.

TEST PROCEDURES

1. The testing follows FCC KDB 971168 v03r01 section.
2. The eut was connected to the peak and av system simulator& spectrum analyzer.
3. Select lowest, middle, and highest channels for each band and different modulation.
4. Set the test probe and measure average power of the spectrum analysis,

TEST SETUP

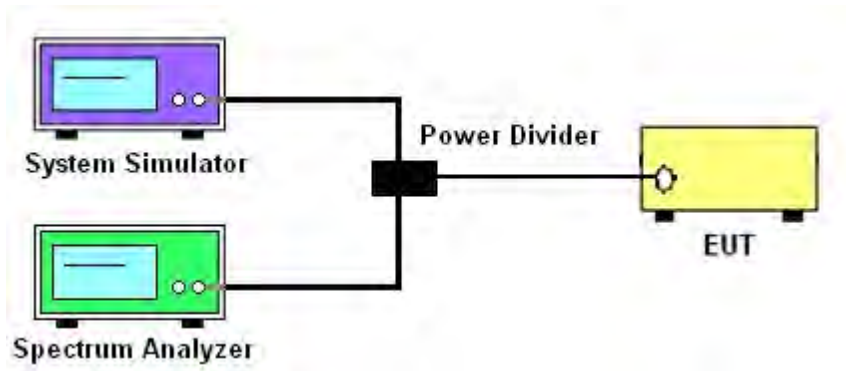

TEST RESULT

Note: Test data See APPENDIX I.

6.3 TRANSMITTER RADIATED POWER (EIRP/ERP)

TEST OVERVIEW

Effective Radiated Power (ERP) and Equivalent Isotropic Radiated Power (EIRP) measurements are performed using the substitution method described in ANSI C63.26 2015 with the EUT transmitting into an integral antenna. Measurements on signals operating below 1GHz are performed using vertically polarized tuned dipole antennas. Measurements on signals operating above 1GHz are performed using vertically polarized broadband horn antennas. All measurements are performed as RMS average measurements while the EUT is operating at maximum power, and at the appropriate frequencies.

TEST PROCEDURE

1. The testing follows FCC KDB 971168 Section 5.8 and ANSI C63.26-2015 Section 5.2.
2. The transmitter was placed on a wooden turntable, and it was transmitting into a non-radiating load which was also placed on the turntable.
3. The measurement antenna was placed at a distance of 3 meters from the EUT. During the tests, the antenna height and polarization as well as EUT azimuth were varied in order to identify the maximum level of emissions from the EUT. The test was performed by placing the EUT on 3-orthogonal axis.
4. The frequency range up to tenth harmonic of the fundamental frequency was investigated.
5. Remove the EUT and replace it with substitution antenna. A signal generator was connected to the substitution antenna by a nonradiating cable. The absolute levels of the spurious emissions were measured by the substitution.
6. Effective Isotropic Radiated Power (EIRP) was measured by substitution method according to ANSI C63.26-2015. The EUT was replaced by the substitution antenna at same location, and then a known power from S.G. was applied into the dipole antenna through a Tx cable, and then recorded the maximum Analyzer reading through raised and lowered the test antenna.
EIRP=S.G Level+ Gain-Cable loss; ERP=S.G Level+ Gain-Cable loss-2.15.

TEST RESULT

Note: Test data See APPENDIX I.

6.4 OCCUPIED BANDWIDTH

TEST OVERVIEW

The occupied bandwidth, that is the frequency bandwidth such that, below its lower and above its upper frequency limits, the mean powers radiated are each equal to 0.5 percent of the total mean power radiated by a given emission shall be measured.

The 26 dB emission bandwidth is defined as the frequency range between two points, one above and one below the carrier frequency, at which the spectral density of the emission is attenuated 26 dB below the maximum in-band spectral density of the modulated signal. Spectral density (power per unit bandwidth) is to be measured with a detector of resolution bandwidth equal to approximately 1.0% of the emission bandwidth.

All modes of operation were investigated and the worst-case configuration results are reported in this section.

TEST PROCEDURE

1. The signal analyzer's automatic bandwidth measurement capability was used to perform the 99% occupied bandwidth and the 26dB bandwidth. The bandwidth measurement was not influenced by any intermediate power nulls in the fundamental emission.
2. RBW = 1 – 5% of the expected OBW
3. VBW $\geq 3 \times$ RBW
4. Detector = Peak
5. Trace mode = max hold
6. Sweep = auto couple
7. The trace was allowed to stabilize
8. If necessary, steps 2 – 7 were repeated after changing the RBW such that it would be within 1 – 5% of the 99% occupied bandwidth observed in Step 7

TEST SETUP

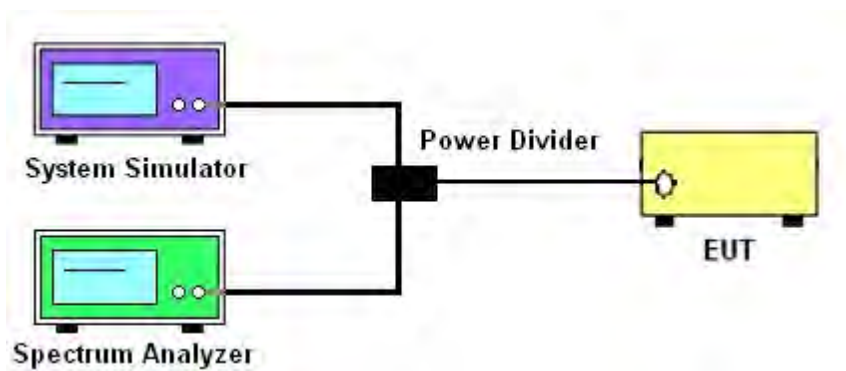

TEST RESULT

Note: Test data See APPENDIX I.

6.5 FREQUENCY STABILITY

TEST OVERVIEW

Frequency stability testing is performed in accordance with the guidelines of ANSI C63.26 2015. The frequency stability of the transmitter is measured by:

- a.) Temperature: The temperature is varied from -30°C to $+50^{\circ}\text{C}$ in 10°C increments using an environmental chamber.
- b.) Primary Supply Voltage: The primary supply voltage is varied from 85% to 115% of the nominal value for non hand-carried battery and AC powered equipment. For hand-carried, battery-powered equipment, primary supply voltage is reduced to the battery operating end point which shall be specified by the manufacturer.

For Part 22, the frequency stability of the transmitter shall be maintained within $\pm 0.00025\%$ (± 2.5 ppm) of the center frequency. For Part 24 the frequency stability shall be sufficient to ensure that the fundamental emission stays within the authorized frequency block.

TEST PROCEDURE

Temperature Variation

1. The testing follows FCC KDB 971168 D01 section 9.0
2. The EUT was set up in the thermal chamber and connected with the system simulator.
3. With power OFF, the temperature was decreased to -30°C and the EUT was stabilized before testing. Power was applied and the maximum change in frequency was recorded within one minute.
4. With power OFF, the temperature was raised in 10°C steps up to 50°C . The EUT was stabilized at each step for at least half an hour. Power was applied and the maximum frequency change was recorded within one minute.

Voltage Variation

1. The testing follows FCC KDB 971168 D01 Section 9.0.
2. The EUT was placed in a temperature chamber at $25\pm 5^{\circ}\text{C}$ and connected with the system simulator.
3. The power supply voltage to the EUT was varied from 85% to 115% of the nominal value measured at the input to the EUT.
4. The variation in frequency was measured for the worst case.

TEST SETUP

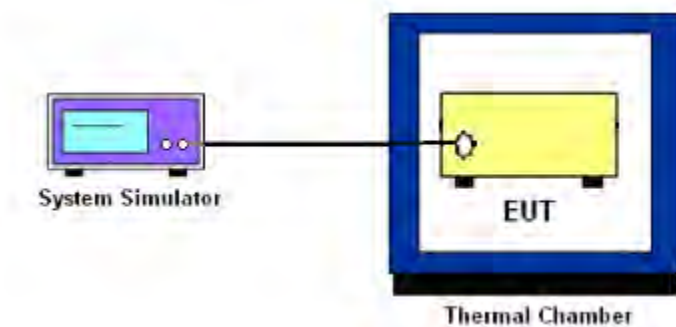

TEST RESULT

Note: Test data See APPENDIX I.

6.6 SPURIOUS EMISSIONS AT ANTENNA TERMINALS

TEST OVERVIEW

The power of any emission outside of the authorized operating frequency ranges must be lower than the transmitter power (P) by a factor of at least $43 + 10 \log (P)$ dB.

It is measured by means of a calibrated spectrum analyzer and scanned from 30 MHz up to a frequency including its 10th harmonic.

TEST PROCEDURE

1. The testing FCC KDB 971168 D01 v03r01 Section 6.0. and ANSI C63.26-2015-Section 5.7.
2. The EUT was connected to the spectrum analyzer and system simulator via a power divider.
3. The RF output of EUT was connected to the spectrum analyzer by an RF cable and attenuator. The path loss was compensated to the results for each measurement.
4. The middle channel for the highest RF power within the transmitting frequency was measured.
5. The conducted spurious emission for the whole frequency range was taken.
6. The RF fundamental frequency should be excluded against the limit line in the operating frequency band.
7. The limit line is derived from $43 + 10\log(P)$ dB below the transmitter power P(Watts)

$$= P(W) - [43 + 10\log(P)] \text{ (dB)}$$

$$= [30 + 10\log(P)] \text{ (dBm)} - [43 + 10\log(P)] \text{ (dB)}$$

$$= -13\text{dBm.}$$

TEST SETUP

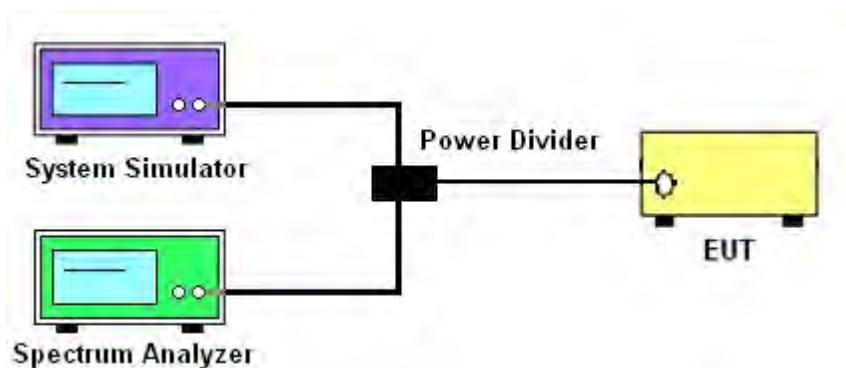

TEST RESULT

Note: Test data See APPENDIX I.

6.7 BAND EDGE

TEST OVERVIEW

All out of band emissions are measured with a spectrum analyzer connected to the antenna terminal of the EUT while the EUT is operating at maximum power, and at the appropriate frequencies. All data rates were investigated to determine the worst-case configuration. All modes of operation were investigated and the worst-case configuration results are reported in this section.

The minimum permissible attenuation level of any spurious emission is $43 + \log_{10}(P[\text{Watts}])$, where P is the transmitter power in Watts.

TEST PROCEDURE

1. The testing FCC KDB 971168 D01 v03r01 Section 6.0 and ANSI C63.26-2015-Section 5.7
2. Start and stop frequency were set such that the band edge would be placed in the center of the Plot.
3. The EUT was connected to the spectrum analyzer and system simulator via a power divider.
4. The RF output of EUT was connected to the spectrum analyzer by an RF cable and attenuator. The path loss was compensated to the results for each measurement.
5. The band edges of low and high channels for the highest RF powers were measured.
6. The RF fundamental frequency should be excluded against the limit line in the operating frequency band.
7. The limit line is derived from $43 + 10\log(P)$ dB below the transmitter power P(Watts)

$$= P(\text{W}) - [43 + 10\log(P)] (\text{dB})$$

$$= [30 + 10\log(P)] (\text{dBm}) - [43 + 10\log(P)] (\text{dB})$$

$$= -13\text{dBm}.$$

TEST SETUP

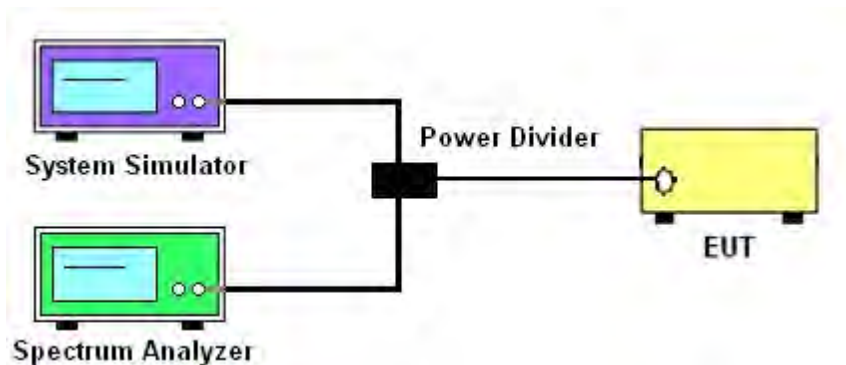

TEST RESULT

Note: Test data See APPENDIX I.

6.8 FIELD STRENGTH OF SPURIOUS RADIATION MEASUREMENT

TEST OVERVIEW

Radiated spurious emissions measurements are performed using the substitution method described in ANSI C63.26-2015 with the EUT transmitting into an integral antenna. Measurements on signals operating below 1GHz are performed using horizontally and vertically polarized tuned dipole antennas. Measurements on signals operating above 1GHz are performed using vertically and horizontally polarized horn antennas. All measurements are performed as peak measurements while the EUT is operating at maximum power and at the appropriate frequencies.

It is measured by means of a calibrated spectrum analyzer and scanned from 30 MHz up to a frequency including its 10th harmonic.

TEST PROCEDURE

1. The testing FCC KDB 971168 D01 Section 5.8 and ANSI C63.26-2015-Section 5.5.
2. RBW = 100kHz for emissions below 1GHz and 1MHz for emissions above 1GHz
3. VBW \geq 3 x RBW
4. Span = 1.5 times the OBW
5. No. of sweep points > 2 x span/RBW
6. Detector = Peak
7. Trace mode = max hold
8. The trace was allowed to stabilize
9. Effective Isotropic Spurious Radiation was measured by substitution method according to TIA/EIA-603-D. The EUT was replaced by the substitution antenna at same location, and then a known power from S.G. was applied into the dipole antenna through a Tx cable, and then recorded the maximum Analyzer reading through raised and lowered the test antenna.
 $P_{Mea} = S.G \text{ Level} + \text{Ant-Cable loss}$; $\text{Margin} = P_{Mea} - \text{Limit}$.

TEST SETUP

For radiated test from 30MHz to 1GHz

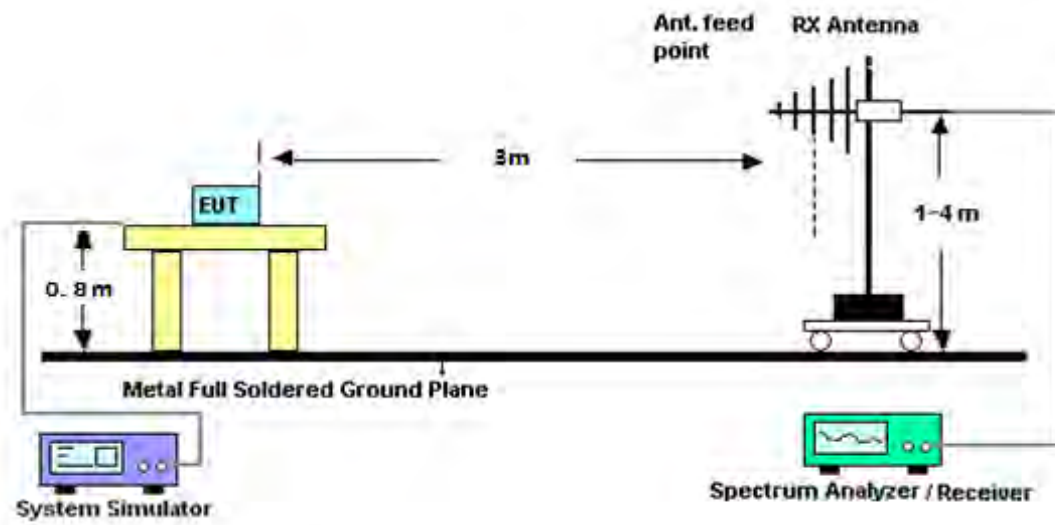

For radiated test from above 1GHz

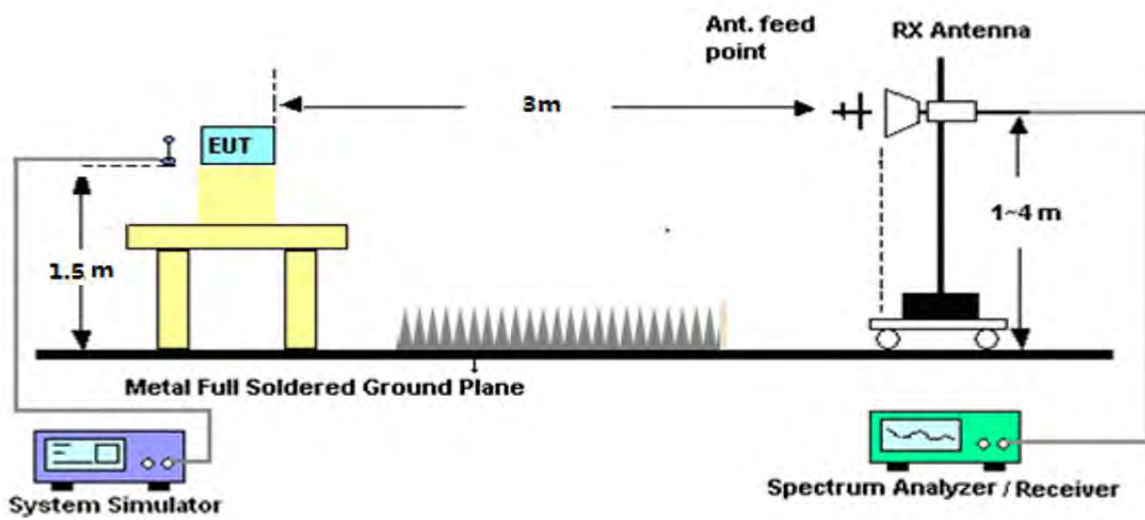

TEST RESULT

Note: Test data See APPENDIX I.

APPENDIX I - TESTRESULT

2G

Conducted output power

Band	Channel	Frequency (MHz)	Power (dBm)	Gain (dB)	ERP (dBm)	ERP Limit (dBm)	Verdict
GSM850	128	824.2	33.44	-5.6	25.69	38.45	PASS
GSM850	190	836.6	33.47	-5.6	25.72	38.45	PASS
GSM850	251	848.8	33.40	-5.6	25.65	38.45	PASS
GPRS850 1 Slot	128	824.2	33.48	-5.6	25.73	38.45	PASS
GPRS850 1 Slot	190	836.6	33.54	-5.6	25.79	38.45	PASS
GPRS850 1 Slot	251	848.8	33.45	-5.6	25.70	38.45	PASS
GPRS850 2 Slot	128	824.2	32.68	-5.6	24.93	38.45	PASS
GPRS850 2 Slot	190	836.6	32.68	-5.6	24.93	38.45	PASS
GPRS850 2 Slot	251	848.8	32.56	-5.6	24.81	38.45	PASS
GPRS850 3 Slot	128	824.2	30.78	-5.6	23.03	38.45	PASS
GPRS850 3 Slot	190	836.6	30.81	-5.6	23.06	38.45	PASS
GPRS850 3 Slot	251	848.8	30.67	-5.6	22.92	38.45	PASS
GPRS850 4 Slot	128	824.2	30.80	-5.6	23.05	38.45	PASS
GPRS850 4 Slot	190	836.6	29.65	-5.6	21.90	38.45	PASS
GPRS850 4 Slot	251	848.8	29.44	-5.6	21.69	38.45	PASS
EGPRS850 1 Slot	128	824.2	27.81	-5.6	20.06	38.45	PASS
EGPRS850 1 Slot	190	836.6	27.99	-5.6	20.24	38.45	PASS
EGPRS850 1 Slot	251	848.8	28.31	-5.6	20.56	38.45	PASS
EGPRS850 2 Slot	128	824.2	27.54	-5.6	19.79	38.45	PASS
EGPRS850 2 Slot	190	836.6	0.00	-5.6	-7.75	38.45	PASS
EGPRS850 2 Slot	251	848.8	26.89	-5.6	19.14	38.45	PASS
EGPRS850 3 Slot	128	824.2	25.02	-5.6	17.27	38.45	PASS
EGPRS850 3 Slot	190	836.6	24.77	-5.6	17.02	38.45	PASS
EGPRS850 3 Slot	251	848.8	24.61	-5.6	16.86	38.45	PASS
EGPRS850 4 Slot	128	824.2	24.01	-5.6	16.26	38.45	PASS
EGPRS850 4 Slot	190	836.6	23.72	-5.6	15.97	38.45	PASS
EGPRS850 4 Slot	251	848.8	23.78	-5.6	16.03	38.45	PASS

Band	Channel	Frequency (MHz)	Power (dBm)	Gain (dB)	EIRP (dBm)	EIRP Limit (dBm)	Verdict
GSM1900	512	1850.2	30.15	-0.6	29.55	33.01	PASS
GSM1900	661	1880	30.34	-0.6	29.74	33.01	PASS
GSM1900	810	1909.8	30.28	-0.6	29.68	33.01	PASS
GPRS1900 1 Slot	512	1850.2	30.14	-0.6	29.54	33.01	PASS
GPRS1900 1 Slot	661	1880	30.30	-0.6	29.70	33.01	PASS
GPRS1900 1 Slot	810	1909.8	30.26	-0.6	29.66	33.01	PASS
GPRS1900 2 Slot	512	1850.2	29.20	-0.6	28.60	33.01	PASS
GPRS1900 2 Slot	661	1880	29.33	-0.6	28.73	33.01	PASS
GPRS1900 2 Slot	810	1909.8	29.31	-0.6	28.71	33.01	PASS
GPRS1900 3 Slot	512	1850.2	27.27	-0.6	26.67	33.01	PASS
GPRS1900 3 Slot	661	1880	27.45	-0.6	26.85	33.01	PASS
GPRS1900 3 Slot	810	1909.8	27.45	-0.6	26.85	33.01	PASS
GPRS1900 4 Slot	512	1850.2	25.99	-0.6	25.39	33.01	PASS
GPRS1900 4 Slot	661	1880	26.11	-0.6	25.51	33.01	PASS
GPRS1900 4 Slot	810	1909.8	26.17	-0.6	25.57	33.01	PASS
EGPRS1900 1 Slot	512	1850.2	26.93	-0.6	26.33	33.01	PASS
EGPRS1900 1 Slot	661	1880	27.28	-0.6	26.68	33.01	PASS
EGPRS1900 1 Slot	810	1909.8	27.20	-0.6	26.60	33.01	PASS
EGPRS1900 2 Slot	512	1850.2	26.08	-0.6	25.48	33.01	PASS
EGPRS1900 2 Slot	661	1880	26.22	-0.6	25.62	33.01	PASS
EGPRS1900 2 Slot	810	1909.8	26.24	-0.6	25.64	33.01	PASS
EGPRS1900 3 Slot	512	1850.2	23.90	-0.6	23.30	33.01	PASS
EGPRS1900 3 Slot	661	1880	23.87	-0.6	23.27	33.01	PASS
EGPRS1900 3 Slot	810	1909.8	24.01	-0.6	23.41	33.01	PASS
EGPRS1900 4 Slot	512	1850.2	22.83	-0.6	22.23	33.01	PASS
EGPRS1900 4 Slot	661	1880	22.83	-0.6	22.23	33.01	PASS
EGPRS1900 4 Slot	810	1909.8	23.35	-0.6	22.75	33.01	PASS

Frequency stability

GSM 850 /836.6MHz					
Temperature (°C)	Voltage	Freq. Dev.	Freq. Dev.	Limit	Result
	(Volt)	(Hz)	(ppm)		
50	Normal Voltage	-9.92	-0.012	2.5ppm	PASS
40		-9.76	-0.012		
30		-10.08	-0.012		
20		18.47	0.022		
10		10.03	0.012		
0		10.34	0.012		
-10		9.92	0.012		
-20		9.85	0.012		
-30		10.03	0.012		
20		Maximum Voltage	-9.91		
20	BEP	10.20	0.012		

GPRS 850 /836.6MHz					
Temperature (°C)	Voltage	Freq. Dev.	Freq. Dev.	Limit	Result
	(Volt)	(Hz)	(ppm)		
50	Normal Voltage	500.56	0.598	2.5ppm	PASS
40		500.20	0.598		
30		-500.36	-0.598		
20		999.00	1.194		
10		500.04	0.598		
0		-500.30	-0.598		
-10		-500.11	-0.598		
-20		500.42	0.598		
-30		500.41	0.598		
20		Maximum Voltage	500.47		
20	BEP	-500.05	-0.598		

EGPRS 850 /836.6MHz					
Temperature (°C)	Voltage	Freq. Dev.	Freq. Dev.	Limit	Result
	(Volt)	(Hz)	(ppm)		
50	Normal Voltage	-10.82	-0.013	2.5ppm	PASS
40		10.95	0.013		
30		10.37	0.012		
20		19.66	0.023		
10		10.41	0.012		
0		10.43	0.012		
-10		10.38	0.012		
-20		10.37	0.012		
-30		-10.65	-0.013		
20		Maximum Voltage	-10.61		
20	BEP	10.92	0.013		

GSM 1900 / 1880MHz					
Temperature (°C)	Voltage	Freq. Dev.	Freq. Dev.	Limit	Result
	(Volt)	(Hz)	(ppm)		
50	Normal Voltage	-10.15	-0.005	Within Authorized Band	PASS
40		-9.66	-0.005		
30		10.21	0.005		
20		18.21	0.010		
10		-9.73	-0.005		
0		10.06	0.005		
-10		9.73	0.005		
-20		-9.66	-0.005		
-30		-9.69	-0.005		
20		Maximum Voltage	9.74		
20	BEP	10.00	0.005		

GPRS 1900 / 1880MHz					
Temperature (°C)	Voltage	Freq. Dev.	Freq. Dev.	Limit	Result
	(Volt)	(Hz)	(ppm)		
50	Normal Voltage	-12.29	-0.007	Within Authorized Band	PASS
40		-12.25	-0.007		
30		11.95	0.006		
20		22.70	0.012		
10		11.98	0.006		
0		12.27	0.007		
-10		11.96	0.006		
-20		12.41	0.007		
-30		12.29	0.007		
20		Maximum Voltage	-11.89		
20	BEP	-12.33	-0.007		

EGPRS 1900 / 1880MHz					
Temperature (°C)	Voltage	Freq. Dev.	Freq. Dev.	Limit	Result
	(Volt)	(Hz)	(ppm)		
50	Normal Voltage	-11.95	-0.006	Within Authorized Band	PASS
40		11.98	0.006		
30		-11.79	-0.006		
20		22.15	0.012		
10		11.72	0.006		
0		11.88	0.006		
-10		11.77	0.006		
-20		11.86	0.006		
-30		11.78	0.006		
20		Maximum Voltage	-11.94		
20	BEP	-11.85	-0.006		

Peak-to-Average Ratio

Band	Channel	Frequency (MHz)	Result (dB)	high Limit (dB)	Verdict
GSM850	128	824.2	2.74	13	PASS
GSM850	190	836.6	2.71	13	PASS
GSM850	251	848.8	2.76	13	PASS
GPRS850	128	824.2	2.81	13	PASS
GPRS850	190	836.6	2.76	13	PASS
GPRS850	251	848.8	2.83	13	PASS
EGPRS850	128	824.2	7.45	13	PASS
EGPRS850	190	836.6	8.10	13	PASS
EGPRS850	251	848.8	7.70	13	PASS
GSM1900	512	1850.2	2.81	13	PASS
GSM1900	661	1880	2.80	13	PASS
GSM1900	810	1909.8	2.79	13	PASS
GPRS1900	512	1850.2	2.86	13	PASS
GPRS1900	661	1880	2.84	13	PASS
GPRS1900	810	1909.8	2.83	13	PASS
EGPRS1900	512	1850.2	5.75	13	PASS
EGPRS1900	661	1880	6.04	13	PASS
EGPRS1900	810	1909.8	6.06	13	PASS

GSM850 Channel=128

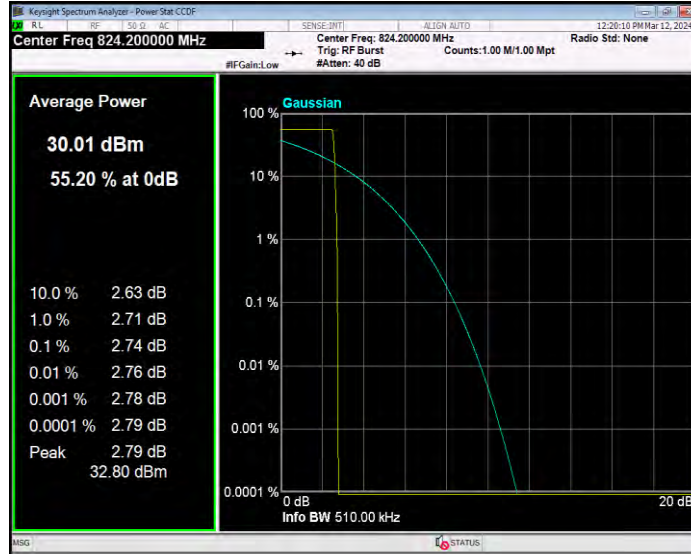

GSM850 Channel=190



GSM850 Channel=251



GPRS850 Channel=128

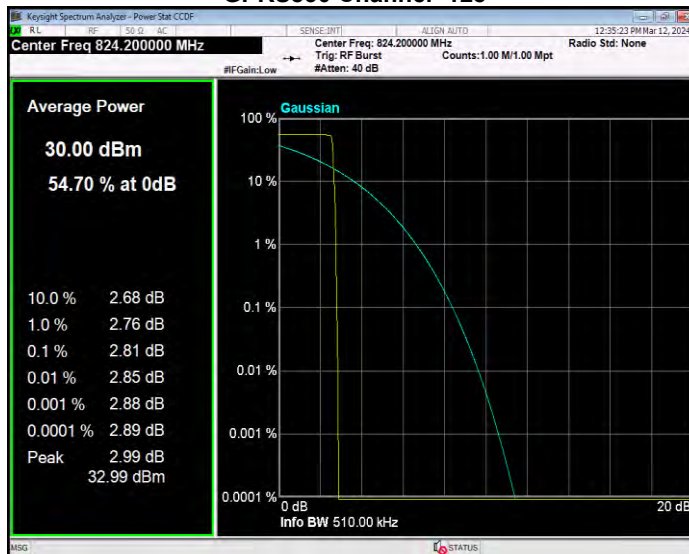

GPRS850 Channel=190



GPRS850 Channel=251

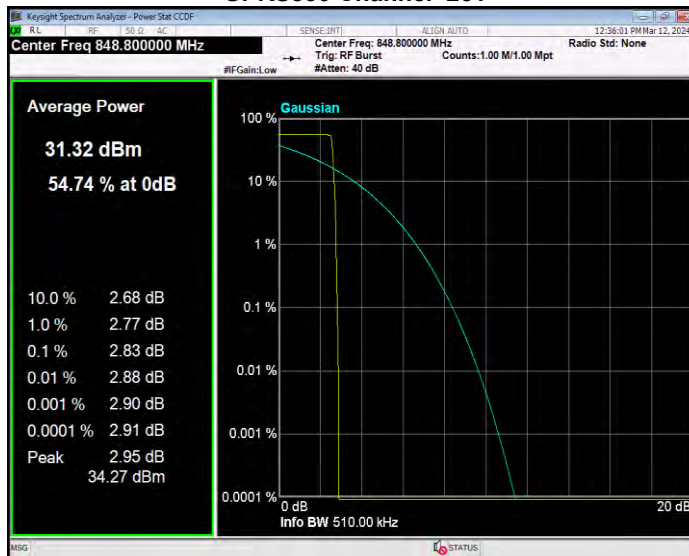

EGPRS850 Channel=128

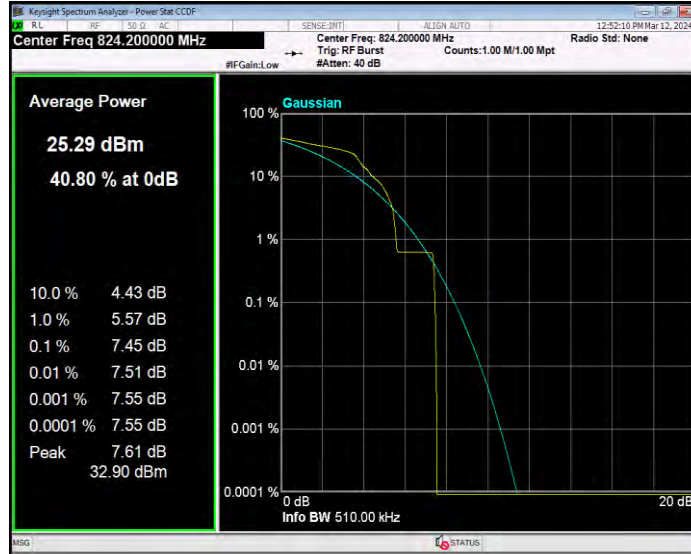

EGPRS850 Channel=190



EGPRS850 Channel=251



GSM1900 Channel=512

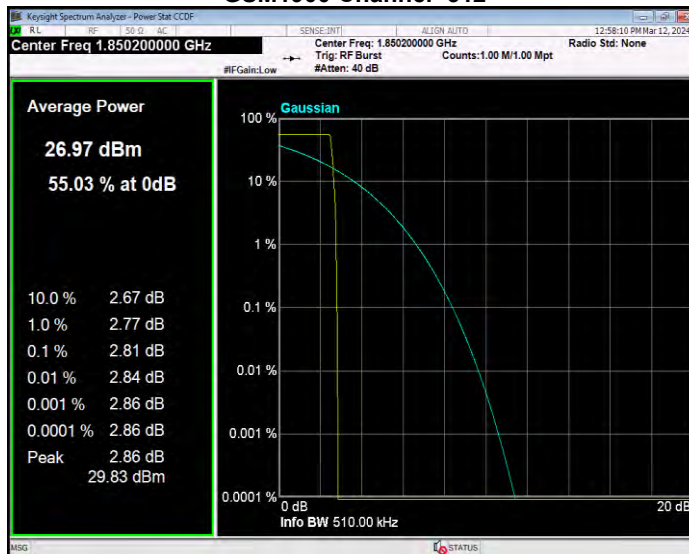

GSM1900 Channel=661



GSM1900 Channel=810

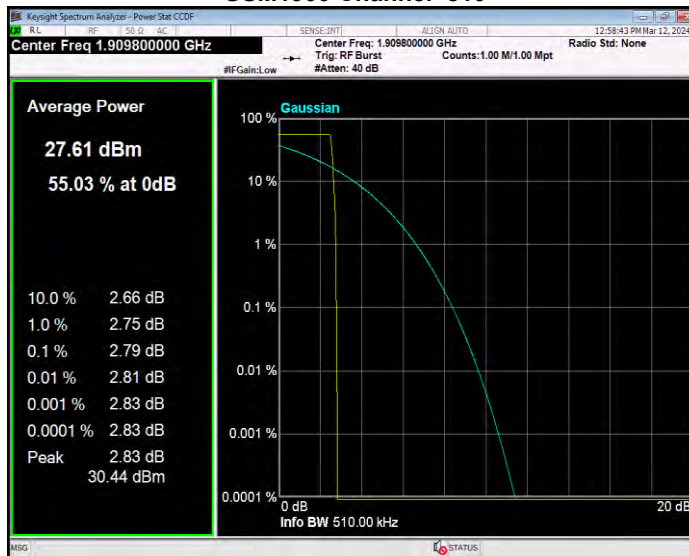

GPRS1900 Channel=512

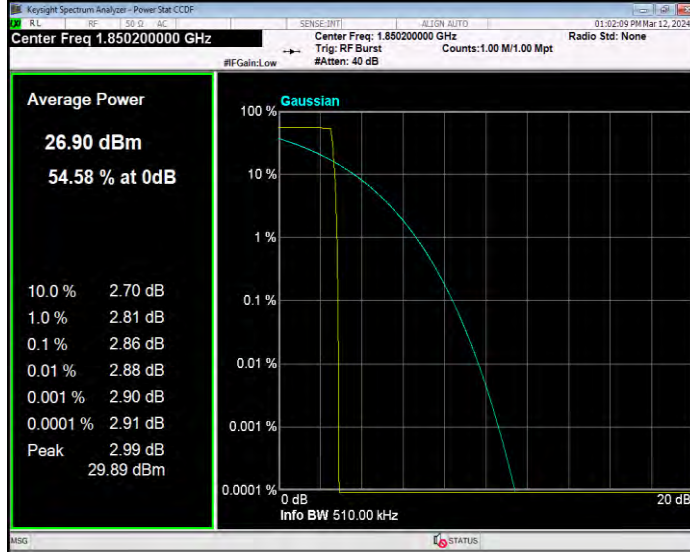

GPRS1900 Channel=661

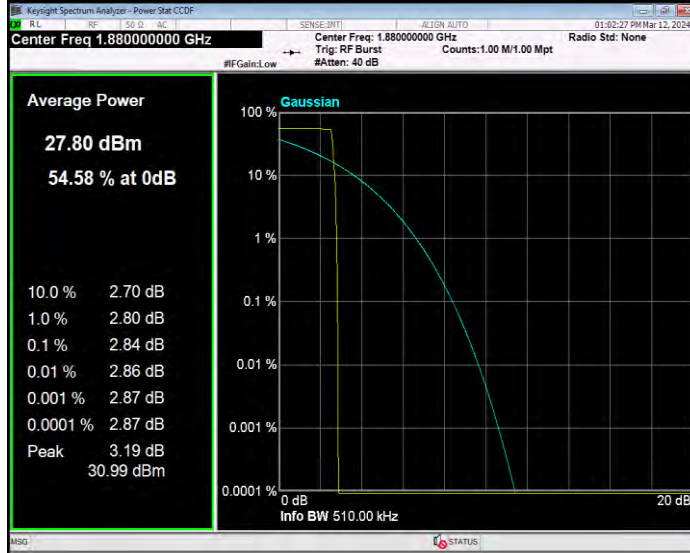

GPRS1900 Channel=810

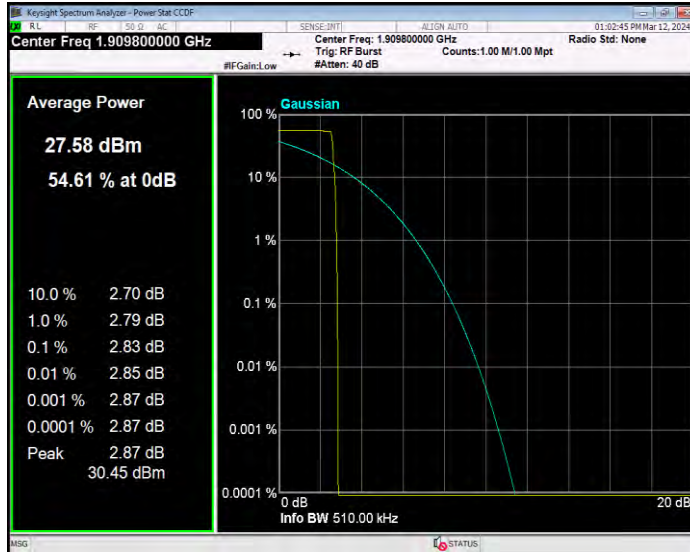

EGPRS1900 Channel=512

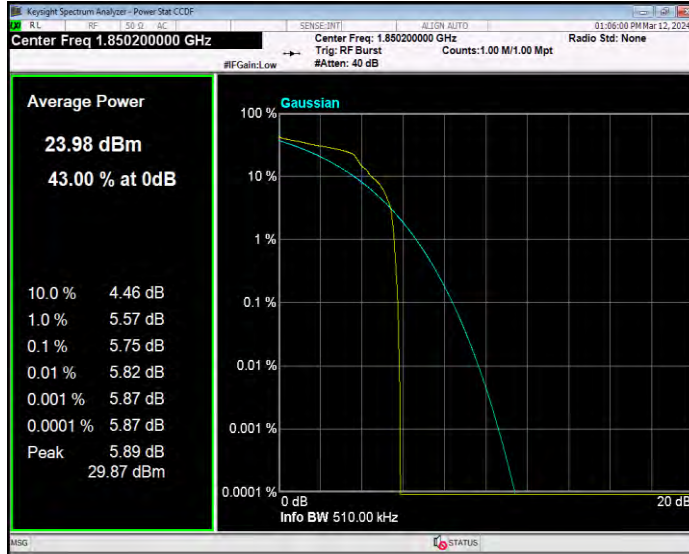

EGPRS1900 Channel=661

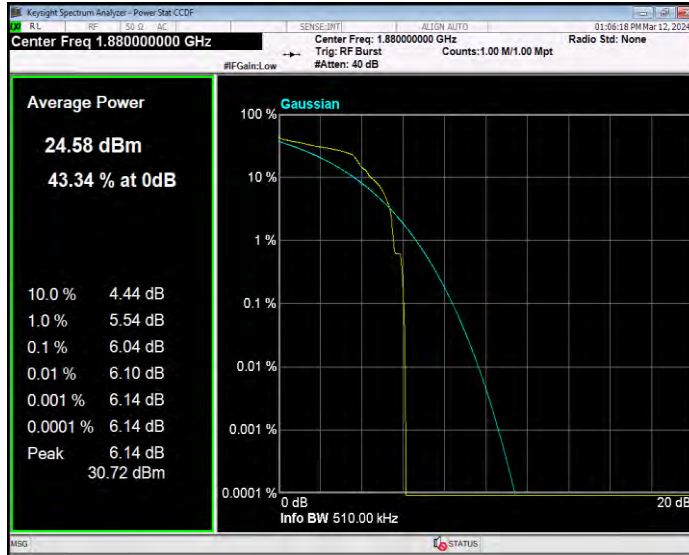

EGPRS1900 Channel=810



Occupied bandwidth

Band	Channel	Frequency (MHz)	99% OBW (kHz)	-26dB EBW (kHz)	Verdict
GSM850	128	824.2	240.151	310.116	PASS
GSM850	190	836.6	250.344	312.736	PASS
GSM850	251	848.8	254.207	323.270	PASS
GPRS850	128	824.2	242.184	320.842	PASS
GPRS850	190	836.6	244.867	312.950	PASS
GPRS850	251	848.8	250.085	326.355	PASS
EGPRS850	128	824.2	244.860	307.871	PASS
EGPRS850	190	836.6	244.419	298.962	PASS
EGPRS850	251	848.8	243.974	304.594	PASS
GSM1900	512	1850.2	247.464	321.481	PASS
GSM1900	661	1880	246.995	322.766	PASS
GSM1900	810	1909.8	241.339	326.756	PASS
GPRS1900	512	1850.2	251.682	321.844	PASS
GPRS1900	661	1880	246.861	320.330	PASS
GPRS1900	810	1909.8	250.051	322.298	PASS
EGPRS1900	512	1850.2	249.696	300.329	PASS
EGPRS1900	661	1880	249.338	319.917	PASS
EGPRS1900	810	1909.8	249.212	311.325	PASS

GSM850 Channel=128

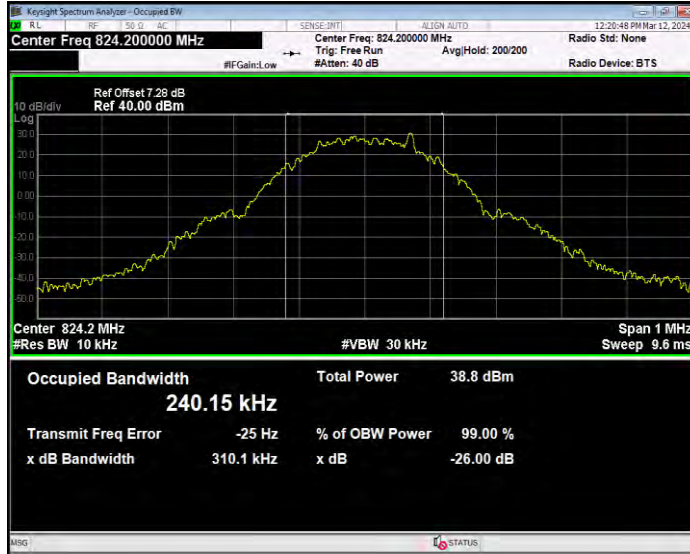

GSM850 Channel=190

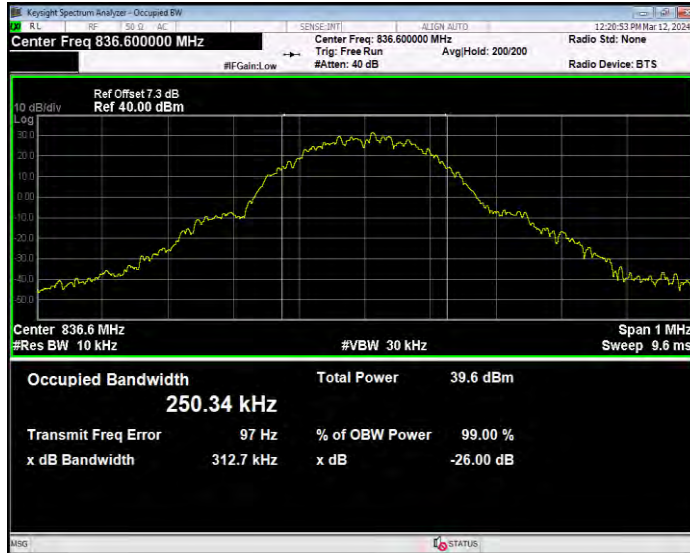

GSM850 Channel=251

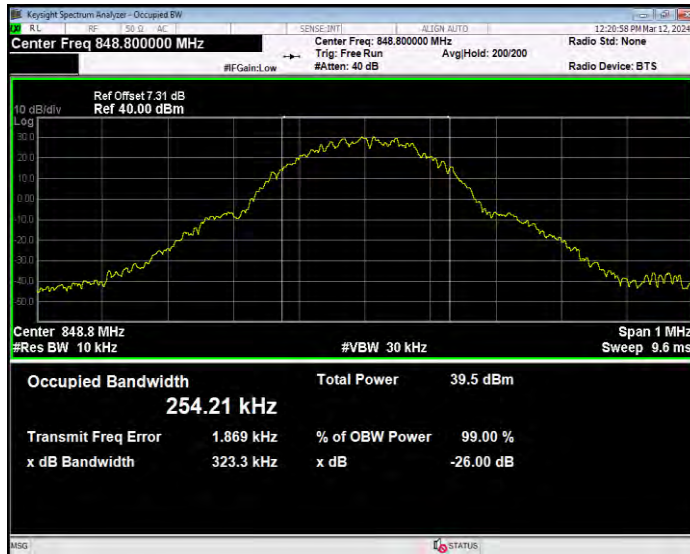

GPRS850 Channel=128

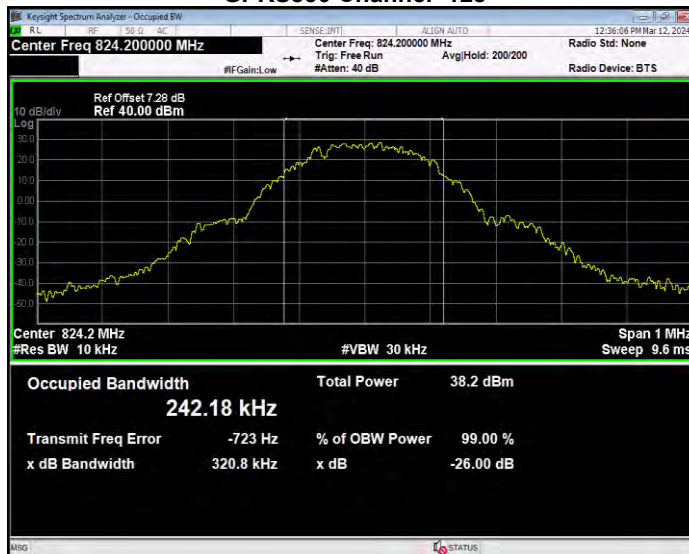

GPRS850 Channel=190

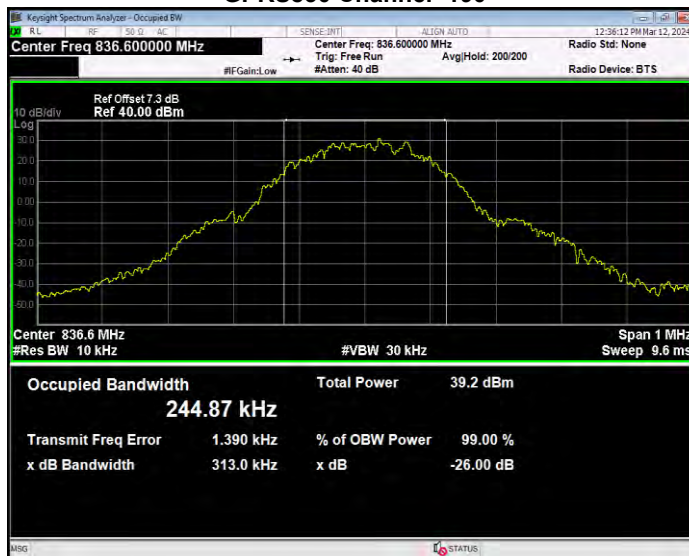

GPRS850 Channel=251

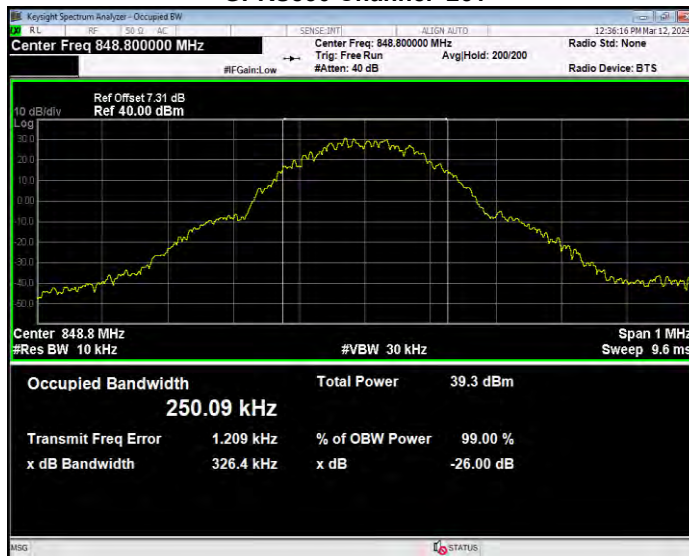

EGPRS850 Channel=128

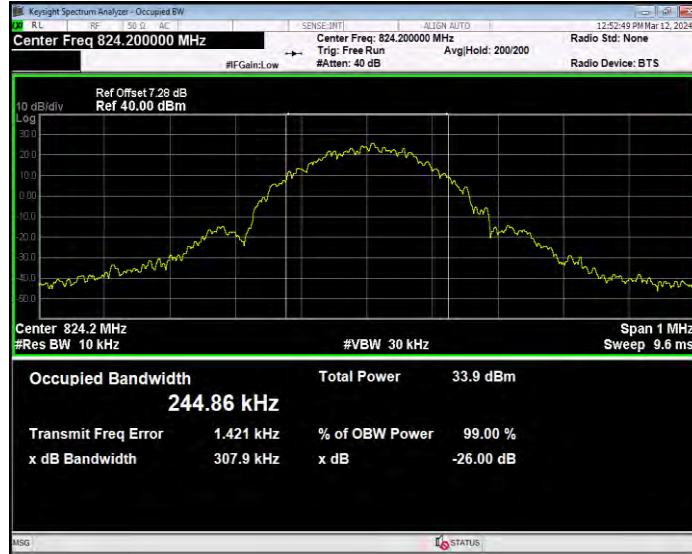

EGPRS850 Channel=190

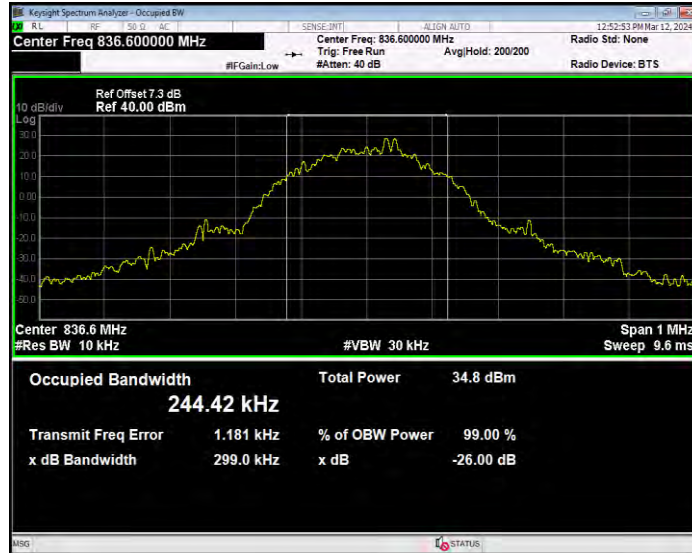

EGPRS850 Channel=251

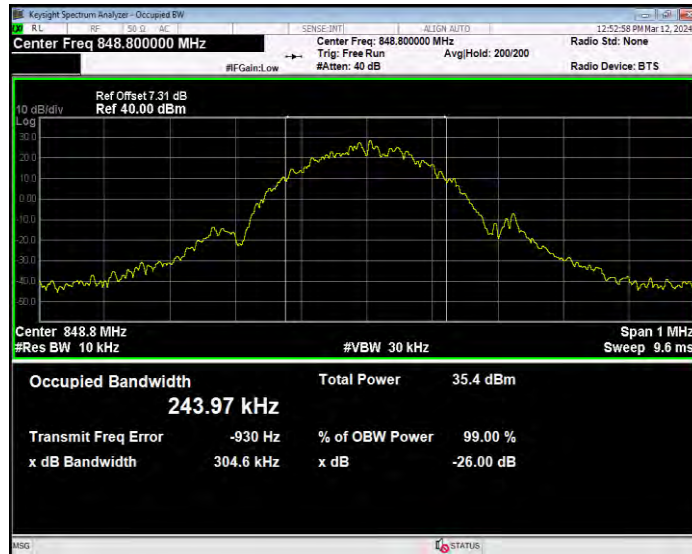

GSM1900 Channel=512

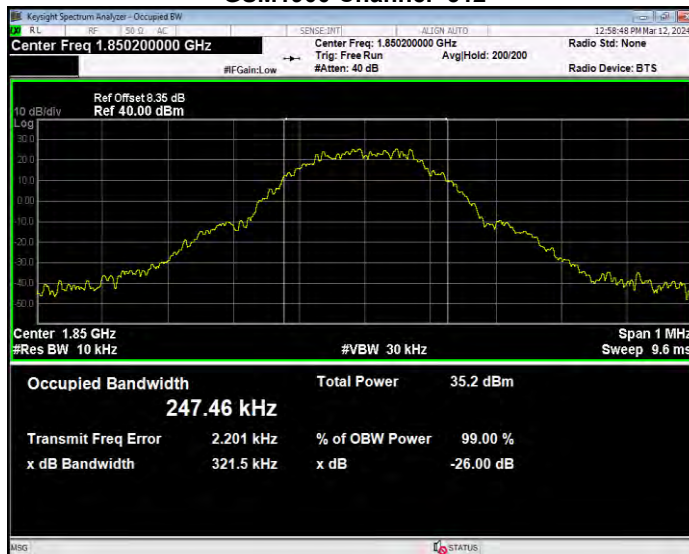

GSM1900 Channel=661

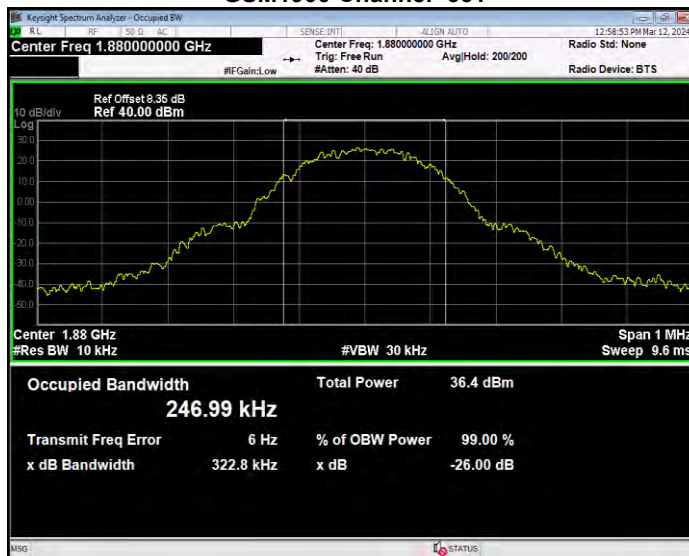

GSM1900 Channel=810

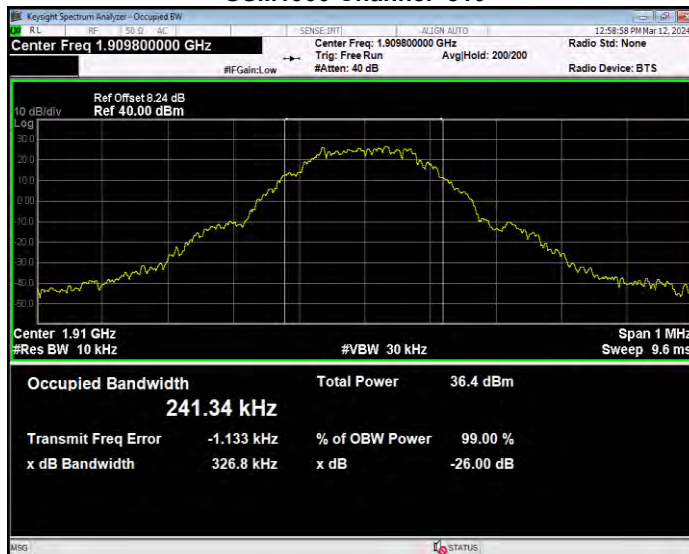

GPRS1900 Channel=512

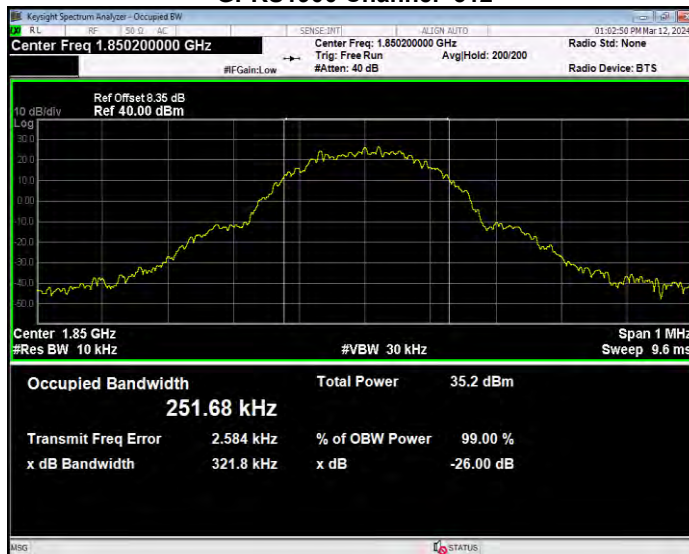

GPRS1900 Channel=661

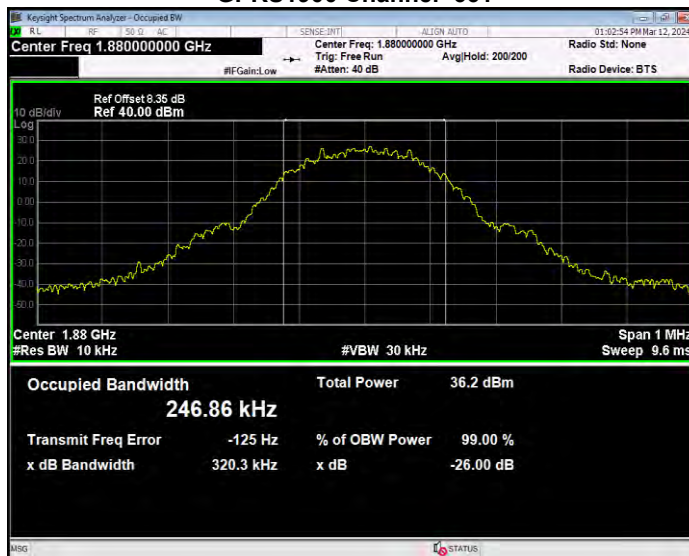

GPRS1900 Channel=810

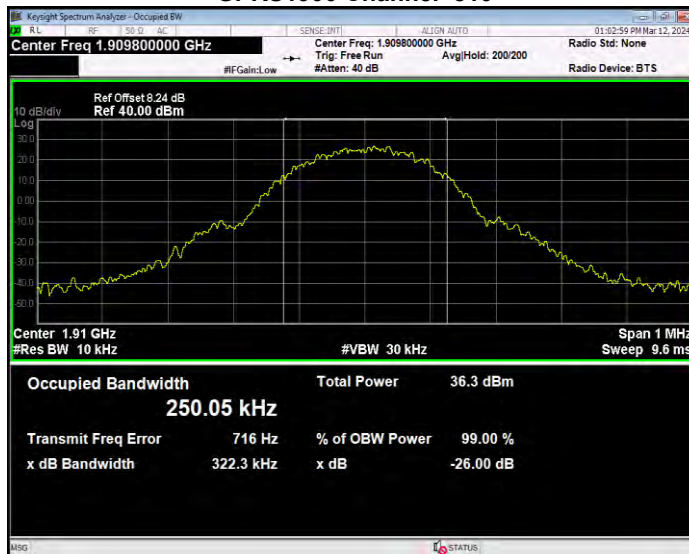

EGPRS1900 Channel=512

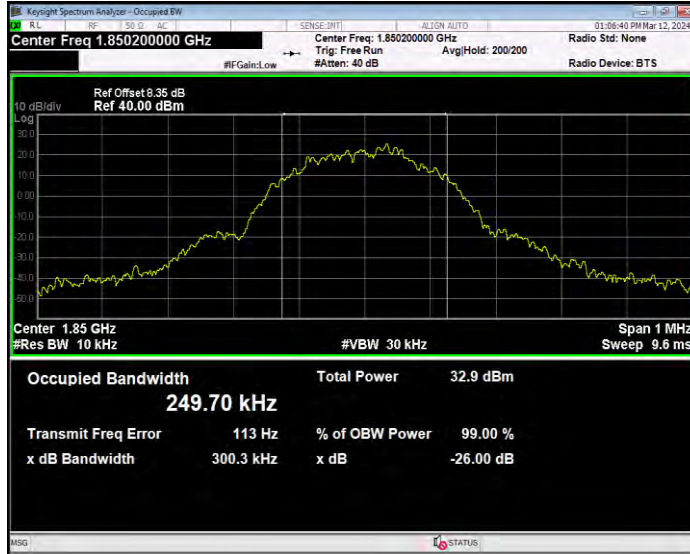

EGPRS1900 Channel=661

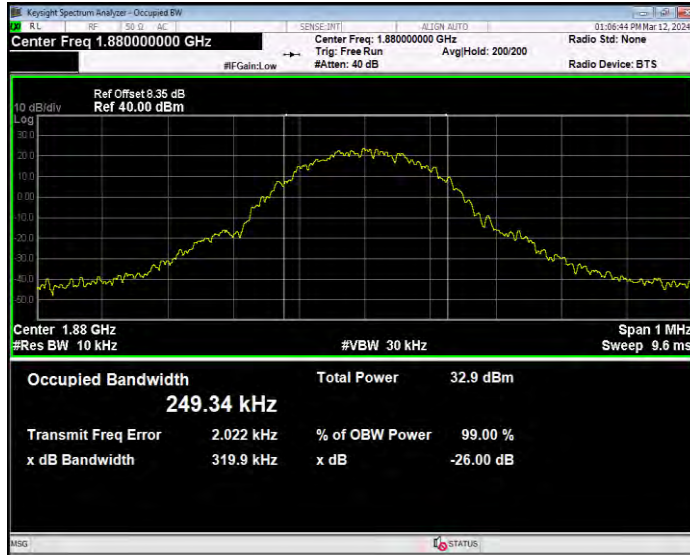

EGPRS1900 Channel=810

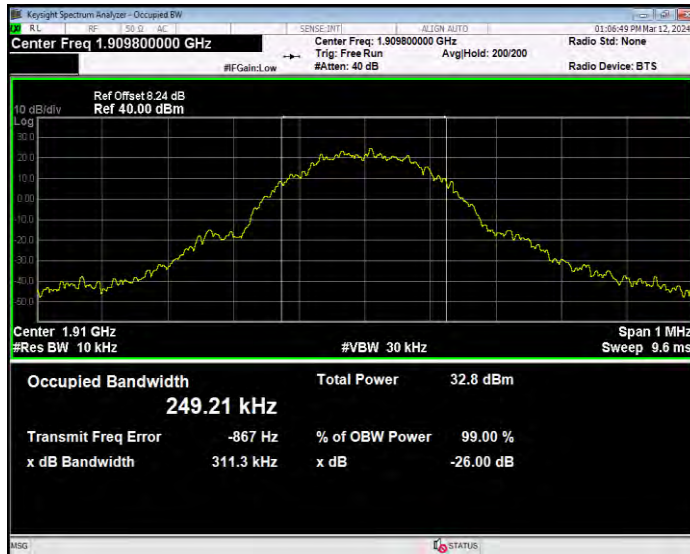

Band edge

Band	Channel	Frequency (MHz)	Spur Freq (MHz)	Spur Level (dBm)	Limit (dBm)	Verdict
GSM850	128	824.2	823.99	-28.01	-13	PASS
GSM850	251	848.8	849.02	-24.84	-13	PASS
GPRS850	128	824.2	823.98	-28.23	-13	PASS
GPRS850	251	848.8	849.02	-26.25	-13	PASS
EGPRS850	128	824.2	823.97	-35.09	-13	PASS
EGPRS850	251	848.8	849.02	-32.57	-13	PASS
GSM1900	512	1850.2	1850.00	-29.12	-13	PASS
GSM1900	810	1909.8	1910.02	-28.90	-13	PASS
GPRS1900	512	1850.2	1850.00	-31.36	-13	PASS
GPRS1900	810	1909.8	1910.02	-30.51	-13	PASS
EGPRS1900	512	1850.2	1849.98	-36.92	-13	PASS
EGPRS1900	810	1909.8	1910.01	-35.91	-13	PASS

GSM850 Channel=128

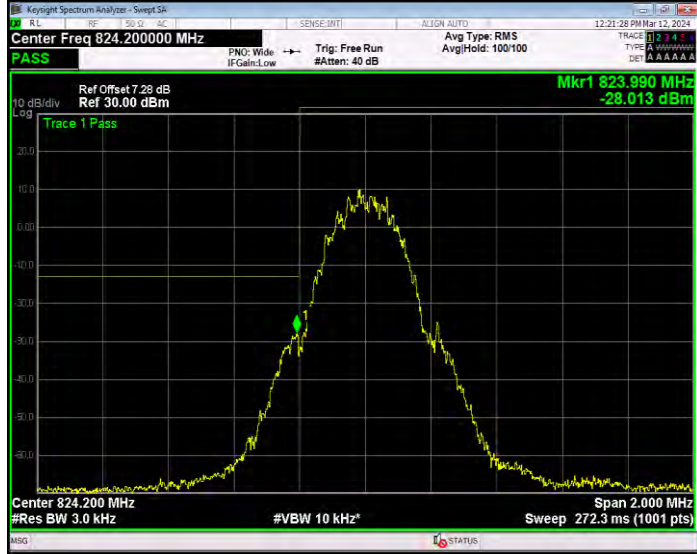

GSM850 Channel=251

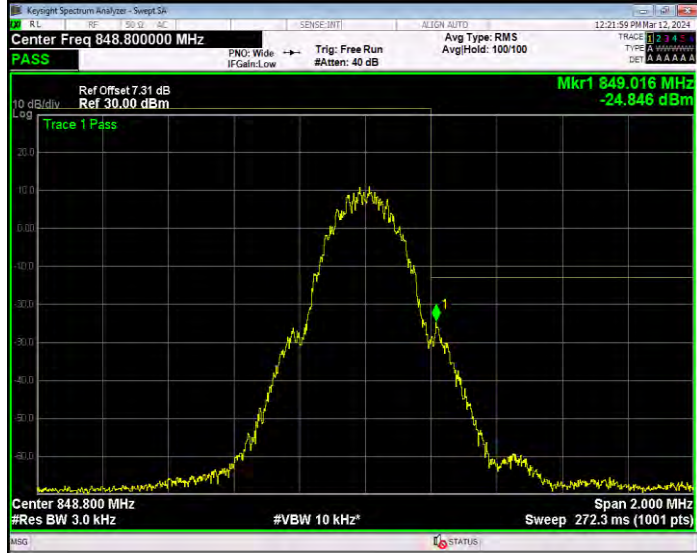

GPRS850 Channel=128

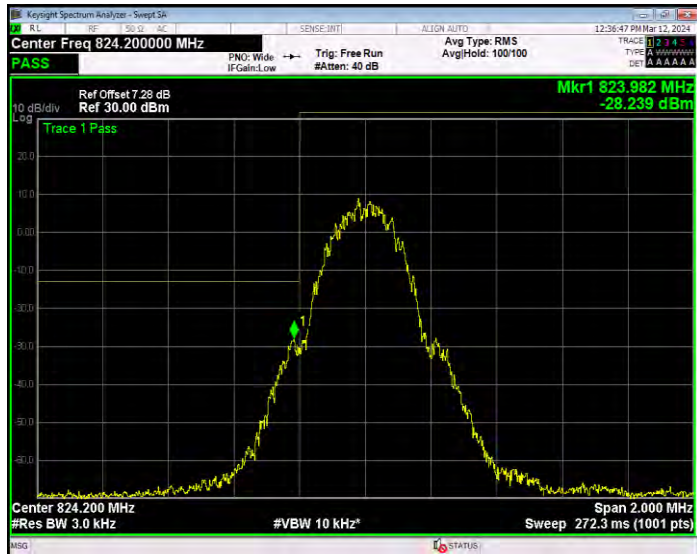

GPRS850 Channel=251



EGPRS850 Channel=128

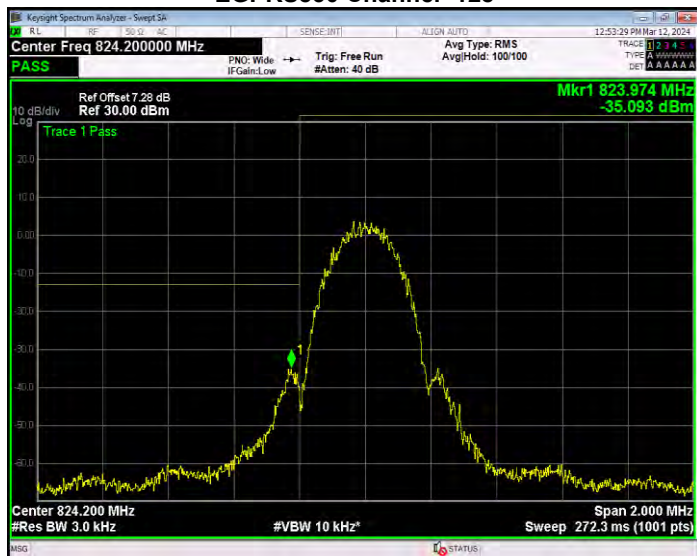

EGPRS850 Channel=251

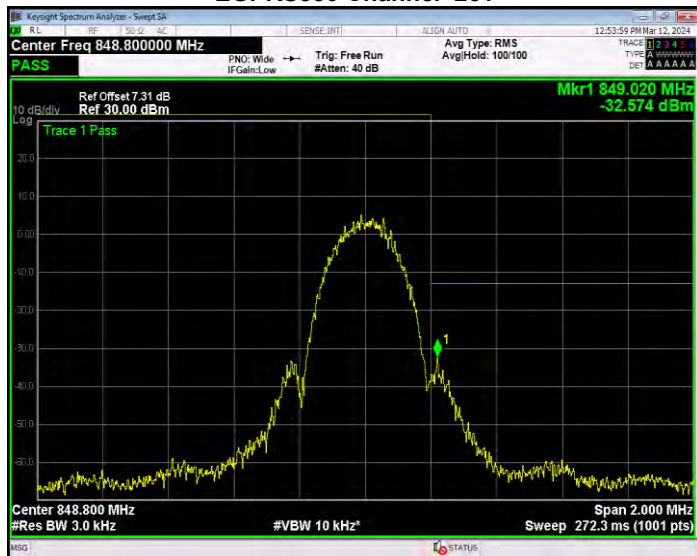

GSM1900 Channel=512

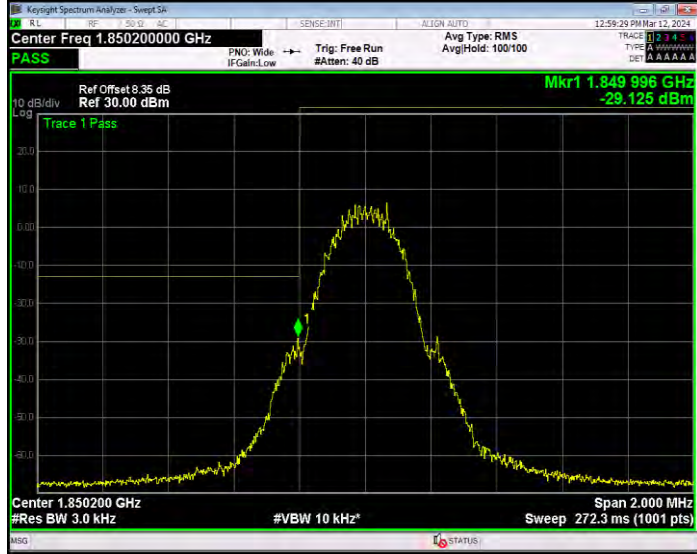

GSM1900 Channel=810

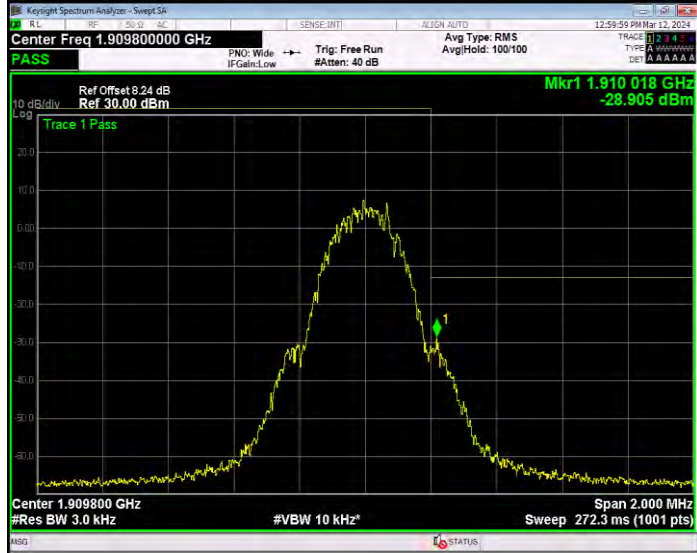

GPRS1900 Channel=512

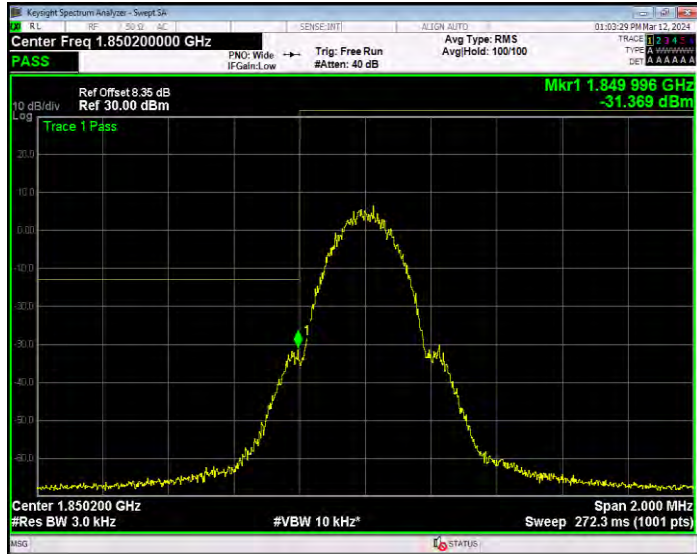

GPRS1900 Channel=810

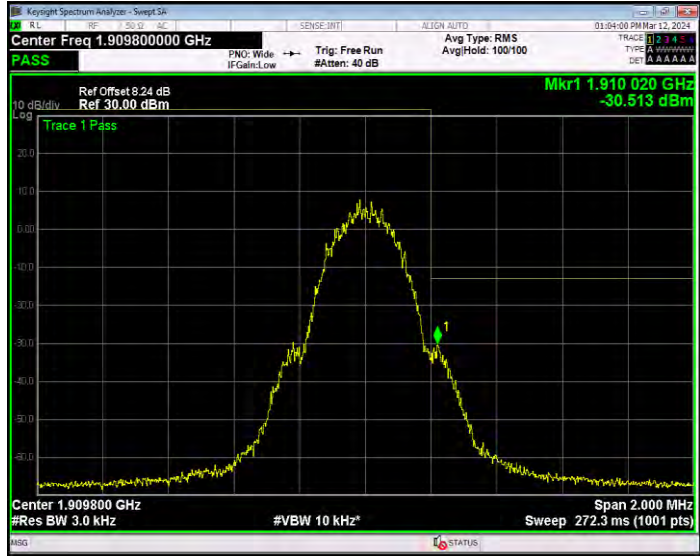

EGPRS1900 Channel=512

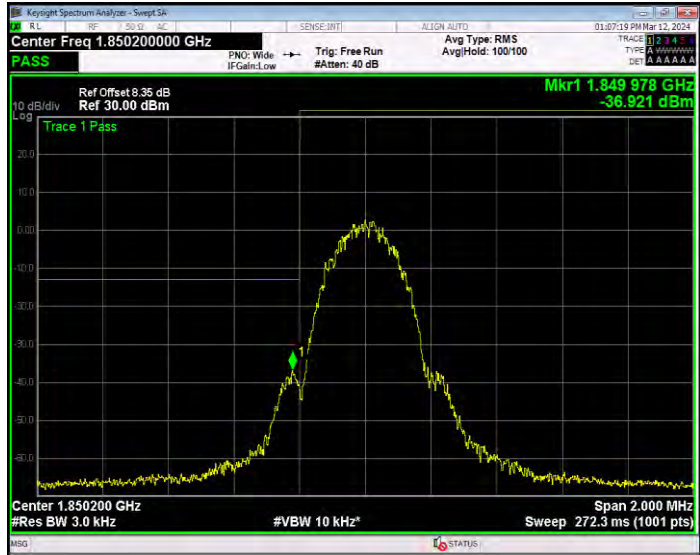

EGPRS1900 Channel=810

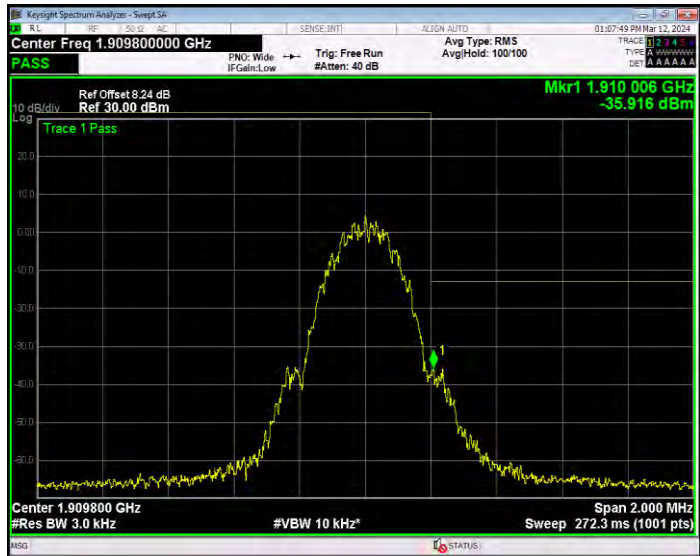

Out-of-band emissions

Band	Channel	Frequency (MHz)	Spur Freq (MHz)	Spur Level (dBm)	Limit (dBm)	Verdict
GSM850	128	824.2	2741.34	-29.97	-13	PASS
GSM850	190	836.6	3169.80	-28.02	-13	PASS
GSM850	251	848.8	2967.16	-28.07	-13	PASS
GPRS850	128	824.2	3176.78	-29.76	-13	PASS
GPRS850	190	836.6	3006.05	-28.96	-13	PASS
GPRS850	251	848.8	3281.72	-29.31	-13	PASS
EGPRS850	128	824.2	3167.31	-29.24	-13	PASS
EGPRS850	190	836.6	2647.87	-28.94	-13	PASS
EGPRS850	251	848.8	3009.53	-29.04	-13	PASS
GSM1900	512	1850.2	19205.69	-20.64	-13	PASS
GSM1900	661	1880	16441.35	-21.53	-13	PASS
GSM1900	810	1909.8	19304.54	-22.21	-13	PASS
GPRS1900	512	1850.2	19491.76	-22.04	-13	PASS
GPRS1900	661	1880	19985.02	-21.12	-13	PASS
GPRS1900	810	1909.8	16525.22	-22.15	-13	PASS
EGPRS1900	512	1850.2	16484.28	-20.85	-13	PASS
EGPRS1900	661	1880	19602.10	-22.10	-13	PASS
EGPRS1900	810	1909.8	19149.28	-21.75	-13	PASS

GSM850 Channel=128

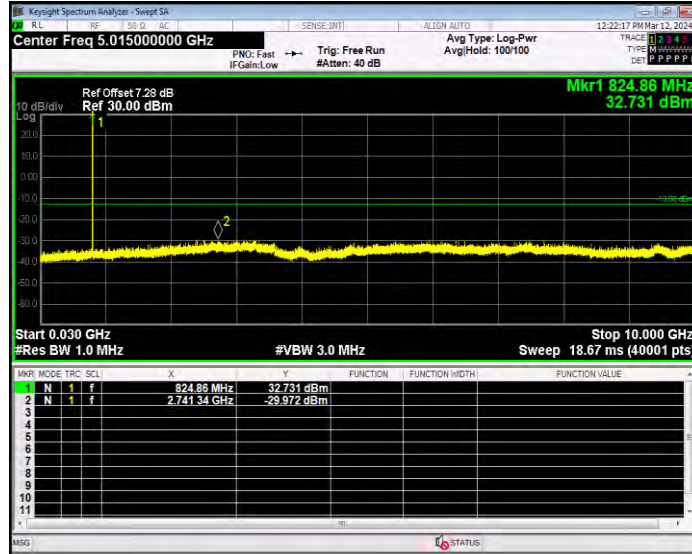

GSM850 Channel=190

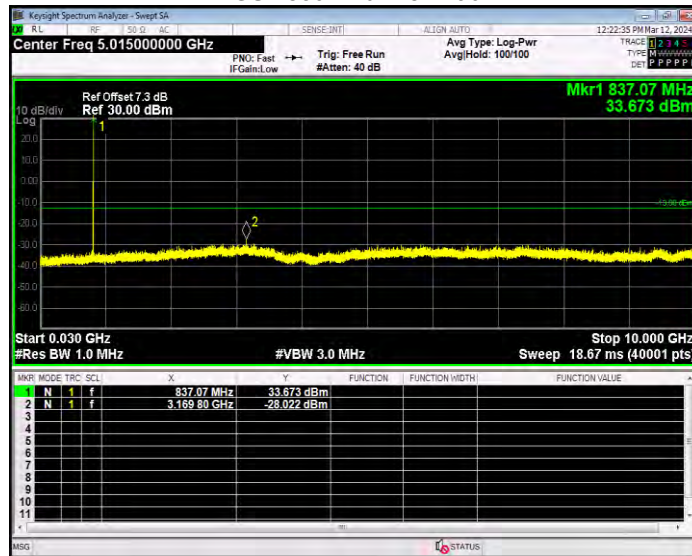

GSM850 Channel=251

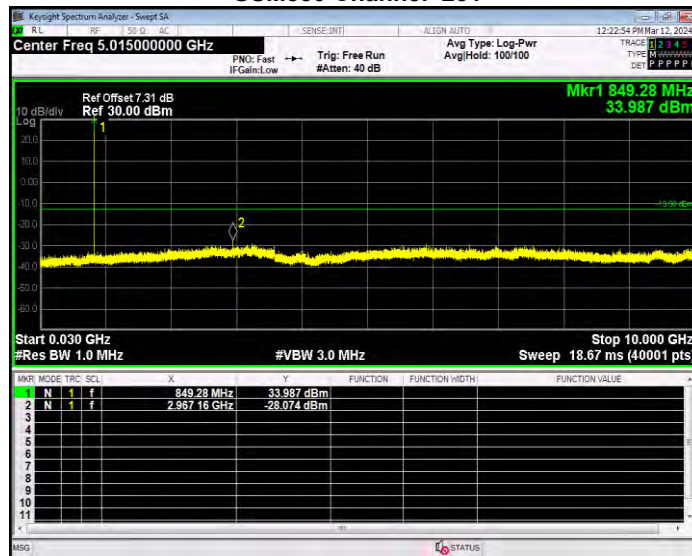

GPRS850 Channel=128

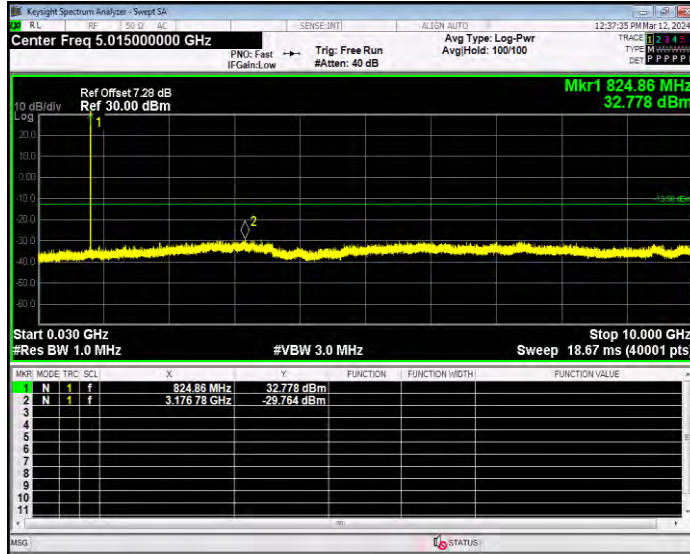

GPRS850 Channel=190

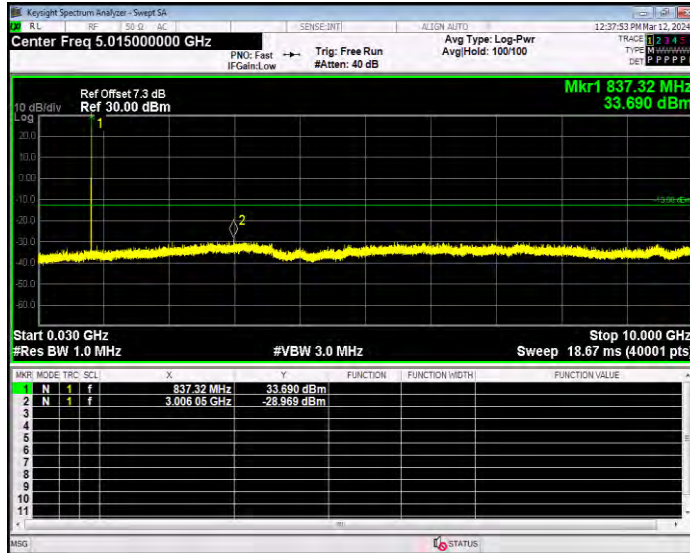

GPRS850 Channel=251

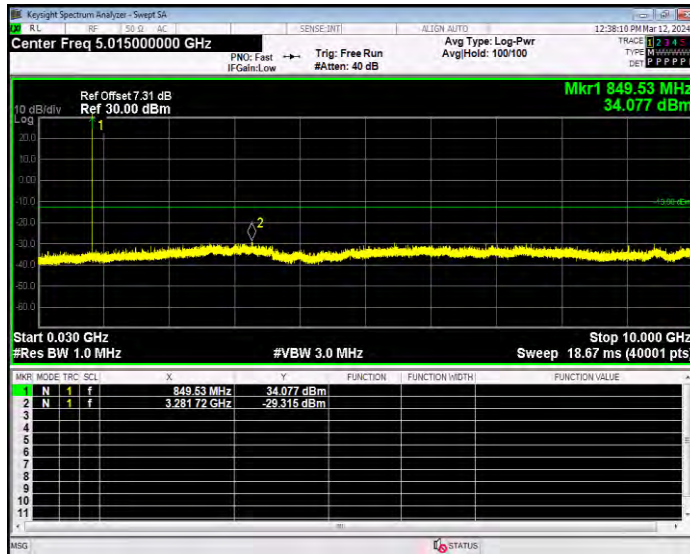

EGPRS850 Channel=128

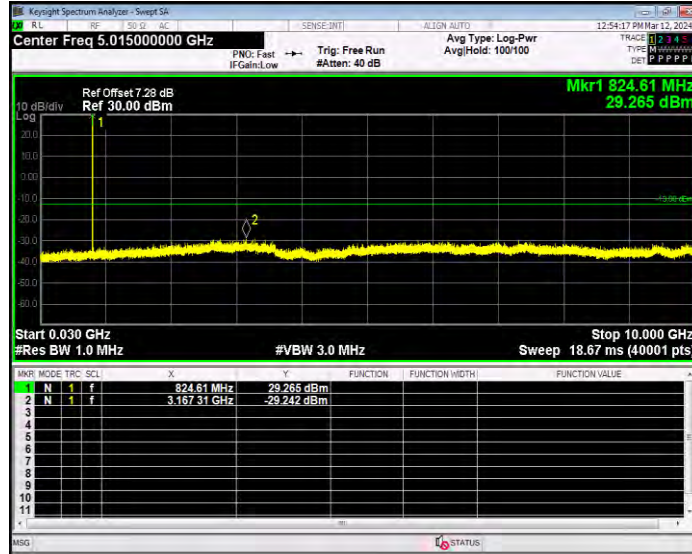

EGPRS850 Channel=190

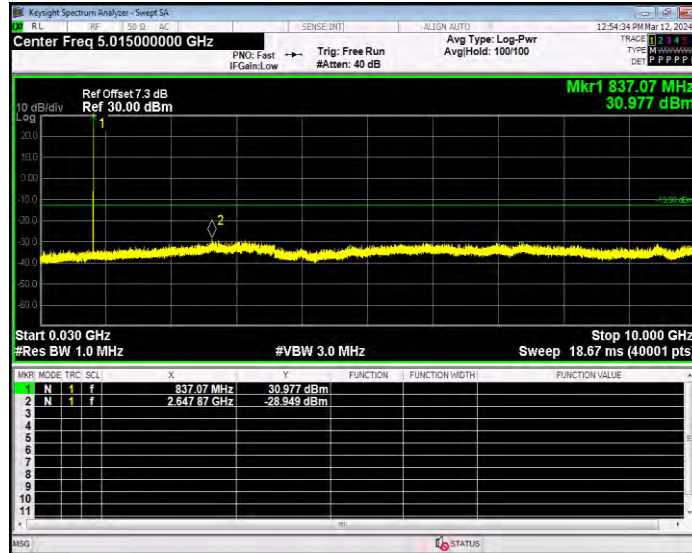

EGPRS850 Channel=251

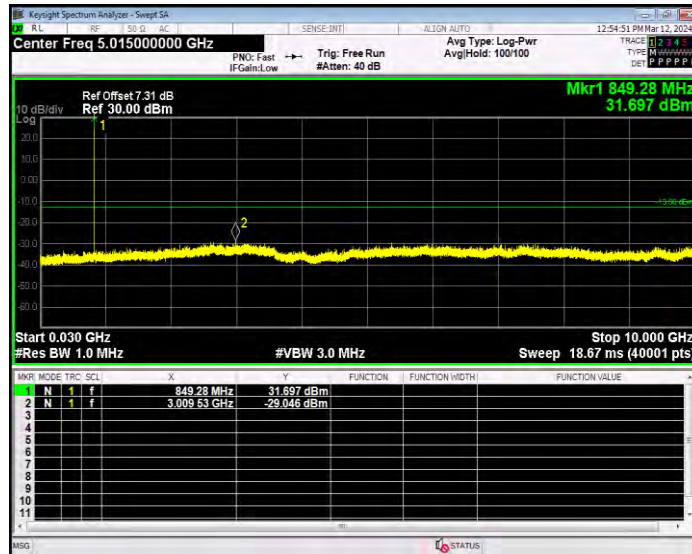

GSM1900 Channel=512

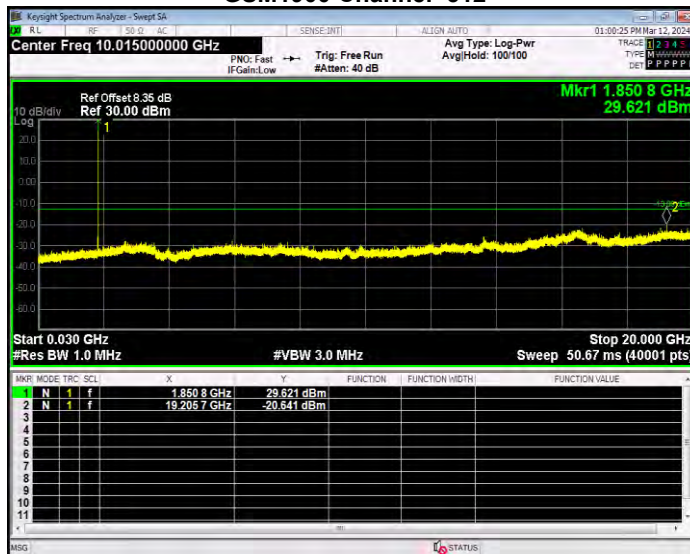

GSM1900 Channel=661

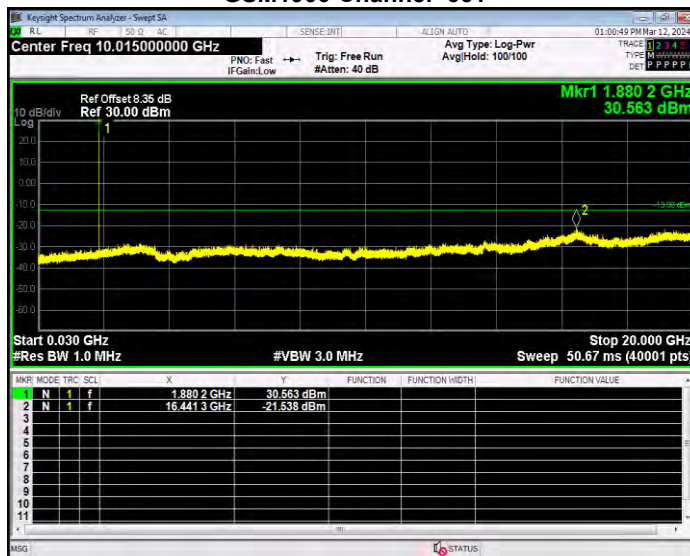

GSM1900 Channel=810

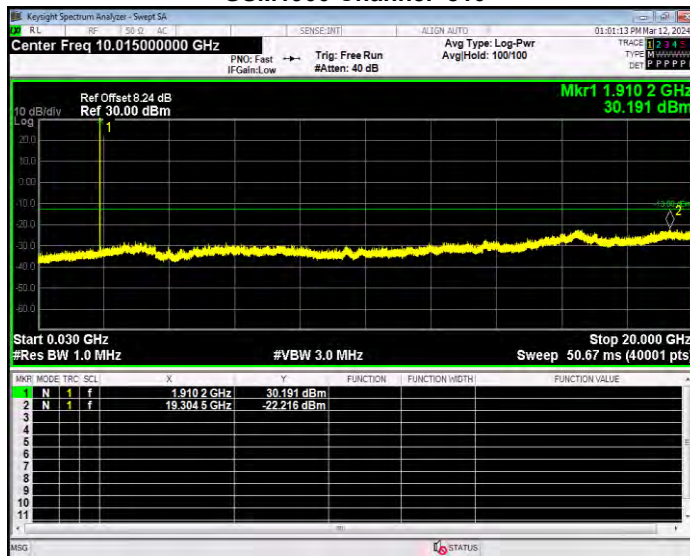

GPRS1900 Channel=512

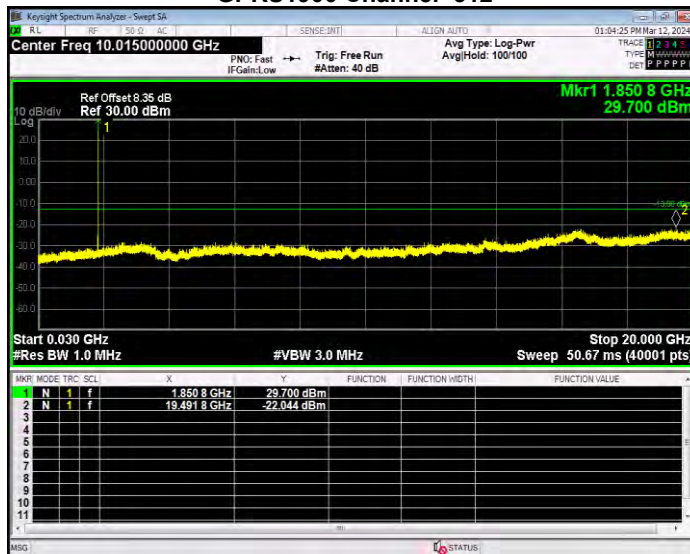

GPRS1900 Channel=661

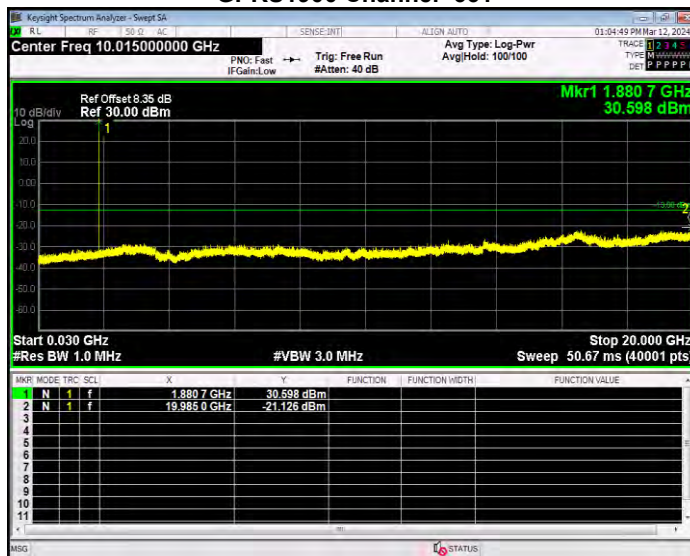

GPRS1900 Channel=810

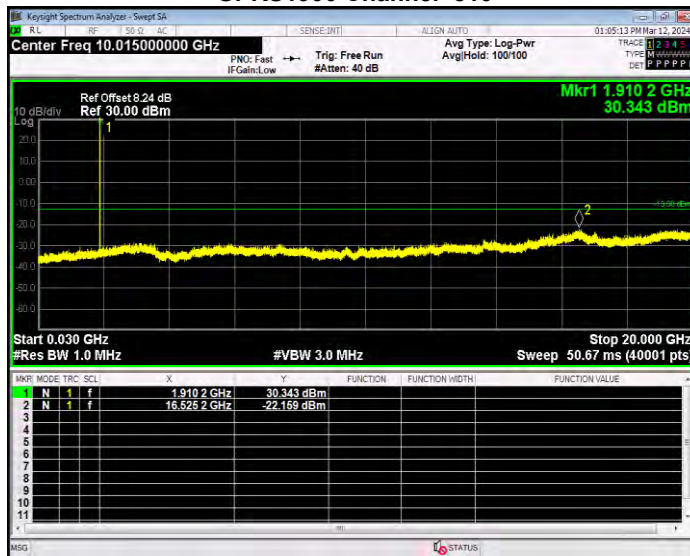

EGPRS1900 Channel=512

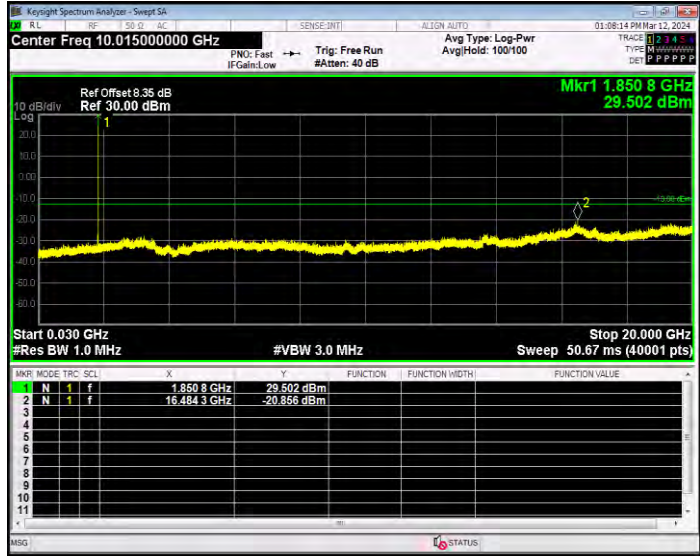

EGPRS1900 Channel=661

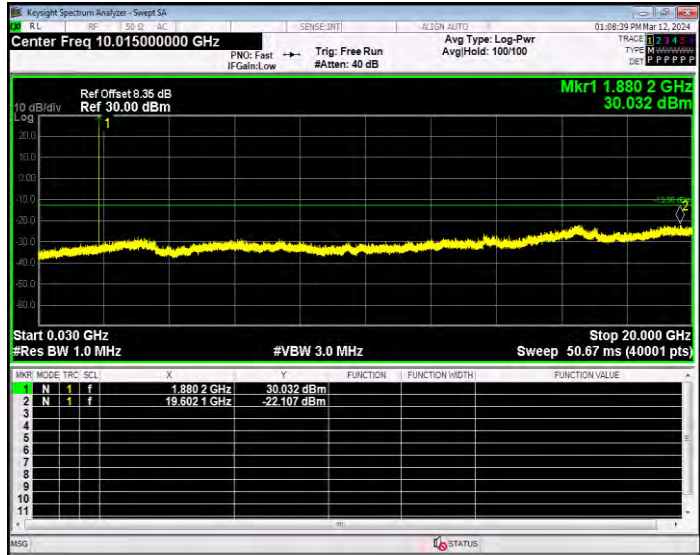

EGPRS1900 Channel=810

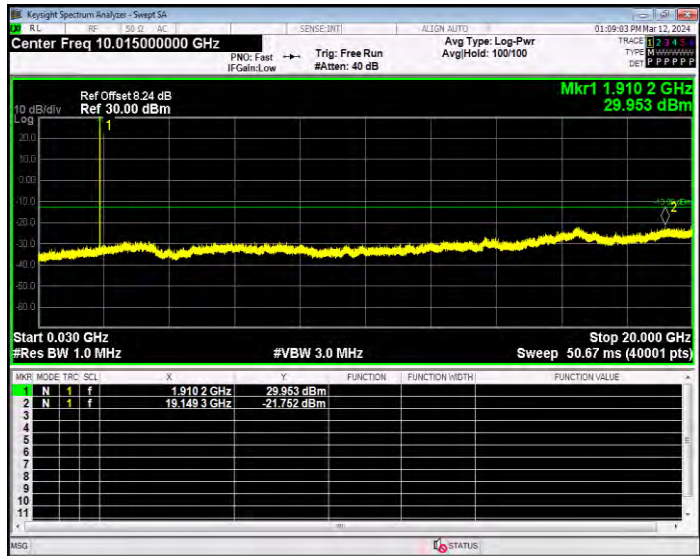

RADIATED SPURIOUS EMISSION

Note: (1) Spurious emissions which are attenuated by more than 20dB below the permissible value for frequency below 1000MHz.

(2) Test is divided into three directions, X/Y/Z. X pattern for the worst.

GSM 850: (30-9000)MHz							
The Worst Test Results Channel 128/824.2 MHz							
Frequency(MHz)	S G.Lev (dBm)	Ant(dBi)	Loss	PMea	Limit	Margin	Polarity
				(dBm)	(dBm)	(dBm)	
1648.26	-34.26	7.40	4.75	-31.61	-13.00	-18.61	H
2472.55	-32.29	8.20	8.39	-32.48	-13.00	-19.48	H
3296.63	-25.02	7.20	11.79	-29.61	-13.00	-16.61	H
1648.13	-26.73	7.40	4.75	-24.08	-13.00	-11.08	V
2472.65	-29.78	8.20	8.39	-29.97	-13.00	-16.97	V
3296.63	-24.93	7.20	11.79	-29.52	-13.00	-16.52	V
The Worst Test Results Channel 190/836.6 MHz							
Frequency(MHz)	S G.Lev (dBm)	Ant(dBi)	Loss	PMea	Limit	Margin	Polarity
				(dBm)	(dBm)	(dBm)	
1672.99	-32.06	7.40	4.76	-29.42	-13.00	-16.42	H
2509.63	-31.52	8.20	8.40	-31.72	-13.00	-18.72	H
3346.07	-26.28	7.20	11.80	-30.88	-13.00	-17.88	H
1672.89	-29.15	7.40	4.75	-26.50	-13.00	-13.50	V
2509.91	-29.45	8.20	8.39	-29.64	-13.00	-16.64	V
3346.29	-23.87	7.20	11.82	-28.49	-13.00	-15.49	V
The Worst Test Results Channel 251/848.8 MHz							
Frequency(MHz)	S G.Lev (dBm)	Ant(dBi)	Loss	PMea	Limit	Margin	Polarity
				(dBm)	(dBm)	(dBm)	
1697.36	-33.74	7.40	4.77	-31.11	-13.00	-18.11	H
2546.16	-32.64	8.20	8.50	-32.94	-13.00	-19.94	H
3395.17	-28.46	7.20	11.90	-33.16	-13.00	-20.16	H
1697.64	-31.48	7.40	4.77	-28.85	-13.00	-15.85	V
2546.09	-29.89	8.20	8.50	-30.19	-13.00	-17.19	V
3395.21	-24.63	7.20	11.90	-29.33	-13.00	-16.33	V

GPRS 850: (30-9000)MHz							
The Worst Test Results Channel 128/824.2 MHz							
Frequency(MHz)	S G.Lev (dBm)	Ant(dBi)	Loss	PMea	Limit	Margin	Polarity
				(dBm)	(dBm)	(dBm)	
1648.17	-35.44	7.40	4.75	-32.79	-13.00	-19.79	H
2472.39	-29.07	8.20	8.39	-29.26	-13.00	-16.26	H
3296.50	-27.18	7.20	11.79	-31.77	-13.00	-18.77	H
1648.35	-29.18	7.40	4.75	-26.53	-13.00	-13.53	V
2472.46	-29.04	8.20	8.39	-29.23	-13.00	-16.23	V
3296.65	-22.12	7.20	11.79	-26.71	-13.00	-13.71	V
The Worst Test Results Channel 190/836.6 MHz							
Frequency(MHz)	S G.Lev (dBm)	Ant(dBi)	Loss	PMea	Limit	Margin	Polarity
				(dBm)	(dBm)	(dBm)	
1673.12	-34.10	7.40	4.76	-31.46	-13.00	-18.46	H
2509.76	-31.92	8.20	8.40	-32.12	-13.00	-19.12	H
3346.26	-28.26	7.20	11.80	-32.86	-13.00	-19.86	H
1673.08	-29.15	7.40	4.75	-26.50	-13.00	-13.50	V
2509.63	-29.58	8.20	8.39	-29.77	-13.00	-16.77	V
3345.95	-24.58	7.20	11.82	-29.20	-13.00	-16.20	V
The Worst Test Results Channel 251/848.8 MHz							
Frequency(MHz)	S G.Lev (dBm)	Ant(dBi)	Loss	PMea	Limit	Margin	Polarity
				(dBm)	(dBm)	(dBm)	
1697.22	-35.95	7.40	4.77	-33.32	-13.00	-20.32	H
2546.32	-30.72	8.20	8.50	-31.02	-13.00	-18.02	H
3395.03	-29.14	7.20	11.90	-33.84	-13.00	-20.84	H
1697.21	-26.83	7.40	4.77	-24.20	-13.00	-11.20	V
2546.51	-29.84	8.20	8.50	-30.14	-13.00	-17.14	V
3395.30	-21.68	7.20	11.90	-26.38	-13.00	-13.38	V

EGPRS 850: (30-9000)MHz

The Worst Test Results Channel 128/824.2 MHz

Frequency(MHz)	S G.Lev (dBm)	Ant(dBi)	Loss	PMea	Limit	Margin	Polarity
				(dBm)	(dBm)	(dBm)	
1648.39	-35.40	7.40	4.75	-32.75	-13.00	-19.75	H
2472.55	-31.28	8.20	8.39	-31.47	-13.00	-18.47	H
3296.49	-28.02	7.20	11.79	-32.61	-13.00	-19.61	H
1648.37	-28.61	7.40	4.75	-25.96	-13.00	-12.96	V
2472.63	-29.61	8.20	8.39	-29.80	-13.00	-16.80	V
3296.75	-23.86	7.20	11.79	-28.45	-13.00	-15.45	V

The Worst Test Results Channel 190/836.6 MHz

Frequency(MHz)	S G.Lev (dBm)	Ant(dBi)	Loss	PMea	Limit	Margin	Polarity
				(dBm)	(dBm)	(dBm)	
1673.05	-36.03	7.40	4.76	-33.39	-13.00	-20.39	H
2509.51	-31.67	8.20	8.40	-31.87	-13.00	-18.87	H
3346.02	-29.00	7.20	11.80	-33.60	-13.00	-20.60	H
1672.86	-28.68	7.40	4.75	-26.03	-13.00	-13.03	V
2509.50	-29.88	8.20	8.39	-30.07	-13.00	-17.07	V
3346.05	-24.84	7.20	11.82	-29.46	-13.00	-16.46	V

The Worst Test Results Channel 251/848.8 MHz

Frequency(MHz)	S G.Lev (dBm)	Ant(dBi)	Loss	PMea	Limit	Margin	Polarity
				(dBm)	(dBm)	(dBm)	
1697.30	-36.44	7.40	4.77	-33.81	-13.00	-20.81	H
2546.40	-30.41	8.20	8.50	-30.71	-13.00	-17.71	H
3395.13	-29.31	7.20	11.90	-34.01	-13.00	-21.01	H
1697.27	-31.04	7.40	4.77	-28.41	-13.00	-15.41	V
2546.41	-29.24	8.20	8.50	-29.54	-13.00	-16.54	V
3395.26	-21.46	7.20	11.90	-26.16	-13.00	-13.16	V

PCS 1900: (30-20000)MHz							
The Worst Test Results for Channel 512/1850.2MHz							
Frequency(MHz)	S G.Lev (dBm)	Ant(dBi)	Loss	PMea	Limit	Margin	Polarity
				(dBm)	(dBm)	(dBm)	
3700.08	-28.43	7.00	12.93	-34.36	-13.00	-21.36	H
5550.28	-27.44	8.40	17.11	-36.15	-13.00	-23.15	H
7400.71	-27.69	8.30	22.20	-41.59	-13.00	-28.59	H
3700.35	-24.86	7.00	12.93	-30.79	-13.00	-17.79	V
5550.31	-22.86	8.40	17.11	-31.57	-13.00	-18.57	V
7401.00	-23.73	8.30	22.20	-37.63	-13.00	-24.63	V
The Worst Test Results for Channel 661/1880.0MHz							
Frequency(MHz)	S G.Lev (dBm)	Ant(dBi)	Loss	PMea	Limit	Margin	Polarity
				(dBm)	(dBm)	(dBm)	
3760.04	-24.70	7.00	12.93	-30.63	-13.00	-17.63	H
5640.05	-24.17	8.40	17.11	-32.88	-13.00	-19.88	H
7519.81	-25.68	8.30	22.20	-39.58	-13.00	-26.58	H
3759.88	-21.07	7.00	12.93	-27.00	-13.00	-14.00	V
5640.26	-24.72	8.40	17.11	-33.43	-13.00	-20.43	V
7519.94	-19.95	8.30	22.20	-33.85	-13.00	-20.85	V
The Worst Test Results for Channel 810/1909.8MHz							
Frequency(MHz)	S G.Lev (dBm)	Ant(dBi)	Loss	PMea	Limit	Margin	Polarity
				(dBm)	(dBm)	(dBm)	
3819.69	-25.16	7.00	12.93	-31.09	-13.00	-18.09	H
5729.31	-24.70	8.40	17.11	-33.41	-13.00	-20.41	H
7639.08	-24.87	8.30	22.20	-38.77	-13.00	-25.77	H
3819.72	-22.05	7.00	12.93	-27.98	-13.00	-14.98	V
5729.08	-22.40	8.40	17.11	-31.11	-13.00	-18.11	V
7639.01	-23.41	8.30	22.20	-37.31	-13.00	-24.31	V

GPRS1900: (30-20000)MHz**The Worst Test Results for Channel 512/1850.2MHz**

Frequency(MHz)	S G.Lev (dBm)	Ant(dBi)	Loss	PMea	Limit	Margin	Polarity
				(dBm)	(dBm)	(dBm)	
3700.21	-24.40	7.00	12.93	-30.33	-13.00	-17.33	H
5550.44	-23.91	8.40	17.11	-32.62	-13.00	-19.62	H
7400.96	-26.95	8.30	22.20	-40.85	-13.00	-27.85	H
3700.12	-24.34	7.00	12.93	-30.27	-13.00	-17.27	V
5550.48	-26.25	8.40	17.11	-34.96	-13.00	-21.96	V
7400.64	-20.01	8.30	22.20	-33.91	-13.00	-20.91	V

The Worst Test Results for Channel 661/1880.0MHz

Frequency(MHz)	S G.Lev (dBm)	Ant(dBi)	Loss	PMea	Limit	Margin	Polarity
				(dBm)	(dBm)	(dBm)	
3760.06	-27.77	7.00	12.93	-33.70	-13.00	-20.70	H
5639.94	-26.57	8.40	17.11	-35.28	-13.00	-22.28	H
7520.29	-27.05	8.30	22.20	-40.95	-13.00	-27.95	H
3759.97	-25.43	7.00	12.93	-31.36	-13.00	-18.36	V
5640.01	-24.29	8.40	17.11	-33.00	-13.00	-20.00	V
7519.89	-23.75	8.30	22.20	-37.65	-13.00	-24.65	V

The Worst Test Results for Channel 810/1909.8MHz

Frequency(MHz)	S G.Lev (dBm)	Ant(dBi)	Loss	PMea	Limit	Margin	Polarity
				(dBm)	(dBm)	(dBm)	
3819.73	-27.15	7.00	12.93	-33.08	-13.00	-20.08	H
5729.10	-26.57	8.40	17.11	-35.28	-13.00	-22.28	H
7639.06	-27.31	8.30	22.20	-41.21	-13.00	-28.21	H
3819.62	-23.88	7.00	12.93	-29.81	-13.00	-16.81	V
5729.11	-26.00	8.40	17.11	-34.71	-13.00	-21.71	V
7639.32	-20.52	8.30	22.20	-34.42	-13.00	-21.42	V

EGPRS 1900: (30-20000)MHz

The Worst Test Results for Channel 512/1850.2MHz

Frequency(MHz)	S G.Lev (dBm)	Ant(dBi)	Loss	PMea	Limit	Margin	Polarity
				(dBm)	(dBm)	(dBm)	
3700.37	-28.69	7.00	12.93	-34.62	-13.00	-21.62	H
5550.64	-23.62	8.40	17.11	-32.33	-13.00	-19.33	H
7400.94	-27.44	8.30	22.20	-41.34	-13.00	-28.34	H
3700.30	-23.80	7.00	12.93	-29.73	-13.00	-16.73	V
5550.70	-24.00	8.40	17.11	-32.71	-13.00	-19.71	V
7400.57	-20.48	8.30	22.20	-34.38	-13.00	-21.38	V

The Worst Test Results for Channel 661/1880.0MHz

Frequency(MHz)	S G.Lev (dBm)	Ant(dBi)	Loss	PMea	Limit	Margin	Polarity
				(dBm)	(dBm)	(dBm)	
3760.19	-27.36	7.00	12.93	-33.29	-13.00	-20.29	H
5640.11	-24.34	8.40	17.11	-33.05	-13.00	-20.05	H
7519.92	-27.10	8.30	22.20	-41.00	-13.00	-28.00	H
3760.20	-21.37	7.00	12.93	-27.30	-13.00	-14.30	V
5640.24	-21.33	8.40	17.11	-30.04	-13.00	-17.04	V
7520.13	-22.01	8.30	22.20	-35.91	-13.00	-22.91	V

The Worst Test Results for Channel 810/1909.8MHz

Frequency(MHz)	S G.Lev (dBm)	Ant(dBi)	Loss	PMea	Limit	Margin	Polarity
				(dBm)	(dBm)	(dBm)	
3819.33	-24.81	7.00	12.93	-30.74	-13.00	-17.74	H
5729.26	-24.06	8.40	17.11	-32.77	-13.00	-19.77	H
7638.93	-27.15	8.30	22.20	-41.05	-13.00	-28.05	H
3819.52	-22.20	7.00	12.93	-28.13	-13.00	-15.13	V
5729.19	-22.36	8.40	17.11	-31.07	-13.00	-18.07	V
7639.17	-19.72	8.30	22.20	-33.62	-13.00	-20.62	V

3G

Conducted output power

Band	Channel	Frequency (MHz)	Power (dBm)	Gain (dB)	EIRP (dBm)	EIRP Limit (dBm)	Verdict
WCDMA Band2	9262	1852.4	23.43	-0.6	22.83	33.01	PASS
WCDMA Band2	9400	1880	23.56	-0.6	22.96	33.01	PASS
WCDMA Band2	9538	1907.6	23.62	-0.6	23.02	33.01	PASS
HSDPA Band2 Subtest1	9262	1852.4	22.48	-0.6	21.88	33.01	PASS
HSDPA Band2 Subtest2	9262	1852.4	21.99	-0.6	21.39	33.01	PASS
HSDPA Band2 Subtest3	9262	1852.4	20.73	-0.6	20.13	33.01	PASS
HSDPA Band2 Subtest4	9262	1852.4	20.66	-0.6	20.06	33.01	PASS
HSDPA Band2 Subtest1	9400	1880	22.64	-0.6	22.04	33.01	PASS
HSDPA Band2 Subtest2	9400	1880	21.99	-0.6	21.39	33.01	PASS
HSDPA Band2 Subtest3	9400	1880	20.61	-0.6	20.01	33.01	PASS
HSDPA Band2 Subtest4	9400	1880	20.76	-0.6	20.16	33.01	PASS
HSDPA Band2 Subtest1	9538	1907.6	22.69	-0.6	22.09	33.01	PASS
HSDPA Band2 Subtest2	9538	1907.6	22.27	-0.6	21.67	33.01	PASS
HSDPA Band2 Subtest3	9538	1907.6	20.73	-0.6	20.13	33.01	PASS
HSDPA Band2 Subtest4	9538	1907.6	21.14	-0.6	20.54	33.01	PASS
HSUPA Band2 Subtest1	9262	1852.4	21.32	-0.6	20.72	33.01	PASS
HSUPA Band2 Subtest2	9262	1852.4	22.32	-0.6	21.72	33.01	PASS
HSUPA Band2 Subtest3	9262	1852.4	20.67	-0.6	20.07	33.01	PASS
HSUPA Band2 Subtest4	9262	1852.4	22.45	-0.6	21.85	33.01	PASS
HSUPA Band2 Subtest5	9262	1852.4	21.00	-0.6	20.40	33.01	PASS
HSUPA Band2 Subtest1	9400	1880	22.39	-0.6	21.79	33.01	PASS
HSUPA Band2 Subtest2	9400	1880	22.40	-0.6	21.80	33.01	PASS
HSUPA Band2 Subtest3	9400	1880	21.30	-0.6	20.70	33.01	PASS
HSUPA Band2 Subtest4	9400	1880	22.58	-0.6	21.98	33.01	PASS
HSUPA Band2 Subtest5	9400	1880	21.88	-0.6	21.28	33.01	PASS
HSUPA Band2 Subtest1	9538	1907.6	22.46	-0.6	21.86	33.01	PASS
HSUPA Band2 Subtest2	9538	1907.6	22.50	-0.6	21.90	33.01	PASS
HSUPA Band2 Subtest3	9538	1907.6	21.33	-0.6	20.73	33.01	PASS
HSUPA Band2 Subtest4	9538	1907.6	22.63	-0.6	22.03	33.01	PASS
HSUPA Band2 Subtest5	9538	1907.6	22.07	-0.6	21.47	33.01	PASS

Band	Channel	Frequency (MHz)	Power (dBm)	Gain (dB)	EIRP (dBm)	EIRP Limit (dBm)	Verdict
WCDMA Band4	1312	1712.4	23.00	-1.6	21.40	30	PASS
WCDMA Band4	1450	1740	23.07	-1.6	21.47	30	PASS
WCDMA Band4	1513	1752.6	22.98	-1.6	21.38	30	PASS
HSDPA Band4 Subtest1	1312	1712.4	22.03	-1.6	20.43	30	PASS
HSDPA Band4 Subtest2	1312	1712.4	21.62	-1.6	20.02	30	PASS
HSDPA Band4 Subtest3	1312	1712.4	20.64	-1.6	19.04	30	PASS
HSDPA Band4 Subtest4	1312	1712.4	20.76	-1.6	19.16	30	PASS
HSDPA Band4 Subtest1	1450	1740	22.11	-1.6	20.51	30	PASS
HSDPA Band4 Subtest2	1450	1740	21.69	-1.6	20.09	30	PASS
HSDPA Band4 Subtest3	1450	1740	20.81	-1.6	19.21	30	PASS
HSDPA Band4 Subtest4	1450	1740	20.62	-1.6	19.02	30	PASS
HSDPA Band4 Subtest1	1513	1752.6	21.96	-1.6	20.36	30	PASS
HSDPA Band4 Subtest2	1513	1752.6	21.58	-1.6	19.98	30	PASS
HSDPA Band4 Subtest3	1513	1752.6	20.59	-1.6	18.99	30	PASS
HSDPA Band4 Subtest4	1513	1752.6	20.49	-1.6	18.89	30	PASS
HSUPA Band4 Subtest1	1312	1712.4	20.56	-1.6	18.96	30	PASS
HSUPA Band4 Subtest2	1312	1712.4	21.91	-1.6	20.31	30	PASS
HSUPA Band4 Subtest3	1312	1712.4	20.06	-1.6	18.46	30	PASS
HSUPA Band4 Subtest4	1312	1712.4	22.02	-1.6	20.42	30	PASS
HSUPA Band4 Subtest5	1312	1712.4	20.62	-1.6	19.02	30	PASS
HSUPA Band4 Subtest1	1450	1740	21.92	-1.6	20.32	30	PASS
HSUPA Band4 Subtest2	1450	1740	22.00	-1.6	20.40	30	PASS
HSUPA Band4 Subtest3	1450	1740	20.91	-1.6	19.31	30	PASS
HSUPA Band4 Subtest4	1450	1740	22.11	-1.6	20.51	30	PASS
HSUPA Band4 Subtest5	1450	1740	21.22	-1.6	19.62	30	PASS
HSUPA Band4 Subtest1	1513	1752.6	21.75	-1.6	20.15	30	PASS
HSUPA Band4 Subtest2	1513	1752.6	21.86	-1.6	20.26	30	PASS
HSUPA Band4 Subtest3	1513	1752.6	20.49	-1.6	18.89	30	PASS
HSUPA Band4 Subtest4	1513	1752.6	21.98	-1.6	20.38	30	PASS
HSUPA Band4 Subtest5	1513	1752.6	21.30	-1.6	19.70	30	PASS

Band	Channel	Frequency (MHz)	Power (dBm)	Gain (dB)	ERP (dBm)	ERP Limit (dBm)	Verdict
WCDMA Band5	4132	826.4	23.12	-5.6	15.37	38.45	PASS
WCDMA Band5	4182	836.4	23.26	-5.6	15.51	38.45	PASS
WCDMA Band5	4233	846.6	23.65	-5.6	15.90	38.45	PASS
HSDPA Band5 Subtest1	4132	826.4	22.18	-5.6	14.43	38.45	PASS
HSDPA Band5 Subtest2	4132	826.4	21.70	-5.6	13.95	38.45	PASS
HSDPA Band5 Subtest3	4132	826.4	20.85	-5.6	13.10	38.45	PASS
HSDPA Band5 Subtest4	4132	826.4	20.63	-5.6	12.88	38.45	PASS
HSDPA Band5 Subtest1	4182	836.4	22.32	-5.6	14.57	38.45	PASS
HSDPA Band5 Subtest2	4182	836.4	21.92	-5.6	14.17	38.45	PASS
HSDPA Band5 Subtest3	4182	836.4	20.78	-5.6	13.03	38.45	PASS
HSDPA Band5 Subtest4	4182	836.4	20.77	-5.6	13.02	38.45	PASS
HSDPA Band5 Subtest1	4233	846.6	22.74	-5.6	14.99	38.45	PASS
HSDPA Band5 Subtest2	4233	846.6	22.24	-5.6	14.49	38.45	PASS
HSDPA Band5 Subtest3	4233	846.6	21.02	-5.6	13.27	38.45	PASS
HSDPA Band5 Subtest4	4233	846.6	20.96	-5.6	13.21	38.45	PASS
HSUPA Band5 Subtest1	4132	826.4	20.83	-5.6	13.08	38.45	PASS
HSUPA Band5 Subtest2	4132	826.4	22.02	-5.6	14.27	38.45	PASS
HSUPA Band5 Subtest3	4132	826.4	20.28	-5.6	12.53	38.45	PASS
HSUPA Band5 Subtest4	4132	826.4	22.18	-5.6	14.43	38.45	PASS
HSUPA Band5 Subtest5	4132	826.4	20.62	-5.6	12.87	38.45	PASS
HSUPA Band5 Subtest1	4182	836.4	22.21	-5.6	14.46	38.45	PASS
HSUPA Band5 Subtest2	4182	836.4	22.14	-5.6	14.39	38.45	PASS
HSUPA Band5 Subtest3	4182	836.4	21.15	-5.6	13.40	38.45	PASS
HSUPA Band5 Subtest4	4182	836.4	22.34	-5.6	14.59	38.45	PASS
HSUPA Band5 Subtest5	4182	836.4	21.52	-5.6	13.77	38.45	PASS
HSUPA Band5 Subtest1	4233	846.6	22.57	-5.6	14.82	38.45	PASS
HSUPA Band5 Subtest2	4233	846.6	22.64	-5.6	14.89	38.45	PASS
HSUPA Band5 Subtest3	4233	846.6	21.51	-5.6	13.76	38.45	PASS
HSUPA Band5 Subtest4	4233	846.6	22.75	-5.6	15.00	38.45	PASS
HSUPA Band5 Subtest5	4233	846.6	22.03	-5.6	14.28	38.45	PASS

Frequency stability

UMTS Band 2 /1880MHz					
Temperature (°C)	Voltage	Freq. Dev.	Freq. Dev.	Limit	Result
	(Volt)	(Hz)	(ppm)		
50	Normal Voltage	8.59	0.005	Within Authorized Band	PASS
40		-8.62	-0.005		
30		8.98	0.005		
20		-19.33	-0.010		
10		8.59	0.005		
0		-9.12	-0.005		
-10		8.62	0.005		
-20		-8.96	-0.005		
-30		-8.81	-0.005		
20		Maximum Voltage	-14.20		
20	BEP	-14.49	-0.008		

UMTS Band 4 /1740MHz					
Temperature (°C)	Voltage	Freq. Dev.	Freq. Dev.	Limit	Result
	(Volt)	(Hz)	(ppm)		
50	Normal Voltage	7.47	0.004	Within Authorized Band	PASS
40		7.66	0.004		
30		7.57	0.004		
20		-16.37	-0.009		
10		7.29	0.004		
0		7.34	0.004		
-10		7.17	0.004		
-20		-7.11	-0.004		
-30		-7.55	-0.004		
20		Maximum Voltage	-11.81		
20	BEP	2.97	0.002		

UMTS Band 5 / 836.6MHz					
Temperature (°C)	Voltage	Freq. Dev.	Freq. Dev.	Limit	Result
	(Volt)	(Hz)	(ppm)		
50	Normal Voltage	-6.52	-0.008	2.5ppm	PASS
40		6.42	0.008		
30		6.41	0.008		
20		-14.65	-0.018		
10		-6.63	-0.008		
0		6.30	0.008		
-10		6.48	0.008		
-20		-6.80	-0.008		
-30		-6.44	-0.008		
20		Maximum Voltage	-10.39		
20	BEP	-10.59	-0.013		

Peak-to-Average Ratio

Band	Channel	Frequency (MHz)	Result (dB)	high Limit (dB)	Verdict
WCDMA Band2	9262	1852.4	3.02	13	PASS
WCDMA Band2	9400	1880	3.08	13	PASS
WCDMA Band2	9538	1907.6	3.08	13	PASS
WCDMA Band4	1312	1712.4	3.10	13	PASS
WCDMA Band4	1450	1740	3.06	13	PASS
WCDMA Band4	1513	1752.6	2.98	13	PASS
WCDMA Band5	4132	826.4	3.10	13	PASS
WCDMA Band5	4182	836.4	3.08	13	PASS
WCDMA Band5	4233	846.6	3.10	13	PASS

WCDMA Band2 Channel=9262

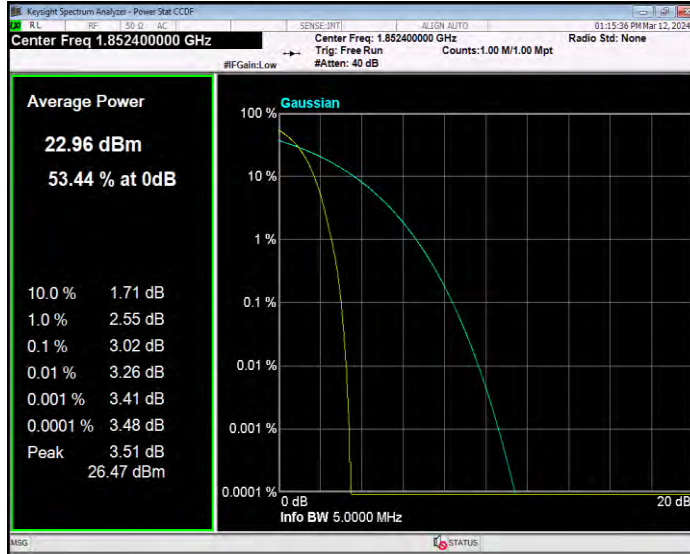

WCDMA Band2 Channel=9400

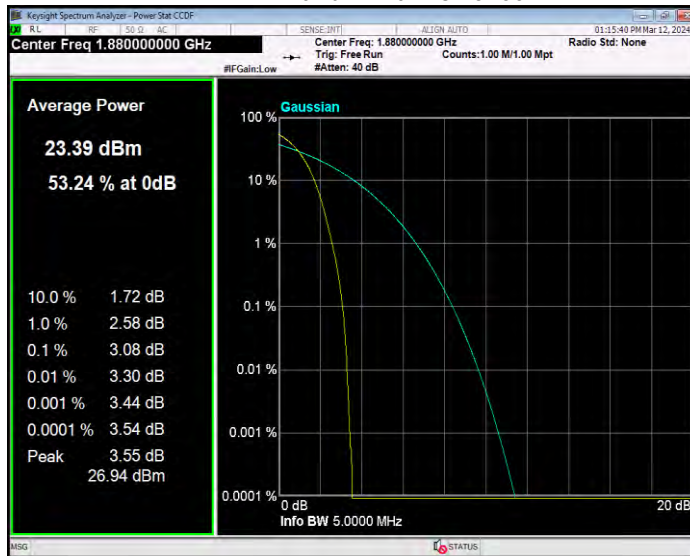

WCDMA Band2 Channel=9538



WCDMA Band4 Channel=1312



WCDMA Band4 Channel=1450

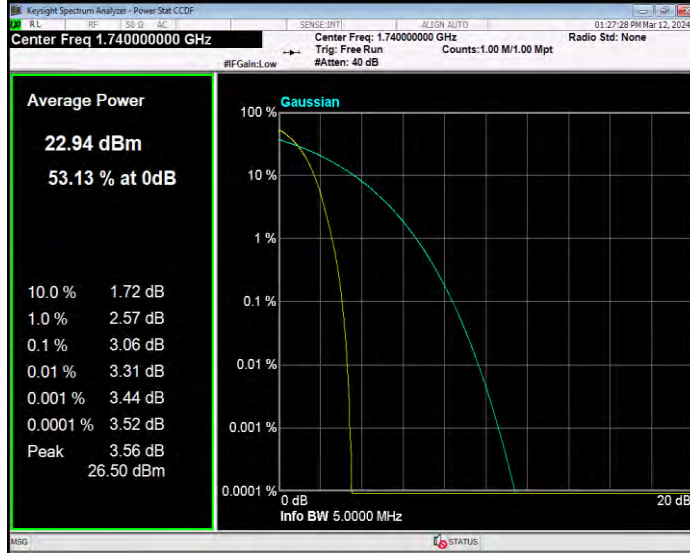

WCDMA Band4 Channel=1513

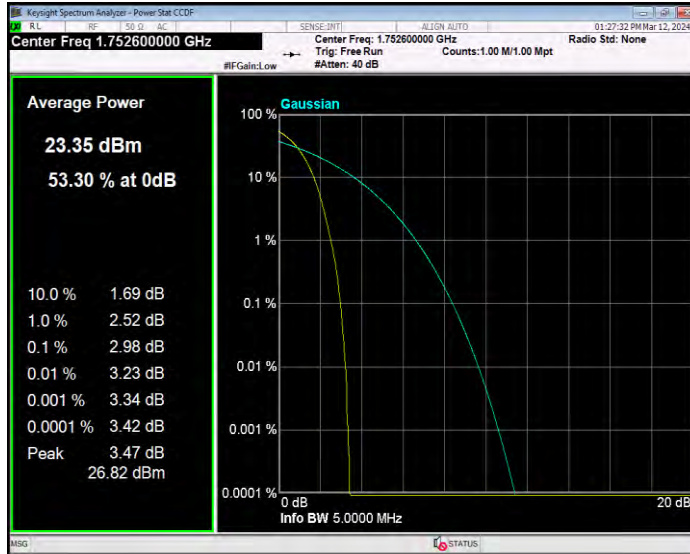

WCDMA Band5 Channel=4132

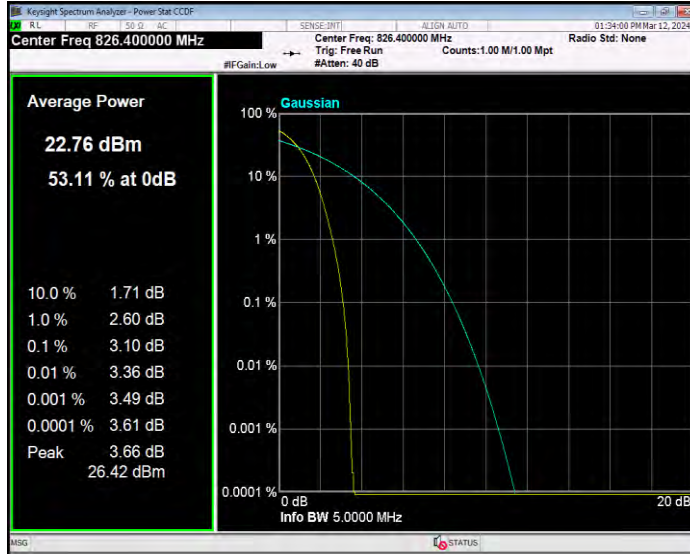

WCDMA Band5 Channel=4182

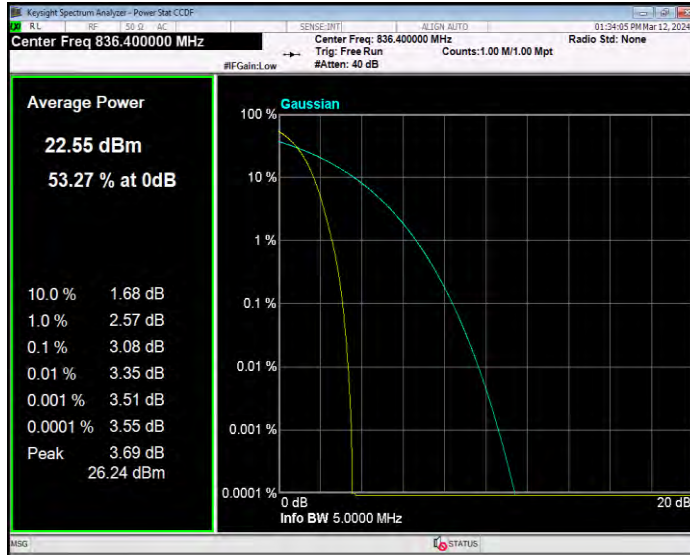

WCDMA Band5 Channel=4233

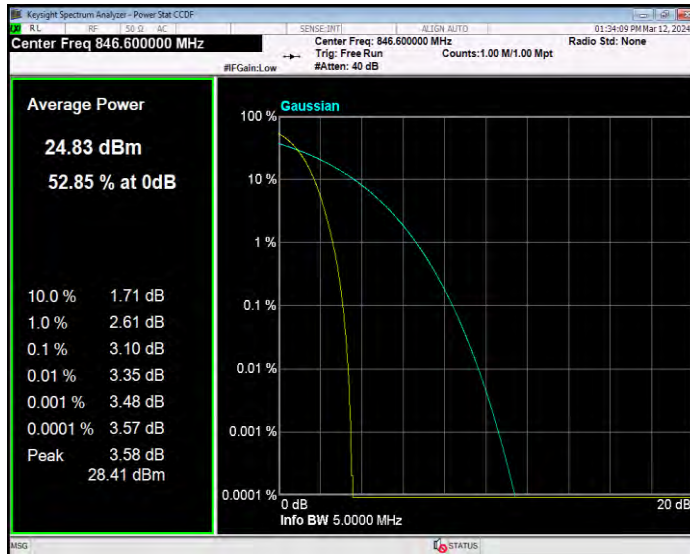

Occupied bandwidth

Band	Channel	Frequency (MHz)	99% OBW (MHz)	-26dB EBW (MHz)	Verdict
WCDMA Band2	9262	1852.4	4.185	4.695	PASS
WCDMA Band2	9400	1880	4.171	4.690	PASS
WCDMA Band2	9538	1907.6	4.187	4.690	PASS
WCDMA Band4	1312	1712.4	4.182	4.687	PASS
WCDMA Band4	1450	1740	4.173	4.702	PASS
WCDMA Band4	1513	1752.6	4.166	4.694	PASS
WCDMA Band5	4132	826.4	4.155	4.710	PASS
WCDMA Band5	4182	836.4	4.173	4.723	PASS
WCDMA Band5	4233	846.6	4.164	4.710	PASS

WCDMA Band2 Channel=9262

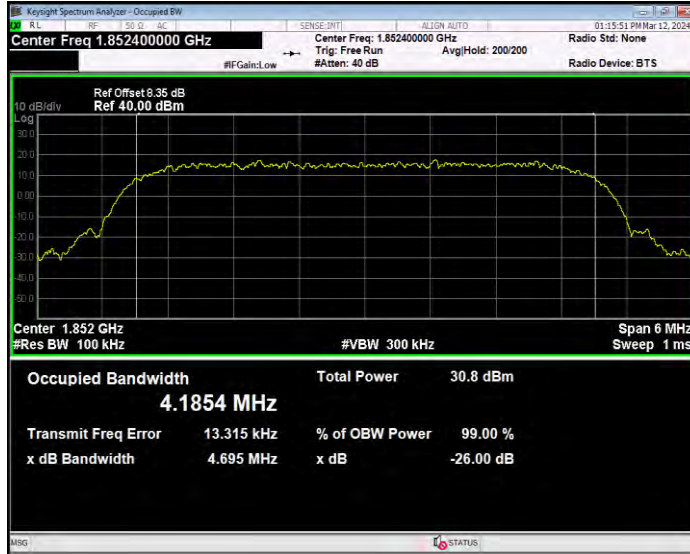

WCDMA Band2 Channel=9400

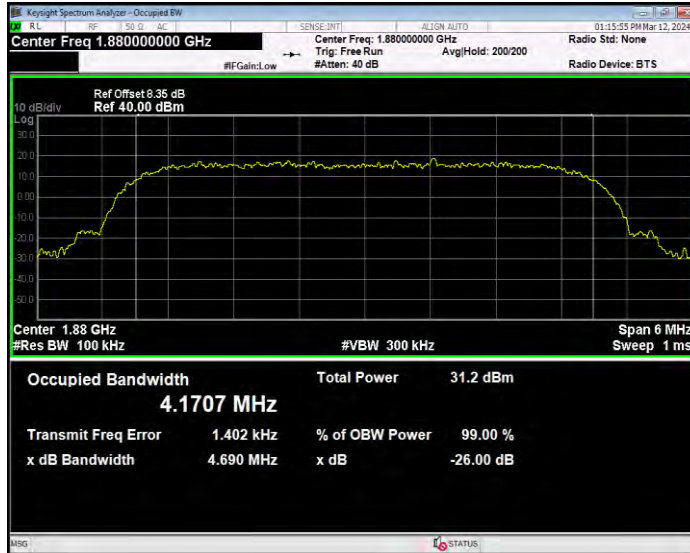

WCDMA Band2 Channel=9538

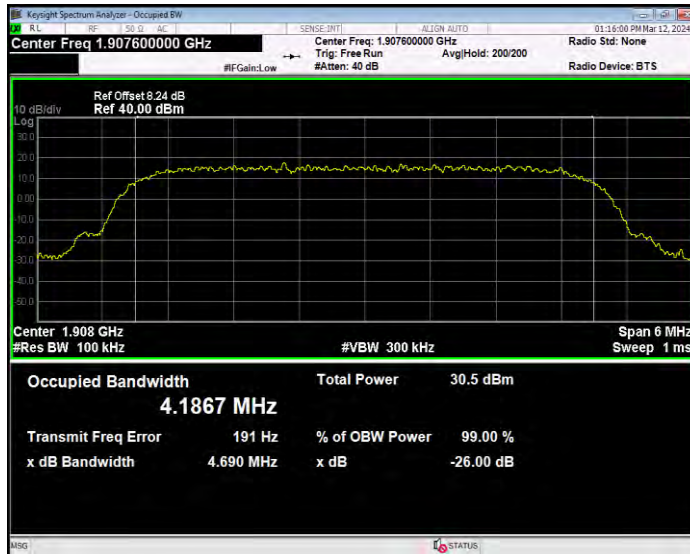

WCDMA Band4 Channel=1312

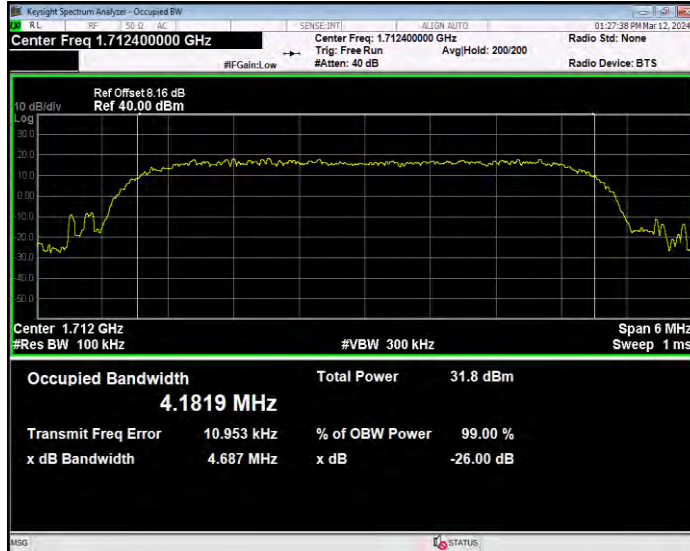

WCDMA Band4 Channel=1450

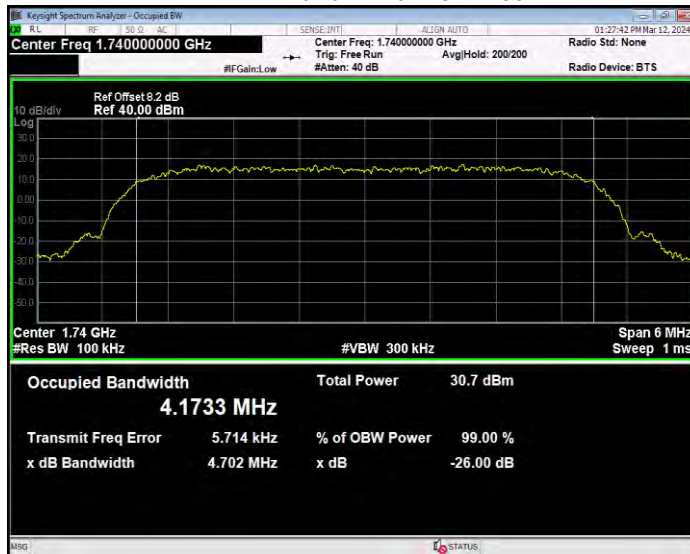

WCDMA Band4 Channel=1513

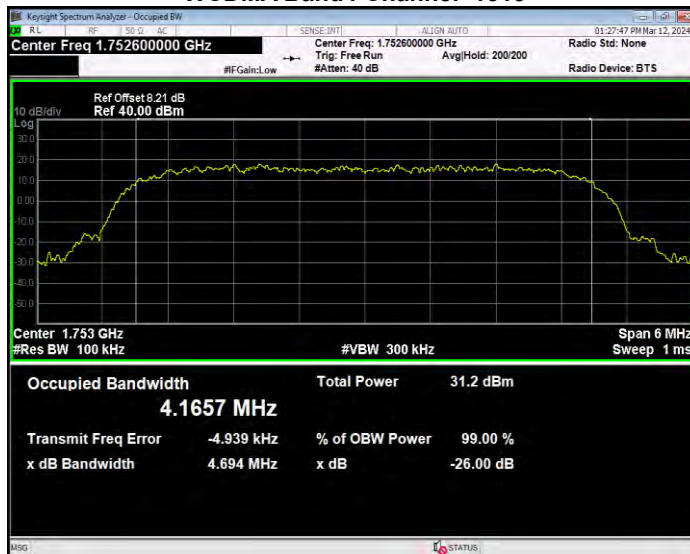

WCDMA Band5 Channel=4132

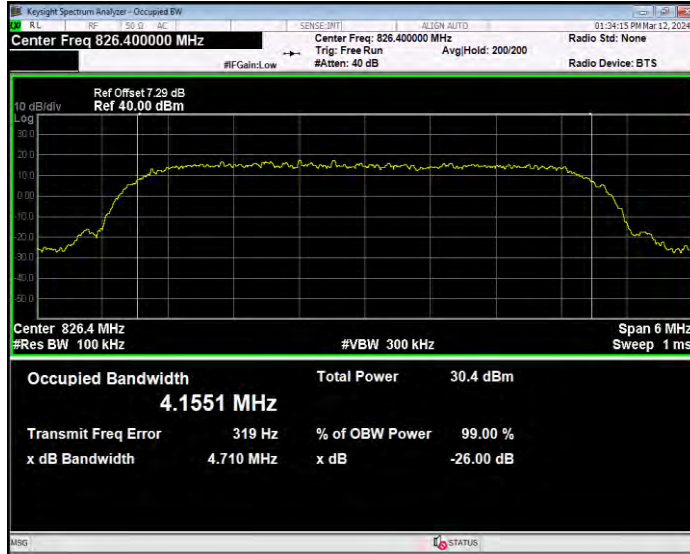

WCDMA Band5 Channel=4182

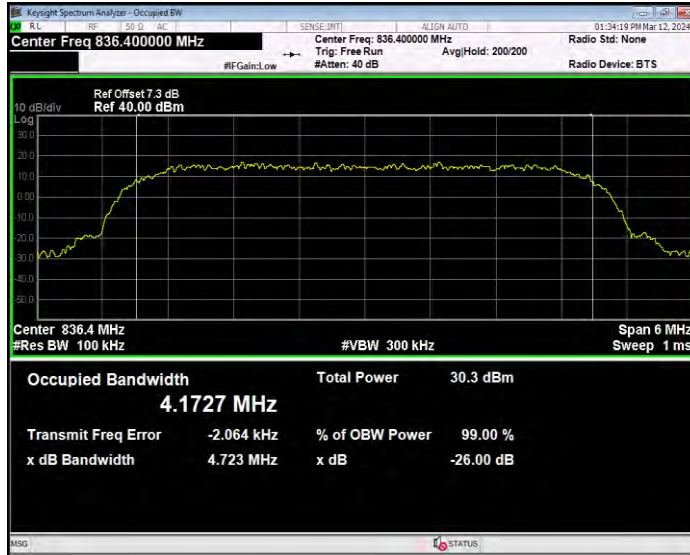

WCDMA Band5 Channel=4233

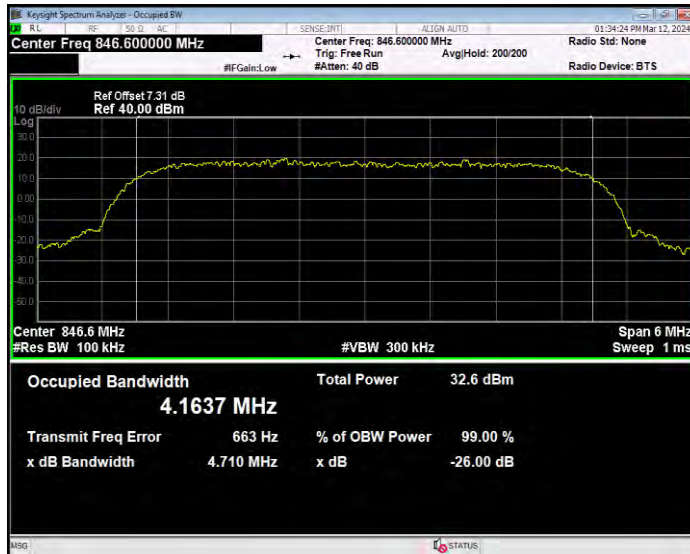

Band edge

Band	Channel	Frequency (MHz)	Spur Freq (MHz)	Spur Level (dBm)	Limit (dBm)	Verdict
WCDMA Band2	9262	1852.4	1850.00	-24.30	-13	PASS
WCDMA Band2	9538	1907.6	1910.00	-22.86	-13	PASS
WCDMA Band4	1312	1712.4	1710.00	-22.72	-13	PASS
WCDMA Band4	1513	1752.6	1755.00	-22.20	-13	PASS
WCDMA Band5	4132	826.4	824.00	-23.30	-13	PASS
WCDMA Band5	4233	846.6	849.00	-21.43	-13	PASS

WCDMA Band2 Channel=9262

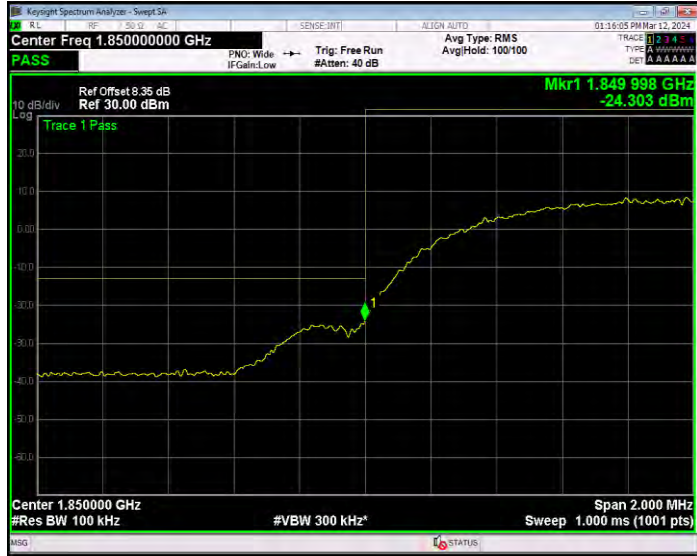

WCDMA Band2 Channel=9538



WCDMA Band4 Channel=1312

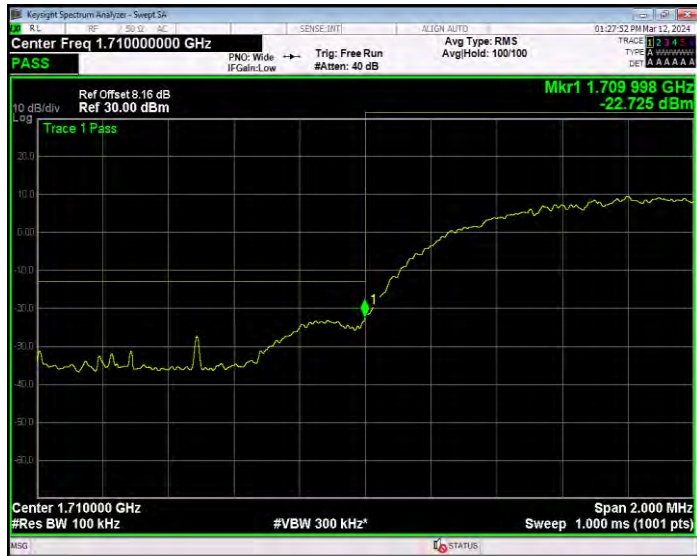

WCDMA Band4 Channel=1513



WCDMA Band5 Channel=4132

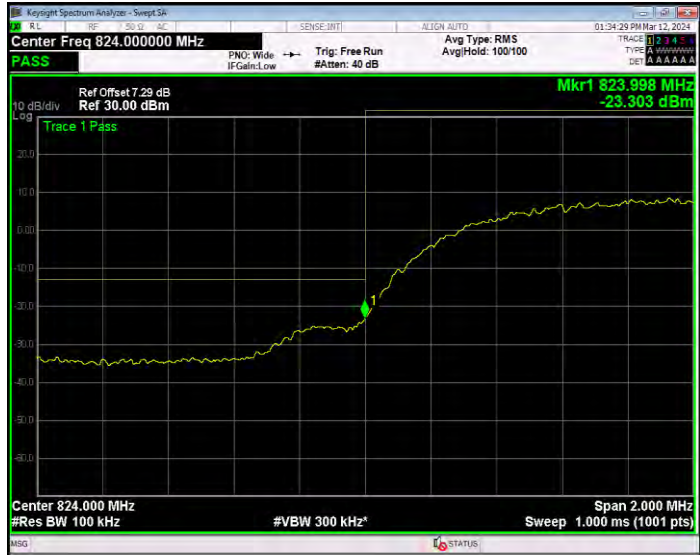

WCDMA Band5 Channel=4233



Out-of-band emissions

Band	Channel	Frequency (MHz)	Spur Freq (MHz)	Spur Level (dBm)	Limit (dBm)	Verdict
WCDMA Band2	9262	1852.4	16460.82	-21.47	-13	PASS
WCDMA Band2	9400	1880	19443.34	-21.99	-13	PASS
WCDMA Band2	9538	1907.6	16455.82	-22.16	-13	PASS
WCDMA Band4	1312	1712.4	19336.00	-21.27	-13	PASS
WCDMA Band4	1450	1740	19318.02	-21.86	-13	PASS
WCDMA Band4	1513	1752.6	16430.86	-21.96	-13	PASS
WCDMA Band5	4132	826.4	3150.86	-29.24	-13	PASS
WCDMA Band5	4182	836.4	3004.80	-29.66	-13	PASS
WCDMA Band5	4233	846.6	3156.34	-29.18	-13	PASS

WCDMA Band2 Channel=9262

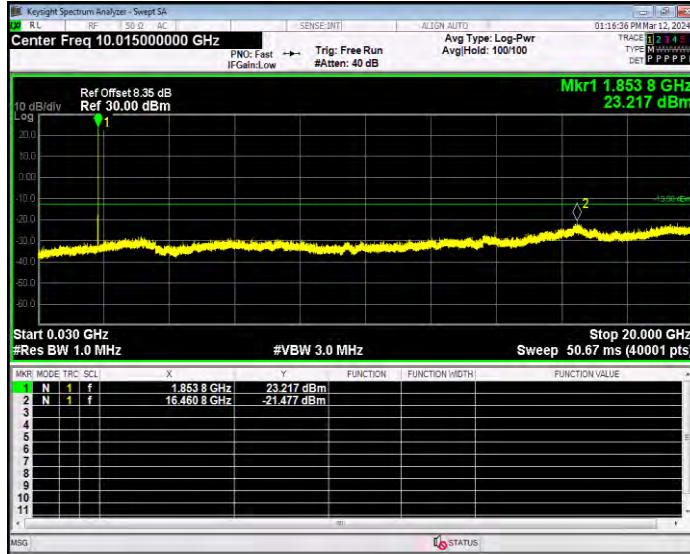

WCDMA Band2 Channel=9400

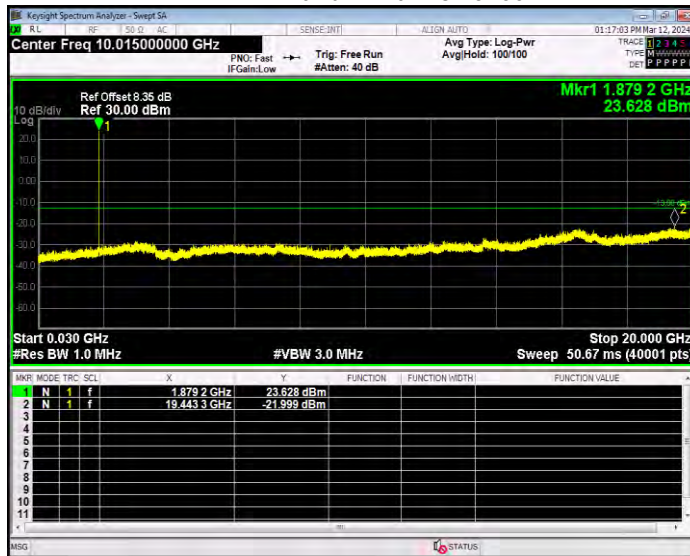

WCDMA Band2 Channel=9538

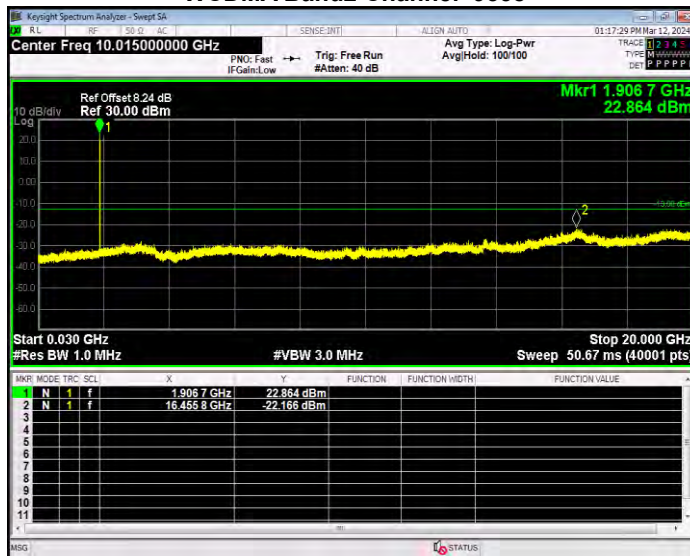

WCDMA Band4 Channel=1312

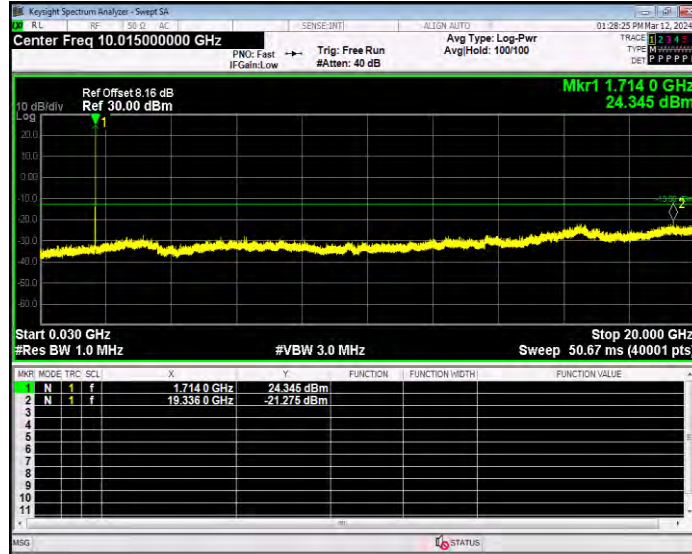

WCDMA Band4 Channel=1450

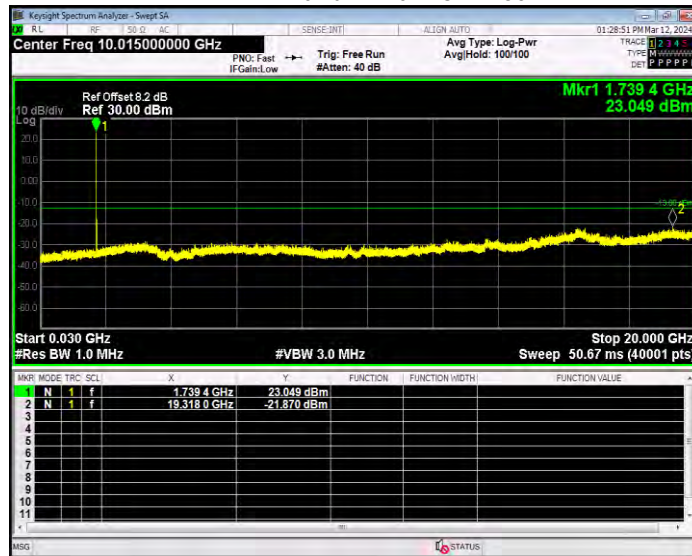

WCDMA Band4 Channel=1513

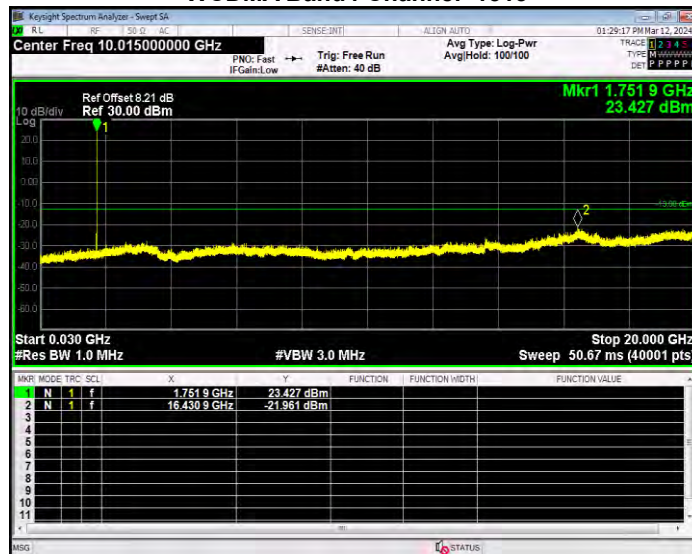

WCDMA Band5 Channel=4132

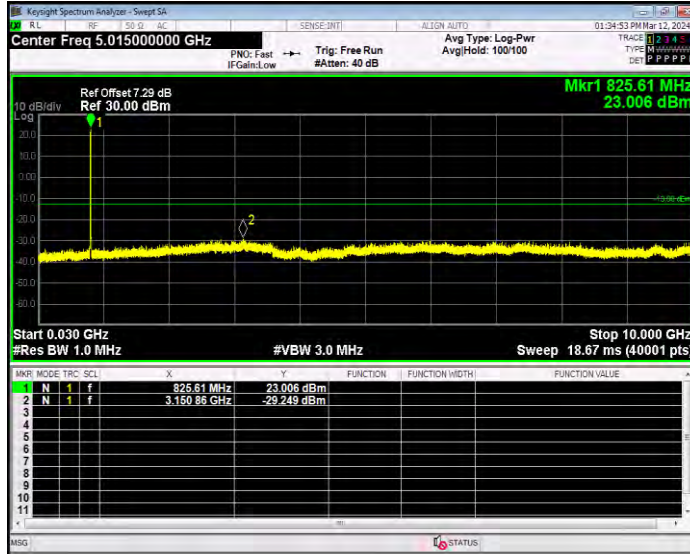

WCDMA Band5 Channel=4182

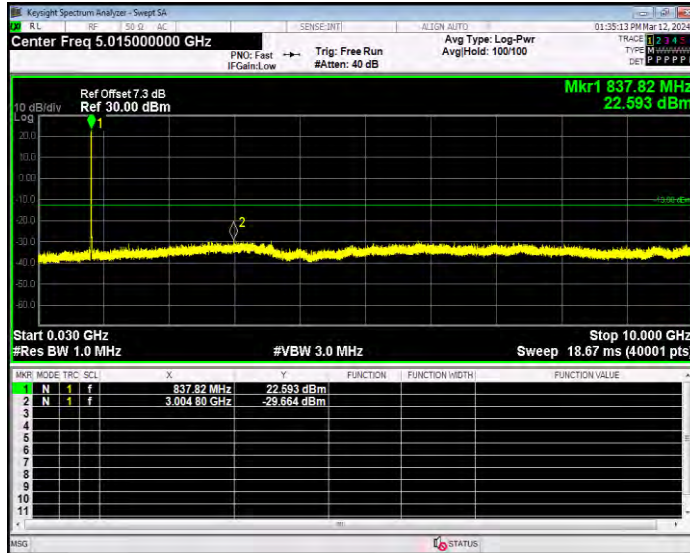

WCDMA Band5 Channel=4233

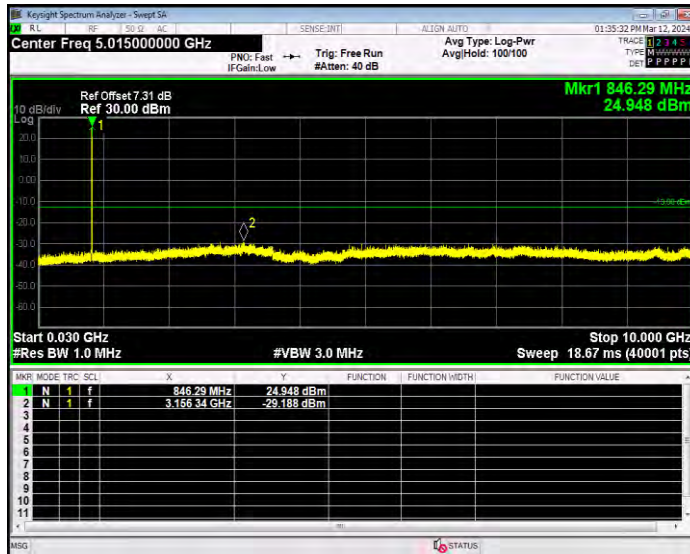

RADIATED SPURIOUS EMISSION

Note:

(1) Spurious emissions which are attenuated by more than 20dB below the permissible value for frequency below 1000MHz.

(2) Test is divided into three directions, X/Y/Z. X pattern for the worst.

WCDMA Band 2: (30-20000)MHz							
The Worst Test Results for Channel 9262/1852.4MHz							
Frequency(MHz)	S G.Lev (dBm)	Ant(dBi)	Loss	PMea	Limit	Margin	Polarity
				(dBm)	(dBm)	(dBm)	
3704.08	-29.58	7.00	12.93	-35.51	-13.00	-22.51	H
5557.62	-25.77	8.20	17.11	-34.68	-13.00	-21.68	H
7409.88	-25.54	8.10	22.20	-39.64	-13.00	-26.64	H
3704.47	-25.24	7.00	12.93	-31.17	-13.00	-18.17	V
5557.60	-26.08	8.20	17.11	-34.99	-13.00	-21.99	V
7409.69	-25.40	8.10	22.20	-39.50	-13.00	-26.50	V
The Worst Test Results for Channel 9400/1880MHz							
Frequency(MHz)	S G.Lev (dBm)	Ant(dBi)	Loss	PMea	Limit	Margin	Polarity
				(dBm)	(dBm)	(dBm)	
3760.24	-27.78	7.00	12.93	-33.71	-13.00	-20.71	H
5640.06	-27.94	8.20	17.11	-36.85	-13.00	-23.85	H
7520.11	-24.09	8.10	22.20	-38.19	-13.00	-25.19	H
3760.32	-29.00	7.00	12.93	-34.93	-13.00	-21.93	V
5640.05	-29.76	8.20	17.11	-38.67	-13.00	-25.67	V
7520.05	-25.88	8.10	22.20	-39.98	-13.00	-26.98	V
The Worst Test Results for Channel 9538/1907.6MHz							
Frequency(MHz)	S G.Lev (dBm)	Ant(dBi)	Loss	PMea	Limit	Margin	Polarity
				(dBm)	(dBm)	(dBm)	
3815.25	-28.26	7.00	12.93	-34.19	-13.00	-21.19	H
5722.16	-26.72	8.20	17.11	-35.63	-13.00	-22.63	H
7629.85	-26.71	8.10	22.20	-40.81	-13.00	-27.81	H
3815.37	-26.80	7.00	12.93	-32.73	-13.00	-19.73	V
5722.22	-29.91	8.20	17.11	-38.82	-13.00	-25.82	V
7629.97	-24.72	8.10	22.20	-38.82	-13.00	-25.82	V

HSUPA Band 2: (30-20000)MHz

The Worst Test Results for Channel 9262/1852.4MHz

Frequency(MHz)	S G.Lev (dBm)	Ant(dBi)	Loss	PMea	Limit	Margin	Polarity
				(dBm)	(dBm)	(dBm)	
3704.13	-29.48	7.00	12.93	-35.41	-13.00	-22.41	H
5557.33	-28.20	8.20	17.11	-37.11	-13.00	-24.11	H
7409.63	-23.88	8.10	22.20	-37.98	-13.00	-24.98	H
3704.30	-29.84	7.00	12.93	-35.77	-13.00	-22.77	V
5557.22	-27.08	8.20	17.11	-35.99	-13.00	-22.99	V
7409.69	-24.91	8.10	22.20	-39.01	-13.00	-26.01	V

The Worst Test Results for Channel 9400/1880MHz

Frequency(MHz)	S G.Lev (dBm)	Ant(dBi)	Loss	PMea	Limit	Margin	Polarity
				(dBm)	(dBm)	(dBm)	
3759.99	-24.95	7.00	12.93	-30.88	-13.00	-17.88	H
5639.90	-29.17	8.20	17.11	-38.08	-13.00	-25.08	H
7519.81	-25.80	8.10	22.20	-39.90	-13.00	-26.90	H
3760.23	-29.85	7.00	12.93	-35.78	-13.00	-22.78	V
5640.04	-26.27	8.20	17.11	-35.18	-13.00	-22.18	V
7519.83	-26.54	8.10	22.20	-40.64	-13.00	-27.64	V

The Worst Test Results for Channel 9538/1907.6MHz

Frequency(MHz)	S G.Lev (dBm)	Ant(dBi)	Loss	PMea	Limit	Margin	Polarity
				(dBm)	(dBm)	(dBm)	
3815.33	-28.95	7.00	12.93	-34.88	-13.00	-21.88	H
5722.11	-25.49	8.20	17.11	-34.40	-13.00	-21.40	H
7630.07	-23.75	8.10	22.20	-37.85	-13.00	-24.85	H
3815.63	-28.16	7.00	12.93	-34.09	-13.00	-21.09	V
5722.44	-29.93	8.20	17.11	-38.84	-13.00	-25.84	V
7629.86	-26.40	8.10	22.20	-40.50	-13.00	-27.50	V

HSDPA Band 2: (30-20000)MHz

The Worst Test Results for Channel 9262/1852.4MHz

Frequency(MHz)	S G.Lev (dBm)	Ant(dBi)	Loss	PMea	Limit	Margin	Polarity
				(dBm)	(dBm)	(dBm)	
3704.27	-28.34	7.00	12.93	-34.27	-13.00	-21.27	H
5557.27	-27.19	8.20	17.11	-36.10	-13.00	-23.10	H
7409.89	-23.80	8.10	22.20	-37.90	-13.00	-24.90	H
3704.22	-27.72	7.00	12.93	-33.65	-13.00	-20.65	V
5557.28	-26.03	8.20	17.11	-34.94	-13.00	-21.94	V
7409.68	-24.96	8.10	22.20	-39.06	-13.00	-26.06	V

The Worst Test Results for Channel 9400/1880MHz

Frequency(MHz)	S G.Lev (dBm)	Ant(dBi)	Loss	PMea	Limit	Margin	Polarity
				(dBm)	(dBm)	(dBm)	
3760.26	-29.44	7.00	12.93	-35.37	-13.00	-22.37	H
5640.02	-29.50	8.20	17.11	-38.41	-13.00	-25.41	H
7520.13	-25.59	8.10	22.20	-39.69	-13.00	-26.69	H
3760.25	-27.21	7.00	12.93	-33.14	-13.00	-20.14	V
5640.12	-28.19	8.20	17.11	-37.10	-13.00	-24.10	V
7520.20	-27.61	8.10	22.20	-41.71	-13.00	-28.71	V

The Worst Test Results for Channel 9538/1907.6MHz

Frequency(MHz)	S G.Lev (dBm)	Ant(dBi)	Loss	PMea	Limit	Margin	Polarity
				(dBm)	(dBm)	(dBm)	
3815.39	-27.21	7.00	12.93	-33.14	-13.00	-20.14	H
5722.24	-29.07	8.20	17.11	-37.98	-13.00	-24.98	H
7629.90	-23.95	8.10	22.20	-38.05	-13.00	-25.05	H
3815.52	-28.81	7.00	12.93	-34.74	-13.00	-21.74	V
5722.43	-27.65	8.20	17.11	-36.56	-13.00	-23.56	V
7629.83	-25.20	8.10	22.20	-39.30	-13.00	-26.30	V

WCDMA Band 4: (30-18000)MHz**The Worst Test Results for Channel 1313/1712.6MHz**

Frequency(MHz)	S G.Lev (dBm)	Ant(dBi)	Loss	PMea	Limit	Margin	Polarity
				(dBm)	(dBm)	(dBm)	
3425.10	-30.93	7.20	12.05	-35.78	-13.00	-22.78	H
5137.69	-31.87	7.90	16.27	-40.24	-13.00	-27.24	H
6849.98	-28.83	8.30	20.13	-40.66	-13.00	-27.66	H
3424.89	-32.61	7.20	12.05	-37.46	-13.00	-24.46	V
5137.31	-33.67	7.90	16.27	-42.04	-13.00	-29.04	V
6850.09	-33.01	8.30	20.13	-44.84	-13.00	-31.84	V

The Worst Test Results for Channel 1450/1740.0MHz

Frequency(MHz)	S G.Lev (dBm)	Ant(dBi)	Loss	PMea	Limit	Margin	Polarity
				(dBm)	(dBm)	(dBm)	
3479.85	-32.30	7.20	12.05	-37.15	-13.00	-24.15	H
5219.78	-33.77	7.90	16.27	-42.14	-13.00	-29.14	H
6959.98	-28.92	8.30	20.13	-40.75	-13.00	-27.75	H
3479.64	-32.07	7.20	12.05	-36.92	-13.00	-23.92	V
5219.68	-34.96	7.90	16.27	-43.33	-13.00	-30.33	V
6959.88	-31.36	8.30	20.13	-43.19	-13.00	-30.19	V

The Worst Test Results for Channel 1512/1752.4MHz

Frequency(MHz)	S G.Lev (dBm)	Ant(dBi)	Loss	PMea	Limit	Margin	Polarity
				(dBm)	(dBm)	(dBm)	
3504.39	-34.37	7.20	12.05	-39.22	-13.00	-26.22	H
5256.70	-34.81	7.90	16.27	-43.18	-13.00	-30.18	H
7009.55	-28.98	8.30	20.13	-40.81	-13.00	-27.81	H
3504.63	-34.06	7.20	12.05	-38.91	-13.00	-25.91	V
5256.87	-31.09	7.90	16.27	-39.46	-13.00	-26.46	V
7009.20	-30.46	8.30	20.13	-42.29	-13.00	-29.29	V

HSUPA Band 4: (30-18000)MHz**The Worst Test Results for Channel 1313/1712.6MHz**

Frequency(MHz)	S G.Lev (dBm)	Ant(dBi)	Loss	PMea	Limit	Margin	Polarity
				(dBm)	(dBm)	(dBm)	
3424.74	-31.43	7.20	12.05	-36.28	-13.00	-23.28	H
5137.59	-33.03	7.90	16.27	-41.40	-13.00	-28.40	H
6850.25	-29.67	8.30	20.13	-41.50	-13.00	-28.50	H
3425.04	-34.24	7.20	12.05	-39.09	-13.00	-26.09	V
5137.50	-31.36	7.90	16.27	-39.73	-13.00	-26.73	V
6849.92	-32.71	8.30	20.13	-44.54	-13.00	-31.54	V

The Worst Test Results for Channel 1450/1740.0MHz

Frequency(MHz)	S G.Lev (dBm)	Ant(dBi)	Loss	PMea	Limit	Margin	Polarity
				(dBm)	(dBm)	(dBm)	
3479.99	-34.31	7.20	12.05	-39.16	-13.00	-26.16	H
5219.92	-33.28	7.90	16.27	-41.65	-13.00	-28.65	H
6959.86	-31.35	8.30	20.13	-43.18	-13.00	-30.18	H
3479.63	-33.06	7.20	12.05	-37.91	-13.00	-24.91	V
5219.52	-32.35	7.90	16.27	-40.72	-13.00	-27.72	V
6959.86	-30.72	8.30	20.13	-42.55	-13.00	-29.55	V

The Worst Test Results for Channel 1512/1752.4MHz

Frequency(MHz)	S G.Lev (dBm)	Ant(dBi)	Loss	PMea	Limit	Margin	Polarity
				(dBm)	(dBm)	(dBm)	
3504.46	-34.33	7.20	12.05	-39.18	-13.00	-26.18	H
5257.10	-32.04	7.90	16.27	-40.41	-13.00	-27.41	H
7009.40	-28.94	8.30	20.13	-40.77	-13.00	-27.77	H
3504.41	-31.09	7.20	12.05	-35.94	-13.00	-22.94	V
5257.09	-32.34	7.90	16.27	-40.71	-13.00	-27.71	V
7009.30	-31.01	8.30	20.13	-42.84	-13.00	-29.84	V

HSDPA Band 4: (30-18000)MHz

The Worst Test Results for Channel 1313/1712.6MHz

Frequency(MHz)	S G.Lev (dBm)	Ant(dBi)	Loss	PMea	Limit	Margin	Polarity
				(dBm)	(dBm)	(dBm)	
3424.74	-34.32	7.20	12.05	-39.17	-13.00	-26.17	H
5137.51	-32.35	7.90	16.27	-40.72	-13.00	-27.72	H
6850.15	-31.01	8.30	20.13	-42.84	-13.00	-29.84	H
3424.74	-33.84	7.20	12.05	-38.69	-13.00	-25.69	V
5137.41	-35.00	7.90	16.27	-43.37	-13.00	-30.37	V
6849.91	-30.90	8.30	20.13	-42.73	-13.00	-29.73	V

The Worst Test Results for Channel 1450/1740.0MHz

Frequency(MHz)	S G.Lev (dBm)	Ant(dBi)	Loss	PMea	Limit	Margin	Polarity
				(dBm)	(dBm)	(dBm)	
3479.77	-29.97	7.20	12.05	-34.82	-13.00	-21.82	H
5219.51	-31.66	7.90	16.27	-40.03	-13.00	-27.03	H
6959.97	-30.47	8.30	20.13	-42.30	-13.00	-29.30	H
3479.80	-31.46	7.20	12.05	-36.31	-13.00	-23.31	V
5219.88	-31.94	7.90	16.27	-40.31	-13.00	-27.31	V
6959.96	-30.13	8.30	20.13	-41.96	-13.00	-28.96	V

The Worst Test Results for Channel 1512/1752.4MHz

Frequency(MHz)	S G.Lev (dBm)	Ant(dBi)	Loss	PMea	Limit	Margin	Polarity
				(dBm)	(dBm)	(dBm)	
3504.47	-33.88	7.20	12.05	-38.73	-13.00	-25.73	H
5256.95	-30.55	7.90	16.27	-38.92	-13.00	-25.92	H
7009.14	-31.24	8.30	20.13	-43.07	-13.00	-30.07	H
3504.37	-35.62	7.20	12.05	-40.47	-13.00	-27.47	V
5257.05	-31.32	7.90	16.27	-39.69	-13.00	-26.69	V
7009.47	-31.03	8.30	20.13	-42.86	-13.00	-29.86	V

WCDMA Band 5: (30-9000)MHz							
The most testresults channel 4132/826.4MHz							
Frequency(MHz)	S G.Lev (dBm)	Ant(dBi)	Loss	PMea	Limit	Margin	Polarity
				(dBm)	(dBm)	(dBm)	
1652.27	-32.61	7.40	4.75	-29.96	-13.00	-16.96	H
2479.39	-31.96	8.30	8.39	-32.05	-13.00	-19.05	H
3305.52	-23.61	7.20	11.79	-28.20	-13.00	-15.20	H
1652.05	-34.78	7.40	4.75	-32.13	-13.00	-19.13	V
2479.70	-35.57	8.30	8.39	-35.66	-13.00	-22.66	V
3305.57	-33.61	7.20	11.79	-38.20	-13.00	-25.20	V
The Worst Test Results Channel 4183/836.6MHz							
Frequency(MHz)	S G.Lev (dBm)	Ant(dBi)	Loss	PMea	Limit	Margin	Polarity
				(dBm)	(dBm)	(dBm)	
1673.21	-35.99	7.40	4.75	-33.34	-13.00	-20.34	H
2509.46	-29.81	8.30	8.39	-29.90	-13.00	-16.90	H
3346.00	-26.06	7.20	11.79	-30.65	-13.00	-17.65	H
1673.21	-36.45	7.40	4.75	-33.80	-13.00	-20.80	V
2509.71	-31.89	8.30	8.39	-31.98	-13.00	-18.98	V
3346.39	-32.39	7.20	11.79	-36.98	-13.00	-23.98	V
The Worst Test Results Channel 4233/846.6MHz							
Frequency(MHz)	S G.Lev (dBm)	Ant(dBi)	Loss	PMea	Limit	Margin	Polarity
				(dBm)	(dBm)	(dBm)	
1693.63	-36.49	7.40	4.75	-33.84	-13.00	-20.84	H
2539.22	-30.03	8.30	8.39	-30.12	-13.00	-17.12	H
3385.88	-23.65	7.20	11.79	-28.24	-13.00	-15.24	H
1693.45	-33.23	7.40	4.75	-30.58	-13.00	-17.58	V
2539.18	-35.36	8.30	8.39	-35.45	-13.00	-22.45	V
3386.13	-30.31	7.20	11.79	-34.90	-13.00	-21.90	V

HSUPA Band 5: (30-9000)MHz							
The most testresults channel 4132/826.4MHz							
Frequency(MHz)	S G.Lev (dBm)	Ant(dBi)	Loss	PMea	Limit	Margin	Polarity
				(dBm)	(dBm)	(dBm)	
1652.07	-32.74	7.40	4.75	-30.09	-13.00	-17.09	H
2479.22	-30.07	8.30	8.39	-30.16	-13.00	-17.16	H
3305.60	-23.44	7.20	11.79	-28.03	-13.00	-15.03	H
1652.33	-34.13	7.40	4.75	-31.48	-13.00	-18.48	V
2479.47	-32.66	8.30	8.39	-32.75	-13.00	-19.75	V
3305.49	-30.62	7.20	11.79	-35.21	-13.00	-22.21	V
The Worst Test Results Channel 4183/836.6MHz							
Frequency(MHz)	S G.Lev (dBm)	Ant(dBi)	Loss	PMea	Limit	Margin	Polarity
				(dBm)	(dBm)	(dBm)	
1672.84	-35.95	7.40	4.75	-33.30	-13.00	-20.30	H
2509.54	-31.65	8.30	8.39	-31.74	-13.00	-18.74	H
3346.33	-25.63	7.20	11.79	-30.22	-13.00	-17.22	H
1673.07	-37.25	7.40	4.75	-34.60	-13.00	-21.60	V
2509.58	-32.09	8.30	8.39	-32.18	-13.00	-19.18	V
3346.36	-30.57	7.20	11.79	-35.16	-13.00	-22.16	V
The Worst Test Results Channel 4233/846.6MHz							
Frequency(MHz)	S G.Lev (dBm)	Ant(dBi)	Loss	PMea	Limit	Margin	Polarity
				(dBm)	(dBm)	(dBm)	
1693.48	-34.17	7.40	4.75	-31.52	-13.00	-18.52	H
2539.49	-34.37	8.30	8.39	-34.46	-13.00	-21.46	H
3385.93	-25.01	7.20	11.79	-29.60	-13.00	-16.60	H
1693.65	-32.75	7.40	4.75	-30.10	-13.00	-17.10	V
2539.43	-33.52	8.30	8.39	-33.61	-13.00	-20.61	V
3385.89	-33.58	7.20	11.79	-38.17	-13.00	-25.17	V

HSDPA Band 5: (30-9000)MHz							
The most testresults channel 4132/826.4MHz							
Frequency(MHz)	S G.Lev (dBm)	Ant(dBi)	Loss	PMea	Limit	Margin	Polarity
				(dBm)	(dBm)	(dBm)	
1652.44	-34.50	7.40	4.75	-31.85	-13.00	-18.85	H
2479.67	-29.72	8.30	8.39	-29.81	-13.00	-16.81	H
3305.86	-23.18	7.20	11.79	-27.77	-13.00	-14.77	H
1652.21	-34.98	7.40	4.75	-32.33	-13.00	-19.33	V
2479.50	-35.75	8.30	8.39	-35.84	-13.00	-22.84	V
3305.64	-31.62	7.20	11.79	-36.21	-13.00	-23.21	V
The Worst Test Results Channel 4183/836.6MHz							
Frequency(MHz)	S G.Lev (dBm)	Ant(dBi)	Loss	PMea	Limit	Margin	Polarity
				(dBm)	(dBm)	(dBm)	
1672.99	-34.49	7.40	4.75	-31.84	-13.00	-18.84	H
2509.60	-32.80	8.30	8.39	-32.89	-13.00	-19.89	H
3346.35	-24.78	7.20	11.79	-29.37	-13.00	-16.37	H
1672.94	-35.49	7.40	4.75	-32.84	-13.00	-19.84	V
2509.63	-34.84	8.30	8.39	-34.93	-13.00	-21.93	V
3345.97	-31.18	7.20	11.79	-35.77	-13.00	-22.77	V
The Worst Test Results Channel 4233/846.6MHz							
Frequency(MHz)	S G.Lev (dBm)	Ant(dBi)	Loss	PMea	Limit	Margin	Polarity
				(dBm)	(dBm)	(dBm)	
1693.28	-32.64	7.40	4.75	-29.99	-13.00	-16.99	H
2539.50	-29.78	8.30	8.39	-29.87	-13.00	-16.87	H
3385.89	-22.80	7.20	11.79	-27.39	-13.00	-14.39	H
1693.55	-37.17	7.40	4.75	-34.52	-13.00	-21.52	V
2539.27	-32.12	8.30	8.39	-32.21	-13.00	-19.21	V
3386.13	-32.83	7.20	11.79	-37.42	-13.00	-24.42	V

APPENDIX II - PHOTOS OF TEST SETUP

Note: See test photos in setup photo document for the actual connections between Product and support equipment.

※※※※END OF THE REPORT※※※※