

FCC RF Test Report

APPLICANT : Yulong Computer Telecommunication Scientific (Shenzhen) Co., Ltd.
EQUIPMENT : Mobile Phone
BRAND NAME : Vodafone Smart 4G/Smartphone Android™ by SFR STARADDICT III
MODEL NAME : Coolpad 8860U/Coolpad 8861U
MARKETING NAME : Vodafone Smart 4G/Smartphone Android™ by SFR STARADDICT III
FCC ID : R38YL8860U
STANDARD : 47 CFR Part 2, 27(M)
CLASSIFICATION : PCS Licensed Transmitter Held to Ear (PCE)

The product was received on Apr. 04, 2013 and testing was completed on Sep. 13, 2013. We, SPORTON INTERNATIONAL (SHENZHEN) INC., would like to declare that the tested sample has been evaluated in accordance with the procedures given in ANSI C63.4-2003 and 47 CFR FCC Part 27 Subpart M and shown to be compliant with the applicable technical standards.

The test results in this report apply exclusively to the tested model / sample. Without written approval of SPORTON INTERNATIONAL (SHENZHEN) INC., the test report shall not be reproduced except in full.



Reviewed by: Joseph Lin / Supervisor

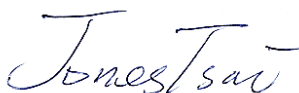

Approved by: Jones Tsai / Manager



SPORTON INTERNATIONAL (SHENZHEN) INC.

No. 3 Building, the third floor of south, Shahe River west, Fengzeyuan warehouse, Nanshan District, Shenzhen, Guangdong, P.R.C.



TABLE OF CONTENTS

REVISION HISTORY..... 3

SUMMARY OF TEST RESULT 4

1 GENERAL DESCRIPTION 5

 1.1 Applicant..... 5

 1.2 Manufacturer..... 5

 1.3 Feature of Equipment Under Test 5

 1.4 Product Specification of Equipment Under Test..... 6

 1.5 Modification of EUT 6

 1.6 Maximum EIRP Power, Frequency Tolerance, and Emission Designator 6

 1.7 Testing Site..... 7

 1.8 Applied Standards 7

2 TEST CONFIGURATION OF EQUIPMENT UNDER TEST 8

 2.1 Test Mode..... 8

 2.2 Connection Diagram of Test System..... 9

 2.3 Support Unit used in test configuration and system 9

 2.4 Measurement Results Explanation Example..... 10

3 TEST RESULT..... 11

 3.1 Maximum Output Power and Effective Isotropic Radiated Power Measurement 11

 3.2 99% Occupied Bandwidth and 26dB Bandwidth Measurement..... 19

 3.3 Conducted Band Edge and Spurious Emission Measurement 29

 3.4 Radiated Emissions Measurement..... 66

 3.5 Frequency Stability Measurement..... 76

4 UNCERTAINTY OF EVALUATION 80

APPENDIX A. SETUP PHOTOGRAPHS



REVISION HISTORY

REPORT NO.	VERSION	DESCRIPTION	ISSUED DATE
FW340403	Rev. 01	Initial issue of report	Sep. 14, 2013



SUMMARY OF TEST RESULT

Report Section	FCC Rule	Description	Limit	Result	Remark
3.1	§2.1033 §2.1046 §27.50	Maximum Output Power	Output Power < 2 Watts	PASS	-
3.1	§27.50	Equivalent Isotropic Radiated Power	< 33 dBW + 10 log(X/Y) dBW + 10 log(360/beamwidth) dBW	PASS	-
3.2	§2.1049 §27.53	Emissions Bandwidth	N/A	PASS	-
3.3	§2.1033 §2.1046 §27.50	Conducted Band Edge Emissions and Spurious Emissions	< 5.5MHz: -13 dBm ≥5.5MHz: -25 dBm	PASS	-
3.4	§2.1053 §27.53	Field Strength of Spurious Radiation	-25 dBm	PASS	Under limit 15.08 dB at 12848.000 MHz
3.5	§2.1055 §27.54	Frequency Stability for Temperature & Voltage	2.5 ppm	PASS	-

1 General Description

1.1 Applicant

Yulong Computer Telecommunication Scientific (Shenzhen) Co., Ltd.

Coolpad Information Harbor, 2nd Mengxi Road, Northern Part of Science&Technology Park, Nanshan district, Shenzhen, P.R.China

1.2 Manufacturer

Yulong Computer Telecommunication Scientific (Shenzhen) Co., Ltd.

Coolpad Information Harbor, 2nd Mengxi Road, Northern Part of Science&Technology Park, Nanshan district, Shenzhen, P.R.China

1.3 Feature of Equipment Under Test

Product Feature	
Equipment	Mobile Phone
Brand Name	Vodafone Smart 4G/Smartphone Android™ by SFR STARADDICT III
Model Name	Coolpad 8860U/Coolpad 8861U
Marketing Name	Vodafone Smart 4G/Smartphone Android™ by SFR STARADDICT III
FCC ID	R38YL8860U
EUT supports Radios application	GSM/GPRS/EGPRS/LTE/WLAN 802.11abgn HT 20/Bluetooth v3.0 + EDR/Bluetooth v4.0/NFC
HW Version	T3
SW Version	082.12.T3.130819.CP8860U (for Vodafone Smart 4G) 082.12.T3.130819.CP8861U (for Smartphone Android™ by SFR STARADDICT III)
EUT Stage	Production Unit

Remark:

- The above EUT's information was declared by manufacturer. Please refer to the specifications or user's manual for more detailed description.
- There are two types of EUT for this project. The differences between them are summary below:

Sample List	Function Type	Brand name	Model name
Sample 1	With NFC	Vodafone Smart 4G	Coolpad 8860U
Sample 2	With NFC	Smartphone Android™ by SFR STARADDICT III	Coolpad 8861U

Sample 1 and sample 2 are identical on hardware. The only difference is for different market purpose.

In this report, we use with sample 1 to perform the test.

1.4 Product Specification of Equipment Under Test

Product Specification subjective to this standard	
Tx Frequency	2506.5 MHz ~ 2534.5 MHz, 2562.5 MHz ~ 2567.5 MHz
Rx Frequency	2626.5 MHz ~ 2654.5 MHz, 2666.5 MHz ~ 2697.5 MHz
Bandwidth	5MHz/10MHz/15MHz/20MHz
Maximum Output Average Power to Antenna	20.48 dBm
Antenna Type	PIFA Antenna
Type of Modulation	QPSK / 16QAM

1.5 Modification of EUT

No modifications are made to the EUT during all test items.

1.6 Maximum EIRP Power, Frequency Tolerance, and Emission Designator

FCC Rule	System	Type of Modulation	BW	Maximum EIRP	Frequency Tolerance (% , Hz, ppm)	Emission Designator
Part 27	LTE Band 7	QPSK	5MHz	0.1845	0.008 ppm	4M52G7D
Part 27	LTE Band 7	16QAM	5MHz	0.1300	0.009 ppm	4M52D7W
Part 27	LTE Band 7	QPSK	10MHz	0.1875	0.010 ppm	9M16G7D
Part 27	LTE Band 7	16QAM	10MHz	0.1435	0.010 ppm	9M12D7W
Part 27	LTE Band 7	QPSK	15MHz	0.1828	0.008 ppm	13M6G7D
Part 27	LTE Band 7	16QAM	15MHz	0.1390	0.009 ppm	13M6D7W
Part 27	LTE Band 7	QPSK	20MHz	0.1148	0.010 ppm	18M0G7D
Part 27	LTE Band 7	16QAM	20MHz	0.1086	0.010 ppm	18M0D7W

1.7 Testing Site

Test Site	SPORTON INTERNATIONAL (SHENZHEN) INC.		
Test Site Location	No. 3 Building, the third floor of south, Shahe River west, Fengzeyuan warehouse, Nanshan District, Shenzhen, Guangdong, P.R.C. TEL: +86-755- 3320-2398		
Test Site No.	Sporton Site No.		FCC Registration No.
	TH01-SZ	03CH01-SZ	OTA01-SZ
			831040

1.8 Applied Standards

According to the specifications of the manufacturer, the EUT must comply with the requirements of the following standards:

- ♦ 47 CFR Part 2, 27(M)
- ♦ ANSI C63.4-2003
- ♦ ANSI TIA-603-C-2004

Remark:

1. All test items were verified and recorded according to the standards and without any deviation during the test.
2. This EUT has also been tested and complied with the requirements of FCC Part 15, Subpart B, recorded in a separate test report.

2 Test Configuration of Equipment Under Test

2.1 Test Mode

During all testing, EUT is in link mode with base station emulator at maximum power level. The spurious emission measurements were carried out in semi-anechoic chamber with 3-meter test range, and EUT is rotated on three test planes to find out the worst emission.

Frequency range investigated for radiated emission: 30MHz to 26000 MHz.

Test Modes				
Band	Radiated TCs		Conducted TCs	
	Modulation : QPSK		Modulation : QPSK / 16QAM	
LTE Band 7	BW 5MHz	<ul style="list-style-type: none"> ■ LTE (RB Size 1, RB Offset 24) QPSK Link 	<ul style="list-style-type: none"> ■ LTE (RB Size 1, RB Offset 0) Link ■ LTE (RB Size 1, RB Offset 12) Link ■ LTE (RB Size 1, RB Offset 24) Link ■ LTE (RB Size 12, RB Offset 0) Link ■ LTE (RB Size 12, RB Offset 6) Link ■ LTE (RB Size 12, RB Offset 11) Link ■ LTE (RB Size 25, RB Offset 0) Link 	
	BW 10MHz	<ul style="list-style-type: none"> ■ LTE (RB Size 1, RB Offset 49) QPSK Link 	<ul style="list-style-type: none"> ■ LTE (RB Size 1, RB Offset 0) Link ■ LTE (RB Size 1, RB Offset 24) Link ■ LTE (RB Size 1, RB Offset 49) Link ■ LTE (RB Size 25, RB Offset 0) Link ■ LTE (RB Size 25, RB Offset 12) Link ■ LTE (RB Size 25, RB Offset 24) Link ■ LTE (RB Size 50, RB Offset 0) Link 	
	BW 15MHz	<ul style="list-style-type: none"> ■ LTE (RB Size 1, RB Offset 37) QPSK Link 	<ul style="list-style-type: none"> ■ LTE (RB Size 1, RB Offset 0) Link ■ LTE (RB Size 1, RB Offset 37) Link ■ LTE (RB Size 1, RB Offset 74) Link ■ LTE (RB Size 36, RB Offset 0) Link ■ LTE (RB Size 36, RB Offset 18) Link ■ LTE (RB Size 36, RB Offset 37) Link ■ LTE (RB Size 75, RB Offset 0) Link 	
	BW 20MHz	<ul style="list-style-type: none"> ■ LTE (RB Size 1, RB Offset 49) QPSK Link 	<ul style="list-style-type: none"> ■ LTE (RB Size 1, RB Offset 0) Link ■ LTE (RB Size 1, RB Offset 49) Link ■ LTE (RB Size 1, RB Offset 99) Link ■ LTE (RB Size 50, RB Offset 0) Link ■ LTE (RB Size 50, RB Offset 24) Link ■ LTE (RB Size 50, RB Offset 49) Link ■ LTE (RB Size 100, RB Offset 0) Link 	

Note:

1. For conducted test, both two Modulations (QPSK and 16QAM) are tested. For RSE, only the maximum

RF output power level is chosen.

2. From conducted spurious emission measurement, the modulation related spurious emission out of the band is not identified. Since MPR is implemented, 1RB-QPSK results in highest RF power, therefore it's chosen for RSE measurement.

2.2 Connection Diagram of Test System

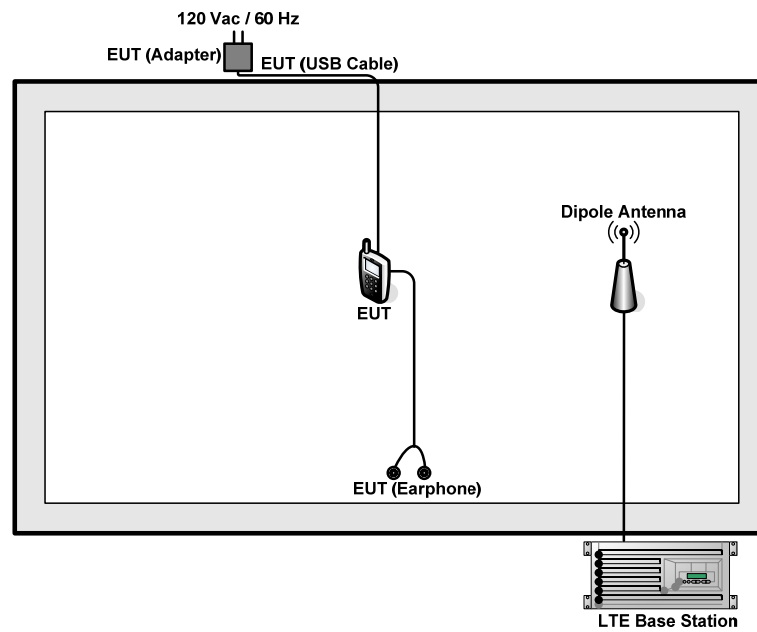

2.3 Support Unit used in test configuration and system

Item	Equipment	Trade Name	Model No.	FCC ID	Data Cable	Power Cord
1.	LTE Base Station	Anritsu	MT8820C	N/A	N/A	Unshielded, 1.8 m
2.	DC Power Supply	TOPWORD	3303DR	N/A	N/A	Unshielded, 1.8 m

2.4 Measurement Results Explanation Example

For all conducted test items:

The offset level is set in the spectrum analyzer to compensate the RF cable loss and attenuator factor between EUT conducted output port and spectrum analyzer. With the offset compensation, the spectrum analyzer reading level is exactly the EUT RF output level.

The spectrum analyzer offset is derived from RF cable loss and attenuator factor.

Offset = RF cable loss + attenuator factor.

Following shows an offset computation example with cable loss 7.5 dB and 10dB attenuator.

Example :

$$\begin{aligned} \text{Offset(dB)} &= \text{RF cable loss(dB)} + \text{attenuator factor(dB)}. \\ &= 7.5 + 10 = 17.5 \text{ (dB)} \end{aligned}$$

3 Test Result

3.1 Maximum Output Power and Effective Isotropic Radiated Power Measurement

3.1.1 Limit

For mobile and other user stations, mobile stations are limited to 2.0 watts EIRP and all user stations are limited to 2.0 watts transmitter output power. The power of any emission outside of the authorized operating frequency ranges must be attenuated below the transmitting power (p) by a factor of mobile digital stations, the attenuation factor shall be not less than $43 + 10 \log (p)$ dB at the channel edge and $55 + 10 \log (p)$ dB at 5.5 MHz from the channel edges.

3.1.2 Measuring Instruments

See list of measuring instruments of this test report.

3.1.3 Test Procedures

For Conducted Power Measurement:

1. The RF output of the transmitter was connected to base station simulator.
2. The RF output of EUT was connected to the spectrum analyzer by RF cable and attenuator. The path loss was compensated to the results for each measurement.
3. Set EUT at maximum average power by base station simulator.
4. Measure lowest, middle, and highest channels for each bandwidth and different modulation.

For Effective Isotropic Radiated Power Measurement:

1. The EUT was placed on a turntable with 1.5 meter height in a fully anechoic chamber.
2. The EUT was set at 3 meters from the receiving antenna, which was mounted on the antenna tower.
3. LTE operating modes: Set RBW= 100 KHz, VBW= 300 KHz, RMS detector over frame, and use channel power option with bandwidth=5MHz, per section 4.0 of KDB 971168 D01.
4. The table was rotated 360 degrees to determine the position of the highest radiated power.
5. The height of the receiving antenna is adjusted to look for the maximum EIRP.
6. Taking the record of maximum EIRP.
7. A dipole antenna was substituted in place of the EUT and was driven by a signal generator.
8. The conducted power at the terminal of the dipole antenna is measured.
9. Repeat step 3 to step 5 to get the maximum EIRP of the substitution antenna.
10. $EIRP = P_s + E_t - E_s + G_s = P_s + R_t - R_s + G_s$
 P_s (dBm) : Input power to substitution antenna.

Gs (dBi or dBd) : Substitution antenna Gain.

$E_t = R_t + AF$

$E_s = R_s + AF$

AF (dB/m) : Receive antenna factor

R_t : The highest received signal in spectrum analyzer for EUT.

R_s : The highest received signal in spectrum analyzer for substitution antenna.

3.1.4 Test Setup

<Conducted Power and Band Edge Measurement>

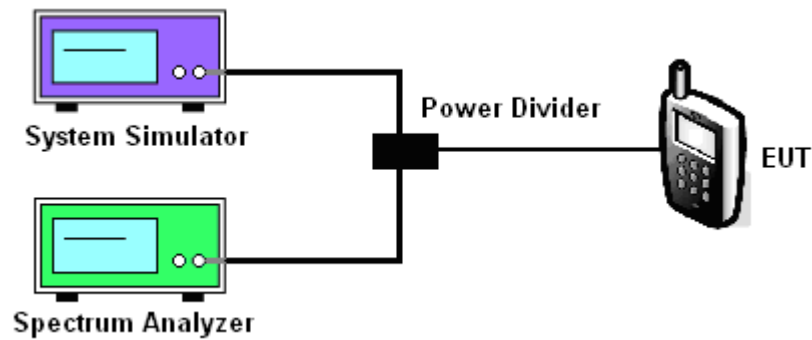

<Effective Isotropic Radiated Power Measurement>

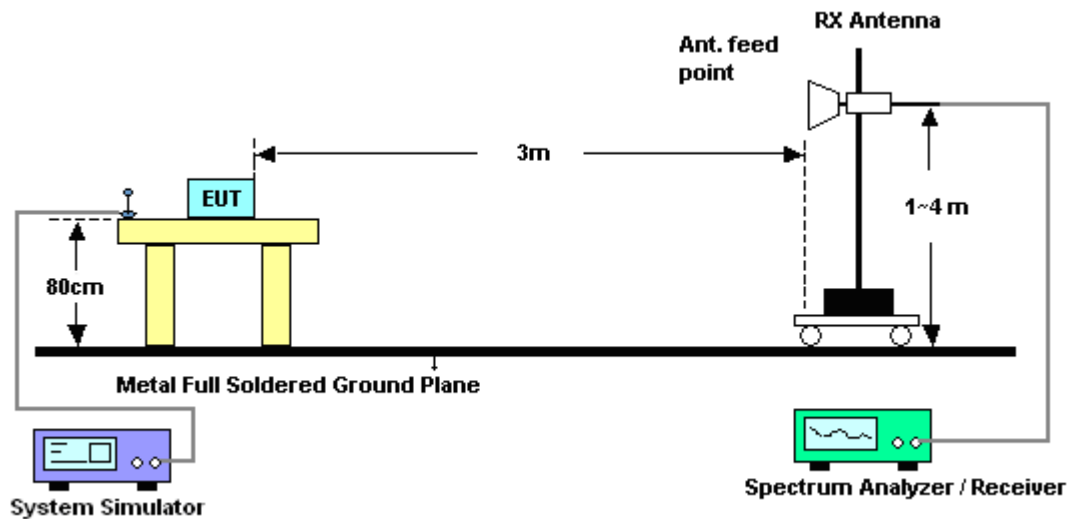



3.1.5 Test Result of Conducted Output Power

Mode	Band Width	Channel	Frequency (MHz)	Modulation	RB Configuration		Average Power (dBm)	Average Power (Watts)	
					RB Size	RB Offset			
LTE Band 7	5MHz	20815	2506.5	QPSK	1	0	19.54	0.0899	
					1	12	19.53	0.0897	
					1	24	19.60	0.0912	
					12	0	18.51	0.0710	
					12	6	18.57	0.0719	
					12	11	18.52	0.0711	
				16-QAM	25	0	18.34	0.0682	
					1	0	18.96	0.0787	
					1	12	18.96	0.0787	
					1	24	19.05	0.0804	
					12	0	17.83	0.0607	
					12	6	17.90	0.0617	
		21095	2534.5	QPSK	2534.5	12	11	17.98	0.0628
						25	0	17.67	0.0585
						1	0	19.16	0.0824
						1	12	19.06	0.0805
						1	24	19.01	0.0796
						12	0	18.12	0.0649
				16-QAM	12	6	18.13	0.0650	
					12	11	18.05	0.0638	
					25	0	17.96	0.0625	
					1	0	19.32	0.0855	
					1	12	19.28	0.0847	
					1	24	19.19	0.0830	
		21425	2567.5	QPSK	2567.5	12	0	18.48	0.0705
						12	6	18.26	0.0670
						12	11	18.28	0.0673
						25	0	18.20	0.0661
						1	0	19.56	0.0904
						1	12	19.83	0.0962
				16-QAM	1	24	19.94	0.0986	
					12	0	18.73	0.0746	
					12	6	18.75	0.0750	
					12	11	18.87	0.0771	
					25	0	18.63	0.0729	
					1	0	18.78	0.0755	
16-QAM	1	12	19.37	0.0865					
	1	24	19.27	0.0845					
	12	0	18.07	0.0641					
	12	6	18.14	0.0652					
	12	11	18.14	0.0652					
	25	0	17.90	0.0617					



Mode	Band Width	Channel	Frequency (MHz)	Modulation	RB Configuration		Average Power (dBm)	Average Power (Watts)	
					RB Size	RB Offset			
LTE Band 7	10MHz	20840	2509	QPSK	1	0	19.95	0.0989	
					1	24	20.05	0.1012	
					1	49	20.18	0.1042	
					25	0	18.58	0.0721	
					25	12	18.72	0.0745	
					25	24	18.79	0.0757	
				16-QAM	50	0	18.65	0.0733	
					1	0	19.40	0.0871	
					1	24	19.46	0.0883	
					1	49	19.49	0.0889	
					25	0	18.07	0.0641	
					25	12	18.12	0.0649	
		21070	2532	QPSK	2532	25	24	18.14	0.0652
						25	24	18.14	0.0652
						50	0	17.92	0.0619
						1	0	19.23	0.0838
						1	24	19.00	0.0794
						1	49	18.87	0.0771
				16-QAM	25	0	17.83	0.0607	
					25	12	17.83	0.0607	
					25	24	17.78	0.0600	
					50	0	17.92	0.0619	
					1	0	18.60	0.0724	
					1	24	18.50	0.0708	
		21400	2565	QPSK	2565	1	49	18.47	0.0703
						25	0	17.29	0.0536
						25	12	17.21	0.0526
						25	24	17.26	0.0532
						50	0	17.11	0.0514
						1	0	19.35	0.0861
16-QAM	1			24	19.79	0.0953			
	1			49	19.81	0.0957			
	25			0	18.54	0.0714			
	25			12	18.62	0.0728			
	25			24	18.90	0.0776			
	50			0	18.61	0.0726			
16-QAM	1	0	18.85	0.0703					
	1	24	18.90	0.0776					
	1	49	19.45	0.0881					
	25	0	17.76	0.0597					
	25	12	17.77	0.0598					
	25	24	17.95	0.0624					
					50	0	17.56	0.0570	



Mode	Band Width	Channel	Frequency (MHz)	Modulation	RB Configuration		Average Power (dBm)	Average Power (Watts)
					RB Size	RB Offset		
LTE Band 7	15MHz	20865	2511.5	QPSK	1	0	19.99	0.0998
					1	37	20.29	0.1069
					1	74	20.27	0.1064
					36	0	18.75	0.0750
					36	18	18.89	0.0774
					36	37	18.95	0.0785
					75	0	18.72	0.0745
		16-QAM	1	0	19.36	0.0863		
			1	37	19.49	0.0889		
			1	74	19.37	0.0865		
			36	0	18.23	0.0665		
			36	18	18.31	0.0678		
			36	37	18.39	0.0690		
			75	0	18.26	0.0670		
	21045	2529.5	QPSK	1	0	19.88	0.0973	
				1	37	19.60	0.0912	
				1	74	19.25	0.0841	
				36	0	18.54	0.0714	
				36	18	18.33	0.0681	
				36	37	18.24	0.0667	
				75	0	18.24	0.0667	
	16-QAM	1	0	19.45	0.0881			
		1	37	19.32	0.0855			
		1	74	19.27	0.0845			
		36	0	17.77	0.0598			
		36	18	17.69	0.0587			
		36	37	17.56	0.0570			
75		0	17.46	0.0557				
21375	2562.5	QPSK	1	0	19.16	0.0824		
			1	37	19.41	0.0873		
			1	74	19.74	0.0942		
			36	0	18.24	0.0667		
			36	18	18.07	0.0641		
			36	37	18.19	0.0659		
			75	0	18.17	0.0656		
	16-QAM	1	0	18.82	0.0762			
		1	37	18.99	0.0793			
		1	74	19.44	0.0879			
		36	0	18.02	0.0634			
		36	18	17.73	0.0593			
		36	37	17.82	0.0605			
75	0	17.62	0.0578					



Mode	Band Width	Channel	Frequency (MHz)	Modulation	RB Configuration		Average Power (dBm)	Average Power (Watts)
					RB Size	RB Offset		
LTE Band 7	20MHz	20890	2514	QPSK	1	0	20.25	0.1059
					1	49	20.48	0.1117
					1	99	19.86	0.0968
					50	0	18.95	0.0785
					50	24	19.49	0.0889
					50	49	19.38	0.0867
		100	0	19.31	0.0853			
		16-QAM	1	0	19.37	0.0865		
			1	49	19.47	0.0885		
			1	99	19.44	0.0879		
			50	0	17.97	0.0627		
			50	24	17.99	0.0630		
	50		49	18.25	0.0668			
	100	0	18.33	0.0681				
	21020	2527	QPSK	1	0	20.42	0.1102	
				1	49	20.26	0.1062	
				1	99	19.75	0.0944	
				50	0	19.11	0.0815	
				50	24	18.94	0.0783	
				50	49	18.80	0.0759	
		100	0	18.73	0.0746			
		16-QAM	1	0	19.49	0.0889		
			1	49	19.34	0.0859		
			1	99	19.36	0.0863		
50			0	18.34	0.0682			
50			24	18.15	0.0653			
50	49		18.09	0.0644				
100	0	18.18	0.0658					

Note: Maximum average power for LTE.

3.1.6 Test Result of Effective Isotropic Radiated Power

LTE Band 7 Radiated Power EIRP								
LTE Band	Channel BW (MHz)	Modulation	RB Configuration		Freq. (MHz)	EIRP (dBm)	EIRP (W)	H/V
			RB Size	RB Offset				
7	5	QPSK	1	24	2506.5	21.09	0.1285	H
7	5	QPSK	1	0	2534.5	21.25	0.1334	H
7	5	QPSK	1	24	2567.5	22.66	0.1845	H
7	5	QPSK	1	24	2506.5	21.27	0.1340	V
7	5	QPSK	1	0	2534.5	21.23	0.1327	V
7	5	QPSK	1	24	2567.5	22.55	0.1799	V
7	5	16QAM	1	24	2506.5	19.97	0.0993	H
7	5	16QAM	1	0	2534.5	20.33	0.1079	H
7	5	16QAM	1	12	2567.5	21.14	0.1300	H
7	5	16QAM	1	24	2506.5	20.10	0.1023	V
7	5	16QAM	1	0	2534.5	20.25	0.1059	V
7	5	16QAM	1	12	2567.5	21.01	0.1262	V
7	10	QPSK	1	49	2509	20.74	0.1186	H
7	10	QPSK	1	0	2532	22.63	0.1832	H
7	10	QPSK	1	49	2565	22.73	0.1875	H
7	10	QPSK	1	49	2509	20.80	0.1202	V
7	10	QPSK	1	0	2532	22.01	0.1589	V
7	10	QPSK	1	49	2565	22.59	0.1816	V
7	10	16QAM	1	49	2509	19.98	0.0995	H
7	10	16QAM	1	0	2532	20.43	0.1104	H
7	10	16QAM	1	49	2565	21.57	0.1435	H
7	10	16QAM	1	49	2509	20.05	0.1012	V
7	10	16QAM	1	0	2532	20.47	0.1114	V
7	10	16QAM	1	49	2565	21.45	0.1396	V



LTE Band 7 Radiated Power EIRP								
LTE Band	Channel BW (MHz)	Modulation	RB Configuration		Freq. (MHz)	EIRP (dBm)	EIRP (W)	H/V
			RB Size	RB Offset				
7	15	QPSK	1	37	2511.5	20.45	0.1109	H
7	15	QPSK	1	0	2529.5	22.42	0.1746	H
7	15	QPSK	1	74	2562.5	22.62	0.1828	H
7	15	QPSK	1	37	2511.5	20.61	0.1151	V
7	15	QPSK	1	0	2529.5	21.83	0.1524	V
7	15	QPSK	1	74	2562.5	22.52	0.1786	V
7	15	16QAM	1	37	2511.5	19.95	0.0989	H
7	15	16QAM	1	0	2529.5	20.50	0.1122	H
7	15	16QAM	1	74	2562.5	21.43	0.1390	H
7	15	16QAM	1	37	2511.5	20.02	0.1005	V
7	15	16QAM	1	0	2529.5	20.40	0.1096	V
7	15	16QAM	1	74	2562.5	21.30	0.1349	V
7	20	QPSK	1	49	2514	20.45	0.1109	H
7	20	QPSK	1	0	2527	20.31	0.1074	H
7	20	QPSK	1	49	2514	20.60	0.1148	V
7	20	QPSK	1	0	2527	20.35	0.1084	V
7	20	16QAM	1	49	2514	20.00	0.1000	H
7	20	16QAM	1	0	2527	20.36	0.1086	H
7	20	16QAM	1	49	2514	20.10	0.1023	V
7	20	16QAM	1	0	2527	20.31	0.1074	V

3.2 99% Occupied Bandwidth and 26dB Bandwidth Measurement

3.2.1 Description of 99% Occupied Bandwidth and 26dB Bandwidth Measurement

The occupied bandwidth is the width of a frequency band such that, below the lower and above the upper frequency limits, the mean powers emitted are each equal to a specified percentage 0.5% of the total mean transmitted power.

The emission bandwidth is defined as the width of the signal between two points, located at the 2 sides of the carrier frequency, outside of which all emissions are attenuated at least 26 dB below the transmitter power.

3.2.2 Measuring Instruments

See list of measuring instruments of this test report.

3.2.3 Test Procedures

11. The EUT was connected to Spectrum Analyzer and Base Station via power divider.
12. The RF output of EUT was connected to the spectrum analyzer by RF cable and attenuator. The path loss was compensated to the results for each measurement.
13. The 99% occupied bandwidth and 26 dB bandwidth of the middle channel for the highest RF powers were measured.

3.2.4 Test Setup

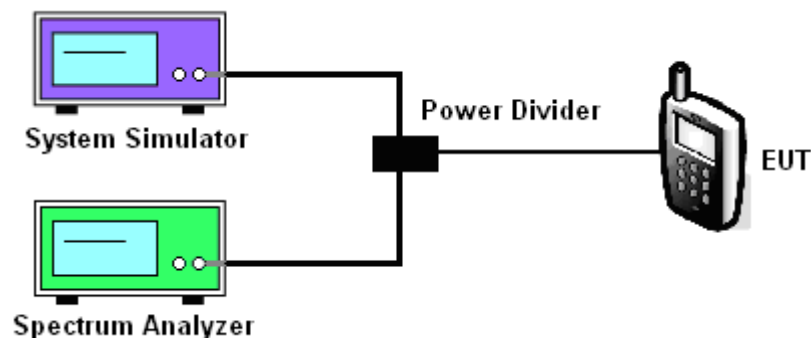



3.2.6 Test Result of 99% Occupied Bandwidth and 26dB Bandwidth

Modes	LTE Band 7			
BW / Modulation	5MHz / QPSK	5MHz / 16QAM	10MHz / QPSK	10MHz / 16QAM
99% OBW (MHz)	4.52	4.52	9.16	9.12
26dB BW (MHz)	5.08	5.16	10.12	10.12

Modes	LTE Band 7			
BW / Modulation	15MHz / QPSK	15MHz / 16QAM	20MHz / QPSK	20MHz / 16QAM
99% OBW (MHz)	13.62	13.56	18.00	18.00
26dB BW (MHz)	14.76	15.00	21.20	21.44



3.2.7 Test Plots of 99% Occupied Bandwidth and 26dB Bandwidth

Band :	LTE Band 7	BW / Mod. :	5MHz / QPSK
--------	------------	-------------	-------------

**99% Occupied Bandwidth Plot on Channel 21095
for RB Size 25, RB Offset 0**

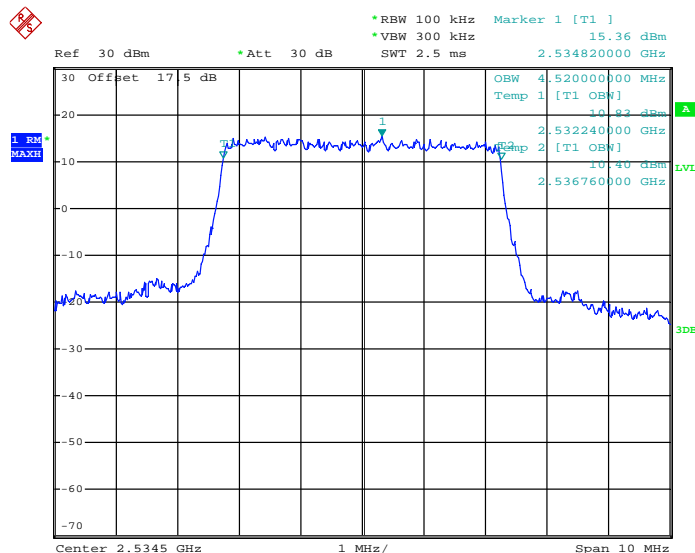

Date: 4.SEP.2013 16:42:57

**26dB Bandwidth Plot on Channel 21095
for RB Size 25, RB Offset 0**

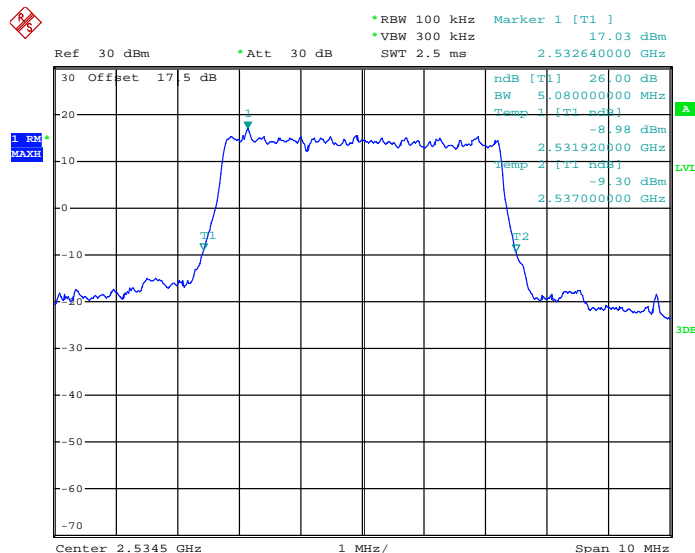

Date: 4.SEP.2013 16:19:20



Band :	LTE Band 7	BW / Mod. :	5MHz / 16QAM
--------	------------	-------------	--------------

**99% Occupied Bandwidth Plot on Channel 21095
for RB Size 25, RB Offset 0**

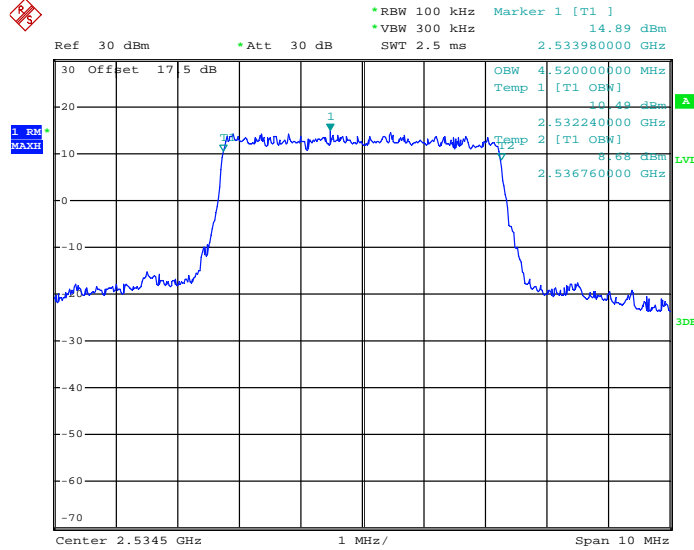

Date: 4.SEP.2013 16:42:07

**26dB Bandwidth Plot on Channel 21095
for RB Size 25, RB Offset 0**

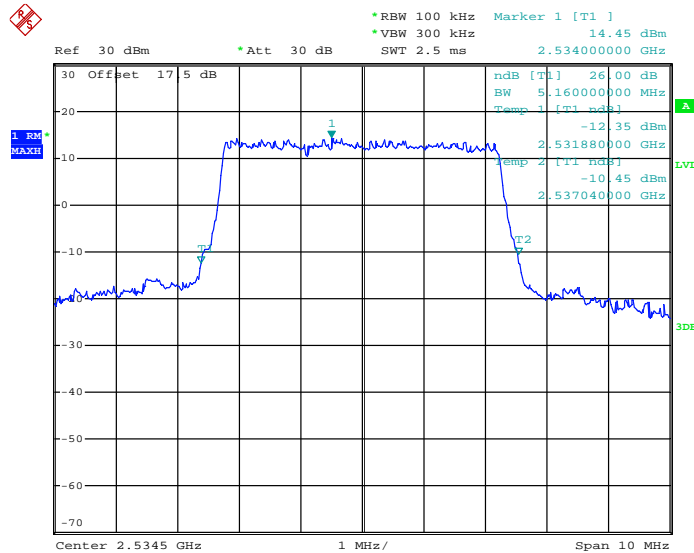

Date: 4.SEP.2013 16:20:32



Band :	LTE Band 7	BW / Mod. :	10MHz / QPSK
--------	------------	-------------	--------------

**99% Occupied Bandwidth Plot on Channel 21070
for RB Size 50, RB Offset 0**

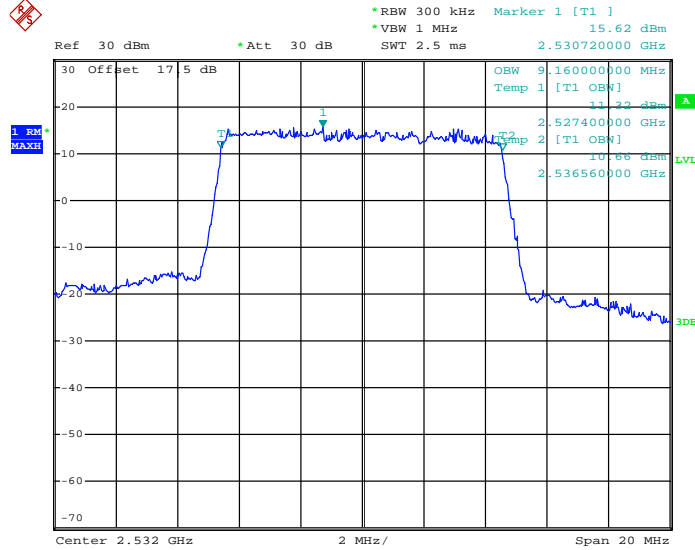

Date: 4.SEP.2013 16:53:12

**26dB Bandwidth Plot on Channel 21070
for RB Size 50, RB Offset 0**

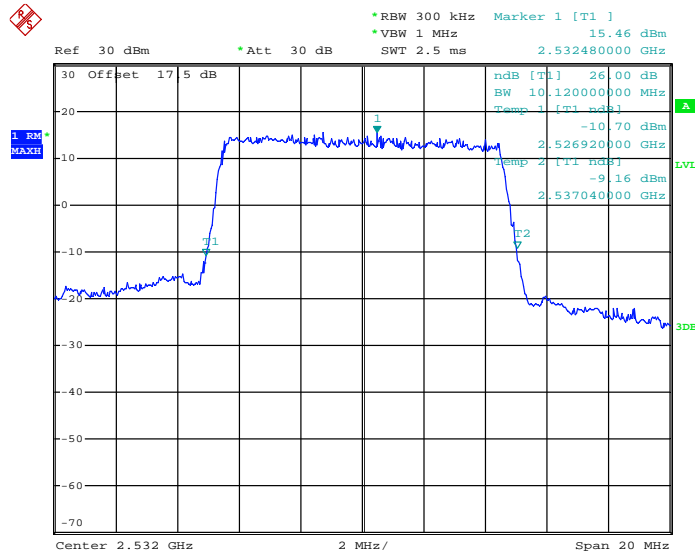

Date: 4.SEP.2013 16:24:36



Band :	LTE Band 7	BW / Mod. :	10MHz / 16QAM
--------	------------	-------------	---------------

**99% Occupied Bandwidth Plot on Channel 21070
for RB Size 50, RB Offset 0**

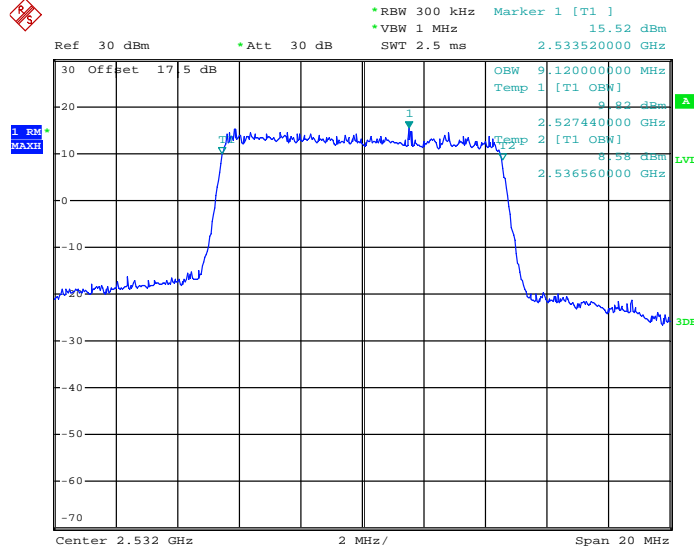

Date: 4.SEP.2013 16:52:15

**26dB Bandwidth Plot on Channel 21070
for RB Size 50, RB Offset 0**

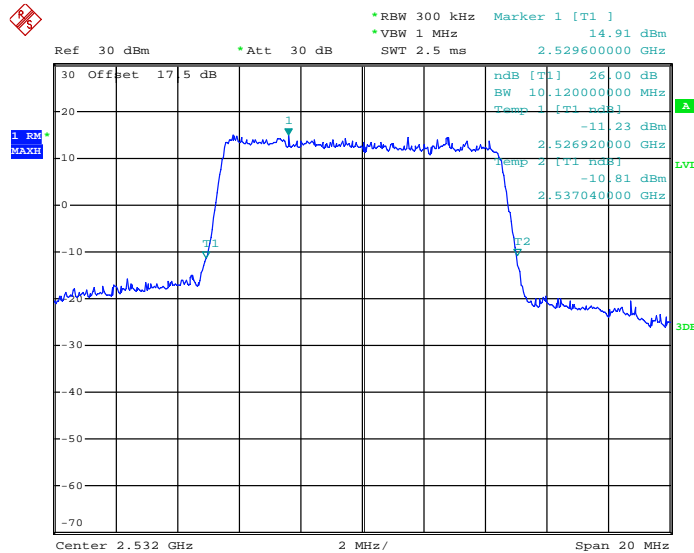

Date: 4.SEP.2013 16:25:29



Band :	LTE Band 7	BW / Mod. :	15MHz / QPSK
--------	------------	-------------	--------------

**99% Occupied Bandwidth Plot on Channel 21045
for RB Size 75, RB Offset 0**

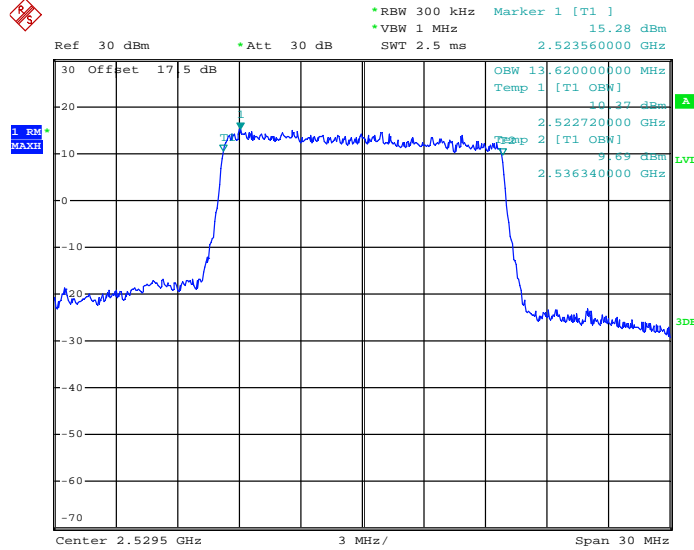

Date: 4.SEP.2013 17:11:27

**26dB Bandwidth Plot on Channel 21045
for RB Size 75, RB Offset 0**

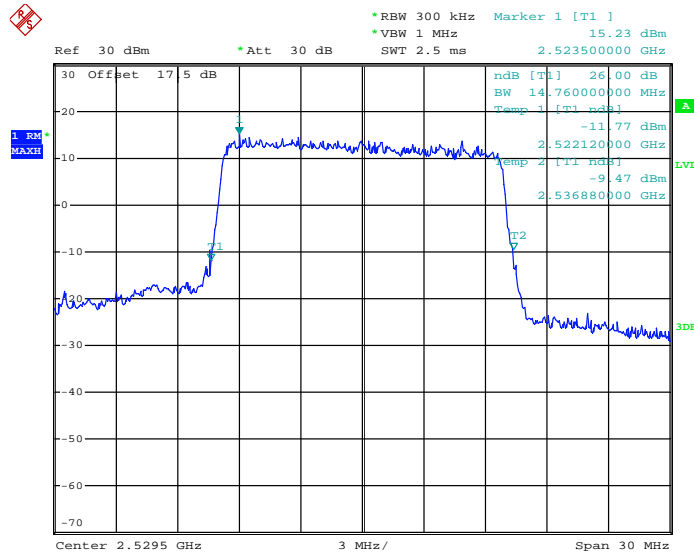

Date: 4.SEP.2013 16:27:58



Band :	LTE Band 7	BW / Mod. :	15MHz / 16QAM
--------	------------	-------------	---------------

**99% Occupied Bandwidth Plot on Channel 21045
for RB Size 75, RB Offset 0**

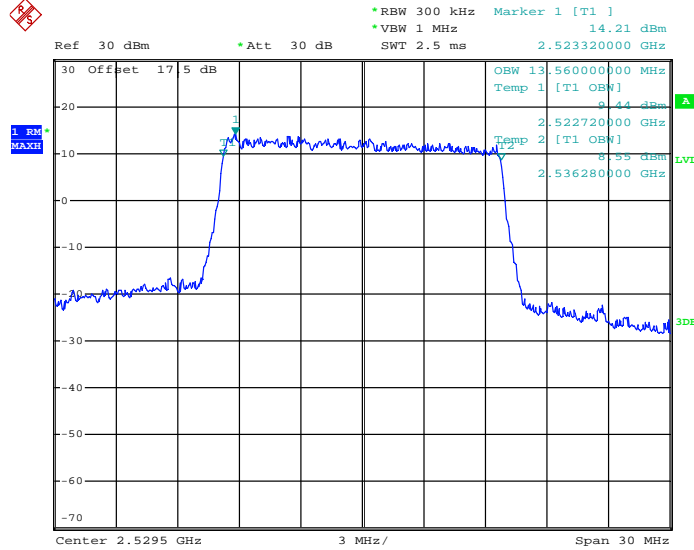

Date: 4.SEP.2013 17:03:35

**26dB Bandwidth Plot on Channel 21045
for RB Size 75, RB Offset 0**

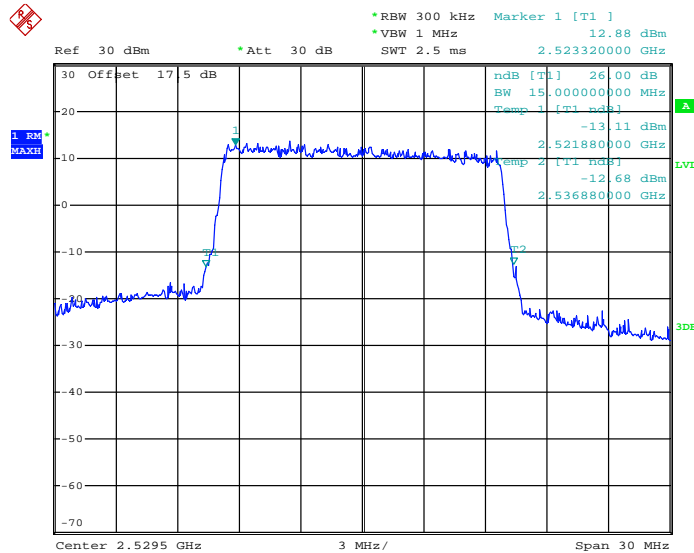

Date: 4.SEP.2013 16:26:58



Band :	LTE Band 7	BW / Mod. :	20MHz / QPSK
--------	------------	-------------	--------------

**99% Occupied Bandwidth Plot on Channel 21020
for RB Size 100, RB Offset 0**

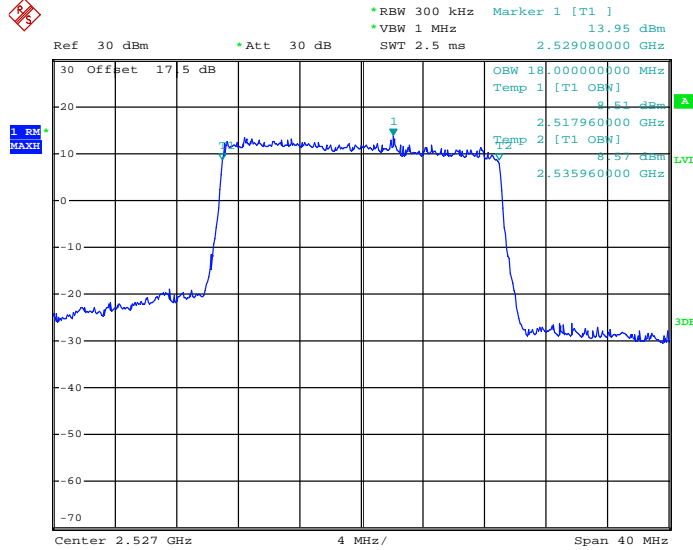

Date: 4.SEP.2013 17:20:32

**26dB Bandwidth Plot on Channel 21020
for RB Size 100, RB Offset 0**

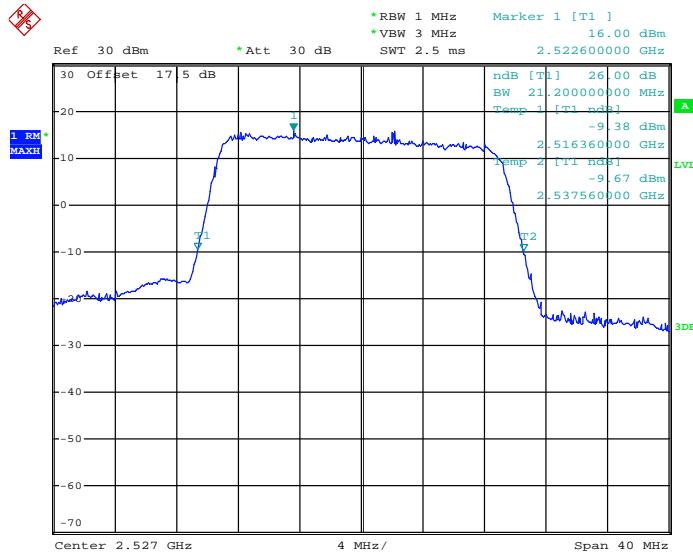

Date: 4.SEP.2013 16:29:14



Band :	LTE Band 7	BW / Mod. :	20MHz / 16QAM
--------	------------	-------------	---------------

**99% Occupied Bandwidth Plot on Channel 21020
for RB Size 100, RB Offset 0**

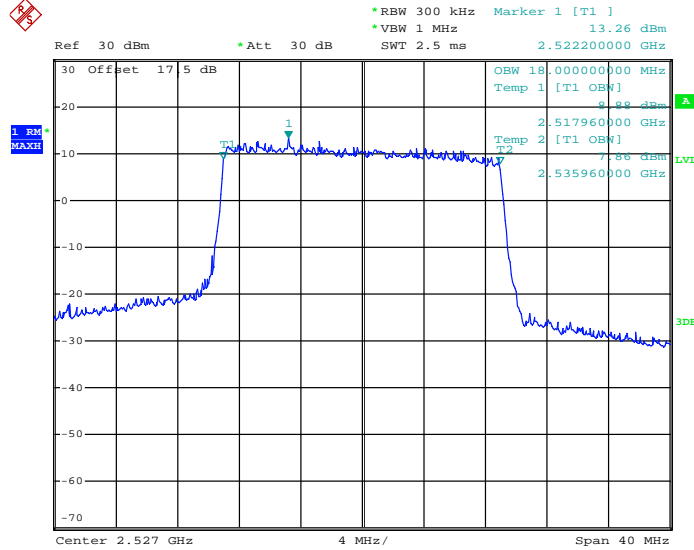

Date: 4.SEP.2013 17:18:34

**26dB Bandwidth Plot on Channel 21020 for
RB Size 100, RB Offset 0**

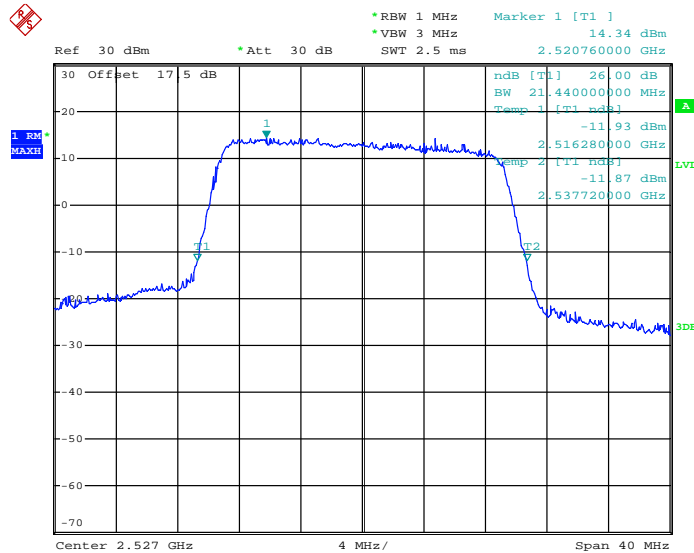

Date: 4.SEP.2013 16:29:53

3.3 Conducted Band Edge and Spurious Emission Measurement

3.3.1 Description of Conducted Band Edge and Spurious Emission Measurement

The power of any emission outside of the authorized operating frequency ranges must be lower than the transmitter power (P) by a factor of mobile digital stations, the attenuation factor shall be not less than $43 + 10 \log (P)$ dB at the channel edge and $55 + 10 \log (P)$ dB at 5.5 MHz from the channel edges. It is measured by means of a calibrated spectrum analyzer and scanned from 30 MHz up to a frequency including its 10th harmonic.

3.3.2 Measuring Instruments

See list of measuring instruments of this test report.

3.3.3 Test Procedures

1. The EUT was connected to spectrum analyzer and System Simulator via power divider.
2. The RF output of EUT was connected to the spectrum analyzer by RF cable and attenuator. The path loss was compensated to the results for each measurement.
3. The conducted spurious emission for the whole frequency range was taken.

3.3.4 Test Setup

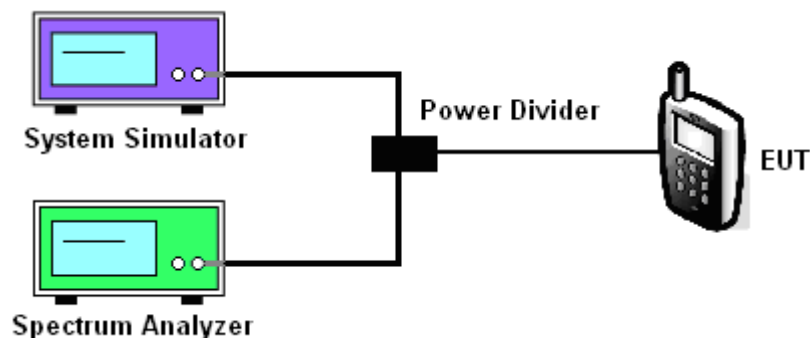

3.3.5 Test Plots of Conducted Band-Edge Emission

Band :	LTE Band 7	Band Width	5MHz / QPSK
---------------	------------	-------------------	-------------

Lower Band Edge Plot for QPSK-RB Size 1, RB Offset 0

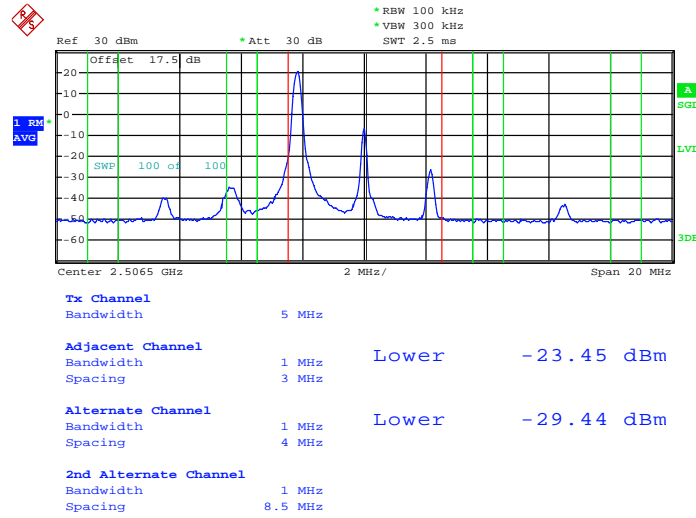

Date: 5.SEP.2013 12:20:20

Lower Band Edge Plot for QPSK-RB Size 25, RB Offset 0

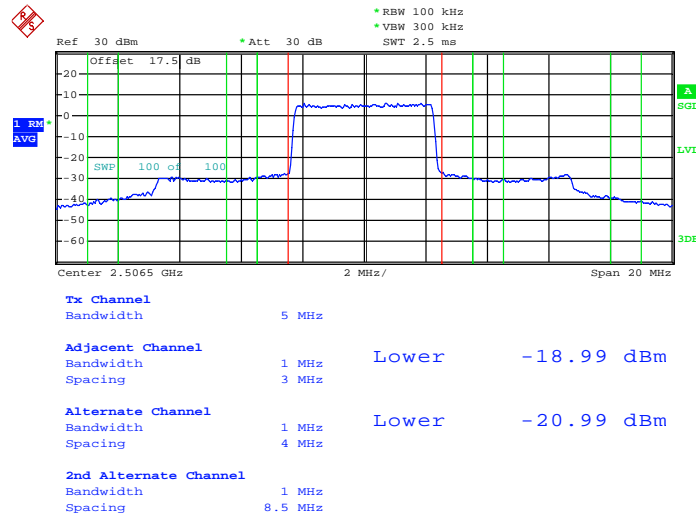

Date: 5.SEP.2013 12:19:46



Higher Band Edge Plot for QPSK-RB Size 1, RB Offset 24

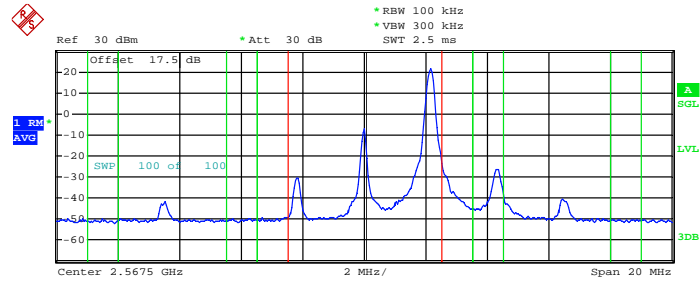

Tx Channel			
Bandwidth	5 MHz		
Adjacent Channel			
Bandwidth	1 MHz		
Spacing	3 MHz	Upper	-20.82 dBm
Alternate Channel			
Bandwidth	1 MHz		
Spacing	4 MHz	Upper	-22.97 dBm
2nd Alternate Channel			
Bandwidth	1 MHz		
Spacing	8.5 MHz		

Date: 5.SEP.2013 12:22:13

Higher Band Edge Plot for QPSK-RB Size 25, RB Offset 0

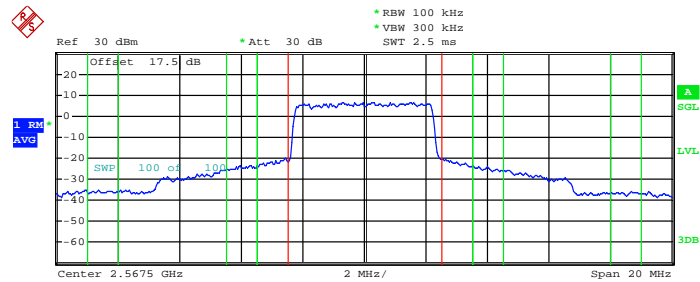

Tx Channel			
Bandwidth	5 MHz		
Adjacent Channel			
Bandwidth	1 MHz		
Spacing	3 MHz	Upper	-12.38 dBm
Alternate Channel			
Bandwidth	1 MHz		
Spacing	4 MHz	Upper	-15.32 dBm
2nd Alternate Channel			
Bandwidth	1 MHz		
Spacing	8.5 MHz		

Date: 5.SEP.2013 12:22:39



Band :	LTE Band 7	Band Width	5MHz / 16QAM
---------------	------------	-------------------	--------------

Lower Band Edge Plot for 16QAM -RB Size 1, RB Offset 0

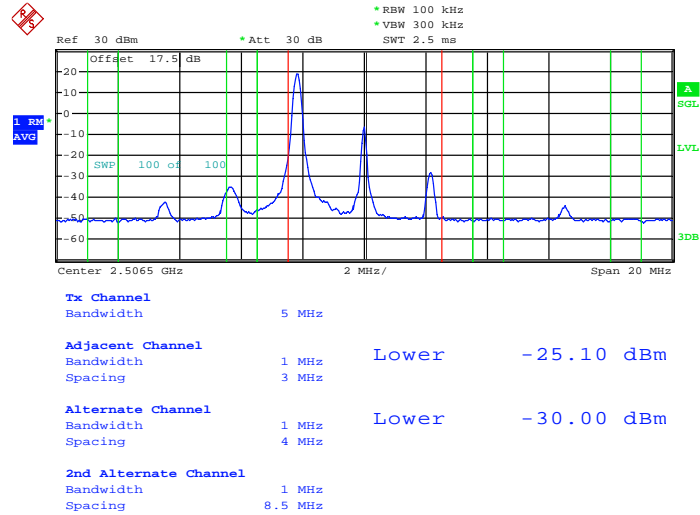

Date: 5.SEP.2013 12:20:35

Lower Band Edge Plot for 16QAM -RB Size 25, RB Offset 0

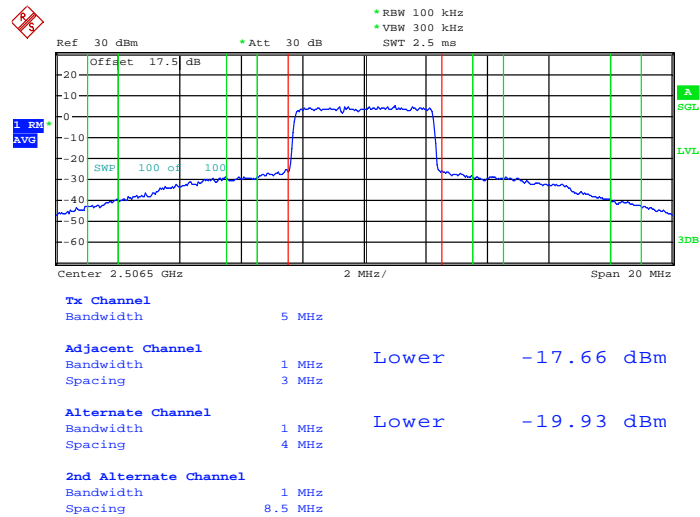

Date: 5.SEP.2013 12:19:25



Higher Band Edge Plot for 16QAM -RB Size 1, RB Offset 24

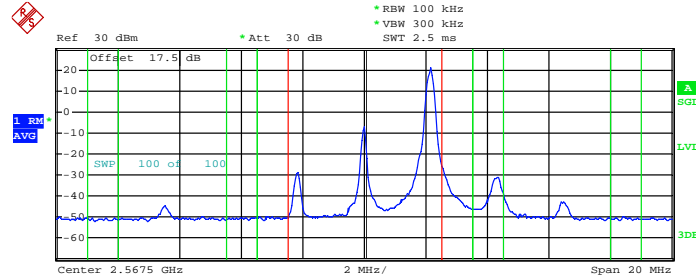

Tx Channel			
Bandwidth	5 MHz		
Adjacent Channel			
Bandwidth	1 MHz		
Spacing	3 MHz	Upper	-23.67 dBm
Alternate Channel			
Bandwidth	1 MHz		
Spacing	4 MHz	Upper	-26.48 dBm
2nd Alternate Channel			
Bandwidth	1 MHz		
Spacing	8.5 MHz		

Date: 5.SEP.2013 12:21:40

Higher Band Edge Plot for 16QAM -RB Size 25, RB Offset 0

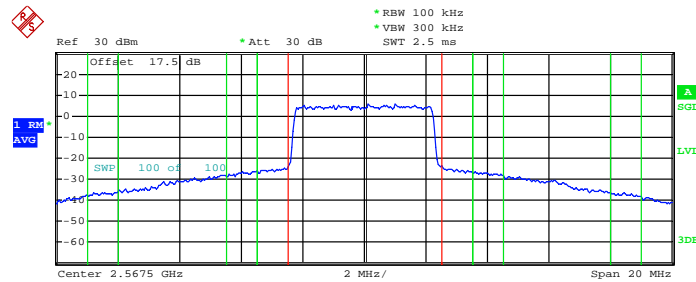

Tx Channel			
Bandwidth	5 MHz		
Adjacent Channel			
Bandwidth	1 MHz		
Spacing	3 MHz	Upper	-15.91 dBm
Alternate Channel			
Bandwidth	1 MHz		
Spacing	4 MHz	Upper	-17.57 dBm
2nd Alternate Channel			
Bandwidth	1 MHz		
Spacing	8.5 MHz		

Date: 5.SEP.2013 12:23:03



Band :	LTE Band 7	Band Width	10MHz / QPSK
---------------	------------	-------------------	--------------

Lower Band Edge Plot for QPSK-RB Size 1, RB Offset 0

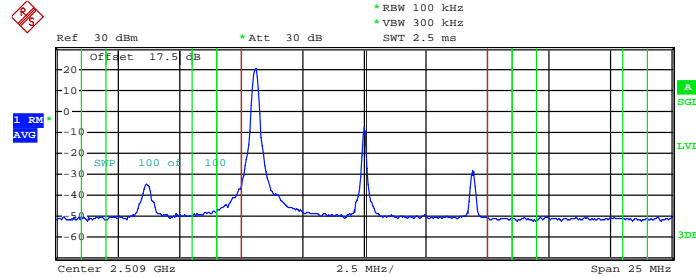

Tx Channel	Bandwidth	10 MHz		
Adjacent Channel	Bandwidth	1 MHz	Lower	-32.00 dBm
	Spacing	5.5 MHz		
Alternate Channel	Bandwidth	1 MHz	Lower	-38.84 dBm
	Spacing	6.5 MHz		
2nd Alternate Channel	Bandwidth	1 MHz		
	Spacing	11 MHz		

Date: 5.SEP.2013 12:30:41

Lower Band Edge Plot for QPSK-RB Size 50, RB Offset 0

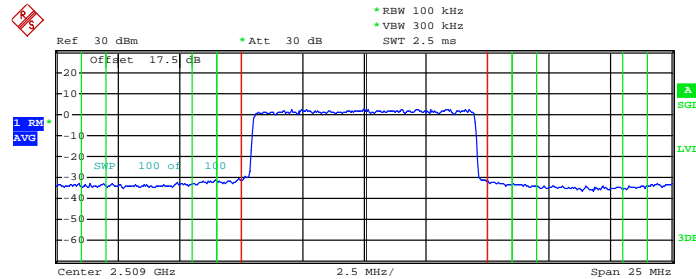

Tx Channel	Bandwidth	10 MHz		
Adjacent Channel	Bandwidth	1 MHz	Lower	-22.12 dBm
	Spacing	5.5 MHz		
Alternate Channel	Bandwidth	1 MHz	Lower	-22.60 dBm
	Spacing	6.5 MHz		
2nd Alternate Channel	Bandwidth	1 MHz		
	Spacing	11 MHz		

Date: 5.SEP.2013 12:31:22



Higher Band Edge Plot for QPSK-RB Size 1, RB Offset 49

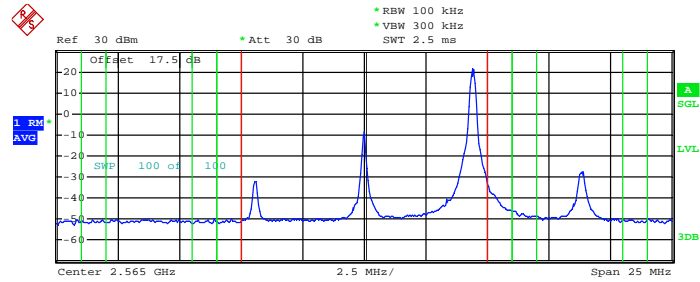

Tx Channel	Bandwidth	10 MHz		
Adjacent Channel	Bandwidth	1 MHz		
	Spacing	5.5 MHz	Upper	-29.78 dBm
Alternate Channel	Bandwidth	1 MHz		
	Spacing	6.5 MHz	Upper	-38.19 dBm
2nd Alternate Channel	Bandwidth	1 MHz		
	Spacing	11 MHz		

Date: 5.SEP.2013 12:26:58

Higher Band Edge Plot for QPSK-RB Size 50, RB Offset 0

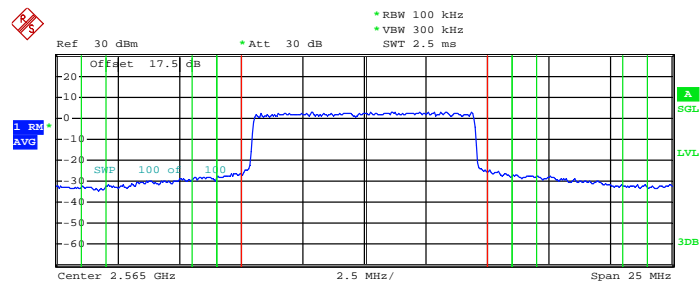

Tx Channel	Bandwidth	10 MHz		
Adjacent Channel	Bandwidth	1 MHz		
	Spacing	5.5 MHz	Upper	-16.58 dBm
Alternate Channel	Bandwidth	1 MHz		
	Spacing	6.5 MHz	Upper	-17.99 dBm
2nd Alternate Channel	Bandwidth	1 MHz		
	Spacing	11 MHz		

Date: 5.SEP.2013 12:26:28



Band :	LTE Band 7	Band Width	10MHz / 16QAM
---------------	------------	-------------------	---------------

Lower Band Edge Plot for 16QAM -RB Size 1, RB Offset 0

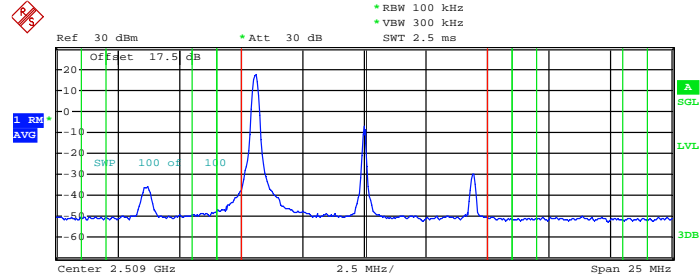

Tx Channel	Bandwidth	10 MHz		
Adjacent Channel	Bandwidth	1 MHz	Lower	-33.17 dBm
	Spacing	5.5 MHz		
Alternate Channel	Bandwidth	1 MHz	Lower	-39.13 dBm
	Spacing	6.5 MHz		
2nd Alternate Channel	Bandwidth	1 MHz		
	Spacing	11 MHz		

Date: 5.SEP.2013 12:28:15

Lower Band Edge Plot for 16QAM -RB Size 50, RB Offset 0

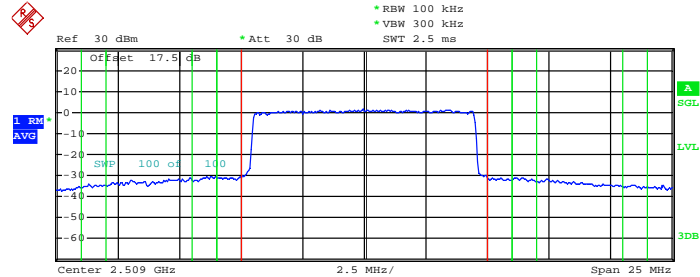

Tx Channel	Bandwidth	10 MHz		
Adjacent Channel	Bandwidth	1 MHz	Lower	-21.57 dBm
	Spacing	5.5 MHz		
Alternate Channel	Bandwidth	1 MHz	Lower	-21.65 dBm
	Spacing	6.5 MHz		
2nd Alternate Channel	Bandwidth	1 MHz		
	Spacing	11 MHz		

Date: 5.SEP.2013 12:31:45



Higher Band Edge Plot for 16QAM -RB Size 1, RB Offset 49

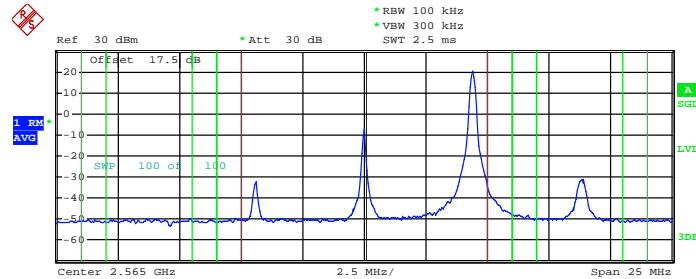

Tx Channel	Bandwidth	10 MHz		
Adjacent Channel	Bandwidth	1 MHz		
	Spacing	5.5 MHz	Upper	-31.45 dBm
Alternate Channel	Bandwidth	1 MHz		
	Spacing	6.5 MHz	Upper	-39.10 dBm
2nd Alternate Channel	Bandwidth	1 MHz		
	Spacing	11 MHz		

Date: 5.SEP.2013 12:27:18

Higher Band Edge Plot for 16QAM -RB Size 50, RB Offset 0

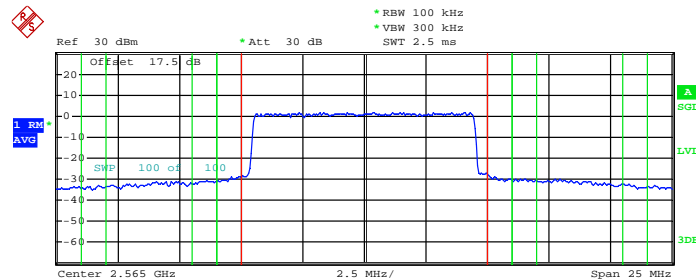

Tx Channel	Bandwidth	10 MHz		
Adjacent Channel	Bandwidth	1 MHz		
	Spacing	5.5 MHz	Upper	-19.90 dBm
Alternate Channel	Bandwidth	1 MHz		
	Spacing	6.5 MHz	Upper	-20.67 dBm
2nd Alternate Channel	Bandwidth	1 MHz		
	Spacing	11 MHz		

Date: 5.SEP.2013 12:26:02



Band :	LTE Band 7	Band Width	15MHz / QPSK
---------------	------------	-------------------	--------------

Lower Band Edge Plot for QPSK-RB Size 1, RB Offset 0

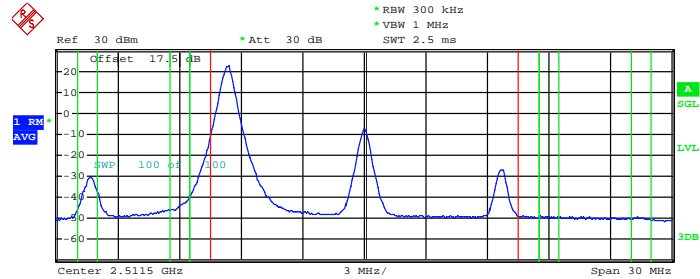

Tx Channel	Bandwidth	15 MHz		
Adjacent Channel	Bandwidth	1 MHz	Lower	-16.11 dBm
	Spacing	8 MHz		
Alternate Channel	Bandwidth	1 MHz	Lower	-39.01 dBm
	Spacing	9 MHz		
2nd Alternate Channel	Bandwidth	1 MHz		
	Spacing	13.5 MHz		

Date: 5.SEP.2013 12:37:49

Lower Band Edge Plot for QPSK-RB Size 75, RB Offset 0

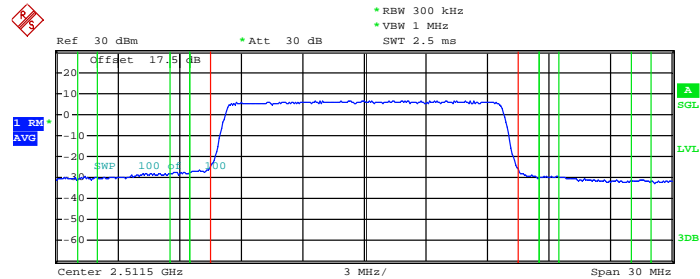

Tx Channel	Bandwidth	15 MHz		
Adjacent Channel	Bandwidth	1 MHz	Lower	-22.30 dBm
	Spacing	8 MHz		
Alternate Channel	Bandwidth	1 MHz	Lower	-23.43 dBm
	Spacing	9 MHz		
2nd Alternate Channel	Bandwidth	1 MHz		
	Spacing	13.5 MHz		

Date: 5.SEP.2013 12:37:26



Higher Band Edge Plot for QPSK-RB Size 1, RB Offset 74

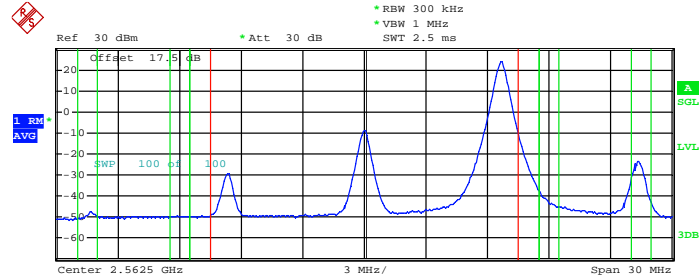

Tx Channel			
Bandwidth	15 MHz		
Adjacent Channel			
Bandwidth	1 MHz		
Spacing	8 MHz	Upper	-13.65 dBm
Alternate Channel			
Bandwidth	1 MHz		
Spacing	9 MHz	Upper	-37.22 dBm
2nd Alternate Channel			
Bandwidth	1 MHz		
Spacing	13.5 MHz		

Date: 5.SEP.2013 12:40:05

Higher Band Edge Plot for QPSK-RB Size 75, RB Offset 0

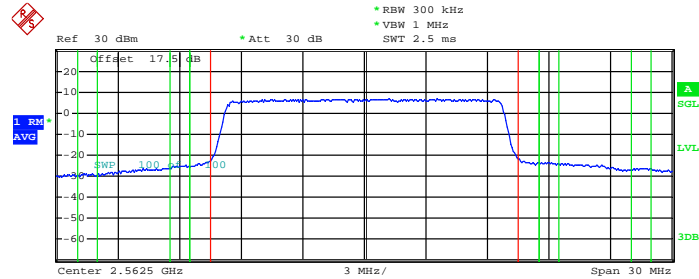

Tx Channel			
Bandwidth	15 MHz		
Adjacent Channel			
Bandwidth	1 MHz		
Spacing	8 MHz	Upper	-18.78 dBm
Alternate Channel			
Bandwidth	1 MHz		
Spacing	9 MHz	Upper	-19.40 dBm
2nd Alternate Channel			
Bandwidth	1 MHz		
Spacing	13.5 MHz		

Date: 5.SEP.2013 12:40:32



Band :	LTE Band 7	Band Width	15MHz / 16QAM
---------------	------------	-------------------	---------------

Lower Band Edge Plot for 16QAM -RB Size 1, RB Offset 0

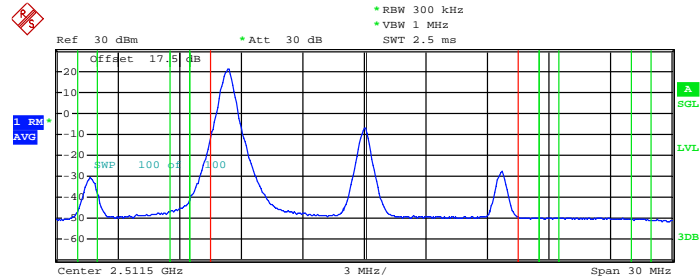

Tx Channel	Bandwidth	15 MHz		
Adjacent Channel	Bandwidth	1 MHz	Lower	-17.39 dBm
	Spacing	8 MHz		
Alternate Channel	Bandwidth	1 MHz	Lower	-40.20 dBm
	Spacing	9 MHz		
2nd Alternate Channel	Bandwidth	1 MHz		
	Spacing	13.5 MHz		

Date: 5.SEP.2013 12:38:15

Lower Band Edge Plot for 16QAM -RB Size 75, RB Offset 0

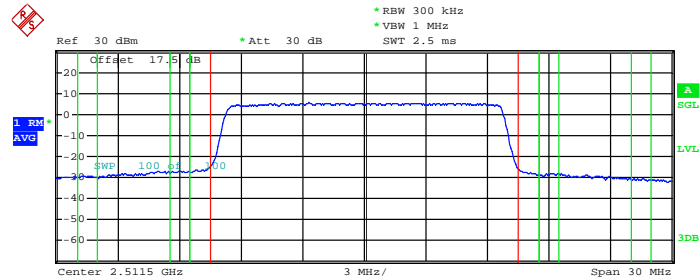

Tx Channel	Bandwidth	15 MHz		
Adjacent Channel	Bandwidth	1 MHz	Lower	-22.10 dBm
	Spacing	8 MHz		
Alternate Channel	Bandwidth	1 MHz	Lower	-22.89 dBm
	Spacing	9 MHz		
2nd Alternate Channel	Bandwidth	1 MHz		
	Spacing	13.5 MHz		

Date: 5.SEP.2013 12:36:46



Higher Band Edge Plot for 16QAM -RB Size 1, RB Offset 74

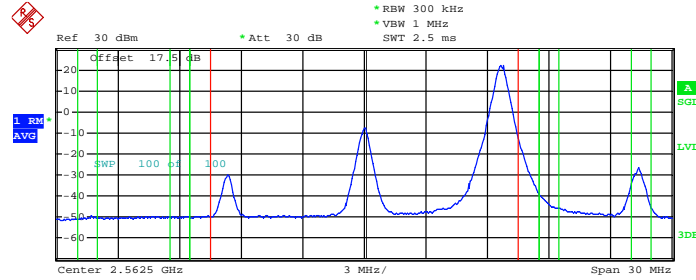

Tx Channel			
Bandwidth	15 MHz		
Adjacent Channel			
Bandwidth	1 MHz		
Spacing	8 MHz	Upper	-15.71 dBm
Alternate Channel			
Bandwidth	1 MHz		
Spacing	9 MHz	Upper	-38.35 dBm
2nd Alternate Channel			
Bandwidth	1 MHz		
Spacing	13.5 MHz		

Date: 5.SEP.2013 12:39:44

Higher Band Edge Plot for 16QAM-RB Size 75, RB Offset 0

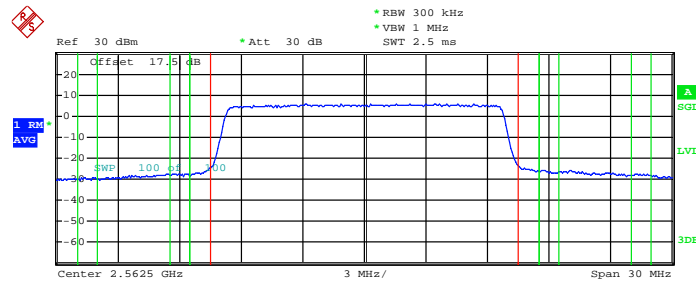

Tx Channel			
Bandwidth	15 MHz		
Adjacent Channel			
Bandwidth	1 MHz		
Spacing	8 MHz	Upper	-20.68 dBm
Alternate Channel			
Bandwidth	1 MHz		
Spacing	9 MHz	Upper	-22.04 dBm
2nd Alternate Channel			
Bandwidth	1 MHz		
Spacing	13.5 MHz		

Date: 5.SEP.2013 12:40:52



Band :	LTE Band 7	Band Width	20MHz / QPSK
---------------	------------	-------------------	--------------

Lower Band Edge Plot for QPSK-RB Size 1, RB Offset 0

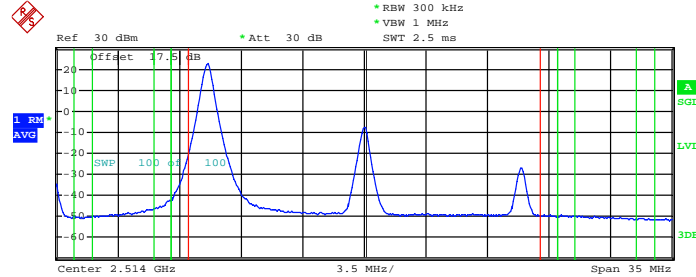

Tx Channel	Bandwidth	20 MHz		
Adjacent Channel	Bandwidth	1 MHz	Lower	-24.55 dBm
	Spacing	10.5 MHz		
Alternate Channel	Bandwidth	1 MHz	Lower	-40.11 dBm
	Spacing	11.5 MHz		
2nd Alternate Channel	Bandwidth	1 MHz		
	Spacing	16 MHz		

Date: 5.SEP.2013 12:43:42

Lower Band Edge Plot for QPSK-RB Size 100, RB Offset 0

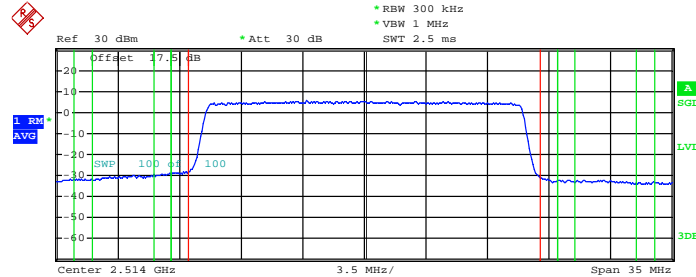

Tx Channel	Bandwidth	20 MHz		
Adjacent Channel	Bandwidth	1 MHz	Lower	-24.39 dBm
	Spacing	10.5 MHz		
Alternate Channel	Bandwidth	1 MHz	Lower	-25.13 dBm
	Spacing	11.5 MHz		
2nd Alternate Channel	Bandwidth	1 MHz		
	Spacing	16 MHz		

Date: 5.SEP.2013 12:43:22



Band :	LTE Band 7	Band Width	20MHz / 16QAM
---------------	------------	-------------------	---------------

Lower Band Edge Plot for 16QAM -RB Size 1, RB Offset 0

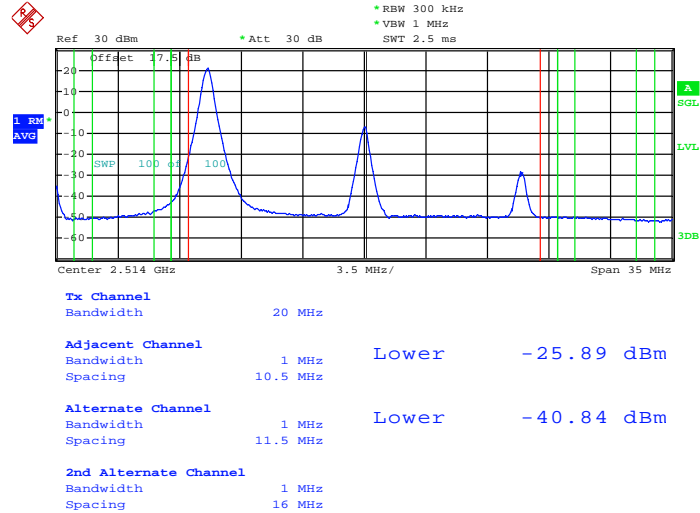

Date: 5.SEP.2013 12:44:06

Lower Band Edge Plot for 16QAM -RB Size 100, RB Offset 0

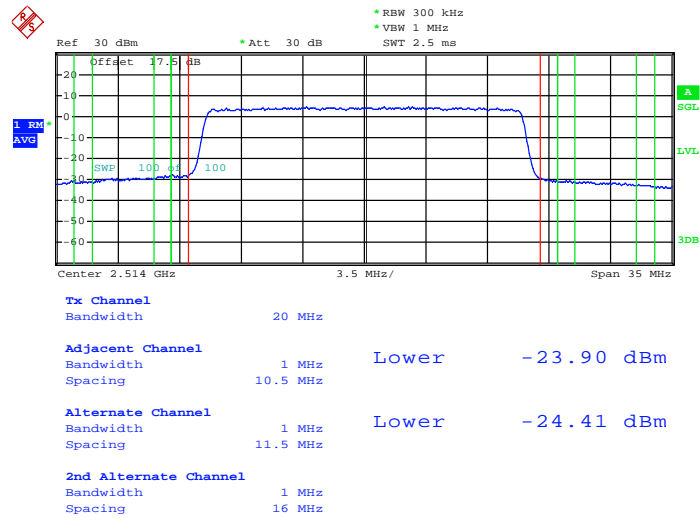

Date: 5.SEP.2013 12:43:04

3.3.6 Test Plots of Spurious Emission

Band :	LTE Band 7	Bandwidth :	5MHz / QPSK
Frequency :	2506.5	Channel :	20815

Conducted Emission Plot (30MHz ~ 1GHz) for QPSK (RB Size 1, RB Offset 24)

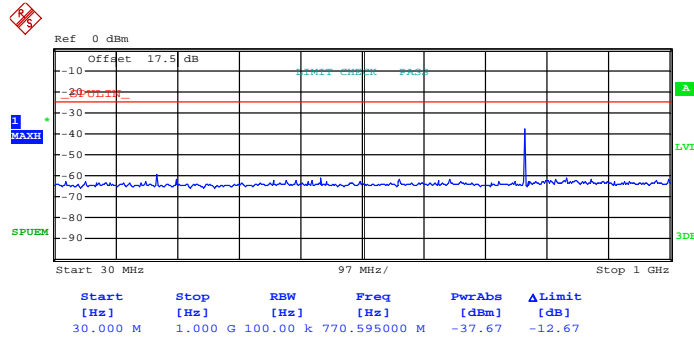

Date: 4.SEP.2013 18:20:09

Conducted Emission Plot (1GHz ~ 30GHz) for QPSK (RB Size 1, RB Offset 24)

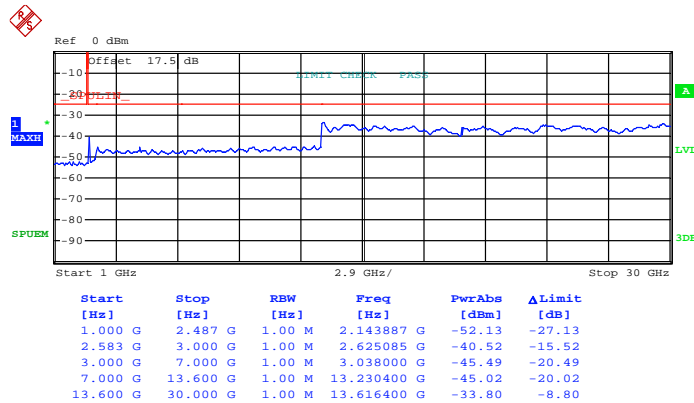

Date: 4.SEP.2013 18:27:33



Band :	LTE Band 7	Bandwidth :	5MHz / QPSK
Frequency :	2534.5	Channel :	21095

Conducted Emission Plot (30MHz ~ 1GHz) for QPSK (RB Size 1, RB Offset 0)

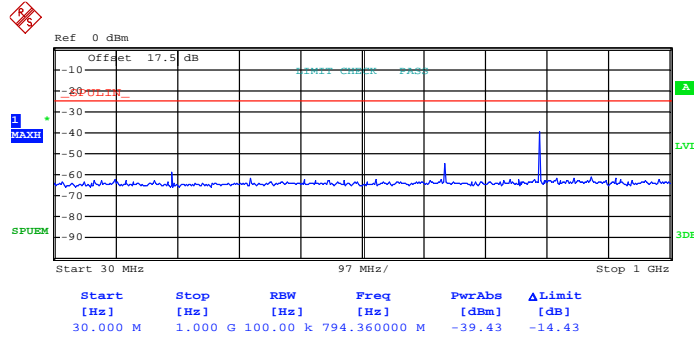

Date: 4.SEP.2013 18:31:27

Conducted Emission Plot (1GHz ~ 30GHz) for QPSK (RB Size 1, RB Offset 0)

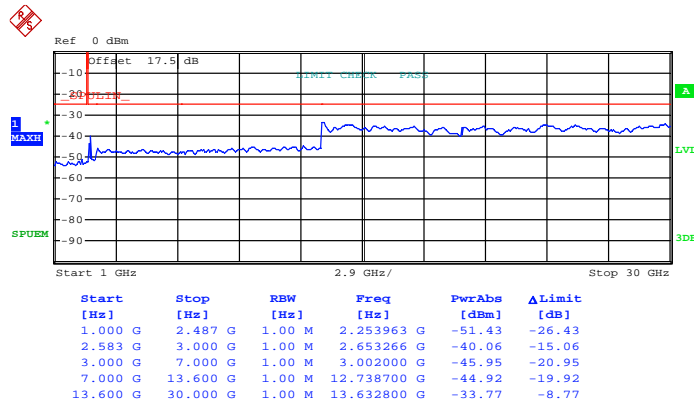

Date: 4.SEP.2013 18:29:57



Band :	LTE Band 7	Bandwidth :	5MHz / QPSK
Frequency :	2567.5	Channel :	21425

Conducted Emission Plot (30MHz ~ 1GHz) for QPSK (RB Size 1, RB Offset 24)

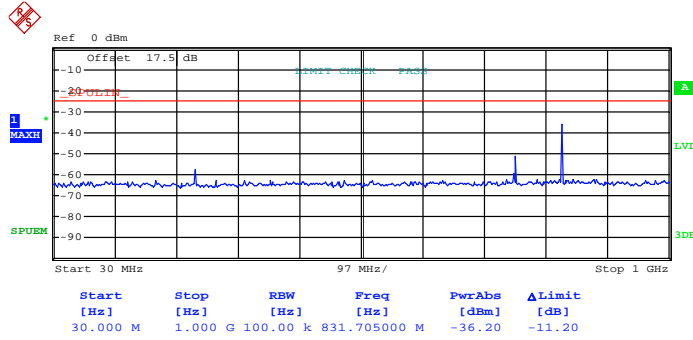

Date: 4.SEP.2013 18:32:25

Conducted Emission Plot (1GHz ~ 30GHz) for QPSK (RB Size 1, RB Offset 24)

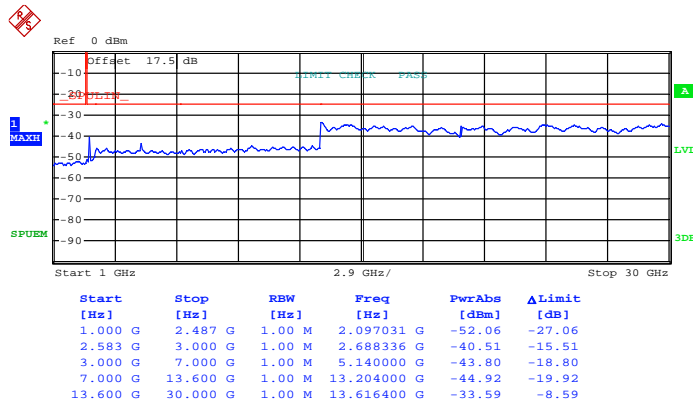

Date: 4.SEP.2013 18:35:20



Band :	LTE Band 7	Bandwidth :	5MHz / 16QAM
Frequency :	2506.5	Channel :	20815

Conducted Emission Plot (30MHz ~ 1GHz) for 16-QAM (RB Size 1, RB Offset 24)

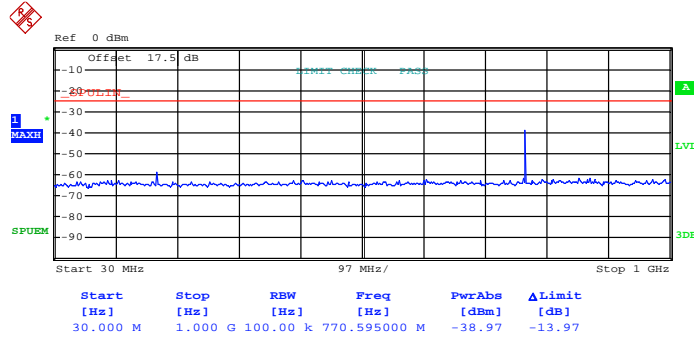

Date: 4.SEP.2013 18:20:39

Conducted Emission Plot (1GHz ~ 30GHz) for 16-QAM (RB Size 1, RB Offset 24)

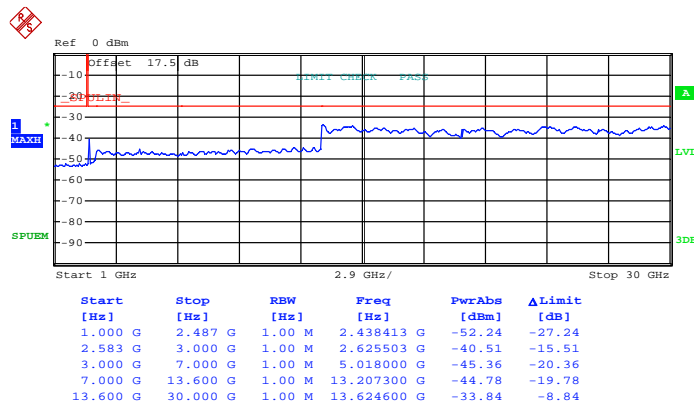

Date: 4.SEP.2013 18:27:03



Band :	LTE Band 7	Bandwidth :	5MHz / 16QAM
Frequency :	2534.5	Channel :	21095

Conducted Emission Plot (30MHz ~ 1GHz) for 16-QAM (RB Size 1, RB Offset 0)

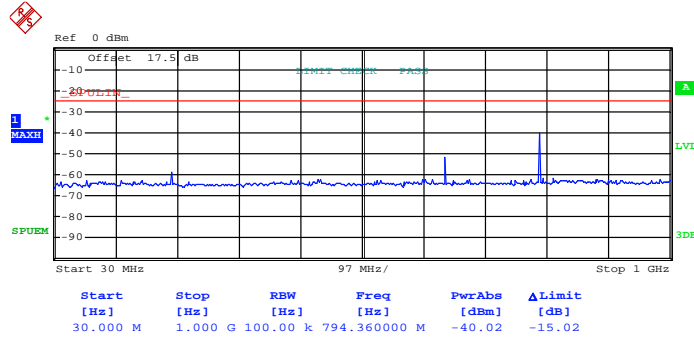

Date: 4.SEP.2013 18:30:59

Conducted Emission Plot (1GHz ~ 30GHz) for 16-QAM (RB Size 1, RB Offset 0)

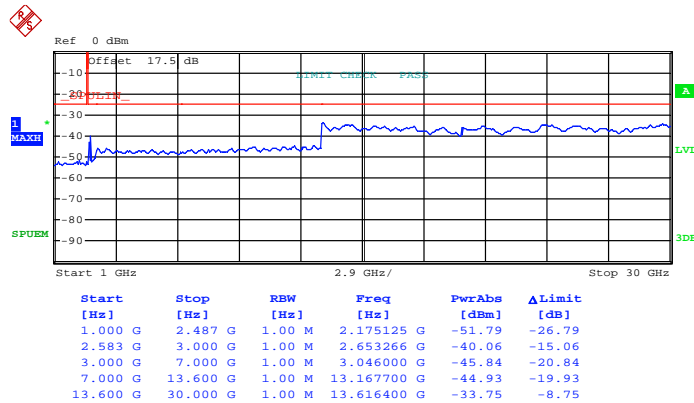

Date: 4.SEP.2013 18:30:27



Band :	LTE Band 7	Bandwidth :	5MHz / 16QAM
Frequency :	2567.5	Channel :	21425

Conducted Emission Plot (30MHz ~ 1GHz) for 16-QAM (RB Size 1, RB Offset 12)

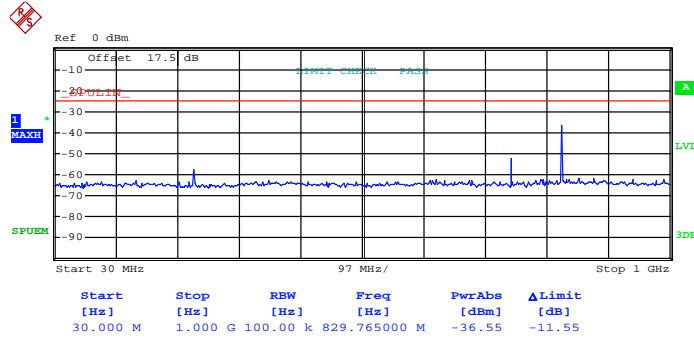

Date: 4.SEP.2013 18:33:11

Conducted Emission Plot (1GHz ~ 30GHz) for 16-QAM (RB Size 1, RB Offset 12)

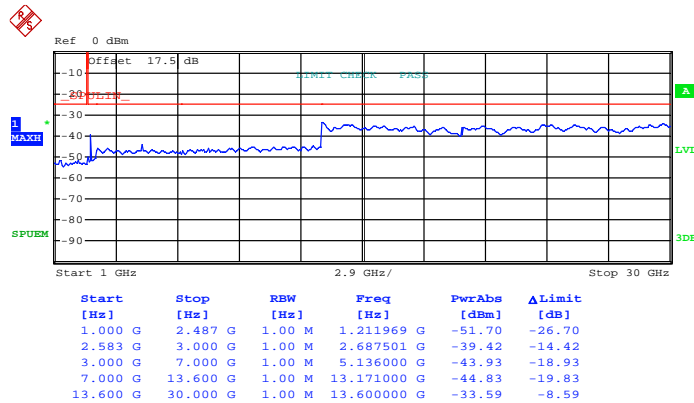

Date: 4.SEP.2013 18:34:47



Band :	LTE Band 7	Bandwidth:	10MHz / QPSK
Frequency :	2509	Channel :	20840

Conducted Emission Plot (30MHz ~ 1GHz) for QPSK (RB Size 1, RB Offset 49)

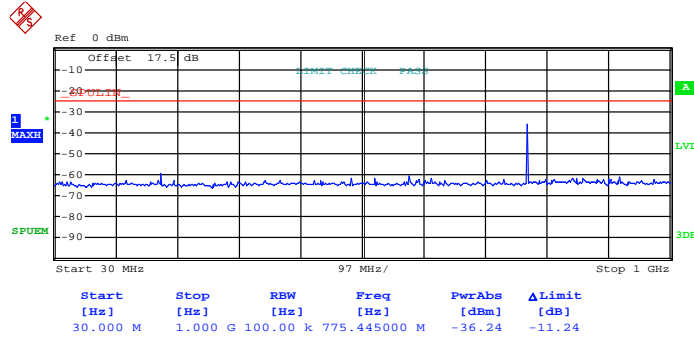

Date: 4.SEP.2013 18:41:13

Conducted Emission Plot (1GHz ~ 30GHz) for QPSK (RB Size 1, RB Offset 49)

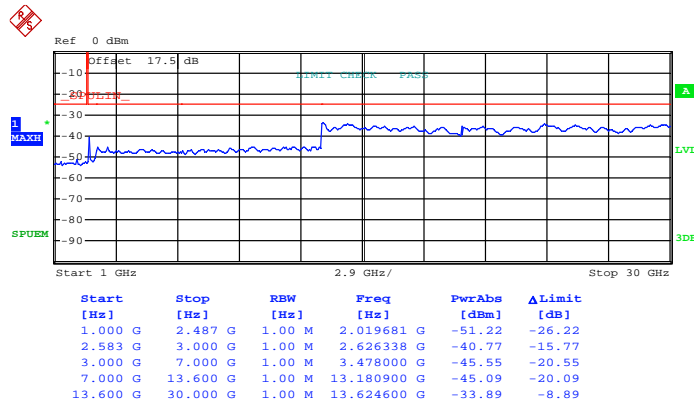

Date: 4.SEP.2013 18:44:41



Band :	LTE Band 7	Bandwidth:	10MHz / QPSK
Frequency :	2532	Channel :	21070

Conducted Emission Plot (30MHz ~ 1GHz) for QPSK (RB Size 1, RB Offset 0)

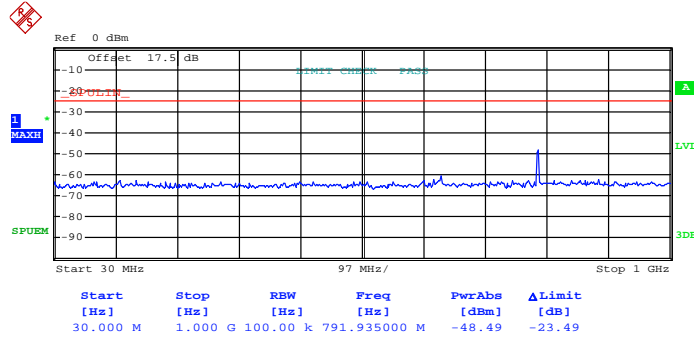

Date: 4.SEP.2013 20:14:24

Conducted Emission Plot (1GHz ~ 30GHz) for QPSK (RB Size 1, RB Offset 0)

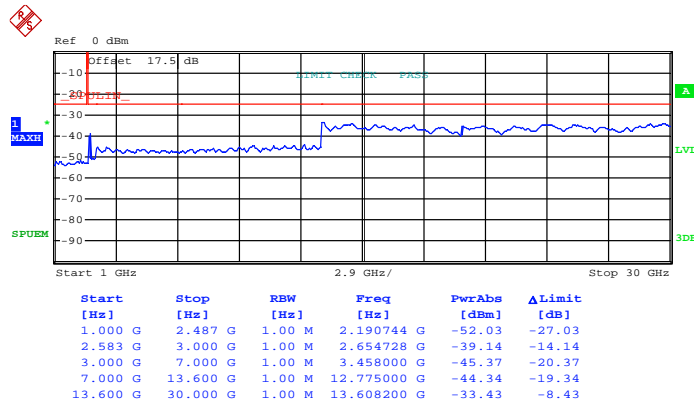

Date: 4.SEP.2013 20:18:45



Band :	LTE Band 7	Bandwidth:	10MHz / QPSK
Frequency :	2565	Channel :	21400

Conducted Emission Plot (30MHz ~ 1GHz) for QPSK (RB Size 1, RB Offset 49)

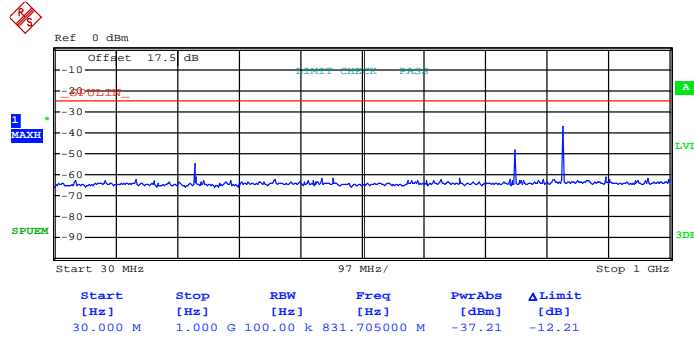

Date: 4.SEP.2013 18:40:15

Conducted Emission Plot (1GHz ~ 30GHz) for QPSK (RB Size 1, RB Offset 49)

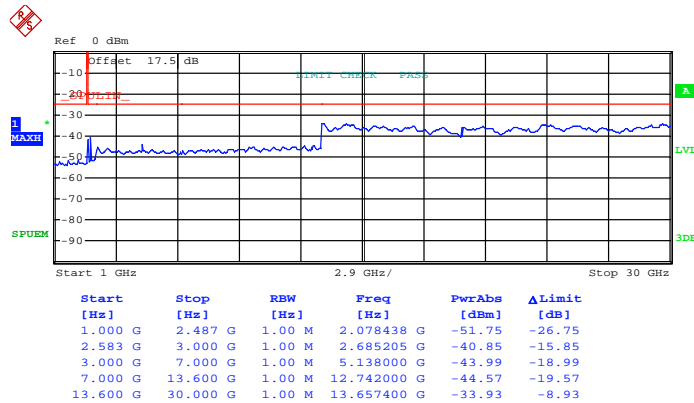

Date: 4.SEP.2013 18:37:25



Band :	LTE Band 7	Bandwidth:	10MHz / 16QAM
Frequency :	2509	Channel :	20840

Conducted Emission Plot (30MHz ~ 1GHz) for 16-QAM (RB Size 1, RB Offset 49)

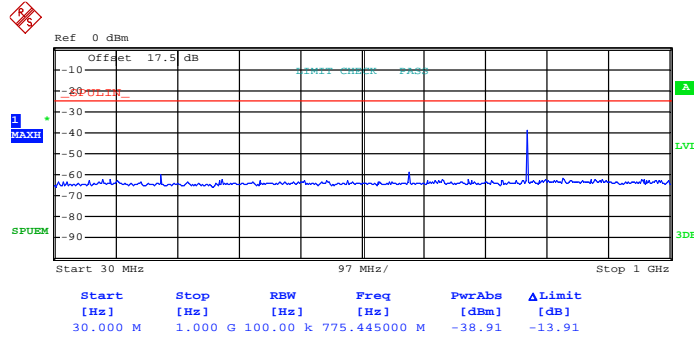

Date: 4.SEP.2013 18:41:56

Conducted Emission Plot (1GHz ~ 30GHz) for 16-QAM (RB Size 1, RB Offset 49)

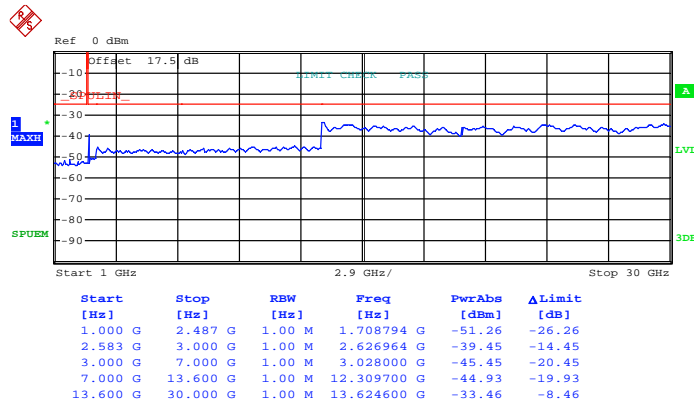

Date: 4.SEP.2013 18:44:12



Band :	LTE Band 7	Bandwidth:	10MHz / 16QAM
Frequency :	2532	Channel :	21070

Conducted Emission Plot (30MHz ~ 1GHz) for 16-QAM (RB Size 1, RB Offset 0)

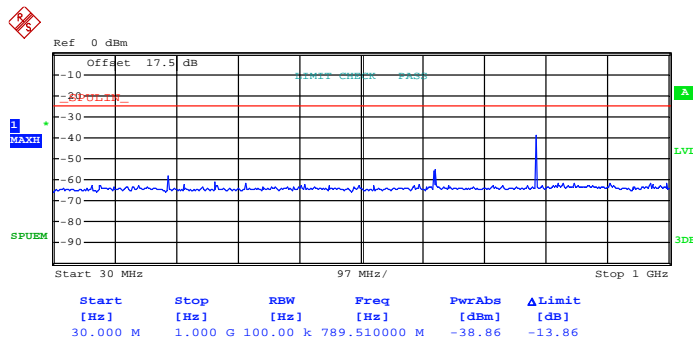

Date: 4.SEP.2013 20:52:51

Conducted Emission Plot (1GHz ~ 30GHz) for 16-QAM (RB Size 1, RB Offset 0)

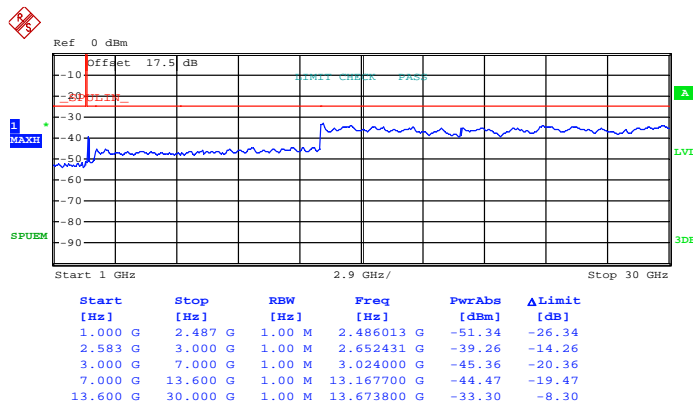

Date: 4.SEP.2013 20:56:08



Band :	LTE Band 7	Bandwidth:	10MHz / 16QAM
Frequency :	2565	Channel :	21400

Conducted Emission Plot (30MHz ~ 1GHz) for 16-QAM (RB Size 1, RB Offset 49)

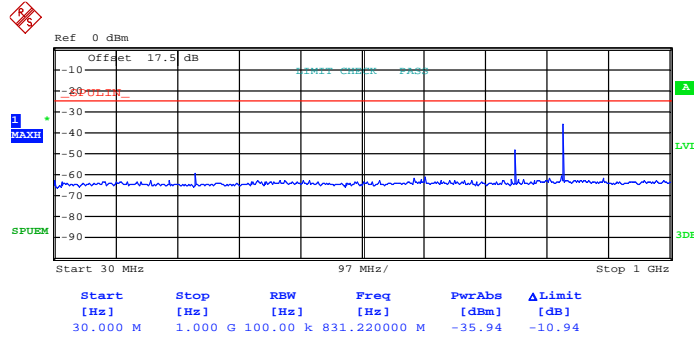

Date: 4.SEP.2013 18:39:50

Conducted Emission Plot (1GHz ~ 30GHz) for 16-QAM (RB Size 1, RB Offset 49)

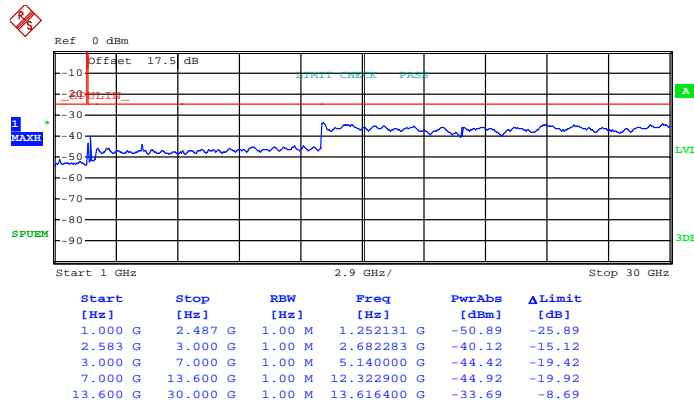

Date: 4.SEP.2013 18:37:54

Band :	LTE Band 7	Bandwidth:	15MHz / QPSK
Frequency :	2511.5	Channel :	20865

Conducted Emission Plot (30MHz ~ 1GHz) for QPSK (RB Size 1, RB Offset 37)

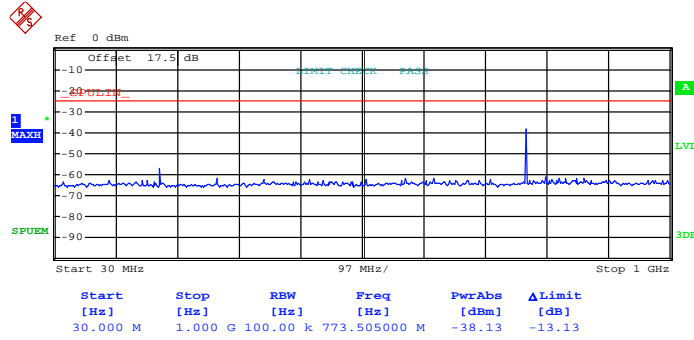

Date: 4.SEP.2013 21:17:04

Conducted Emission Plot (1GHz ~ 30GHz) for QPSK (RB Size 1, RB Offset 37)

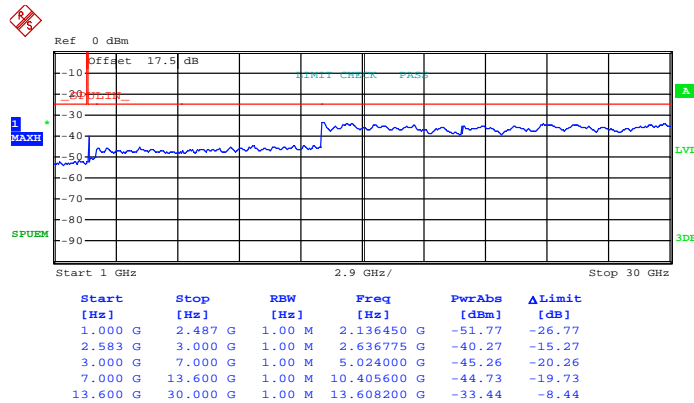

Date: 4.SEP.2013 21:18:19



Band :	LTE Band 7	Bandwidth:	15MHz / QPSK
Frequency :	2529.5	Channel :	21045

Conducted Emission Plot (30MHz ~ 1GHz) for QPSK (RB Size 1, RB Offset 0)

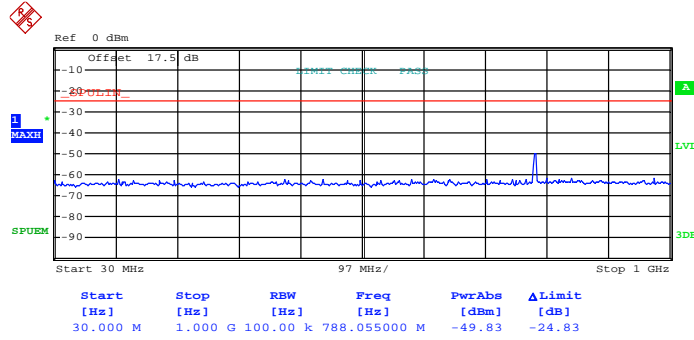

Date: 4.SEP.2013 21:07:11

Conducted Emission Plot (1GHz ~ 30GHz) for QPSK (RB Size 1, RB Offset 0)

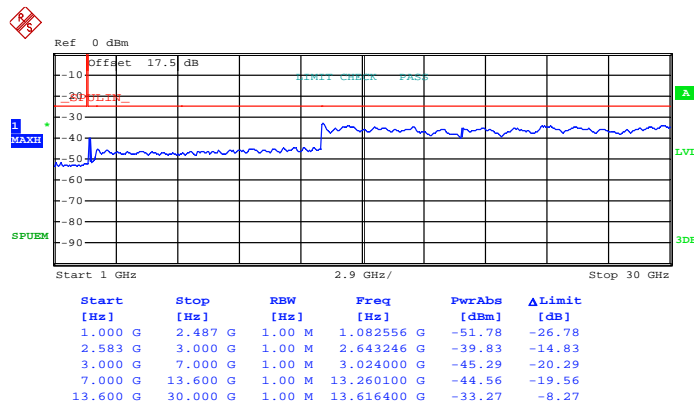

Date: 4.SEP.2013 21:08:22



Band :	LTE Band 7	Bandwidth:	15MHz / QPSK
Frequency :	2562.5	Channel :	21375

Conducted Emission Plot (30MHz ~ 1GHz) for QPSK (RB Size 1, RB Offset 74)

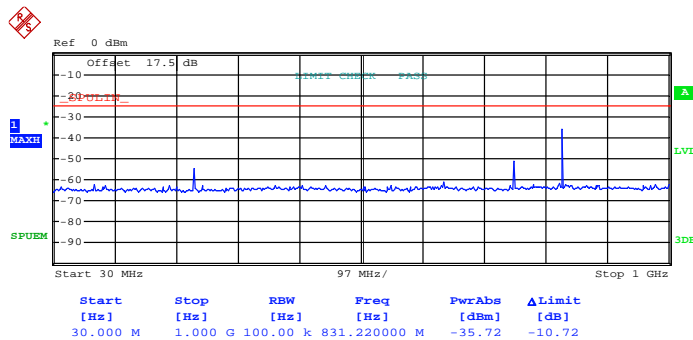

Date: 4.SEP.2013 21:23:46

Conducted Emission Plot (1GHz ~ 30GHz) for QPSK (RB Size 1, RB Offset 74)

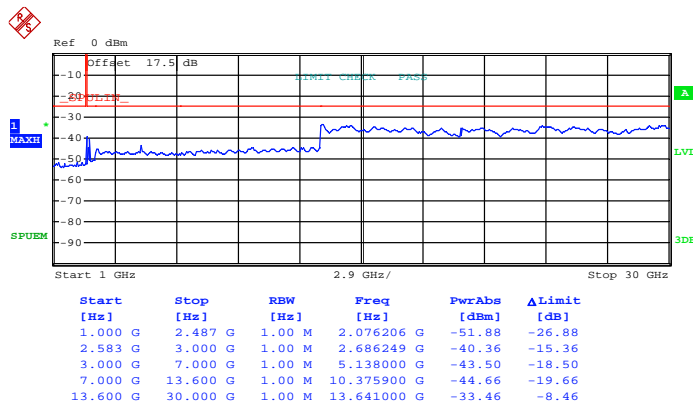

Date: 4.SEP.2013 21:25:36



Band :	LTE Band 7	Bandwidth:	15MHz / 16QAM
Frequency :	2511.5	Channel :	20865

**Conducted Emission Plot (30MHz ~ 1GHz) for
16-QAM (RB Size 1, RB Offset 37)**

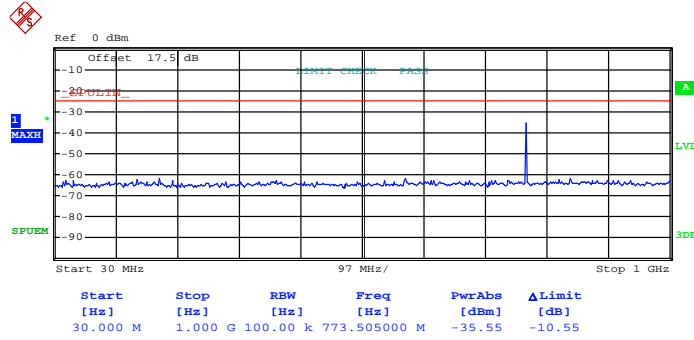

Date: 4.SEP.2013 21:20:50

**Conducted Emission Plot (1GHz ~ 30GHz) for
16-QAM (RB Size 1, RB Offset 37)**

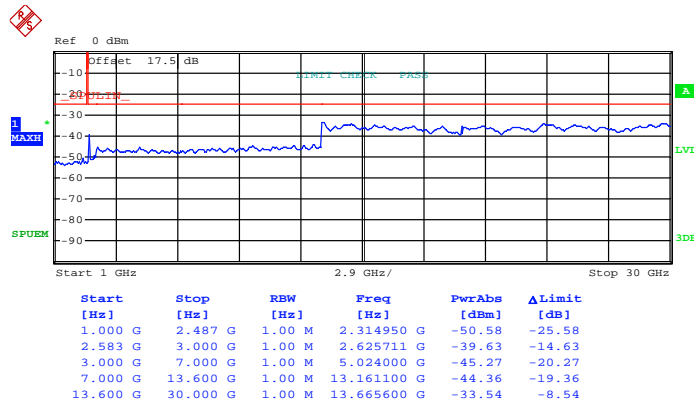

Date: 4.SEP.2013 21:19:31



Band :	LTE Band 7	Bandwidth:	15MHz / 16QAM
Frequency :	2529.5	Channel :	21045

Conducted Emission Plot (30MHz ~ 1GHz) for 16-QAM (RB Size 1, RB Offset 0)

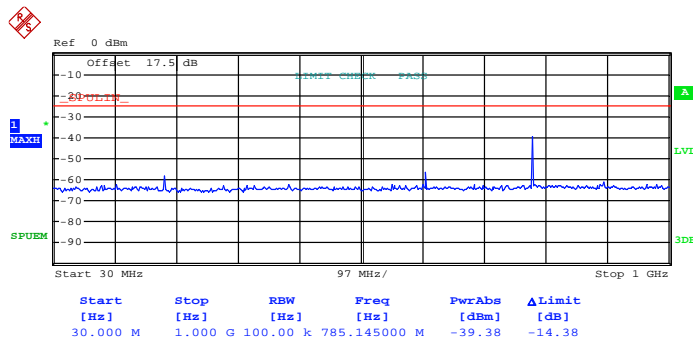

Date: 4.SEP.2013 21:12:28

Conducted Emission Plot (1GHz ~ 30GHz) for 16-QAM (RB Size 1, RB Offset 0)

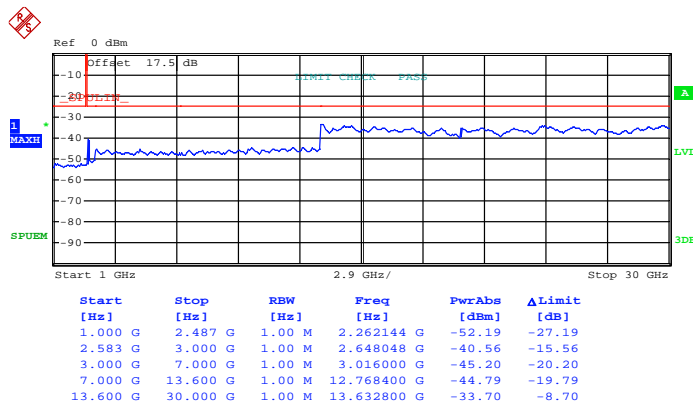

Date: 4.SEP.2013 21:11:06



Band :	LTE Band 7	Bandwidth:	15MHz / 16QAM
Frequency :	2562.5	Channel :	21375

**Conducted Emission Plot (30MHz ~ 1GHz) for
16-QAM (RB Size 1, RB Offset 74)**

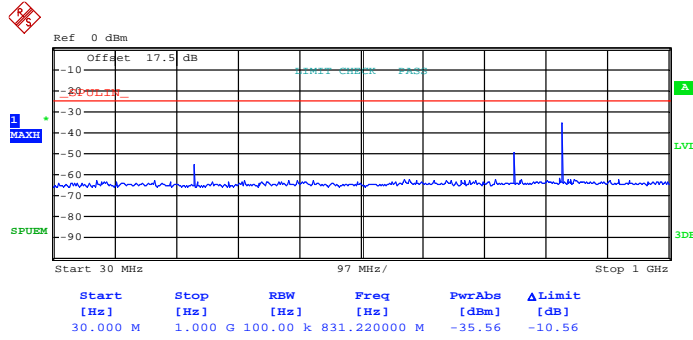

Date: 4.SEP.2013 21:28:48

**Conducted Emission Plot (1GHz ~ 30GHz) for
16-QAM (RB Size 1, RB Offset 74)**

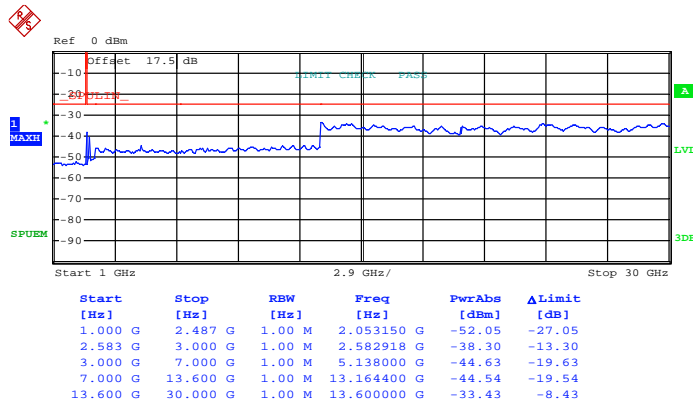

Date: 4.SEP.2013 21:27:06



Band :	LTE Band 7	Bandwidth:	20MHz / QPSK
Frequency :	2514	Channel :	20890

Conducted Emission Plot (30MHz ~ 1GHz) for QPSK (RB Size 1, RB Offset 49)

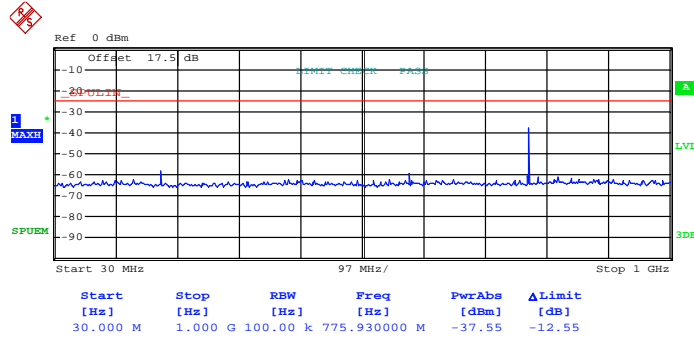

Date: 4.SEP.2013 21:32:10

Conducted Emission Plot (1GHz ~ 30GHz) for QPSK (RB Size 1, RB Offset 49)

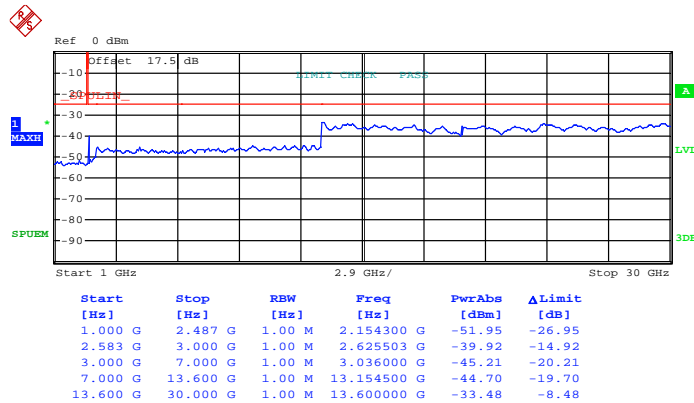

Date: 4.SEP.2013 21:33:02



Band :	LTE Band 7	Bandwidth:	20MHz / QPSK
Frequency :	2527	Channel :	21020

Conducted Emission Plot (30MHz ~ 1GHz) for QPSK (RB Size 1, RB Offset 0)

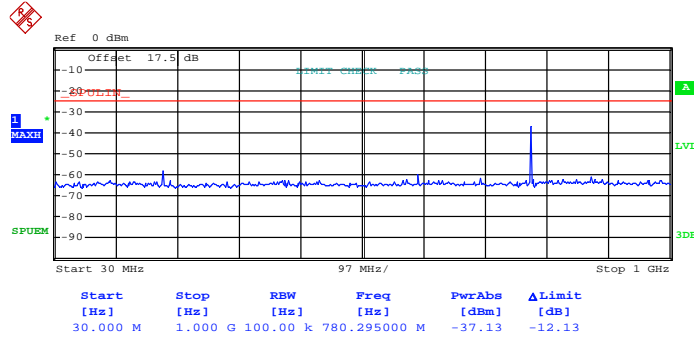

Date: 4.SEP.2013 21:38:53

Conducted Emission Plot (1GHz ~ 30GHz) for QPSK (RB Size 1, RB Offset 0)

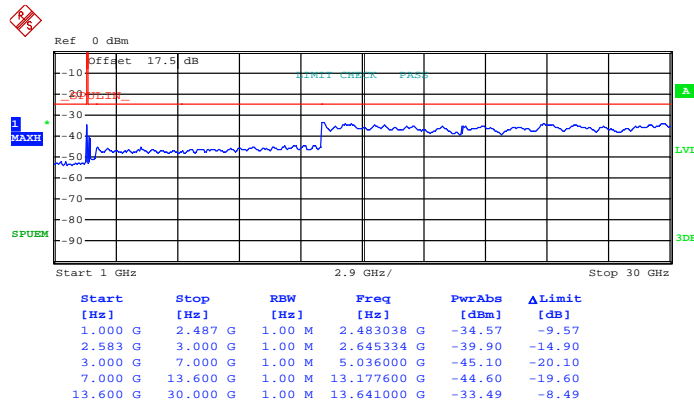

Date: 4.SEP.2013 21:39:52



Band :	LTE Band 7	Bandwidth:	20MHz / 16QAM
Frequency :	2514	Channel :	20890

Conducted Emission Plot (30MHz ~ 1GHz) for QPSK (RB Size 1, RB Offset 49)

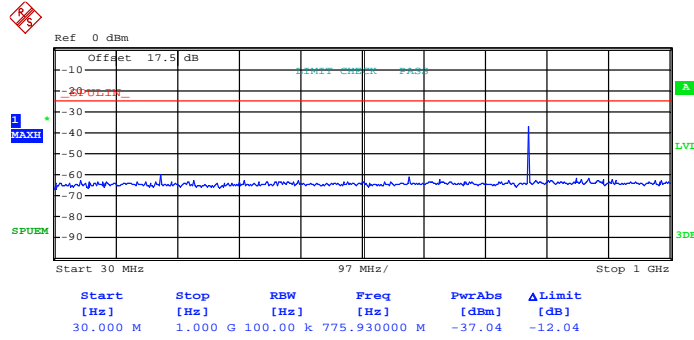

Date: 4.SEP.2013 21:35:13

Conducted Emission Plot (1GHz ~ 30GHz) for QPSK (RB Size 1, RB Offset 49)

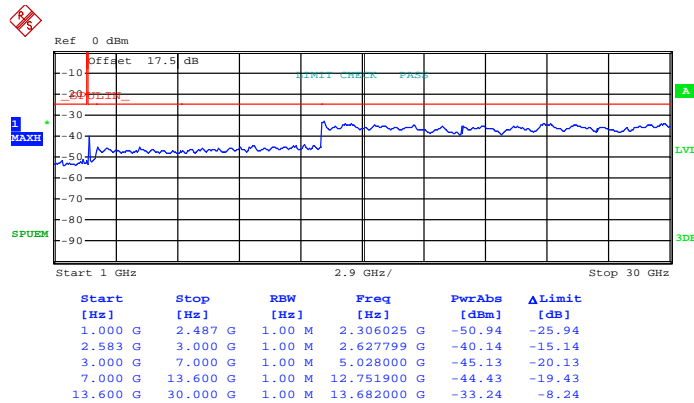

Date: 4.SEP.2013 21:34:32



Band :	LTE Band 7	Bandwidth:	20MHz / 16QAM
Frequency :	2527	Channel :	21020

Conducted Emission Plot (30MHz ~ 1GHz) for 16-QAM (RB Size 1, RB Offset 0)

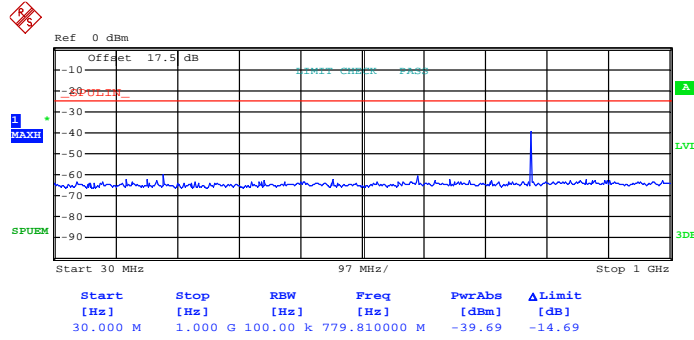

Date: 4.SEP.2013 21:55:59

Conducted Emission Plot (1GHz ~ 30GHz) for 16-QAM (RB Size 1, RB Offset 0)

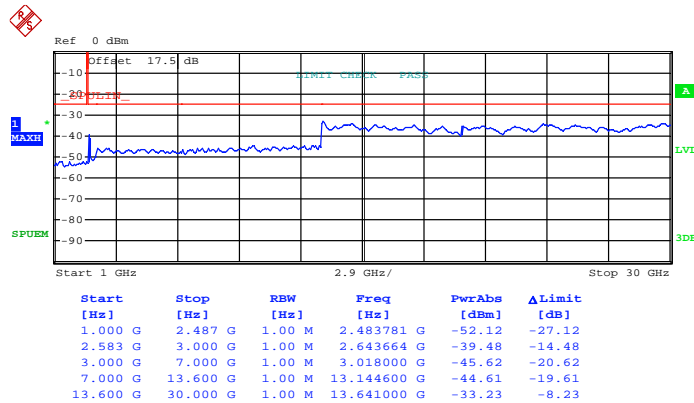

Date: 4.SEP.2013 21:52:48

3.4 Radiated Emissions Measurement

3.4.1 Description of Radiated Emissions Measurement

The power of any emission outside of the authorized operating frequency ranges must be lower than the transmitter power (P) by a factor of mobile digital stations, the attenuation factor shall be not less than $55 + 10 \log (P)$ dB at 5.5 MHz from the channel edges. It is measured by means of a calibrated spectrum analyzer and scanned from 30 MHz up to a frequency including its 10th harmonic.

3.4.2 Measuring Instruments

See list of measuring instruments of this test report.

3.4.3 Test Procedures

1. The EUT was placed on a rotatable wooden table with 0.8 meter above ground.
2. The EUT was set 3 meters from the receiving antenna, which was mounted on the antenna tower.
3. The table was rotated 360 degrees to determine the position of the highest spurious emission.
4. The height of the receiving antenna is varied between one meter and four meters to search the maximum spurious emission for both horizontal and vertical polarizations.
5. Make the measurement with the spectrum analyzer's RBW = 1MHz, VBW = 1MHz, Sweep = 500ms, Taking the record of maximum spurious emission.
6. A horn antenna was substituted in place of the EUT and was driven by a signal generator.
7. Tune the output power of signal generator to the same emission level with EUT maximum spurious emission.
8. Taking the record of output power at antenna port.
9. Repeat step 7 to step 8 for another polarization.
10. Emission level (dBm) = output power + substitution Gain.

3.4.4 Test Setup

For radiated emissions from 30MHz to 1GHz

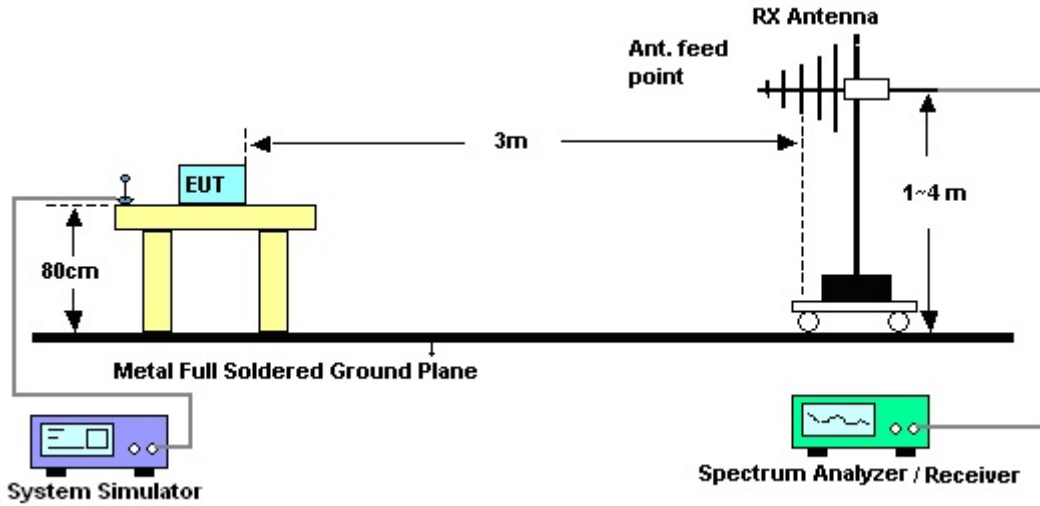

For radiated emissions above 1GHz

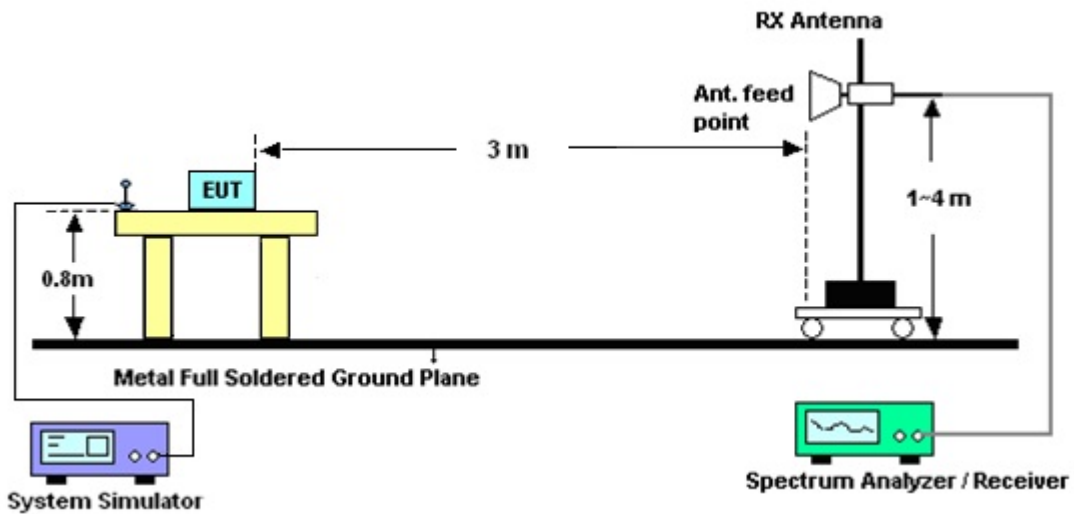



3.4.5 Test Result of Radiated Emissions

Band :	LTE Band 7	Temperature :	23~25°C
Test Mode :	5MHz, QPSK RB Size 1, RB Offset 24	Relative Humidity :	49~52%
Test Engineer :	Gavin Zhang	Polarization :	Horizontal
Remark :	Spurious emissions within 30-1000MHz were found more than 20dB below limit line.		

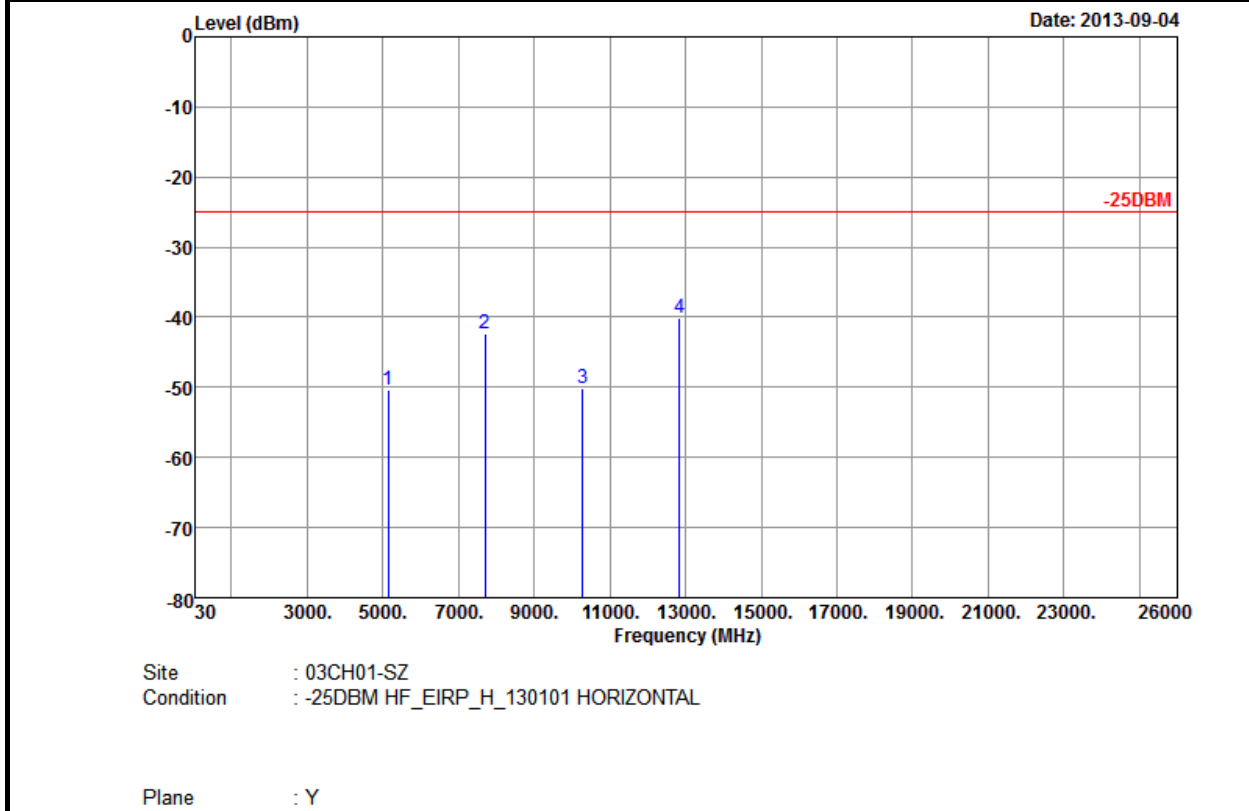

Frequency (MHz)	EIRP (dBm)	Limit (dBm)	Over Limit (dB)	SPA Reading (dBm)	S.G. Power (dBm)	TX Cable loss (dB)	TX Antenna Gain (dBi)	Polarization (H/V)	Result
5140.00	-50.33	-25	-25.33	-61.41	-38.20	1.15	7.54	H	Pass
7708.00	-42.27	-25	-17.27	-61.30	-68.60	1.51	9.80	H	Pass
10280.00	-50.09	-25	-25.09	-73.71	-67.90	1.75	11.51	H	Pass
12848.00	-40.08	-25	-15.08	-66.34	-58.70	1.97	12.86	H	Pass



Band :	LTE Band 7	Temperature :	23~25°C
Test Mode :	5MHz, QPSK RB Size 1, RB Offset 24	Relative Humidity :	49~52%
Test Engineer :	Gavin Zhang	Polarization :	Vertical
Remark :	Spurious emissions within 30-1000MHz were found more than 20dB below limit line.		

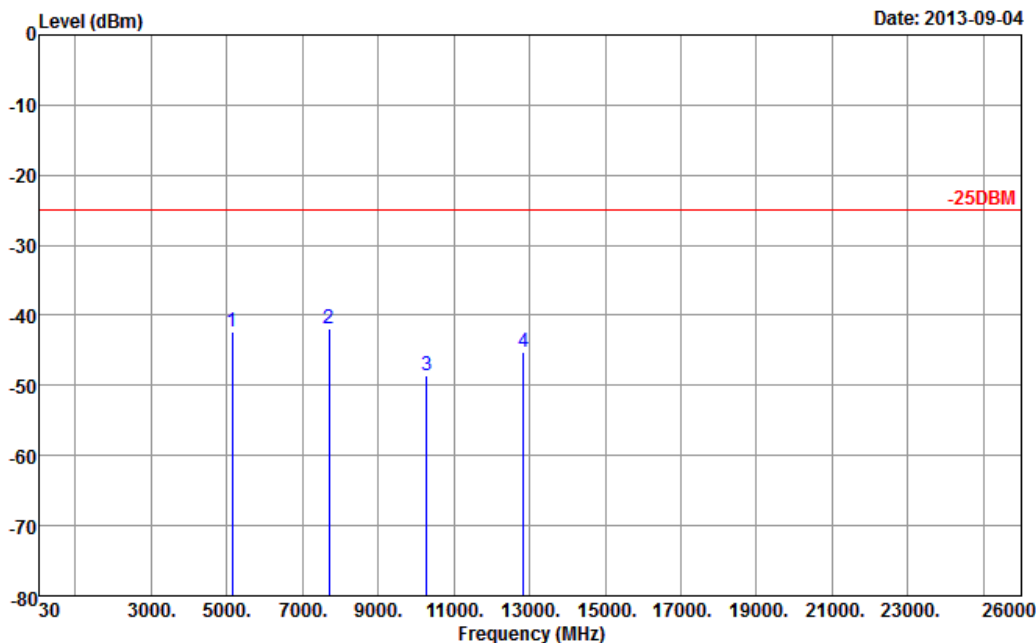

Site : 03CH01-SZ
 Condition : -25DBM HF_EIRP_V_130101 VERTICAL

Plane : Y

Frequency (MHz)	EIRP (dBm)	Limit (dBm)	Over Limit (dB)	SPA Reading (dBm)	S.G. Power (dBm)	TX Cable loss (dB)	TX Antenna Gain (dBi)	Polarization (H/V)	Result
5140	-42.33	-25	-17.33	-57.14	-43.20	1.15	7.54	V	Pass
7708	-41.88	-25	-16.88	-61.28	-70.30	1.51	9.80	V	Pass
10280	-48.67	-25	-23.67	-72	-64.60	1.75	11.51	V	Pass
12848	-45.14	-25	-20.14	-71.04	-56.60	1.97	12.86	V	Pass



Band :	LTE Band 7	Temperature :	23~25°C
Test Mode :	10MHz, QPSK, RB Size 1, RB Offset 49	Relative Humidity :	49~52%
Test Engineer :	Gavin Zhang	Polarization :	Horizontal
Remark :	Spurious emissions within 30-1000MHz were found more than 20dB below limit line.		

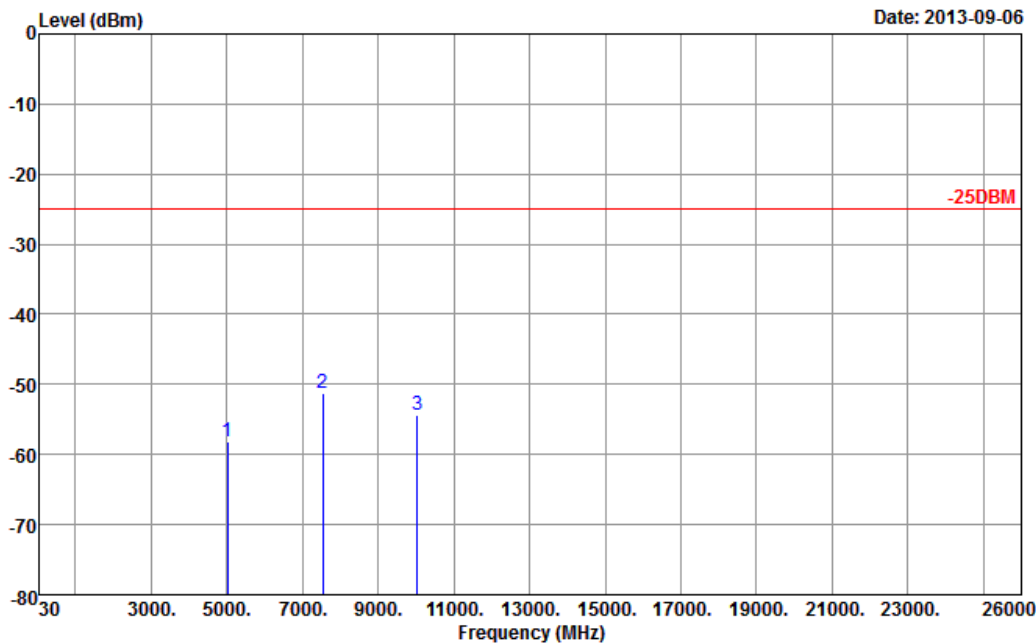

Site : 03CH01-SZ
 Condition : -25DBM HF_EIRP_H_130101 HORIZONTAL

Plane : Y

Frequency (MHz)	EIRP (dBm)	Limit (dBm)	Over Limit (dB)	SPA Reading (dBm)	S.G. Power (dBm)	TX Cable loss (dB)	TX Antenna Gain (dBi)	Polarization (H/V)	Result
5020.00	-58.18	-25	-33.18	-69.26	-38.20	1.15	7.54	H	Pass
7528.00	-51.26	-25	-26.26	-70.22	-68.60	1.51	9.80	H	Pass
10040.00	-54.36	-25	-29.36	-77.98	-67.90	1.75	11.51	H	Pass



Band :	LTE Band 7	Temperature :	23~25°C
Test Mode :	10MHz, QPSK, RB Size 1, RB Offset 49	Relative Humidity :	49~52%
Test Engineer :	Gavin Zhang	Polarization :	Vertical
Remark :	Spurious emissions within 30-1000MHz were found more than 20dB below limit line.		

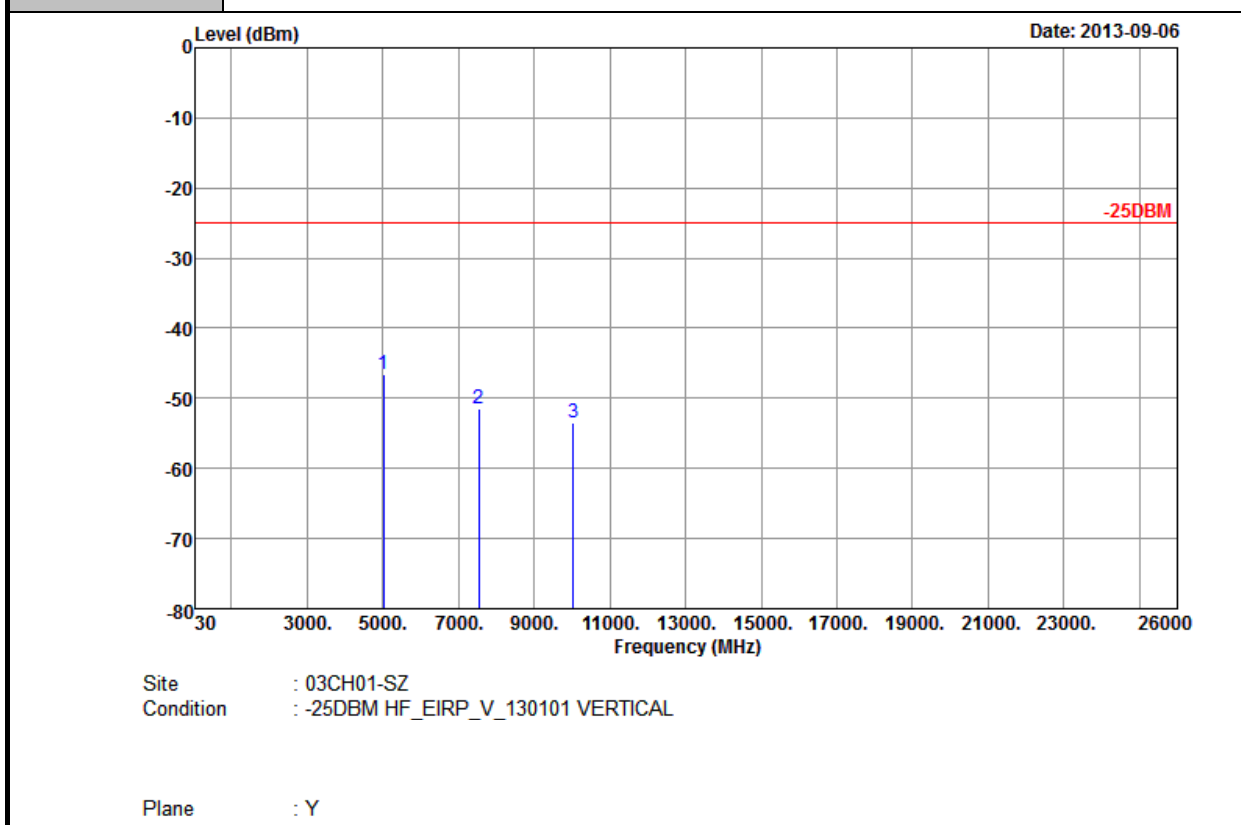

Frequency (MHz)	EIRP (dBm)	Limit (dBm)	Over Limit (dB)	SPA Reading (dBm)	S.G. Power (dBm)	TX Cable loss (dB)	TX Antenna Gain (dBi)	Polarization (H/V)	Result
5020.00	-46.57	-25	-21.57	-65.32	-43.20	1.15	7.54	V	Pass
7528.00	-51.40	-25	-26.40	-70.8	-70.30	1.51	9.80	V	Pass
10040.00	-53.47	-25	-28.47	-76.8	-64.60	1.75	11.51	V	Pass



Band :	LTE Band 7	Temperature :	23~25°C
Test Mode :	15MHz, QPSK, RB Size 1, RB Offset 37	Relative Humidity :	49~52%
Test Engineer :	Gavin Zhang	Polarization :	Horizontal
Remark :	Spurious emissions within 30-1000MHz were found more than 20dB below limit line.		

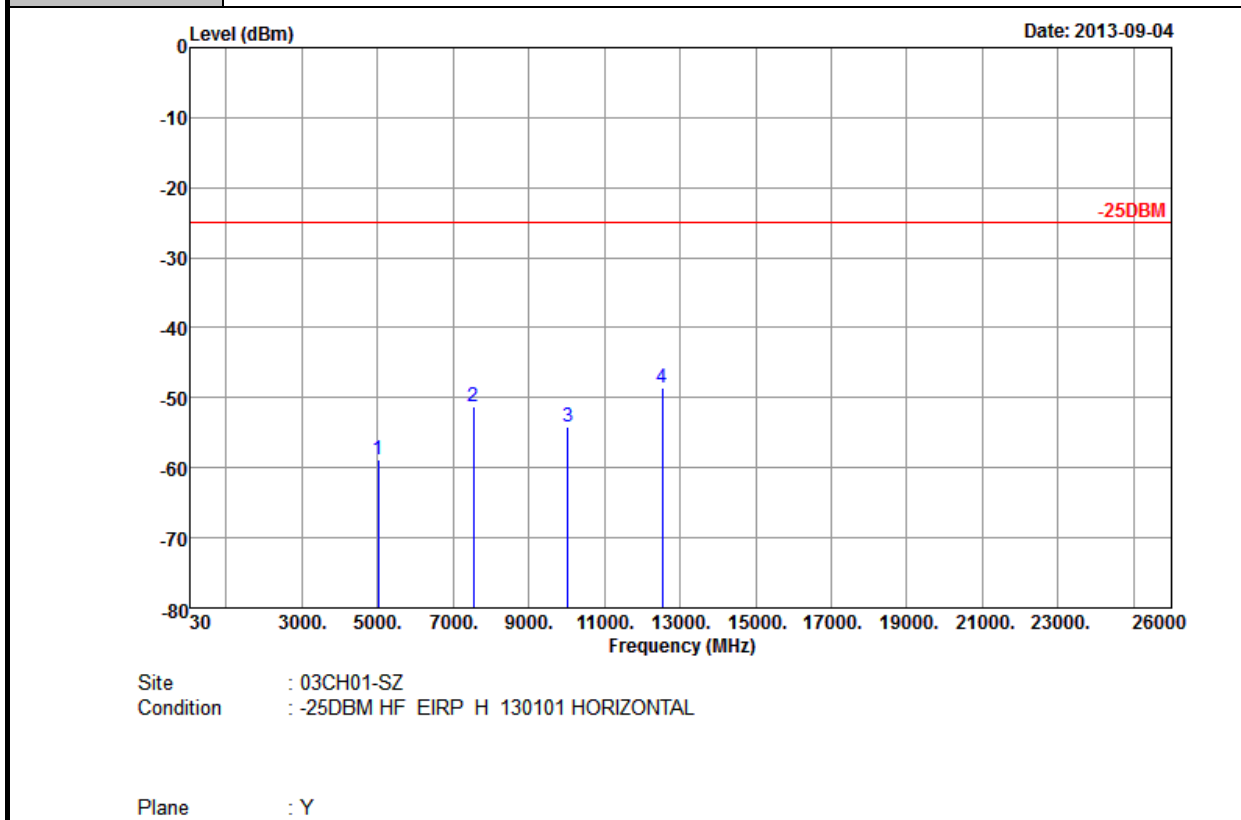

Frequency (MHz)	EIRP (dBm)	Limit (dBm)	Over Limit (dB)	SPA Reading (dBm)	S.G. Power (dBm)	TX Cable loss (dB)	TX Antenna Gain (dBi)	Polarization (H/V)	Result
5016.00	-58.76	-25	-33.76	-69.84	-38.20	1.15	7.54	H	Pass
7524.00	-51.22	-25	-26.22	-70.18	-68.60	1.51	9.80	H	Pass
10032.00	-54.10	-25	-29.10	-77.72	-67.90	1.75	11.51	H	Pass
12536.00	-48.69	-25	-23.69	-74.95	-58.70	1.97	12.86	H	Pass



Band :	LTE Band 7	Temperature :	23~25°C
Test Mode :	15MHz, QPSK, RB Size 1, RB Offset 37	Relative Humidity :	49~52%
Test Engineer :	Gavin Zhang	Polarization :	Vertical
Remark :	Spurious emissions within 30-1000MHz were found more than 20dB below limit line.		

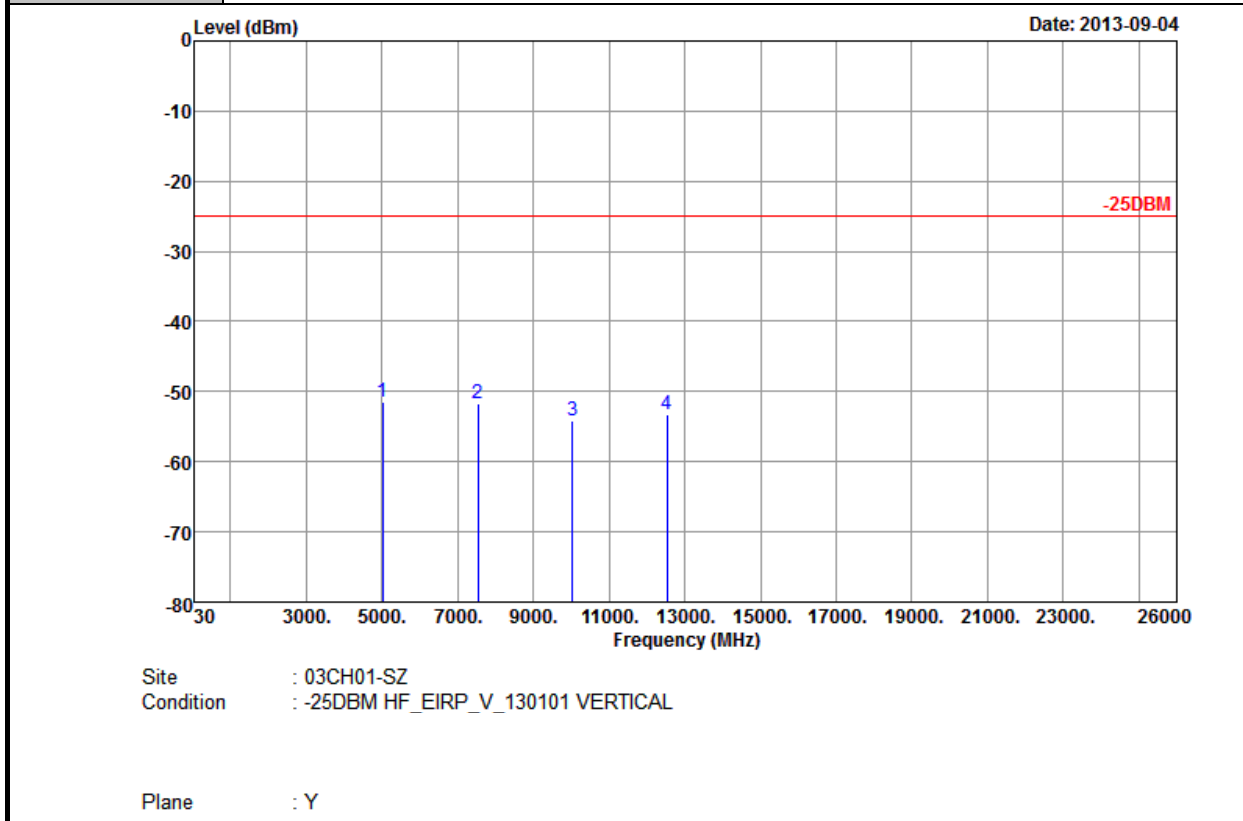

Frequency (MHz)	EIRP (dBm)	Limit (dBm)	Over Limit (dB)	SPA Reading (dBm)	S.G. Power (dBm)	TX Cable loss (dB)	TX Antenna Gain (dBi)	Polarization (H/V)	Result
5016	-51.46	-25	-26.46	-64.32	-43.20	1.15	7.54	V	Pass
7524	-51.71	-25	-26.71	-71.11	-70.30	1.51	9.80	V	Pass
10032	-54.18	-25	-29.18	-77.51	-64.60	1.75	11.51	V	Pass
12536	-53.17	-25	-28.17	-79.07	-56.60	1.97	12.86	V	Pass



Band :	LTE Band 7	Temperature :	23~25°C
Test Mode :	20MHz, QPSK, RB Size 1, RB Offset 49	Relative Humidity :	49~52%
Test Engineer :	Gavin Zhang	Polarization :	Horizontal
Remark :	Spurious emissions within 30-1000MHz were found more than 20dB below limit line.		

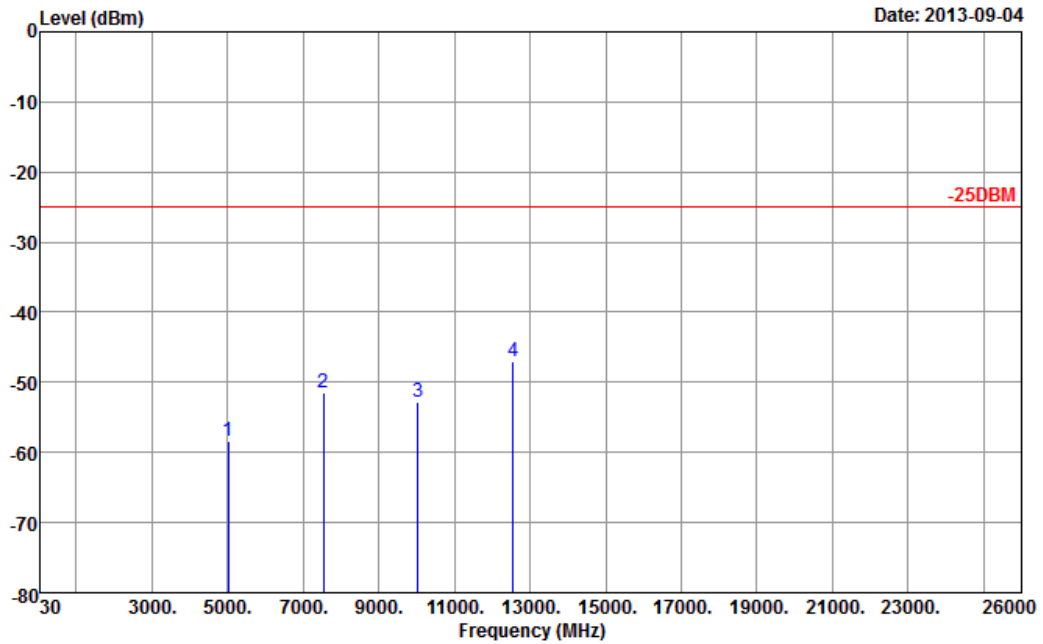

Site : 03CH01-SZ
 Condition : -25DBM HF_EIRP_H_130101 HORIZONTAL

Plane : Y

Frequency (MHz)	EIRP (dBm)	Limit (dBm)	Over Limit (dB)	SPA Reading (dBm)	S.G. Power (dBm)	TX Cable loss (dB)	TX Antenna Gain (dBi)	Polarization (H/V)	Result
5020.00	-58.41	-25	-33.41	-69.49	-38.20	1.15	7.54	H	Pass
7528.00	-51.56	-25	-26.56	-70.52	-68.60	1.51	9.80	H	Pass
10040.00	-52.74	-25	-27.74	-76.36	-67.90	1.75	11.51	H	Pass
12548.00	-46.93	-25	-21.93	-73.19	-58.70	1.97	12.86	H	Pass



Band :	LTE Band 7	Temperature :	23~25°C
Test Mode :	20MHz, QPSK, RB Size 1, RB Offset 49	Relative Humidity :	49~52%
Test Engineer :	Gavin Zhang	Polarization :	Vertical
Remark :	Spurious emissions within 30-1000MHz were found more than 20dB below limit line.		

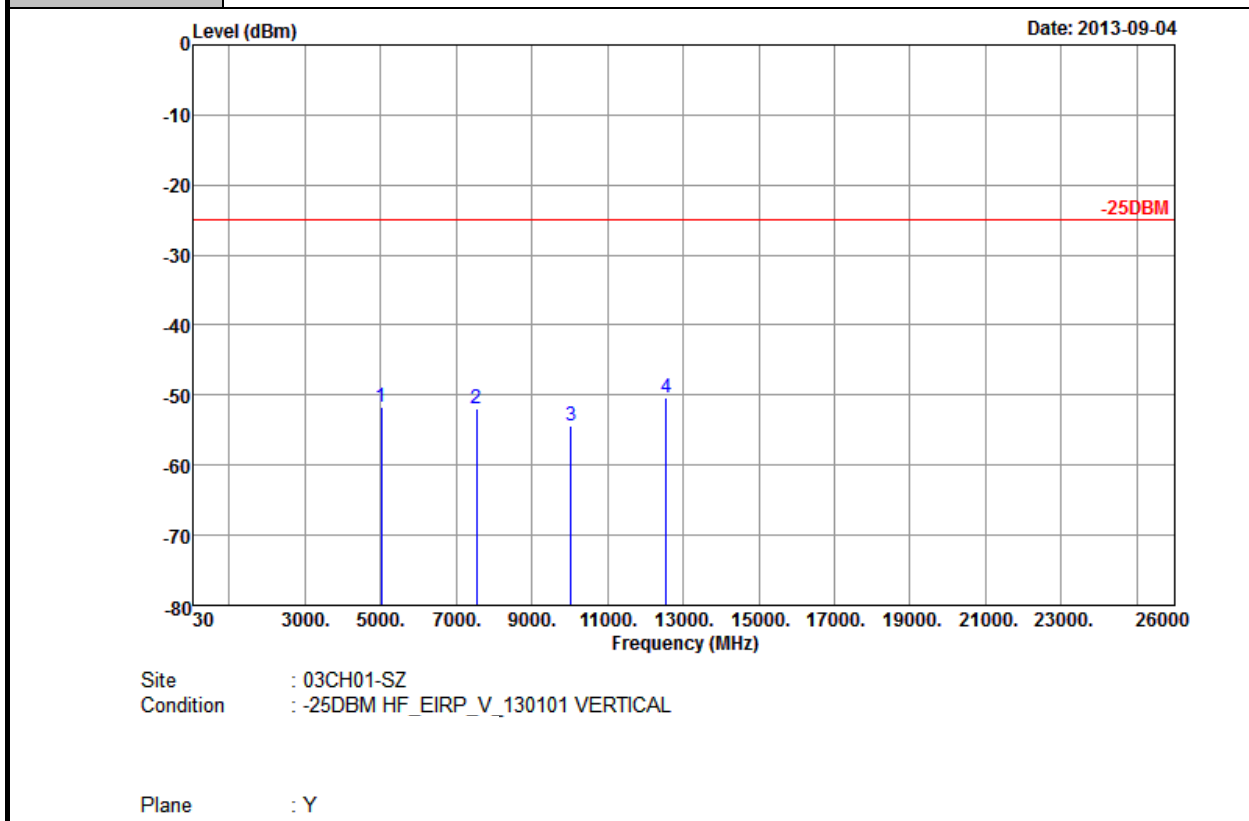

Frequency (MHz)	EIRP (dBm)	Limit (dBm)	Over Limit (dB)	SPA Reading (dBm)	S.G. Power (dBm)	TX Cable loss (dB)	TX Antenna Gain (dBi)	Polarization (H/V)	Result
5020	-51.78	-25	-26.78	-64.64	-43.20	1.15	7.54	V	Pass
7528	-51.96	-25	-26.96	-71.36	-70.30	1.51	9.80	V	Pass
10040	-54.41	-25	-29.41	-77.74	-64.60	1.75	11.51	V	Pass
12548	-50.40	-25	-25.40	-76.3	-56.60	1.97	12.86	V	Pass

3.5 Frequency Stability Measurement

3.5.1 Description of Frequency Stability Measurement

The frequency stability shall be sufficient to ensure that the fundamental emissions stay within the authorized frequency band. For equipment authorization purposes, this is a reporting requirement only.

3.5.2 Measuring Instruments

See list of measuring instruments of this test report.

3.5.3 Test Procedures for Temperature Variation

1. The EUT was set up in the thermal chamber and connected with the system simulator.
2. With power OFF, the temperature was decreased to -30°C and the EUT was stabilized before testing. Power was applied and the maximum change in frequency was recorded within one minute.
3. With power OFF, the temperature was raised in 10°C step up to 50°C . The EUT was stabilized at each step for at least half an hour. Power was applied and the maximum frequency change was recorded within one minute.
4. If the EUT cannot be turned on at -30°C , the testing lowest temperature will be raised in 10°C step until the EUT can be turned on.

3.5.4 Test Procedures for Voltage Variation

1. The EUT was placed in a temperature chamber at $25\pm 5^{\circ}\text{C}$ and connected with the system simulator.
2. The power supply voltage to the EUT was varied from 85% to 115% of the nominal value measured at the input to the EUT.
3. The variation in frequency was measured for the worst case.

3.5.5 Test Setup

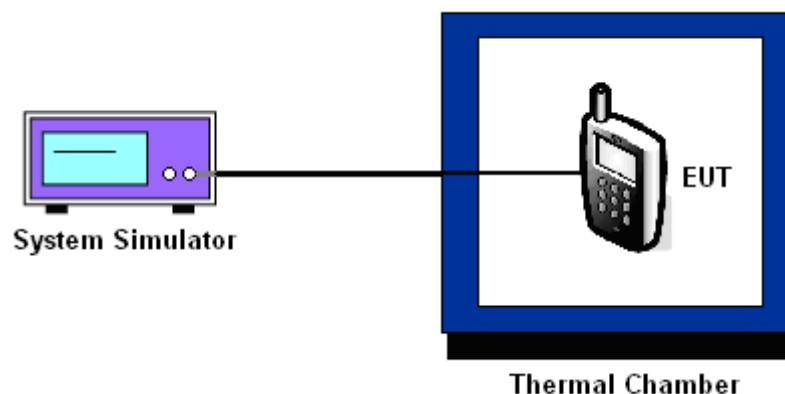

3.5.6 Test Result of Temperature Variation

Band :	LTE Band 7	Limit (ppm) :	2.5
Mode :	QPSK		

Temperature (°C)	5MHz		10MHz		15MHz		20MHz		Result
	Freq. Dev. (Hz)	Deviation (ppm)	Freq. Dev. (Hz)	Deviation (ppm)	Freq. Dev. (Hz)	Deviation (ppm)	Freq. Dev. (Hz)	Deviation (ppm)	
-30	-19.5	-0.008	-22.3	-0.009	20.7	+0.008	-20.7	-0.008	PASS
-20	-19.1	-0.008	-20.3	-0.008	19.5	+0.008	-21.3	-0.008	
-10	-18.5	-0.007	-21.8	-0.009	18.7	+0.007	-20.3	-0.008	
0	-18.7	-0.007	-20.9	-0.008	-20.3	-0.008	-19.5	-0.008	
10	-18.6	-0.007	-23.5	-0.009	-19.7	-0.008	-21.6	-0.009	
20	-18.9	-0.007	-21.6	-0.009	18.6	+0.007	-22.4	-0.009	
30	-17.6	-0.007	-23.4	-0.009	19.7	+0.008	-21.6	-0.009	
40	-17.2	-0.007	-25.4	-0.010	20.3	+0.008	-22.5	-0.009	
50	-18.2	-0.007	-23.2	-0.009	-20.9	-0.008	-24.6	-0.010	
55	-17.1	-0.007	-26.1	-0.010	-21.2	-0.008	-25.5	-0.010	

Note: The manufacturer declared that the EUT could work properly at temperature 55°C.

Band :	LTE Band 7	Limit (ppm) :	2.5
Mode :	16QAM		

Temperature (°C)	5MHz		10MHz		15MHz		20MHz		Result
	Freq. Dev. (Hz)	Deviation (ppm)	Freq. Dev. (Hz)	Deviation (ppm)	Freq. Dev. (Hz)	Deviation (ppm)	Freq. Dev. (Hz)	Deviation (ppm)	
-30	-20.1	-0.008	-20.8	-0.008	-20.3	-0.008	-21.8	-0.009	PASS
-20	-21.2	-0.008	-23.1	-0.009	-21.3	-0.008	-20.3	-0.008	
-10	-19.7	-0.008	-19.5	-0.008	-19.5	-0.008	-19.5	-0.008	
0	-22.1	-0.009	-20.1	-0.008	-18.6	-0.007	-21.3	-0.008	
10	-21.5	-0.008	19.5	+0.008	-19.5	-0.008	-20.3	-0.008	
20	-19.2	-0.008	22.5	+0.009	-17.8	-0.007	-19.5	-0.008	
30	-20.1	-0.008	23.4	+0.009	-22.5	-0.009	-19.8	-0.008	
40	-18.5	-0.007	22.4	+0.009	-19.5	-0.008	-24.3	-0.010	
50	-20.6	-0.008	24.6	+0.010	-21.3	-0.008	-23.4	-0.009	
55	-22.9	-0.009	26.5	+0.010	-23.2	-0.009	-25.5	-0.010	

Note: The manufacturer declared that the EUT could work properly at temperature 55°C.

3.5.7 Test Result of Voltage Variation

Band	Mode	Band Width	Voltage (Volt)	Freq. Dev. (Hz)	Deviation (ppm)	Limit (ppm)	Result
LTE Band 7	QPSK	5MHz	4.2	-20.3	-0.008	2.5	PASS
			3.7	-18.9	-0.007		
			3.6	-19.5	-0.008		
		10MHz	4.2	-20.4	-0.008		
			3.7	-21.6	-0.009		
			3.6	-22.1	-0.009		
		15MHz	4.2	19.4	+0.008		
			3.7	18.6	+0.007		
			3.6	18.8	+0.007		
		20MHz	4.2	-22.1	-0.009		
			3.7	-22.4	-0.009		
			3.6	-21.5	-0.009		
	16QAM	5MHz	4.2	-20.1	-0.008		
			3.7	-19.2	-0.008		
			3.6	-18.5	-0.007		
		10MHz	4.2	23.1	+0.009		
			3.7	22.5	+0.009		
			3.6	22.8	+0.009		
		15MHz	4.2	-18.4	-0.007		
			3.7	-17.8	-0.007		
			3.6	-16.3	-0.006		
		20MHz	4.2	-20.9	-0.008		
			3.7	-19.5	-0.008		
			3.6	-19.8	-0.008		

Remark:

1. Normal Voltage = 3.7V.
2. The manufacturer declared that the EUT could work properly between voltage 3.6V ~ 4.2V.

3.5.8 List of Measuring Equipment

Instrument	Manufacturer	Model No.	Serial No.	Characteristics	Calibration Date	Test Date	Due Date	Remark
Spectrum Analyzer	R&S	FSP30	101400	9kHz~30GHz	Mar. 28, 2013	Sep. 04, 2013~ Sep. 05, 2013	Mar. 27, 2014	Conducted (TH01-SZ)
Power Meter	Anritsu	ML2495A	1218010	N/A	Mar. 28, 2013	Sep. 04, 2013~ Sep. 05, 2013	Mar. 27, 2014	Conducted (TH01-SZ)
Power Sensor	Anritsu	MA2411B	1207253	N/A	Mar. 28, 2013	Sep. 04, 2013~ Sep. 05, 2013	Mar. 27, 2014	Conducted (TH01-SZ)
Thermal Chamber	Hongzhan	LP-150U	HD20120425	N/A	Mar. 28, 2013	Sep. 04, 2013~ Sep. 05, 2013	Mar. 27, 2014	Conducted (TH01-SZ)
Spectrum Analyzer	Agilent Technologies	N9038A	MY52260185	20Hz~26.5GHz	Apr. 04, 2013	Sep. 04, 2013~ Sep. 06, 2013	Apr. 03, 2014	Radiation (03CH01-SZ)
Bilog Antenna	SCHAFFNER	CBL6112B	2614	30MHz~2GHz	Nov. 03, 2012	Sep. 04, 2013~ Sep. 06, 2013	Nov. 02, 2013	Radiation (03CH01-SZ)
Double Ridge Horn Antenna	ETS Lindgren	3117	00119436	1GHz~18GHz	Oct. 12, 2012	Sep. 04, 2013~ Sep. 06, 2013	Oct. 11, 2013	Radiation (03CH01-SZ)
Amplifier	ADVANTEST	BB525C	E9007003	9kHz~3GHz Gain 30dB	Mar. 28, 2013	Sep. 04, 2013~ Sep. 06, 2013	Mar. 27, 2014	Radiation (03CH01-SZ)
Amplifier	Yiai	AV3860B	04030	2GHz~26.5GHz	Mar. 28, 2013	Sep. 04, 2013~ Sep. 06, 2013	Mar. 27, 2014	Radiation (03CH01-SZ)
SHF-EHF-Horn	Schwarzbeck	BBHA9170	BBHA9170249	14GHz~40GHz	Nov. 23, 2012	Sep. 04, 2013~ Sep. 06, 2013	Nov. 22, 2013	Radiation (03CH01-SZ)
Turn Table	EM Electronics	EM 1000	N/A	0 ~ 360 degree	N/A	Sep. 04, 2013~ Sep. 06, 2013	N/A	Radiation (03CH01-SZ)
Antenna Mast	EM Electronics	EM 1000	N/A	1 m ~ 4 m	N/A	Sep. 04, 2013~ Sep. 06, 2013	N/A	Radiation (03CH01-SZ)
Spectrum Analyzer	R&S	FSP 7	100818	9kHz~7GHz	Aug. 21, 2013	Sep. 13, 2013	Aug. 20, 2014	EIRP (OTA01-SZ)
Quad-Ridged Horn	ETS-Lindgren	3164-08	00102954	700MHz~10000 MHz	N/A	Sep. 13, 2013	N/A	EIRP (OTA01-SZ)
Multi-Devices Controller	ETS-Lindgren	2090-OPT1	00108147	N/A	N/A	Sep. 13, 2013	N/A	EIRP (OTA01-SZ)
Switch Control Mainframe	Agilent	3499A	MY42005451	N/A	N/A	Sep. 13, 2013	N/A	EIRP (OTA01-SZ)



4 Uncertainty of Evaluation

Uncertainty of Radiated Emission Measurement (30 MHz ~ 1000 MHz)

Measuring Uncertainty for a Level of Confidence of 95% ($U = 2Uc(y)$)	2.54
---	------

Uncertainty of Radiated Emission Measurement (1 GHz ~ 40 GHz)

Measuring Uncertainty for a Level of Confidence of 95% ($U = 2Uc(y)$)	4.72
---	------