



FCC RF Test Report

APPLICANT : Yulong Computer Telecommunication Scientific (Shenzhen) Co., Ltd.
EQUIPMENT : Mobile Phone
BRAND NAME : Vodafone Smart 4G/Smartphone
Android™ by SFR STARADDICT III
MODEL NAME : Coolpad 8860U/Coolpad 8861U
MARKETING NAME : Vodafone Smart 4G/Smartphone
Android™ by SFR STARADDICT III
FCC ID : R38YL8860U
STANDARD : FCC Part 15 Subpart C §15.247
CLASSIFICATION : (DTS) Digital Transmission System

The product was received on Apr. 04, 2013 and testing was completed on Sep. 04, 2013. We, SPORTON INTERNATIONAL (SHENZHEN) INC., would like to declare that the tested sample has been evaluated in accordance with the procedures and shown to be compliant with the applicable technical standards.

The test results in this report apply exclusively to the tested model / sample. Without written approval of SPORTON INTERNATIONAL (SHENZHEN) INC., the test report shall not be reproduced except in full.



Reviewed by: Joseph Lin / Supervisor

Approved by: Jones Tsai / Manager



SPORTON INTERNATIONAL (SHENZHEN) INC.

**No. 3 Building, the third floor of south, Shahe River west, Fengzeyuan warehouse, Nanshan District,
Shenzhen, Guangdong, P.R.C.**



TABLE OF CONTENTS

REVISION HISTORY..... 4

SUMMARY OF TEST RESULT 5

1 GENERAL DESCRIPTION..... 6

 1.1 Applicant 6

 1.2 Manufacturer..... 6

 1.3 Feature of Equipment Under Test 6

 1.4 Product Specification of Equipment Under Test..... 7

 1.5 Modification of EUT 7

 1.6 Testing Site..... 7

 1.7 Applied Standards 7

2 TEST CONFIGURATION OF EQUIPMENT UNDER TEST..... 8

 2.1 Descriptions of Test Mode 8

 2.2 Test Mode..... 9

 2.3 Connection Diagram of Test System..... 10

 2.4 Support Unit used in test configuration and system 11

 2.5 Description of RF Function Operation Test Setup..... 11

 2.6 Measurement Results Explanation Example..... 12

3 TEST RESULT 13

 3.1 6dB Bandwidth Measurement 13

 3.2 Peak Output Power Measurement 16

 3.3 Power Spectral Density Measurement 18

 3.4 Conducted Band Edges and Spurious Emission Measurement 24

 3.5 Radiated Band Edges and Spurious Emission Measurement 33

 3.6 AC Conducted Emission Measurement..... 44

 3.7 Antenna Requirements..... 48

4 LIST OF MEASURING EQUIPMENT..... 49

5 UNCERTAINTY OF EVALUATION..... 50

APPENDIX A. SETUP PHOTOGRAPHS

SUMMARY OF TEST RESULT

Report Section	FCC Rule	Description	Limit	Result	Remark
3.1	15.247(a)(2)	6dB Bandwidth	$\geq 0.5\text{MHz}$	Pass	-
3.2	15.247(b)(1)	Peak Output Power	$\leq 30\text{dBm}$	Pass	-
3.3	15.247(e)	Power Spectral Density	$\leq 8\text{dBm}$	Pass	-
3.4	15.247(d)	Conducted Band Edges and Spurious Emission	$\leq 20\text{dBc}$	Pass	-
3.5	15.247(d)	Radiated Band Edges and Spurious Emission	15.209(a) & 15.247(d)	Pass	Under limit 11.36 dB at 546.040 MHz
3.6	15.207	AC Conducted Emission	15.207(a)	Pass	Under limit 6.12 dB at 0.440 MHz
3.7	15.203 & 15.247(b)	Antenna Requirement	N/A	Pass	-

1 General Description

1.1 Applicant

Yulong Computer Telecommunication Scientific (Shenzhen) Co., Ltd.

Coolpad Information Harbor, 2nd Mengxi Road, Northern Part of Science&Technology Park, Nanshan district, Shenzhen, P.R.China

1.2 Manufacturer

Yulong Computer Telecommunication Scientific (Shenzhen) Co., Ltd.

Coolpad Information Harbor, 2nd Mengxi Road, Northern Part of Science&Technology Park, Nanshan district, Shenzhen, P.R.China

1.3 Feature of Equipment Under Test

Product Feature	
Equipment	Mobile Phone
Brand Name	Vodafone Smart 4G/Smartphone Android™ by SFR STARADDICT III
Model Name	Coolpad 8860U/Coolpad 8861U
Marketing Name	Vodafone Smart 4G/Smartphone Android™ by SFR STARADDICT III
FCC ID	R38YL8860U
EUT supports Radios application	GSM/GPRS/EGPRS/LTE/WLAN 802.11abgn HT 20/ Bluetooth v3.0 + EDR/Bluetooth v4.0/NFC
HW Version	T3
SW Version	082.12.T3.130819.CP8860U (for Vodafone Smart 4G) 082.12.T3.130819.CP8861U (for Smartphone Android™ by SFR STARADDICT III)
EUT Stage	Production Unit

Remark:

- The above EUT's information was declared by manufacturer. Please refer to the specifications or user's manual for more detailed description.
- There are two types of EUT for this project. The differences between them are summary below:

Sample List	Function Type	Brand name	Model name
Sample 1	With NFC	Vodafone Smart 4G	Coolpad 8860U
Sample 2	With NFC	Smartphone Android™ by SFR STARADDICT III	Coolpad 8861U

Sample 1 and sample 2 are identical on hardware. The only difference is for different market purpose.

In this report, we use with sample 1 to perform the test.

1.4 Product Specification of Equipment Under Test

Product Specification subjective to this standard	
Tx/Rx Frequency Range	2402 MHz ~ 2480 MHz
Number of Channels	40
Carrier Frequency of Each Channel	40 Channel(37 hopping + 3 advertising channel)
Maximum Output Power to Antenna	1.22 dBm (0.00132 W)
Antenna Type	PIFA Antenna with gain -0.9 dBi
Type of Modulation	Bluetooth v4.0 - LE : GFSK

1.5 Modification of EUT

No modifications are made to the EUT during all test items.

1.6 Testing Site

Test Site	SPORTON INTERNATIONAL (SHENZHEN) INC.			
Test Site Location	No. 3 Building, the third floor of south, Shahe River west, Fengzeyuan warehouse, Nanshan District, Shenzhen, Guangdong, P.R.C. TEL: +86-755- 3320-2398			
Test Site No.	Sporton Site No.			FCC Registration No.
	TH01-SZ	CO01-SZ	03CH01-SZ	831040

The test site complies with ANSI C63.4 2003 requirement.

1.7 Applied Standards

According to the specifications of the manufacturer, the EUT must comply with the requirements of the following standards:

- ♦ FCC Part 15 Subpart C §15.247
- ♦ FCC KDB Publication No. 558074 D01 DTS Meas. Guidance v03r01
- ♦ ANSI C63.4-2003

Remark:

1. All test items were verified and recorded according to the standards and without any deviation during the test.
2. This EUT has also been tested and complied with the requirements of FCC Part 15, Subpart B, recorded in a separate test report.

2 Test Configuration of Equipment Under Test

2.1 Descriptions of Test Mode

The RF output power was recorded in the following table:

Channel	Frequency	Bluetooth 4.0 – LE RF Output Power	
		Data Rate / Modulation	
		GFSK	
		1Mbps	
Ch00	2402MHz	0.57 dBm	
Ch19	2440MHz	1.14 dBm	
Ch39	2480MHz	1.22 dBm	

- a. The EUT has been associated with peripherals and configuration operated in a manner tended to maximize its emission characteristics in a typical application. Frequency range investigated: conduction (150 kHz to 30 MHz), radiation (9 kHz to the 10th harmonic of the highest fundamental frequency or to 40 GHz, whichever is lower). Pre-scanned tests, X, Y, Z in three orthogonal panels to determine the final configuration (Z plane as worst plane) from all possible combinations.
- b. AC power line Conducted Emission was tested under maximum output power.

2.2 Test Mode

The following summary table is showing all test modes to demonstrate in compliance with the standard.

Summary table of Test Cases	
Test Item	Data Rate / Modulation
	Bluetooth v4.0 – LE / GFSK
Conducted TCs	Mode 1: Bluetooth Tx CH00_2402 MHz_1Mbps Mode 2: Bluetooth Tx CH19_2440 MHz_1Mbps Mode 3: Bluetooth Tx CH39_2480 MHz_1Mbps
Radiated TCs	Mode 1: Bluetooth Tx CH00_2402 MHz_1Mbps Mode 2: Bluetooth Tx CH19_2440 MHz_1Mbps Mode 3: Bluetooth Tx CH39_2480 MHz_1Mbps
AC Conducted Emission	Mode 1: GSM1900 Idle + Bluetooth Link + WLAN (2.4GHz) Link + USB Cable (Charging from Adapter) + Earphone + NFC on + Battery 1 Mode 2: GSM1900 Idle + Bluetooth Link + WLAN (5GHz) Link + USB Cable (Charging from Adapter) + Earphone + Battery 2
Remark: The worst case of conducted emission is mode 1; only the test data of it was reported.	

2.3 Connection Diagram of Test System

<Bluetooth v4.0 – LE Tx Mode>

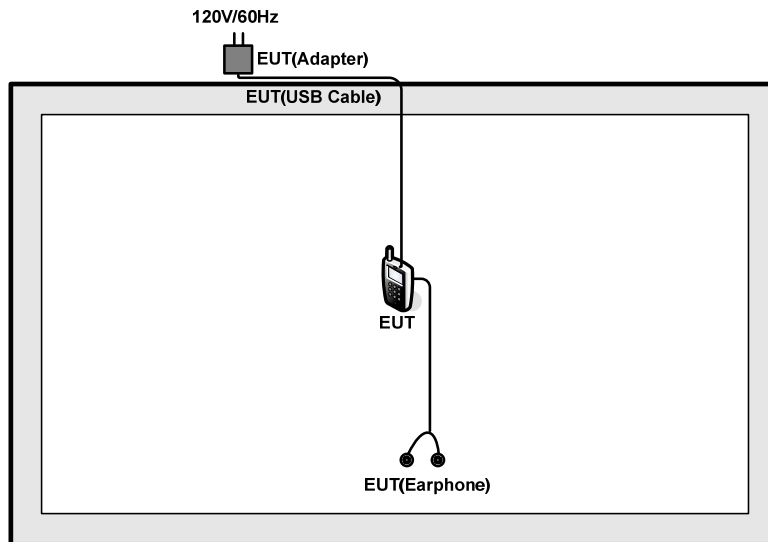

<AC Conducted Emission Mode>

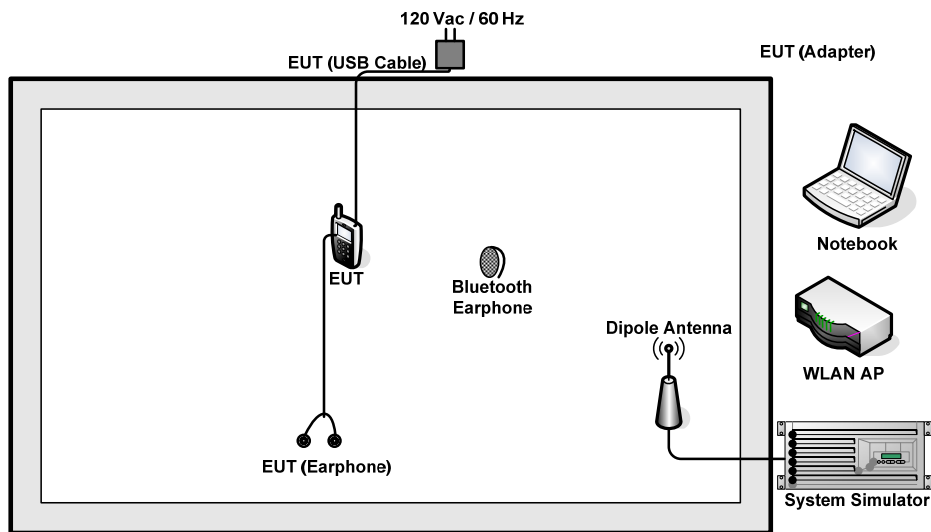

2.4 Support Unit used in test configuration and system

Item	Equipment	Trade Name	Model Name	FCC ID	Data Cable	Power Cord
1.	System Simulator	Agilent	E5515C	N/A	N/A	Unshielded, 1.8 m
2.	DC Power Supply	TOPWORD	3303DR	N/A	N/A	Unshielded, 1.8 m
3.	WLAN AP	D-Link	DIR-612	N/A	N/A	Unshielded, 1.8 m
4.	Notebook	DELL	P08S	QDS-BRCM1030	N/A	AC I/P: Unshielded, 0.9 m DC O/P: Shielded, 1.8 m
5.	Bluetooth Earphone	Nokia	BH108	N/A	N/A	N/A

2.5 Description of RF Function Operation Test Setup

For Bluetooth function, an engineering test program was provided and enabled to make EUT continuous transmit/receive.

For AC power line conducted emissions, the EUT was set to connect with the WLAN AP under large package sizes transmission.

2.6 Measurement Results Explanation Example

For all conducted test items:

The offset level is set in the spectrum analyzer to compensate the RF cable loss and attenuator factor between EUT conducted output port and spectrum analyzer. With the offset compensation, the spectrum analyzer reading level is exactly the EUT RF output level.

Example :

The spectrum analyzer offset is derived from RF cable loss and attenuator factor.

Offset = RF cable loss + attenuator factor.

Following shows an offset computation example with cable loss 7.5 dB and 10dB attenuator.

$$\begin{aligned} \text{Offset(dB)} &= \text{RF cable loss(dB)} + \text{attenuator factor(dB)} \\ &= 7.5 + 10 = 17.5 \text{ (dB)} \end{aligned}$$

3 Test Result

3.1 6dB Bandwidth Measurement

3.1.1 Limit of 6dB Bandwidth

The minimum 6 dB bandwidth shall be at least 500 kHz.

3.1.2 Measuring Instruments

See list of measuring instruments of this test report.

3.1.3 Test Procedures

1. The testing follows FCC KDB Publication No. 558074 D01 DTS Meas. Guidance v03r01.
2. The RF output of EUT was connected to the spectrum analyzer by RF cable and attenuator. The path loss was compensated to the results for each measurement.
3. Set to the maximum power setting and enable the EUT transmit continuously.
4. Make the measurement with the spectrum analyzer's resolution bandwidth (RBW) = 100 kHz. Set the Video bandwidth (VBW) = 300 kHz. In order to make an accurate measurement. The 6 dB bandwidth must be greater than 500 kHz.
5. Measure and record the results in the test report.

3.1.4 Test Setup

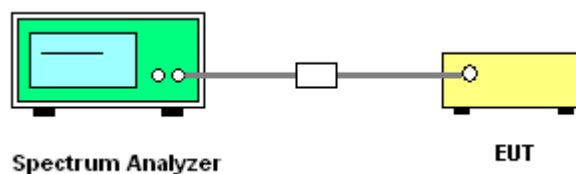



3.1.5 Test Result of 6dB Bandwidth

Test Mode :	Bluetooth v4.0 - LE	Temperature :	24~26°C
Test Engineer :	Fly Chen	Relative Humidity :	50~53%

Channel	Frequency (MHz)	6dB Bandwidth (MHz)	6dB Bandwidth Min. Limit (MHz)	Pass/Fail
00	2402	0.668	0.5	Pass
19	2440	0.674	0.5	Pass
39	2480	0.660	0.5	Pass

6 dB Bandwidth Plot on Channel 00

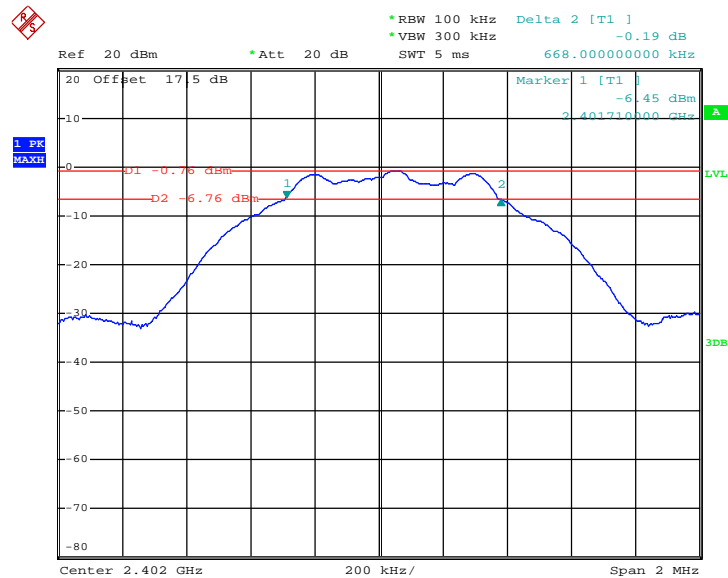

Date: 13.JUL.2013 15:07:56



6 dB Bandwidth Plot on Channel 19

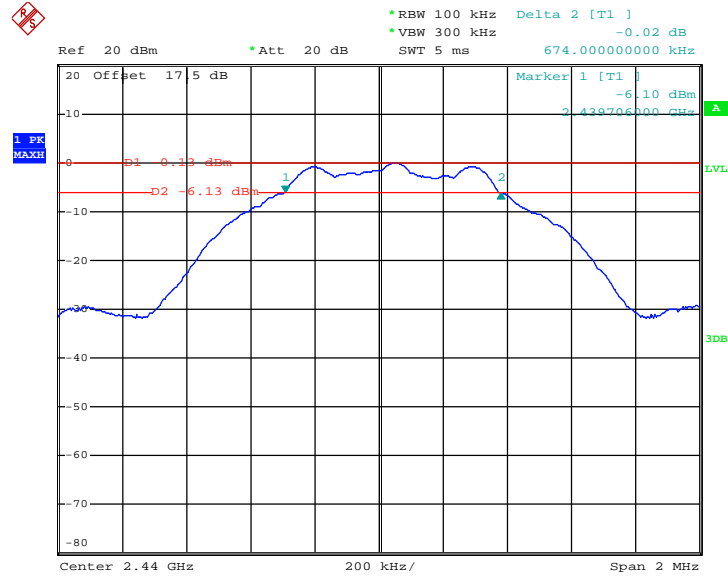

Date: 13.JUL.2013 15:10:37

6 dB Bandwidth Plot on Channel 39

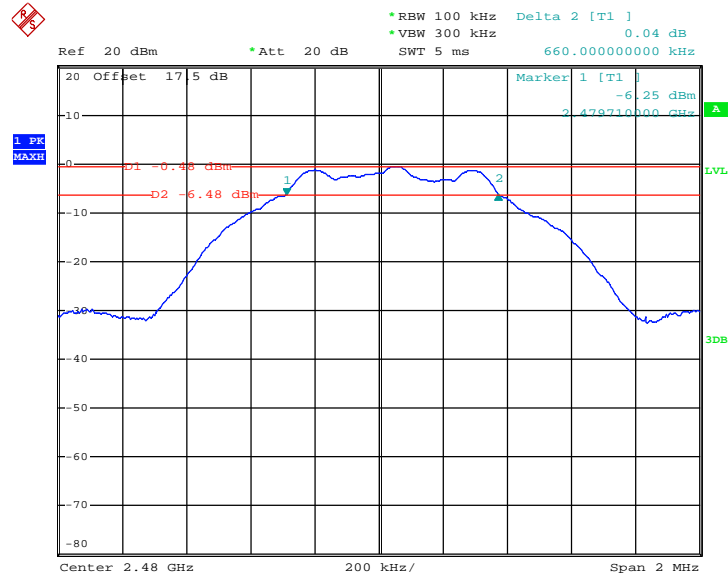

Date: 13.JUL.2013 15:13:33

3.2 Peak Output Power Measurement

3.2.1 Limit of Peak Output Power

For systems using digital modulation in the 2400-2483.5MHz, the limit for peak output power is 30dBm. If transmitting antenna of directional gain greater than 6dBi is used, the peak output power from the intentional radiator shall be reduced below the above stated value by the amount in dB that the directional gain of the antenna exceeds 6 dBi. In case of point-to-point operation, the limit has to be reduced by 1dB for every 3dB that the directional gain of the antenna exceeds 6dBi.

3.2.2 Measuring Instruments

See list of measuring instruments of this test report.

3.2.3 Test Procedures

1. The testing follows the Measurement Procedure of FCC KDB No. 558074 DTS D01 Meas. Guidance v03r01.
2. The RF output of EUT was connected to the power meter by RF cable and attenuator. The path loss was compensated to the results for each measurement.
3. Set to the maximum power setting and enable the EUT transmit continuously.
4. Measure the conducted output power and record the results in the test report.

3.2.4 Test Setup

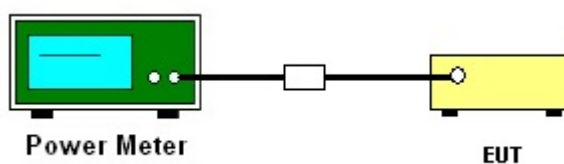



3.2.5 Test Result of Peak Output Power

Test Mode :	Bluetooth v4.0 - LE	Temperature :	24~26°C
Test Engineer :	Fly Chen	Relative Humidity :	50~53%

Channel	Frequency (MHz)	RF Power (dBm)		
		GFSK	Max. Limits (dBm)	Pass/Fail
		1 Mbps		
00	2402	0.57	30.00	Pass
19	2440	1.14	30.00	Pass
39	2480	1.22	30.00	Pass

3.3 Power Spectral Density Measurement

3.3.1 Limit of Power Spectral Density

The peak power spectral density shall not be greater than 8dBm in any 3kHz band at any time interval of continuous transmission.

3.3.2 Measuring Instruments

See list of measuring instruments of this test report.

3.3.3 Test Procedures

1. The testing follows Measurement Procedure 10.2 Method PKPSD of FCC KDB Publication No. 558074 D01 DTS Meas. Guidance v03r01
2. The RF output of EUT was connected to the spectrum analyzer by RF cable and attenuator. The path loss was compensated to the results for each measurement.
3. Set to the maximum power setting and enable the EUT transmit continuously.
4. Make the measurement with the spectrum analyzer's resolution bandwidth (RBW) = 3 kHz. Video bandwidth VBW = 10 kHz In order to make an accurate measurement, set the span to 1.5 times DTS Channel Bandwidth. (6dB BW)
5. Detector = peak, Sweep time = auto couple, Trace mode = max hold, Allow trace to fully stabilize. Use the peak marker function to determine the maximum power level.
6. Measure and record the results in the test report.
7. The Measured power density (dBm)/ 100kHz is a reference level and used as 20dBc down limit line for Conducted Band Edges and Conducted Spurious Emission.

3.3.4 Test Setup

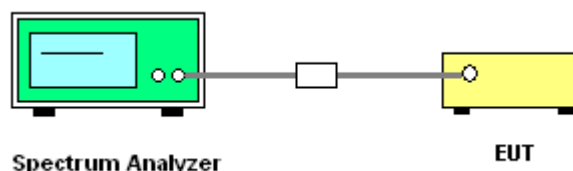

3.3.5 Test Result of Power Spectral Density

Test Mode :	Bluetooth v4.0 - LE	Temperature :	24~26°C
Test Engineer :	Fly Chen	Relative Humidity :	50~53%

Channel	Frequency (MHz)	Power Density		Max. Limits (dBm/3kHz)	Pass/Fail
		PSD/100kHz (dBm)	PSD/3kHz (dBm)		
00	2402	-0.77	-15.82	8	Pass
19	2440	-0.14	-15.15	8	Pass
39	2480	-0.51	-15.58	8	Pass

Note:

1. Measured power density (dBm) has offset with cable loss.
2. The Measured power density (dBm)/ 100kHz is reference level and used as 20dBc down for Conducted Band Edges and Conducted Spurious Emission limit line.



3.3.6 Test Result of Power Spectral Density Plots (100kHz)

PSD 100kHz Plot on Channel 00

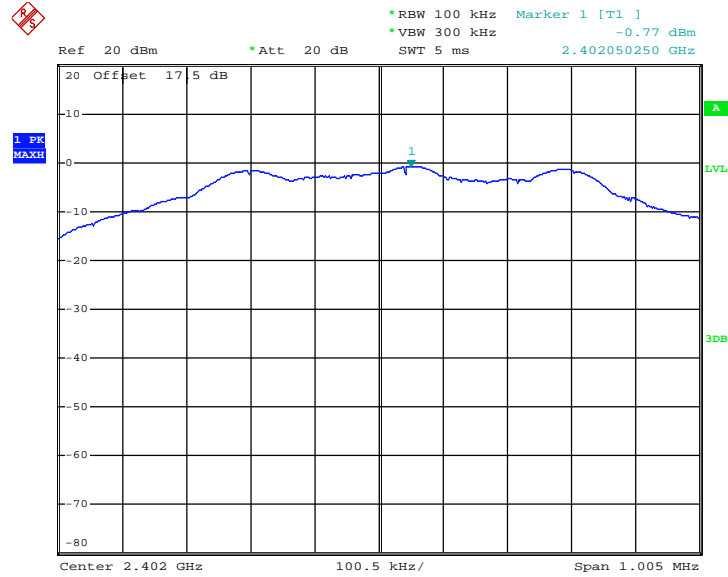

Date: 13.JUL.2013 15:08:24

PSD 100kHz Plot on Channel 19

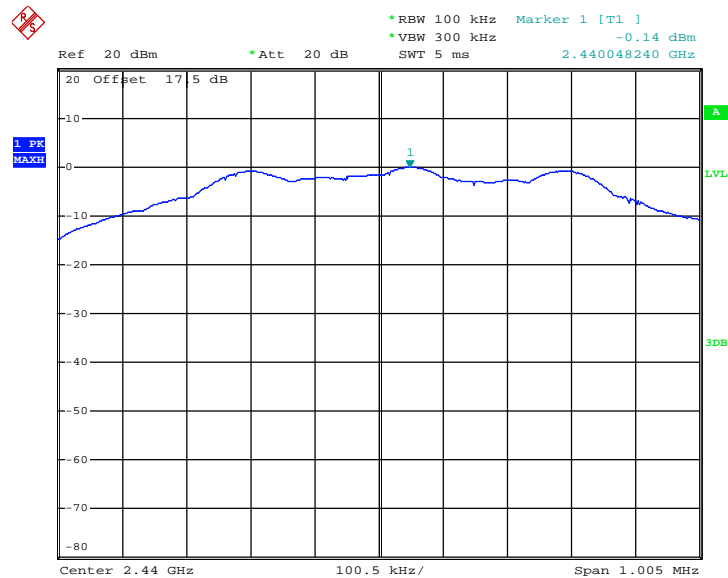

Date: 13.JUL.2013 15:11:05



PSD 100kHz Plot on Channel 39

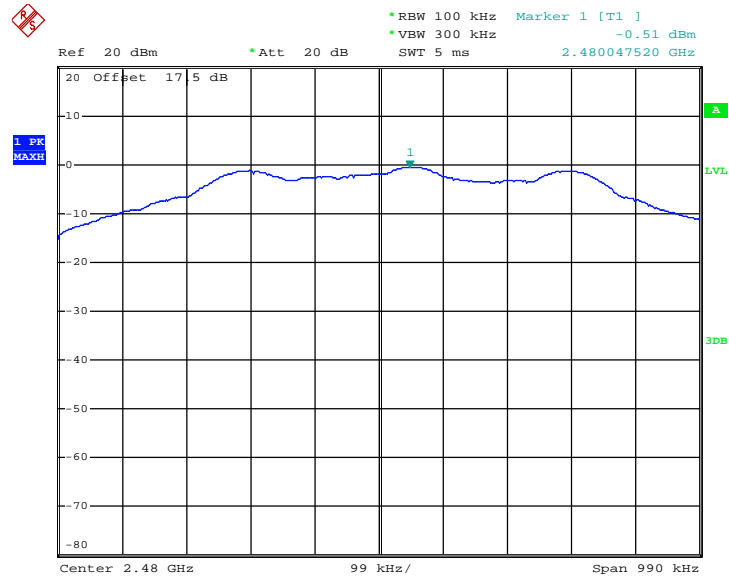

Date: 13.JUL.2013 15:14:02



3.3.7 Test Result of Power Spectral Density Plots (3kHz)

PSD 3kHz Plot on Channel 00

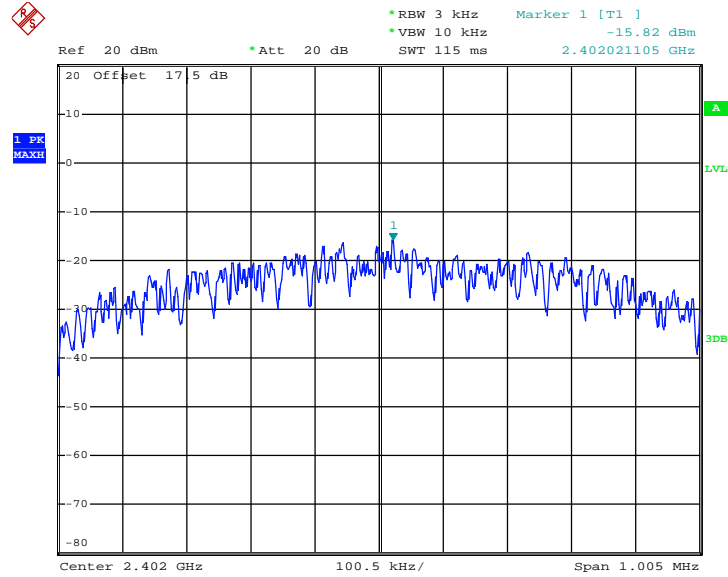

Date: 13.JUL.2013 15:08:15

PSD 3kHz Plot on Channel 19

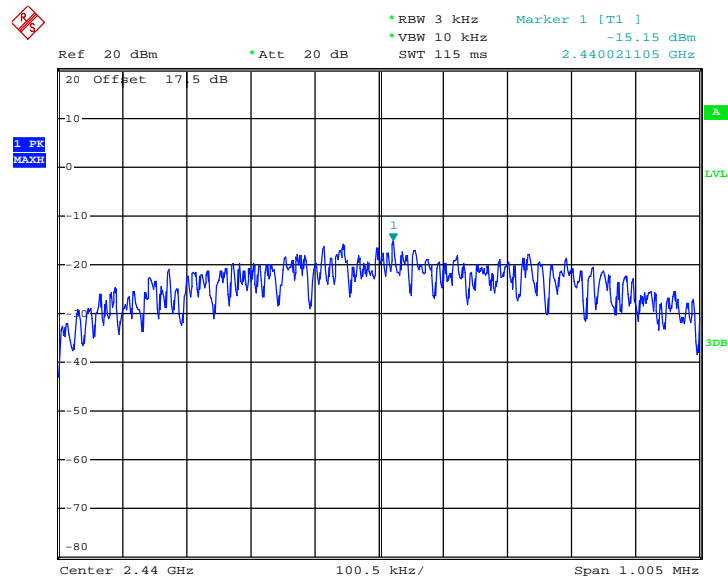

Date: 13.JUL.2013 15:10:56



PSD 3kHz Plot on Channel 39

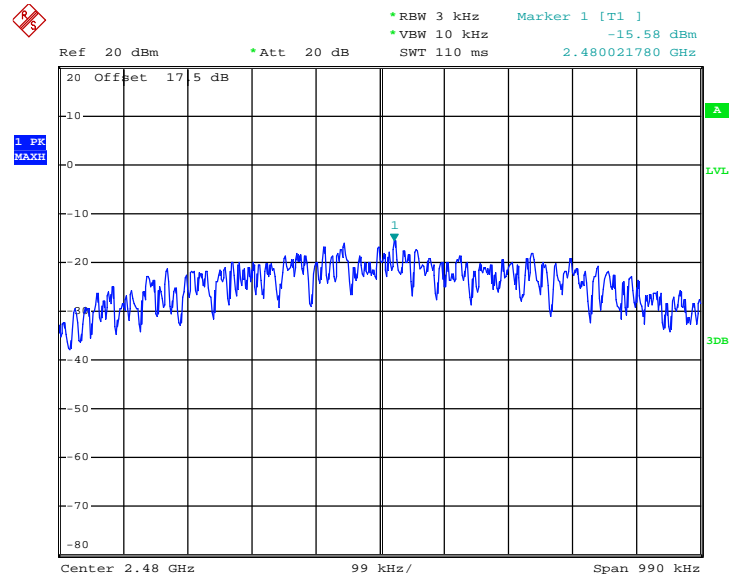

Date: 13.JUL.2013 15:13:53

3.4 Conducted Band Edges and Spurious Emission Measurement

3.4.1 Limit of Conducted Band Edges and Spurious Emission

All harmonics/spurious must be at least 20 dB down from the highest emission level within the authorized band.

3.4.2 Measuring Instruments

See list of measuring instruments of this test report.

3.4.3 Test Procedure

1. The testing follows FCC KDB Publication No. 558074 D01 DTS Meas. Guidance v03r01.
2. The RF output of EUT was connected to the spectrum analyzer by RF cable and attenuator. The path loss was compensated to the results for each measurement.
3. Set to the maximum power setting and enable the EUT transmit continuously.
4. Set RBW = 100 kHz, VBW=300 kHz, Peak Detector. Unwanted Emissions measured in any 100 kHz bandwidth outside of the authorized frequency band shall be attenuated by at least 20 dB relative to the maximum in-band peak PSD level in 100 kHz when maximum peak conducted output power procedure is used. If the transmitter complies with the conducted power limits based on the use of RMS averaging over a time interval, the attenuation required under this paragraph shall be 30 dB instead of 20 dB per 15.247(d).
5. Measure and record the results in the test report.
6. The RF fundamental frequency should be excluded against the limit line in the operating frequency band.

3.4.4 Test Setup

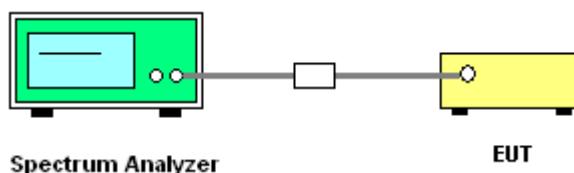



3.4.5 Test Result of Conducted Band Edges

Test Mode :	Bluetooth v4.0 - LE	Temperature :	24~26°C
Test Channel :	00 and 39	Relative Humidity :	50~53%
		Test Engineer :	Fly Chen

Low Band Edge Plot on Channel 00

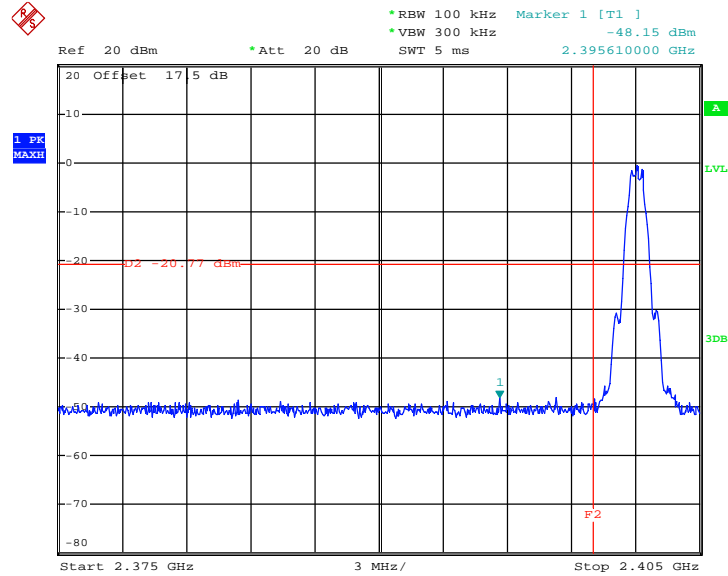

Date: 13.JUL.2013 15:08:38



High Band Edge Plot on Channel 39

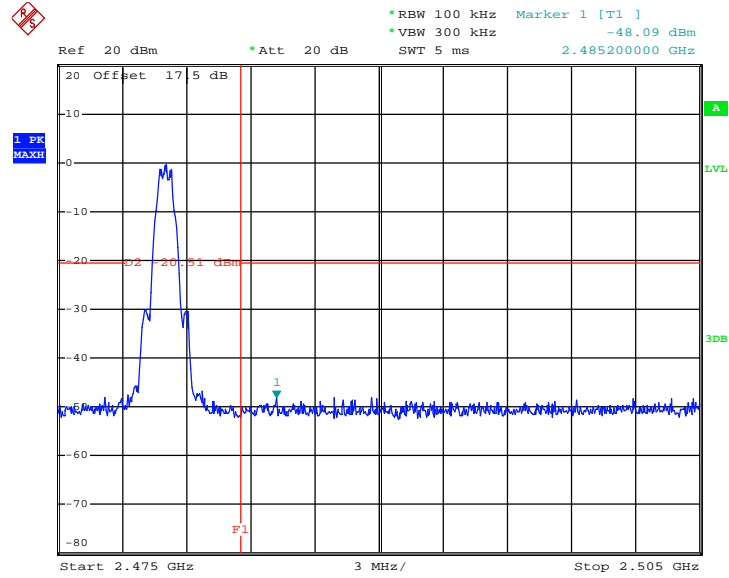

Date: 13.JUL.2013 15:14:15



3.4.6 Test Result of Conducted Spurious Emission

Test Mode :	Bluetooth v4.0 - LE	Temperature :	24~26°C
Test Channel :	00	Relative Humidity :	50~53%
		Test Engineer :	Fly Chen

Conducted Spurious Emission Plot on Bluetooth LE 1Mbps
GFSK Channel 00

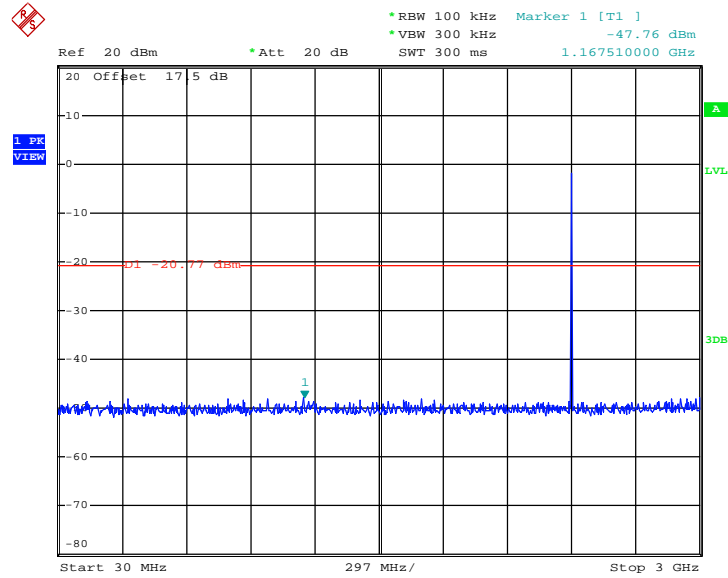

Date: 13.JUL.2013 15:08:58



Conducted Spurious Emission Plot on Bluetooth LE 1Mbps GFSK Channel 00

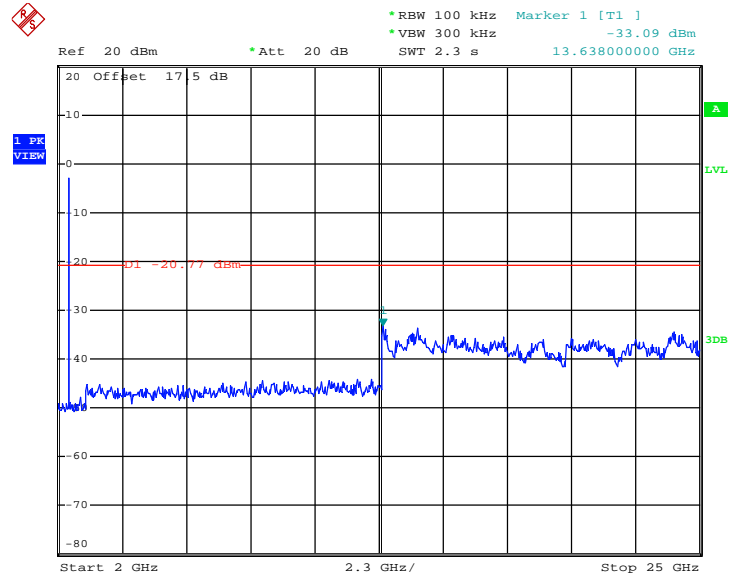

Date: 13.JUL.2013 15:09:16



Test Mode :	Bluetooth v4.0 - LE	Temperature :	24~26°C
Test Channel :	19	Relative Humidity :	50~53%
		Test Engineer :	Fly Chen

Conducted Spurious Emission Plot on Bluetooth LE 1Mbps
GFSK Channel 19

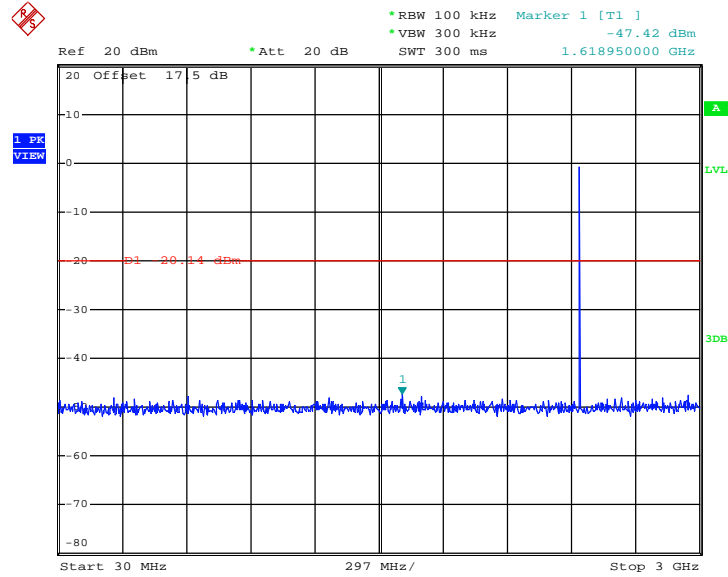

Date: 13.JUL.2013 15:11:25



Conducted Spurious Emission Plot on Bluetooth LE 1Mbps GFSK Channel 19

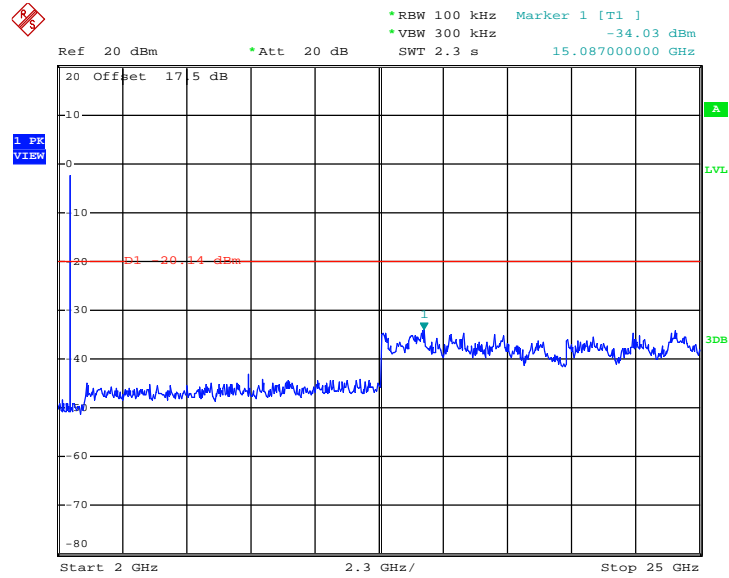

Date: 13.JUL.2013 15:11:43



Test Mode :	Bluetooth v4.0 - LE	Temperature :	24~26°C
Test Channel :	39	Relative Humidity :	50~53%
		Test Engineer :	Fly Chen

Conducted Spurious Emission Plot on Bluetooth LE 1Mbps
GFSK Channel 39

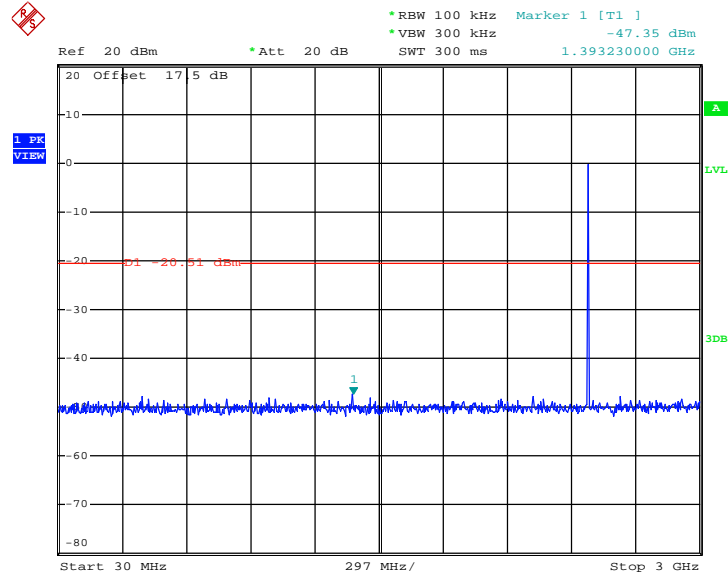

Date: 13.JUL.2013 15:14:35



Conducted Spurious Emission Plot on Bluetooth LE 1Mbps GFSK Channel 39

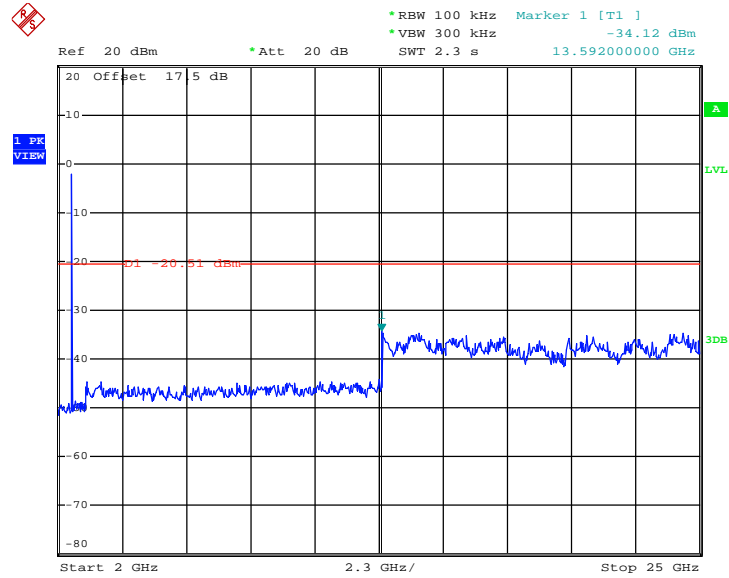

Date: 13.JUL.2013 15:14:53

3.5 Radiated Band Edges and Spurious Emission Measurement

3.5.1 Limit of Radiated Band Edges and Spurious Emission

In any 100 kHz bandwidth outside the intentional radiator frequency band, all harmonics/spurious must be at least 20 dB below the highest emission level within the authorized band. If the output power of this device was measured by spectrum analyzer, the attenuation under this paragraph shall be 30 dB instead of 20 dB. In addition, radiated emissions which fall in the restricted bands must also comply with the FCC section 15.209 limits as below.

Frequency (MHz)	Field Strength (microvolts/meter)	Measurement Distance (meters)
0.009 – 0.490	2400/F(kHz)	300
0.490 – 1.705	24000/F(kHz)	30
1.705 – 30.0	30	30
30 – 88	100	3
88 – 216	150	3
216 - 960	200	3
Above 960	500	3

3.5.2 Measuring Instruments

See list of measuring instruments of this test report.

3.5.3 Test Procedures

1. The testing follows FCC KDB Publication No. 558074 D01 DTS Meas. Guidance v03r01.
2. The EUT was arranged to its worst case and then tune the antenna tower (from 1 m to 4 m) and turntable (from 0 degree to 360 degrees) to find the maximum reading. A pre-amp and a high pass filter are used for the test in order to get better signal level.
3. The EUT was placed on a turntable with 0.8 meter above ground.
4. The EUT was set 3 meters from the interference receiving antenna, which was mounted on the top of a variable height antenna tower.
5. Corrected Reading: Antenna Factor + Cable Loss + Read Level - Preamp Factor = Level
6. For measurement below 1GHz, If the emission level of the EUT measured by the peak detector is 3 dB lower than the applicable limit, the peak emission level will be reported. Otherwise, the emission measurement will be repeated using the quasi-peak detector and reported.
7. Use the following spectrum analyzer settings:
 - (1) Span shall wide enough to fully capture the emission being measured;
 - (2) Set RBW=100 kHz for $f < 1$ GHz; $VBW \geq RBW$; Sweep = auto; Detector function = peak; Trace = max hold;
 - (3) Set RBW = 1 MHz, VBW= 3MHz for $f \geq 1$ GHz for peak measurement.
 For average measurement:
 - $VBW = 10$ Hz, when duty cycle is no less than 98 percent.
 - $VBW \geq 1/T$, when duty cycle is less than 98 percent where T is the minimum transmission duration over which the transmitter is on and is transmitting at its maximum power control level for the tested mode of operation.

Band	Duty Cycle(%)	T(ms)	1/T(kHz)	VBW Setting
Bluetooth v4.0 - LE	32.28	0.204	4.90	10kHz



Bluetooth 4.0_LE Duty Cycle

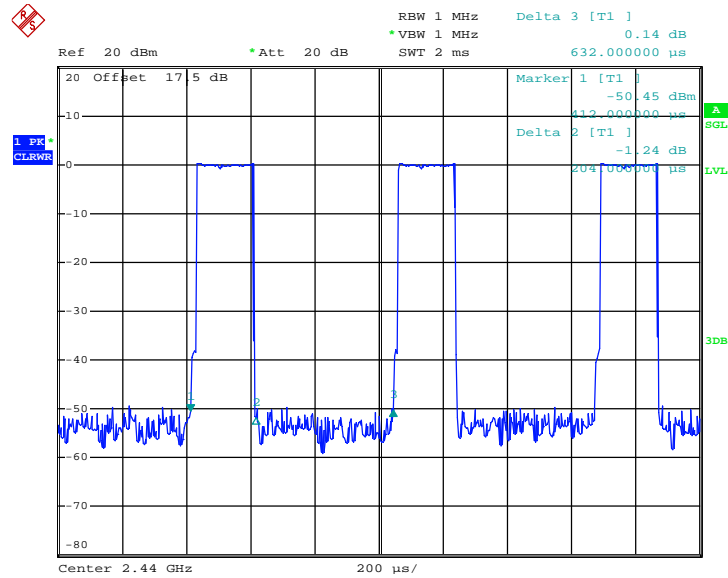

Date: 9.JUL.2013 15:04:03

Note:

The total loss is 17.5dB of the RF cable and attenuator, and has been compensated to the spectrum analyzer by setting into the amplitude level offset. That means the measured result shown on the spectrum analyzer has added the total loss and been compliance with the limit line.

3.5.4 Test Setup

For radiated emissions below 30MHz

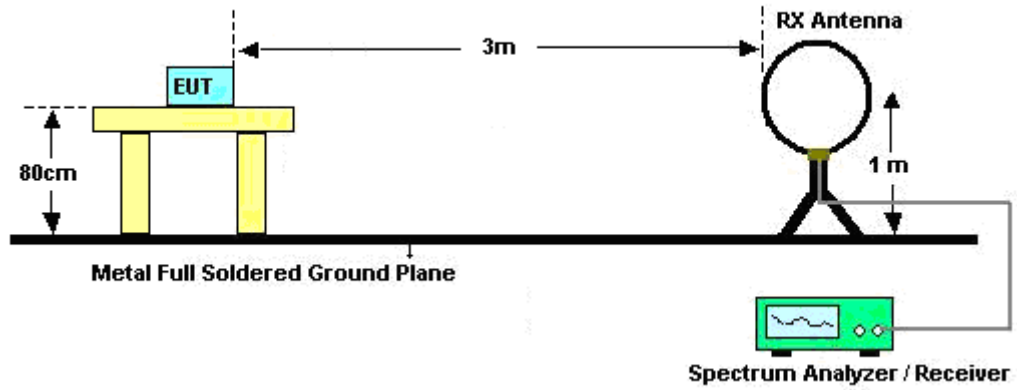

For radiated emissions from 30MHz to 1GHz

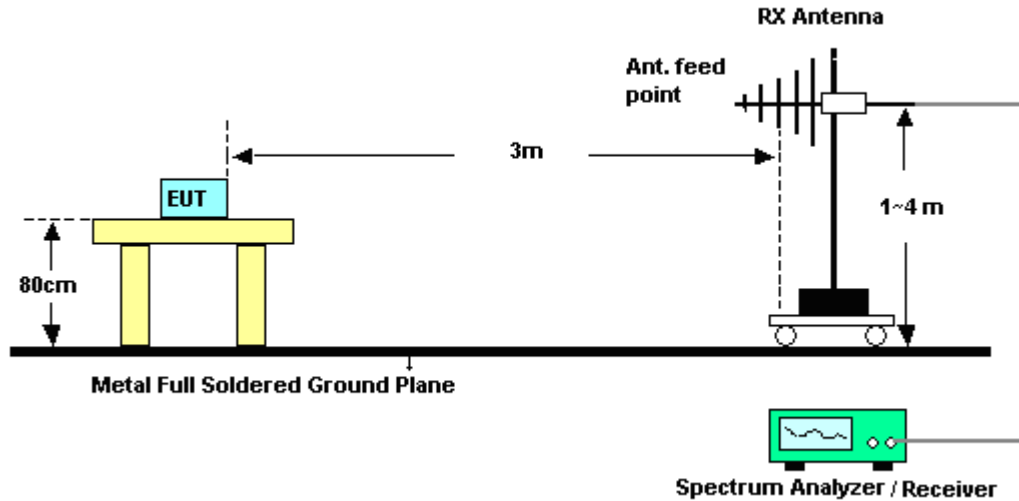

For radiated emissions above 1GHz

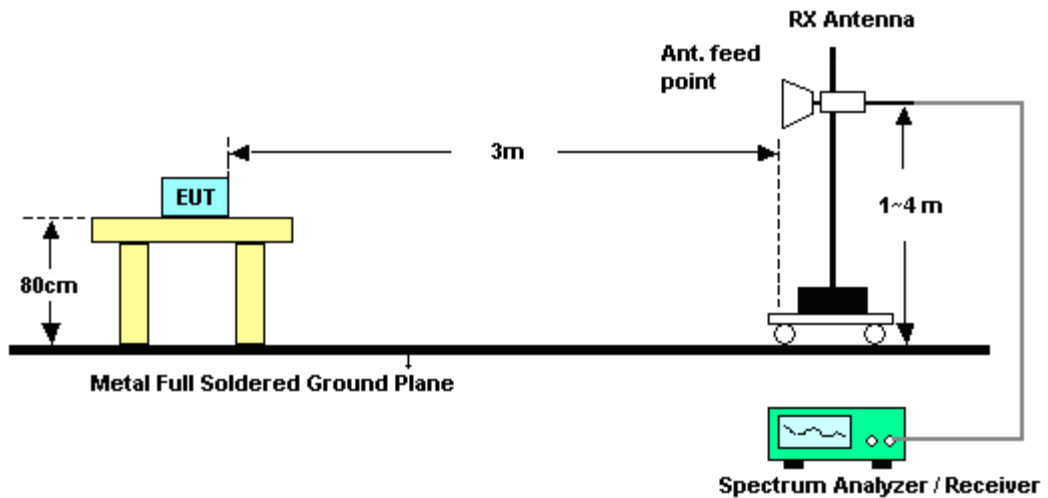

3.5.5 Test Results of Radiated Spurious Emissions (9 kHz ~ 30 MHz)

The low frequency, which started from 9 kHz to 30MHz, was pre-scanned and the result which was 20dB lower than the limit line per 15.31(o) was not reported.



3.5.6 Test Result of Radiated Spurious at Band Edges

Test Mode :	Mode 1	Temperature :	23~25°C
Test Channel :	00	Relative Humidity :	49~52%
		Test Engineer :	Gavin Zhang

ANTENNA POLARITY : HORIZONTAL										
Frequency (MHz)	Level (dBμV /m)	Over Limit (dB)	Limit Line (dBμV /m)	Read Level (dBμV)	Antenna Factor (dB)	Cable Loss (dB)	Preamp Factor (dB)	Ant Pos (cm)	Table Pos (deg)	Remark
2333.31	45.84	-28.16	74	38.06	32.05	5.53	29.8	126	7	Peak
2368.32	37.18	-16.82	54	29.28	32.1	5.59	29.79	126	7	Average

ANTENNA POLARITY : VERTICAL										
Frequency (MHz)	Level (dBμV /m)	Over Limit (dB)	Limit Line (dBμV /m)	Read Level (dBμV)	Antenna Factor (dB)	Cable Loss (dB)	Preamp Factor (dB)	Ant Pos (cm)	Table Pos (deg)	Remark
2370.03	46.09	-27.91	74	38.17	32.12	5.59	29.79	120	42	Peak
2359.68	37.18	-16.82	54	29.31	32.1	5.56	29.79	120	42	Average

Test Mode :	Mode 3	Temperature :	23~25°C
Test Channel :	39	Relative Humidity :	49~52%
		Test Engineer :	Gavin Zhang

ANTENNA POLARITY : HORIZONTAL										
Frequency (MHz)	Level (dBμV /m)	Over Limit (dB)	Limit Line (dBμV /m)	Read Level (dBμV)	Antenna Factor (dB)	Cable Loss (dB)	Preamp Factor (dB)	Ant Pos (cm)	Table Pos (deg)	Remark
2489.98	46.75	-27.25	74	38.51	32.29	5.71	29.76	105	332	Peak
2486.05	37.8	-16.2	54	29.58	32.27	5.71	29.76	105	332	Average

ANTENNA POLARITY : VERTICAL										
Frequency (MHz)	Level (dBμV /m)	Over Limit (dB)	Limit Line (dBμV /m)	Read Level (dBμV)	Antenna Factor (dB)	Cable Loss (dB)	Preamp Factor (dB)	Ant Pos (cm)	Table Pos (deg)	Remark
2490.79	46.42	-27.58	74	38.18	32.29	5.71	29.76	150	157	Peak
2499.4	37.61	-16.39	54	29.33	32.29	5.74	29.75	150	157	Average

3.5.7 Test Result of Radiated Spurious Emission (30MHz ~ 10th Harmonic)

Note: Pre-scanned all test modes and only choose the worst case mode recorded in the test report for radiated spurious emission below 1GHz.

Test Mode :	Mode 1	Temperature :	23~25°C
Test Channel :	00	Relative Humidity :	49~52%
Test Engineer :	Gavin Zhang	Polarization :	Horizontal
Remark :	1. 2402 MHz is fundamental signal which can be ignored. 2. 7206 MHz is not within a restricted band, and its limit line is 20dB below the highest emission level. For example, 94.86dBμV/m - 20dB = 74.86dBμV/m. 3. Average measurement was not performed if peak level went lower than the average limit.		

Frequency (MHz)	Level (dBμV/m)	Over Limit (dB)	Limit Line (dBμV/m)	Read Level (dBμV)	Antenna Factor (dB)	Cable Loss (dB)	Preamp Factor (dB)	Ant Pos (cm)	Table Pos (deg)	Remark
2402	94.86	-	-	86.88	32.14	5.62	29.78	126	7	Peak
2402	94.13	-	-	86.15	32.14	5.62	29.78	126	7	Average
4804	38.2	-35.8	74	53.53	33.63	8.33	57.29	120	110	Peak
7206	39.43	-35.43	74.86	51.5	35.27	9.95	57.29	132	310	Peak

Note: Other harmonics are lower than background noise.



Test Mode :	Mode 1	Temperature :	23~25°C
Test Channel :	00	Relative Humidity :	49~52%
Test Engineer :	Gavin Zhang	Polarization :	Vertical
Remark :	1. 2402 MHz is fundamental signal which can be ignored. 2. 7206 MHz is not within a restricted band, and its limit line is 20dB below the highest emission level. 3. Average measurement was not performed if peak level went lower than the average limit.		

Frequency (MHz)	Level (dBμV/m)	Over Limit (dB)	Limit Line (dBμV/m)	Read Level (dBμV)	Antenna Factor (dB)	Cable Loss (dB)	Preamp Factor (dB)	Ant Pos (cm)	Table Pos (deg)	Remark
2402	88.89	-	-	80.91	32.14	5.62	29.78	120	41	Peak
2402	88.09	-	-	80.11	32.14	5.62	29.78	120	41	Average
4804	37.61	-36.39	74	52.94	33.63	8.33	57.29	120	110	Peak
7206	38.97	-29.92	68.89	51.04	35.27	9.95	57.29	132	310	Peak

Note: Other harmonics are lower than background noise.

Test Mode :	Mode 2	Temperature :	23~25°C
Test Channel :	19	Relative Humidity :	49~52%
Test Engineer :	Gavin Zhang	Polarization :	Horizontal
Remark :	1. 2440 MHz is fundamental signal which can be ignored. 2. Average measurement was not performed if peak level went lower than the average limit.		

Frequency (MHz)	Level (dBμV/m)	Over Limit (dB)	Limit Line (dBμV/m)	Read Level (dBμV)	Antenna Factor (dB)	Cable Loss (dB)	Preamp Factor (dB)	Ant Pos (cm)	Table Pos (deg)	Remark
2440	92.68	-	-	84.58	32.22	5.65	29.77	100	170	Peak
2440	91.6	-	-	83.5	32.22	5.65	29.77	100	170	Average
4880	38.06	-35.94	74	53.02	33.8	8.41	57.17	110	245	Peak
7320	40.73	-33.27	74	52.55	35.32	10	57.14	184	225	Peak

Note: Other harmonics are lower than background noise.



Test Mode :	Mode 2	Temperature :	23~25°C
Test Channel :	19	Relative Humidity :	49~52%
Test Engineer :	Gavin Zhang	Polarization :	Vertical
Remark :	1. 2440 MHz is fundamental signal which can be ignored. 2. Average measurement was not performed if peak level went lower than the average limit.		

Frequency (MHz)	Level (dBμV/m)	Over Limit (dB)	Limit Line (dBμV/m)	Read Level (dBμV)	Antenna Factor (dB)	Cable Loss (dB)	Preamp Factor (dB)	Ant Pos (cm)	Table Pos (deg)	Remark
2440	89.5	-	-	81.4	32.22	5.65	29.77	124	208	Peak
2440	88.63	-	-	80.53	32.22	5.65	29.77	124	208	Average
4880	37.96	-36.04	74	52.92	33.8	8.41	57.17	110	245	Peak
7320	40.74	-33.26	74	52.56	35.32	10	57.14	184	225	Peak

Note: Other harmonics are lower than background noise.



Test Mode :	Mode 3	Temperature :	23~25°C
Test Channel :	39	Relative Humidity :	49~52%
Test Engineer :	Gavin Zhang	Polarization :	Horizontal
Remark :	1. 2480 MHz is fundamental signal which can be ignored. 2. Average measurement was not performed if peak level went lower than the average limit.		

Frequency (MHz)	Level (dBμV/m)	Over Limit (dB)	Limit Line (dBμV/m)	Read Level (dBμV)	Antenna Factor (dB)	Cable Loss (dB)	Preamp Factor (dB)	Ant Pos (cm)	Table Pos (deg)	Remark
265.71	30.41	-15.59	46	45.59	13.03	1.9	30.11	-	-	Peak
354.95	29.43	-16.57	46	42.24	14.85	2.16	29.82	-	-	Peak
460.68	29.76	-16.24	46	39.95	16.84	2.43	29.46	-	-	Peak
546.04	34.64	-11.36	46	42.71	18.56	2.64	29.27	100	360	Peak
583.87	33.07	-12.93	46	40.92	18.64	2.73	29.22	-	-	Peak
770.11	34.35	-11.65	46	39.82	20.4	3.1	28.97	-	-	Peak
2480	94.27	-	-	86.05	32.27	5.71	29.76	105	332	Peak
2480	93.18	-	-	84.96	32.27	5.71	29.76	105	332	Average
4960	37.69	-36.31	74	52.21	34.01	8.49	57.02	150	135	Peak
7440	40.27	-33.73	74	51.85	35.37	10.04	56.99	175	260	Peak

Note: Other harmonics are lower than background noise.



Test Mode :	Mode 3	Temperature :	23~25°C
Test Channel :	39	Relative Humidity :	49~52%
Test Engineer :	Gavin Zhang	Polarization :	Vertical
Remark :	1. 2480 MHz is fundamental signal which can be ignored. 2. Average measurement was not performed if peak level went lower than the average limit.		

Frequency (MHz)	Level (dBμV/m)	Over Limit (dB)	Limit Line (dBμV/m)	Read Level (dBμV)	Antenna Factor (dB)	Cable Loss (dB)	Preamp Factor (dB)	Ant Pos (cm)	Table Pos (deg)	Remark
188.11	24.79	-18.71	43.5	44.07	9.45	1.64	30.37	-	-	Peak
352.04	28.38	-17.62	46	41.38	14.68	2.15	29.83	-	-	Peak
454.86	28.12	-17.88	46	38.34	16.84	2.42	29.48	-	-	Peak
547.98	34.24	-11.76	46	42.14	18.72	2.65	29.27	200	360	Peak
667.29	30.32	-15.68	46	37.31	19.22	2.9	29.11	-	-	Peak
762.35	32.04	-13.96	46	37.62	20.32	3.08	28.98	-	-	Peak
2480	89.73	-	-	81.51	32.27	5.71	29.76	149	156	Peak
2480	89.08	-	-	80.86	32.27	5.71	29.76	192	360	Average
4960	39.02	-34.98	74	53.54	34.01	8.49	57.02	150	135	Peak
7440	40.7	-33.3	74	52.28	35.37	10.04	56.99	175	260	Peak

Note: Other harmonics are lower than background noise.

3.6 AC Conducted Emission Measurement

3.6.1 Limit of AC Conducted Emission

For equipment that is designed to be connected to the public utility (AC) power line, the radio frequency voltage that is conducted back onto the AC power line on any frequency or frequencies within the band 150 kHz to 30 MHz shall not exceed the limits in the following table.

Frequency of emission (MHz)	Conducted limit (dB μ V)	
	Quasi-peak	Average
0.15-0.5	66 to 56*	56 to 46*
0.5-5	56	46
5-30	60	50

*Decreases with the logarithm of the frequency.

3.6.2 Measuring Instruments

See list of measuring instruments of this test report.

3.6.3 Test Procedures

1. The EUT was placed 0.4 meter from the conducting wall of the shielding room was kept at least 80 centimeters from any other grounded conducting surface.
2. Connect EUT to the power mains through a line impedance stabilization network (LISN).
3. All the support units are connecting to the other LISN.
4. The LISN provides 50 ohm coupling impedance for the measuring instrument.
5. The FCC states that a 50 ohm, 50 microhenry LISN should be used.
6. Both sides of AC line were checked for maximum conducted interference.
7. The frequency range from 150 kHz to 30 MHz was searched.
8. Set the test-receiver system to Peak Detect Function and specified bandwidth with Maximum Hold Mode.

3.6.4 Test Setup

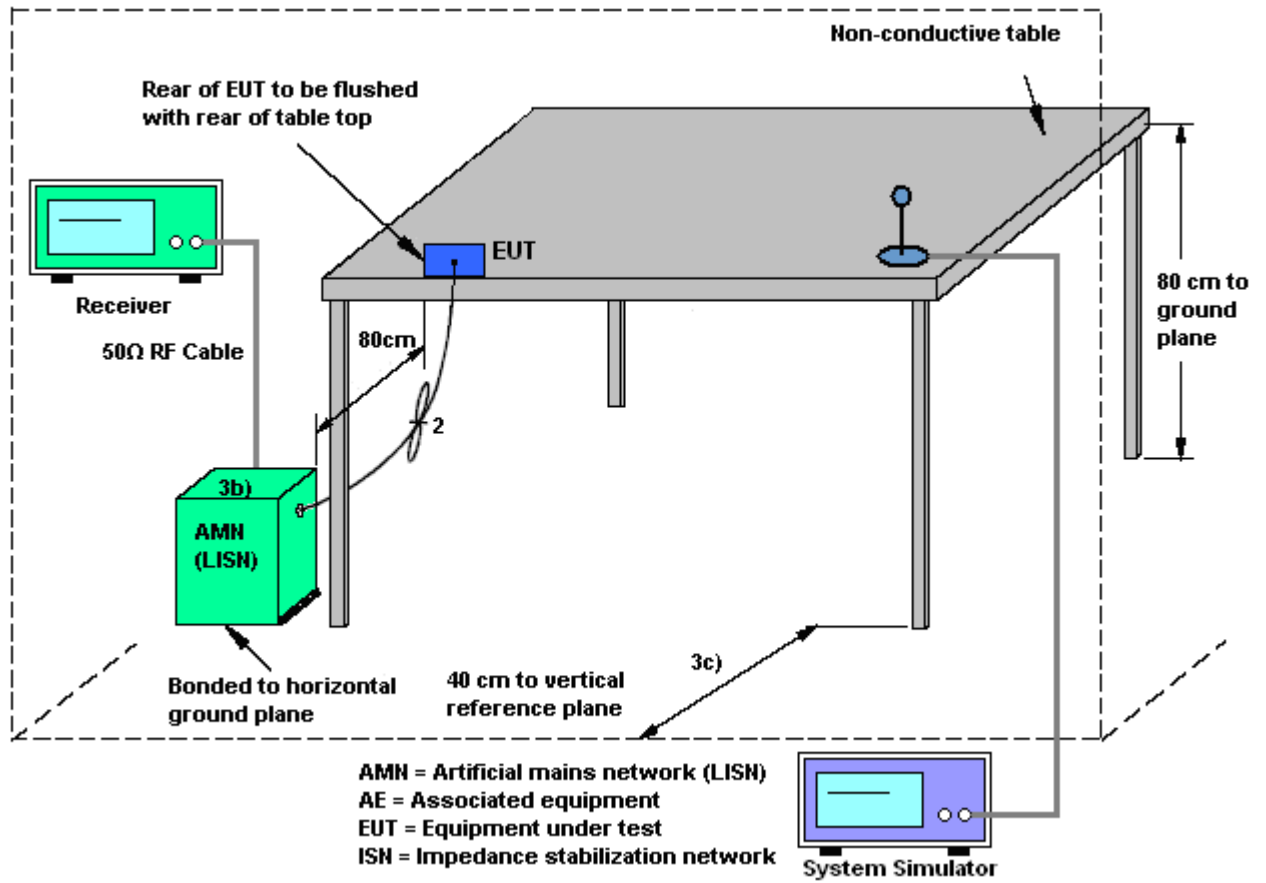



3.6.5 Test Result of AC Conducted Emission

Test Mode :	Mode 1	Temperature :	23~24°C
Test Engineer :	Henry Chen	Relative Humidity :	49~50%
Test Voltage :	120Vac / 60Hz	Phase :	Line
Function Type :	GSM1900 Idle + Bluetooth Link + WLAN (2.4GHz) Link + USB Cable (Charging from Adapter) + Earphone + NFC on + Battery 1		

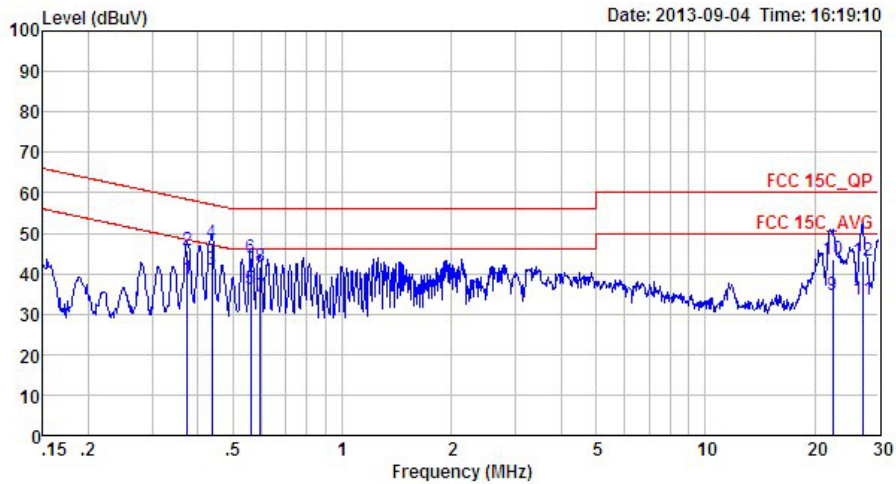

Site : CO01-SZ
 Condition: FCC 15C_QP LISN_L_20130328 LINE
 Mode : Mode 1

	Freq	Level	Over Limit	Limit Line	Read Level	LISN Factor	Cable Loss	Remark
	MHz	dBuV	dB	dBuV	dBuV	dB	dB	
1	0.38	38.79	-9.60	48.39	28.50	0.12	10.17	Average
2	0.38	45.69	-12.70	58.39	35.40	0.12	10.17	QP
3	0.44	40.99	-6.12	47.11	30.70	0.13	10.16	Average
4	0.44	47.69	-9.42	57.11	37.40	0.13	10.16	QP
5	0.56	36.00	-10.00	46.00	25.70	0.15	10.15	Average
6	0.56	43.80	-12.20	56.00	33.50	0.15	10.15	QP
7	0.59	34.40	-11.60	46.00	24.10	0.15	10.15	Average
8	0.59	41.80	-14.20	56.00	31.50	0.15	10.15	QP
9	22.42	34.65	-15.35	50.00	22.40	1.68	10.57	Average
10	22.42	43.45	-16.55	60.00	31.20	1.68	10.57	QP
11	27.13	33.72	-16.28	50.00	21.31	1.85	10.56	Average
12	27.13	43.02	-16.98	60.00	30.61	1.85	10.56	QP



Test Mode :	Mode 1	Temperature :	23~24°C
Test Engineer :	Henry Chen	Relative Humidity :	49~50%
Test Voltage :	120Vac / 60Hz	Phase :	Neutral
Function Type :	GSM1900 Idle + Bluetooth Link + WLAN (2.4GHz) Link + USB Cable (Charging from Adapter) + Earphone + NFC on + Battery 1		

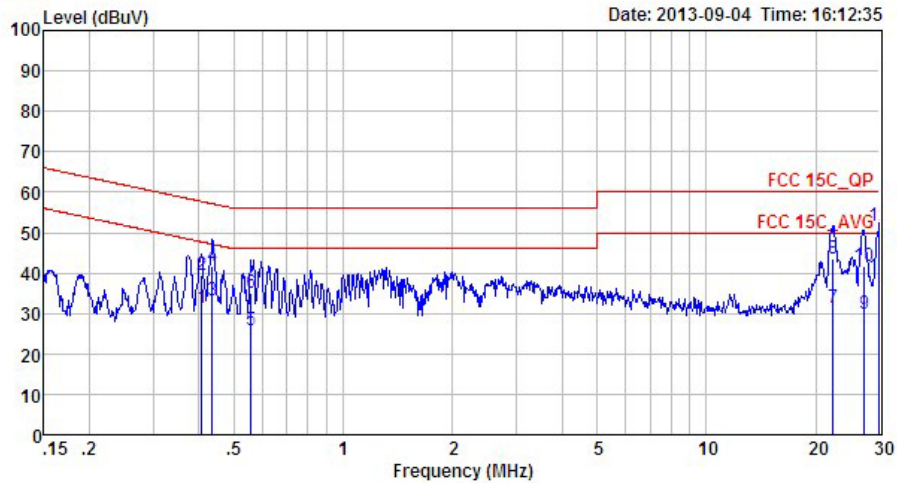

Site : CO01-SZ
 Condition: FCC 15C_QP LISN_N_20130328 NEUTRAL

Mode : Mode 1

	Freq	Level	Over Limit	Limit Line	Read Level	LISN Factor	Cable Loss	Remark
	MHz	dBuV	dB	dBuV	dBuV	dB	dB	
1	0.41	31.21	-16.47	47.68	21.00	0.04	10.17	Average
2	0.41	39.51	-18.17	57.68	29.30	0.04	10.17	QP
3	0.44	33.20	-13.95	47.15	23.00	0.04	10.16	Average
4	0.44	41.60	-15.55	57.15	31.40	0.04	10.16	QP
5	0.56	25.79	-20.21	46.00	15.60	0.04	10.15	Average
6	0.56	35.19	-20.81	56.00	25.00	0.04	10.15	QP
7	22.30	31.22	-18.78	50.00	19.70	0.95	10.57	Average
8	22.30	43.62	-16.38	60.00	32.10	0.95	10.57	QP
9	27.27	29.87	-20.13	50.00	18.10	1.20	10.57	Average
10	27.27	41.57	-18.43	60.00	29.80	1.20	10.57	QP
11	30.00	39.21	-10.79	50.00	27.20	1.38	10.63	Average
12 *	30.00	51.71	-8.29	60.00	39.70	1.38	10.63	QP



3.7 Antenna Requirements

3.7.1 Standard Applicable

If directional gain of transmitting antennas is greater than 6dBi, the power shall be reduced by the same level in dB comparing to gain minus 6dBi. The use of a permanently attached antenna or of an antenna that uses a unique coupling to the intentional radiator shall be considered sufficient to comply with the FCC rule.

3.7.2 Antenna Connected Construction

Non-standard connector used.

3.7.3 Antenna Gain

The antenna peak gain of EUT is less than 6 dBi. Therefore, it is not necessary to reduce maximum peak output power limit.



4 List of Measuring Equipment

Instrument	Manufacturer	Model No.	Serial No.	Characteristics	Calibration Date	Test Date	Due Date	Remark
Spectrum Analyzer	R&S	FSP30	101400	9kHz~30GHz	Mar. 28, 2013	Jul. 13, 2013	Mar. 27, 2014	Conducted (TH01-SZ)
Power Meter	Anritsu	ML2495A	1218010	N/A	Mar. 28, 2013	Jul. 13, 2013	Mar. 27, 2014	Conducted (TH01-SZ)
Power Sensor	Anritsu	MA2411B	1207253	N/A	Mar. 28, 2013	Jul. 13, 2013	Mar. 27, 2014	Conducted (TH01-SZ)
Spectrum Analyzer	Agilent Technologies	N9038A	MY52260185	20Hz~26.5GHz	Apr. 04, 2013	Jul.07, 2013~ Aug. 22, 2013	Apr. 03, 2014	Radiation (03CH01-SZ)
Double Ridge Horn Antenna	ETS Lindgren	3117	00119436	1GHz~18GHz	Oct. 12, 2012	Jul.07, 2013~ Aug. 22, 2013	Oct. 11, 2013	Radiation (03CH01-SZ)
Bilog Antenna	SCHAFFNER	CBL6112B	2614	30MHz ~2GHz	Nov. 03, 2012	Jul.07, 2013~ Aug. 22, 2013	Nov. 02, 2013	Radiation (03CH01-SZ)
Amplifier	ADVANTEST	BB525C	E9007003	9 kHz-3000MHz GAIN 30db	Mar. 28, 2013	Jul.07, 2013~ Aug. 22, 2013	Mar. 27, 2014	Radiation (03CH01-SZ)
Amplifier	Yiai	AV3860B	04030	2GHz~26.5GHz	Mar. 28, 2013	Aug. 22, 2013	Mar. 27, 2014	Radiation (03CH01-SZ)
SHF-EHF-Horn	Schwarzbeck	BBHA9170	BBHA9170249	14GHz ~40GHz	Nov. 23, 2012	Jul.07, 2013~ Aug. 22, 2013	Nov. 22, 2013	Radiation (03CH01-SZ)
Loop Antenna	R&S	HFH2-Z2	100321	9kHz-30MHz	Oct. 22, 2012	Jul.07, 2013~ Aug. 22, 2013	Oct. 21, 2013	Radiation (03CH01-SZ)
Turn Table	EM Electronice	EM 1000	N/A	0 ~ 360 degree	N/A	Jul.07, 2013~ Aug. 22, 2013	N/A	Radiation (03CH01-SZ)
Antenna Mast	EM Electronice	EM 1000	N/A	1 m - 4 m	N/A	Jul.07, 2013~ Aug. 22, 2013	N/A	Radiation (03CH01-SZ)
AC LISN	ETS-LINDGRE N	3816/2SH	00103912	0.1MHz~108MHz	Feb. 28, 2013	Sep. 04, 2013	Feb. 27, 2014	Conduction (CO01-SZ)
AC LISN (for auxiliary equipment)	ETS-LINDGRE N	3816/2SH	00103892	0.1MHz~108MHz	Feb. 28, 2013	Sep. 04, 2013	Feb. 27, 2014	Conduction (CO01-SZ)
ESCIO TEST Receiver	R&S	1142.8007.0 3	100724	9kHz -3GHz	Mar. 08, 2013	Sep. 04, 2013	Mar. 07, 2014	Conduction (CO01-SZ)
AC Power Source	Chroma	61602	616020000891 N/A	N/A	Oct. 12, 2012	Sep. 04, 2013	Oct. 11, 2013	Conduction (CO01-SZ)

5 Uncertainty of Evaluation

Uncertainty of Conducted Emission Measurement (150 kHz ~ 30 MHz)

Measuring Uncertainty for a Level of Confidence of 95% ($U = 2Uc(y)$)	2.26
---	------

Uncertainty of Radiated Emission Measurement (30 MHz ~ 1000 MHz)

Measuring Uncertainty for a Level of Confidence of 95% ($U = 2Uc(y)$)	2.54
---	------

Uncertainty of Radiated Emission Measurement (1 GHz ~ 40 GHz)

Measuring Uncertainty for a Level of Confidence of 95% ($U = 2Uc(y)$)	4.72
---	------