

FCC RF Test Report

APPLICANT : Yulong Computer Telecommunication Scientific
(Shenzhen) Co., Ltd.

EQUIPMENT : mobile phone

BRAND NAME : Coolpad

MODEL NAME : Coolpad 801E

FCC ID : R38YL801E

STANDARD : FCC Part 15 Subpart C §15.247

CLASSIFICATION : (DTS) Digital Transmission System

The product was received on Jan. 16, 2013 and completely tested on Jan. 25, 2013. We, SPORTON INTERNATIONAL (KUNSHAN) INC., would like to declare that the tested sample has been evaluated in accordance with the procedures and shown the compliance with the applicable technical standards.

The test results in this report apply exclusively to the tested model / sample. Without written approval of SPORTON INTERNATIONAL (KUNSHAN) INC., the test report shall not be reproduced except in full.

Reviewed by:



Jones Tsai / Manager



SPORTON INTERNATIONAL (KUNSHAN) INC.
No. 3-2, PingXiang Road, Kunshan, Jiangsu Province, P.R.C.



TABLE OF CONTENTS

REVISION HISTORY..... 3

SUMMARY OF TEST RESULT 4

1 GENERAL DESCRIPTION..... 5

 1.1 Applicant 5

 1.2 Manufacturer..... 5

 1.3 Feature of Equipment Under Test 5

 1.4 Product Specification of Equipment Under Test..... 5

 1.5 Testing Site..... 6

 1.6 Applied Standards 6

2 TEST CONFIGURATION OF EQUIPMENT UNDER TEST..... 7

 2.1 Descriptions of Test Mode..... 7

 2.2 Test Mode..... 8

 2.3 Connection Diagram of Test System..... 9

 2.4 Support Unit used in test configuration and system 10

 2.5 Description of RF Function Operation Test Setup..... 10

 2.6 Measurement Results Explanation Example..... 11

3 TEST RESULT 12

 3.1 6dB and 99% Bandwidth Measurement 12

 3.2 Peak Output Power Measurement 17

 3.3 Power Spectral Density Measurement 20

 3.4 Conducted Band Edges and Spurious Emission Measurement 26

 3.5 Radiated Band Edges and Spurious Emission Measurement 35

 3.6 AC Conducted Emission Measurement..... 46

 3.7 Antenna Requirements..... 50

4 LIST OF MEASURING EQUIPMENT..... 51

5 UNCERTAINTY OF EVALUATION..... 52

APPENDIX A. PHOTOGRAPHS OF EUT

APPENDIX B. SETUP PHOTOGRAPHS

SUMMARY OF TEST RESULT

Report Section	FCC Rule	IC Rule	Description	Limit	Result	Remark
3.1	15.247(a)(2)	RSS-210 A8.2(a)	6dB Bandwidth	$\geq 0.5\text{MHz}$	Pass	-
3.1	-	RSS-Gen 4.6.1	99% Bandwidth	-	Pass	-
3.2	15.247(b)(1)	RSS-210 A8.1(b)	Peak Output Power	$\leq 30\text{dBm}$	Pass	-
3.5	15.247(e)	RSS-210 A8.2(b)	Power Spectral Density	$\leq 8\text{dBm}$	Pass	-
3.4	15.247(d)	RSS-210 A8.5	Conducted Band Edges and Spurious Emission	$\leq 20\text{dBc}$	Pass	-
3.5	15.247(d)	RSS-210 A8.5	Radiated Band Edges and Spurious Emission	15.209(a) & 15.247(d)	Pass	Under limit 2.4 dB at 2483.500 MHz
3.6	15.207	RSS-210 Gen 7.2.2	AC Conducted Emission	15.207(a)	Pass	Under limit 8.80 dB at 0.480 MHz
3.7	15.203 & 15.247(b)	RSS-210 A8.4	Antenna Requirement	N/A	Pass	-

1 General Description

1.1 Applicant

Yulong Computer Telecommunication Scientific (Shenzhen) Co., Ltd.

Hi-Tech Industry Park(North), Nanshan District, Shenzhen City, Guangdong Province, P.R.C

1.2 Manufacturer

Yulong Computer Telecommunication Scientific (Shenzhen) Co., Ltd.

Hi-Tech Industry Park(North), Nanshan District, Shenzhen City, Guangdong Province, P.R.C

1.3 Feature of Equipment Under Test

Product Feature	
Equipment	mobile phone
Brand Name	Coolpad
Model Name	Coolpad 801E
FCC ID	R38YL801E
EUT supports Radios application	CDMA/EV-DO/ LTE/WLAN 11bgn/ Bluetooth/Bluetooth4.0 - LE
HW Version	P0
SW Version	4.1.012.P0.130105.QC1
EUT Stage	Identical Prototype

Remark: The above EUT's information was declared by manufacturer. Please refer to the specifications or user's manual for more detailed description.

1.4 Product Specification of Equipment Under Test

Product Specification subjective to this standard	
Tx/Rx Frequency Range	2402 MHz ~ 2480 MHz
Number of Channels	40
Carrier Frequency of Each Channel	2402+n*2 MHz; n=0~39
Maximum Output Power to Antenna	Bluetooth v4.0 - LE : 1.05 dBm (0.0013 W)
99% Occupied Bandwidth	Bluetooth v4.0 - LE : 1.044MHz
Antenna Type	PIFA Antenna type with gain 0.80 dBi
Type of Modulation	Bluetooth v4.0 - LE : GFSK

1.5 Testing Site

Test Site	SPORTON INTERNATIONAL (KUNSHAN) INC.			
Test Site Location	No. 3-2, PingXiang Road, Kunshan, Jiangsu Province, P.R.C. TEL: +86-0512-5790-0158 FAX: +86-0512-5790-0958			
Test Site No.	Sporton Site No.			FCC/IC Registration No.
	TH01-KS	CO01-KS	03CH01-KS	149928/4086E-1

1.6 Applied Standards

According to the specifications of the manufacturer, the EUT must comply with the requirements of the following standards:

- ♦ FCC Part 15 Subpart C §15.247
- ♦ FCC KDB Publication No. 558074 D01 DTS Meas. Guidance v02
- ♦ ANSI C63.4-2003 and ANSI C63.10-2009
- ♦ IC RSS-210 Issue 8
- ♦ IC RSS-Gen Issue 3
- ♦ NOTICE 2012-DRS0126

Remark:

1. All test items were verified and recorded according to the standards and without any deviation during the test.
2. This EUT has also been tested and complied with the requirements of FCC Part 15, Subpart B, recorded in a separate test report.
3. Per the section 2.2.3 of Notice of 2012-DRS0126, " Receivers Excluded from Industry Canada Requirements", only radio communication receivers operating in stand-alone mode within the band 30-960 MHz and scanner receivers are subject to Industry Canada requirements.

2 Test Configuration of Equipment Under Test

2.1 Descriptions of Test Mode

The RF output power was recorded in the following table:

Channel	Frequency	Bluetooth 4.0 – LE RF Output Power
		Data Rate / Modulation
		GFSK
Ch00	2402MHz	0.05 dBm
Ch19	2440MHz	1.05 dBm
Ch39	2480MHz	-1.27 dBm

- a. The EUT has been associated with peripherals pursuant to ANSI C63.4-2003 and ANSI C63.10-2009 and configuration operated in a manner tended to maximize its emission characteristics in a typical application. Frequency range investigated: conduction (150 KHz to 30 MHz), radiation (9 KHz to the 10th harmonic of the highest fundamental frequency or to 40 GHz, whichever is lower). Pre-scanned tests, X, Y, Z in three orthogonal panels to determine the final configuration (Z plane as worst plane) from all possible combinations.

- b. AC power line Conducted Emission was tested under maximum output power.

2.2 Test Mode

The following summary table is showing all test modes to demonstrate in compliance with the standard.

Summary table of Test Cases	
Test Item	Data Rate / Modulation
	Bluetooth 4.0 – LE / GFSK
Conducted TCs	Mode 1: Bluetooth Tx CH00_2402 MHz_1Mbps Mode 2: Bluetooth Tx CH19_2440 MHz_1Mbps Mode 3: Bluetooth Tx CH39_2480 MHz_1Mbps
Radiated TCs	Mode 1: Bluetooth Tx CH00_2402 MHz_1Mbps Mode 2: Bluetooth Tx CH19_2440 MHz_1Mbps Mode 3: Bluetooth Tx CH39_2480 MHz_1Mbps
AC Conducted Emission	Mode 1 :CDMA2000 BC0 Idle + Bluetooth Link + WLAN Link + USB Cable (Charging from Adapter)

2.3 Connection Diagram of Test System

<Bluetooth 4.0 – LE Tx Mode>

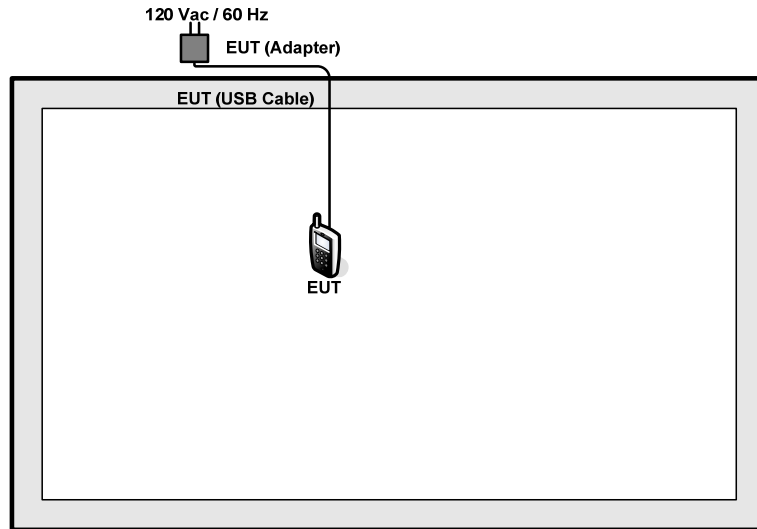

<AC Conducted Emission Mode>

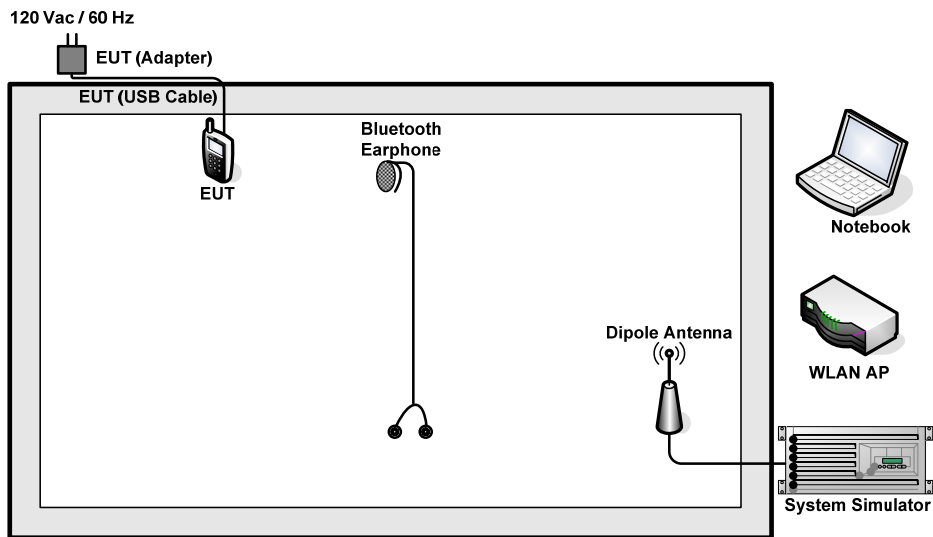

2.4 Support Unit used in test configuration and system

Item	Equipment	Trade Name	Model Name	FCC ID	Data Cable	Power Cord
1.	System Simulator	R&S	CMU 200	N/A	N/A	Unshielded, 1.8 m
2.	DC Power Supply	GWINSTEK	GPS-3030D	N/A	N/A	Unshielded, 1.8 m
3.	WLAN AP	D-Link	DIR-855	KA2DIR855A2	N/A	Unshielded, 1.8 m
4.	Notebook	DELL	P08S	QDS-BRCM1030	N/A	AC I/P: Unshielded, 0.9 m DC O/P: Shielded, 1.8 m
5.	Bluetooth Earphone	Nokia	BH-106	QTLBH-106	N/A	N/A

2.5 Description of RF Function Operation Test Setup

For Bluetooth function, programmed RF utility, "QRCT" installed in the PC make the EUT provides functions like channel selection and power level for continuous transmitting and receiving signals.



2.6 Measurement Results Explanation Example

For conducted test items:

The offset level is set in the spectrum analyzer to compensate the RF cable loss and 10dB attenuator between EUT conducted output port and spectrum analyzer. With the offset compensation, the spectrum analyzer reading level is exactly the EUT RF output level.

The spectrum analyzer offset is derived from RF cable loss and 10dB attenuator factor.

Offset = RF cable loss + attenuator factor.

Following table shows an offset computation example with cable loss 7.50 dB.

Example:

$$\begin{aligned} \text{Offset (dB)} &= \text{RF cable loss (dB)} + \text{attenuator factor (dB)} \\ &= 7.50 + 10 = 17.50 \text{ (dB)} \end{aligned}$$

3 Test Result

3.1 6dB and 99% Bandwidth Measurement

3.1.1 Limit of 6dB and 99% Bandwidth

The minimum 6 dB bandwidth shall be at least 500 KHz.

3.1.2 Measuring Instruments

See list of measuring instruments of this test report.

3.1.3 Test Procedures

1. The testing follows FCC KDB Publication No. 558074 D01 DTS Meas. Guidance v02.
2. The RF output of EUT was connected to the spectrum analyzer by RF cable and attenuator. The path loss was compensated to the results for each measurement.
3. Set to the maximum power setting and enable the EUT transmit continuously.
4. Make the measurement with the spectrum analyzer's resolution bandwidth (RBW) = 1-5% of DTS BW, not to exceed 100 KHz. Set the Video bandwidth (VBW) $\geq 3 \times$ RBW. In order to make an accurate measurement. The 6 dB bandwidth must be greater than 500 KHz.
5. Use the following spectrum analyzer settings for 99 % Bandwidth measurement.
For 99% Bandwidth measurement, the RBW=30kHz, and VBW=100kHz. Sweep = auto ;
Detector function = sample. Trace = max hold.
6. Measure and record the results in the test report.

3.1.4 Test Setup

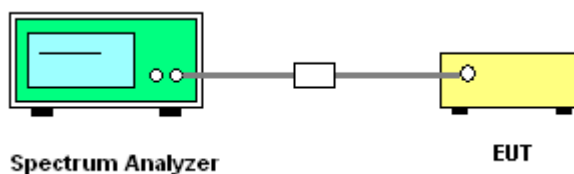

3.1.5 Test Result of 6dB Bandwidth

Test Mode :	Bluetooth 4.0 - LE	Temperature :	20~21°C
Test Engineer :	Zhi Lu	Relative Humidity :	40~41%

Channel	Frequency (MHz)	6dB Bandwidth (MHz)
00	2402	0.602
19	2440	0.600
39	2480	0.604

6 dB Bandwidth Plot on Channel 00

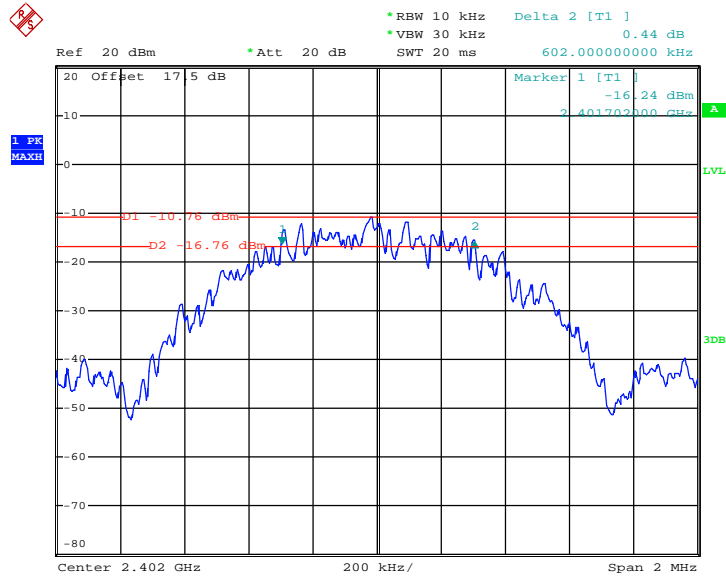

Date: 19.JAN.2013 16:21:06



6 dB Bandwidth Plot on Channel 19

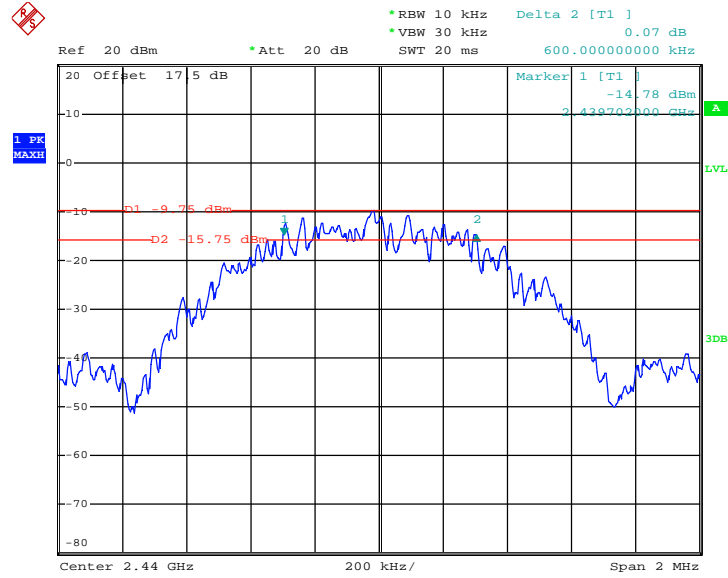

Date: 19.JAN.2013 16:22:57

6 dB Bandwidth Plot on Channel 39

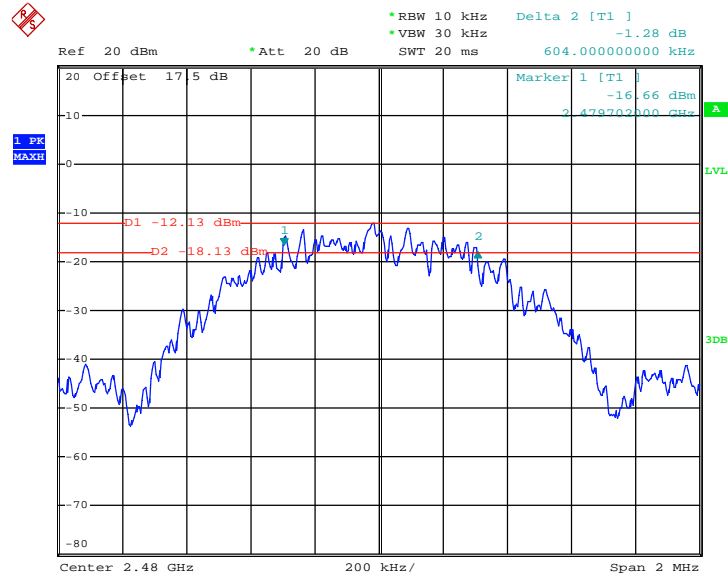

Date: 19.JAN.2013 16:24:24



3.1.6 Test Result of 99% Occupied Bandwidth

Test Mode :	Bluetooth 4.0 - LE	Temperature :	20~21°C
Test Engineer :	Zhi Lu	Relative Humidity :	40~41%

Channel	Frequency (MHz)	99% Occupied Bandwidth (MHz)
00	2402	1.044
19	2440	1.044
39	2480	1.044

99% Bandwidth Plot on Channel 00

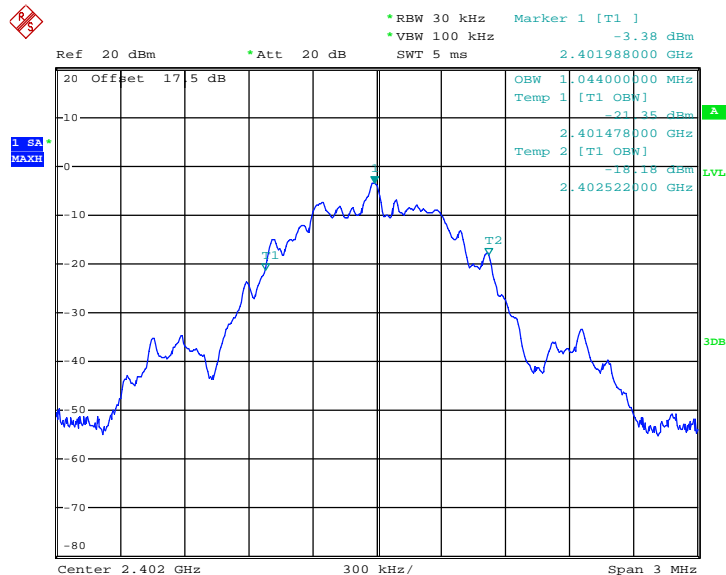

Date: 19.JAN.2013 16:30:48



99% Occupied Bandwidth Plot on Channel 19

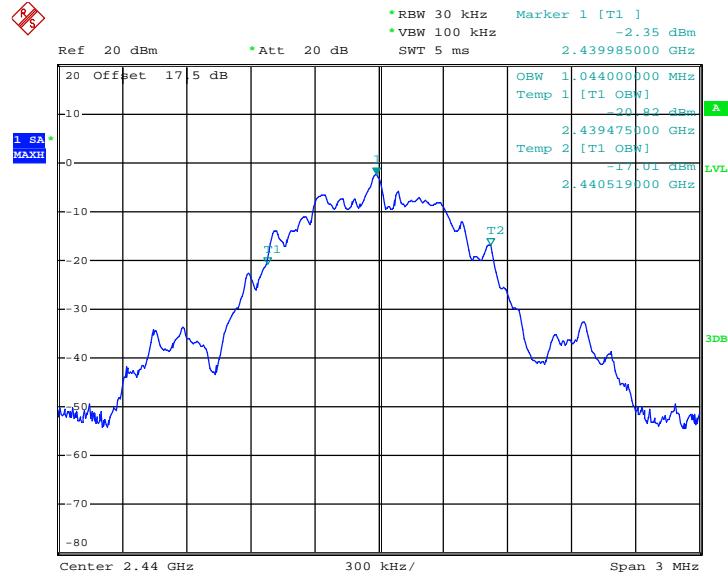

Date: 19.JAN.2013 16:31:40

99% Occupied Bandwidth Plot on Channel 39

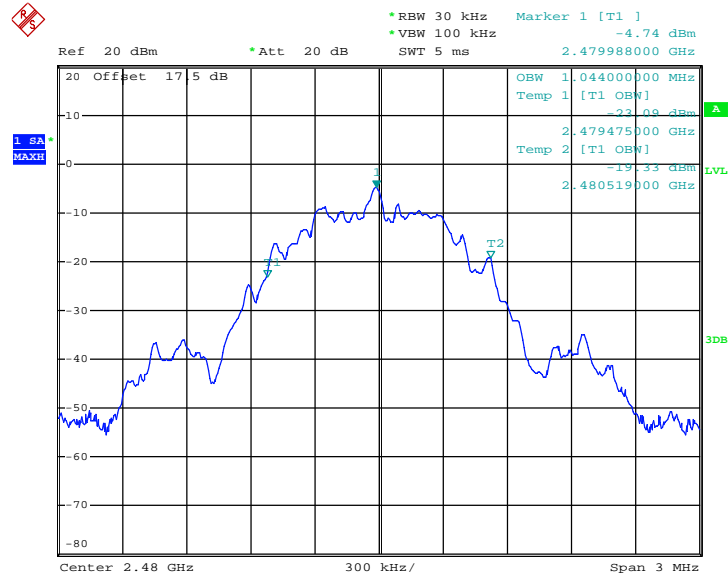

Date: 19.JAN.2013 16:32:50

3.2 Peak Output Power Measurement

3.2.1 Limit of Peak Output Power

For systems using digital modulation in the 2400-2483.5MHz, the limit for peak output power is 30dBm. If transmitting antenna of directional gain greater than 6dBi is used, the peak output power from the intentional radiator shall be reduced below the above stated value by the amount in dB that the directional gain of the antenna exceeds 6 dBi. In case of point-to-point operation, the limit has to be reduced by 1dB for every 3dB that the directional gain of the antenna exceeds 6dBi.

3.2.2 Measuring Instruments

See list of measuring instruments of this test report.

3.2.3 Test Procedures

1. The testing follows the Measurement Procedure of FCC KDB No. 558074 DTS D01 Meas. Guidance v02.
2. The RF output of EUT was connected to the spectrum analyzer by RF cable and attenuator. The path loss was compensated to the results for each measurement.
3. Set to the maximum power setting and enable the EUT transmit continuously.
4. Measure the conducted output power and record the results in the test report.

3.2.4 Test Setup

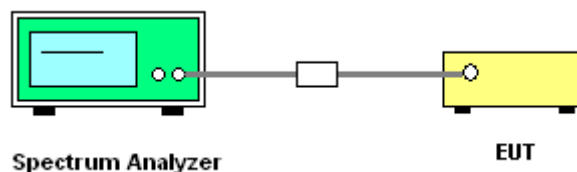



3.2.5 Test Result of Peak Output Power

Test Mode :	Bluetooth 4.0 - LE	Temperature :	20~21°C
Test Engineer :	Zhi Lu	Relative Humidity :	40~41%

Channel	Frequency (MHz)	RF Power (dBm)		
		GFSK	Max. Limits (dBm)	Pass/Fail
00	2402	0.05	30.00	Pass
19	2440	1.05	30.00	Pass
39	2480	-1.27	30.00	Pass

Peak Output Power Plot on Channel 00

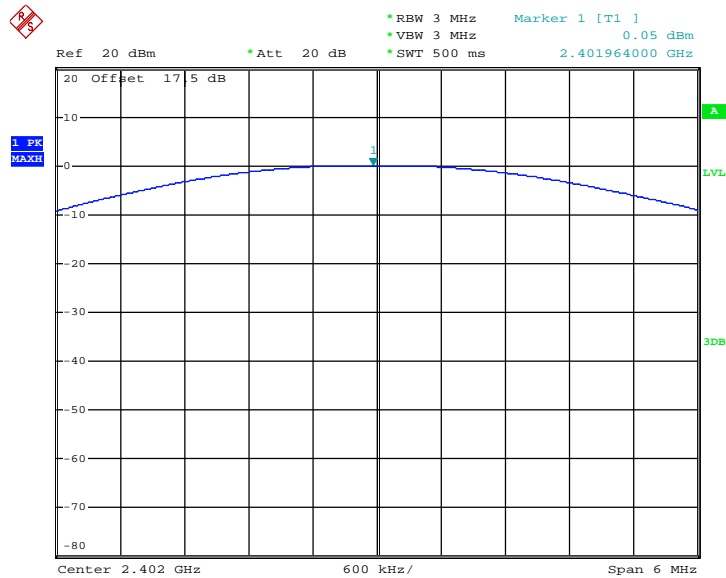

Date: 18.JAN.2013 21:14:06



Peak Output Power Plot on Channel 19

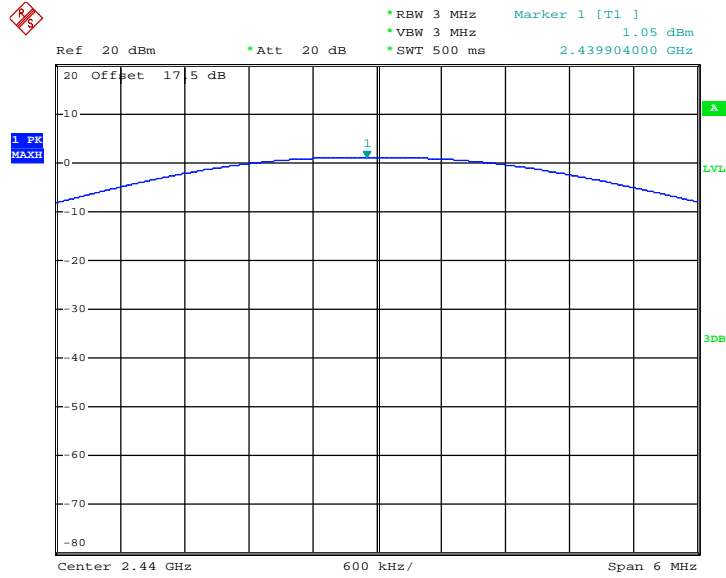

Date: 18.JAN.2013 21:13:25

Peak Output Power Plot on Channel 39

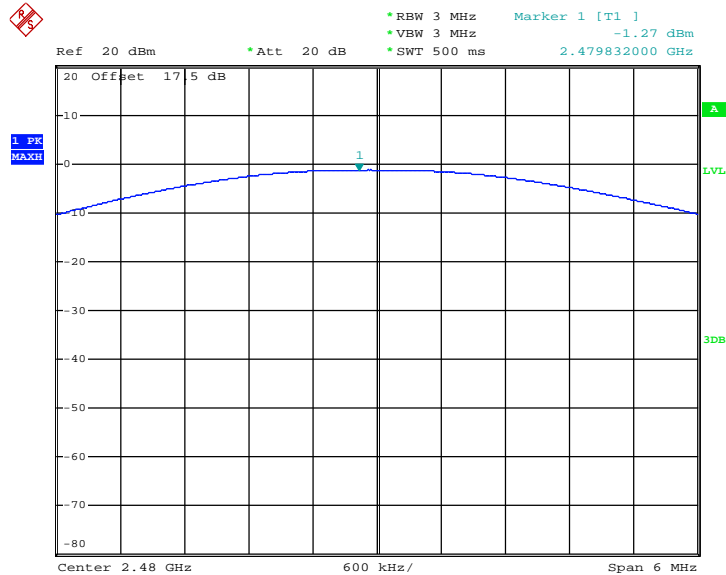

Date: 18.JAN.2013 21:14:45

3.3 Power Spectral Density Measurement

3.3.1 Limit of Power Spectral Density

The peak power spectral density shall not be greater than 8dBm in any 3KHz band at any time interval of continuous transmission.

3.3.2 Measuring Instruments

See list of measuring instruments of this test report.

3.3.3 Test Procedures

1. The testing follows Measurement Procedure 9.1 Option 1 of FCC KDB Publication No. 558074 D01 DTS Meas. Guidance v02
2. The RF output of EUT was connected to the spectrum analyzer by RF cable and attenuator. The path loss was compensated to the results for each measurement.
3. Set to the maximum power setting and enable the EUT transmit continuously.
4. Make the measurement with the spectrum analyzer's resolution bandwidth (RBW) = 3 kHz. Video bandwidth VBW = 10 kHz In order to make an accurate measurement, set the span to 1.5 times DTS Channel Bandwidth. (6dB BW)
5. Detector = peak, Sweep time = auto couple, Trace mode = max hold, Allow trace to fully stabilize. Use the peak marker function to determine the maximum power level.
6. Measure and record the results in the test report.
7. The Measured power density (dBm)/ 100KHz is a reference level and used as 20dBc down limit line for Conducted Band Edges and Conducted Spurious Emission.

3.3.4 Test Setup

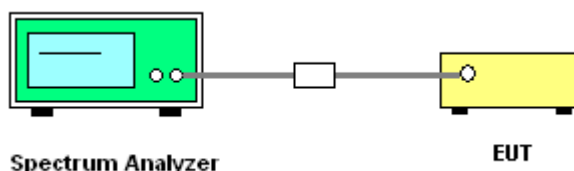

3.3.5 Test Result of Power Spectral Density

Test Mode :	Bluetooth 4.0 - LE	Temperature :	20~21°C
Test Engineer :	Zhi Lu	Relative Humidity :	40~41%

Channel	Frequency (MHz)	Power Density		Max. Limits (dBm/3KHz)	Pass/Fail
		PSD/100KHz (dBm)	PSD/3KHz (dBm)		
00	2402	-0.67	-17.74	8	Pass
19	2440	0.34	-16.77	8	Pass
39	2480	-2.02	-19.17	8	Pass

Note:

1. Measured power density (dBm) has offset with cable loss.
2. The Measured power density (dBm)/ 100KHz is reference level and used as 20dBc down for Conducted Band Edges and Conducted Spurious Emission limit line.



3.3.6 Test Result of Power Spectral Density Plots (100kHz)

PSD 100kHz Plot on Channel 00

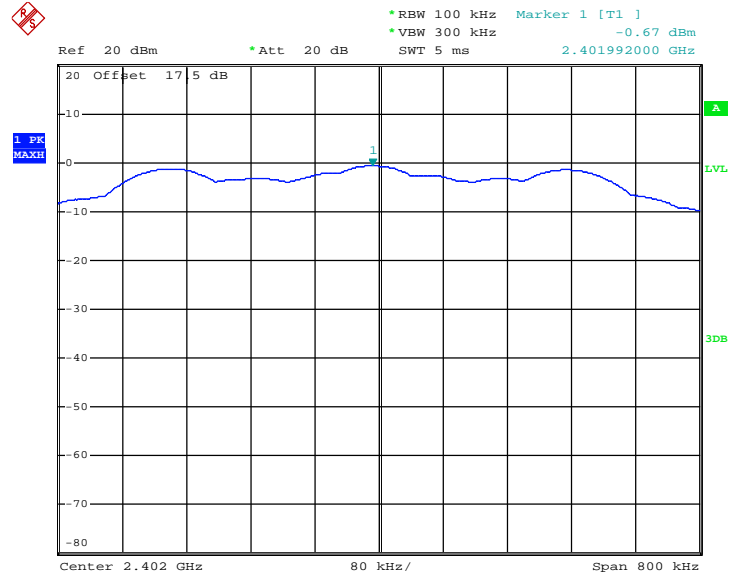

Date: 19.JAN.2013 16:29:11



PSD 100kHz Plot on Channel 19

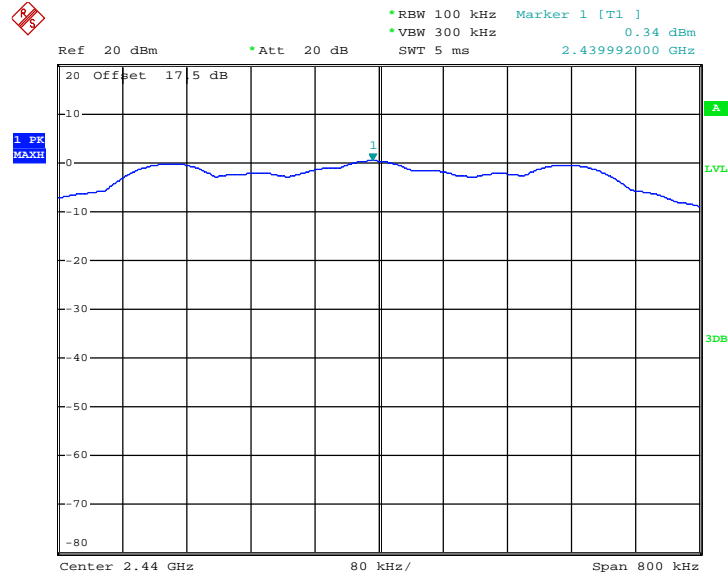

Date: 19.JAN.2013 16:28:27

PSD 100kHz Plot on Channel 39

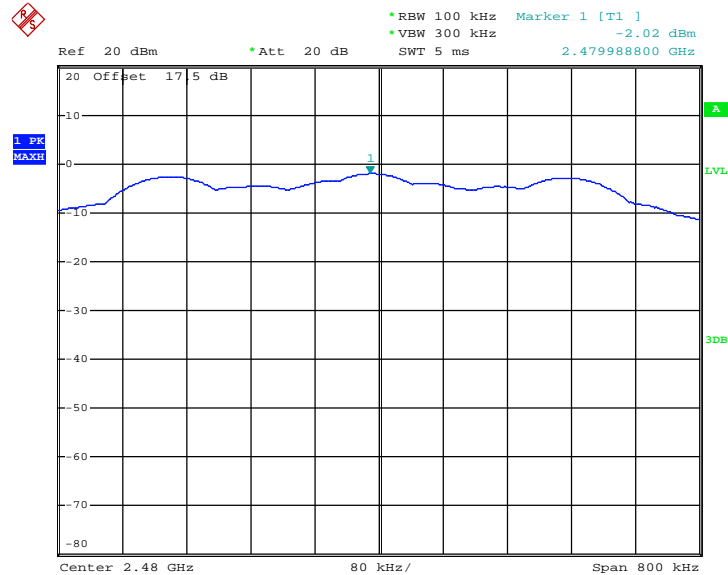

Date: 19.JAN.2013 16:27:07



3.3.7 Test Result of Power Spectral Density Plots (3kHz)

PSD 3kHz Plot on Channel 00

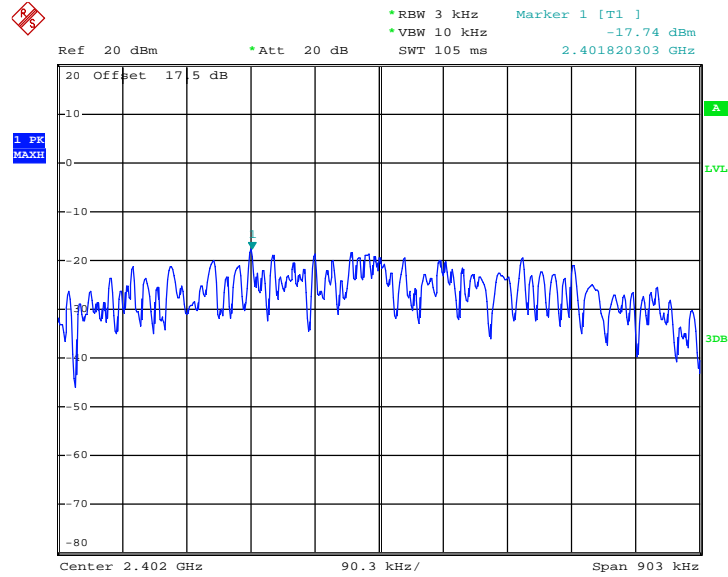

Date: 19.JAN.2013 16:41:53



PSD 3kHz Plot on Channel 19

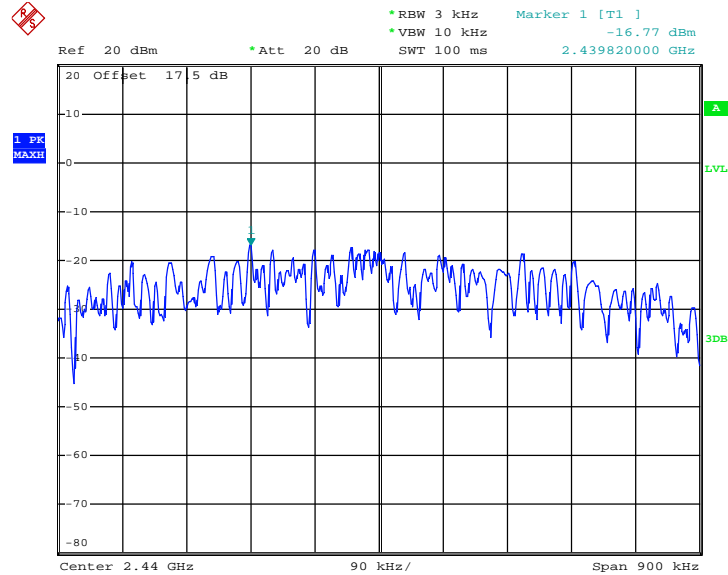

Date: 19.JAN.2013 16:40:25

PSD 3kHz Plot on Channel 39

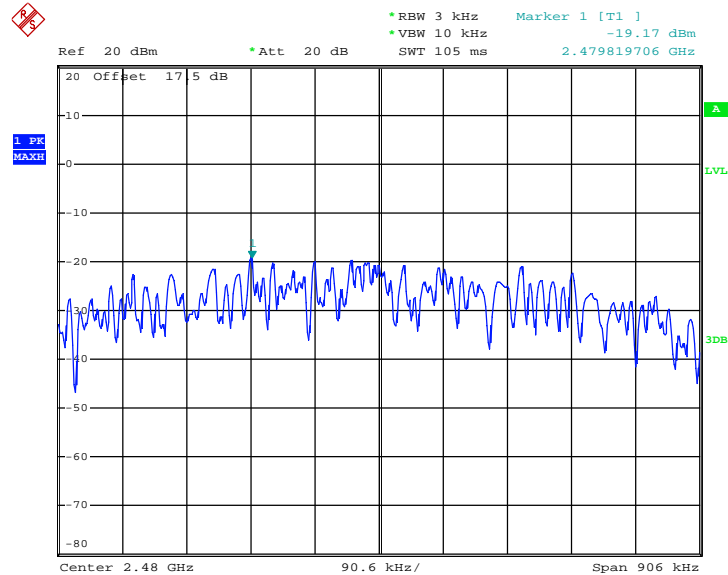

Date: 19.JAN.2013 16:39:11

3.4 Conducted Band Edges and Spurious Emission Measurement

3.4.1 Limit of Conducted Band Edges and Spurious Emission

All harmonics/spurious must be at least 20 dB down from the highest emission level within the authorized band.

3.4.2 Measuring Instruments

See list of measuring instruments of this test report.

3.4.3 Test Procedure

1. The testing follows FCC KDB Publication No. 558074 D01 DTS Meas. Guidance v02.
2. The RF output of EUT was connected to the spectrum analyzer by RF cable and attenuator. The path loss was compensated to the results for each measurement.
3. Set to the maximum power setting and enable the EUT transmit continuously.
4. Set RBW = 100 KHz, VBW=300 KHz, Peak Detector. Unwanted Emissions measured in any 100 kHz bandwidth outside of the authorized frequency band shall be attenuated by at least 20 dB relative to the maximum in-band peak PSD level in 100 kHz when maximum peak conducted output power procedure is used. If the transmitter complies with the conducted power limits based on the use of RMS averaging over a time interval, the attenuation required under this paragraph shall be 30 dB instead of 20 dB per 15.247(d).
5. Measure and record the results in the test report.
6. The RF fundamental frequency should be excluded against the limit line in the operating frequency band.

3.4.4 Test Setup

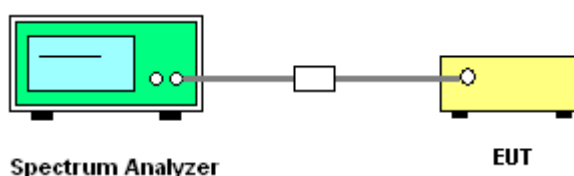



3.4.5 Test Result of Conducted Band Edges

Test Mode :	Bluetooth 4.0 - LE	Temperature :	20~21°C
Test Channel :	00 and 39	Relative Humidity :	40~41%
		Test Engineer :	Zhi Lu

Low Band Edge Plot on Channel 00

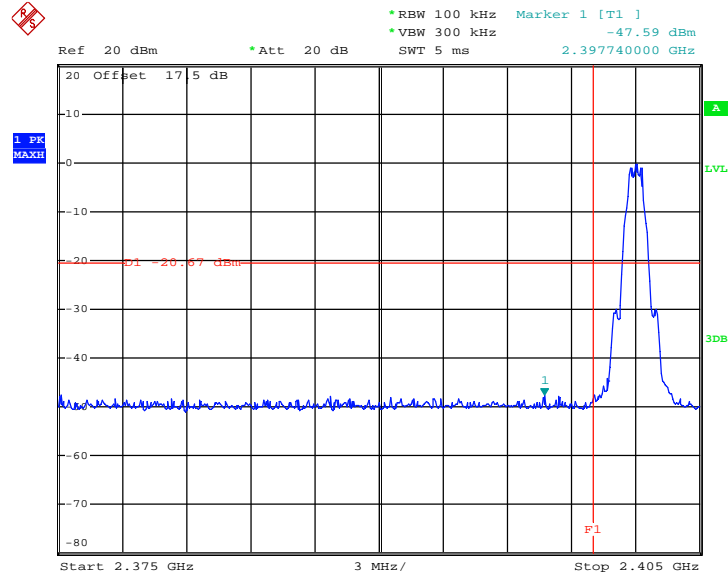

Date: 19.JAN.2013 16:55:21



High Band Edge Plot on Channel 39

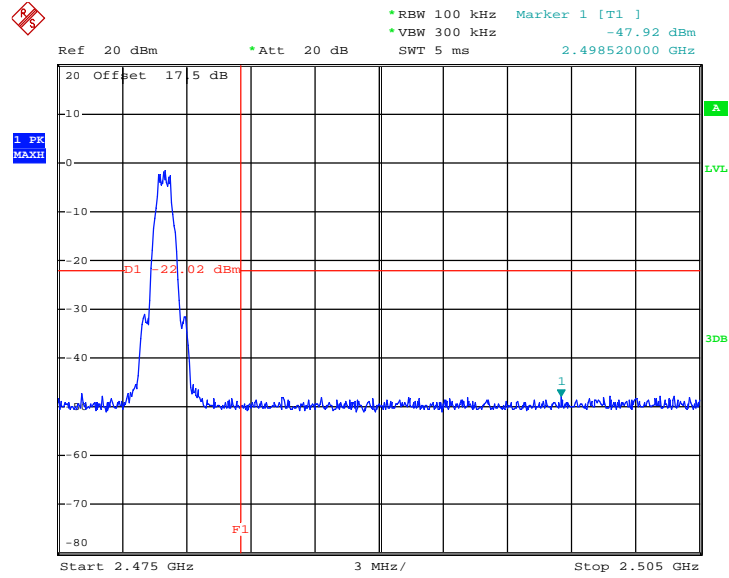

Date: 19.JAN.2013 16:51:39



Conducted Spurious Emission Plot on Bluetooth LE
GFSK Channel 00

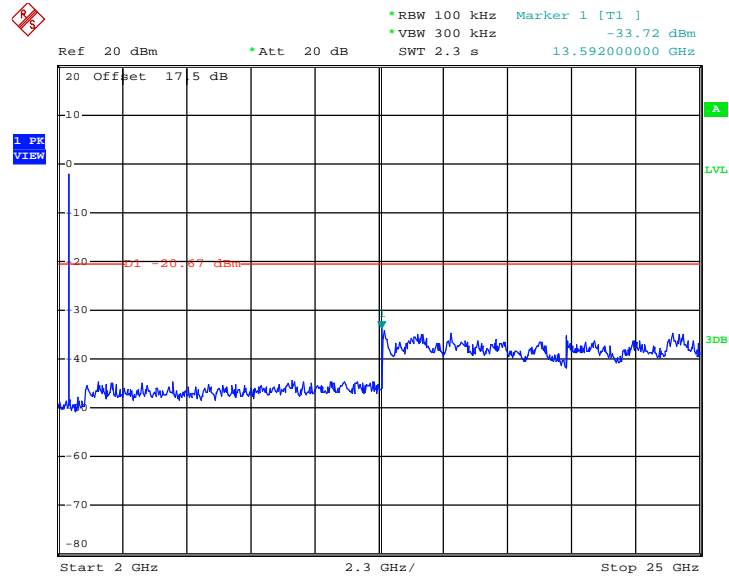

Date: 19.JAN.2013 16:44:16



Test Mode :	Bluetooth 4.0 - LE	Temperature :	20~21°C
Test Channel :	19	Relative Humidity :	40~41%
		Test Engineer :	Zhi Lu

Conducted Spurious Emission Plot on Bluetooth LE
GFSK Channel 19

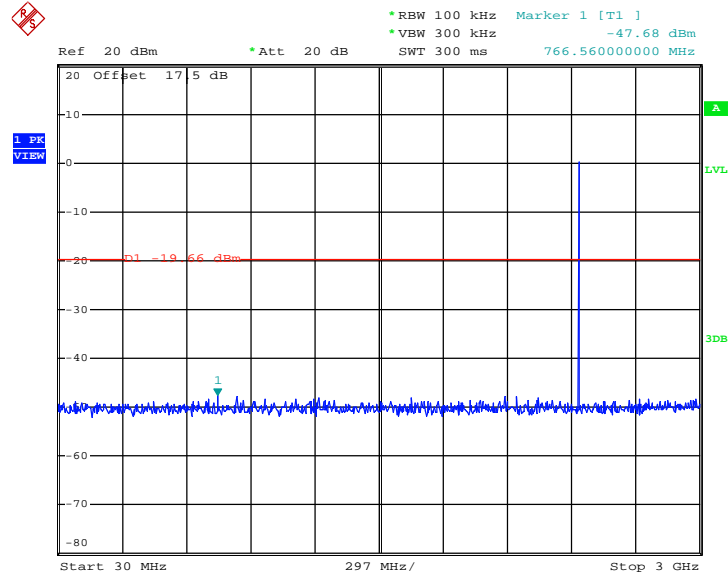

Date: 19.JAN.2013 16:45:24



Conducted Spurious Emission Plot on Bluetooth LE GFSK Channel 19

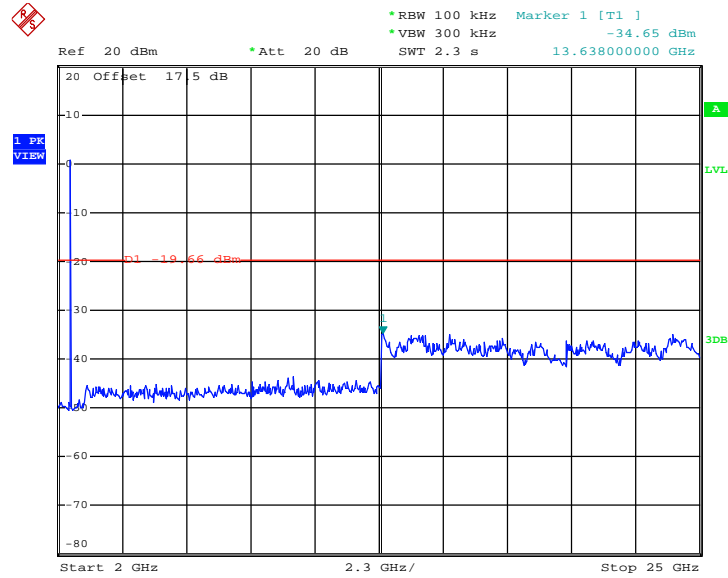

Date: 19.JAN.2013 16:46:08



Test Mode :	Bluetooth 4.0 - LE	Temperature :	20~21°C
Test Channel :	39	Relative Humidity :	40~41%
		Test Engineer :	Zhi Lu

Conducted Spurious Emission Plot on Bluetooth LE
GFSK Channel 39

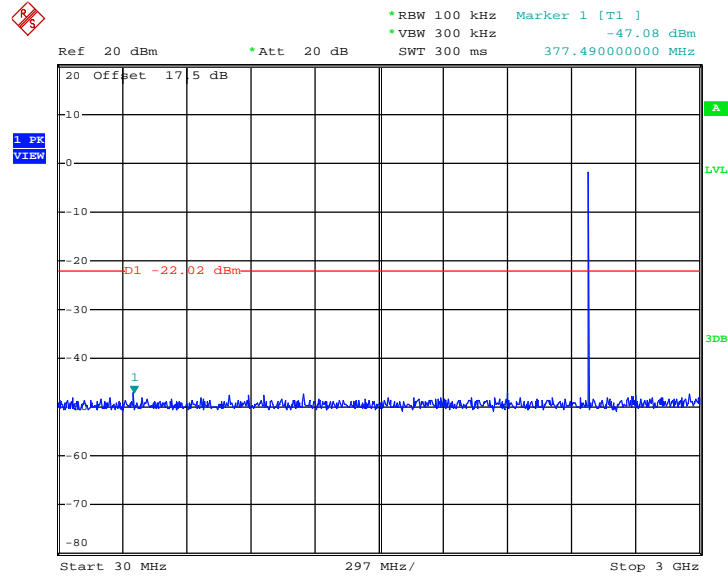

Date: 19.JAN.2013 16:48:01



Conducted Spurious Emission Plot on Bluetooth LE GFSK Channel 39

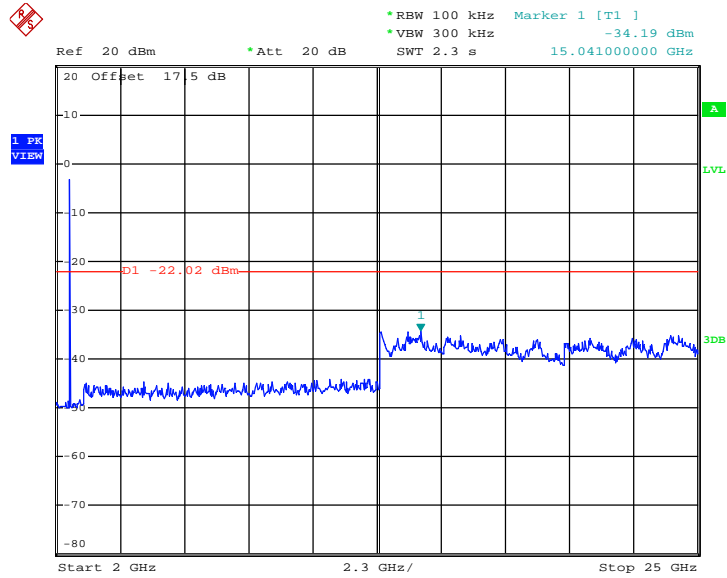

Date: 19.JAN.2013 16:49:00

3.5 Radiated Band Edges and Spurious Emission Measurement

3.5.1 Limit of Radiated Band Edges and Spurious Emission

In any 100 KHz bandwidth outside the intentional radiator frequency band, all harmonics/spurious must be at least 20 dB below the highest emission level within the authorized band. If the output power of this device was measured by spectrum analyzer, the attenuation under this paragraph shall be 30 dB instead of 20 dB. In addition, radiated emissions which fall in the restricted bands must also comply with the FCC section 15.209 limits as below.

Frequency (MHz)	Field Strength (microvolts/meter)	Measurement Distance (meters)
0.009 – 0.490	2400/F(kHz)	300
0.490 – 1.705	24000/F(kHz)	30
1.705 – 30.0	30	30
30 – 88	100	3
88 – 216	150	3
216 - 960	200	3
Above 960	500	3

3.5.2 Measuring Instruments

See list of measuring instruments of this test report.

3.5.3 Test Procedures

1. The testing follows the guidelines in ANSI C63.10-2009 and ANSI C63.4-2003 test site requirement.
2. The EUT was arranged to its worst case and then tune the antenna tower (from 1 m to 4 m) and turntable (from 0 degree to 360 degrees) to find the maximum reading. A pre-amp and a high pass filter are used for the test in order to get better signal level.
3. The EUT was placed on a turntable with 0.8 meter above ground.
4. The EUT was set 3 meters from the interference receiving antenna, which was mounted on the top of a variable height antenna tower.
5. Corrected Reading: Antenna Factor + Cable Loss + Read Level - Preamp Factor = Level
6. For measurement below 1GHz, If the emission level of the EUT measured by the peak detector is 3 dB lower than the applicable limit, the peak emission level will be reported. Otherwise, the emission measurement will be repeated using the quasi-peak detector and reported.
7. Use the following spectrum analyzer settings:
 - (1) Span shall wide enough to fully capture the emission being measured;
 - (2) Set RBW=100 KHz for $f < 1$ GHz; $VBW \geq RBW$; Sweep = auto; Detector function = peak; Trace = max hold;
 - (3) Set RBW = 1 MHz, VBW= 3MHz for $f \geq 1$ GHz for peak measurement.

For average measurement:

 - $VBW = 10$ Hz, when duty cycle is no less than 98 percent.
 - $VBW \geq 1/T$, when duty cycle is less than 98 percent where T is the minimum transmission duration over which the transmitter is on and is transmitting at its maximum power control level for the tested mode of operation.

Band	Duty Cycle(%)	T(ms)	1/T(KHz)	VBW Setting
Bluetooth 4.0 - LE	32.484	0.204	4.902	10KHz

Note: For average measurement with duty cycle < 98%, use reduced VBW measurement method 4.2.3.2.3 in ANSI C63.10.

3.5.4 Test Setup

For radiated emissions below 30MHz

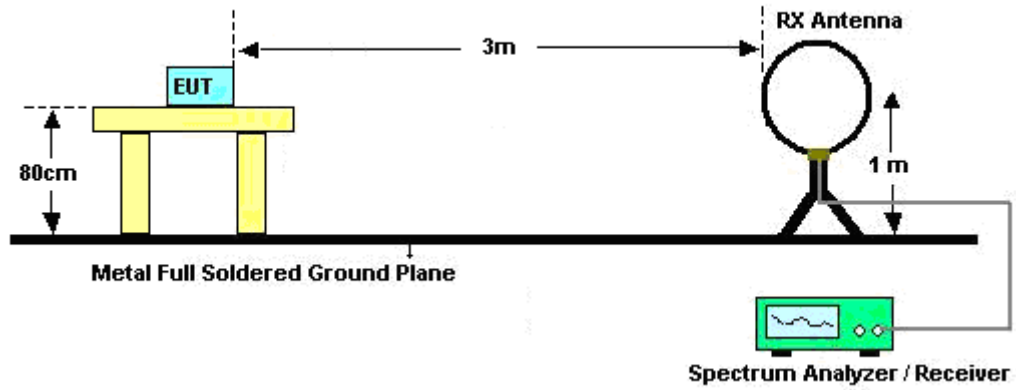

For radiated emissions from 30MHz to 1GHz

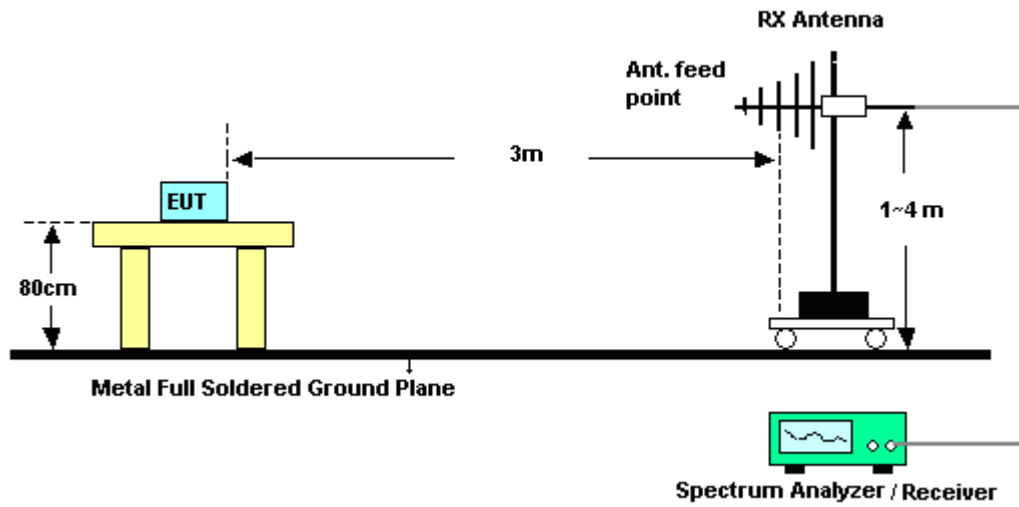

For radiated emissions above 1GHz

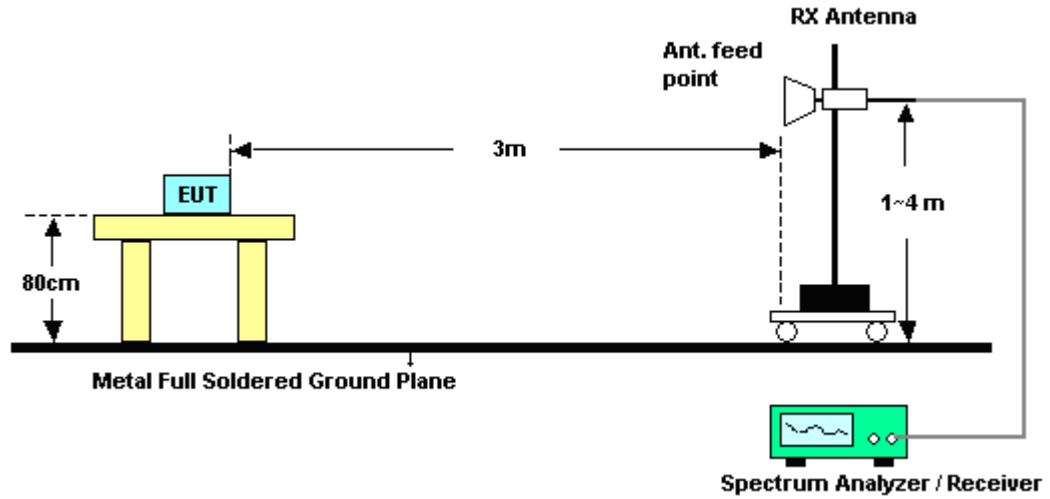

3.5.5 Test Results of Radiated Emissions (9 kHz ~ 30 MHz)

The low frequency, which started from 9 KHz to 30MHz, was pre-scanned and the result which was 20dB lower than the limit line per 15.31(o) was not reported.



3.5.6 Test Result of Radiated Band Edges

Test Mode :	Mode 1	Temperature :	21~22°C
Test Channel :	00	Relative Humidity :	41~43%
		Test Engineer :	Steven Hao

ANTENNA POLARITY : HORIZONTAL										
Frequency (MHz)	Level (dBuV/m)	Over Limit (dB)	Limit Line (dBuV/m)	Read Level (dBuV)	Antenna Factor (dB)	Cable Loss (dB)	Preamp Factor (dB)	Ant Pos (cm)	Table Pos (deg)	Remark
2383.35	47.01	-26.99	74	43.6	32.83	2.09	31.51	100	360	Peak
2381.46	35.64	-18.36	54	32.23	32.83	2.09	31.51	100	360	Average

ANTENNA POLARITY : VERTICAL										
Frequency (MHz)	Level (dBuV/m)	Over Limit (dB)	Limit Line (dBuV/m)	Read Level (dBuV)	Antenna Factor (dB)	Cable Loss (dB)	Preamp Factor (dB)	Ant Pos (cm)	Table Pos (deg)	Remark
2379.84	47.16	-26.84	74	43.75	32.83	2.09	31.51	100	360	Peak
2390.46	35.65	-18.35	54	32.19	32.86	2.11	31.51	100	360	Average

Test Mode :	Mode 3	Temperature :	21~22°C
Test Channel :	39	Relative Humidity :	41~43%
		Test Engineer :	Steven Hao

ANTENNA POLARITY : HORIZONTAL										
Frequency (MHz)	Level (dBuV/m)	Over Limit (dB)	Limit Line (dBuV/m)	Read Level (dBuV)	Antenna Factor (dB)	Cable Loss (dB)	Preamp Factor (dB)	Ant Pos (cm)	Table Pos (deg)	Remark
2483.5	57.2	-16.8	74	53.54	33.01	2.16	31.51	100	353	Peak
2483.5	51.6	-2.4	54	47.94	33.01	2.16	31.51	100	353	Average

ANTENNA POLARITY : VERTICAL										
Frequency (MHz)	Level (dBuV/m)	Over Limit (dB)	Limit Line (dBuV/m)	Read Level (dBuV)	Antenna Factor (dB)	Cable Loss (dB)	Preamp Factor (dB)	Ant Pos (cm)	Table Pos (deg)	Remark
2483.5	53.75	-20.25	74	50.09	33.01	2.16	31.51	128	91	Peak
2483.5	50.16	-3.84	54	46.5	33.01	2.16	31.51	128	91	Average



3.5.7 Test Result of Radiated Emission (30 MHz ~ 10th Harmonic)

NOTE: Below 1GHz for radiated emission measurement, pre-scanned all test modes and only choose the worst case mode was recorded in the report.

Test Mode :	Mode 1	Temperature :	21~22°C
Test Channel :	00	Relative Humidity :	41~43%
Test Engineer :	Steven Hao	Polarization :	Horizontal
Remark :	1. 2402 MHz is fundamental signal which can be ignored. 2. 2399 MHz and 7206 MHz is not within a restricted band, and its limit line is 20dB below the highest emission level. 3. Average measurement was not performed if peak level went lower than the average limit.		

Frequency (MHz)	Level (dBuV/m)	Over Limit (dB)	Limit Line (dBuV/m)	Read Level (dBuV)	Antenna Factor (dB)	Cable Loss (dB)	Preamp Factor (dB)	Ant Pos (cm)	Table Pos (deg)	Remark
2399	54	-18.47	72.47	50.54	32.86	2.11	31.51	100	360	Peak
2402	92.47	-	-	89.01	32.86	2.11	31.51	128	62	Peak
2402	91.17	-	-	87.71	32.86	2.11	31.51	128	62	Average
4804	50.74	-23.26	74	44.03	35.17	3.08	31.54	100	0	Peak
7206	50.84	-21.63	72.47	42.4	36.16	3.24	30.96	100	0	Peak



Test Mode :	Mode 1	Temperature :	21~22°C
Test Channel :	00	Relative Humidity :	41~43%
Test Engineer :	Steven Hao	Polarization :	Vertical
Remark :	1. 2402 MHz is fundamental signal which can be ignored. 2. 2399 MHz and 7206 MHz is not within a restricted band, and its limit line is 20dB below the highest emission level. 3. Average measurement was not performed if peak level went lower than the average limit.		

Frequency (MHz)	Level (dBuV/m)	Over Limit (dB)	Limit Line (dBuV/m)	Read Level (dBuV)	Antenna Factor (dB)	Cable Loss (dB)	Preamp Factor (dB)	Ant Pos (cm)	Table Pos (deg)	Remark
2399	51.96	-18.06	70.02	48.5	32.86	2.11	31.51	100	360	Peak
2402	90.02	-	-	86.56	32.86	2.11	31.51	165	92	Peak
2402	89.31	-	-	85.85	32.86	2.11	31.51	165	92	Average
4804	49.93	-24.07	74	43.22	35.17	3.08	31.54	100	0	Peak
7206	51.64	-18.38	70.02	43.2	36.16	3.24	30.96	100	360	Peak



Test Mode :	Mode 2	Temperature :	21~22°C
Test Channel :	19	Relative Humidity :	41~43%
Test Engineer :	Steven Hao	Polarization :	Horizontal
Remark :	1. 2440 MHz is fundamental signal which can be ignored. 2. Average measurement was not performed if peak level went lower than the average limit.		

Frequency (MHz)	Level (dBuV/m)	Over Limit (dB)	Limit Line (dBuV/m)	Read Level (dBuV)	Antenna Factor (dB)	Cable Loss (dB)	Preamp Factor (dB)	Ant Pos (cm)	Table Pos (deg)	Remark
2440	95.61	-	-	92.03	32.95	2.14	31.51	100	226	Peak
2440	94.01	-	-	90.43	32.95	2.14	31.51	100	226	Average
4880	49.79	-24.21	74	43.01	35.18	3.12	31.52	100	0	Peak
7320	51.72	-22.28	74	43.24	36.21	3.21	30.94	100	360	Peak



Test Mode :	Mode 2	Temperature :	21~22°C
Test Channel :	19	Relative Humidity :	41~43%
Test Engineer :	Steven Hao	Polarization :	Vertical
Remark :	1. 2440 MHz is fundamental signal which can be ignored. 2. Average measurement was not performed if peak level went lower than the average limit.		

Frequency (MHz)	Level (dBuV/m)	Over Limit (dB)	Limit Line (dBuV/m)	Read Level (dBuV)	Antenna Factor (dB)	Cable Loss (dB)	Preamp Factor (dB)	Ant Pos (cm)	Table Pos (deg)	Remark
2440	91.26	-	-	87.68	32.95	2.14	31.51	100	316	Peak
2440	90.03	-	-	86.45	32.95	2.14	31.51	100	316	Average
4880	50.97	-23.03	74	44.19	35.18	3.12	31.52	100	360	Peak
7320	52.87	-21.13	74	44.39	36.21	3.21	30.94	100	360	Peak



Test Mode :	Mode 3	Temperature :	21~22°C
Test Channel :	39	Relative Humidity :	41~43%
Test Engineer :	Steven Hao	Polarization :	Horizontal
Remark :	1. 2480 MHz is fundamental signal which can be ignored. 2. Average measurement was not performed if peak level went lower than the average limit.		

Frequency (MHz)	Level (dBuV/m)	Over Limit (dB)	Limit Line (dBuV/m)	Read Level (dBuV)	Antenna Factor (dB)	Cable Loss (dB)	Preamp Factor (dB)	Ant Pos (cm)	Table Pos (deg)	Remark
31.071	18.01	-21.99	40	33.96	17.29	0.34	33.58	-	-	Peak
284.977	23.85	-22.15	46	43.51	12.76	0.97	33.39	-	-	Peak
365.539	25.61	-20.39	46	42.97	14.88	1.11	33.35	-	-	Peak
670.489	27.23	-18.77	46	39.63	19.05	1.47	32.92	-	-	Peak
771.449	29.73	-16.27	46	40.96	19.88	1.61	32.72	100	0	Peak
866.088	28.23	-17.77	46	38.72	20.49	1.67	32.65	-	-	Peak
2480	94.18	-	-	90.52	33.01	2.16	31.51	100	360	Peak
2480	92.98	-	-	89.32	33.01	2.16	31.51	100	360	Average
4960	50.06	-23.94	74	43.21	35.2	3.16	31.51	100	0	Peak
7440	52.19	-21.81	74	43.66	36.27	3.18	30.92	100	360	Peak



Test Mode :	Mode 3	Temperature :	21~22°C
Test Channel :	39	Relative Humidity :	41~43%
Test Engineer :	Steven Hao	Polarization :	Vertical
Remark :	1. 2480 MHz is fundamental signal which can be ignored. 2. Average measurement was not performed if peak level went lower than the average limit.		

Frequency (MHz)	Level (dBuV/m)	Over Limit (dB)	Limit Line (dBuV/m)	Read Level (dBuV)	Antenna Factor (dB)	Cable Loss (dB)	Preamp Factor (dB)	Ant Pos (cm)	Table Pos (deg)	Remark
45.058	22.72	-17.28	40	46.67	9.25	0.41	33.61	-	-	Peak
52.025	22.59	-17.41	40	48.71	7.01	0.45	33.58	-	-	Peak
101.289	20.67	-22.83	43.5	43.08	10.62	0.58	33.61	-	-	Peak
640.611	31.38	-14.62	46	44.03	18.85	1.45	32.95	100	234	Peak
670.489	31.47	-14.53	46	43.87	19.05	1.47	32.92	-	-	Peak
945.44	26.1	-19.9	46	36.08	20.71	1.75	32.44	-	-	Peak
2480	91.63	-	-	87.97	33.01	2.16	31.51	100	156	Peak
2480	90.26	-	-	86.6	33.01	2.16	31.51	100	156	Average
4960	50.4	-23.6	74	43.55	35.2	3.16	31.51	100	360	Peak
7440	52.26	-21.74	74	43.73	36.27	3.18	30.92	-	-	Peak

3.6 AC Conducted Emission Measurement

3.6.1 Limit of AC Conducted Emission

For equipment that is designed to be connected to the public utility (AC) power line, the radio frequency voltage that is conducted back onto the AC power line on any frequency or frequencies within the band 150 kHz to 30 MHz shall not exceed the limits in the following table.

Frequency of emission (MHz)	Conducted limit (dBuV)	
	Quasi-peak	Average
0.15-0.5	66 to 56*	56 to 46*
0.5-5	56	46
5-30	60	50

*Decreases with the logarithm of the frequency.

3.6.2 Measuring Instruments

See list of measuring instruments of this test report.

3.6.3 Test Procedures

1. The testing follows the guidelines in ANSI C63.10-2009 and ANSI C63.4-2003 test site requirement.
2. The EUT was placed 0.4 meter from the conducting wall of the shielding room was kept at least 80 centimeters from any other grounded conducting surface.
3. Connect EUT to the power mains through a line impedance stabilization network (LISN).
4. All the support units are connecting to the other LISN.
5. The LISN provides 50 ohm coupling impedance for the measuring instrument.
6. The FCC states that a 50 ohm, 50 microhenry LISN should be used.
7. Both sides of AC line were checked for maximum conducted interference.
8. The frequency range from 150 kHz to 30 MHz was searched.
9. Set the test-receiver system to Peak Detect Function and specified bandwidth with Maximum Hold Mode.

3.6.4 Test Setup

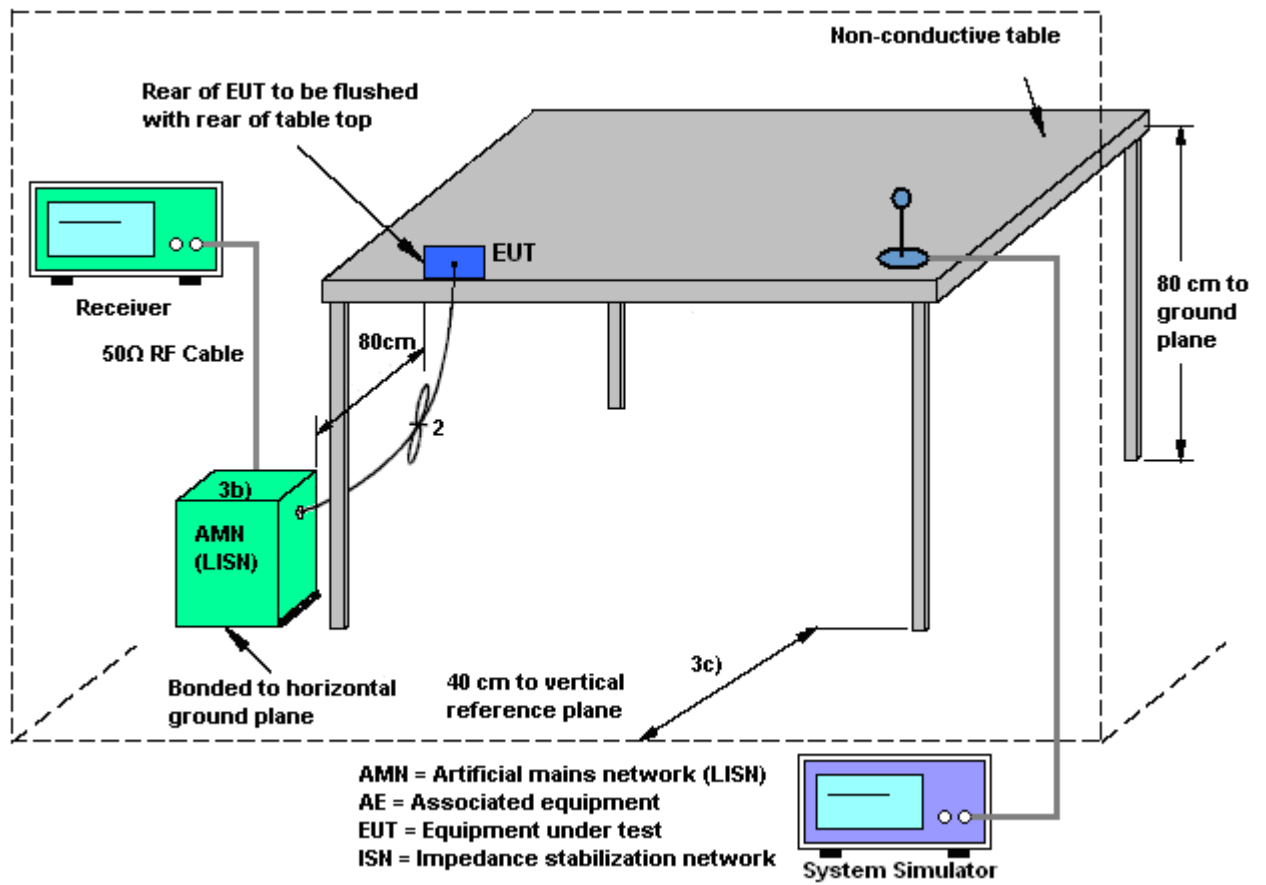



3.6.5 Test Result of AC Conducted Emission

Test Mode :	Mode 1	Temperature :	19~20°C
Test Engineer :	Tom Wang	Relative Humidity :	39~40%
Test Voltage :	120Vac / 60Hz	Phase :	Line
Function Type :	CDMA2000 BC0 Idle + Bluetooth Link + WLAN Link + USB Cable (Charging from Adapter)		
Remark :	All emissions not reported here are more than 10 dB below the prescribed limit.		

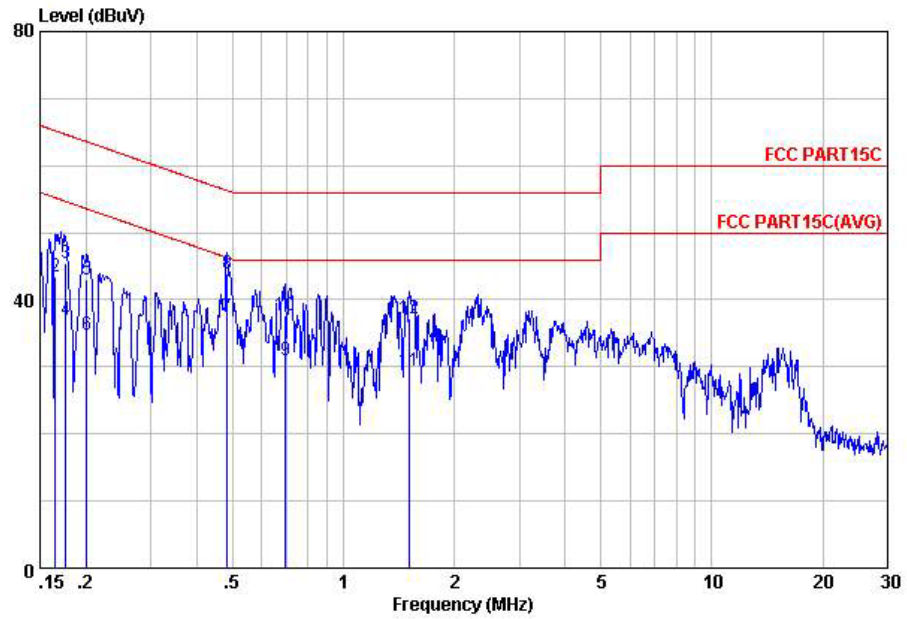

Site : C001-KS
 Condition: FCC PART15C LISN-111230 LINE

	Freq	Level	Over	Limit	Read	LISN	Cable	Remark
	MHz	dBuV	Limit	Line	Level	Factor	Loss	
			dB	dBuV	dBuV	dB	dB	
1	0.17	35.34	-19.87	55.21	25.20	-0.07	10.21	Average
2	0.17	43.44	-21.77	65.21	33.30	-0.07	10.21	QP
3	0.18	45.44	-19.23	64.67	35.30	-0.07	10.21	QP
4	0.18	36.94	-17.73	54.67	26.80	-0.07	10.21	Average
5	0.20	42.95	-20.63	63.58	32.80	-0.07	10.22	QP
6	0.20	34.85	-18.73	53.58	24.70	-0.07	10.22	Average
7	0.48	37.47	-8.80	46.27	27.30	-0.08	10.25	Average
8	0.48	43.97	-12.30	56.27	33.80	-0.08	10.25	QP
9	0.70	30.98	-15.02	46.00	20.80	-0.09	10.27	Average
10	0.70	37.58	-18.42	56.00	27.40	-0.09	10.27	QP
11	1.50	29.39	-16.61	46.00	19.21	-0.11	10.29	Average
12	1.50	37.29	-18.71	56.00	27.11	-0.11	10.29	QP



Test Mode :	Mode 1	Temperature :	19~20°C
Test Engineer :	Tom Wang	Relative Humidity :	39~40%
Test Voltage :	120Vac / 60Hz	Phase :	Neutral
Function Type :	CDMA2000 BC0 Idle + Bluetooth Link + WLAN Link + USB Cable (Charging from Adapter)		
Remark :	All emissions not reported here are more than 10 dB below the prescribed limit.		

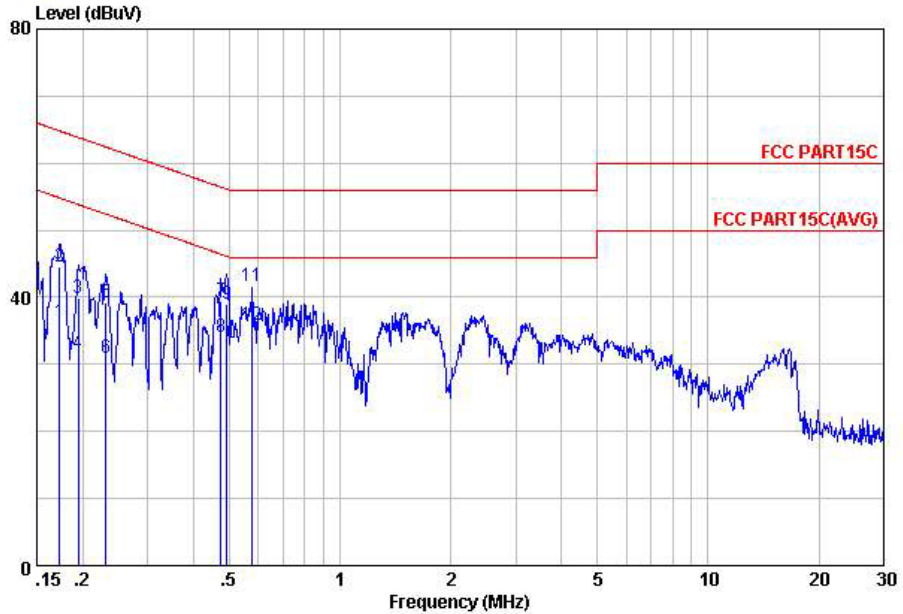

Site : C001-KS
 Condition: FCC PART15C LISN-111230 NEUTRAL

	Freq	Level	Over	Limit	Read	LISN	Cable	Remark
	MHz	dBuV	Limit	Line	Level	Factor	Loss	
			dB	dBuV	dBuV	dB	dB	
1	0.17	36.33	-18.48	54.81	26.20	-0.08	10.21	Average
2	0.17	44.63	-20.18	64.81	34.50	-0.08	10.21	QP
3	0.19	39.95	-23.89	63.84	29.80	-0.07	10.22	QP
4	0.19	31.75	-22.09	53.84	21.60	-0.07	10.22	Average
5	0.23	39.15	-23.24	62.39	29.00	-0.07	10.22	QP
6	0.23	30.95	-21.44	52.39	20.80	-0.07	10.22	Average
7	0.47	39.47	-16.98	56.45	29.30	-0.08	10.25	QP
8	0.47	34.07	-12.38	46.45	23.90	-0.08	10.25	Average
9	0.49	39.07	-17.07	56.14	28.90	-0.08	10.25	QP
10	0.49	33.17	-12.97	46.14	23.00	-0.08	10.25	Average
11	0.58	41.68	-14.32	56.00	31.50	-0.08	10.26	QP
12	0.58	35.98	-10.02	46.00	25.80	-0.08	10.26	Average



3.7 Antenna Requirements

3.7.1 Standard Applicable

If directional gain of transmitting antennas is greater than 6dBi, the power shall be reduced by the same level in dB comparing to gain minus 6dBi. The use of a permanently attached antenna or of an antenna that uses a unique coupling to the intentional radiator shall be considered sufficient to comply with the FCC rule.

3.7.2 Antenna Connected Construction

Non-standard connector used.

3.7.3 Antenna Gain

The antenna peak gain of EUT is less than 6 dBi. Therefore, it is not necessary to reduce maximum peak output power limit.



4 List of Measuring Equipment

Instrument	Manufacturer	Model No.	Serial No.	Characteristics	Calibration Date	Test Date	Due Date	Remark
Spectrum Analyzer	R&S	FSP40	100319	9kHz~40GHz	Dec. 29, 2012	Jan. 18, 2013~ Jan. 19, 2013	Dec. 28, 2013	Conducted (TH01-KS)
Power Meter	Agilent	E4416A	MY45101555	N/A	Aug. 22, 2012	Jan. 18, 2013~ Jan. 19, 2013	Aug. 21, 2013	Conducted (TH01-KS)
Power Sensor	Agilent	E9327A	MY44421198	N/A	Aug. 22, 2012	Jan. 18, 2013~ Jan. 19, 2013	Aug. 21, 2013	Conducted (TH01-KS)
DC Power Supply	GWINSTEK	GPS-3030D	E1884515	N/A	Aug. 22, 2012	Jan. 18, 2013~ Jan. 19, 2013	Aug. 21, 2013	Conducted (TH01-KS)
Thermal Chamber	Ten Billion	TTC-B3S	TBN-960502	N/A	Dec. 29, 2012	Jan. 18, 2013~ Jan. 19, 2013	Dec. 28, 2013	Conducted (TH01-KS)
EMI Test Receiver	R&S	ESCI	100534	9kHz~3GHz	Nov. 08, 2012	Jan. 25, 2013	Nov. 07, 2013	Radiation (03CH01-KS)
Spectrum Analyzer	R&S	FSP30	100400	9kHz~30GHz	Jun. 01, 2012	Jan. 25, 2013	May 31, 2013	Radiation (03CH01-KS)
Bilog Antenna	SCHAFFNER	CBL6112D	23182	25MHz~2GHz	Dec. 07, 2012	Jan. 25, 2013	Dec. 06, 2013	Radiation (03CH01-KS)
Loop Antenna	R&S	HFH2-Z2	860004/ 001	9 kHz~30 MHz	Jul. 03, 2012	Jan. 25, 2013	Jul. 02, 2014	Radiation (03CH01-KS)
Double Ridge Horn Antenna	ETS-Lindgren	1908/7/13	00075957	1GHz~18GHz	Dec. 07, 2012	Jan. 25, 2013	Dec. 06, 2013	Radiation (03CH01-KS)
Amplifier	com-power	PA-103A	161069	1MHz~1GHz	Jun. 01, 2012	Jan. 25, 2013	May 31, 2013	Radiation (03CH01-KS)
Amplifier	Agilent	8449B	3008A02370	1GHz~26.5GHz	Dec. 29, 2012	Jan. 25, 2013	Dec. 28, 2013	Radiation (03CH01-KS)
Active Horn Antenna	com-power	AHA-118	701023	1GHz~18GHz	Nov. 07, 2012	Jan. 25, 2013	Nov. 06, 2013	Radiation (03CH01-KS)
SHF-EHF Horn	Schwarzbeck	BBHA 9170	9170249	15GHz~40GHz	Nov. 23, 2012	Jan. 25, 2013	Nov. 22, 2013	Radiation (03CH01-KS)
EMI Receiver	R&S	ESCI7	100768	9kHz~7GHz	Jun. 01, 2012	Jan. 21, 2013	May 31, 2013	Conduction (CO01-KS)
LISN	MessTec	AN3016	60103	9kHz~30MHz	Dec. 29, 2012	Jan. 21, 2013	Dec. 28, 2013	Conduction (CO01-KS)
LISN	MessTec	AN3016	60105	9kHz~30MHz	Dec. 29, 2012	Jan. 21, 2013	Dec. 28, 2013	Conduction (CO01-KS)
AC Power Source	Chroma	61602	ABP000000811	N/A	Nov. 15, 2012	Jan. 21, 2013	Nov. 14, 2013	Conduction (CO01-KS)
System Simulator	R&S	CMU200	837587/066	2G Full-Band	Dec. 29, 2012	Jan. 21, 2013	Dec. 28, 2013	Conduction (CO01-KS)

5 Uncertainty of Evaluation

Uncertainty of Radiated Emission Measurement (30 MHz ~ 1000 MHz)

Measuring Uncertainty for a Level of Confidence of 95% ($U = 2Uc(y)$)	2.54
---	------

Uncertainty of Radiated Emission Measurement (1 GHz ~ 40 GHz)

Measuring Uncertainty for a Level of Confidence of 95% ($U = 2Uc(y)$)	4.72
---	------

Uncertainty of Conducted Emission Measurement (150 kHz ~ 30 MHz)

Measuring Uncertainty for a Level of Confidence of 95% ($U = 2Uc(y)$)	2.26
---	------



Appendix A. Photographs of EUT

Please refer to Sporton report number EP311602 as below.