



# FCC Test Report

**APPLICANT** : Yulong Computer  
Telecommunication Scientific  
(Shenzhen) Co., Ltd.

**EQUIPMENT** : Smartphone

**BRAND NAME** : Coolpad

**MODEL NAME** : Coolpad 5560S

**FCC ID** : R38YL5560S

**STANDARD** : FCC 47 CFR FCC Part 15 Subpart B

**CLASSIFICATION** : Certification

The product was received on May 27, 2014 and testing was completed on Jul. 24, 2014. We, SPORTON INTERNATIONAL (SHENZHEN) INC., would like to declare that the tested sample has been evaluated in accordance with the test procedures given in ANSI C63.4-2009 and has been in compliance with the applicable technical standards.

The test results in this report apply exclusively to the tested model / sample. Without written approval of SPORTON INTERNATIONAL (SHENZHEN) INC., the test report shall not be reproduced except in full.

Reviewed by: Louis Wu / Manager

Approved by: Jones Tsai / Manager



**SPORTON INTERNATIONAL (SHENZHEN) INC.**

No. 3 Building, the third floor of south, Shahe River west, Fengzeyuan warehouse, Nanshan District, Shenzhen, Guangdong, P.R.C.



# TABLE OF CONTENTS

**REVISION HISTORY..... 3**

**SUMMARY OF TEST RESULT ..... 4**

**1. GENERAL DESCRIPTION ..... 5**

    1.1. Applicant..... 5

    1.2. Manufacturer ..... 5

    1.3. Product Feature of Equipment Under Test ..... 5

    1.4. Product Specification subjective to this standard..... 6

    1.5. Modification of EUT..... 6

    1.6. Test Location..... 7

    1.7. Applicable Standards ..... 7

**2. TEST CONFIGURATION OF EQUIPMENT UNDER TEST ..... 8**

    2.1. Test Mode ..... 8

    2.2. Connection Diagram of Test System ..... 10

    2.3. Support Unit used in test configuration and system..... 11

    2.4. EUT Operation Test Setup..... 12

**3. TEST RESULT..... 13**

    3.1. Test of AC Conducted Emission Measurement ..... 13

    3.2. Test of Radiated Emission Measurement ..... 19

**4. LIST OF MEASURING EQUIPMENT ..... 23**

**5. UNCERTAINTY OF EVALUATION ..... 24**

**APPENDIX A. SETUP PHOTOGRAPHS**





### SUMMARY OF TEST RESULT

Report Section	FCC Rule	Description	Limit	Result	Remark
3.1	15.107	AC Conducted Emission	< 15.107 limits	PASS	Under limit 5.51 dB at 0.480 MHz
3.2	15.109	Radiated Emission	< 15.109 limits	PASS	Under limit 8.43 dB at 865.60 MHz



# 1. General Description

## 1.1. Applicant

**Yulong Computer Telecommunication Scientific (Shenzhen) Co., Ltd.**  
Hi-Tech Industry Park(North), Nanshan District, Shenzhen City, Guangdong Province, P.R.C.

## 1.2. Manufacturer

**Yulong Computer Telecommunication Scientific (Shenzhen) Co., Ltd.**  
Hi-Tech Industry Park(North), Nanshan District, Shenzhen City, Guangdong Province, P.R.C.

## 1.3. Product Feature of Equipment Under Test

Product Feature	
Equipment	Smartphone
Brand Name	Coolpad
Model Name	Coolpad 5560S
FCC ID	R38YL5560S
EUT supports Radios application	CDMA/EV-DO WLAN 2.4GHz 802.11b/g/n HT20 Bluetooth v3.0 + EDR/Bluetooth v4.0 LE
HW Version	P1
SW Version	5560S.SP005
EUT Stage	Pre-Production

**Remark:** The above EUT's information was declared by manufacturer. Please refer to the specifications or user's manual for more detailed description.



### 1.4. Product Specification subjective to this standard

Product Specification subjective to this standard	
<b>Tx Frequency</b>	CDMA2000 BC0 : 824.70 MHz ~ 848.31 MHz CDMA2000 BC1 : 1851.25 MHz ~ 1908.75 MHz CDMA2000 BC10 : 817.9 MHz ~ 823.1 MHz 802.11b/g/n: 2412 MHz ~ 2462 MHz Bluetooth: 2402 MHz ~ 2480 MHz
<b>Rx Frequency</b>	CDMA2000 BC0 : 869.70 MHz ~ 893.31 MHz CDMA2000 BC1 : 1931.25 MHz ~ 1988.75 MHz CDMA2000 BC10 : 862.9 MHz ~ 868.1 MHz 802.11b/g/n: 2412 MHz ~ 2462 MHz Bluetooth: 2402 MHz ~ 2480 MHz GPS : 1.57542 GHz
<b>Antenna Type</b>	WWAN : PIFA Antenna WLAN : MONOPOLE Antenna Bluetooth : MONOPOLE Antenna GPS : IFA Antenna
<b>Type of Modulation</b>	CDMA2000 : QPSK CDMA2000 1xEV-DO : QPSK/8PSK 802.11b : DSSS (DBPSK / DQPSK / CCK) 802.11g/n : OFDM (BPSK / QPSK / 16QAM / 64QAM) Bluetooth v4.0 LE : GFSK Bluetooth v3.0 EDR : GFSK, $\pi/4$ -DQPSK, 8-DPSK GPS : BPSK

### 1.5. Modification of EUT

No modifications are made to the EUT during all test items.



### 1.6. Test Location

<b>Test Site</b>	SPORTON INTERNATIONAL (SHENZHEN) INC.		
<b>Test Site Location</b>	No. 3 Building, the third floor of south, Shahe River west, Fengzeyuan warehouse, Nanshan District, Shenzhen, Guangdong, P.R.C. TEL: +86-755- 3320-2398		
<b>Test Site No.</b>	<b>Sporton Site No.</b>		<b>FCC Registration No.</b>
	CO01-SZ	03CH01-SZ	831040

### 1.7. Applicable Standards

According to the specifications of the manufacturer, the EUT must comply with the requirements of the following standards:

- FCC 47 CFR FCC Part 15 Subpart B
- ANSI C63.4-2009

**Remark:** All test items were verified and recorded according to the standards and without any deviation during the test.

## 2. Test Configuration of Equipment Under Test

### 2.1. Test Mode

The EUT has been associated with peripherals pursuant to ANSI C63.4-2009 and configuration operated in a manner tended to maximize its emission characteristics in a typical application.

Frequency range investigated: conduction (150 kHz to 30 MHz), radiation (30MHz to the 5th harmonic of the highest fundamental frequency or to 40 GHz, whichever is lower).

The following tables are showing the test modes as the worst cases and recorded in this report.

Item	EUT Configuration	Test Condition		
		EMI AC	EMI RE<1G	EMI RE≥1G
1.	Charging Mode (EUT with adapter)	☒	☒	Note 1
2.	Data application transferred mode (EUT connected with notebook)	☒	☒	☒

**Abbreviations:**

- EMI AC: AC conducted emissions
- EMI RE ≥ 1G: EUT radiated emissions ≥ 1GHz
- EMI RE < 1G: EUT radiated emissions < 1GHz

**Note 1:** Testing for this mode is not required or not the worst case.

**Remark:** For signal above 1GHz, the worst case was test item 2.





Test Items	EUT Configure Mode	Function Type
AC Conducted Emission	1/2	Mode 1: CDMA850 Idle (BC0) + Bluetooth Idle +WLAN Idle + USB Cable (Charging from Adapter) + Camera<Fig.1> Mode 2: CDMA1900 Idle (BC1) + Bluetooth Idle +WLAN Idle + USB Cable (Charging from Adapter) + MPEG4<Fig.1> Mode 3: CDMA850 Idle(BC10) + Bluetooth Idle + WLAN Idle + USB Cable (Data Link with Notebook) + GPS Rx<Fig.2>
Radiated Emissions < 1GHz	1/2	Mode 1: CDMA850 Idle (BC0) + Bluetooth Idle +WLAN Idle + USB Cable (Charging from Adapter) + Camera<Fig.1> Mode 2: CDMA1900 Idle (BC1) + Bluetooth Idle +WLAN Idle + USB Cable (Charging from Adapter) + MPEG4<Fig.1> Mode 3: CDMA850 Idle(BC10) + Bluetooth Idle + WLAN Idle + USB Cable (Data Link with Notebook) + GPS Rx<Fig.2>
Radiated Emissions ≥ 1GHz	2	Mode 1: CDMA850 Idle(BC10) + Bluetooth Idle + WLAN Idle + USB Cable (Data Link with Notebook) + GPS Rx<Fig.2>
<b>Remark:</b> <ol style="list-style-type: none"><li>1. The worst case of AC is mode 2, and the USB Link mode of AC is mode 3, the test data of these modes are reported.</li><li>2. The worst case of RE &lt; 1G is mode 3; only the test data of this mode was reported.</li><li>3. Link with Notebook means data application transferred mode between EUT and Notebook.</li></ol>		

## 2.2. Connection Diagram of Test System

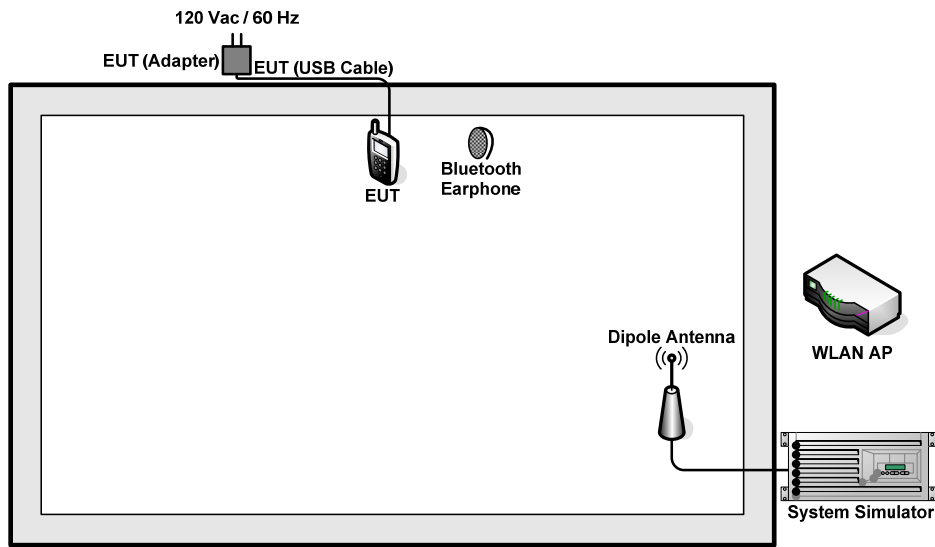

<Fig.1>

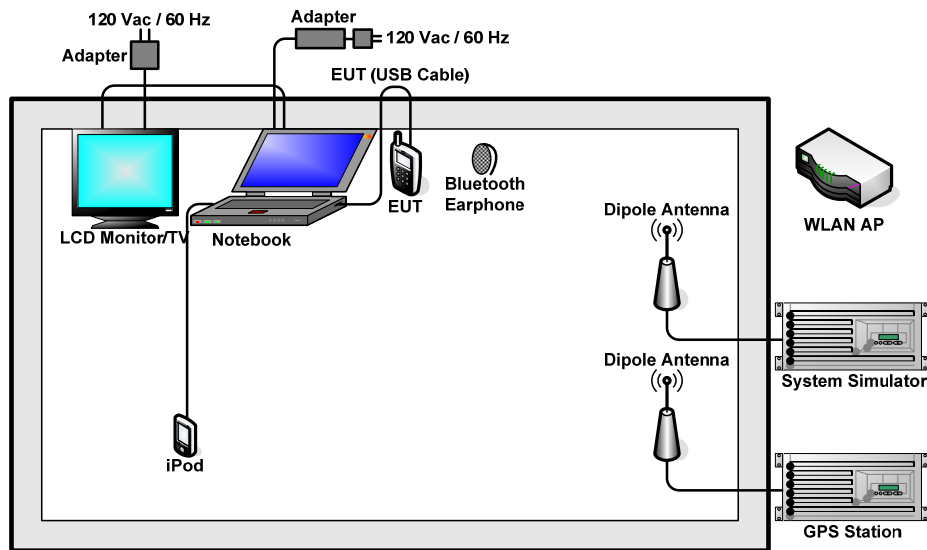

<Fig.2>



### 2.3. Support Unit used in test configuration and system

Item	Equipment	Trade Name	Model Name	FCC ID	Data Cable	Power Cord
1.	Bluetooth Earphone	Nokia	BH-108	PYAHS-107W	N/A	N/A
2.	Base Station	Agilent	8960	N/A	N/A	Unshielded, 1.8 m
3.	Notebook	Lenovo	G480	FCC DoC	N/A	AC I/P: Unshielded, 1.2m DC O/P: Shielded, 1.8 m
4.	WLAN AP	D-link	DIR-615	N/A	N/A	Unshielded, 1.8m
5.	WLAN AP	D-link	DIR-815	KA2IR815A1	N/A	Unshielded, 1.8m
6.	Television	changhong	LTE19920EX	N/A	N/A	Unshielded, 1.8 m
7.	Notebook	Lenovo	E540	FCC DoC	N/A	AC I/P: Unshielded, 1.2m DC O/P: Shielded, 1.8 m
8.	LCD Monitor	DELL	IN1940MWb	FCC DoC	Shielded, 1.6 m	Unshielded, 1.8 m
9.	GPS Station	ADIVIC	MP9000	N/A	N/A	Unshielded, 1.8 m
10.	SD Card	SanDisk	4G class 4	FCC DoC	N/A	N/A
11.	iPod	Apple	MC525 ZP/A	FCC DoC	Shielded, 1.0 m	N/A
12.	iPod nano 8GB	Apple	MC690ZP/A	FCC DoC	Shielded, 1.2 m	N/A



## **2.4. EUT Operation Test Setup**

The EUT was in GSM or WCDMA idle mode during the testing. The EUT was synchronized to the BCCH, and was in continuous receiving mode by setting system simulator's paging reorganization.

At the same time, the EUT was attached to the Bluetooth earphone or WLAN AP, and the following programs installed in the EUT were programmed during the test.

1. Data application is transferred between Laptop and EUT via USB cable.
2. Execute "GPS Test" to make the EUT receive continuous signals from GPS station.
3. Execute "Video Media Player" to play MPEG4 files.
4. Turn on camera to capture images.



### 3. Test Result

#### 3.1. Test of AC Conducted Emission Measurement

##### 3.1.1 Limits of AC Conducted Emission

For equipment that is designed to be connected to the public utility (AC) power line, the radio frequency voltage that is conducted back onto the AC power line on any frequency or frequencies within the band 150 kHz to 30 MHz shall not exceed the limits in the following table.

Frequency of emission (MHz)	Conducted limit (dBuV)	
	Quasi-peak	Average
0.15-0.5	66 to 56*	56 to 46*
0.5-5	56	46
5-30	60	50

\*Decreases with the logarithm of the frequency.

##### 3.1.2 Measuring Instruments

The measuring equipment is listed in the section 4 of this test report.

##### 3.1.3 Test Procedure

1. The EUT was placed 0.4 meter from the conducting wall of the shielding room was kept at least 80 centimeters from any other grounded conducting surface.
2. Connect EUT to the power mains through a line impedance stabilization network (LISN).
3. All the support units are connecting to the other LISN.
4. The LISN provides 50 ohm coupling impedance for the measuring instrument.
5. The FCC states that a 50 ohm, 50 microhenry LISN should be used.
6. Both sides of AC line were checked for maximum conducted interference.
7. The frequency range from 150 kHz to 30 MHz was searched.
8. Set the test-receiver system to Peak Detect Function and specified bandwidth with Maximum Hold Mode.

### 3.1.4 Test Setup





3.1.5 Test Result of AC Conducted Emission

Test Mode :	Mode 2	Temperature :	21~22°C
Test Engineer :	Jack Tian	Relative Humidity :	41~42%
Test Voltage :	120Vac / 60Hz	Phase :	Line
Function Type :	CDMA1900 Idle (BC1) + Bluetooth Idle + WLAN Idle + USB Cable (Charging from Adapter) + MPEG4		

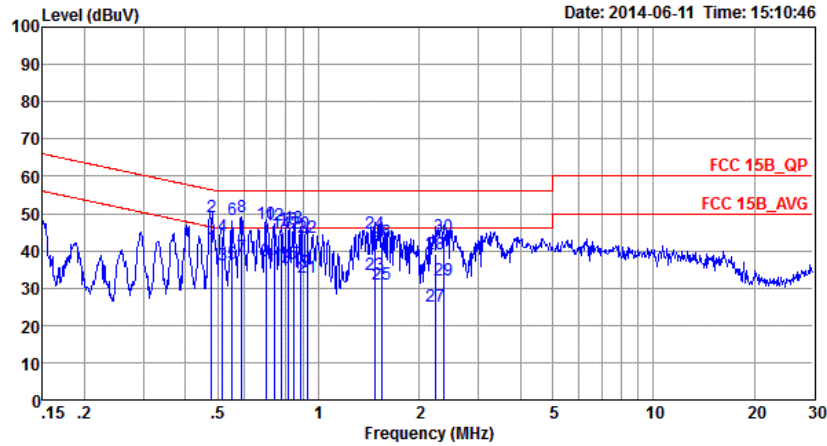

Site : CO01-SZ  
 Condition: FCC 15B\_QP LISN\_L\_20140304 LINE  
 Project : (FC)452702  
 Mode : Mode 2

	Freq	Level	Over Limit	Limit Line	Read Level	LISN Factor	Cable Loss	Remark
	MHz	dBuV	dB	dBuV	dBuV	dB	dB	
1 *	0.48	40.85	-5.51	46.36	30.39	0.30	10.16	Average
2	0.48	49.15	-7.21	56.36	38.69	0.30	10.16	QP
3	0.52	36.24	-9.76	46.00	25.79	0.29	10.16	Average
4	0.52	44.04	-11.96	56.00	33.59	0.29	10.16	QP
5	0.55	36.42	-9.58	46.00	26.01	0.26	10.15	Average
6	0.55	48.52	-7.48	56.00	38.11	0.26	10.15	QP
7	0.59	38.39	-7.61	46.00	28.00	0.24	10.15	Average
8	0.59	48.89	-7.11	56.00	38.50	0.24	10.15	QP
9	0.70	37.33	-8.67	46.00	27.00	0.18	10.15	Average
10	0.70	47.33	-8.67	56.00	37.00	0.18	10.15	QP
11	0.74	36.34	-9.66	46.00	26.00	0.19	10.15	Average
12	0.74	46.94	-9.06	56.00	36.60	0.19	10.15	QP
13	0.77	35.55	-10.45	46.00	25.20	0.20	10.15	Average
14	0.77	44.65	-11.35	56.00	34.30	0.20	10.15	QP
15	0.81	36.46	-9.54	46.00	26.10	0.21	10.15	Average
16	0.81	45.86	-10.14	56.00	35.50	0.21	10.15	QP
17	0.84	36.47	-9.53	46.00	26.10	0.22	10.15	Average
18	0.84	46.07	-9.93	56.00	35.70	0.22	10.15	QP
19	0.88	34.28	-11.72	46.00	23.90	0.23	10.15	Average
20	0.88	44.68	-11.32	56.00	34.30	0.23	10.15	QP
21	0.92	32.89	-13.11	46.00	22.50	0.24	10.15	Average
22	0.92	43.69	-12.31	56.00	33.30	0.24	10.15	QP
23	1.47	33.71	-12.29	46.00	23.30	0.24	10.17	Average
24	1.47	44.71	-11.29	56.00	34.30	0.24	10.17	QP
25	1.54	31.11	-14.89	46.00	20.70	0.24	10.17	Average
26	1.54	42.31	-13.69	56.00	31.90	0.24	10.17	QP
27	2.24	25.24	-20.76	46.00	14.81	0.24	10.19	Average
28	2.24	39.24	-16.76	56.00	28.81	0.24	10.19	QP
29	2.36	32.05	-13.95	46.00	21.59	0.26	10.20	Average
30	2.36	43.75	-12.25	56.00	33.29	0.26	10.20	QP



Test Mode :	Mode 2	Temperature :	21~22°C
Test Engineer :	Jack Tian	Relative Humidity :	41~42%
Test Voltage :	120Vac / 60Hz	Phase :	Neutral
Function Type :	CDMA1900 Idle ( BC1 ) + Bluetooth Idle +WLAN Idle + USB Cable (Charging from Adapter) + MPEG4		

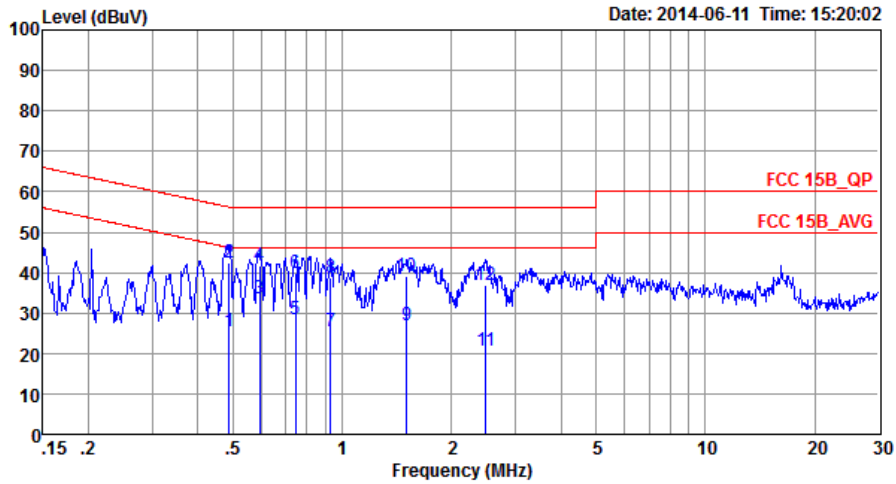

Site : C001-SZ  
 Condition: FCC 15B\_QP LISN\_N\_20140304 NEUTRAL  
 Project : (FC)452702  
 Mode : Mode 2

	Freq	Level	Over Limit	Limit Line	Read Level	LISN Factor	Cable Loss	Remark
	MHz	dBuV	dB	dBuV	dBuV	dB	dB	
1	0.49	25.56	-20.63	46.19	14.99	0.41	10.16	Average
2	0.49	42.56	-13.63	56.19	31.99	0.41	10.16	QP
3 *	0.59	33.68	-12.32	46.00	23.20	0.33	10.15	Average
4	0.59	41.58	-14.42	56.00	31.10	0.33	10.15	QP
5	0.74	28.31	-17.69	46.00	17.90	0.26	10.15	Average
6	0.74	40.01	-15.99	56.00	29.60	0.26	10.15	QP
7	0.93	25.46	-20.54	46.00	15.00	0.31	10.15	Average
8	0.93	38.66	-17.34	56.00	28.20	0.31	10.15	QP
9	1.50	26.83	-19.17	46.00	16.31	0.35	10.17	Average
10	1.50	39.13	-16.87	56.00	28.61	0.35	10.17	QP
11	2.49	20.70	-25.30	46.00	10.10	0.40	10.20	Average
12	2.49	36.80	-19.20	56.00	26.20	0.40	10.20	QP





Test Mode :	Mode 3	Temperature :	21~22°C
Test Engineer :	Jack Tian	Relative Humidity :	41~42%
Test Voltage :	120Vac / 60Hz	Phase :	Line
Function Type :	CDMA850 Idle(BC10) + Bluetooth Idle + WLAN Idle + USB Cable (Data Link with Notebook) + GPS Rx		

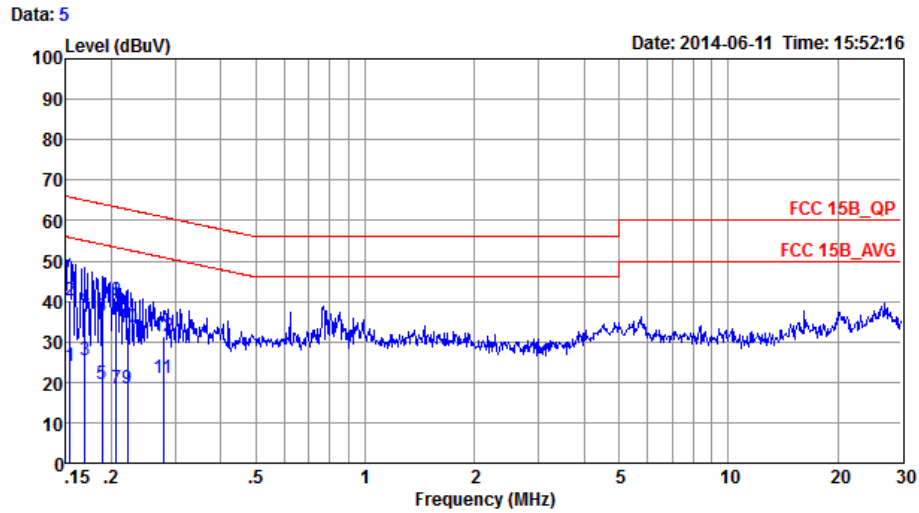

Site : CO01-SZ  
 Condition: FCC 15B\_QP LISN\_L\_20140304 LINE  
 Project : (FC)452702  
 Mode : Mode 3  
 IMEI : 99000526000726

	MHz	dBuV	Over imit dB	Limit Line dBuV	Read Level dBuV	LISN Factor dB	Cable Loss dB	Remark
1	0.15	24.07	-31.71	55.78	13.50	0.22	10.35	Average
2	0.15	40.37	-25.41	65.78	29.80	0.22	10.35	QP
3	0.17	25.45	-29.54	54.99	14.90	0.22	10.33	Average
4	0.17	38.55	-26.44	64.99	28.00	0.22	10.33	QP
5	0.19	19.53	-34.58	54.11	9.00	0.22	10.31	Average
6	0.19	36.03	-28.08	64.11	25.50	0.22	10.31	QP
7	0.21	18.31	-35.05	53.36	7.80	0.22	10.29	Average
8 *	0.21	40.21	-23.15	63.36	29.70	0.22	10.29	QP
9	0.22	18.60	-34.14	52.74	8.10	0.23	10.27	Average
10	0.22	33.40	-29.34	62.74	22.90	0.23	10.27	QP
11	0.28	20.87	-30.03	50.90	10.40	0.25	10.22	Average
12	0.28	31.47	-29.43	60.90	21.00	0.25	10.22	QP



Test Mode :	Mode 3	Temperature :	21~22°C
Test Engineer :	Jack Tian	Relative Humidity :	41~42%
Test Voltage :	120Vac / 60Hz	Phase :	Neutral
Function Type :	CDMA850 Idle(BC10) + Bluetooth Idle + WLAN Idle + USB Cable (Data Link with Notebook) + GPS Rx		

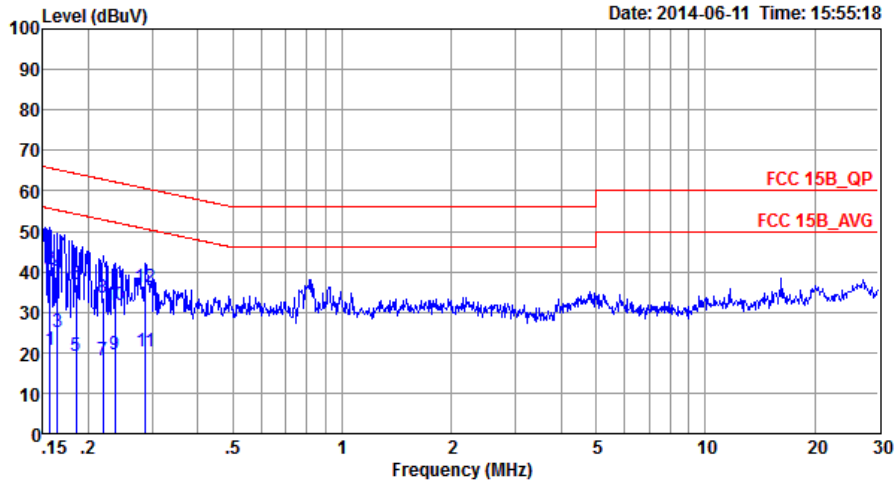

Site : CO01-SZ  
 Condition: FCC 15B\_QP LISN\_N\_20140304 NEUTRAL  
 Project : (FC)452702  
 Mode : Mode 3

	Freq	Level	Over Limit	Limit Line	Read Level	LISN Factor	Cable Loss	Remark
	MHz	dBuV	dB	dBuV	dBuV	dB	dB	
1	0.16	20.78	-34.87	55.65	10.10	0.33	10.35	Average
2	0.16	40.48	-25.17	65.65	29.80	0.33	10.35	QP
3	0.16	25.17	-30.08	55.25	14.50	0.33	10.34	Average
4	0.16	39.47	-25.78	65.25	28.80	0.33	10.34	QP
5	0.19	19.23	-35.01	54.24	8.60	0.32	10.31	Average
6	0.19	36.93	-27.31	64.24	26.30	0.32	10.31	QP
7	0.22	17.90	-34.93	52.83	7.30	0.33	10.27	Average
8	0.22	33.40	-29.43	62.83	22.80	0.33	10.27	QP
9	0.24	19.39	-32.83	52.22	8.80	0.34	10.25	Average
10	0.24	31.59	-30.63	62.22	21.00	0.34	10.25	QP
11	0.29	20.47	-30.12	50.59	9.90	0.36	10.21	Average
12 *	0.29	36.27	-24.32	60.59	25.70	0.36	10.21	QP



### 3.2. Test of Radiated Emission Measurement

#### 3.2.1. Limit of Radiated Emission

The emissions from an unintentional radiator shall not exceed the field strength levels specified in the following table:

Frequency (MHz)	Field Strength (microvolts/meter)	Measurement Distance (meters)
30 – 88	100	3
88 – 216	150	3
216 - 960	200	3
Above 960	500	3

#### 3.2.2. Measuring Instruments

The measuring equipment is listed in the section 4 of this test report.

#### 3.2.3. Test Procedures

1. The EUT was placed on a turntable with 0.8 meter above ground.
2. The EUT was set 3 meters from the interference receiving antenna, which was mounted on the top of a variable height antenna tower.
3. The table was rotated 360 degrees to determine the position of the highest radiation.
4. The antenna is a Bi-Log antenna and its height is adjusted between one to four meters above ground to find the maximum value of the field strength for both horizontal polarization and vertical polarization of the antenna.
5. For each suspected emission, the EUT was arranged to its worst case and then tune the antenna tower (from 1 m to 4 m) and turntable (from 0 degree to 360 degrees) to find the maximum reading.
6. Set the test-receiver system to Peak Detect Function and specified bandwidth with Maximum Hold Mode.
7. If the emission level of the EUT in peak mode was 3 dB lower than the limit specified, peak values of EUT will be reported. Otherwise, the emission will be repeated by using the quasi-peak method and reported.
8. Emission level (dB $\mu$ V/m) = 20 log Emission level ( $\mu$ V/m)
9. Corrected Reading: Antenna Factor + Cable Loss + Read Level - Preamp Factor = Level

### 3.2.4. Test Setup of Radiated Emission

For radiated emissions from 30MHz to 1GHz

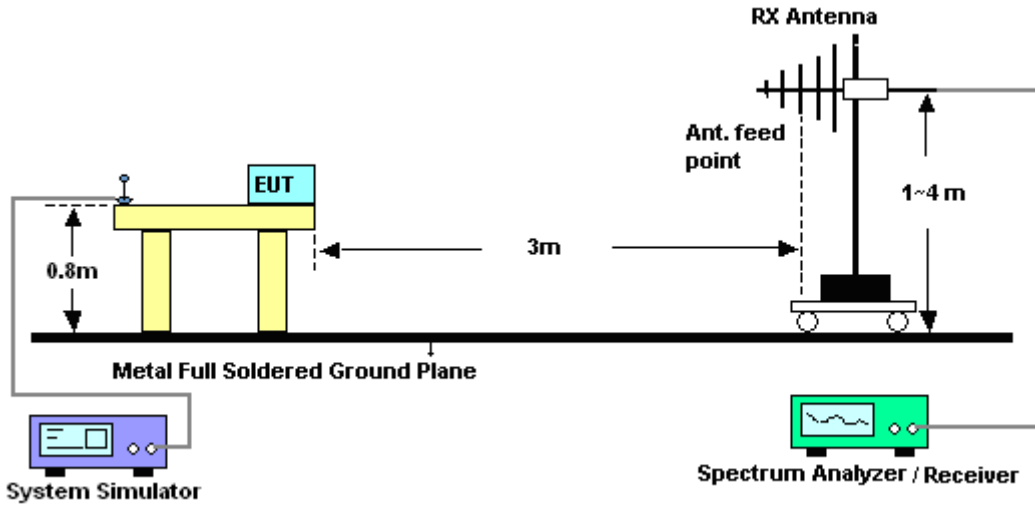

For radiated emissions above 1GHz

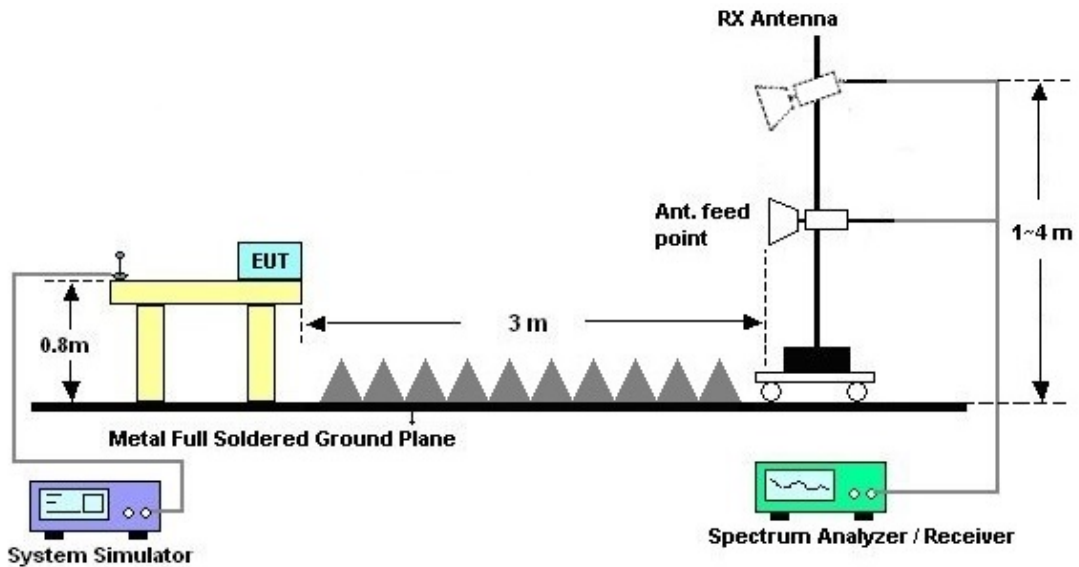



3.2.5. Test Result of Radiated Emission

Test Mode :	Mode 3	Temperature :	23~25°C
Test Engineer :	Rock Tang	Relative Humidity :	48~52%
Test Distance :	3m	Polarization :	Horizontal
Function Type :	CDMA850 Idle(BC10) + Bluetooth Idle + WLAN Idle + USB Cable (Data Link with Notebook) + GPS Rx		

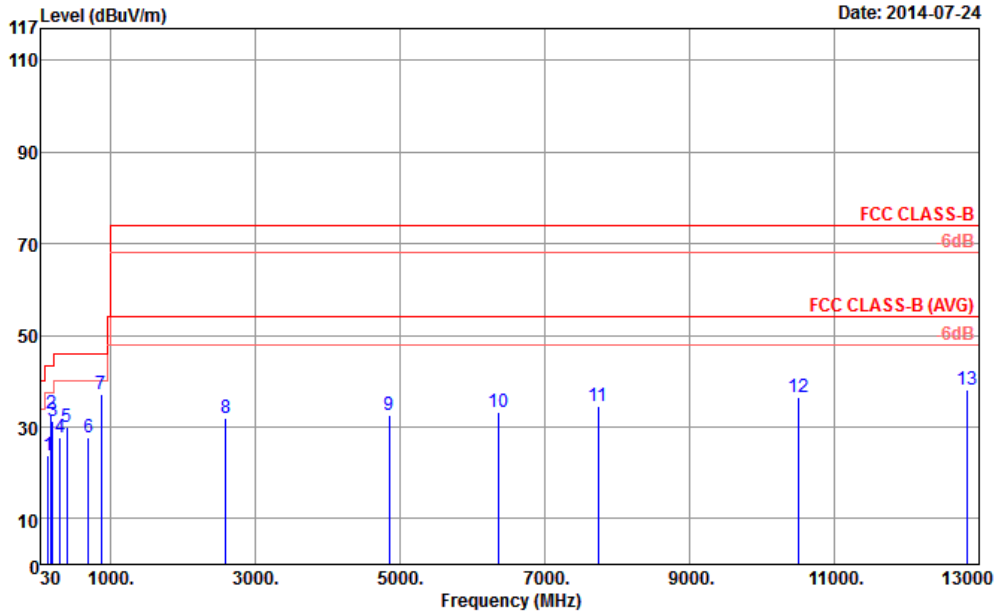

Site : 03CH01-SZ  
 Condition : FCC CLASS-B 3m LF\_ANT\_131026 HORIZONTAL  
 Project : (FC)452702  
 Mode : Mode 3  
 IMEI : 99000526000739

	Freq	Level	Over	Limit	ReadAntenna	Cable	Preamp	A/Pos	T/Pos	Remark	
	MHz	dBuV/m	dB	dBuV/m	dBuV	dB/m	dB	dB	cm	deg	
1	142.59	23.74	-19.76	43.50	41.59	10.65	1.44	29.94	---	---	Peak
2	179.85	32.91	-10.59	43.50	53.37	7.86	1.62	29.94	100	206	Peak
3	200.10	31.21	-12.29	43.50	50.35	9.10	1.70	29.94	---	---	Peak
4	306.30	27.78	-18.22	46.00	42.92	12.75	2.04	29.93	---	---	Peak
5	399.40	29.87	-16.13	46.00	41.61	15.90	2.29	29.93	---	---	Peak
6	699.70	27.66	-18.34	46.00	35.68	18.95	2.96	29.93	---	---	Peak
7 P	866.30	37.17	-8.83	46.00	43.01	20.80	3.29	29.93	---	---	Peak
8	2596.00	31.98	-42.02	74.00	50.55	32.60	5.87	57.04	---	---	Peak
9	4846.00	32.49	-41.51	74.00	47.74	33.86	8.38	57.49	---	---	Peak
10	6360.00	33.19	-40.81	74.00	46.35	34.00	9.66	56.82	---	---	Peak
11	7734.00	34.60	-39.40	74.00	46.58	34.42	10.36	56.76	---	---	Peak
12	10496.00	36.46	-37.54	74.00	45.60	36.70	12.92	58.76	---	---	Peak
13	12830.00	38.03	-35.97	74.00	43.32	38.50	14.31	58.10	100	206	Peak



Test Mode :	Mode 3	Temperature :	23~25°C
Test Engineer :	Rock Tang	Relative Humidity :	48~52%
Test Distance :	3m	Polarization :	Vertical
Function Type :	CDMA850 Idle(BC10) + Bluetooth Idle + WLAN Idle + USB Cable (Data Link with Notebook) + GPS Rx		

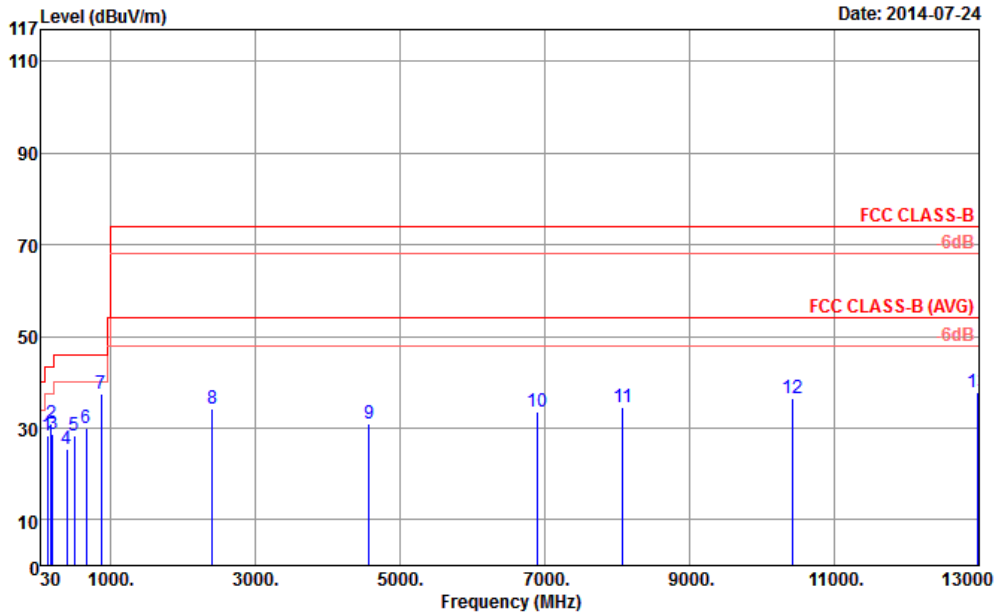

Site : 03CH01-SZ  
 Condition : FCC CLASS-B 3m LF\_ANT\_131026 VERTICAL  
 Project : (FC)452702  
 Mode : Mode 3  
 IMEI : 99000526000739

	Freq	Level	Over Limit	Limit Line	ReadAntenna Level	Cable Factor	Preamp Loss	A/Pos	T/Pos	Remark	
	MHz	dBuV/m	dB	dBuV/m	dBuV	dB/m	dB	dB	cm	deg	
1	132.33	28.45	-15.05	43.50	45.11	11.88	1.40	29.94	---	---	Peak
2	178.50	30.92	-12.58	43.50	51.32	7.93	1.61	29.94	100	206	Peak
3	200.10	28.67	-14.83	43.50	47.81	9.10	1.70	29.94	---	---	Peak
4	399.40	25.49	-20.51	46.00	37.23	15.90	2.29	29.93	---	---	Peak
5	499.50	28.43	-17.57	46.00	38.80	17.02	2.53	29.92	---	---	Peak
6	659.10	29.89	-16.11	46.00	38.45	18.50	2.87	29.93	---	---	Peak
7 P	865.60	37.57	-8.43	46.00	43.40	20.80	3.30	29.93	---	---	Peak
8	2408.00	34.30	-39.70	74.00	53.60	32.07	5.62	56.99	---	---	Peak
9	4572.00	30.91	-43.09	74.00	47.56	33.25	8.10	58.00	---	---	Peak
10	6896.00	33.47	-40.53	74.00	47.21	33.76	9.87	57.37	---	---	Peak
11	8074.00	34.46	-39.54	74.00	45.33	35.02	10.75	56.64	---	---	Peak
12	10430.00	36.41	-37.59	74.00	45.45	36.74	12.89	58.67	---	---	Peak
13	12974.00	37.91	-36.09	74.00	42.90	38.74	14.35	58.08	100	196	Peak



## 4. List of Measuring Equipment

Instrument	Manufacturer	Model No.	Serial No.	Characteristics	Calibration Date	Test Date	Due Date	Remark
ESCIO TEST Receiver	R&S	ESCI	100724	9kHz~3GHz	Feb. 21, 2014	Jul. 23, 2014~ Jul. 24, 2014	Feb. 20, 2015	Radiation (03CH01-SZ)
Spectrum Analyzer	Agilent Technologies	N9038A	MY52260185	20Hz~26.5GHz	May 26, 2014	Jul. 23, 2014~ Jul. 24, 2014	May 25, 2015	Radiation (03CH01-SZ)
Bilog Antenna	TESEQ	CBL 6112D	23188	30MHz~2GHz	Oct. 26, 2013	Jul. 23, 2014~ Jul. 24, 2014	Oct. 25, 2014	Radiation (03CH01-SZ)
Double Ridge Horn Antenna	ETS Lindgren	3117	00119436	1GHz~18GHz	Oct. 26, 2013	Jul. 23, 2014~ Jul. 24, 2014	Oct. 25, 2014	Radiation (03CH01-SZ)
Amplifier	ADVANTEST	BB525C	E9007003	9kHz~3000MHz	Feb. 21, 2014	Jul. 23, 2014~ Jul. 24, 2014	Feb. 20, 2015	Radiation (03CH01-SZ)
Amplifier	Yiai	AV3860B	04030	2GHz~26.5GHz	May 08, 2014	Jul. 23, 2014~ Jul. 24, 2014	May 07, 2015	Radiation (03CH01-SZ)
AC Source(AVR)	Chroma	61601	61601000198 5	100Vac~250Vac	Mar. 25, 2014	Jul. 23, 2014~ Jul. 24, 2014	Mar. 24, 2015	Radiation (03CH01-SZ)
Turn Table	EM Electronics	EM 1000	N/A	0~360 degree	NCR	Jul. 23, 2014~ Jul. 24, 2014	NCR	Radiation (03CH01-SZ)
Antenna Mast	EM Electronics	EM 1000	N/A	1 m~4 m	NCR	Jul. 23, 2014~ Jul. 24, 2014	NCR	Radiation (03CH01-SZ)
ESCIO TEST Receiver	R&S	ESCI	100724	9kHz~3GHz	Feb. 21, 2014	Jun. 11, 2014	Feb. 20, 2015	Conduction (CO01-SZ)
AC LISN	EMCO	3816/2SH	00103912	9kHz~30MHz	Mar. 04, 2014	Jun. 11, 2014	Mar. 03, 2015	Conduction (CO01-SZ)
AC LISN (for auxiliary equipment)	EMCO	3816/2SH	00103892	9kHz~30MHz	Mar. 04, 2014	Jun. 11, 2014	Mar. 03, 2015	Conduction (CO01-SZ)
AC Power Source	Chroma	61602	61602000089 1	100Vac~250Vac	Dec. 17, 2013	Jun. 11, 2014	Dec. 16, 2014	Conduction (CO01-SZ)



## 5. Uncertainty of Evaluation

### Uncertainty of Conducted Emission Measurement (150 kHz ~ 30 MHz)

Measuring Uncertainty for a Level of Confidence of 95% ( $U = 2Uc(y)$ )	2.3
---	-----

### Uncertainty of Radiated Emission Measurement (30 MHz ~ 1000 MHz)

Measuring Uncertainty for a Level of Confidence of 95% ( $U = 2Uc(y)$ )	3.9
---	-----