



TEST REPORT

No.I18N01496-SAR

For

Yulong Computer Telecommunication Scientific (Shenzhen) Co., Ltd

Smartphone

Model Name: cp3705A

With

Hardware Version: P1

Software Version: 3705A.MPCS.181120.1D

FCC ID: R38YL3705A

Issued Date: 2018-12-03

Designation Number: CN1210

Note:

The test results in this test report relate only to the devices specified in this report. This report shall not be reproduced except in full without the written approval of SAICT.

Test Laboratory:

Shenzhen Academy of Information and Communications Technology

Building G, Shenzhen International Innovation Center, No.1006 Shennan Road, Futian District, Shenzhen,

Guangdong, P. R. China 518026.

Tel: +86(0)755-33322000, Fax: +86(0)755-33322001

Email: yewu@caict.ac.cn, website: www.cszit.com

REPORT HISTORY

| Report Number | Revision | Issue Date | Description |
|----------------------|-----------------|-------------------|---------------------------------|
| I18N01496-SAR | Rev.0 | 2018-12-03 | Initial creation of test report |

TABLE OF CONTENT

| | |
|--|-----------|
| 1 TEST LABORATORY | 5 |
| 1.1 TESTING LOCATION | 5 |
| 1.2 TESTING ENVIRONMENT | 5 |
| 1.3 PROJECT DATA | 5 |
| 1.4 SIGNATURE | 5 |
| 2 STATEMENT OF COMPLIANCE | 6 |
| 3 CLIENT INFORMATION | 9 |
| 3.1 APPLICANT INFORMATION..... | 9 |
| 3.2 MANUFACTURER INFORMATION | 9 |
| 4 EQUIPMENT UNDER TEST (EUT) AND ANCILLARY EQUIPMENT (AE) | 10 |
| 4.1 ABOUT EUT | 10 |
| 4.2 INTERNAL IDENTIFICATION OF EUT USED DURING THE TEST | 10 |
| 4.3 INTERNAL IDENTIFICATION OF AE USED DURING THE TEST | 11 |
| 5 TEST METHODOLOGY | 12 |
| 5.1 APPLICABLE LIMIT REGULATIONS..... | 12 |
| 5.2 APPLICABLE MEASUREMENT STANDARDS | 12 |
| 6 SPECIFIC ABSORPTION RATE (SAR)..... | 13 |
| 6.1 INTRODUCTION..... | 13 |
| 6.2 SAR DEFINITION..... | 13 |
| 7 TISSUE SIMULATING LIQUIDS | 14 |
| 7.1 TARGETS FOR TISSUE SIMULATING LIQUID | 14 |
| 7.2 DIELECTRIC PERFORMANCE | 15 |
| 8 SYSTEM VERIFICATION | 23 |
| 8.1 SYSTEM SETUP..... | 23 |
| 8.2 SYSTEM VERIFICATION | 24 |
| 9 MEASUREMENT PROCEDURES | 25 |
| 9.1 TESTS TO BE PERFORMED..... | 25 |
| 9.2 GENERAL MEASUREMENT PROCEDURE | 27 |
| 9.3 WCDMA MEASUREMENT PROCEDURES FOR SAR | 28 |
| 9.4 BLUETOOTH & WI-FI MEASUREMENT PROCEDURES FOR SAR | 29 |
| 9.5 SAR MEASUREMENT FOR LTE..... | 29 |
| 9.6 POWER DRIFT..... | 30 |
| 10 AREA SCAN BASED 1-G SAR..... | 31 |
| 10.1 REQUIREMENT OF KDB | 31 |
| 10.2 FAST SAR ALGORITHMS..... | 31 |
| 11 CONDUCTED OUTPUT POWER..... | 32 |
| 11.1 GSM MEASUREMENT RESULT | 32 |
| 11.2 WCDMA MEASUREMENT RESULT | 34 |
| 11.3 LTE MEASUREMENT RESULT | 36 |

| | |
|---|------------|
| 11.4 WI-FI AND BT MEASUREMENT RESULT | 66 |
| 12 SIMULTANEOUS TX SAR CONSIDERATIONS..... | 68 |
| 12.1 INTRODUCTION..... | 68 |
| 12.2 TRANSMIT ANTENNA SEPARATION DISTANCES..... | 68 |
| 12.3 SAR MEASUREMENT POSITIONS..... | 69 |
| 12.4 STANDALONE SAR TEST EXCLUSION CONSIDERATIONS | 69 |
| 13 EVALUATION OF SIMULTANEOUS..... | 70 |
| 14 SAR TEST RESULT | 71 |
| 14.1 SAR RESULTS..... | 72 |
| 14.2 WLAN EVALUATION FOR 2.4G | 86 |
| 14.3 WLAN EVALUATION FOR 5G..... | 88 |
| 15 SAR MEASUREMENT VARIABILITY..... | 91 |
| 16 MEASUREMENT UNCERTAINTY | 92 |
| 16.1 MEASUREMENT UNCERTAINTY FOR NORMAL SAR TESTS (300MHZ~3GHZ) | 92 |
| 16.2 MEASUREMENT UNCERTAINTY FOR FAST SAR TESTS (300MHZ~3GHZ) | 93 |
| 16.3 MEASUREMENT UNCERTAINTY FOR NORMAL SAR TESTS (3GHZ~6GHZ) | 94 |
| 16.4 MEASUREMENT UNCERTAINTY FOR FAST SAR TESTS (3GHZ~6GHZ) | 95 |
| 17 MAIN TEST INSTRUMENTS..... | 96 |
| ANNEX A GRAPH RESULTS..... | 97 |
| ANNEX B SYSTEMVERIFICATION RESULTS | 125 |
| ANNEX C SAR MEASUREMENT SETUP | 144 |
| C.1 MEASUREMENT SET-UP | 144 |
| C.2 DASY5 E-FIELD PROBE SYSTEM | 145 |
| C.3 E-FIELD PROBE CALIBRATION..... | 145 |
| C.4 OTHER TEST EQUIPMENT..... | 146 |
| ANNEX D POSITION OF THE WIRELESS DEVICE IN RELATION TO THE PHANTOM | 150 |
| D.1 GENERAL CONSIDERATIONS | 150 |
| D.2 BODY-WORN DEVICE | 151 |
| D.3 DESKTOP DEVICE..... | 151 |
| D.4 DUT SETUP PHOTOS..... | 152 |
| ANNEX E EQUIVALENT MEDIA RECIPES..... | 153 |
| ANNEX F SYSTEM VALIDATION..... | 154 |
| ANNEX G DAE CALIBRATION CERTIFICATE..... | 155 |
| ANNEX H PROBE CALIBRATION CERTIFICATE..... | 163 |
| ANNEX I DIPOLE CALIBRATION CERTIFICATE..... | 174 |
| ANNEX J EXTENDED CALIBRATION SAR DIPOLE..... | 238 |

1 Test Laboratory

1.1 Testing Location

| | |
|---------------|--|
| Company Name: | Shenzhen Academy of Information and Communications Technology |
| Address: | Building G, Shenzhen International Innovation Center, No.1006 Shennan Road, Futian District, Shenzhen, Guangdong, P. R. China |
| Postal Code: | 518026 |
| Telephone: | +86-755-33322000 |
| Fax: | +86-755-33322001 |

1.2 Testing Environment

| | |
|-----------------------------|--------------|
| Temperature: | 18°C~25 °C |
| Relative humidity: | 30%~ 70% |
| Ground system resistance: | <4Ω |
| Ambient noise & Reflection: | < 0.012 W/kg |

1.3 Project Data

| | |
|---------------------|-------------------|
| Testing Start Date: | October 20, 2018 |
| Testing End Date: | November 20, 2018 |

1.4 Signature



Li Yongfu

(Prepared this test report)



Zhang Yunzhan

(Reviewed this test report)



Cao Junfei

Deputy Director of the laboratory
(Approved this test report)

2 Statement of Compliance

The maximum results of Specific Absorption Rate (SAR) found during testing for Yulong Computer Telecommunication Scientific (Shenzhen) Co., Ltd Smartphone cp3705A are as follows:

Table 2.1: Highest Reported SAR for Head (1g)

| Exposure Configuration | Technology Band | Highest Reported SAR 1g(W/Kg) | Equipment Class |
|-----------------------------------|-----------------|----------------------------------|-----------------|
| Head (Separation Distance 0mm) | GSM850 | 0.20 | PCE |
| | PCS1900 | 0.01 | |
| | UMTS FDD 5 | 0.25 | |
| | UMTS FDD 2 | 0.08 | |
| | UMTS FDD 4 | 0.11 | |
| | LTE Band 2 | 0.09 | |
| | LTE Band 4 | 0.15 | |
| | LTE Band 5 | 0.22 | |
| | LTE Band 7 | 0.18 | |
| | LTE Band 12 | 0.13 | |
| | LTE Band 66 | 0.10 | |
| | LTE Band 71 | 0.16 | |
| | WLAN 2.4GHz | 0.87 | |
| | WLAN 5GHz | 0.75 | U-NII-3 |

Table 2.2: Highest Reported SAR for Hotspot (1g)

| Exposure Configuration | Technology Band | Highest Reported SAR 1g(W/Kg) | Equipment Class |
|--|-----------------|----------------------------------|-----------------|
| Hotspot (Separation Distance 10 mm) | GSM850 | 0.41 | PCE |
| | PCS1900 | 1.19 | |
| | UMTS FDD 5 | 0.41 | |
| | UMTS FDD 2 | 1.28 | |
| | UMTS FDD 4 | 0.85 | |
| | LTE Band 2 | 0.90 | |
| | LTE Band 4 | 1.01 | |
| | LTE Band 5 | 0.51 | |
| | LTE Band 7 | 0.91 | |
| | LTE Band 12 | 0.24 | |
| | LTE Band 66 | 0.96 | |
| | LTE Band 71 | 0.22 | |
| | WLAN 2.4GHz | 0.20 | |
| | WLAN 5GHz | 0.16 | U-NII-2A |

Table 2.3: Highest Reported SAR for Body-worn (1g)

| Exposure Configuration | Technology Band | Highest Reported SAR 1g(W/Kg) | Equipment Class |
|--|-----------------|----------------------------------|-----------------|
| Body-worn (Separation Distance 15 mm) | GSM850 | 0.28 | PCE |
| | PCS1900 | 0.37 | |
| | UMTS FDD 5 | 0.27 | |
| | UMTS FDD 2 | 0.64 | |
| | UMTS FDD 4 | 0.64 | |
| | LTE Band 2 | 0.50 | |
| | LTE Band 4 | 0.97 | |
| | LTE Band 5 | 0.26 | |
| | LTE Band 7 | 0.73 | |
| | LTE Band 12 | 0.20 | |
| | LTE Band 66 | 0.57 | |
| | LTE Band 71 | 0.17 | |
| | WLAN 2.4GHz | 0.09 | DTS |
| | WLAN 5GHz | 0.09 | U-NII-2A |

The SAR values found for the Mobile Phone are below the maximum recommended levels of 1.6 W/Kg as averaged over any 1g tissue according to the ANSI C95.1-1992.

For body worn operation, this device has been tested and meets FCC RF exposure guidelines when used with any accessory that contains no metal and which provides a minimum separation distance of 10mm between this device and the body of the user. Use of other accessories may not ensure compliance with FCC RF exposure guidelines.

The EUT battery must be fully charged and checked periodically during the test to ascertain uniform power output.

The measurement together with the test system set-up is described in annex C of this test report. A detailed description of the equipment under test can be found in chapter 4 of this test report.

The highest reported SAR value is obtained at the case of **(Table 2.1 & 2.2 & 2.3)**, and the values are: **1.28 W/kg (1g)**.

Table 2.4: The sum of reported SAR values for main antenna and Wi-Fi

| / | Position | Main antenna | Wi-Fi | Sum |
|--|------------|--------------|-------|------|
| Highest reported SAR value for Head | Left Touch | 0.21 | 0.87 | 1.08 |
| Highest reported SAR value for Hotspot | Bottom | 1.28 | / | 1.28 |
| Highest reported SAR value for Body-worn | Front | 0.97 | 0.06 | 1.03 |

Table2.5: The sum of reported SAR values for main antenna and BT

| / | Position | Main antenna | BT* | Sum |
|--|-------------|--------------|------|------|
| Highest reported SAR value for Head | Right Touch | 0.25 | 0.10 | 0.35 |
| Highest reported SAR value for Hotspot | Bottom | 1.28 | / | 1.28 |
| Highest reported SAR value for Body-worn | Front | 0.97 | 0.03 | 1.00 |

BT*-Estimated SAR for Bluetooth (seethetable13.3)

According to the above tables, the highest sum of reported SAR values is **1.28 W/kg (1g)**. The detail for simultaneous transmission consideration is described in chapter 13.

3 Client Information

3.1 Applicant Information

| | |
|----------------|--|
| Company Name: | Yulong Computer Telecommunication Scientific (Shenzhen) Co., Ltd |
| Address /Post: | Building B, Boton Science Park, Chaguang Road, Xili Town, Nanshan District, Shenzhen |
| Contact: | Yentl Chen |
| Email: | chenyanting@yulong.com |
| Telephone: | +86 15927320221 |
| Fax: | / |

3.2 Manufacturer Information

| | |
|----------------|--|
| Company Name: | Yulong Computer Telecommunication Scientific (Shenzhen) Co., Ltd |
| Address /Post: | Building B, Boton Science Park, Chaguang Road, Xili Town, Nanshan District, Shenzhen |
| Contact: | Yentl Chen |
| Email: | chenyanting@yulong.com |
| Telephone: | +86 15927320221 |
| Fax: | / |

4 Equipment under Test (EUT) and Ancillary Equipment (AE)

4.1 About EUT

| | |
|-------------------------------------|---|
| Description: | Smartphone |
| Model Name: | cp3705A |
| Condition of EUT as received | No obvious damage in appearance |
| Operating mode(s): | GSM 850/1900, WCDMA 850/1700/1900, LTE_ Band 2/4/5/7/12/66/71, BT, Wi-Fi 2.4G/5G. |
| Tested Tx Frequency: | 825 – 848.8MHz (GSM 850) |
| | 1850.2 – 1910MHz (GSM 1900) |
| | 826.4 – 846.6MHz (WCDMA850 Band V) |
| | 1712.4 – 1752.6MHz (WCDMA1700 Band IV) |
| | 1852.4 – 1907.6MHz (WCDMA1900 Band II) |
| | 1850.7 – 1909.3MHz (LTE_FDD Band 2) |
| | 1710.7 – 1754.3MHz (LTE_FDD Band 4) |
| | 824.7 – 848.3MHz (LTE_FDD Band 5) |
| | 2502.5 – 2567.5MHz (LTE_FDD Band 7) |
| | 699.7 – 715.3MHz (LTE_FDD Band 12) |
| | 1710.7 – 1779.3MHz (LTE_FDD Band 66) |
| | 665.5 – 695.5MHz (LTE_FDD Band 71) |
| | 2412 – 2462MHz (Wi-Fi 2.4G) |
| 5150 – 5825MHz (Wi-Fi 5G) | |
| GPRS / EGPRS Multislot Class: | 33 |
| GPRS capability Class: | B |
| Test device Production information: | Production unit |
| Device type: | Portable device |
| Antenna type: | Integrated antenna |
| Hotspot mode: | Support |

4.2 Internal Identification of EUT used during the test

| EUT ID* | IMEI | HW Version | SW Version |
|---------|-----------------|------------|----------------------|
| EUT1 | 860667040002714 | P1 | 3705A.MPCS.181120.1D |
| EUT2 | 860667040002839 | P1 | 3705A.MPCS.181120.1D |
| EUT3 | 860667040005261 | P1 | 3705A.MPCS.181120.1D |
| EUT4 | 860667040001583 | P1 | 3705A.MPCS.181120.1D |

*EUT ID: is used to identify the test sample in the lab internally.

Note: It is performed to test SAR with the EUT 1 & 2 & 3, and conducted power with the EUT 4.

4.3 Internal Identification of AE used during the test

| AE ID* | Description | Type | Manufacturer |
|--------|-------------|----------------|-----------------|
| AE1 | Battery | Li-ion Polymer | Tianjin Lishen |
| AE2 | Battery | Li-ion Polymer | Zhuhai Coslight |

*AE ID: is used to identify the test sample in the lab internally.

5 TEST METHODOLOGY

5.1 Applicable Limit Regulations

ANSI C95.1–1992: IEEE Standard for Safety Levels with Respect to Human Exposure to Radio Frequency Electromagnetic Fields, 3 kHz to 300 GHz.

It specifies the maximum exposure limit of **1.6 W/kg** as averaged over any 1 gram of tissue for portable devices being used within 20 cm of the user in the uncontrolled environment.

5.2 Applicable Measurement Standards

IEEE 1528–2013: Recommended Practice for Determining the Peak Spatial-Average Specific Absorption Rate (SAR) in the Human Head from Wireless Communications Devices: Experimental Techniques.

KDB 447498 D01 General RF Exposure Guidance v06: Mobile and Portable Devices RF Exposure Procedures and Equipment Authorization Policies.

KDB648474 D04 Handset SAR v01r03: SAR Evaluation Considerations for Wireless Handsets.

KDB941225 D01 SAR test for 3G devices v03r01: SAR Measurement Procedures for 3G Devices

KDB941225 D05 SAR for LTE Devices v02r05: SAR Evaluation Considerations for LTE Devices

KDB 941225 D06 Hot Spot SAR v02r01: SAR Evaluation Procedures for Portable Devices with Wireless Router Capabilities

KDB 248227 D01 802.11 Wi-Fi SAR v02r02: SAR Guidance for IEEE 802.11 (Wi-Fi) Transmitters.

KDB 865664 D01 SAR measurement 100 MHz to 6 GHz v01r04: SAR Measurement Requirements for 100 MHz to 6 GHz.

KDB 865664 D02 RF Exposure Reporting v01r02: RF Exposure Compliance Reporting and Documentation Considerations

KDB 941225 D05A LTE Rel.10 KDB Inquiry Sheet v01r02: REL. 10 LTE SAR TEST GUIDANCE AND KDB INQUIRIES

6 Specific Absorption Rate (SAR)

6.1 Introduction

SAR is related to the rate at which energy is absorbed per unit mass in an object exposed to a radio field. The SAR distribution in a biological body is complicated and is usually carried out by experimental techniques or numerical modeling. The standard recommends limits for two tiers of groups, occupational/controlled and general population/uncontrolled, based on a person's awareness and ability to exercise control over his or her exposure. In general, occupational/controlled exposure limits are higher than the limits for general population/uncontrolled.

6.2 SAR Definition

The SAR definition is the time derivative (rate) of the incremental energy (dW) absorbed by (dissipated in) an incremental mass (dm) contained in a volume element (dv) of a given density (ρ). The equation description is as below:

$$SAR = \frac{d}{dt} \left(\frac{dW}{dm} \right) = \frac{d}{dt} \left(\frac{dW}{\rho dv} \right)$$

SAR is expressed in units of Watts per kilogram (W/kg)

SAR measurement can be either related to the temperature elevation in tissue by

$$SAR = c \left(\frac{\delta T}{\delta t} \right)$$

Where: C is the specific heat capacity, δT is the temperature rise and δt is the exposure duration, or related to the electrical field in the tissue by

$$SAR = \frac{\sigma |E|^2}{\rho}$$

Where: σ is the conductivity of the tissue, ρ is the mass density of tissue and E is the RMS electrical field strength.

However for evaluating SAR of low power transmitter, electrical field measurement is typically applied.

7 Tissue Simulating Liquids

7.1 Targets for tissue simulating liquid

Table 7.1: Targets for tissue simulating liquid

| Frequency (MHz) | Liquid Type | Conductivity (σ) | $\pm 5\%$ Range | Permittivity (ϵ) | $\pm 5\%$ Range |
|-----------------|-------------|---------------------------|-----------------|-----------------------------|-----------------|
| 750 | Head | 0.89 | 0.85~0.93 | 41.94 | 39.8~44.0 |
| 750 | Body | 0.96 | 0.91~1.01 | 55.50 | 52.7~58.3 |
| 835 | Head | 0.90 | 0.86~0.95 | 41.50 | 39.4~43.6 |
| 835 | Body | 0.97 | 0.92~1.02 | 55.20 | 52.4~58.0 |
| 1750 | Head | 1.37 | 1.30~1.44 | 40.08 | 38.1~42.1 |
| 1750 | Body | 1.49 | 1.42~1.56 | 53.40 | 50.7~56.1 |
| 1900 | Head | 1.40 | 1.33~1.47 | 40.00 | 38.0~42.0 |
| 1900 | Body | 1.52 | 1.44~1.60 | 53.30 | 50.6~56.0 |
| 2450 | Head | 1.80 | 1.71~1.89 | 39.20 | 37.2~41.2 |
| 2450 | Body | 1.95 | 1.85~2.05 | 52.70 | 50.1~55.3 |
| 2550 | Head | 1.91 | 1.81~2.01 | 39.07 | 37.1~41.0 |
| 2550 | Body | 2.09 | 1.99~2.19 | 52.60 | 50.0~55.2 |
| 5300 | Head | 4.76 | 4.52~5.00 | 35.87 | 34.1~37.6 |
| 5300 | Body | 5.42 | 5.15~5.69 | 48.90 | 46.5~51.3 |
| 5600 | Head | 5.07 | 4.82~5.32 | 35.53 | 33.8~37.3 |
| 5600 | Body | 5.77 | 5.48~6.06 | 48.50 | 46.1~50.9 |
| 5800 | Head | 5.27 | 5.01~5.53 | 35.30 | 33.5~37.1 |
| 5800 | Body | 6.00 | 5.70~6.30 | 48.20 | 45.8~50.6 |

7.2 Dielectric Performance

Table 7.2: Dielectric Performance of Tissue Simulating Liquid

| Measurement Date (yyyy-mm-dd) | Type | Frequency | Conductivity σ (S/m) | Drift (%) | Permittivity ϵ | Drift (%) |
|-------------------------------|------|-----------|-----------------------------|-----------|-------------------------|-----------|
| 2018-10-20 | Head | 750 | 0.919 | 3.26 | 40.55 | -3.31 |
| 2018-10-20 | Body | 750 | 0.983 | 2.40 | 53.60 | -3.42 |
| 2018-10-22 | Head | 835 | 0.884 | -1.78 | 41.97 | 1.13 |
| 2018-10-22 | Body | 835 | 0.989 | 1.96 | 53.38 | -3.30 |
| 2018-10-17 | Head | 1750 | 1.381 | 0.80 | 40.83 | 1.87 |
| 2018-10-17 | Body | 1750 | 1.458 | -2.15 | 53.69 | 0.54 |
| 2018-10-23 | Head | 1900 | 1.370 | -2.14 | 40.68 | 1.70 |
| 2018-11-20 | Body | 1900 | 1.554 | 2.24 | 52.95 | -0.66 |
| 2018-10-26 | Head | 2450 | 1.855 | 3.06 | 38.74 | -1.17 |
| 2018-10-26 | Body | 2450 | 1.928 | -1.13 | 53.23 | 1.01 |
| 2018-11-19 | Head | 2550 | 1.970 | 3.14 | 38.36 | -1.82 |
| 2018-11-19 | Body | 2550 | 2.052 | -1.82 | 52.92 | 0.61 |
| 2018-10-27 | Head | 5300 | 4.817 | 1.20 | 34.64 | -3.43 |
| 2018-10-27 | Body | 5300 | 5.634 | 3.95 | 47.95 | -1.94 |
| 2018-10-27 | Head | 5600 | 5.129 | 1.16 | 35.11 | -1.18 |
| 2018-10-27 | Body | 5600 | 5.605 | -2.86 | 49.06 | 1.15 |
| 2018-10-27 | Head | 5800 | 5.122 | -2.81 | 35.79 | 1.39 |
| 2018-10-27 | Body | 5800 | 6.139 | 2.32 | 47.58 | -1.29 |

Note: The liquid temperature is 22.0°C.

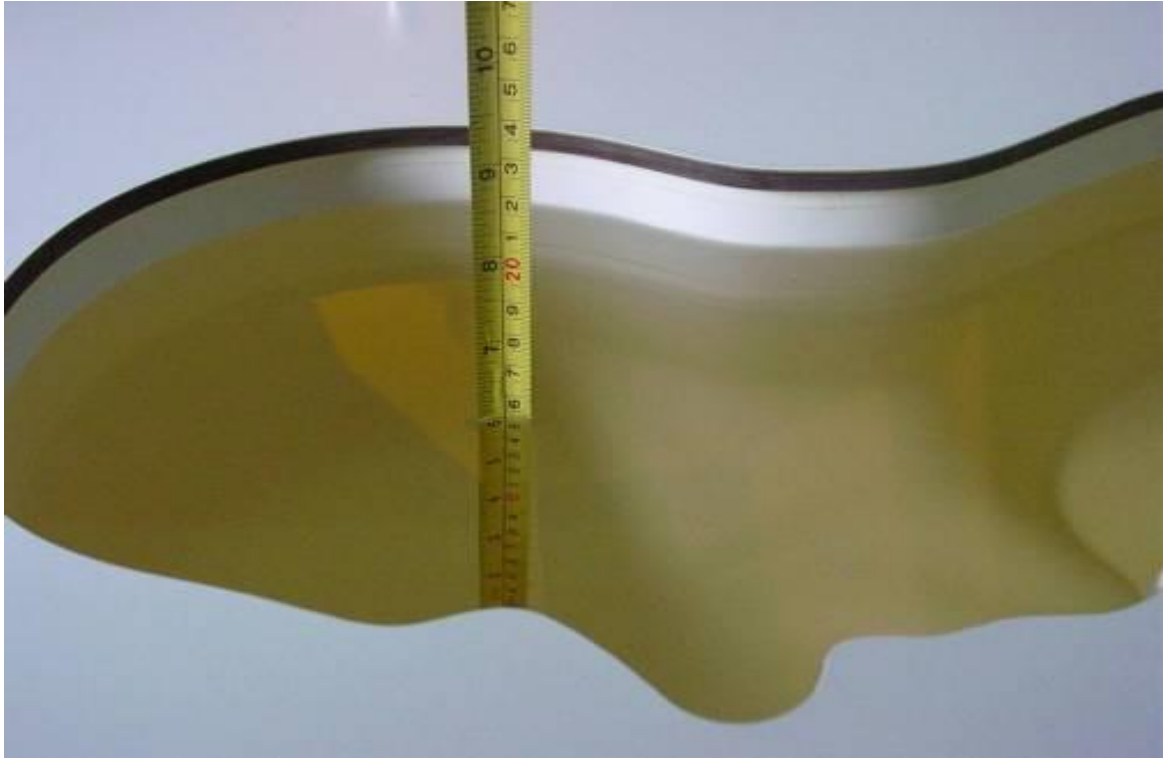

Picture 7-1: Liquid depth in the Head Phantom (750 MHz)

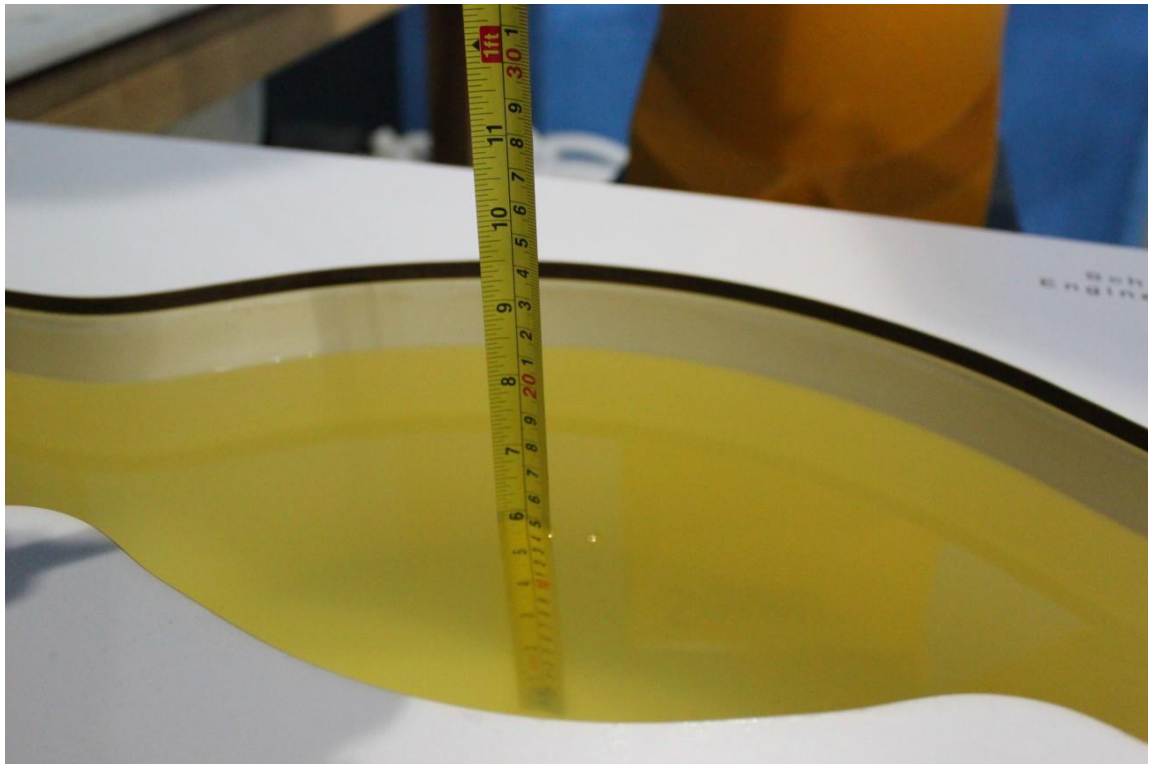

Picture 7-2: Liquid depth in the Flat Phantom (750 MHz)

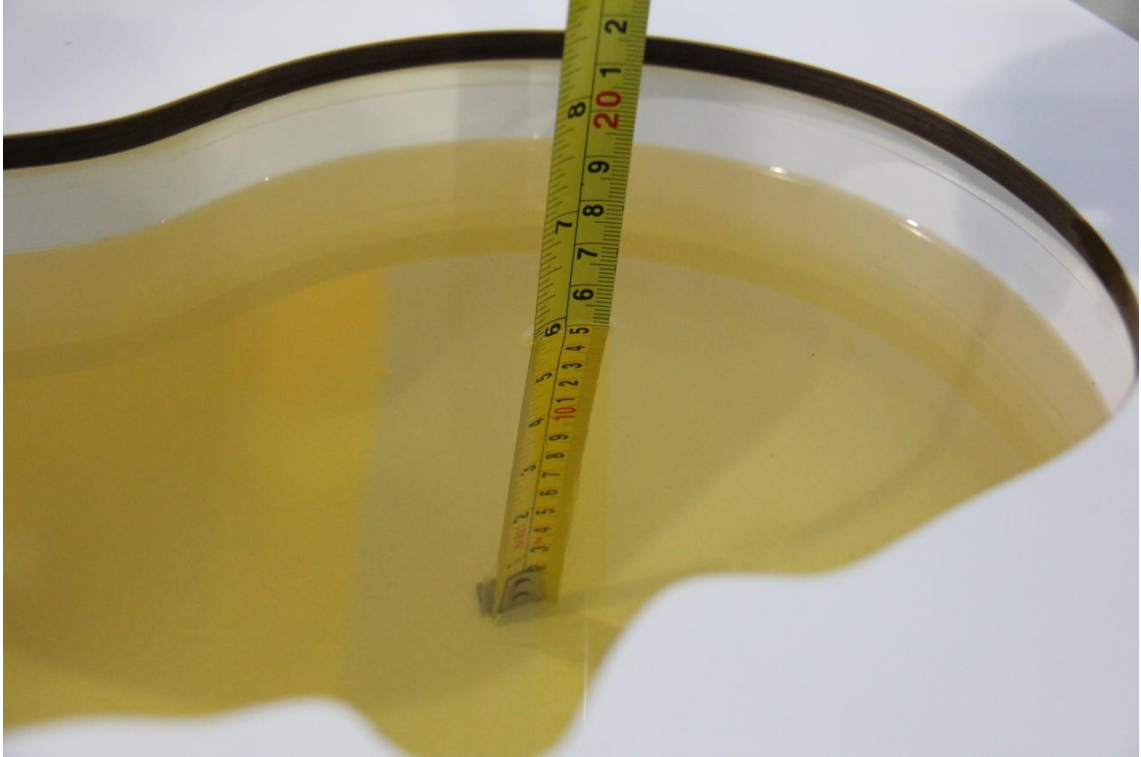

Picture 7-3: Liquid depth in the Head Phantom (835 MHz)

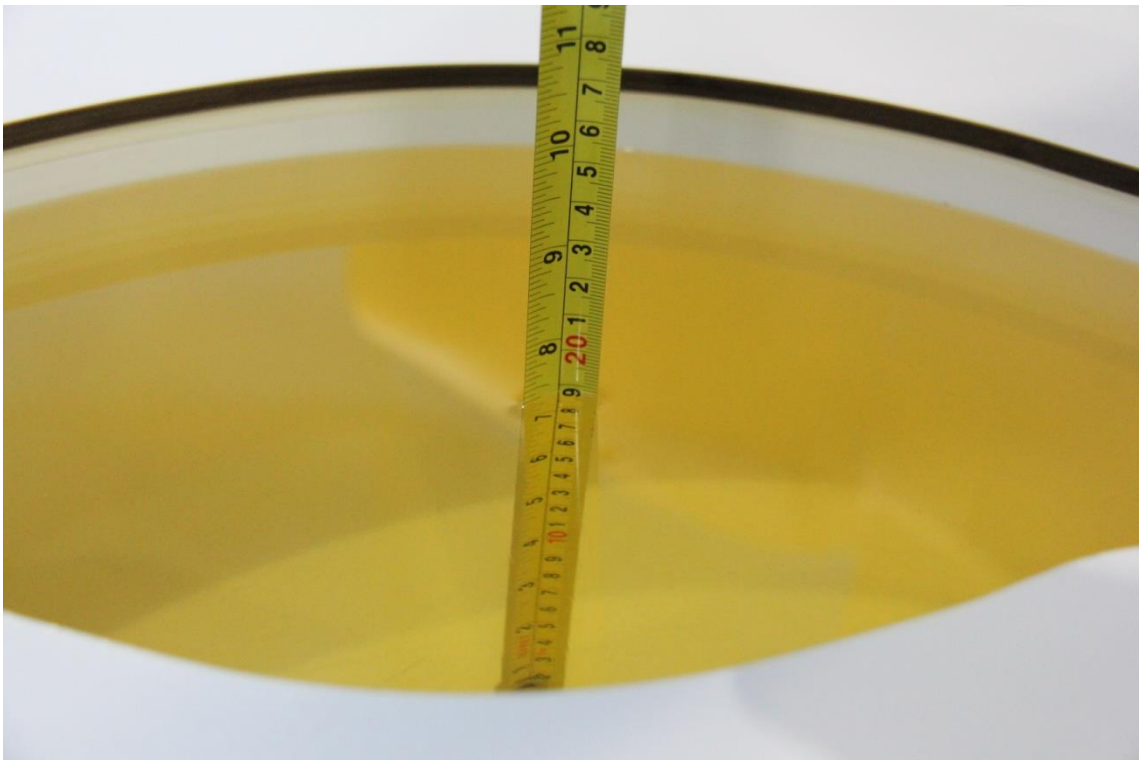

Picture 7-4: Liquid depth in the Flat Phantom (835 MHz)

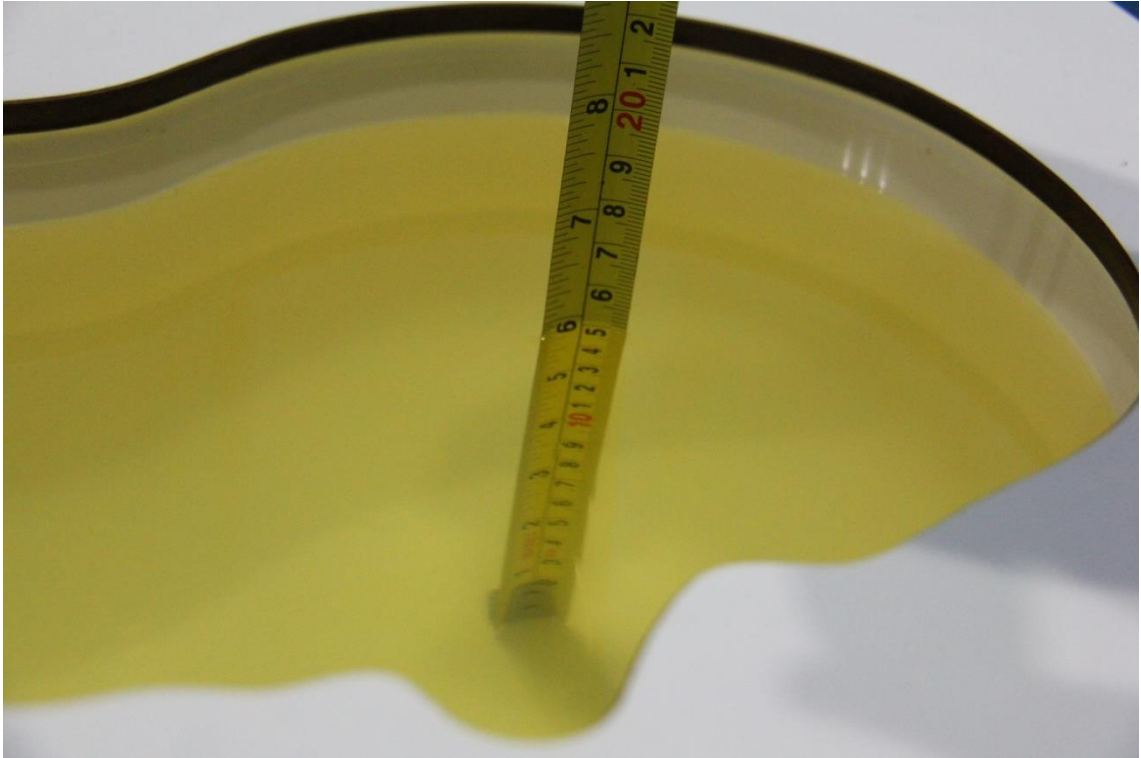

Picture 7-5: Liquid depth in the Head Phantom (1750 MHz)

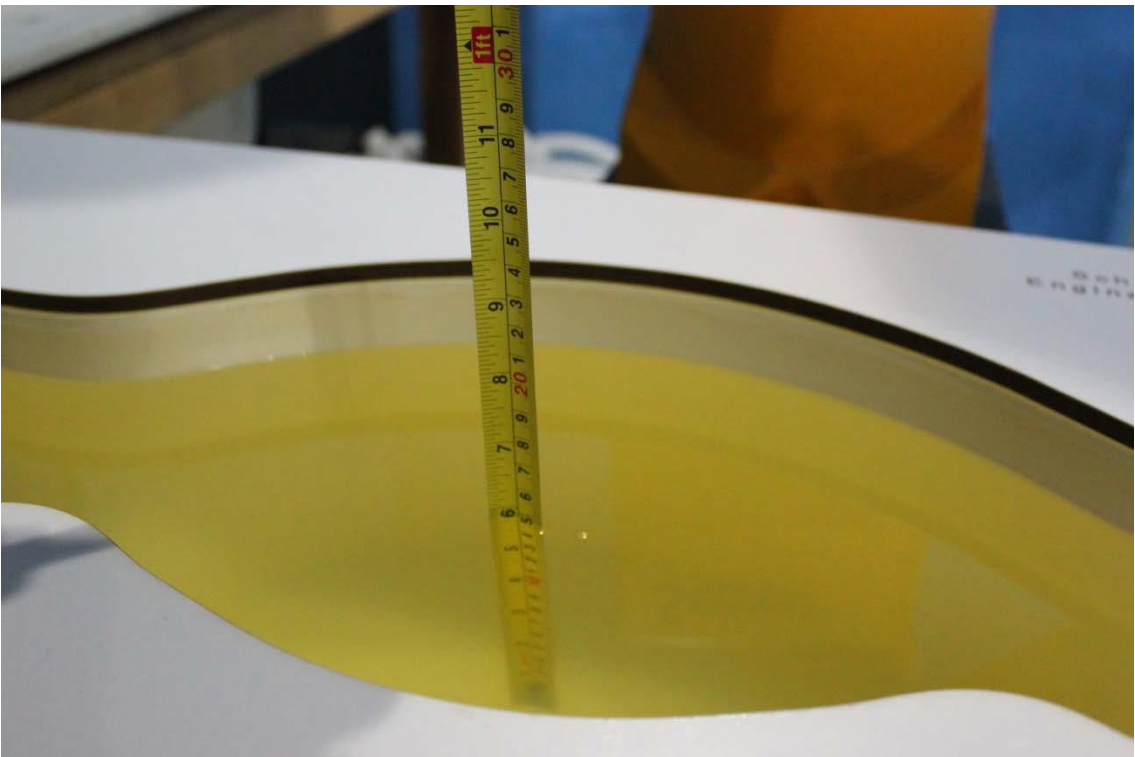

Picture 7-6: Liquid depth in the Flat Phantom (1750MHz)

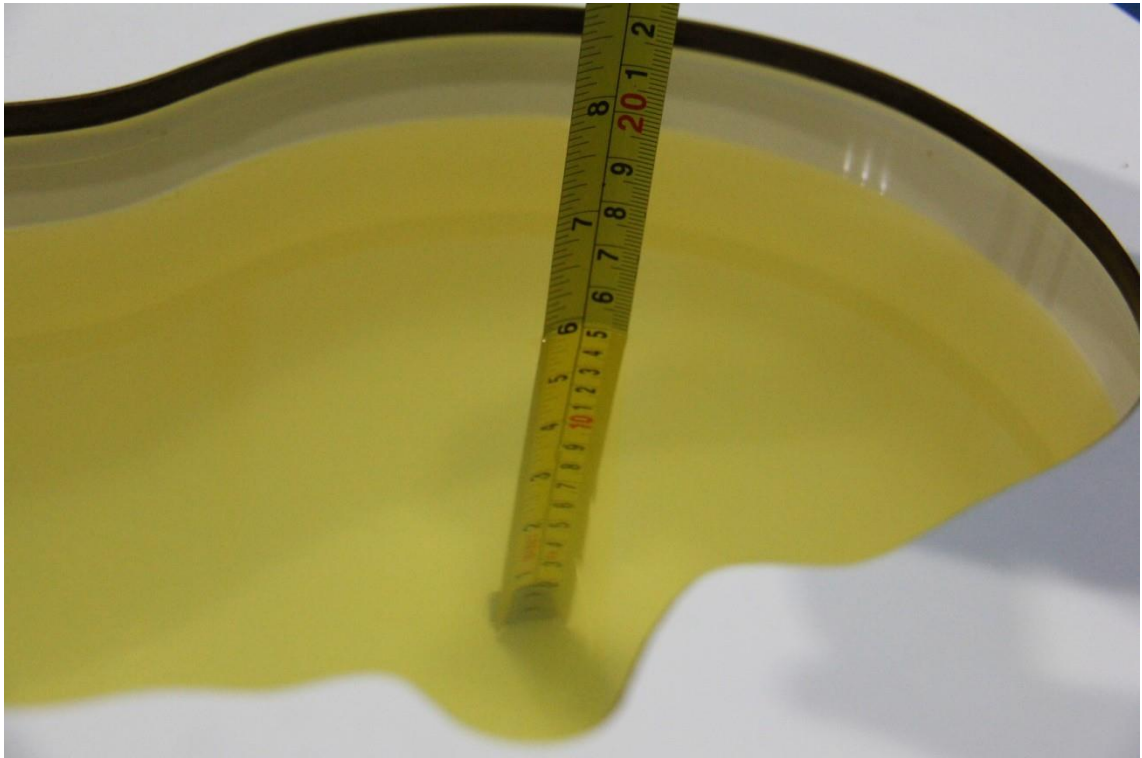

Picture 7-7: Liquid depth in the Head Phantom (1900 MHz)

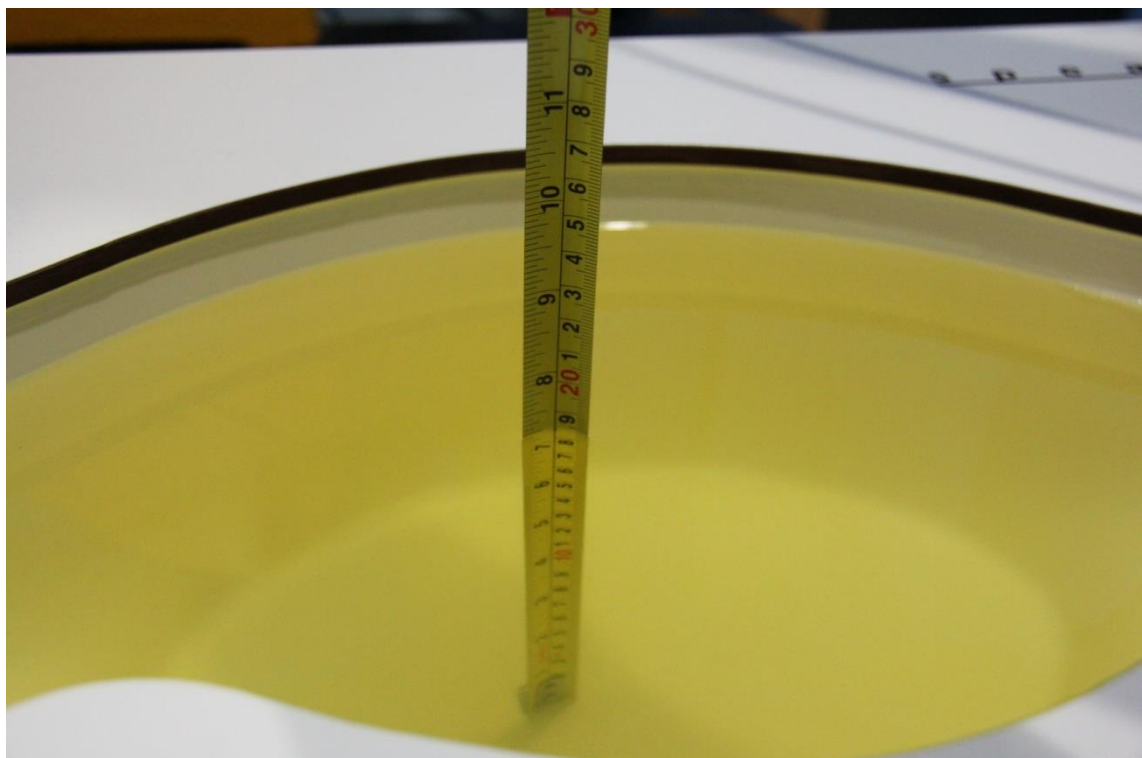

Picture 7-8: Liquid depth in the Flat Phantom (1900MHz)

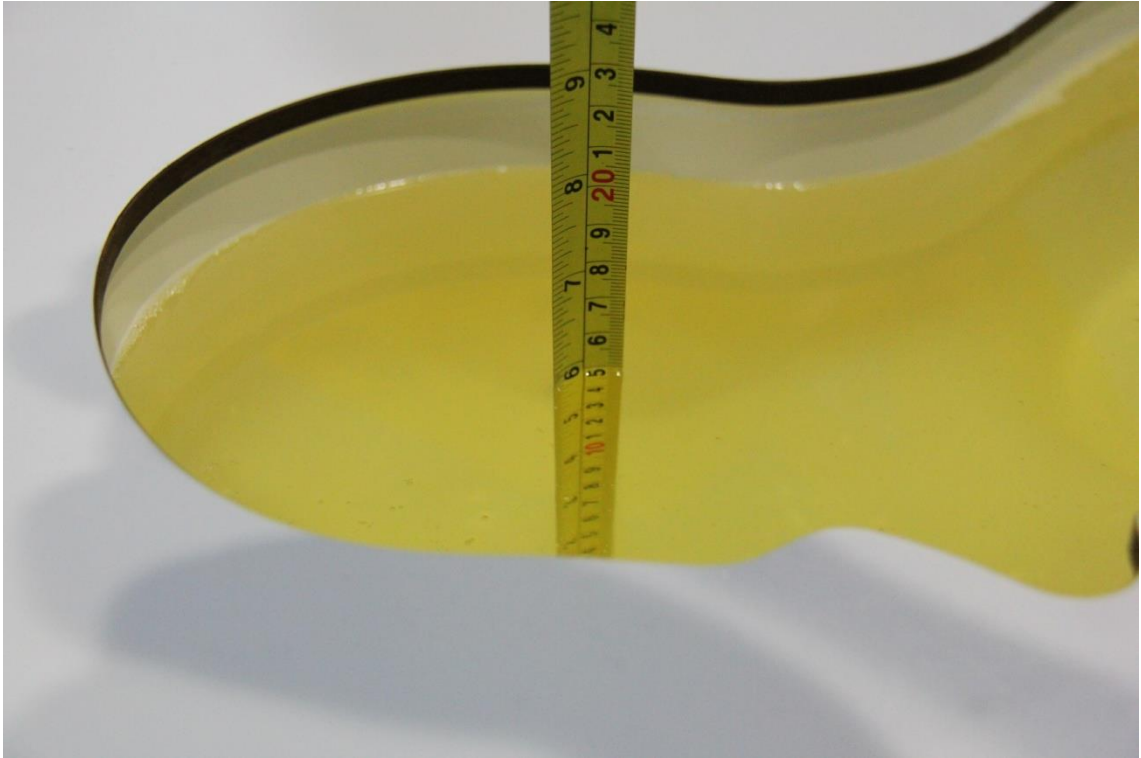

Picture 7-9: Liquid depth in the Head Phantom(2450MHz)



Picture 7-10: Liquid depth in the Flat Phantom(2450MHz)



Picture 7-11: Liquid depth in the Head Phantom(2550MHz)



Picture 7-12: Liquid depth in the Flat Phantom(2550MHz)



Picture 7-13: Liquid depth in the Head Phantom (5GHz)



Picture 7-14: Liquid depth in the Flat Phantom (5GHz)

8 System verification

8.1 System Setup

In the simplified setup for system evaluation, the DUT is replaced by a calibrated dipole and the power source is replaced by a continuous wave that comes from a signal generator. The calibrated dipole must be placed beneath the flat phantom section of the SAM twin phantom with the correct distance holder. The distance holder should touch the phantom surface with a light pressure at the reference marking and be oriented parallel to the long side of the phantom. The equipment setup is shown below:

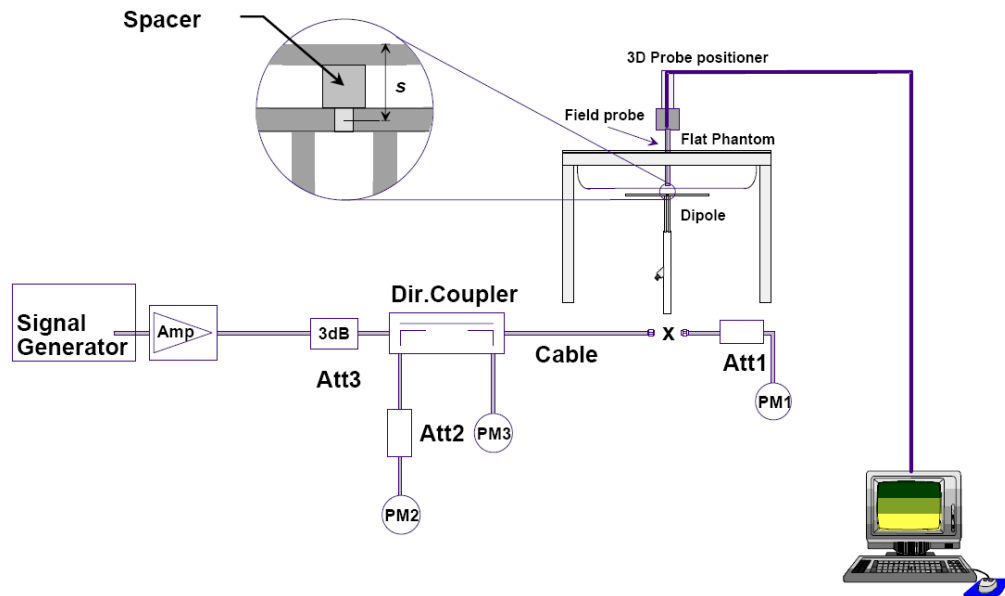

Picture 8.1 System Setup for System Evaluation



Picture 8.2 Photo of Dipole Setup

8.2 System Verification

SAR system verification is required to confirm measurement accuracy, according to the tissue dielectric media, probe calibration points and other system operating parameters required for measuring the SAR of a test device. The system verification must be performed for each frequency band and within the valid range of each probe calibration point required for testing the device.

The system verification results are required that the area scan estimated 1-g SAR is within 3% of the zoom scan 1-g SAR. The details are presented in annex B.

Table 8.1: System Verification of Head

| Measurement Date (yyyy-mm-dd) | Frequency | Target value (W/kg) | | Measured value (W/kg) | | Deviation (%) | |
|-------------------------------|-----------|---------------------|-------------|-----------------------|-------------|---------------|-------------|
| | | 10 g Average | 1 g Average | 10 g Average | 1 g Average | 10 g Average | 1 g Average |
| 2018-10-20 | 750 MHz | 5.43 | 8.26 | 5.56 | 8.60 | 2.39 | 4.12 |
| 2018-10-22 | 835 MHz | 6.29 | 9.62 | 6.20 | 9.36 | -1.43 | -2.70 |
| 2018-10-17 | 1750 MHz | 19.4 | 36.6 | 19.76 | 37.68 | 1.86 | 2.95 |
| 2018-10-23 | 1900 MHz | 21.0 | 40.8 | 20.76 | 39.72 | -1.14 | -2.65 |
| 2018-10-26 | 2450 MHz | 24.1 | 52.0 | 24.72 | 54.40 | 2.57 | 4.62 |
| 2018-11-19 | 2550 MHz | 26.5 | 57.8 | 26.92 | 59.60 | 1.58 | 3.11 |
| 2018-10-27 | 5300 MHz | 23.7 | 83.0 | 24.00 | 85.60 | 1.27 | 3.13 |
| 2018-10-27 | 5600 MHz | 23.6 | 82.9 | 23.80 | 84.40 | 0.85 | 1.81 |
| 2018-10-27 | 5800 MHz | 22.3 | 78.8 | 21.90 | 76.30 | -1.79 | -3.17 |

Table 8.2: System Verification of Body

| Measurement Date (yyyy-mm-dd) | Frequency | Target value (W/kg) | | Measured value (W/kg) | | Deviation (%) | |
|-------------------------------|-----------|---------------------|-------------|-----------------------|-------------|---------------|-------------|
| | | 10 g Average | 1 g Average | 10 g Average | 1 g Average | 10 g Average | 1 g Average |
| 2018-10-20 | 750 MHz | 5.64 | 8.58 | 5.76 | 8.88 | 2.13 | 3.50 |
| 2018-10-22 | 835 MHz | 6.56 | 9.90 | 6.72 | 10.28 | 2.44 | 3.84 |
| 2018-10-17 | 1750 MHz | 19.5 | 36.2 | 19.08 | 34.92 | -2.15 | -3.54 |
| 2018-11-20 | 1900 MHz | 21.4 | 40.6 | 21.92 | 42.40 | 2.43 | 4.43 |
| 2018-10-26 | 2450 MHz | 23.5 | 50.5 | 23.04 | 48.80 | -1.96 | -3.37 |
| 2018-11-19 | 2550 MHz | 24.7 | 54.0 | 24.44 | 52.40 | -1.05 | -2.96 |
| 2018-10-27 | 5300 MHz | 21.5 | 76.5 | 21.80 | 79.40 | 1.40 | 3.79 |
| 2018-10-27 | 5600 MHz | 22.1 | 79.1 | 21.50 | 75.70 | -2.71 | -4.30 |
| 2018-10-27 | 5800 MHz | 21.1 | 76.2 | 21.40 | 78.80 | 1.42 | 3.41 |

9 Measurement Procedures

9.1 Tests to be performed

In order to determine the highest value of the peak spatial-average SAR of a handset, all device positions, configurations and operational modes shall be tested for each frequency band according to steps 1 to 3 below. A flowchart of the test process is shown in picture 9.1.

Step 1: The tests described in 9.2 shall be performed at the channel that is closest to the center of the transmit frequency band (f_c) for:

- a) all device positions (cheek and tilt, for both left and right sides of the SAM phantom, as described in annex D),
- b) all configurations for each device position in a), e.g., antenna extended and retracted, and
- c) all operational modes, e.g., analogue and digital, for each device position in a) and configuration in b) in each frequency band.

If more than three frequencies need to be tested according to 11.1 (i.e., $N_c > 3$), then all frequencies, configurations and modes shall be tested for all of the above test conditions.

Step 2: For the condition providing highest peak spatial-average SAR determined in Step 1, perform all tests described in 9.2 at all other test frequencies, i.e., lowest and highest frequencies. In addition, for all other conditions (device position, configuration and operational mode) where the peak spatial-average SAR value determined in Step 1 is within 3 dB of the applicable SAR limit, it is recommended that all other test frequencies shall be tested as well.

Step 3: Examine all data to determine the highest value of the peak spatial-average SAR found in Steps 1 to 2.

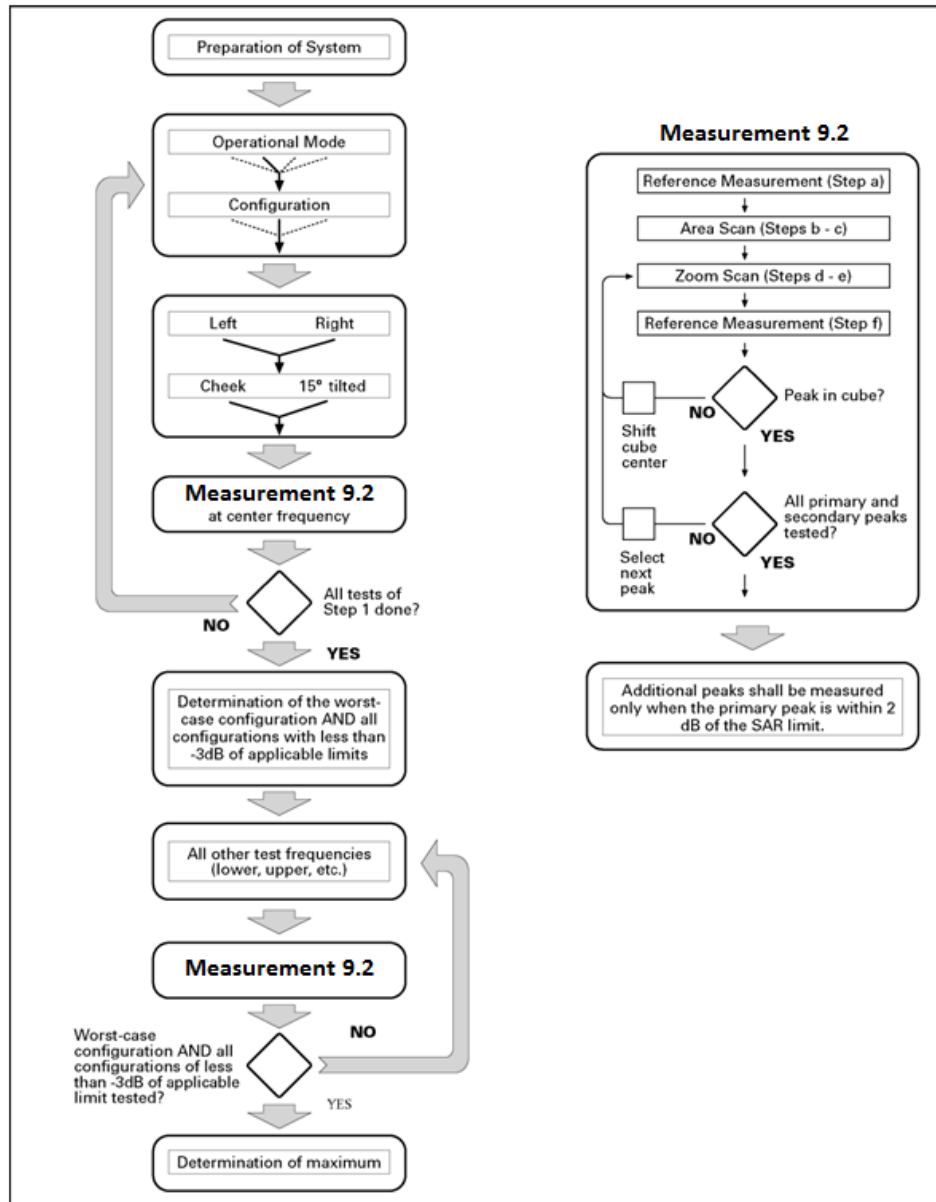

Picture 9.1 Block diagram of the tests to be performed

9.2 General Measurement Procedure

The area and zoom scan resolutions specified in the table below must be applied to the SAR measurements and fully documented in SAR reports to qualify for TCB approval. Probe boundary effect error compensation is required for measurements with the probe tip closer than half a probe tip diameter to the phantom surface. Both the probe tip diameter and sensor offset distance must satisfy measurement protocols; to ensure probe boundary effect errors are minimized and the higher fields closest to the phantom surface can be correctly measured and extrapolated to the phantom surface for computing 1-g SAR. Tolerances of the post-processing algorithms must be verified by the test laboratory for the scan resolutions used in the SAR measurements, according to the reference distribution functions specified in IEEE Std 1528-2013. The results should be documented as part of the system validation records and may be requested to support test results when all the measurement parameters in the following table are not satisfied.

| | | ≤ 3 GHz | > 3 GHz | |
|---|------------------------------------|--|---|--|
| Maximum distance from closest measurement point (geometric center of probe sensors) to phantom surface | | 5 ± 1 mm | $\frac{1}{2} \cdot \delta \cdot \ln(2) \pm 0.5$ mm | |
| Maximum probe angle from probe axis to phantom surface normal at the measurement location | | $30^\circ \pm 1^\circ$ | $20^\circ \pm 1^\circ$ | |
| Maximum area scan spatial resolution: $\Delta x_{Area}, \Delta y_{Area}$ | | ≤ 2 GHz: ≤ 15 mm 2 – 3 GHz: ≤ 12 mm | 3 – 4 GHz: ≤ 12 mm 4 – 6 GHz: ≤ 10 mm | |
| | | When the x or y dimension of the test device, in the measurement plane orientation, is smaller than the above, the measurement resolution must be \leq the corresponding x or y dimension of the test device with at least one measurement point on the test device. | | |
| Maximum zoom scan spatial resolution: $\Delta x_{Zoom}, \Delta y_{Zoom}$ | | ≤ 2 GHz: ≤ 8 mm 2 – 3 GHz: ≤ 5 mm* | 3 – 4 GHz: ≤ 5 mm* 4 – 6 GHz: ≤ 4 mm* | |
| Maximum zoom scan spatial resolution, normal to phantom surface | uniform grid: $\Delta z_{Zoom}(n)$ | ≤ 5 mm | 3 – 4 GHz: ≤ 4 mm 4 – 5 GHz: ≤ 3 mm 5 – 6 GHz: ≤ 2 mm | |
| | graded grid | $\Delta z_{Zoom}(1)$: between 1 st two points closest to phantom surface | ≤ 4 mm | 3 – 4 GHz: ≤ 3 mm 4 – 5 GHz: ≤ 2.5 mm 5 – 6 GHz: ≤ 2 mm |
| | | $\Delta z_{Zoom}(n>1)$: between subsequent points | $\leq 1.5 \cdot \Delta z_{Zoom}(n-1)$ | |
| Minimum zoom scan volume | x, y, z | ≥ 30 mm | 3 – 4 GHz: ≥ 28 mm 4 – 5 GHz: ≥ 25 mm 5 – 6 GHz: ≥ 22 mm | |
| Note: δ is the penetration depth of a plane-wave at normal incidence to the tissue medium; see draft standard IEEE P1528-2011 for details. | | | | |
| * When zoom scan is required and the reported SAR from the area scan based 1-g SAR estimation procedures of KDB 447498 is ≤ 1.4 W/kg, ≤ 8 mm, ≤ 7 mm and ≤ 5 mm zoom scan resolution may be applied, respectively, for 2 GHz to 3 GHz, 3 GHz to 4 GHz and 4 GHz to 6 GHz. | | | | |

9.3 WCDMA Measurement Procedures for SAR

The following procedures are applicable to WCDMA handsets operating under 3GPP Release99, Release 5 and Release 6. The default test configuration is to measure SAR with an established radio link between the DUT and a communication test set using a 12.2kbps RMC (reference measurement channel) configured in Test Loop Mode 1. SAR is selectively confirmed for other physical channel configurations (DPCCH & DPDCH_n), HSDPA and HSPA (HSUPA/HSDPA) modes according to output power, exposure conditions and device operating capabilities. Both uplink and downlink should be configured with the same RMC or AMR, when required. SAR for Release 5 HSDPA and Release 6 HSPA are measured using the applicable FRC (fixed reference channel) and E-DCH reference channel configurations. Maximum output power is verified according to applicable versions of 3GPP TS 34.121 and SAR must be measured according to these maximum output conditions. When Maximum Power Reduction (MPR) is not implemented according to Cubic Metric (CM) requirements for Release 6 HSPA, the following procedures do not apply.

For Release 5 HSDPA Data Devices:

| Sub-test | β_c | β_d | β_d (SF) | β_c / β_d | β_{hs} | CM/dB |
|----------|-----------|-----------|----------------|---------------------|--------------|-------|
| 1 | 2/15 | 15/15 | 64 | 2/15 | 4/15 | 0.0 |
| 2 | 12/15 | 15/15 | 64 | 12/15 | 24/25 | 1.0 |
| 3 | 15/15 | 8/15 | 64 | 15/8 | 30/15 | 1.5 |
| 4 | 15/15 | 4/15 | 64 | 15/4 | 30/15 | 1.5 |

For Release 6 HSPA Data Devices

| Sub-test | β_c | β_d | β_d (SF) | β_c / β_d | β_{hs} | β_{ec} | β_{ed} | β_{ed} (SF) | β_{ed} (codes) | CM (dB) | MPR (dB) | AG Index | E-TFCI |
|----------|-----------|-----------|----------------|---------------------|--------------|--------------|--|-------------------|----------------------|---------|----------|----------|--------|
| 1 | 11/15 | 15/15 | 64 | 11/15 | 22/15 | 209/225 | 1039/225 | 4 | 1 | 1.0 | 0.0 | 20 | 75 |
| 2 | 6/15 | 15/15 | 64 | 6/15 | 12/15 | 12/15 | 12/15 | 4 | 1 | 3.0 | 2.0 | 12 | 67 |
| 3 | 15/15 | 9/15 | 64 | 15/9 | 30/15 | 30/15 | $\beta_{ed1}:47/15$ $\beta_{ed2}:47/15$ | 4 | 2 | 2.0 | 1.0 | 15 | 92 |
| 4 | 2/15 | 15/15 | 64 | 2/15 | 4/15 | 4/15 | 56/75 | 4 | 1 | 3.0 | 2.0 | 17 | 71 |
| 5 | 15/15 | 15/15 | 64 | 15/15 | 24/15 | 30/15 | 134/15 | 4 | 1 | 1.0 | 0.0 | 21 | 81 |

9.4 Bluetooth & WI-FI Measurement Procedures for SAR

Normal network operating configurations are not suitable for measuring the SAR of 802.11 transmitters in general. Unpredictable fluctuations in network traffic and antenna diversity conditions can introduce undesirable variations in SAR results. The SAR for these devices should be measured using chipset based test mode software to ensure that the results are consistent and reliable.

Chipset based test mode software is hardware dependent and generally varies among manufacturers. The device operating parameters established in a test mode for SAR measurements must be identical to those programmed in production units, including output power levels, amplifier gain settings and other RF performance tuning parameters. The test frequencies should correspond to actual channel frequencies defined for domestic use. SAR for devices with switched diversity should be measured with only one antenna transmitting at a time during each SAR measurement, according to a fixed modulation and data rate. The same data pattern should be used for all measurements.

9.5 SAR Measurement for LTE

SAR tests for LTE are performed with a base station simulator, Anristu MT8820C. Closed loop power control was used so the UE transmits with maximum output power during SAR testing. All powers were measured with the Anristu MT8820C. It is performed for conducted power and SAR based on the KDB941225 D05.

SAR is evaluated separately according to the following procedures for the different test positions in each exposure condition – head, body, body-worn accessories and other use conditions. The procedures in the following subsections are applied separately to test each LTE frequency band.

1) QPSK with 1 RB allocation

Start with the largest channel bandwidth and measure SAR for QPSK with 1 RB allocation, using the RB offset and required test channel combination with the highest maximum output power among RB offsets at the upper edge, middle and lower edge of each required test channel. When the reported SAR is ≤ 0.8 W/kg, testing of the remaining RB offset configurations and required test channels is not required for 1 RB allocation; otherwise, SAR is required for the remaining required test channels and only for the RB offset configuration with the highest output power for that channel. When the reported SAR of a required test channel is > 1.45 W/kg, SAR is required for all three RB offset configurations for that required test channel.

2) QPSK with 50% RB allocation

The procedures required for 1 RB allocation in 1) are applied to measure the SAR for QPSK with 50% RB allocation.

3) QPSK with 100% RB allocation

For QPSK with 100% RB allocation, SAR is not required when the highest maximum output power for 100 % RB allocation is less than the highest maximum output power in 50% and 1 RB allocations and the highest reported SAR for 1 RB and 50% RB allocation in 1) and 2) are ≤ 0.8 W/kg. Otherwise, SAR is measured for the highest output power channel; and if the reported SAR is > 1.45 W/kg, the remaining required test channels must also be tested.

9.6 Power Drift

To control the output power stability during the SAR test, DASY5 system calculates the power drift by measuring the E-field at the same location at the beginning and at the end of the measurement for each test position. These drift values can be found in Section 14 labeled as: (Power Drift [dB]). This ensures that the power drift during one measurement is within 5%.

10 Area Scan Based 1-g SAR

10.1 Requirement of KDB

According to the KDB447498 D01, when the implementation is based the specific polynomial fit algorithm as presented at the 29th Bioelectromagnetics Society meeting (2007) and the estimated 1-gSAR is ≤ 1.2 W/kg, a zoom scan measurement is not required provided it is also not needed for any other purpose; for example, if the peak SAR location required for simultaneous transmission SAR test exclusion can be determined accurately by the SAR system or manually to discriminate between distinctive peaks and scattered noisy SAR distributions from area scans.

There must not be any warning or alert messages due to various measurement concerns identified by the SAR system; for example, noise in measurements, peaks too close to scan boundary, peaks are too sharp, spatial resolution and uncertainty issues etc. The SAR system verification must also demonstrate that the area scan estimated 1-g SAR is within 3% of the zoom scan 1-g SAR (See Annex B). When all the SAR results for each exposure condition in a frequency band and wireless mode are based on estimated 1-g SAR, the 1-g SAR for the highest SAR configuration must be determined by a zoom scan.

10.2 Fast SAR Algorithms

The approach is based on the area scan measurement applying a frequency dependent attenuation parameter. This attenuation parameter was empirically determined by analyzing a large number of phones. The MOTOROLA FAST SAR was developed and validated by the MOTOROLA Research Group in Ft. Lauderdale.

In the initial study, an approximation algorithm based on Linear fit was developed. The accuracy of the algorithm has been demonstrated across a broad frequency range (136-2450 MHz) and for both 1- and 10-g averaged SAR using a sample of 264 SAR measurements from 55 wireless handsets. For the sample size studied, the root-mean-squared errors of the algorithm are 1.2% and 5.8% for 1- and 10-g averaged SAR, respectively. The paper describing the algorithm in detail is expected to be published in August 2004 within the Special Issue of Transactions on MTT.

In the second step, the same research group optimized the fitting algorithm to an Polynomial fit whereby the frequency validity was extended to cover the range 30-6000MHz. Details of this study can be found in the BEMS 2007 Proceedings.

Both algorithms are implemented in DASY software.

11 Conducted Output Power

11.1 GSM Measurement result

During the process of testing, the EUT was controlled via Agilent Digital Radio Communication tester (E5515C) to ensure the maximum power transmission and proper modulation. This result contains conducted output power for the EUT. In all cases, the measured peak output power should be greater and within 5% than EMI measurement.

Table 11.1: The conducted power measurement results for GSM850/1900

Full Power

| GSM 850MHz | Tune up | Conducted Power (dBm) | | |
|----------------|-------------|---------------------------|-----------------------|---------------------------|
| | | Channel 251(848.8MHz) | Channel 190(836.6MHz) | Channel 128(824.2MHz) |
| | 34.5 | 34.22 | 34.31 | 34.30 |
| GSM 1900MHz | Tune up | Conducted Power(dBm) | | |
| | | Channel 810(1909.8MHz) | Channel 661(1880MHz) | Channel 512(1850.2MHz) |
| | 30.5 | 29.79 | 30.05 | 30.32 |

Table 11.2: The conducted power measurement results for GPRS and EGPRS

Full Power

| GPRS 850 | Tune up | Measured Power (dBm) | | | calculation | Average Power (dBm) | | |
|---------------------|-------------|----------------------|--------------|--------------|----------------|----------------------|--------------|--------------|
| | | 251 | 190 | 128 | | 251 | 190 | 128 |
| 1Tx-slots | 34.5 | 34.17 | 34.27 | 34.26 | -9.03dB | 25.14 | 25.24 | 25.23 |
| 2Tx-slots | 33 | 32.24 | 32.34 | 32.46 | -6.02dB | 26.22 | 26.32 | 26.44 |
| 3Tx-slots | 31 | 29.99 | 30.06 | 30.14 | -4.26dB | 25.73 | 25.80 | 25.88 |
| 4Tx-slots | 30.5 | 29.61 | 29.76 | 29.92 | -3.01dB | 26.60 | 26.75 | 26.91 |
| EGPRS 850 (8PSK) | Tune up | Measured Power (dBm) | | | calculation | Measured Power (dBm) | | |
| | | 251 | 190 | 128 | | 251 | 190 | 128 |
| 1Tx-slots | 28 | 27.39 | 27.54 | 27.69 | -9.03dB | 18.36 | 18.51 | 18.66 |
| 2Tx-slots | 27 | 26.29 | 26.41 | 26.59 | -6.02dB | 20.27 | 20.39 | 20.57 |
| 3Tx-slots | 24 | 23.49 | 23.48 | 23.68 | -4.26dB | 19.23 | 19.22 | 19.42 |
| 4Tx-slots | 24 | 23.33 | 23.30 | 23.52 | -3.01dB | 20.32 | 20.29 | 20.51 |

Full Power

| GPRS 1900 | Tune up | Measured Power (dBm) | | | calculation | Average Power (dBm) | | |
|-------------------|-------------|----------------------|--------------|--------------|----------------|----------------------|--------------|--------------|
| | | 810 | 661 | 512 | | 810 | 661 | 512 |
| 1Tx-slots | 30.5 | 29.73 | 30.07 | 30.25 | -9.03dB | 20.70 | 21.04 | 21.22 |
| 2Tx-slots | 29 | 28.02 | 28.15 | 28.26 | -6.02dB | 22.00 | 22.13 | 22.24 |
| 3Tx-slots | 28 | 27.05 | 26.83 | 27.06 | -4.26dB | 22.79 | 22.57 | 22.80 |
| 4Tx-slots | 26.5 | 25.87 | 25.79 | 25.90 | -3.01dB | 22.86 | 22.78 | 22.89 |
| EGPRS 1900 (8PSK) | Tune up | Measured Power (dBm) | | | calculation | Measured Power (dBm) | | |
| | | 810 | 661 | 512 | | 810 | 661 | 512 |
| 1Tx-slots | 27 | 25.80 | 25.89 | 26.03 | -9.03dB | 16.77 | 16.86 | 17.00 |
| 2Tx-slots | 26 | 25.12 | 25.23 | 25.35 | -6.02dB | 19.10 | 19.21 | 19.33 |
| 3Tx-slots | 23 | 22.10 | 22.07 | 22.09 | -4.26dB | 17.84 | 17.81 | 17.83 |
| 4Tx-slots | 23 | 21.94 | 22.02 | 21.98 | -3.01dB | 18.93 | 19.01 | 18.97 |

Hotspot on

| GPRS 1900 | Tune up | Measured Power (dBm) | | | calculation | Average Power (dBm) | | |
|-------------------|-----------|----------------------|--------------|--------------|----------------|----------------------|--------------|--------------|
| | | 810 | 661 | 512 | | 810 | 661 | 512 |
| 1Tx-slots | 25 | 24.52 | 24.61 | 24.30 | -9.03dB | 15.49 | 15.58 | 15.27 |
| 2Tx-slots | 25 | 24.26 | 24.21 | 24.28 | -6.02dB | 18.24 | 18.19 | 18.26 |
| 3Tx-slots | 25 | 24.17 | 24.16 | 24.15 | -4.26dB | 19.91 | 19.9 | 19.89 |
| 4Tx-slots | 25 | 24.04 | 24.10 | 24.02 | -3.01dB | 21.03 | 21.09 | 21.01 |
| EGPRS 1900 (8PSK) | Tune up | Measured Power (dBm) | | | calculation | Measured Power (dBm) | | |
| | | 810 | 661 | 512 | | 810 | 661 | 512 |
| 1Tx-slots | 25 | 24.07 | 24.14 | 24.22 | -9.03dB | 15.04 | 15.11 | 15.19 |
| 2Tx-slots | 25 | 24.22 | 24.27 | 24.26 | -6.02dB | 18.20 | 18.25 | 18.24 |
| 3Tx-slots | 22 | 21.53 | 21.56 | 21.57 | -4.26dB | 17.27 | 17.30 | 17.31 |
| 4Tx-slots | 22 | 21.46 | 21.40 | 21.47 | -3.01dB | 18.45 | 18.39 | 18.46 |

NOTES:

1) Division Factors

To average the power, the division factor is as follows:

1TX-slot = 1 transmit time slot out of 8 time slots=> conducted power divided by (8/1) => -9.03dB

2TX-slots = 2 transmit time slots out of 8 time slots=> conducted power divided by (8/2) => -6.02dB

3TX-slots = 3 transmit time slots out of 8 time slots=> conducted power divided by (8/3) => -4.26dB

4TX-slots = 4 transmit time slots out of 8 time slots=> conducted power divided by (8/4) => -3.01dB

According to the conducted power as above, the body measurements are performed with 4Txslots for 850MHz and 1900MHz.

11.2 WCDMA Measurement result

Table 11.3: The conducted Power for WCDMA850/1700/1900

Full Power

| Item | band | FDD Band 5 result | | | |
|----------|-------|-------------------|--------------------|--------------------|--------------------|
| | ARFCN | Tune up | 4233 (846.6MHz) | 4182 (836.4MHz) | 4132 (826.4MHz) |
| WCDMA | \ | 24.5 | 23.7 | 23.7 | 23.5 |
| HSUPA | 1 | 24 | 22.7 | 22.7 | 22.6 |
| | 2 | 22 | 20.7 | 20.7 | 20.7 |
| | 3 | 23 | 21.7 | 21.7 | 21.6 |
| | 4 | 22 | 20.7 | 20.7 | 20.7 |
| | 5 | 24 | 22.6 | 22.6 | 22.6 |
| HSDPA | 1 | 23.5 | 22.7 | 22.6 | 22.4 |
| | 2 | 23.5 | 22.6 | 22.6 | 22.4 |
| | 3 | 23.5 | 22.2 | 22.2 | 22.0 |
| | 4 | 23.5 | 22.2 | 22.2 | 21.9 |
| DC-HSDPA | 1 | 23.5 | 22.5 | 22.5 | 22.2 |
| | 2 | 23.5 | 22.3 | 22.2 | 22.0 |
| | 3 | 23.5 | 22.0 | 22.1 | 21.9 |
| | 4 | 23.5 | 22.1 | 22.0 | 21.8 |

Full Power

| Item | band | FDD Band 2 result | | | |
|----------|-------|-------------------|---------------------|---------------------|---------------------|
| | ARFCN | Tune up | 9538 (1907.6MHz) | 9400 (1880MHz) | 9262 (1852.4MHz) |
| WCDMA | \ | 24.5 | 23.9 | 23.8 | 24.2 |
| HSUPA | 1 | 24 | 23.0 | 22.9 | 23.2 |
| | 2 | 22 | 21.0 | 20.8 | 21.2 |
| | 3 | 23 | 21.9 | 21.9 | 22.2 |
| | 4 | 22 | 20.9 | 20.9 | 21.2 |
| | 5 | 24 | 23.0 | 22.9 | 23.2 |
| HSDPA | 1 | 24 | 23.2 | 23.0 | 23.2 |
| | 2 | 24 | 23.2 | 23.0 | 23.3 |
| | 3 | 24 | 22.6 | 22.5 | 22.8 |
| | 4 | 24 | 22.6 | 22.5 | 22.8 |
| DC-HSDPA | 1 | 24 | 23.1 | 22.9 | 23.0 |
| | 2 | 24 | 23.0 | 22.8 | 23.1 |
| | 3 | 24 | 22.5 | 22.3 | 22.6 |
| | 4 | 24 | 22.4 | 22.3 | 22.7 |
| Item | band | FDD Band 4 result | | | |
| | ARFCN | Tune up | 1513 (1752.6MHz) | 1413 (1732.6MHz) | 1312 (1712.4MHz) |
| WCDMA | \ | 24.5 | 24.0 | 24.1 | 24.0 |
| HSUPA | 1 | 24 | 23.1 | 23.1 | 23.1 |
| | 2 | 22 | 21.0 | 21.1 | 21.2 |
| | 3 | 23 | 22.0 | 22.1 | 22.1 |
| | 4 | 22 | 21.0 | 21.1 | 21.1 |
| | 5 | 24 | 23.0 | 23.1 | 23.1 |
| HSDPA | 1 | 24 | 23.2 | 23.4 | 23.2 |
| | 2 | 24 | 23.3 | 23.4 | 23.4 |
| | 3 | 24 | 22.6 | 22.9 | 22.8 |
| | 4 | 24 | 22.6 | 22.9 | 22.8 |
| DC-HSDPA | 1 | 24 | 23.0 | 23.3 | 23.0 |
| | 2 | 24 | 23.1 | 23.2 | 23.3 |
| | 3 | 24 | 22.4 | 22.7 | 22.6 |
| | 4 | 24 | 22.5 | 22.8 | 22.7 |

Hotspot on

| Item | band | FDD Band 2 result | | | |
|----------|-------|-------------------|---------------------|---------------------|---------------------|
| | ARFCN | Tune up | 9538 (1907.6MHz) | 9400 (1880MHz) | 9262 (1852.4MHz) |
| WCDMA | \ | 20 | 19.1 | 19.1 | 19.4 |
| HSDPA | 1 | 19 | 18.1 | 18.1 | 18.4 |
| | 2 | 17 | 16.1 | 16.1 | 16.3 |
| | 3 | 18 | 17.2 | 17.1 | 17.4 |
| | 4 | 17 | 16.2 | 16.1 | 16.3 |
| | 5 | 19 | 18.1 | 18.1 | 18.4 |
| HSDPA | 1 | 19 | 18.1 | 18.1 | 18.4 |
| | 2 | 19 | 18.1 | 18.1 | 18.3 |
| | 3 | 19 | 17.6 | 17.6 | 17.9 |
| | 4 | 19 | 17.6 | 17.6 | 17.9 |
| DC-HSDPA | 1 | 19 | 18.0 | 17.9 | 18.2 |
| | 2 | 19 | 17.9 | 18.0 | 18.1 |
| | 3 | 19 | 17.5 | 17.4 | 17.7 |
| | 4 | 19 | 17.4 | 17.4 | 17.6 |
| Item | band | FDD Band 4 result | | | |
| | ARFCN | Tune up | 1513 (1752.6MHz) | 1413 (1732.6MHz) | 1312 (1712.4MHz) |
| WCDMA | \ | 20 | 19.4 | 19.4 | 19.4 |
| HSDPA | 1 | 19 | 18.4 | 18.4 | 18.5 |
| | 2 | 17 | 16.3 | 16.3 | 16.5 |
| | 3 | 18 | 17.3 | 17.4 | 17.5 |
| | 4 | 17 | 16.4 | 16.4 | 16.5 |
| | 5 | 19 | 18.4 | 18.4 | 18.5 |
| HSDPA | 1 | 19 | 18.3 | 18.4 | 18.4 |
| | 2 | 19 | 18.3 | 18.4 | 18.5 |
| | 3 | 19 | 17.9 | 17.8 | 18.0 |
| | 4 | 19 | 17.9 | 17.8 | 18.0 |
| DC-HSDPA | 1 | 19 | 18.1 | 18.1 | 18.1 |
| | 2 | 19 | 18.2 | 18.2 | 18.3 |
| | 3 | 19 | 17.8 | 17.6 | 17.9 |
| | 4 | 19 | 17.8 | 17.7 | 17.8 |

11.3 LTE Measurement result

Table 11.4: The conducted Power measurement results for LTE

Full Power

| LTE-FDD Band 2 | | | | Actual output Power (dBm) | | | Tune up |
|----------------|---------------|-----------|------------|---------------------------|---------|-----------|---------|
| Band-width | RB allocation | RB offset | Modulation | High | Middle | Low | |
| 1.4 MHz | | | | 1909.3MHz | 1880MHz | 1850.7MHz | |
| | 1RB | High | QPSK | 23.92 | 23.23 | 23.39 | 24.5 |
| | | | 16QAM | 23.32 | 22.62 | 22.92 | 23.5 |
| | | Middle | QPSK | 23.98 | 23.30 | 23.43 | 24.5 |
| | | | 16QAM | 23.30 | 22.75 | 23.04 | 23.5 |
| | | Low | QPSK | 23.83 | 23.22 | 23.35 | 24.5 |
| | | | 16QAM | 23.25 | 22.62 | 22.99 | 23.5 |
| | 3RB | High | QPSK | 23.60 | 23.24 | 23.38 | 24.5 |
| | | | 16QAM | 22.41 | 22.45 | 22.42 | 23.5 |
| | | Middle | QPSK | 23.51 | 23.24 | 23.39 | 24.5 |
| | | | 16QAM | 22.45 | 22.48 | 22.45 | 23.5 |
| | | Low | QPSK | 23.61 | 23.22 | 23.38 | 24.5 |
| | | | 16QAM | 22.43 | 22.42 | 22.43 | 23.5 |
| | 6RB | / | QPSK | 22.38 | 22.30 | 22.44 | 23.5 |
| 16QAM | | | 21.45 | 21.29 | 21.44 | 22.5 | |
| 3 MHz | | | | 1908.5MHz | 1880MHz | 1851.5MHz | / |
| | 1RB | High | QPSK | 23.92 | 23.27 | 23.44 | 24.5 |
| | | | 16QAM | 22.99 | 22.68 | 22.97 | 23.5 |
| | | Middle | QPSK | 23.56 | 23.39 | 23.59 | 24.5 |
| | | | 16QAM | 22.74 | 22.43 | 22.71 | 23.5 |
| | | Low | QPSK | 23.71 | 23.32 | 23.48 | 24.5 |
| | | | 16QAM | 22.90 | 22.71 | 23.10 | 23.5 |
| | 8RB | High | QPSK | 22.34 | 22.34 | 22.46 | 23.5 |
| | | | 16QAM | 21.41 | 21.46 | 21.57 | 22.5 |
| | | Middle | QPSK | 22.37 | 22.34 | 22.49 | 23.5 |
| | | | 16QAM | 21.43 | 21.45 | 21.59 | 22.5 |
| | | Low | QPSK | 22.35 | 22.31 | 22.47 | 23.5 |
| | | | 16QAM | 21.46 | 21.45 | 21.58 | 22.5 |
| | 15RB | / | QPSK | 22.39 | 22.30 | 22.53 | 23.5 |
| 16QAM | | | 21.37 | 21.35 | 21.52 | 22.5 | |

Full Power

| LTE-FDD Band 2 | | | | Actual output Power (dBm) | | | Tune up |
|----------------|---------------|-----------|------------|---------------------------|---------|-----------|---------|
| Band-width | RB allocation | RB offset | Modulation | High | Middle | Low | |
| 5 MHz | | | | 1907.5MHz | 1880MHz | 1852.5MHz | |
| | 1RB | High | QPSK | 23.41 | 23.32 | 23.51 | 24.5 |
| | | | 16QAM | 22.79 | 22.55 | 22.77 | 23.5 |
| | | Middle | QPSK | 23.37 | 23.29 | 23.47 | 24.5 |
| | | | 16QAM | 22.66 | 22.64 | 22.67 | 23.5 |
| | | Low | QPSK | 23.50 | 23.43 | 23.63 | 24.5 |
| | | | 16QAM | 22.80 | 22.76 | 22.98 | 23.5 |
| | 12RB | High | QPSK | 22.38 | 22.36 | 22.55 | 23.5 |
| | | | 16QAM | 21.40 | 21.33 | 21.63 | 22.5 |
| | | Middle | QPSK | 22.42 | 22.40 | 22.57 | 23.5 |
| | | | 16QAM | 21.42 | 21.43 | 21.63 | 22.5 |
| | | Low | QPSK | 22.51 | 22.38 | 22.57 | 23.5 |
| | | | 16QAM | 21.48 | 21.44 | 21.57 | 22.5 |
| | 25RB | / | QPSK | 22.40 | 22.46 | 22.68 | 23.5 |
| 16QAM | | | 21.36 | 21.37 | 21.54 | 22.5 | |
| 10 MHz | | | | 1905MHz | 1880MHz | 1855MHz | / |
| | 1RB | High | QPSK | 23.54 | 23.30 | 23.43 | 24.5 |
| | | | 16QAM | 22.79 | 22.60 | 22.75 | 23.5 |
| | | Middle | QPSK | 23.47 | 23.30 | 23.51 | 24.5 |
| | | | 16QAM | 22.78 | 22.62 | 22.67 | 23.5 |
| | | Low | QPSK | 23.58 | 23.40 | 23.50 | 24.5 |
| | | | 16QAM | 22.94 | 22.77 | 22.82 | 23.5 |
| | 25RB | High | QPSK | 22.41 | 22.29 | 22.49 | 23.5 |
| | | | 16QAM | 21.43 | 21.22 | 21.37 | 22.5 |
| | | Middle | QPSK | 22.44 | 22.42 | 22.60 | 23.5 |
| | | | 16QAM | 21.48 | 21.37 | 21.44 | 22.5 |
| | | Low | QPSK | 22.45 | 22.42 | 22.62 | 23.5 |
| | | | 16QAM | 21.49 | 21.32 | 21.45 | 22.5 |
| | 50RB | / | QPSK | 22.47 | 22.31 | 22.47 | 23.5 |
| 16QAM | | | 21.55 | 21.34 | 21.51 | 22.5 | |

Full Power

| LTE-FDD Band 2 | | | | Actual output Power (dBm) | | | Tune up |
|----------------|---------------|-----------|------------|---------------------------|---------|-----------|---------|
| Band-width | RB allocation | RB offset | Modulation | High | Middle | Low | |
| 15 MHz | | | | 1902.5MHz | 1880MHz | 1857.5MHz | |
| | 1RB | High | QPSK | 23.57 | 23.38 | 23.49 | 24.5 |
| | | | 16QAM | 22.84 | 22.66 | 22.84 | 23.5 |
| | | Middle | QPSK | 23.70 | 23.33 | 23.48 | 24.5 |
| | | | 16QAM | 22.86 | 22.70 | 22.78 | 23.5 |
| | | Low | QPSK | 24.48 | 23.60 | 23.42 | 24.5 |
| | | | 16QAM | 22.92 | 23.02 | 22.86 | 23.5 |
| | 36RB | High | QPSK | 22.56 | 22.40 | 22.54 | 23.5 |
| | | | 16QAM | 21.54 | 21.33 | 21.50 | 22.5 |
| | | Middle | QPSK | 22.61 | 22.48 | 22.60 | 23.5 |
| | | | 16QAM | 21.58 | 21.44 | 21.59 | 22.5 |
| | | Low | QPSK | 22.59 | 22.45 | 22.51 | 23.5 |
| | | | 16QAM | 21.57 | 21.45 | 21.49 | 22.5 |
| | 75RB | / | QPSK | 22.62 | 22.46 | 22.56 | 23.5 |
| 16QAM | | | 21.58 | 21.45 | 21.52 | 22.5 | |
| 20 MHz | | | | 1900MHz | 1880MHz | 1860MHz | / |
| | 1RB | High | QPSK | 23.27 | 23.07 | 23.30 | 24.5 |
| | | | 16QAM | 22.45 | 22.31 | 22.68 | 23.5 |
| | | Middle | QPSK | 23.74 | 23.56 | 23.74 | 24.5 |
| | | | 16QAM | 23.03 | 22.93 | 23.11 | 23.5 |
| | | Low | QPSK | 23.80 | 23.55 | 23.50 | 24.5 |
| | | | 16QAM | 22.74 | 22.95 | 22.82 | 23.5 |
| | 50RB | High | QPSK | 22.53 | 22.47 | 22.54 | 23.5 |
| | | | 16QAM | 21.44 | 21.41 | 21.48 | 22.5 |
| | | Middle | QPSK | 22.79 | 22.71 | 22.77 | 23.5 |
| | | | 16QAM | 21.74 | 21.67 | 21.76 | 22.5 |
| | | Low | QPSK | 22.63 | 22.72 | 22.69 | 23.5 |
| | | | 16QAM | 21.65 | 21.64 | 21.64 | 22.5 |
| | 100RB | / | QPSK | 22.60 | 22.48 | 22.62 | 23.5 |
| 16QAM | | | 21.50 | 21.53 | 21.61 | 22.5 | |

Hotspot on

| LTE-FDD Band 2 | | | | Actual output Power (dBm) | | | Tune up |
|----------------|---------------|-----------|------------|---------------------------|---------|-----------|---------|
| Band-width | RB allocation | RB offset | Modulation | High | Middle | Low | |
| 1.4 MHz | | | | 1909.3MHz | 1880MHz | 1850.7MHz | |
| | 1RB | High | QPSK | 19.35 | 19.33 | 19.42 | 20.5 |
| | | | 16QAM | 19.79 | 19.60 | 19.74 | 20.5 |
| | | Middle | QPSK | 19.47 | 19.37 | 19.48 | 20.5 |
| | | | 16QAM | 19.88 | 19.67 | 19.76 | 20.5 |
| | | Low | QPSK | 19.36 | 19.33 | 19.44 | 20.5 |
| | | | 16QAM | 19.80 | 19.61 | 19.74 | 20.5 |
| | 3RB | High | QPSK | 19.48 | 19.51 | 19.51 | 20.5 |
| | | | 16QAM | 19.66 | 19.58 | 19.65 | 20.5 |
| | | Middle | QPSK | 19.62 | 19.50 | 19.60 | 20.5 |
| | | | 16QAM | 19.74 | 19.73 | 19.73 | 20.5 |
| | | Low | QPSK | 19.56 | 19.43 | 19.52 | 20.5 |
| | | | 16QAM | 19.69 | 19.65 | 19.71 | 20.5 |
| | 6RB | / | QPSK | 19.56 | 19.46 | 19.57 | 20.5 |
| 16QAM | | | 19.54 | 19.42 | 19.54 | 20.5 | |
| 3 MHz | | | | 1908.5MHz | 1880MHz | 1851.5MHz | / |
| | 1RB | High | QPSK | 19.46 | 19.31 | 19.46 | 20.5 |
| | | | 16QAM | 19.84 | 19.62 | 19.76 | 20.5 |
| | | Middle | QPSK | 19.71 | 19.49 | 19.59 | 20.5 |
| | | | 16QAM | 19.68 | 19.49 | 19.64 | 20.5 |
| | | Low | QPSK | 19.41 | 19.35 | 19.52 | 20.5 |
| | | | 16QAM | 19.81 | 19.57 | 19.76 | 20.5 |
| | 8RB | High | QPSK | 19.60 | 19.53 | 19.59 | 20.5 |
| | | | 16QAM | 19.68 | 19.70 | 19.74 | 20.5 |
| | | Middle | QPSK | 19.59 | 19.49 | 19.61 | 20.5 |
| | | | 16QAM | 19.73 | 19.64 | 19.75 | 20.5 |
| | | Low | QPSK | 19.63 | 19.52 | 19.64 | 20.5 |
| | | | 16QAM | 19.68 | 19.69 | 19.80 | 20.5 |
| | 15RB | / | QPSK | 19.54 | 19.49 | 19.61 | 20.5 |
| 16QAM | | | 19.62 | 19.49 | 19.62 | 20.5 | |

Hotspot on

| LTE-FDD Band 2 | | | | Actual output Power (dBm) | | | Tune up |
|----------------|---------------|-----------|------------|---------------------------|---------|-----------|---------|
| Band-width | RB allocation | RB offset | Modulation | High | Middle | Low | |
| 5 MHz | | | | 1907.5MHz | 1880MHz | 1852.5MHz | |
| | 1RB | High | QPSK | 19.45 | 19.31 | 19.46 | 20.5 |
| | | | 16QAM | 19.89 | 19.67 | 19.69 | 20.5 |
| | | Middle | QPSK | 19.45 | 19.32 | 19.52 | 20.5 |
| | | | 16QAM | 19.90 | 19.78 | 19.79 | 20.5 |
| | | Low | QPSK | 19.62 | 19.52 | 19.63 | 20.5 |
| | | | 16QAM | 20.01 | 19.85 | 20.01 | 20.5 |
| | 12RB | High | QPSK | 19.50 | 19.49 | 19.68 | 20.5 |
| | | | 16QAM | 19.63 | 19.56 | 19.74 | 20.5 |
| | | Middle | QPSK | 19.53 | 19.56 | 19.70 | 20.5 |
| | | | 16QAM | 19.67 | 19.61 | 19.79 | 20.5 |
| | | Low | QPSK | 19.59 | 19.54 | 19.68 | 20.5 |
| | | | 16QAM | 19.72 | 19.61 | 19.74 | 20.5 |
| | 25RB | / | QPSK | 19.62 | 19.62 | 19.75 | 20.5 |
| 16QAM | | | 19.55 | 19.49 | 19.65 | 20.5 | |
| 10 MHz | | | | 1905MHz | 1880MHz | 1855MHz | / |
| | 1RB | High | QPSK | 19.61 | 19.43 | 19.51 | 20.5 |
| | | | 16QAM | 20.01 | 19.81 | 19.88 | 20.5 |
| | | Middle | QPSK | 19.47 | 19.45 | 19.47 | 20.5 |
| | | | 16QAM | 19.97 | 19.93 | 19.87 | 20.5 |
| | | Low | QPSK | 19.63 | 19.42 | 19.62 | 20.5 |
| | | | 16QAM | 20.14 | 19.96 | 20.02 | 20.5 |
| | 25RB | High | QPSK | 19.50 | 19.42 | 19.50 | 20.5 |
| | | | 16QAM | 19.49 | 19.32 | 19.42 | 20.5 |
| | | Middle | QPSK | 19.58 | 19.51 | 19.60 | 20.5 |
| | | | 16QAM | 19.54 | 19.44 | 19.51 | 20.5 |
| | | Low | QPSK | 19.61 | 19.53 | 19.70 | 20.5 |
| | | | 16QAM | 19.55 | 19.39 | 19.51 | 20.5 |
| | 50RB | / | QPSK | 19.56 | 19.42 | 19.48 | 20.5 |
| 16QAM | | | 19.59 | 19.44 | 19.49 | 20.5 | |

Hotspot on

| LTE-FDD Band 2 | | | | Actual output Power (dBm) | | | Tune up |
|----------------|---------------|-----------|------------|---------------------------|--------------|-------------|-------------|
| Band-width | RB allocation | RB offset | Modulation | High | Middle | Low | |
| 15 MHz | | | | 1902.5MHz | 1880MHz | 1857.5MHz | |
| | 1RB | High | QPSK | 19.48 | 19.36 | 19.50 | 20.5 |
| | | | 16QAM | 20.12 | 19.97 | 20.01 | 20.5 |
| | | Middle | QPSK | 19.41 | 19.30 | 19.47 | 20.5 |
| | | | 16QAM | 20.05 | 19.92 | 20.00 | 20.5 |
| | | Low | QPSK | 19.56 | 19.53 | 19.49 | 20.5 |
| | | | 16QAM | 20.21 | 20.30 | 20.03 | 20.5 |
| | 36RB | High | QPSK | 19.53 | 19.33 | 19.49 | 20.5 |
| | | | 16QAM | 19.63 | 19.42 | 19.47 | 20.5 |
| | | Middle | QPSK | 19.52 | 19.45 | 19.59 | 20.5 |
| | | | 16QAM | 19.68 | 19.58 | 19.58 | 20.5 |
| | | Low | QPSK | 19.59 | 19.43 | 19.41 | 20.5 |
| | | | 16QAM | 19.68 | 19.57 | 19.47 | 20.5 |
| | 75RB | / | QPSK | 19.55 | 19.45 | 19.52 | 20.5 |
| 16QAM | | | 19.68 | 19.51 | 19.49 | 20.5 | |
| 20 MHz | | | | 1900MHz | 1880MHz | 1860MHz | / |
| | 1RB | High | QPSK | 19.17 | 19.01 | 19.16 | 20.5 |
| | | | 16QAM | 19.66 | 19.62 | 19.68 | 20.5 |
| | | Middle | QPSK | 19.78 | 19.52 | 19.65 | 20.5 |
| | | | 16QAM | 20.25 | 20.14 | 20.21 | 20.5 |
| | | Low | QPSK | 19.66 | 19.49 | 19.43 | 20.5 |
| | | | 16QAM | 20.03 | 20.11 | 19.95 | 20.5 |
| | 50RB | High | QPSK | 19.46 | 19.42 | 19.41 | 20.5 |
| | | | 16QAM | 19.42 | 19.43 | 19.39 | 20.5 |
| | | Middle | QPSK | 19.74 | 19.67 | 19.66 | 20.5 |
| | | | 16QAM | 19.75 | 19.65 | 19.68 | 20.5 |
| | | Low | QPSK | 19.61 | 19.70 | 19.61 | 20.5 |
| | | | 16QAM | 19.65 | 19.69 | 19.57 | 20.5 |
| | 100RB | / | QPSK | 19.58 | 19.44 | 19.51 | 20.5 |
| 16QAM | | | 19.53 | 19.50 | 19.54 | 20.5 | |

Full Power

| LTE-FDD Band 4 | | | | Actual output Power (dBm) | | | Tune up |
|----------------|---------------|-----------|------------|---------------------------|-----------|-----------|-----------|
| Band-width | RB allocation | RB offset | Modulation | High | Middle | Low | |
| 1.4 MHz | | | | 1754.3MHz | 1732.5MHz | 1710.7MHz | |
| | 1RB | High | QPSK | 23.95 | 23.34 | 23.24 | 25 |
| | | | 16QAM | 23.21 | 22.81 | 23.04 | 24 |
| | | Middle | QPSK | 24.12 | 23.35 | 23.36 | 25 |
| | | | 16QAM | 23.45 | 22.86 | 23.15 | 24 |
| | | Low | QPSK | 23.93 | 23.26 | 23.33 | 25 |
| | | | 16QAM | 23.12 | 22.74 | 23.06 | 24 |
| | 3RB | High | QPSK | 23.71 | 23.28 | 23.23 | 25 |
| | | | 16QAM | 22.32 | 22.38 | 22.26 | 24 |
| | | Middle | QPSK | 23.60 | 23.28 | 23.26 | 25 |
| | | | 16QAM | 22.38 | 22.40 | 22.28 | 24 |
| | | Low | QPSK | 23.66 | 23.23 | 23.24 | 25 |
| | | | 16QAM | 22.41 | 22.36 | 22.25 | 24 |
| | 6RB | / | QPSK | 22.40 | 22.38 | 22.27 | 24 |
| 16QAM | | | 21.39 | 21.39 | 21.28 | 23 | |
| 3 MHz | | | | 1753.5MHz | 1732.5MHz | 23.95 | 23.34 |
| | 1RB | High | QPSK | 23.41 | 23.25 | 23.22 | 25 |
| | | | 16QAM | 23.30 | 22.72 | 23.00 | 24 |
| | | Middle | QPSK | 23.36 | 23.42 | 23.31 | 25 |
| | | | 16QAM | 23.01 | 22.68 | 22.67 | 24 |
| | | Low | QPSK | 23.49 | 23.40 | 23.41 | 25 |
| | | | 16QAM | 23.25 | 22.87 | 23.21 | 24 |
| | 8RB | High | QPSK | 22.40 | 22.33 | 22.19 | 24 |
| | | | 16QAM | 21.39 | 21.45 | 21.27 | 23 |
| | | Middle | QPSK | 22.42 | 22.34 | 22.23 | 24 |
| | | | 16QAM | 21.41 | 21.47 | 21.29 | 23 |
| | | Low | QPSK | 22.32 | 22.36 | 22.28 | 24 |
| | | | 16QAM | 21.38 | 21.40 | 21.35 | 23 |
| | 15RB | / | QPSK | 22.36 | 22.38 | 22.19 | 24 |
| 16QAM | | | 21.44 | 21.37 | 21.23 | 23 | |

Full Power

| LTE-FDD Band 4 | | | | Actual output Power (dBm) | | | Tune up |
|----------------|---------------|-----------|------------|---------------------------|-----------|-----------|-----------|
| Band-width | RB allocation | RB offset | Modulation | High | Middle | Low | |
| 5 MHz | | | | 1752.5MHz | 1732.5MHz | 1712.5MHz | |
| | 1RB | High | QPSK | 23.96 | 23.37 | 23.33 | 25 |
| | | | 16QAM | 22.87 | 22.72 | 22.74 | 24 |
| | | Middle | QPSK | 23.37 | 23.31 | 23.14 | 25 |
| | | | 16QAM | 22.57 | 22.61 | 22.48 | 24 |
| | | Low | QPSK | 24.20 | 23.49 | 23.49 | 25 |
| | | | 16QAM | 23.10 | 22.89 | 22.85 | 24 |
| | 12RB | High | QPSK | 22.46 | 22.33 | 22.21 | 24 |
| | | | 16QAM | 21.47 | 21.36 | 21.21 | 23 |
| | | Middle | QPSK | 22.40 | 22.43 | 22.26 | 24 |
| | | | 16QAM | 21.41 | 21.43 | 21.28 | 23 |
| | | Low | QPSK | 22.55 | 22.37 | 22.39 | 24 |
| | | | 16QAM | 21.51 | 21.42 | 21.40 | 23 |
| | 25RB | / | QPSK | 22.33 | 22.46 | 22.29 | 24 |
| 16QAM | | | 21.37 | 21.37 | 21.21 | 23 | |
| 10 MHz | | | | 1750MHz | 1732.5MHz | 1715MHz | / |
| | 1RB | High | QPSK | 23.44 | 22.96 | 22.78 | 25 |
| | | | 16QAM | 22.26 | 22.19 | 22.15 | 24 |
| | | Middle | QPSK | 23.97 | 23.34 | 23.25 | 25 |
| | | | 16QAM | 22.50 | 22.60 | 22.49 | 24 |
| | | Low | QPSK | 23.75 | 23.25 | 23.16 | 25 |
| | | | 16QAM | 22.49 | 22.61 | 22.40 | 24 |
| | 25RB | High | QPSK | 22.19 | 22.15 | 22.20 | 24 |
| | | | 16QAM | 21.20 | 21.09 | 21.10 | 23 |
| | | Middle | QPSK | 22.38 | 22.46 | 22.30 | 24 |
| | | | 16QAM | 21.43 | 21.32 | 21.32 | 23 |
| | | Low | QPSK | 22.43 | 22.45 | 22.24 | 24 |
| | | | 16QAM | 21.45 | 21.32 | 21.18 | 23 |
| | 50RB | / | QPSK | 22.31 | 22.32 | 22.20 | 24 |
| 16QAM | | | 21.34 | 21.32 | 21.24 | 23 | |

Full Power

| LTE-FDD Band 4 | | | | Actual output Power (dBm) | | | Tune up |
|----------------|---------------|-----------|------------|---------------------------|--------------|-----------|-----------|
| Band-width | RB allocation | RB offset | Modulation | High | Middle | Low | |
| 15 MHz | | | | 1747.5MHz | 1732.5MHz | 1717.5MHz | |
| | 1RB | High | QPSK | 23.93 | 23.52 | 23.45 | 25 |
| | | | 16QAM | 22.75 | 22.84 | 22.82 | 24 |
| | | Middle | QPSK | 23.59 | 23.31 | 23.29 | 25 |
| | | | 16QAM | 22.48 | 22.70 | 22.53 | 24 |
| | | Low | QPSK | 24.29 | 23.90 | 23.91 | 25 |
| | | | 16QAM | 23.14 | 23.22 | 23.08 | 24 |
| | 36RB | High | QPSK | 22.50 | 22.53 | 22.34 | 24 |
| | | | 16QAM | 21.46 | 21.48 | 21.33 | 23 |
| | | Middle | QPSK | 22.48 | 22.47 | 22.48 | 24 |
| | | | 16QAM | 21.45 | 21.42 | 21.43 | 23 |
| | | Low | QPSK | 22.75 | 22.74 | 22.68 | 24 |
| | | | 16QAM | 21.75 | 21.72 | 21.68 | 23 |
| | 75RB | / | QPSK | 22.61 | 22.57 | 22.53 | 24 |
| 16QAM | | | 21.63 | 21.54 | 21.54 | 23 | |
| 20 MHz | | | | 1745MHz | 1732.5MHz | 1720MHz | / |
| | 1RB | High | QPSK | 23.66 | 23.73 | 23.80 | 25 |
| | | | 16QAM | 22.89 | 22.89 | 23.19 | 24 |
| | | Middle | QPSK | 23.30 | 23.31 | 23.35 | 25 |
| | | | 16QAM | 22.52 | 22.70 | 22.66 | 24 |
| | | Low | QPSK | 24.42 | 24.37 | 24.50 | 25 |
| | | | 16QAM | 23.69 | 23.66 | 23.56 | 24 |
| | 50RB | High | QPSK | 22.38 | 22.50 | 22.55 | 24 |
| | | | 16QAM | 21.42 | 21.50 | 21.52 | 23 |
| | | Middle | QPSK | 22.44 | 22.45 | 22.51 | 24 |
| | | | 16QAM | 21.47 | 21.44 | 21.48 | 23 |
| | | Low | QPSK | 22.84 | 22.85 | 22.81 | 24 |
| | | | 16QAM | 21.86 | 21.82 | 21.81 | 23 |
| | 100RB | / | QPSK | 22.64 | 22.65 | 22.72 | 24 |
| 16QAM | | | 21.70 | 21.71 | 21.71 | 23 | |

Hotspot on

| LTE-FDD Band 4 | | | | Actual output Power (dBm) | | | Tune up |
|----------------|---------------|-----------|------------|---------------------------|-----------|-----------|---------|
| Band-width | RB allocation | RB offset | Modulation | High | Middle | Low | |
| 1.4 MHz | | | | 1754.3MHz | 1732.5MHz | 1710.7MHz | |
| | 1RB | High | QPSK | 19.42 | 19.43 | 19.36 | 21.2 |
| | | | 16QAM | 19.69 | 19.63 | 19.62 | 21.2 |
| | | Middle | QPSK | 19.51 | 19.47 | 19.40 | 21.2 |
| | | | 16QAM | 19.77 | 19.73 | 19.71 | 21.2 |
| | | Low | QPSK | 19.34 | 19.40 | 19.41 | 21.2 |
| | | | 16QAM | 19.69 | 19.63 | 19.65 | 21.2 |
| | 3RB | High | QPSK | 19.53 | 19.50 | 19.45 | 21.2 |
| | | | 16QAM | 19.59 | 19.60 | 19.51 | 21.2 |
| | | Middle | QPSK | 19.59 | 19.57 | 19.52 | 21.2 |
| | | | 16QAM | 19.65 | 19.64 | 19.64 | 21.2 |
| | | Low | QPSK | 19.53 | 19.50 | 19.51 | 21.2 |
| | | | 16QAM | 19.62 | 19.59 | 19.56 | 21.2 |
| | 6RB | / | QPSK | 19.53 | 19.52 | 19.45 | 21.2 |
| 16QAM | | | 19.57 | 19.54 | 19.50 | 21.2 | |
| 3 MHz | | | | 1753.5MHz | 1732.5MHz | 23.95 | 23.34 |
| | 1RB | High | QPSK | 19.44 | 19.37 | 19.31 | 21.2 |
| | | | 16QAM | 19.74 | 19.65 | 19.65 | 21.2 |
| | | Middle | QPSK | 19.55 | 19.52 | 19.44 | 21.2 |
| | | | 16QAM | 19.93 | 19.79 | 19.83 | 21.2 |
| | | Low | QPSK | 19.50 | 19.54 | 19.45 | 21.2 |
| | | | 16QAM | 19.85 | 19.78 | 19.76 | 21.2 |
| | 8RB | High | QPSK | 19.59 | 19.54 | 19.40 | 21.2 |
| | | | 16QAM | 19.68 | 19.70 | 19.50 | 21.2 |
| | | Middle | QPSK | 19.55 | 19.54 | 19.41 | 21.2 |
| | | | 16QAM | 19.66 | 19.71 | 19.54 | 21.2 |
| | | Low | QPSK | 19.52 | 19.54 | 19.52 | 21.2 |
| | | | 16QAM | 19.63 | 19.64 | 19.67 | 21.2 |
| | 15RB | / | QPSK | 19.50 | 19.56 | 19.43 | 21.2 |
| 16QAM | | | 19.58 | 19.53 | 19.45 | 21.2 | |

Hotspot on

| LTE-FDD Band 4 | | | | Actual output Power (dBm) | | | Tune up |
|----------------|---------------|-----------|------------|---------------------------|-----------|-----------|---------|
| Band-width | RB allocation | RB offset | Modulation | High | Middle | Low | |
| 5 MHz | | | | 1752.5MHz | 1732.5MHz | 1712.5MHz | |
| | 1RB | High | QPSK | 19.52 | 19.50 | 19.43 | 21.2 |
| | | | 16QAM | 19.88 | 19.76 | 19.71 | 21.2 |
| | | Middle | QPSK | 19.48 | 19.47 | 19.38 | 21.2 |
| | | | 16QAM | 19.87 | 19.84 | 19.74 | 21.2 |
| | | Low | QPSK | 19.61 | 19.60 | 19.59 | 21.2 |
| | | | 16QAM | 19.98 | 19.88 | 19.86 | 21.2 |
| | 12RB | High | QPSK | 19.61 | 19.51 | 19.43 | 21.2 |
| | | | 16QAM | 19.63 | 19.52 | 19.50 | 21.2 |
| | | Middle | QPSK | 19.59 | 19.60 | 19.44 | 21.2 |
| | | | 16QAM | 19.60 | 19.63 | 19.52 | 21.2 |
| | | Low | QPSK | 19.69 | 19.57 | 19.58 | 21.2 |
| | | | 16QAM | 19.71 | 19.62 | 19.63 | 21.2 |
| | 25RB | / | QPSK | 19.54 | 19.60 | 19.45 | 21.2 |
| 16QAM | | | 19.52 | 19.55 | 19.42 | 21.2 | |
| 10 MHz | | | | 1750MHz | 1732.5MHz | 1715MHz | / |
| | 1RB | High | QPSK | 19.30 | 19.36 | 19.25 | 21.2 |
| | | | 16QAM | 19.68 | 19.73 | 19.54 | 21.2 |
| | | Middle | QPSK | 19.52 | 19.49 | 19.44 | 21.2 |
| | | | 16QAM | 19.89 | 19.89 | 19.87 | 21.2 |
| | | Low | QPSK | 19.37 | 19.42 | 19.37 | 21.2 |
| | | | 16QAM | 19.72 | 19.74 | 19.73 | 21.2 |
| | 25RB | High | QPSK | 19.38 | 19.32 | 19.31 | 21.2 |
| | | | 16QAM | 19.38 | 19.28 | 19.35 | 21.2 |
| | | Middle | QPSK | 19.59 | 19.59 | 19.54 | 21.2 |
| | | | 16QAM | 19.54 | 19.54 | 19.51 | 21.2 |
| | | Low | QPSK | 19.61 | 19.57 | 19.46 | 21.2 |
| | | | 16QAM | 19.60 | 19.51 | 19.42 | 21.2 |
| | 50RB | / | QPSK | 19.42 | 19.44 | 19.41 | 21.2 |
| 16QAM | | | 19.41 | 19.49 | 19.37 | 21.2 | |

Hotspot on

| LTE-FDD Band 4 | | | | Actual output Power (dBm) | | | Tune up |
|----------------|---------------|-----------|------------|---------------------------|-----------|-----------|---------|
| Band-width | RB allocation | RB offset | Modulation | High | Middle | Low | |
| 15 MHz | | | | 1747.5MHz | 1732.5MHz | 1717.5MHz | |
| | 1RB | High | QPSK | 19.66 | 19.71 | 19.63 | 21.2 |
| | | | 16QAM | 20.07 | 20.12 | 20.01 | 21.2 |
| | | Middle | QPSK | 19.47 | 19.43 | 19.50 | 21.2 |
| | | | 16QAM | 19.86 | 19.85 | 19.93 | 21.2 |
| | | Low | QPSK | 20.07 | 20.05 | 20.20 | 21.2 |
| | | | 16QAM | 20.52 | 20.52 | 20.49 | 21.2 |
| | 36RB | High | QPSK | 19.65 | 19.68 | 19.45 | 21.2 |
| | | | 16QAM | 19.65 | 19.65 | 19.49 | 21.2 |
| | | Middle | QPSK | 19.58 | 19.61 | 19.60 | 21.2 |
| | | | 16QAM | 19.60 | 19.61 | 19.64 | 21.2 |
| | | Low | QPSK | 19.89 | 19.86 | 19.79 | 21.2 |
| | | | 16QAM | 19.89 | 19.87 | 19.81 | 21.2 |
| | 75RB | / | QPSK | 19.68 | 19.71 | 19.67 | 21.2 |
| 16QAM | | | 19.73 | 19.71 | 19.68 | 21.2 | |
| 20 MHz | | | | 1745MHz | 1732.5MHz | 1720MHz | / |
| | 1RB | High | QPSK | 19.84 | 19.86 | 19.94 | 21.2 |
| | | | 16QAM | 20.27 | 20.22 | 20.37 | 21.2 |
| | | Middle | QPSK | 19.46 | 19.50 | 19.53 | 21.2 |
| | | | 16QAM | 19.87 | 19.90 | 19.91 | 21.2 |
| | | Low | QPSK | 20.64 | 20.56 | 20.68 | 21.2 |
| | | | 16QAM | 21.11 | 21.01 | 21.03 | 21.2 |
| | 50RB | High | QPSK | 19.51 | 19.62 | 19.63 | 21.2 |
| | | | 16QAM | 19.55 | 19.65 | 19.67 | 21.2 |
| | | Middle | QPSK | 19.58 | 19.60 | 19.61 | 21.2 |
| | | | 16QAM | 19.53 | 19.55 | 19.65 | 21.2 |
| | | Low | QPSK | 19.89 | 19.97 | 20.02 | 21.2 |
| | | | 16QAM | 19.88 | 19.94 | 20.02 | 21.2 |
| | 100RB | / | QPSK | 19.72 | 19.79 | 19.85 | 21.2 |
| 16QAM | | | 19.81 | 19.88 | 19.85 | 21.2 | |

Full Power / Hotspot on

| LTE-FDD Band 5 | | | | Actual output Power (dBm) | | | Tune up |
|----------------|---------------|-----------|------------|---------------------------|----------|-----------|-----------|
| Band-width | RB allocation | RB offset | Modulation | High | Middle | Low | |
| 1.4 MHz | | | | 848.3MHz | 836.5MHz | 824.7MHz | |
| | 1RB | High | QPSK | 23.35 | 23.18 | 22.79 | 24 |
| | | | 16QAM | 22.56 | 22.58 | 22.19 | 23 |
| | | Middle | QPSK | 23.33 | 23.26 | 22.88 | 24 |
| | | | 16QAM | 22.61 | 22.49 | 22.28 | 23 |
| | | Low | QPSK | 23.35 | 23.21 | 22.83 | 24 |
| | | | 16QAM | 22.58 | 22.51 | 22.21 | 23 |
| | 3RB | High | QPSK | 23.35 | 23.20 | 22.89 | 24 |
| | | | 16QAM | 22.40 | 22.30 | 21.95 | 23 |
| | | Middle | QPSK | 23.38 | 23.23 | 22.95 | 24 |
| | | | 16QAM | 22.48 | 22.41 | 22.06 | 23 |
| | | Low | QPSK | 23.32 | 23.20 | 22.89 | 24 |
| | | | 16QAM | 22.39 | 22.31 | 22.03 | 23 |
| | 6RB | / | QPSK | 22.34 | 22.24 | 21.96 | 23 |
| 16QAM | | | 21.29 | 21.23 | 21.01 | 22 | |
| 3 MHz | | | | 847.5MHz | 836.5MHz | 825.5MHz | / |
| | 1RB | High | QPSK | 23.36 | 23.26 | 22.97 | 24 |
| | | | 16QAM | 22.60 | 22.62 | 22.29 | 23 |
| | | Middle | QPSK | 23.35 | 23.36 | 22.93 | 24 |
| | | | 16QAM | 22.42 | 22.44 | 22.04 | 23 |
| | | Low | QPSK | 23.30 | 23.28 | 22.91 | 24 |
| | | | 16QAM | 22.63 | 22.51 | 22.29 | 23 |
| | 8RB | High | QPSK | 22.36 | 22.28 | 21.96 | 23 |
| | | | 16QAM | 21.46 | 21.39 | 21.08 | 22 |
| | | Middle | QPSK | 22.40 | 22.29 | 21.94 | 23 |
| | | | 16QAM | 21.44 | 21.42 | 21.05 | 22 |
| | | Low | QPSK | 22.35 | 22.31 | 22.01 | 23 |
| | | | 16QAM | 21.40 | 21.41 | 21.15 | 22 |
| | 15RB | / | QPSK | 22.42 | 22.32 | 22.04 | 23 |
| 16QAM | | | 21.39 | 21.32 | 21.00 | 22 | |

Full Power / Hotspot on

| LTE-FDD Band 5 | | | | Actual output Power (dBm) | | | Tune up |
|----------------|---------------|-----------|------------|---------------------------|--------------|-----------|-----------|
| Band-width | RB allocation | RB offset | Modulation | High | Middle | Low | |
| 5 MHz | | | | 846.5MHz | 836.5MHz | 826.5MHz | |
| | 1RB | High | QPSK | 23.49 | 23.42 | 23.00 | 24 |
| | | | 16QAM | 22.78 | 22.70 | 22.31 | 23 |
| | | Middle | QPSK | 23.42 | 23.33 | 23.01 | 24 |
| | | | 16QAM | 22.70 | 22.58 | 22.26 | 23 |
| | | Low | QPSK | 23.45 | 23.38 | 22.95 | 24 |
| | | | 16QAM | 22.76 | 22.63 | 22.24 | 23 |
| | 12RB | High | QPSK | 22.48 | 22.37 | 22.02 | 23 |
| | | | 16QAM | 21.48 | 21.35 | 21.01 | 22 |
| | | Middle | QPSK | 22.47 | 22.37 | 22.00 | 23 |
| | | | 16QAM | 21.50 | 21.35 | 21.07 | 22 |
| | | Low | QPSK | 22.50 | 22.40 | 21.99 | 23 |
| | | | 16QAM | 21.50 | 21.39 | 21.03 | 22 |
| | 25RB | / | QPSK | 22.46 | 22.37 | 22.08 | 23 |
| 16QAM | | | 21.49 | 21.32 | 20.97 | 22 | |
| 10 MHz | | | | 844MHz | 836.5MHz | 829MHz | / |
| | 1RB | High | QPSK | 23.79 | 23.64 | 23.29 | 24 |
| | | | 16QAM | 23.19 | 22.91 | 22.67 | 23 |
| | | Middle | QPSK | 23.44 | 23.32 | 22.93 | 24 |
| | | | 16QAM | 22.87 | 22.65 | 22.29 | 23 |
| | | Low | QPSK | 23.53 | 23.34 | 22.97 | 24 |
| | | | 16QAM | 22.94 | 22.73 | 22.43 | 23 |
| | 25RB | High | QPSK | 22.41 | 22.44 | 22.09 | 23 |
| | | | 16QAM | 21.58 | 21.41 | 21.14 | 22 |
| | | Middle | QPSK | 22.53 | 22.40 | 22.11 | 23 |
| | | | 16QAM | 21.61 | 21.37 | 21.03 | 22 |
| | | Low | QPSK | 22.55 | 22.36 | 22.21 | 23 |
| | | | 16QAM | 21.55 | 21.33 | 20.98 | 22 |
| | 50RB | / | QPSK | 22.48 | 22.45 | 22.13 | 23 |
| 16QAM | | | 21.56 | 21.42 | 21.09 | 22 | |

Full Power

| LTE-FDD Band 7 | | | | Actual output Power (dBm) | | | Tune up |
|----------------|---------------|-----------|------------|---------------------------|---------|-----------|---------|
| Band-width | RB allocation | RB offset | Modulation | High | Middle | Low | |
| 5 MHz | | | | 2567.4MHz | 2535MHz | 2502.5MHz | |
| | 1RB | High | QPSK | 23.50 | 23.27 | 23.18 | 24.2 |
| | | | 16QAM | 22.69 | 22.54 | 22.47 | 23.2 |
| | | Middle | QPSK | 23.40 | 23.21 | 23.18 | 24.2 |
| | | | 16QAM | 22.48 | 22.47 | 22.38 | 23.2 |
| | | Low | QPSK | 23.47 | 23.24 | 23.16 | 24.2 |
| | | | 16QAM | 22.65 | 22.52 | 22.48 | 23.2 |
| | 12RB | High | QPSK | 22.42 | 22.32 | 22.22 | 23.2 |
| | | | 16QAM | 21.42 | 21.35 | 21.27 | 22.2 |
| | | Middle | QPSK | 22.42 | 22.31 | 22.30 | 23.2 |
| | | | 16QAM | 21.43 | 21.34 | 21.30 | 22.2 |
| | | Low | QPSK | 22.45 | 22.36 | 22.21 | 23.2 |
| | | | 16QAM | 21.41 | 21.38 | 21.21 | 22.2 |
| | 25RB | / | QPSK | 22.39 | 22.35 | 22.25 | 23.2 |
| 16QAM | | | 21.39 | 21.29 | 21.25 | 22.2 | |
| 10 MHz | | | | 2565MHz | 2535MHz | 2505MHz | / |
| | 1RB | High | QPSK | 23.07 | 22.88 | 22.75 | 24.2 |
| | | | 16QAM | 22.21 | 22.09 | 22.03 | 23.2 |
| | | Middle | QPSK | 23.43 | 23.20 | 23.13 | 24.2 |
| | | | 16QAM | 22.54 | 22.40 | 22.35 | 23.2 |
| | | Low | QPSK | 23.02 | 22.89 | 22.86 | 24.2 |
| | | | 16QAM | 22.24 | 22.17 | 22.01 | 23.2 |
| | 25RB | High | QPSK | 22.22 | 22.18 | 22.08 | 23.2 |
| | | | 16QAM | 21.22 | 21.15 | 21.07 | 22.2 |
| | | Middle | QPSK | 22.34 | 22.31 | 22.23 | 23.2 |
| | | | 16QAM | 21.40 | 21.32 | 21.23 | 22.2 |
| | | Low | QPSK | 22.26 | 22.14 | 22.14 | 23.2 |
| | | | 16QAM | 21.24 | 21.17 | 21.16 | 22.2 |
| | 50RB | / | QPSK | 22.29 | 22.20 | 22.13 | 23.2 |
| 16QAM | | | 21.34 | 21.24 | 21.15 | 22.2 | |

Full Power

| LTE-FDD Band 7 | | | | Actual output Power (dBm) | | | Tune up |
|----------------|---------------|-----------|------------|---------------------------|---------|-----------|---------|
| Band-width | RB allocation | RB offset | Modulation | High | Middle | Low | |
| 15 MHz | | | | 2562.5MHz | 2535MHz | 2507.5MHz | |
| | 1RB | High | QPSK | 23.77 | 23.36 | 23.16 | 24.2 |
| | | | 16QAM | 22.76 | 22.65 | 22.41 | 23.2 |
| | | Middle | QPSK | 23.31 | 23.09 | 23.06 | 24.2 |
| | | | 16QAM | 22.49 | 22.41 | 22.30 | 23.2 |
| | | Low | QPSK | 23.74 | 23.47 | 23.39 | 24.2 |
| | | | 16QAM | 22.94 | 22.74 | 22.68 | 23.2 |
| | 36RB | High | QPSK | 22.46 | 22.31 | 22.22 | 23.2 |
| | | | 16QAM | 21.50 | 21.28 | 21.20 | 22.2 |
| | | Middle | QPSK | 22.35 | 22.27 | 22.22 | 23.2 |
| | | | 16QAM | 21.40 | 21.32 | 21.21 | 22.2 |
| | | Low | QPSK | 22.52 | 22.45 | 22.42 | 23.2 |
| | | | 16QAM | 21.52 | 21.41 | 21.40 | 22.2 |
| | 75RB | / | QPSK | 22.47 | 22.35 | 22.26 | 23.2 |
| 16QAM | | | 21.46 | 21.37 | 21.29 | 22.2 | |
| 20 MHz | | | | 2560MHz | 2535MHz | 2510MHz | / |
| | 1RB | High | QPSK | 24.01 | 23.68 | 23.42 | 24.2 |
| | | | 16QAM | 23.06 | 22.90 | 22.69 | 23.2 |
| | | Middle | QPSK | 23.48 | 23.22 | 22.92 | 24.2 |
| | | | 16QAM | 22.59 | 22.48 | 22.24 | 23.2 |
| | | Low | QPSK | 24.08 | 23.71 | 23.64 | 24.2 |
| | | | 16QAM | 23.17 | 22.95 | 22.62 | 23.2 |
| | 50RB | High | QPSK | 22.61 | 22.48 | 22.17 | 23.2 |
| | | | 16QAM | 21.63 | 21.48 | 21.25 | 22.2 |
| | | Middle | QPSK | 22.53 | 22.37 | 22.06 | 23.2 |
| | | | 16QAM | 21.58 | 21.40 | 21.10 | 22.2 |
| | | Low | QPSK | 22.73 | 22.49 | 22.34 | 23.2 |
| | | | 16QAM | 21.72 | 21.52 | 21.26 | 22.2 |
| | 100RB | / | QPSK | 22.70 | 22.56 | 22.27 | 23.2 |
| 16QAM | | | 21.72 | 21.59 | 21.28 | 22.2 | |

Hotspot on

| LTE-FDD Band 7 | | | | Actual output Power (dBm) | | | Tune up |
|----------------|---------------|-----------|------------|---------------------------|---------|-------------|-------------|
| Band-width | RB allocation | RB offset | Modulation | High | Middle | Low | |
| 5 MHz | | | | 2567.4MHz | 2535MHz | 2502.5MHz | |
| | 1RB | High | QPSK | 19.32 | 19.09 | 18.99 | 20.5 |
| | | | 16QAM | 19.54 | 19.38 | 19.20 | 20.5 |
| | | Middle | QPSK | 19.30 | 19.04 | 18.98 | 20.5 |
| | | | 16QAM | 19.41 | 19.29 | 19.20 | 20.5 |
| | | Low | QPSK | 19.32 | 19.13 | 19.01 | 20.5 |
| | | | 16QAM | 19.58 | 19.40 | 19.31 | 20.5 |
| | 12RB | High | QPSK | 19.29 | 19.20 | 19.05 | 20.5 |
| | | | 16QAM | 19.37 | 19.24 | 19.11 | 20.5 |
| | | Middle | QPSK | 19.36 | 19.24 | 19.15 | 20.5 |
| | | | 16QAM | 19.38 | 19.26 | 19.15 | 20.5 |
| | | Low | QPSK | 19.34 | 19.22 | 19.04 | 20.5 |
| | | | 16QAM | 19.35 | 19.27 | 19.09 | 20.5 |
| | 25RB | / | QPSK | 19.32 | 19.22 | 19.09 | 20.5 |
| 16QAM | | | 19.32 | 19.18 | 19.09 | 20.5 | |
| 10 MHz | | | | 2565MHz | 2535MHz | 2505MHz | / |
| | 1RB | High | QPSK | 18.81 | 18.76 | 18.56 | 20.5 |
| | | | 16QAM | 19.19 | 19.11 | 18.96 | 20.5 |
| | | Middle | QPSK | 19.24 | 19.07 | 18.96 | 20.5 |
| | | | 16QAM | 19.54 | 19.39 | 19.30 | 20.5 |
| | | Low | QPSK | 18.90 | 18.91 | 18.63 | 20.5 |
| | | | 16QAM | 19.24 | 19.24 | 18.97 | 20.5 |
| | 25RB | High | QPSK | 19.14 | 19.05 | 18.92 | 20.5 |
| | | | 16QAM | 19.13 | 19.07 | 18.90 | 20.5 |
| | | Middle | QPSK | 19.30 | 19.17 | 19.09 | 20.5 |
| | | | 16QAM | 19.30 | 19.19 | 19.07 | 20.5 |
| | | Low | QPSK | 19.20 | 19.12 | 18.99 | 20.5 |
| | | | 16QAM | 19.18 | 19.14 | 18.99 | 20.5 |
| | 50RB | / | QPSK | 19.18 | 19.12 | 18.97 | 20.5 |
| 16QAM | | | 19.19 | 19.09 | 18.97 | 20.5 | |

Hotspot on

| LTE-FDD Band 7 | | | | Actual output Power (dBm) | | | Tune up |
|----------------|---------------|-----------|------------|---------------------------|--------------|-------------|-------------|
| Band-width | RB allocation | RB offset | Modulation | High | Middle | Low | |
| 15 MHz | | | | 2562.5MHz | 2535MHz | 2507.5MHz | |
| | 1RB | High | QPSK | 19.37 | 19.32 | 19.20 | 20.5 |
| | | | 16QAM | 19.73 | 19.73 | 19.52 | 20.5 |
| | | Middle | QPSK | 19.25 | 19.16 | 19.05 | 20.5 |
| | | | 16QAM | 19.56 | 19.55 | 19.39 | 20.5 |
| | | Low | QPSK | 19.57 | 19.45 | 19.31 | 20.5 |
| | | | 16QAM | 19.89 | 19.84 | 19.66 | 20.5 |
| | 36RB | High | QPSK | 19.27 | 19.26 | 19.19 | 20.5 |
| | | | 16QAM | 19.33 | 19.27 | 19.22 | 20.5 |
| | | Middle | QPSK | 19.30 | 19.32 | 19.21 | 20.5 |
| | | | 16QAM | 19.37 | 19.35 | 19.19 | 20.5 |
| | | Low | QPSK | 19.37 | 19.41 | 19.27 | 20.5 |
| | | | 16QAM | 19.44 | 19.37 | 19.32 | 20.5 |
| | 75RB | / | QPSK | 19.41 | 19.31 | 19.18 | 20.5 |
| 16QAM | | | 19.42 | 19.29 | 19.21 | 20.5 | |
| 20 MHz | | | | 2560MHz | 2535MHz | 2510MHz | / |
| | 1RB | High | QPSK | 19.58 | 19.46 | 19.37 | 20.5 |
| | | | 16QAM | 19.85 | 19.76 | 19.74 | 20.5 |
| | | Middle | QPSK | 19.29 | 19.17 | 19.07 | 20.5 |
| | | | 16QAM | 19.55 | 19.58 | 19.50 | 20.5 |
| | | Low | QPSK | 19.83 | 19.70 | 19.55 | 20.5 |
| | | | 16QAM | 20.10 | 19.99 | 19.94 | 20.5 |
| | 50RB | High | QPSK | 19.40 | 19.29 | 19.14 | 20.5 |
| | | | 16QAM | 19.41 | 19.31 | 19.19 | 20.5 |
| | | Middle | QPSK | 19.39 | 19.21 | 19.16 | 20.5 |
| | | | 16QAM | 19.38 | 19.24 | 19.24 | 20.5 |
| | | Low | QPSK | 19.47 | 19.45 | 19.37 | 20.5 |
| | | | 16QAM | 19.46 | 19.49 | 19.37 | 20.5 |
| | 100RB | / | QPSK | 19.49 | 19.44 | 19.27 | 20.5 |
| 16QAM | | | 19.44 | 19.39 | 19.31 | 20.5 | |

Full Power / Hotspot on

| LTE-FDD Band 12 | | | | Actual output Power (dBm) | | | Tune up |
|-----------------|---------------|-----------|------------|---------------------------|----------|-------------|-------------|
| Band-width | RB allocation | RB offset | Modulation | High | Middle | Low | |
| 1.4 MHz | | | | 715.3MHz | 707.5MHz | 699.7MHz | |
| | 1RB | High | QPSK | 22.81 | 22.84 | 22.72 | 23.5 |
| | | | 16QAM | 22.01 | 22.01 | 21.90 | 22.5 |
| | | Middle | QPSK | 22.77 | 22.93 | 22.79 | 23.5 |
| | | | 16QAM | 22.08 | 22.02 | 22.04 | 22.5 |
| | | Low | QPSK | 22.61 | 22.89 | 22.66 | 23.5 |
| | | | 16QAM | 21.90 | 22.05 | 21.88 | 22.5 |
| | 3RB | High | QPSK | 22.85 | 22.83 | 22.76 | 23.5 |
| | | | 16QAM | 21.93 | 21.89 | 21.89 | 22.5 |
| | | Middle | QPSK | 22.85 | 22.86 | 22.80 | 23.5 |
| | | | 16QAM | 21.91 | 21.94 | 21.95 | 22.5 |
| | | Low | QPSK | 22.84 | 22.83 | 22.78 | 23.5 |
| | | | 16QAM | 21.89 | 21.92 | 21.94 | 22.5 |
| | 6RB | / | QPSK | 21.82 | 21.87 | 21.83 | 22.5 |
| 16QAM | | | 20.84 | 20.92 | 20.85 | 21.5 | |
| 3 MHz | | | | 714.5MHz | 707.5MHz | 700.5MHz | / |
| | 1RB | High | QPSK | 22.87 | 22.75 | 22.72 | 23.5 |
| | | | 16QAM | 22.09 | 22.02 | 22.03 | 22.5 |
| | | Middle | QPSK | 22.76 | 22.87 | 22.79 | 23.5 |
| | | | 16QAM | 22.03 | 22.14 | 22.10 | 22.5 |
| | | Low | QPSK | 22.79 | 22.76 | 22.73 | 23.5 |
| | | | 16QAM | 21.98 | 22.02 | 21.98 | 22.5 |
| | 8RB | High | QPSK | 21.86 | 21.87 | 21.94 | 22.5 |
| | | | 16QAM | 20.90 | 20.97 | 21.07 | 21.5 |
| | | Middle | QPSK | 21.92 | 21.93 | 21.92 | 22.5 |
| | | | 16QAM | 20.98 | 21.05 | 21.06 | 21.5 |
| | | Low | QPSK | 21.91 | 21.88 | 21.92 | 22.5 |
| | | | 16QAM | 20.97 | 20.92 | 21.05 | 21.5 |
| | 15RB | / | QPSK | 21.95 | 21.89 | 21.87 | 22.5 |
| 16QAM | | | 20.91 | 20.91 | 20.84 | 21.5 | |

Full Power / Hotspot on

| LTE-FDD Band 12 | | | | Actual output Power (dBm) | | | Tune up |
|-----------------|---------------|-----------|------------|---------------------------|--------------|-------------|-------------|
| Band-width | RB allocation | RB offset | Modulation | High | Middle | Low | |
| 5 MHz | | | | 713.5MHz | 707.5MHz | 701.5MHz | |
| | 1RB | High | QPSK | 22.94 | 22.90 | 22.78 | 23.5 |
| | | | 16QAM | 22.24 | 22.14 | 22.03 | 22.5 |
| | | Middle | QPSK | 22.82 | 22.80 | 22.84 | 23.5 |
| | | | 16QAM | 22.03 | 22.06 | 22.22 | 22.5 |
| | | Low | QPSK | 22.85 | 22.83 | 22.87 | 23.5 |
| | | | 16QAM | 22.05 | 22.16 | 22.17 | 22.5 |
| | 12RB | High | QPSK | 21.85 | 21.92 | 21.93 | 22.5 |
| | | | 16QAM | 20.93 | 20.94 | 20.99 | 21.5 |
| | | Middle | QPSK | 21.91 | 21.93 | 21.94 | 22.5 |
| | | | 16QAM | 21.01 | 20.99 | 20.99 | 21.5 |
| | | Low | QPSK | 21.95 | 21.89 | 21.90 | 22.5 |
| | | | 16QAM | 20.99 | 20.93 | 20.98 | 21.5 |
| | 25RB | / | QPSK | 21.95 | 21.99 | 21.97 | 22.5 |
| 16QAM | | | 20.87 | 20.91 | 20.92 | 21.5 | |
| 10 MHz | | | | 711MHz | 707.5MHz | 704MHz | / |
| | 1RB | High | QPSK | 22.81 | 22.42 | 22.41 | 23.5 |
| | | | 16QAM | 21.76 | 21.67 | 21.72 | 22.5 |
| | | Middle | QPSK | 22.82 | 22.86 | 22.78 | 23.5 |
| | | | 16QAM | 22.26 | 22.19 | 22.10 | 22.5 |
| | | Low | QPSK | 22.75 | 22.44 | 22.39 | 23.5 |
| | | | 16QAM | 21.67 | 21.80 | 21.73 | 22.5 |
| | 25RB | High | QPSK | 21.95 | 21.79 | 21.79 | 22.5 |
| | | | 16QAM | 20.73 | 20.77 | 20.67 | 21.5 |
| | | Middle | QPSK | 21.97 | 21.96 | 22.13 | 22.5 |
| | | | 16QAM | 20.93 | 20.92 | 20.97 | 21.5 |
| | | Low | QPSK | 21.99 | 21.87 | 21.87 | 22.5 |
| | | | 16QAM | 20.70 | 20.70 | 20.85 | 21.5 |
| | 50RB | / | QPSK | 21.99 | 21.71 | 21.77 | 22.5 |
| 16QAM | | | 20.76 | 20.72 | 20.84 | 21.5 | |

Full Power

| LTE-FDD Band 66 | | | | Actual output Power (dBm) | | | Tune up |
|-----------------|---------------|-----------|------------|---------------------------|---------|-----------|-----------|
| Band-width | RB allocation | RB offset | Modulation | High | Middle | Low | |
| 1.4 MHz | | | | 1779.3MHz | 1745MHz | 1710.7MHz | |
| | 1RB | High | QPSK | 23.57 | 23.69 | 23.43 | 24 |
| | | | 16QAM | 23.02 | 23.11 | 22.96 | 23 |
| | | Middle | QPSK | 23.65 | 23.88 | 23.51 | 24 |
| | | | 16QAM | 23.10 | 23.38 | 23.00 | 23 |
| | | Low | QPSK | 22.99 | 22.96 | 22.91 | 24 |
| | | | 16QAM | 22.42 | 22.37 | 22.36 | 23 |
| | 3RB | High | QPSK | 22.40 | 22.43 | 22.38 | 24 |
| | | | 16QAM | 21.46 | 21.45 | 21.38 | 23 |
| | | Middle | QPSK | 22.58 | 22.43 | 22.42 | 24 |
| | | | 16QAM | 21.44 | 21.49 | 21.44 | 23 |
| | | Low | QPSK | 22.49 | 22.27 | 22.30 | 24 |
| | | | 16QAM | 21.50 | 21.32 | 21.33 | 23 |
| | 6RB | / | QPSK | 22.50 | 22.44 | 22.42 | 23 |
| 16QAM | | | 21.44 | 21.40 | 21.39 | 22 | |
| 3 MHz | | | | 1778.5MHz | 1745MHz | 1711.5MHz | / |
| | 1RB | High | QPSK | 23.54 | 23.67 | 23.41 | 24 |
| | | | 16QAM | 22.41 | 22.29 | 22.32 | 23 |
| | | Middle | QPSK | 23.62 | 23.90 | 23.48 | 24 |
| | | | 16QAM | 22.67 | 22.32 | 22.57 | 23 |
| | | Low | QPSK | 22.97 | 22.94 | 22.88 | 24 |
| | | | 16QAM | 21.84 | 22.01 | 21.91 | 23 |
| | 8RB | High | QPSK | 22.41 | 22.44 | 22.41 | 23 |
| | | | 16QAM | 21.48 | 21.46 | 21.37 | 22 |
| | | Middle | QPSK | 22.58 | 22.44 | 22.43 | 23 |
| | | | 16QAM | 21.46 | 21.48 | 21.43 | 22 |
| | | Low | QPSK | 22.49 | 22.28 | 22.29 | 23 |
| | | | 16QAM | 21.49 | 21.35 | 21.34 | 22 |
| | 15RB | / | QPSK | 22.51 | 22.45 | 22.45 | 23 |
| 16QAM | | | 21.43 | 21.43 | 21.38 | 22 | |

Full Power

| LTE-FDD Band 66 | | | | Actual output Power (dBm) | | | Tune up |
|-----------------|---------------|-----------|------------|---------------------------|---------|-----------|-----------|
| Band-width | RB allocation | RB offset | Modulation | High | Middle | Low | |
| 5 MHz | | | | 1777.5MHz | 1745MHz | 1712.5MHz | |
| | 1RB | High | QPSK | 23.51 | 23.66 | 23.43 | 24 |
| | | | 16QAM | 22.42 | 22.28 | 22.32 | 23 |
| | | Middle | QPSK | 23.62 | 23.86 | 23.44 | 24 |
| | | | 16QAM | 22.65 | 22.31 | 22.59 | 23 |
| | | Low | QPSK | 22.94 | 22.94 | 22.88 | 24 |
| | | | 16QAM | 21.84 | 22.00 | 21.91 | 23 |
| | 12RB | High | QPSK | 22.41 | 22.45 | 22.40 | 23 |
| | | | 16QAM | 21.48 | 21.46 | 21.39 | 22 |
| | | Middle | QPSK | 22.55 | 22.43 | 22.39 | 23 |
| | | | 16QAM | 21.42 | 21.49 | 21.44 | 22 |
| | | Low | QPSK | 22.49 | 22.27 | 22.30 | 23 |
| | | | 16QAM | 21.47 | 21.35 | 21.33 | 22 |
| | 25RB | / | QPSK | 22.51 | 22.44 | 22.43 | 23 |
| 16QAM | | | 21.41 | 21.42 | 21.39 | 22 | |
| 10 MHz | | | | 1775MHz | 1745MHz | 1715MHz | / |
| | 1RB | High | QPSK | 23.55 | 23.67 | 23.41 | 24 |
| | | | 16QAM | 22.41 | 22.25 | 22.30 | 23 |
| | | Middle | QPSK | 23.61 | 23.88 | 23.44 | 24 |
| | | | 16QAM | 22.67 | 22.30 | 22.59 | 23 |
| | | Low | QPSK | 22.98 | 22.92 | 22.88 | 24 |
| | | | 16QAM | 21.85 | 22.01 | 21.91 | 23 |
| | 25RB | High | QPSK | 22.41 | 22.44 | 22.40 | 23 |
| | | | 16QAM | 21.47 | 21.44 | 21.37 | 22 |
| | | Middle | QPSK | 22.59 | 22.42 | 22.43 | 23 |
| | | | 16QAM | 21.42 | 21.48 | 21.43 | 22 |
| | | Low | QPSK | 22.48 | 22.27 | 22.29 | 23 |
| | | | 16QAM | 21.49 | 21.35 | 21.31 | 22 |
| | 50RB | / | QPSK | 22.49 | 22.46 | 22.45 | 23 |
| 16QAM | | | 21.45 | 21.42 | 21.40 | 22 | |

Full Power

| LTE-FDD Band 66 | | | | Actual output Power (dBm) | | | Tune up |
|-----------------|---------------|-----------|------------|---------------------------|--------------|-----------|-----------|
| Band-width | RB allocation | RB offset | Modulation | High | Middle | Low | |
| 15 MHz | | | | 1772.5MHz | 1745MHz | 1717.5MHz | |
| | 1RB | High | QPSK | 23.49 | 23.65 | 23.43 | 24 |
| | | | 16QAM | 22.37 | 22.28 | 22.32 | 23 |
| | | Middle | QPSK | 23.57 | 23.85 | 23.46 | 24 |
| | | | 16QAM | 22.63 | 22.30 | 22.57 | 23 |
| | | Low | QPSK | 22.92 | 22.93 | 22.88 | 24 |
| | | | 16QAM | 21.79 | 22.02 | 21.89 | 23 |
| | 36RB | High | QPSK | 22.35 | 22.45 | 22.39 | 23 |
| | | | 16QAM | 21.43 | 21.45 | 21.37 | 22 |
| | | Middle | QPSK | 22.53 | 22.44 | 22.41 | 23 |
| | | | 16QAM | 21.40 | 21.49 | 21.42 | 22 |
| | | Low | QPSK | 22.44 | 22.27 | 22.29 | 23 |
| | | | 16QAM | 21.46 | 21.33 | 21.32 | 22 |
| | 75RB | / | QPSK | 22.45 | 22.44 | 22.47 | 23 |
| 16QAM | | | 21.38 | 21.42 | 21.35 | 22 | |
| 20 MHz | | | | 1770MHz | 1745MHz | 1720MHz | / |
| | 1RB | High | QPSK | 23.52 | 23.64 | 23.40 | 24 |
| | | | 16QAM | 22.40 | 22.26 | 22.31 | 23 |
| | | Middle | QPSK | 23.60 | 23.87 | 23.45 | 24 |
| | | | 16QAM | 22.66 | 22.29 | 22.56 | 23 |
| | | Low | QPSK | 22.95 | 22.91 | 22.87 | 24 |
| | | | 16QAM | 21.82 | 21.98 | 21.88 | 23 |
| | 50RB | High | QPSK | 22.38 | 22.43 | 22.38 | 23 |
| | | | 16QAM | 21.46 | 21.43 | 21.36 | 22 |
| | | Middle | QPSK | 22.56 | 22.41 | 22.40 | 23 |
| | | | 16QAM | 21.43 | 21.47 | 21.42 | 22 |
| | | Low | QPSK | 22.47 | 22.25 | 22.28 | 23 |
| | | | 16QAM | 21.48 | 21.32 | 21.31 | 22 |
| | 100RB | / | QPSK | 22.48 | 22.42 | 22.44 | 23 |
| 16QAM | | | 21.42 | 21.40 | 21.37 | 22 | |

Hotspot on

| LTE-FDD Band 66 | | | | Actual output Power (dBm) | | | Tune up |
|-----------------|---------------|-----------|------------|---------------------------|---------|-----------|---------|
| Band-width | RB allocation | RB offset | Modulation | High | Middle | Low | |
| 1.4 MHz | | | | 1779.3MHz | 1745MHz | 1710.7MHz | |
| | 1RB | High | QPSK | 19.23 | 19.36 | 19.23 | 20.5 |
| | | | 16QAM | 19.58 | 19.70 | 19.56 | 20.5 |
| | | Middle | QPSK | 19.28 | 19.36 | 19.28 | 20.5 |
| | | | 16QAM | 19.65 | 19.71 | 19.64 | 20.5 |
| | | Low | QPSK | 18.89 | 18.93 | 18.79 | 20.5 |
| | | | 16QAM | 19.33 | 19.44 | 19.30 | 20.5 |
| | 3RB | High | QPSK | 19.32 | 19.41 | 19.26 | 20.5 |
| | | | 16QAM | 19.39 | 19.43 | 19.28 | 20.5 |
| | | Middle | QPSK | 19.50 | 19.42 | 19.46 | 20.5 |
| | | | 16QAM | 19.53 | 19.44 | 19.43 | 20.5 |
| | | Low | QPSK | 19.32 | 19.24 | 19.19 | 20.5 |
| | | | 16QAM | 19.37 | 19.30 | 19.27 | 20.5 |
| | 6RB | / | QPSK | 19.46 | 19.32 | 19.33 | 20.5 |
| 16QAM | | | 19.51 | 19.37 | 19.36 | 20.5 | |
| 3 MHz | | | | 1778.5MHz | 1745MHz | 1711.5MHz | / |
| | 1RB | High | QPSK | 19.18 | 19.31 | 19.21 | 20.5 |
| | | | 16QAM | 19.52 | 19.65 | 19.55 | 20.5 |
| | | Middle | QPSK | 19.25 | 19.30 | 19.27 | 20.5 |
| | | | 16QAM | 19.62 | 19.66 | 19.58 | 20.5 |
| | | Low | QPSK | 18.84 | 18.88 | 18.74 | 20.5 |
| | | | 16QAM | 19.29 | 19.39 | 19.28 | 20.5 |
| | 8RB | High | QPSK | 19.28 | 19.35 | 19.25 | 20.5 |
| | | | 16QAM | 19.34 | 19.39 | 19.28 | 20.5 |
| | | Middle | QPSK | 19.44 | 19.37 | 19.44 | 20.5 |
| | | | 16QAM | 19.47 | 19.39 | 19.40 | 20.5 |
| | | Low | QPSK | 19.27 | 19.17 | 19.14 | 20.5 |
| | | | 16QAM | 19.34 | 19.25 | 19.25 | 20.5 |
| | 15RB | / | QPSK | 19.41 | 19.27 | 19.32 | 20.5 |
| 16QAM | | | 19.47 | 19.32 | 19.33 | 20.5 | |

Hotspot on

| LTE-FDD Band 66 | | | | Actual output Power (dBm) | | | Tune up |
|-----------------|---------------|-----------|------------|---------------------------|---------|-----------|---------|
| Band-width | RB allocation | RB offset | Modulation | High | Middle | Low | |
| 5 MHz | | | | 1777.5MHz | 1745MHz | 1712.5MHz | |
| | 1RB | High | QPSK | 19.25 | 19.31 | 19.25 | 20.5 |
| | | | 16QAM | 19.60 | 19.65 | 19.59 | 20.5 |
| | | Middle | QPSK | 19.32 | 19.30 | 19.31 | 20.5 |
| | | | 16QAM | 19.69 | 19.66 | 19.66 | 20.5 |
| | | Low | QPSK | 18.92 | 18.88 | 18.82 | 20.5 |
| | | | 16QAM | 19.37 | 19.39 | 19.32 | 20.5 |
| | 12RB | High | QPSK | 19.36 | 19.35 | 19.29 | 20.5 |
| | | | 16QAM | 19.41 | 19.37 | 19.30 | 20.5 |
| | | Middle | QPSK | 19.52 | 19.37 | 19.48 | 20.5 |
| | | | 16QAM | 19.55 | 19.39 | 19.46 | 20.5 |
| | | Low | QPSK | 19.35 | 19.19 | 19.22 | 20.5 |
| | | | 16QAM | 19.41 | 19.25 | 19.29 | 20.5 |
| | 25RB | / | QPSK | 19.49 | 19.27 | 19.36 | 20.5 |
| 16QAM | | | 19.54 | 19.32 | 19.39 | 20.5 | |
| 10 MHz | | | | 1775MHz | 1745MHz | 1715MHz | / |
| | 1RB | High | QPSK | 19.16 | 19.39 | 19.17 | 20.5 |
| | | | 16QAM | 19.51 | 19.73 | 19.51 | 20.5 |
| | | Middle | QPSK | 19.23 | 19.38 | 19.23 | 20.5 |
| | | | 16QAM | 19.60 | 19.74 | 19.58 | 20.5 |
| | | Low | QPSK | 18.83 | 18.96 | 18.74 | 20.5 |
| | | | 16QAM | 19.28 | 19.47 | 19.24 | 20.5 |
| | 25RB | High | QPSK | 19.27 | 19.43 | 19.21 | 20.5 |
| | | | 16QAM | 19.32 | 19.45 | 19.22 | 20.5 |
| | | Middle | QPSK | 19.43 | 19.45 | 19.40 | 20.5 |
| | | | 16QAM | 19.46 | 19.47 | 19.38 | 20.5 |
| | | Low | QPSK | 19.26 | 19.27 | 19.14 | 20.5 |
| | | | 16QAM | 19.32 | 19.33 | 19.21 | 20.5 |
| | 50RB | / | QPSK | 19.40 | 19.35 | 19.28 | 20.5 |
| 16QAM | | | 19.45 | 19.40 | 19.31 | 20.5 | |

Hotspot on

| LTE-FDD Band 66 | | | | Actual output Power (dBm) | | | Tune up |
|-----------------|---------------|-----------|------------|---------------------------|---------|-----------|---------|
| Band-width | RB allocation | RB offset | Modulation | High | Middle | Low | |
| 15 MHz | | | | 1772.5MHz | 1745MHz | 1717.5MHz | |
| | 1RB | High | QPSK | 19.24 | 19.29 | 19.23 | 20.5 |
| | | | 16QAM | 19.59 | 19.63 | 19.57 | 20.5 |
| | | Middle | QPSK | 19.30 | 19.28 | 19.29 | 20.5 |
| | | | 16QAM | 19.67 | 19.64 | 19.64 | 20.5 |
| | | Low | QPSK | 18.91 | 18.95 | 18.80 | 20.5 |
| | | | 16QAM | 19.36 | 19.46 | 19.30 | 20.5 |
| | 36RB | High | QPSK | 19.34 | 19.41 | 19.27 | 20.5 |
| | | | 16QAM | 19.39 | 19.43 | 19.28 | 20.5 |
| | | Middle | QPSK | 19.51 | 19.35 | 19.47 | 20.5 |
| | | | 16QAM | 19.54 | 19.37 | 19.44 | 20.5 |
| | | Low | QPSK | 19.33 | 19.17 | 19.20 | 20.5 |
| | | | 16QAM | 19.39 | 19.23 | 19.27 | 20.5 |
| | 75RB | / | QPSK | 19.48 | 19.25 | 19.34 | 20.5 |
| 16QAM | | | 19.53 | 19.30 | 19.37 | 20.5 | |
| 20 MHz | | | | 1770MHz | 1745MHz | 1720MHz | / |
| | 1RB | High | QPSK | 19.20 | 19.34 | 19.20 | 20.5 |
| | | | 16QAM | 19.55 | 19.68 | 19.54 | 20.5 |
| | | Middle | QPSK | 19.27 | 19.33 | 19.26 | 20.5 |
| | | | 16QAM | 19.64 | 19.69 | 19.61 | 20.5 |
| | | Low | QPSK | 18.87 | 18.91 | 18.77 | 20.5 |
| | | | 16QAM | 19.32 | 19.42 | 19.27 | 20.5 |
| | 50RB | High | QPSK | 19.31 | 19.38 | 19.24 | 20.5 |
| | | | 16QAM | 19.36 | 19.40 | 19.25 | 20.5 |
| | | Middle | QPSK | 19.47 | 19.40 | 19.43 | 20.5 |
| | | | 16QAM | 19.50 | 19.42 | 19.41 | 20.5 |
| | | Low | QPSK | 19.30 | 19.22 | 19.17 | 20.5 |
| | | | 16QAM | 19.36 | 19.28 | 19.24 | 20.5 |
| | 100RB | / | QPSK | 19.44 | 19.30 | 19.31 | 20.5 |
| 16QAM | | | 19.49 | 19.35 | 19.34 | 20.5 | |