



Hearing Aid Compatibility (HAC) RF Emissions Test Report

APPLICANT : Yulong Computer Telecommunication
Scientific (Shenzhen) Co., Ltd
EQUIPMENT : Smartphone
BRAND NAME : Coolpad
MODEL NAME : Coolpad 3701A
FCC ID : R38YL3701A
STANDARD : FCC 47 CFR §20.19
ANSI C63.19-2011

We, SPORTON International (ShenZhen) INC., would like to declare that the tested sample has been evaluated in accordance with the procedures and had been in compliance with the applicable technical standards.

The test results in this report apply exclusively to the tested model / sample. Without written approval of SPORTON International (ShenZhen) INC., the test report shall not be reproduced except in full.

Prepared by: Mark Qu / Manager

Approved by: Jones Tsai / Manager



SPORTON International (ShenZhen) INC.

1/F, 2/F, Bldg 5, Shiling Industrial Zone, Xinwei Village, Xili, Nanshan District, Shenzhen City,
Guangdong Province, China



Table of Contents

| | |
|---|----|
| 1. Attestation of Test Results | 4 |
| 2. Administration Data | 4 |
| 3. Equipment Under Test Information | 5 |
| 3.1 General Information | 5 |
| 3.2 Air Interface and Operating Mode | 6 |
| 3.3 Applied Standards | 7 |
| 4. HAC RF Emission | 8 |
| 5. Measurement System Specification | 9 |
| 5.1 Test Arch Phantom | 9 |
| 5.2 E-Field Probe System | 10 |
| 5.3 System Hardware | 10 |
| 5.4 Data Storage and Evaluation | 11 |
| 5.5 Test Equipment List | 12 |
| 6. Measurement System Validation | 13 |
| 6.1 Purpose of System Performance Check | 13 |
| 6.2 System Setup | 13 |
| 6.3 Verification Results | 14 |
| 7. RF Emissions Test Procedure | 15 |
| 8. Modulation Interference Factor | 19 |
| 9. Low-power Exemption | 21 |
| 10. Conducted RF Output Power (Unit: dBm) | 23 |
| 11. HAC RF Emission Test Results | 24 |
| 12. Uncertainty Assessment | 25 |
| 13. References | 27 |
| Appendix A. Plots of System Performance Check | |
| Appendix B. Plots of RF Emission Measurement | |
| Appendix C. DASYS Calibration Certificate | |
| Appendix D. Test Setup Photos | |



1. Attestation of Test Results

| | |
|----------------|--|
| Applicant Name | Yulong Computer Telecommunication Scientific (Shenzhen) Co., Ltd |
| Equipment Name | Smartphone |
| Brand Name | Coolpad |
| Model Name | Coolpad 3701A |
| FCC ID | R38YL3701A |
| IMEI Code | 861273030013131 |
| HW Version | V2 |
| SW Version | 117.00.170706.3701A-TMO |
| EUT Stage | Identical Prototype |
| HAC Rating | M3 |
| Date Tested | Jul. 01, 2017 |
| Test Result | Pass |

This device is compliance with HAC limits specified in guidelines FCC 47 CFR §20.19 and ANSI Standard ANSI C63.19.

2. Administration Data

| Testing Site | |
|--------------------|---|
| Test Site | SPORTON International (ShenZhen) INC. |
| Test Site Location | 1/F, 2/F, Bldg 5, Shiling Industrial Zone, Xinwei Village, Xili, Nanshan District, Shenzhen City, Guangdong Province, China TEL: +86-755-8637-9589 FAX: +86-755-8637-9595 |
| Test Site No. | Sporton Site No. : SAR01-SZ |
| Applicant | |
| Company Name | Yulong Computer Telecommunication Scientific (Shenzhen) Co., Ltd |
| Address | Coolpad Information Harbor, High-tech Industrial Park (North), Nanshan District, Shenzhen, P.R.C. |
| Manufacturer | |
| Company Name | Yulong Computer Telecommunication Scientific (Shenzhen) Co., Ltd |
| Address | Coolpad Information Harbor, High-tech Industrial Park (North), Nanshan District, Shenzhen, P.R.C. |



3. Equipment Under Test Information

3.1 General Information

| Product Feature & Specification | |
|--|--|
| Wireless Technology and Frequency Range | GSM850: 824.2 MHz ~ 848.8 MHz GSM1900: 1850.2 MHz ~ 1909.8 MHz WCDMA Band II: 1852.4 MHz ~ 1907.6 MHz WCDMA Band IV: 1712.4 MHz ~ 1752.6 MHz WCDMA Band V: 826.4 MHz ~ 846.6 MHz LTE Band 2: 1850.7 MHz ~ 1909.3 MHz LTE Band 4: 1710.7 MHz ~ 1754.3 MHz LTE Band 5: 824.7 MHz ~ 848.3 MHz LTE Band 12: 699.7 MHz ~ 715.3 MHz LTE Band 66: 1710.7 MHz ~ 1779.3 MHz WLAN 2.4GHz Band: 2412 MHz ~ 2462 MHz WLAN 5.2GHz Band: 5180 MHz ~ 5240 MHz WLAN 5.3GHz Band: 5260 MHz ~ 5320 MHz WLAN 5.5GHz Band: 5500 MHz ~ 5720 MHz WLAN 5.8GHz Band: 5745 MHz ~ 5825 MHz Bluetooth: 2402 MHz ~ 2480 MHz |
| Mode | GSM/GPRS/EGPRS RMC/AMR 12.2Kbps HSDPA HSUPA DC-HSDPA HSPA+ (16QAM uplink is not supported) LTE: QPSK, 16QAM 802.11b/g/n HT20/HT40 802.11a/n HT20/HT40/ac VHT20/VHT40/VHT80 Bluetooth v3.0 + EDR, Bluetooth v4.0 LE |
| Remark: | |
| <ol style="list-style-type: none"> This device supports VoIP in GPRS, EGPRS, WCDMA and LTE (e.g. for 3rd-party VoIP), and LTE supports VoLTE operation. This device supports GRPS/EGRPS mode up to multi-slot class 12 and does not support DTM operation. | |



3.2 Air Interface and Operating Mode

| Air Interface | Band MHz | Type | C63.19 Tested | Simultaneous Transmitter | OTT | Power Reduction |
|---------------|-----------|------|---------------------|--------------------------|-----|-----------------|
| GSM | 850 | VO | Yes | WLAN, BT | NA | No |
| | 1900 | | | WLAN, BT | NA | No |
| | GPRS/EDGE | DT | No | WLAN, BT | Yes | No |
| WCDMA | Band V | VO | No ⁽¹⁾ | WLAN, BT | NA | No |
| | Band IV | | | WLAN, BT | NA | Yes |
| | Band II | | | WLAN, BT | NA | Yes |
| | HSPA | DT | No | WLAN, BT | Yes | Yes |
| LTE - FDD | Band 2 | VD | No ^(1,3) | WLAN, BT | Yes | Yes |
| | Band 4 | | | WLAN, BT | | Yes |
| | Band 5 | | | WLAN, BT | | No |
| | Band 12 | | | WLAN, BT | | No |
| | Band 66 | | | WLAN, BT | | Yes |
| WLAN | 2.4GHz | VD | No ^(2,3) | GSM,WCDMA,LTE | Yes | No |
| | 5GHz | | | | | |
| BT | 2450 | DT | No | GSM,WCDMA,LTE | NA | No |

VO=CMRS Voice Service
 DT=Digital Transport
 VD=CMRS IP Voice Service and Digital Transport

Remark:

- WCDMA and LTE is exempted from testing by low power exemption that its average antenna input power plus its MIF is ≤ 17 dBm, and is rated as M4.
- For 2.4GHz WLAN RF emissions testing exemption shall be applied to an RF air interface technology in a device whose Peak antenna input power, averaged over intervals $\leq 50 \mu s$, is ≤ 23 dBm.
- No Associated T-Coil measurement has been made in accordance with KDB 285076 D02 T-Coil testing for CMRS IP.



3.3 Applied Standards

- FCC CFR47 Part 20.19
- ANSI C63.19 2011-version
- FCC KDB 285076 D01 HAC Guidance v04r01
- FCC KDB 285076 D02 T Coil testing for CMRS IP v02



4. HAC RF Emission

FCC wireless hearing aid compatibility rules ensure that consumers with hearing loss are able to access wireless communications services through a wide selection of handsets without experiencing disabling radio frequency (RF) interference or other technical obstacles.

To define and measure the hearing aid compatibility of handsets, in CFR47 part 20.19 ANSI C63.19 is referenced. A handset is considered hearing aid-compatible for acoustic coupling if it meets a rating of at least M3 under ANSI C63.19, and A handset is considered hearing aid compatible for inductive coupling if it meets a rating of at least T3.

According to ANSI C63.19 2011 version, for acoustic coupling, the RF electric field emissions of wireless communication devices should be measured and rated according to the emission level as below.

| Emission Categories | E-field emissions | |
|---------------------|-------------------|-------------------|
| | <960Mhz | >960Mhz |
| M1 | 50 to 55 dB (V/m) | 40 to 45 dB (V/m) |
| M2 | 45 to 50 dB (V/m) | 35 to 40 dB (V/m) |
| M3 | 40 to 45 dB (V/m) | 30 to 35 dB (V/m) |
| M4 | <40 dB (V/m) | <30 dB (V/m) |

Table 4.1 Telephone near-field categories in linear units

5. Measurement System Specification

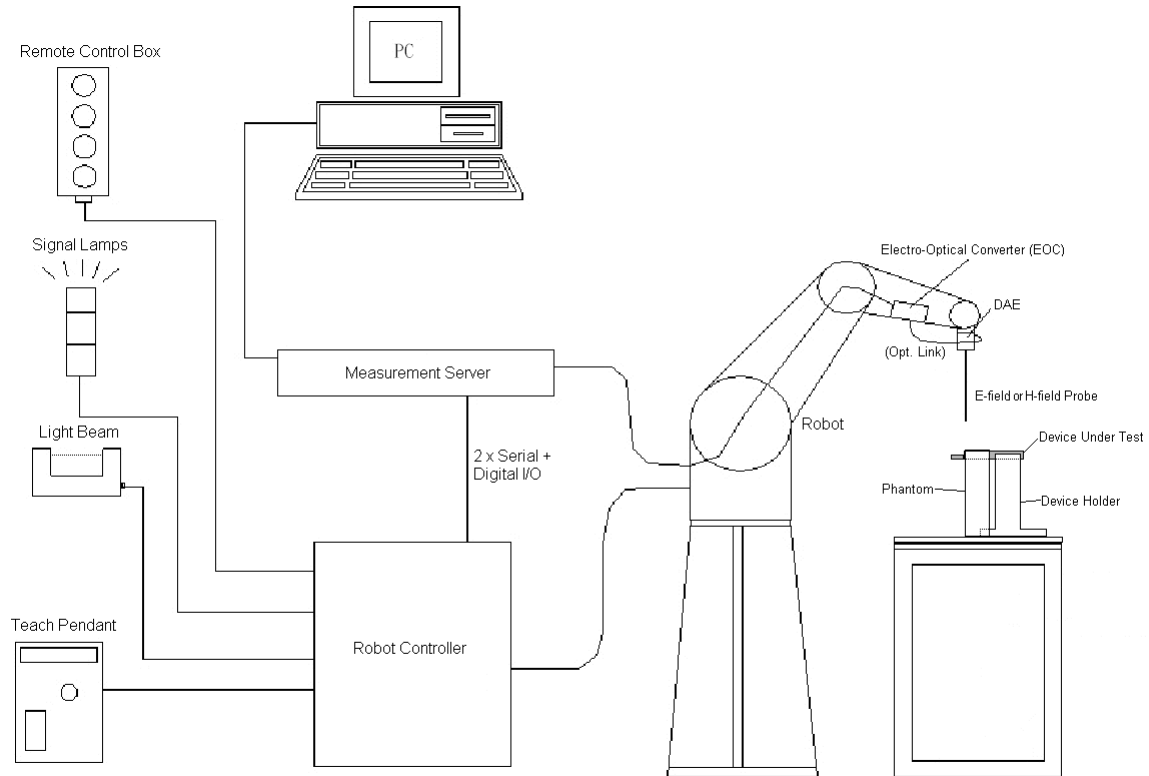

Fig 5.1 SPEAG DASY5 System Configurations

5.1 Test Arch Phantom

| | | |
|------------------------------|---|--|
| <p>Construction :</p> | <p>Enables easy and well defined positioning of the phone and validation dipoles as well as simple teaching of the robot.</p> |  |
| <p>Dimensions :</p> | <p>370 x 370 x 370 mm</p> | |

Fig 5.8 Photo of Arch Phantom

5.2 E-Field Probe System

**E-Field Probe Specification
<ER3DV6>**

| | |
|----------------------|--|
| Construction | One dipole parallel, two dipoles normal to probe axis Built-in shielding against static charges |
| Calibration | In air from 100 MHz to 3.0 GHz (absolute accuracy $\pm 6.0\%$, $k=2$) |
| Frequency | 100 MHz to 6 GHz; Linearity: ± 2.0 dB (100 MHz to 3 GHz) |
| Directivity | ± 0.2 dB in air (rotation around probe axis) ± 0.4 dB in air (rotation normal to probe axis) |
| Dynamic Range | 2 V/m to 1000 V/m (M3 or better device readings fall well below diode compression point) |
| Linearity | ± 0.2 dB |
| Dimensions | Overall length: 330 mm (Tip: 16 mm) Tip diameter: 8 mm (Body: 12 mm) Distance from probe tip to dipole centers: 2.5 mm |

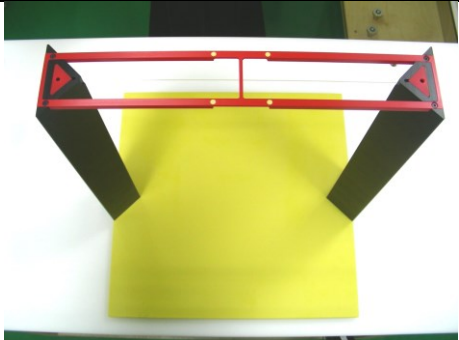

Fig 5.2 Photo of E-field Probe

Probe Tip Description:

HAC field measurements take place in the close near field with high gradients. Increasing the measuring distance from the source will generally decrease the measured field values (in case of the validation dipole approx. 10% per mm).

5.3 System Hardware

DAE

The data acquisition electronics (DAE) consists of a highly sensitive electrometer-grade preamplifier with auto-zeroing, a channel and gain-switching multiplexer, a fast 16 bit AD-converter and a command decoder and control logic unit.

Robot

The SPEAG DASY system uses the high precision robots (DASY5: TX90XL) type from Stäubli SA (France). For the 6-axis controller system, the robot controller version (DASY5: CS8c) from Stäubli is used.

5.4 Data Storage and Evaluation

The DASY software stores the assessed data from the data acquisition electronics as raw data (in microvolt readings from the probe sensors), together with all the necessary software parameters for the data evaluation (probe calibration data, and device frequency and modulation data) in measurement files.

| | | |
|----------------------------|---------------------------|---|
| Probe parameters : | - Sensitivity | Norm _i , a _{i0} , a _{i1} , a _{i2} |
| | - Conversion factor | ConvF _i |
| | - Diode compression point | dcp _i |
| Device parameters : | - Frequency | f |
| | - Crest factor | cf |
| Media parameters : | - Conductivity | σ |
| | - Density | ρ |

The formula for each channel can be given as :

$$V_i = U_i + U_i^2 \cdot \frac{cf}{dcp_i}$$

- with V_i = compensated signal of channel i, (i = x, y, z)
- U_i = input signal of channel i, (i = x, y, z)
- cf = crest factor of exciting field (DASY parameter)
- dcp_i = diode compression point (DASY parameter)

From the compensated input signals, the primary field data for each channel can be evaluated :

$$\text{E-field Probes : } E_i = \sqrt{\frac{V_i}{\text{Norm}_i \cdot \text{ConvF}}}$$

- with V_i = compensated signal of channel i, (i = x, y, z)
- Norm_i = sensor sensitivity of channel i, (i = x, y, z), μV/(V/m)² for E-field Probes
- ConvF = sensitivity enhancement in solution
- f = carrier frequency [GHz]
- E_i = electric field strength of channel i in V/m

The RSS value of the field components gives the total field strength (Hermitian magnitude) :

$$E_{\text{tot}} = \sqrt{E_x^2 + E_y^2 + E_z^2}$$

The primary field data are used to calculate the derived field units.



5.5 Test Equipment List

| Manufacturer | Name of Equipment | Type/Model | Serial Number | Calibration | |
|---------------|------------------------------|------------|---------------|---------------|---------------|
| | | | | Last Cal. | Due Date |
| SPEAG | 835MHz Calibration Dipole | CD835V3 | 1184 | May 22, 2017 | May 21, 2018 |
| SPEAG | 1880MHz Calibration Dipole | CD1880V3 | 1170 | May 22, 2017 | May 21, 2018 |
| SPEAG | Data Acquisition Electronics | DAE4 | 1303 | Nov. 22, 2016 | Nov. 21, 2017 |
| SPEAG | Isotropic E-Field Probe | ER3DV6 | 2528 | Jan. 25, 2017 | Jan. 24, 2018 |
| SPEAG | Phone Positioner | N/A | N/A | NCR | NCR |
| Anritsu | Power Meter | ML2495A | 1349001 | Jan. 03, 2017 | Jan. 02, 2018 |
| Anritsu | Power Sensor | MA2411B | 1306099 | Jan. 03, 2017 | Jan. 02, 2018 |
| R&S | Base Station(Measure) | CMU200 | S110518JGE02 | Jan. 03, 2017 | Jan. 02, 2018 |
| Agilent | Signal Generator | N5181A | MY50145381 | Jan. 03, 2017 | Jan. 02, 2018 |
| Agilent | Dual Directional Coupler | 778D | 50422 | NCR | NCR |
| Woken | Attenuator | WK0602-XX | N/A | NCR | NCR |
| AR | Power Amplifier | 5S1G4M2 | 0328767 | NCR | NCR |
| mini-circuits | Amplifier | ZHL-42W+ | QA1341002 | May 15, 2017 | May 14, 2018 |
| mini-circuits | Amplifier | ZVE-3W-83+ | 599201528 | May 15, 2017 | May 14, 2018 |
| R&S | Spectrum Analyzer | FSP7 | 101634 | Jul. 16, 2016 | Jul. 15, 2017 |

Table 5.1 Test Equipment List

Note: NCR: "No-Calibration Required"

6. Measurement System Validation

Each DASY system is equipped with one or more system validation kits. These units, together with the predefined measurement procedures within the DASY software, enable the user to conduct the system performance check and system validation. System validation kit includes a dipole, tripod holder to fix it underneath the test Arch and a corresponding distance holder.

6.1 Purpose of System Performance Check

The system performance check verifies that the system operates within its specifications. System and operator errors can be detected and corrected. It is recommended that the system performance check be performed prior to any usage of the system in order to guarantee reproducible results. The system performance check uses normal HAC measurements in a simplified setup with a well characterized source. This setup was selected to give a high sensitivity to all parameters that might fail or vary over time. The system check does not intend to replace the calibration of the components, but indicates situations where the system uncertainty is exceeded due to drift or failure.

6.2 System Setup

1. In the simplified setup for system evaluation, the EUT is replaced by a calibrated dipole and the power source is replaced by a continuous wave which comes from a signal generator.
2. The center point of the probe element(s) is 15mm from the closest surface of the dipole elements.
3. The calibrated dipole must be placed beneath the arch phantom. The equipment setup is shown below:

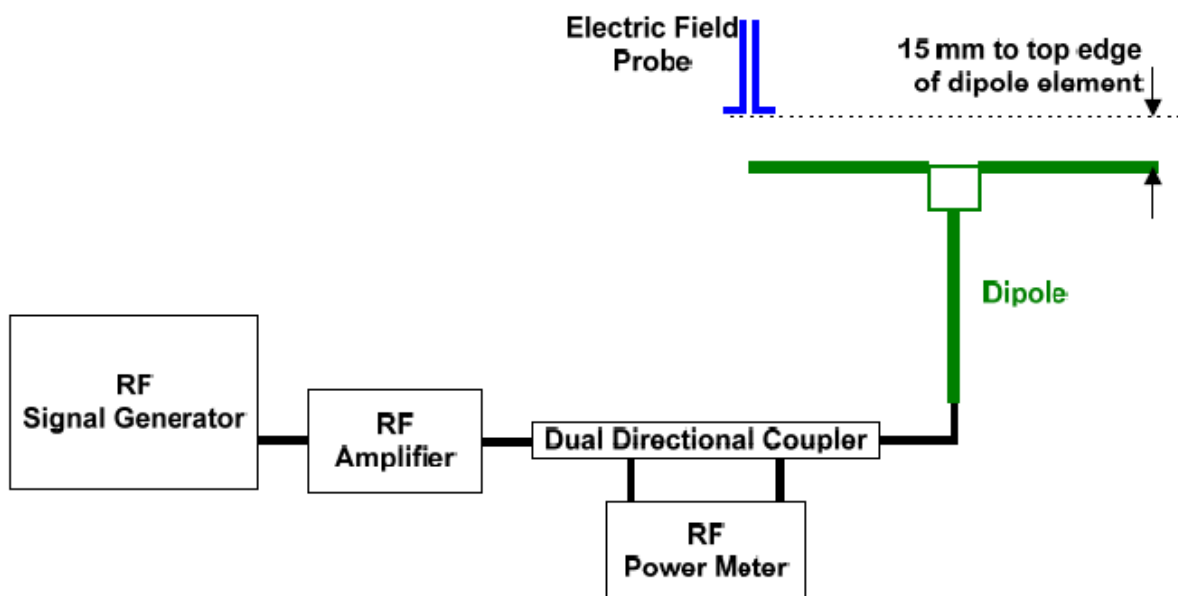

Fig. 6.1 System Validation Setup

The output power on dipole port must be calibrated to 20dBm (100mW) before dipole is connected.

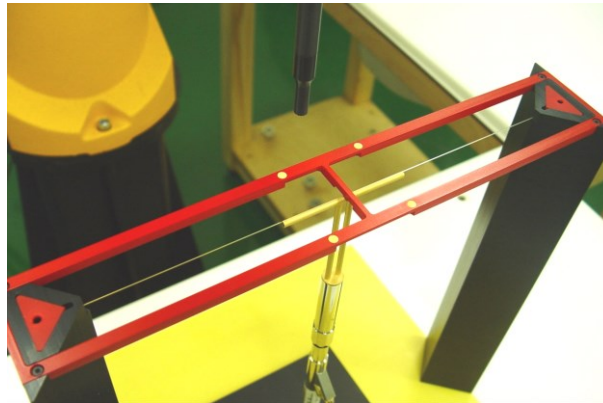

Fig 7.2 Dipole Setup

6.3 Verification Results

Comparing to the original E-field value provided by SPEAG, the verification data should be within its specification of 25 %. Table 6.1 shows the target value and measured value. The table below indicates the system performance check can meet the variation criterion and the plots can be referred to appendix A of this report.

| Frequency (MHz) | Input Power (dBm) | Target Value (V/m) | E-Field above high end (V/m) | E-Field above low end (V/m) | Average Value (V/m) | Deviation (%) | Date |
|-----------------|-------------------|--------------------|------------------------------|-----------------------------|---------------------|---------------|---------------|
| 835 | 20 | 109.2 | 113.9 | 113.8 | 113.85 | 4.26 | Jul. 01, 2017 |
| 1880 | 20 | 91.2 | 93.2 | 96.5 | 94.85 | 4.00 | Jul. 01, 2017 |

Table 6.1 Test Results of System Validation

Note: Deviation = ((Average E-field Value) - (Target value)) / (Target value) * 100%



7. RF Emissions Test Procedure

Referenced from ANSI C63.19 -2011 section 5.5.1

- a) Confirm the proper operation of the field probe, probe measurement system, and other instrumentation and the positioning system.
- b) Position the WD in its intended test position.
- c) Set the WD to transmit a fixed and repeatable combination of signal power and modulation characteristic that is representative of the worst case (highest interference potential) encountered in normal use. Transiently occurring start-up, changeover, or termination conditions, or other operations likely to occur less than 1% of the time during normal operation, may be excluded from consideration.
- d) The center sub-grid shall be centered on the T-Coil mode perpendicular measurement point or the acoustic output, as appropriate. Locate the field probe at the initial test position in the 50 mm by 50 mm grid, which is contained in the measurement plane, refer to illustrated in Figure 8.2. If the field alignment method is used, align the probe for maximum field reception.
- e) Record the reading at the output of the measurement system.
- f) Scan the entire 50 mm by 50 mm region in equality spaced increments and record the reading at each measurement point, The distance between measurement points shall be sufficient to assure the identification of the maximum reading.
- g) Identify the five contiguous sub-grids around the center sub-grid whose maximum reading is the lowest of all available choices. This eliminates the three sub-grids with the maximum readings. Thus, the six areas to be used to determine the WD's highest emissions are identified.
- h) Identify the maximum reading within the non-excluded sub-grids identified in step g).
- i) *Indirect measurement method*
The RF audio interference level in dB (V/m) is obtained by adding the MIF (in dB) to the maximum steady-state rms field-strength reading, in dB (V/m)
- j) Compare this RF audio interference level with the categories in ANSI C63.19-2011 clause 8 and record the resulting WD category rating.
- k) For the T-Coil mode M-rating assessment, determine whether the chosen perpendicular measurement point is contained in an included sub-grid of the first scan. If so, then a second scan is not necessary. The first scan and resultant category rating may be used for the T-Coil mode M rating.

Otherwise, repeat step a) through step i), with the grid shifted so that it is centered on the perpendicular measurement point. Record the WD category rating.



Referenced from ANSI C63.19 -2011 section 5.5.1

- a) Confirm the proper operation of the field probe, probe measurement system, and other instrumentation and the positioning system.
- b) Position the WD in its intended test position.
- c) Set the WD to transmit a fixed and repeatable combination of signal power and modulation characteristic that is representative of the worst case (highest interference potential) encountered in normal use. Transiently occurring start-up, changeover, or termination conditions, or other operations likely to occur less than 1% of the time during normal operation, may be excluded from consideration.
- d) The center sub-grid shall be centered on the T-Coil mode perpendicular measurement point or the acoustic output, as appropriate. Locate the field probe at the initial test position in the 50 mm by 50 mm grid, which is contained in the measurement plane, refer to illustrated in Figure 8.2. If the field alignment method is used, align the probe for maximum field reception.
- e) Record the reading at the output of the measurement system.
- f) Scan the entire 50 mm by 50 mm region in equality spaced increments and record the reading at each measurement point, The distance between measurement points shall be sufficient to assure the identification of the maximum reading.
- g) Identify the five contiguous sub-grids around the center sub-grid whose maximum reading is the lowest of all available choices. This eliminates the three sub-grids with the maximum readings. Thus, the six areas to be used to determine the WD's highest emissions are identified.
- h) Identify the maximum reading within the non-excluded sub-grids identified in step g).
- i) *Indirect measurement method*
The RF audio interference level in dB (V/m) is obtained by adding the MIF (in dB) to the maximum steady-state rms field-strength reading, in dB (V/m)
- j) Compare this RF audio interference level with the categories in ANSI C63.19-2011 clause 8 and record the resulting WD category rating.
- k) For the T-Coil perpendicular measurement location is ≥ 5.0 mm from the center of the acoustic output, then two different 50 mm by 50 mm areas may need to be scanned, the first for the microphone mode assessment and the second for the T-Coil assessment.
- l) The second for the T-Coil assessment, with the grid shifted so that it is centered on the perpendicular measurement point. Record the WD category rating.

Test Instructions

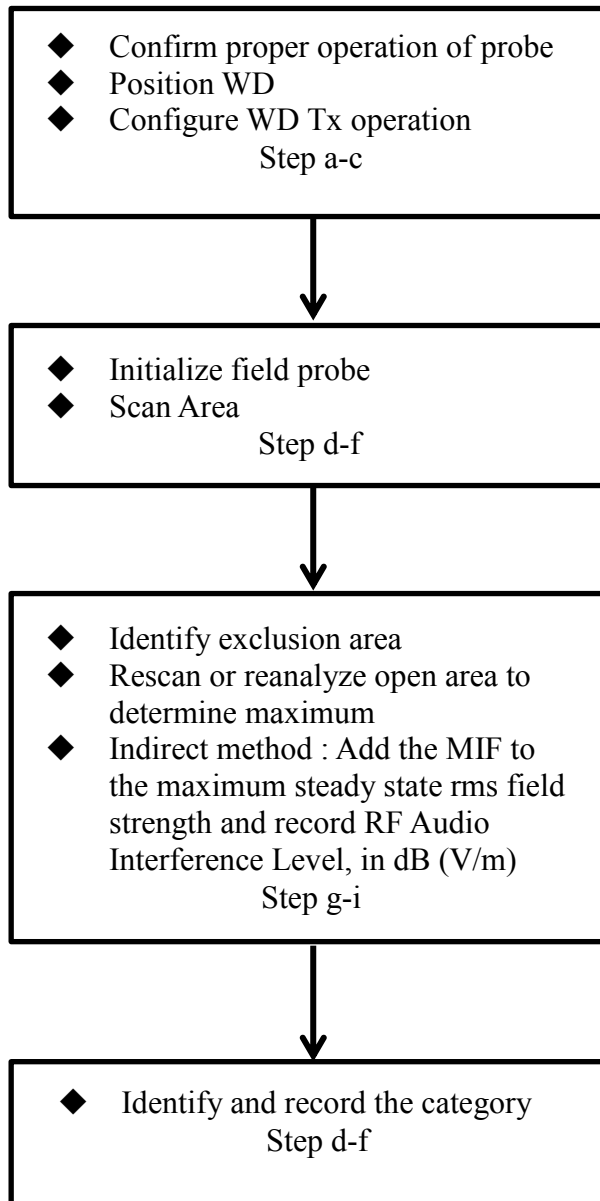

Fig 8.1 Flow Chart of HAC RF Emission



Fig 8.2 EUT reference and plane for HAC RF emission measurements

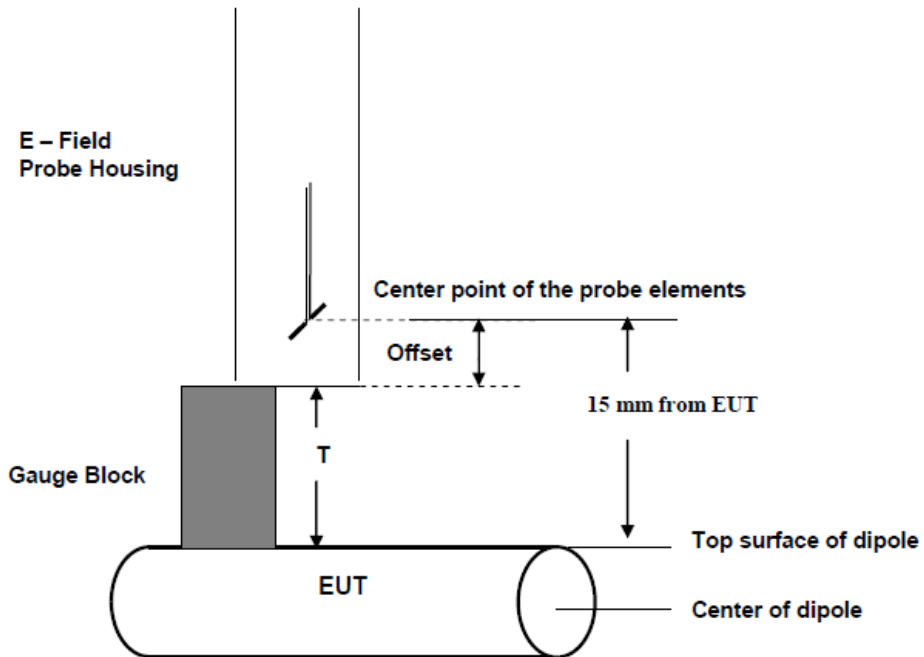

Fig. 8.3 Gauge block with E-field probe



8. Modulation Interference Factor

The HAC Standard ANSI C63.19-2011 defines a new scaling using the Modulation Interference Factor (MIF).

For any specific fixed and repeatable modulated signal, a modulation interference factor (MIF, expressed in dB) may be developed that relates its interference potential to its steady-state rms signal level or average power level. This factor is a function only of the audio-frequency amplitude modulation characteristics of the signal and is the same for field-strength and conducted power measurements. It is important to emphasize that the MIF is valid only for a specific repeatable audio-frequency amplitude modulation characteristic. Any change in modulation characteristic requires determination and application of a new MIF

The Modulation Interference factor (MIF, in dB) is added to the measured average E-field (in dBV/m) and converts it to the RF Audio Interference level (in dBV/m). This level considers the audible amplitude modulation components in the RF E-field. CW fields without amplitude modulation are assumed to not interfere with the hearing aid electronics. Modulations without time slots and low fluctuations at low frequencies have low MIF values, TDMA modulations with narrow transmission and repetition rates of few 100 Hz have high MIF values and give similar classifications as ANSI C63.19-2011.

ER3D, EF3D and EU2D E-field probes have a bandwidth <10 kHz and can therefore not evaluate the RF envelope in the full audio band. DASY52 is therefore using the indirect measurement method according to ANSI C63.19-2011 which is the primary method. These near field probes read the averaged E-field measurement. Especially for the new high peak-to-average (PAR) signal types, the probes shall be linearized by PMR calibration in order to not overestimate the field reading. Probe Modulation Response (PMR) calibration linearizes the probe response over its dynamic range for specific modulations which are characterized by their UID and result in an uncertainty specified in the probe calibration certificate. The MIF is characteristic for a given waveform envelope and can be used as a constant conversion factor if the probe has been PMR calibrated.

The evaluation method for the MIF is defined in ANSI C63.19-2011 section D.7. An RMS demodulated RF signal is fed to a spectral filter (similar to an A weighting filter) and forwarded to a temporal filter acting as a quasi-peak detector. The averaged output of these filtering is scaled to a 1 kHz 80% AM signal as reference. MIF measurement requires additional instrumentation and is not well suited for evaluation by the end user with reasonable uncertainty. It may alternatively be determined through analysis and simulation, because it is constant and characteristic for a communication signal. DASY52 uses well-defined signals for PMR calibration. The MIF of these signals has been determined by simulation and it is automatically applied.



MIF values applied in this test report were provided by the HAC equipment provider, SPEAG, and the values are listed below

| UID | Communication System Name | MIF(dB) |
|-------|---------------------------------------|---------|
| 10021 | GSM-FDD(TDMA,GMSK) | 3.63 |
| 10011 | UMTS-FDD(WCDMA) | -27.23 |
| 10100 | LTE-FDD(SC-FDMA,100%RB,20MHz,QPSK) | -23.48 |
| 10101 | LTE-FDD(SC-FDMA,100%RB,20MHz,16-QAM) | -17.86 |
| 10108 | LTE-FDD(SC-FDMA,100%RB,10MHz,QPSK) | -21.57 |
| 10109 | LTE-FDD(SC-FDMA,100%RB,10MHz,16-QAM) | -16.87 |
| 10110 | LTE-FDD(SC-FDMA,100%RB,5MHz,QPSK) | -23.39 |
| 10111 | LTE-FDD(SC-FDMA,100%RB,5MHz,16-QAM) | -16.35 |
| 10139 | LTE-FDD(SC-FDMA,100%RB,15MHz,QPSK) | -18.25 |
| 10140 | LTE-FDD(SC-FDMA,100%RB,15MHz,16-QAM) | -19.37 |
| 10142 | LTE-FDD(SC-FDMA,100%RB,3MHz,QPSK) | -22.36 |
| 10143 | LTE-FDD(SC-FDMA,100%RB,3MHz,16-QAM) | -14.75 |
| 10145 | LTE-FDD(SC-FDMA,100%RB,1.4MHz,QPSK) | -17.39 |
| 10146 | LTE-FDD(SC-FDMA,100%RB,1.4MHz,16-QAM) | -13.6 |
| 10148 | LTE-FDD(SC-FDMA,50%RB,20MHz,QPSK) | -18.28 |
| 10149 | LTE-FDD(SC-FDMA,50%RB,20MHz,16-QAM) | -16.87 |
| 10154 | LTE-FDD(SC-FDMA,50%RB,10MHz,QPSK) | -23.42 |
| 10155 | LTE-FDD(SC-FDMA,50%RB,10MHz,16-QAM) | -16.36 |
| 10156 | LTE-FDD(SC-FDMA,50%RB,5MHz,QPSK) | -21.71 |
| 10157 | LTE-FDD(SC-FDMA,50%RB,5MHz,16-QAM) | -15.78 |
| 10160 | LTE-FDD(SC-FDMA,50%RB,15MHz,QPSK) | -17.95 |
| 10161 | LTE-FDD(SC-FDMA,50%RB,15MHz,16-QAM) | -17.54 |
| 10163 | LTE-FDD(SC-FDMA,50%RB,3MHz,QPSK) | -19.99 |
| 10164 | LTE-FDD(SC-FDMA,50%RB,3MHz,16-QAM) | -14.41 |
| 10166 | LTE-FDD(SC-FDMA,50%RB,1.4MHz,QPSK) | -18.1 |
| 10167 | LTE-FDD(SC-FDMA,50%RB,1.4MHz,16-QAM) | -12.15 |
| 10169 | LTE-FDD(SC-FDMA,1RB,20MHz,QPSK) | -15.63 |
| 10170 | LTE-FDD(SC-FDMA,1RB,20MHz,16-QAM) | -9.76 |
| 10175 | LTE-FDD(SC-FDMA,1RB,10MHz,QPSK) | -15.63 |
| 10176 | LTE-FDD(SC-FDMA,1RB,10MHz,16-QAM) | -9.76 |
| 10177 | LTE-FDD(SC-FDMA,1RB,5MHz,QPSK) | -15.63 |
| 10178 | LTE-FDD(SC-FDMA,1RB,5MHz,16-QAM) | -9.76 |
| 10181 | LTE-FDD(SC-FDMA,1RB,15MHz,QPSK) | -15.63 |
| 10182 | LTE-FDD(SC-FDMA,1RB,15MHz,16-QAM) | -9.76 |
| 10184 | LTE-FDD(SC-FDMA,1RB,3MHz,QPSK) | -15.62 |
| 10185 | LTE-FDD(SC-FDMA,1RB,3MHz,16-QAM) | -9.76 |
| 10187 | LTE-FDD(SC-FDMA,1RB,1.4MHz,QPSK) | -15.62 |
| 10188 | LTE-FDD(SC-FDMA,1RB,1.4MHz,16-QAM) | -9.76 |

The MIF measurement uncertainty is estimated as follows, declared by HAC equipment provider SPEAG, for modulation frequencies from slotted waveforms with fundamental frequency and at least 2 harmonics within 10 kHz:

- i) 0.2 dB for MIF: -7 to +5 dB,
- ii) 0.5 dB for MIF: -13 to +11 dB
- iii) 1 dB for MIF: > -20 dB



9. Low-power Exemption

<Max Tune-up Limit>

| Mode | | Average Power (dBm) | |
|-------------|---------|---------------------|---------------|
| | | Full Power | Reduced Power |
| GSM | GSM850 | 32.50 | - |
| | GSM1900 | 30.00 | - |
| WCDMA | Band V | 24.00 | - |
| | Band IV | 23.50 | 21.00 |
| | Band II | 23.50 | 22.50 |
| LTE - FDD | Band 2 | 23.50 | 23.00 |
| | Band 4 | 23.50 | 22.00 |
| | Band 5 | 23.50 | - |
| | Band 12 | 23.50 | - |
| | Band 66 | 23.50 | 21.50 |
| 2.4GHz WLAN | | 16.50 | - |
| 5GHz WLAN | | 15.50 | - |



<Low Power Exemption>

| Air Interface | Max Average Antenna Input Power (dBm) | Worst Case MIF (dB) | Power + MIF(dB) | C63.19 test required |
|---------------|---------------------------------------|---------------------|-----------------|----------------------|
| GSM850 | 32.50 | 3.63 | 36.13 | Yes |
| GSM1900 | 30.00 | 3.63 | 33.63 | Yes |
| WCDMA Band V | 24.00 | -27.23 | -3.23 | No |
| WCDMA Band IV | 23.50 | -27.23 | -3.73 | No |
| WCDMA Band II | 23.50 | -27.23 | -3.73 | No |
| LTE - FDD | 23.50 | -9.76 | 13.74 | No |
| 2.4GHz WLAN | 16.50 | | | No |
| 5GHz WLAN | 15.50 | | | No |

General Note:

1. According to ANSI C63.19 2011-version, for WWAN RF air interface technology of a device is exempt from testing when its average antenna input power plus its MIF is ≤ 17 dBm for any of its operating modes.
2. For LTE operation the worst case MIF plus the worst case average antenna input power for all modes are investigated to determine the testing requirements for this device.
3. According to ANSI C63.19 2011, for WLAN RF emissions testing exemption shall be applied to an RF air interface technology in a device whose Peak antenna input power, averaged over intervals $\leq 50 \mu s$, is ≤ 23 dBm.
4. Chose the maximum power of all bands to calculate low power exemption.
5. HAC RF rating is M4 for the air interface which meets the low power exemption.



10. Conducted RF Output Power (Unit: dBm)

| Average Antenna Input Power(dBm) | | | | | | |
|----------------------------------|--------|-------|--------------|--------------|--------|--------|
| Air Interface | GSM850 | | | GSM1900 | | |
| Channel | 128 | 189 | 251 | 512 | 661 | 810 |
| Frequency (MHz) | 824.2 | 836.4 | 848.8 | 1850.2 | 1880.0 | 1909.8 |
| GSM (GMSK, 1 Tx slot) | 31.84 | 31.98 | 32.05 | 29.48 | 29.46 | 29.09 |



11. HAC RF Emission Test Results

| Plot No. | Air Interface | Operating Mode | Channel | Average Antenna Input Power (dBm) | MIF | RF audio interference level dB(V/m) | M-Rating |
|----------|---------------|----------------|---------|-----------------------------------|------|-------------------------------------|----------|
| 1 | GSM850 | GSM Voice | 128 | 31.84 | 3.63 | 34.85 | M4 |
| 2 | GSM850 | GSM Voice | 189 | 31.98 | 3.63 | 35.63 | M4 |
| 3 | GSM850 | GSM Voice | 251 | 32.05 | 3.63 | 36.16 | M4 |
| 4 | GSM1900 | GSM Voice | 512 | 29.48 | 3.63 | 32.89 | M3 |
| 5 | GSM1900 | GSM Voice | 661 | 29.46 | 3.63 | 32.76 | M3 |
| 6 | GSM1900 | GSM Voice | 810 | 29.09 | 3.63 | 33.01 | M3 |

Remark:

1. The HAC measurement system applies MIF value onto the measured RMS E-field, which is indirect method in ANSI C63.19 2011 version, and reports the RF audio interference level.
2. The uncertainty is 0.2dB of MIF ranges from -7dB to +5dB.GSM850 with rating M4 and GSM1900 with rating M3 would not be affected considering the MIF uncertainty.
3. There is special HAC mode software on this EUT.

Test Engineer : Weilong Chen



12. Uncertainty Assessment

The component of uncertainty may generally be categorized according to the methods used to evaluate them. The evaluation of uncertainty by the statistical analysis of a series of observations is termed a Type A evaluation of uncertainty. The evaluation of uncertainty by means other than the statistical analysis of a series of observation is termed a Type B evaluation of uncertainty. Each component of uncertainty, however evaluated, is represented by an estimated standard deviation, termed standard uncertainty, which is determined by the positive square root of the estimated variance.

The combined standard uncertainty of the measurement result represents the estimated standard deviation of the result. It is obtained by combining the individual standard uncertainties of both Type A and Type B evaluation using the usual “root-sum-squares” (RSS) methods of combining standard deviations by taking the positive square root of the estimated variances. Expanded uncertainty is a measure of uncertainty that defines an interval about the measurement result within which the measured value is confidently believed to lie. It is obtained by multiplying the combined standard uncertainty by a coverage factor. For purpose of this document, a coverage factor two is used, which corresponds to confidence interval of about 95 %. The DASY uncertainty Budget is showed in Table 12.1.



| Error Description | Uncertainty Value (±%) | Probability Distribution | Divisor | Ci (E) | Standard Uncertainty (E) |
|---|------------------------|--------------------------|---------|--------|--------------------------|
| Measurement System | | | | | |
| Probe Calibration | 5.1 | Normal | 1 | 1 | ± 5.1 % |
| Axial Isotropy | 4.7 | Rectangular | √3 | 1 | ± 2.7 % |
| Sensor Displacement | 16.5 | Rectangular | √3 | 1 | ± 9.5 % |
| Boundary Effects | 2.4 | Rectangular | √3 | 1 | ± 1.4 % |
| Phantom Boundary Effects | 7.2 | Rectangular | √3 | 1 | ± 4.1 % |
| Linearity | 4.7 | Rectangular | √3 | 1 | ± 2.7 % |
| Scaling with PMR Calibration | 10.0 | Rectangular | √3 | 1 | ± 5.77 % |
| System Detection Limit | 1.0 | Rectangular | √3 | 1 | ± 0.6 % |
| Readout Electronics | 0.3 | Normal | 1 | 1 | ± 0.3 % |
| Response Time | 0.8 | Rectangular | √3 | 1 | ± 0.5 % |
| Integration Time | 2.6 | Rectangular | √3 | 1 | ± 1.5 % |
| RF Ambient Conditions | 3.0 | Rectangular | √3 | 1 | ± 1.7 % |
| RF Reflections | 12.0 | Rectangular | √3 | 1 | ± 6.9 % |
| Probe Positioner | 1.2 | Rectangular | √3 | 1 | ± 0.7 % |
| Probe Positioning | 4.7 | Rectangular | √3 | 1 | ± 2.7 % |
| Extrap. and Interpolation | 1.0 | Rectangular | √3 | 1 | ± 0.6 % |
| Test Sample Related | | | | | |
| Device Positioning Vertical | 4.7 | Rectangular | √3 | 1 | ± 2.7 % |
| Device Positioning Lateral | 1.0 | Rectangular | √3 | 1 | ± 0.6 % |
| Device Holder and Phantom | 2.4 | Rectangular | √3 | 1 | ± 1.4 % |
| Power Drift | 5.0 | Rectangular | √3 | 1 | ± 2.9 % |
| Phantom and Setup Related | | | | | |
| Phantom Thickness | 2.4 | Rectangular | √3 | 1 | ± 1.4 % |
| Combined Standard Uncertainty | | | | | ± 16.30 % |
| Coverage Factor for 95 % | | | | | K = 2 |
| Expanded Std. Uncertainty on Power | | | | | ± 32.6 % |
| Expanded Std. Uncertainty on Field | | | | | ± 16.3 % |

Table 12.1 Uncertainty Budget of HAC free field assessment

Remark:

Worst-Case uncertainty budget for HAC free field assessment according to ANSIC63.19 [1], [2]. The budget is valid for the frequency range 700 MHz - 3 GHz and represents a worst case analysis.



13. References

- [1] ANSI C63.19-2011, "American National Standard for Methods of Measurement of Compatibility between Wireless Communications Devices and Hearing Aids", 27 May 2011.
- [2] FCC KDB 285076 D01v04r01, "Equipment Authorization Guidance for Hearing Aid Compatibility", Apr 2016
- [3] FCC KDB 285076 D02v02, "Guidance for Performing T-Coil tests for Air Interfaces Supporting Voice over IP", Apr 2016
- [4] SPEAG DASY System Handbook



Appendix A. Plots of System Performance Check

The plots are shown as follows.

HAC_E_Dipole_835_170701

DUT: CD835V3-SN:1184

Communication System: UID 0, CW; Frequency: 835 MHz; Duty Cycle: 1:1

Medium: Air Medium parameters used: $\sigma = 0$ S/m, $\epsilon_r = 1$; $\rho = 0$ kg/m³

Ambient Temperature: 23.4 °C

DASY5 Configuration:

- Probe: ER3DV6 - SN2528; ConvF(1, 1, 1); Calibrated: 2017.01.25;
- Sensor-Surface: (Fix Surface)
- Electronics: DAE4 Sn1303; Calibrated: 2016.11.22
- Phantom: HAC Test Arch with AMCC; Type: SD HAC P01 BA;
- Measurement SW: DASY52, Version 52.8 (8); SEMCAD X Version 14.6.10 (7331)

E Scan - measurement distance from the probe sensor center to CD835 =15mm/Hearing Aid Compatibility Test at 15mm distance (41x361x1): Interpolated

grid: dx=0.5000 mm, dy=0.5000 mm

Device Reference Point: 0, 0, -6.3 mm

Reference Value = 113.3 V/m; Power Drift = -0.01 dB

E-field emissions = 114.9 V/m

Average value of Total=(113.9+113.8)/2=113.85 V/m

MIF scaled E-field

| | | |
|--------------------------------------|--------------------------------------|--------------------------------------|
| Grid 1 M4 114.1 V/m | Grid 2 M4 113.9 V/m | Grid 3 M4 113.2 V/m |
| Grid 4 M4 68.58 V/m | Grid 5 M4 69.53 V/m | Grid 6 M4 67.73 V/m |
| Grid 7 M4 113.3 V/m | Grid 8 M4 113.8 V/m | Grid 9 M4 112.3 V/m |

Cursor:

Total = 115.1 V/m

E Category: M4

Location: 0.5, -69.5, 9.7 mm

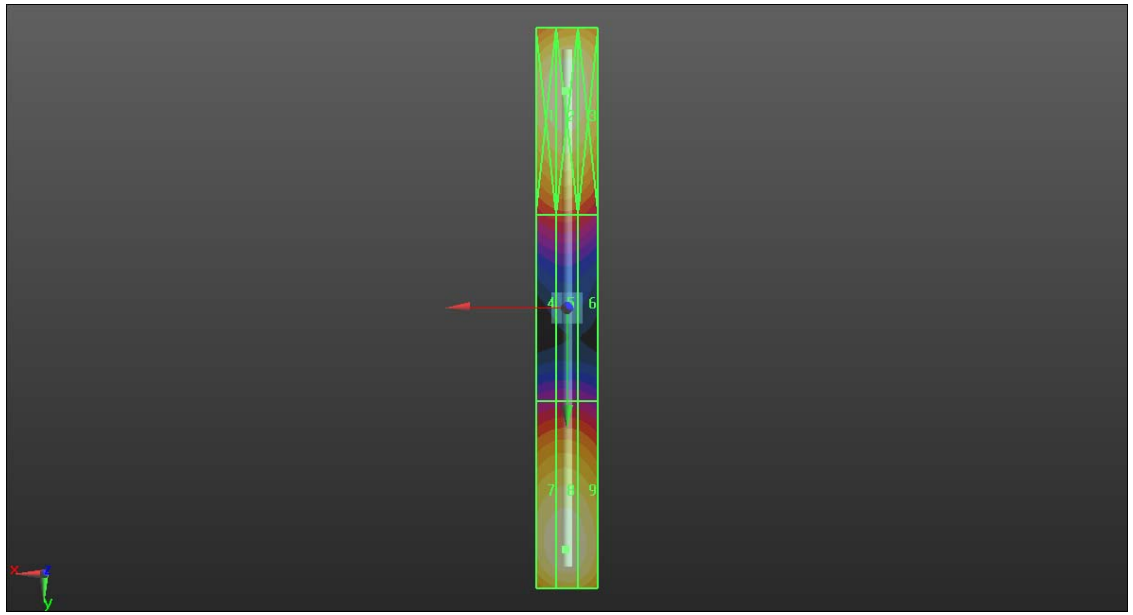
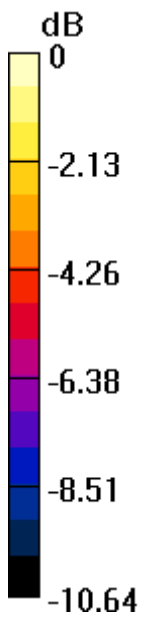

0 dB = 115.9 V/m = 41.28 dBV/m

HAC_E_Dipole_1880_170701

DUT: CD1880V3-SN:1170

Communication System: UID 0, CW; Frequency: 1880 MHz; Duty Cycle: 1:1

Medium: Air Medium parameters used: $\sigma = 0$ S/m, $\epsilon_r = 1$; $\rho = 0$ kg/m³

Ambient Temperature: 23.4 °C

DASY5 Configuration:

- Probe: ER3DV6 - SN2528; ConvF(1, 1, 1); Calibrated: 2017.01.25;
- Sensor-Surface: (Fix Surface)
- Electronics: DAE4 Sn1303; Calibrated: 2016.11.22
- Phantom: HAC Test Arch with AMCC; Type: SD HAC P01 BA;
- Measurement SW: DASY52, Version 52.8 (8); SEMCAD X Version 14.6.10 (7331)

E Scan - measurement distance from the probe sensor center to CD1880 =15mm/Hearing Aid Compatibility Test at 15mm distance (41x181x1): Interpolated

grid: dx=0.5000 mm, dy=0.5000 mm

Device Reference Point: 0, 0, -6.3 mm

Reference Value = 166.9 V/m; Power Drift = 0.00 dB

E-field emissions = 96.62 V/m

Average value of Total=(93.2+96.5)/2=94.85 V/m

MIF scaled E-field

| | | |
|--------------------------------------|--------------------------------------|--------------------------------------|
| Grid 1 M3 95.33 V/m | Grid 2 M3 93.2 V/m | Grid 3 M3 101.1 V/m |
| Grid 4 M3 75.46 V/m | Grid 5 M3 79.61 V/m | Grid 6 M3 79.64 V/m |
| Grid 7 M3 92.47 V/m | Grid 8 M3 96.5 V/m | Grid 9 M3 97.53 V/m |

Cursor:

Total = 101.0 V/m

E Category: M3

Location: -3.5, -30.5, 9.7 mm

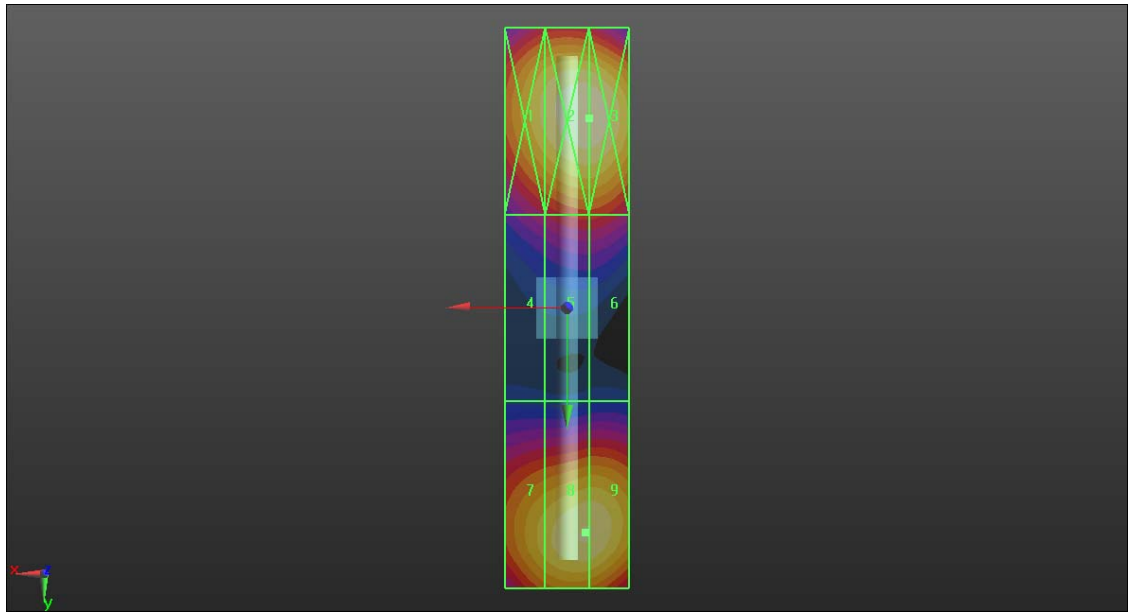
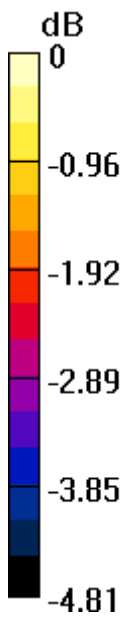

0 dB = 101.0 V/m = 40.09 dBV/m



Appendix B. Plots of RF Emission Measurement

The plots are shown as follows.

01_HAC RF_GSM850_GSM Voice_Ch128_E

Communication System: UID 10021 - DAB, GSM-FDD (TDMA, GMSK); Frequency: 824.2 MHz; Duty Cycle: 1:8.3

Medium: Air Medium parameters used: $\sigma = 0$ S/m, $\epsilon_r = 1$; $\rho = 0$ kg/m³

Ambient Temperature : 23.4 °C

DASY5 Configuration:

- Probe: ER3DV6 - SN2528; ConvF(1, 1, 1); Calibrated: 2017.01.25;
- Sensor-Surface: (Fix Surface)
- Electronics: DAE4 Sn1303; Calibrated: 2016.11.22
- Phantom: HAC Test Arch with AMCC; Type: SD HAC P01 BA;
- Measurement SW: DASY52, Version 52.8 (8); SEMCAD X Version 14.6.10 (7331)

Ch128/Hearing Aid Compatibility Test (101x101x1): Interpolated grid: dx=0.5000 mm, dy=0.5000 mm

Device Reference Point: 0, 0, -6.3 mm

Reference Value = 46.08 V/m; Power Drift = 0.05 dB

Applied MIF = 3.63 dB

RF audio interference level = 34.85 dBV/m

Emission category: M4

MIF scaled E-field

| | | |
|--|--|--|
| Grid 1 M4 33.91 dBV/m | Grid 2 M4 34.63 dBV/m | Grid 3 M4 34.33 dBV/m |
| Grid 4 M4 34.05 dBV/m | Grid 5 M4 34.85 dBV/m | Grid 6 M4 34.6 dBV/m |
| Grid 7 M4 33.86 dBV/m | Grid 8 M4 34.75 dBV/m | Grid 9 M4 34.55 dBV/m |

Cursor:

Total = 34.85 dBV/m

E Category: M4

Location: -3, 1.5, 8.7 mm

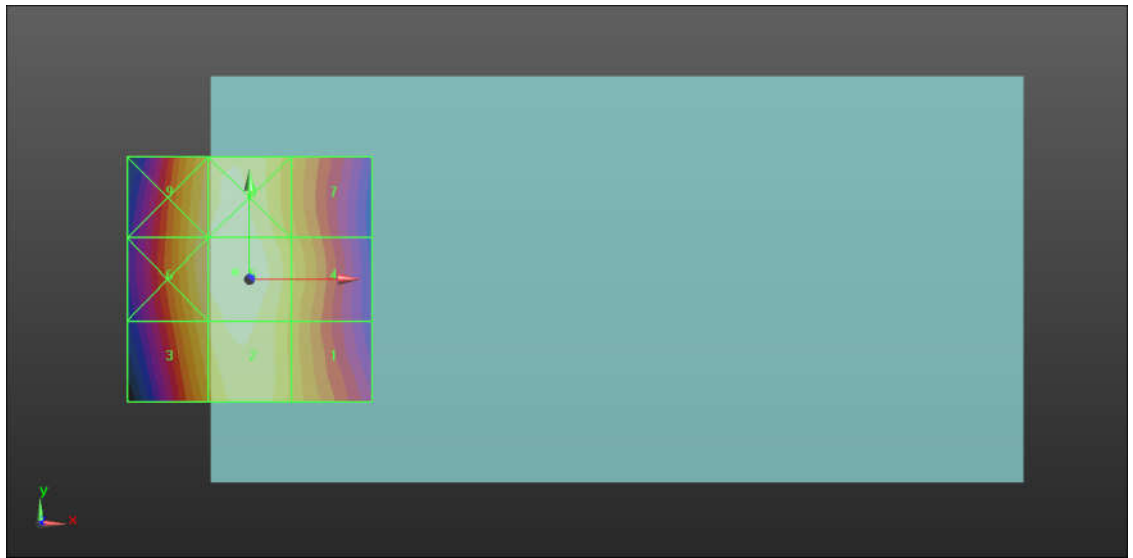
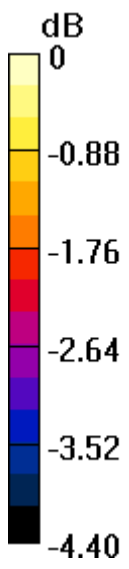

0 dB = 55.24 V/m = 34.85 dBV/m

02_HAC RF_GSM850_GSM Voice_Ch189_E

Communication System: UID 10021 - DAB, GSM-FDD (TDMA, GMSK); Frequency: 836.4 MHz; Duty Cycle: 1:8.3

Medium: Air Medium parameters used: $\sigma = 0$ S/m, $\epsilon_r = 1$; $\rho = 0$ kg/m³

Ambient Temperature : 23.4 °C

DASY5 Configuration:

- Probe: ER3DV6 - SN2528; ConvF(1, 1, 1); Calibrated: 2017.01.25;
- Sensor-Surface: (Fix Surface)
- Electronics: DAE4 Sn1303; Calibrated: 2016.11.22
- Phantom: HAC Test Arch with AMCC; Type: SD HAC P01 BA;
- Measurement SW: DASY52, Version 52.8 (8); SEMCAD X Version 14.6.10 (7331)

Ch189/Hearing Aid Compatibility Test (101x101x1): Interpolated grid: dx=0.5000 mm, dy=0.5000 mm

Device Reference Point: 0, 0, -6.3 mm

Reference Value = 50.17 V/m; Power Drift = 0.05 dB

Applied MIF = 3.63 dB

RF audio interference level = 35.63 dBV/m

Emission category: M4

MIF scaled E-field

| | | |
|--|--|--|
| Grid 1 M4 34.59 dBV/m | Grid 2 M4 35.41 dBV/m | Grid 3 M4 35.15 dBV/m |
| Grid 4 M4 34.73 dBV/m | Grid 5 M4 35.63 dBV/m | Grid 6 M4 35.42 dBV/m |
| Grid 7 M4 34.54 dBV/m | Grid 8 M4 35.53 dBV/m | Grid 9 M4 35.34 dBV/m |

Cursor:

Total = 35.63 dBV/m

E Category: M4

Location: -3.5, 2, 8.7 mm

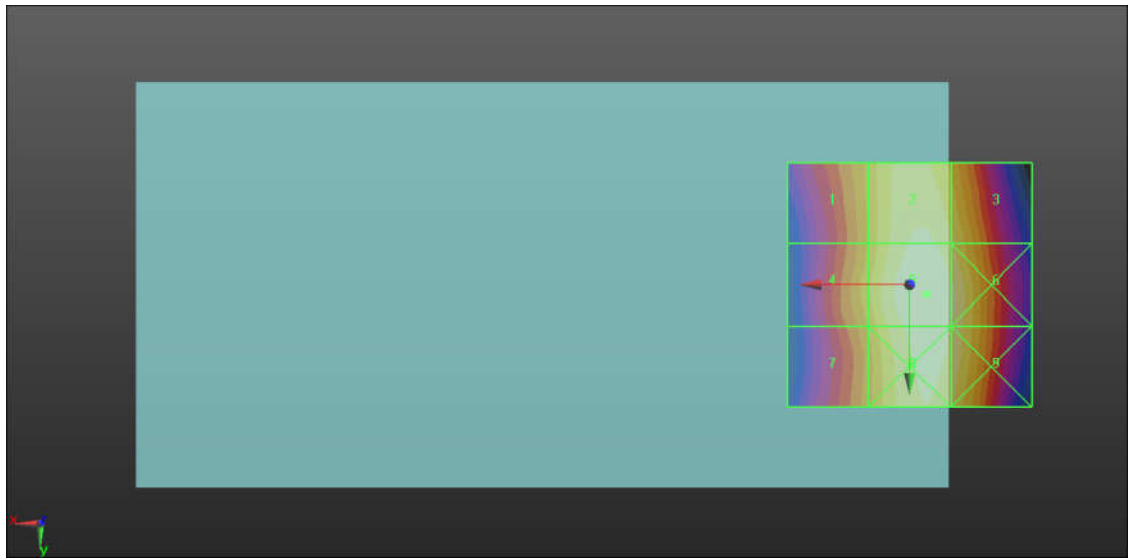
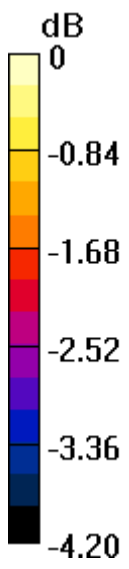

0 dB = 60.44 V/m = 35.63 dBV/m

03_HAC RF_GSM850_GSM Voice_Ch251_E

Communication System: UID 10021 - DAB, GSM-FDD (TDMA, GMSK); Frequency: 848.8 MHz; Duty Cycle: 1:8.3

Medium: Air Medium parameters used: $\sigma = 0$ S/m, $\epsilon_r = 1$; $\rho = 0$ kg/m³

Ambient Temperature : 23.4 °C

DASY5 Configuration:

- Probe: ER3DV6 - SN2528; ConvF(1, 1, 1); Calibrated: 2017.01.25;
- Sensor-Surface: (Fix Surface)
- Electronics: DAE4 Sn1303; Calibrated: 2016.11.22
- Phantom: HAC Test Arch with AMCC; Type: SD HAC P01 BA;
- Measurement SW: DASY52, Version 52.8 (8); SEMCAD X Version 14.6.10 (7331)

Ch251/Hearing Aid Compatibility Test (101x101x1): Interpolated grid: dx=0.5000 mm, dy=0.5000 mm

Device Reference Point: 0, 0, -6.3 mm

Reference Value = 53.64 V/m; Power Drift = 0.00 dB

Applied MIF = 3.63 dB

RF audio interference level = 36.16 dBV/m

Emission category: M4

MIF scaled E-field

| | | |
|--|--|--|
| Grid 1 M4 35.24 dBV/m | Grid 2 M4 35.98 dBV/m | Grid 3 M4 35.73 dBV/m |
| Grid 4 M4 35.25 dBV/m | Grid 5 M4 36.16 dBV/m | Grid 6 M4 35.96 dBV/m |
| Grid 7 M4 35.03 dBV/m | Grid 8 M4 36.04 dBV/m | Grid 9 M4 35.87 dBV/m |

Cursor:

Total = 36.16 dBV/m

E Category: M4

Location: -3.5, 0.5, 8.7 mm

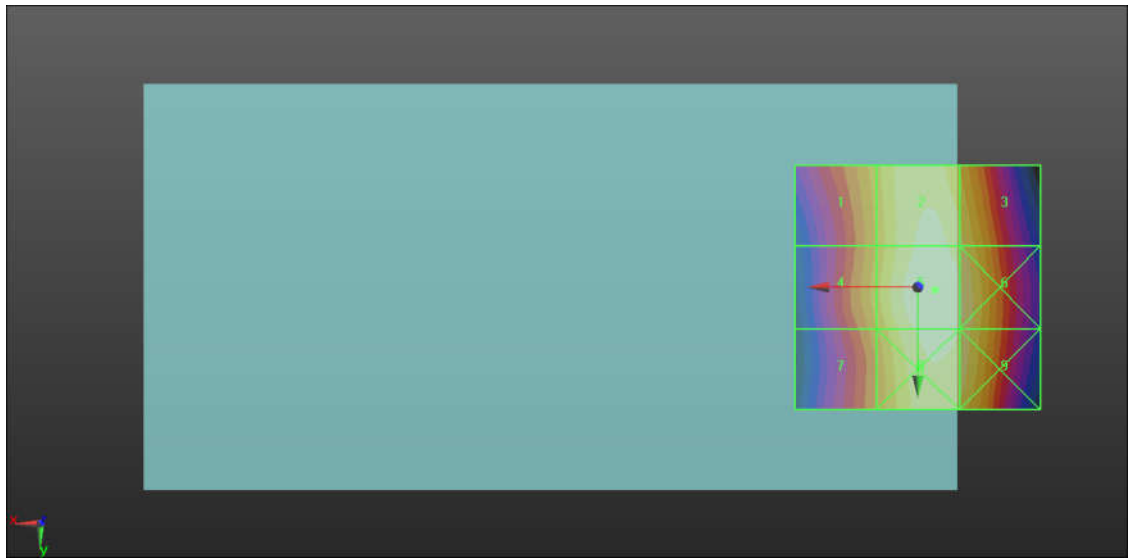
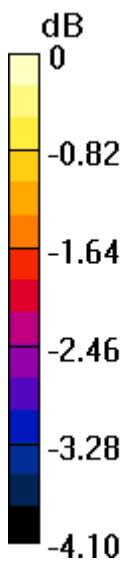

0 dB = 64.25 V/m = 36.16 dBV/m

04_HAC RF_GSM1900_GSM Voice_Ch512_E

Communication System: UID 10021 - DAB, GSM-FDD (TDMA, GMSK); Frequency: 1850.2 MHz; Duty Cycle: 1:8.3

Medium: Air Medium parameters used: $\sigma = 0$ S/m, $\epsilon_r = 1$; $\rho = 0$ kg/m³

Ambient Temperature : 23.4 °C

DASY5 Configuration:

- Probe: ER3DV6 - SN2528; ConvF(1, 1, 1); Calibrated: 2017.01.25;
- Sensor-Surface: (Fix Surface)
- Electronics: DAE4 Sn1303; Calibrated: 2016.11.22
- Phantom: HAC Test Arch with AMCC; Type: SD HAC P01 BA;
- Measurement SW: DASY52, Version 52.8 (8); SEMCAD X Version 14.6.10 (7331)

Ch512/Hearing Aid Compatibility Test (101x101x1): Interpolated grid: dx=0.5000 mm, dy=0.5000 mm

Device Reference Point: 0, 0, -6.3 mm

Reference Value = 31.37 V/m; Power Drift = -0.00 dB

Applied MIF = 3.63 dB

RF audio interference level = 32.89 dBV/m

Emission category: M3

MIF scaled E-field

| | | |
|--|--|--|
| Grid 1 M4 27.22 dBV/m | Grid 2 M3 31.99 dBV/m | Grid 3 M3 32.03 dBV/m |
| Grid 4 M4 29.12 dBV/m | Grid 5 M3 32.89 dBV/m | Grid 6 M3 32.89 dBV/m |
| Grid 7 M3 30.16 dBV/m | Grid 8 M3 32.89 dBV/m | Grid 9 M3 32.89 dBV/m |

Cursor:

Total = 32.89 dBV/m

E Category: M3

Location: -8.5, 8, 8.7 mm

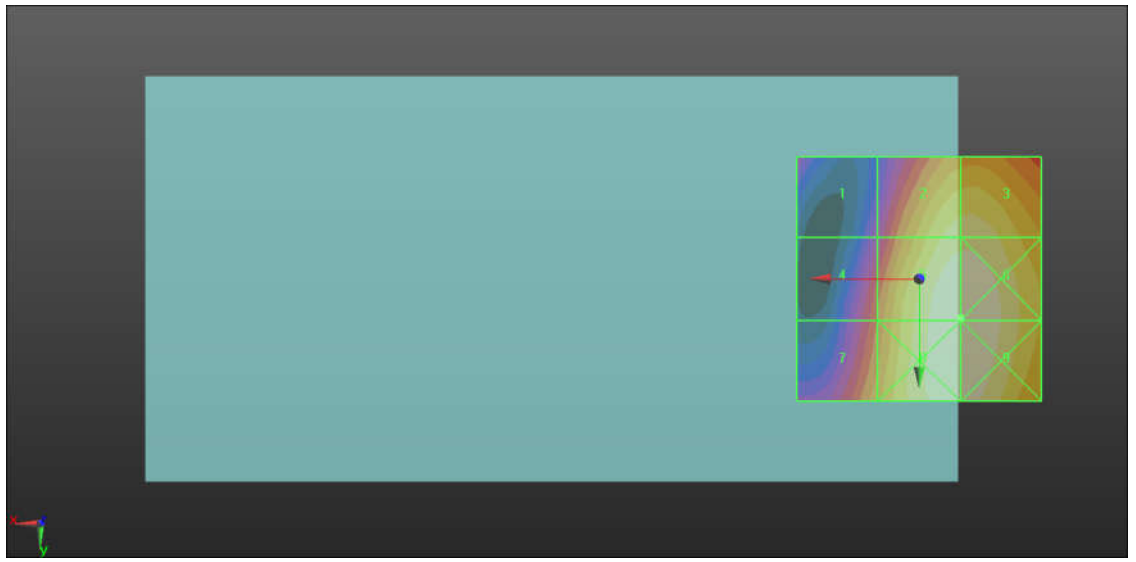
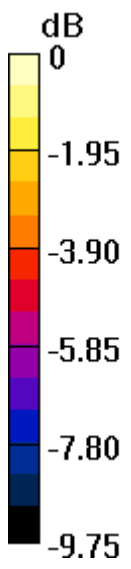

0 dB = 44.13 V/m = 32.89 dBV/m

05_HAC RF_GSM1900_GSM Voice_Ch661_E

Communication System: UID 10021 - DAB, GSM-FDD (TDMA, GMSK); Frequency: 1880 MHz; Duty Cycle: 1:8.3

Medium: Air Medium parameters used: $\sigma = 0$ S/m, $\epsilon_r = 1$; $\rho = 0$ kg/m³

Ambient Temperature : 23.4 °C

DASY5 Configuration:

- Probe: ER3DV6 - SN2528; ConvF(1, 1, 1); Calibrated: 2017.01.25;
- Sensor-Surface: (Fix Surface)
- Electronics: DAE4 Sn1303; Calibrated: 2016.11.22
- Phantom: HAC Test Arch with AMCC; Type: SD HAC P01 BA;
- Measurement SW: DASY52, Version 52.8 (8); SEMCAD X Version 14.6.10 (7331)

Ch661/Hearing Aid Compatibility Test (101x101x1): Interpolated grid: dx=0.5000 mm, dy=0.5000 mm

Device Reference Point: 0, 0, -6.3 mm

Reference Value = 30.68 V/m; Power Drift = -0.10 dB

Applied MIF = 3.63 dB

RF audio interference level = 32.76 dBV/m

Emission category: M3

MIF scaled E-field

| | | |
|--|--|--|
| Grid 1 M4 27.66 dBV/m | Grid 2 M3 31.96 dBV/m | Grid 3 M3 32.02 dBV/m |
| Grid 4 M4 28.47 dBV/m | Grid 5 M3 32.76 dBV/m | Grid 6 M3 32.77 dBV/m |
| Grid 7 M4 29.17 dBV/m | Grid 8 M3 32.75 dBV/m | Grid 9 M3 32.76 dBV/m |

Cursor:

Total = 32.77 dBV/m

E Category: M3

Location: -9.5, 7, 8.7 mm

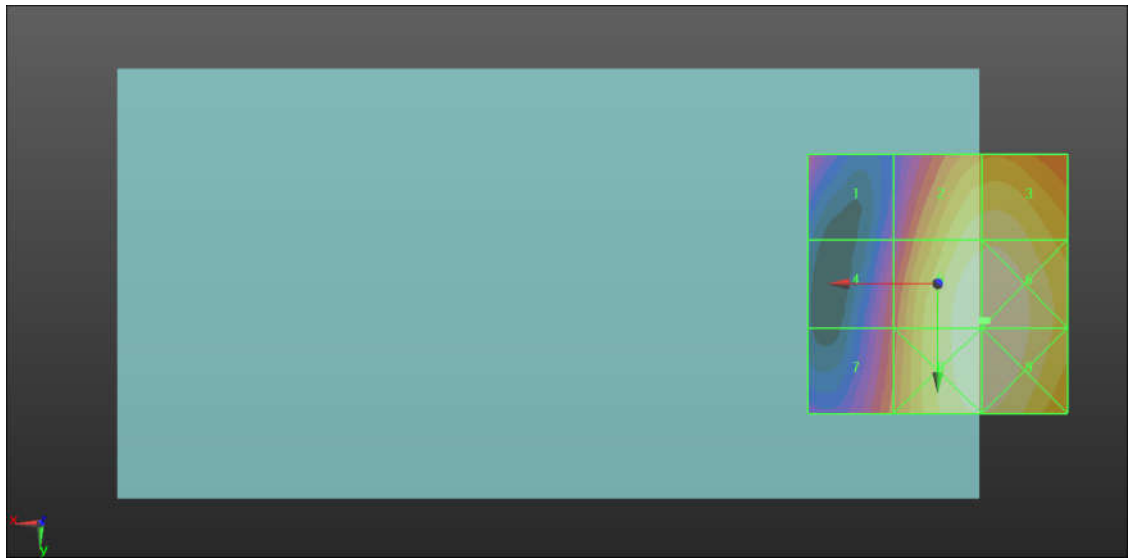
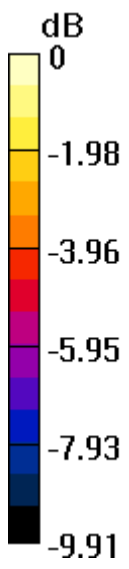

0 dB = 43.50 V/m = 32.77 dBV/m

06_HAC RF_GSM1900_GSM Voice_Ch810_E

Communication System: UID 10021 - DAB, GSM-FDD (TDMA, GMSK); Frequency: 1909.8 MHz; Duty Cycle: 1:8.3

Medium: Air Medium parameters used: $\sigma = 0$ S/m, $\epsilon_r = 1$; $\rho = 0$ kg/m³

Ambient Temperature : 23.4 °C

DASY5 Configuration:

- Probe: ER3DV6 - SN2528; ConvF(1, 1, 1); Calibrated: 2017.01.25;
- Sensor-Surface: (Fix Surface)
- Electronics: DAE4 Sn1303; Calibrated: 2016.11.22
- Phantom: HAC Test Arch with AMCC; Type: SD HAC P01 BA;
- Measurement SW: DASY52, Version 52.8 (8); SEMCAD X Version 14.6.10 (7331)

Ch810/Hearing Aid Compatibility Test (101x101x1): Interpolated grid: dx=0.5000 mm, dy=0.5000 mm

Device Reference Point: 0, 0, -6.3 mm

Reference Value = 31.43 V/m; Power Drift = 0.03 dB

Applied MIF = 3.63 dB

RF audio interference level = 33.01 dBV/m

Emission category: M3

MIF scaled E-field

| | | |
|--|--|--|
| Grid 1 M4 28.37 dBV/m | Grid 2 M3 32.27 dBV/m | Grid 3 M3 32.33 dBV/m |
| Grid 4 M4 28.61 dBV/m | Grid 5 M3 33.01 dBV/m | Grid 6 M3 33.01 dBV/m |
| Grid 7 M4 29.45 dBV/m | Grid 8 M3 33 dBV/m | Grid 9 M3 33 dBV/m |

Cursor:

Total = 33.01 dBV/m

E Category: M3

Location: -9.5, 7, 8.7 mm

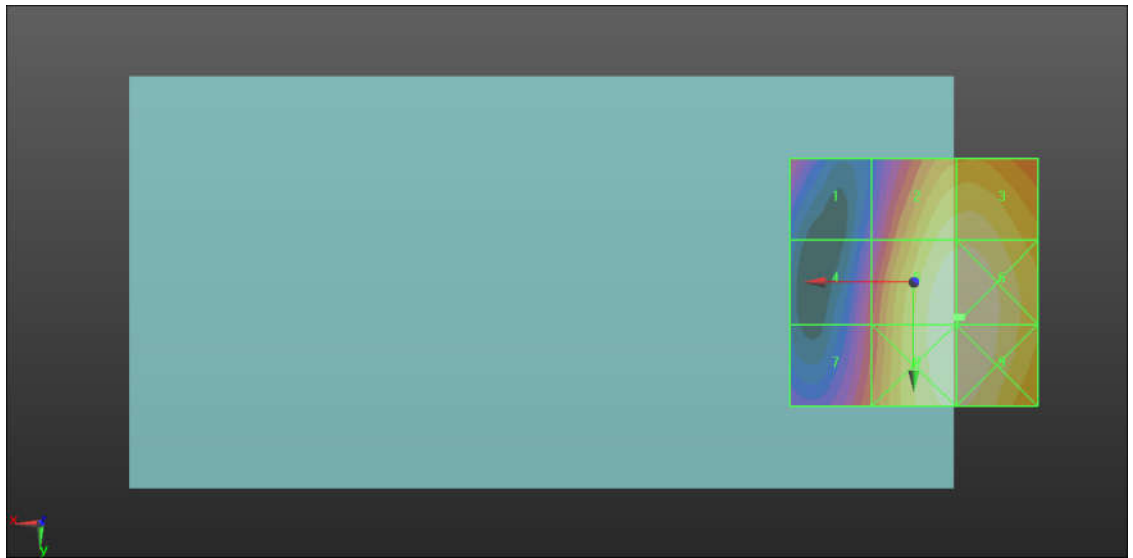
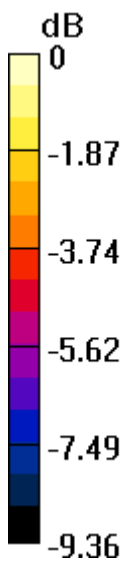

0 dB = 44.74 V/m = 33.01 dBV/m



Appendix C. DASY Calibration Certificate

The DASY calibration certificates are shown as follows.



Accredited by the Swiss Accreditation Service (SAS)
The Swiss Accreditation Service is one of the signatories to the EA
Multilateral Agreement for the recognition of calibration certificates

Accreditation No.: **SCS 0108**

Client **Sporton (Auden)**

Certificate No: **CD835V3-1184_May17**

CALIBRATION CERTIFICATE

Object **CD835V3 - SN: 1184**

Calibration procedure(s) **QA CAL-20.v6
Calibration procedure for dipoles in air**

Calibration date: **May 22, 2017**

This calibration certificate documents the traceability to national standards, which realize the physical units of measurements (SI).
The measurements and the uncertainties with confidence probability are given on the following pages and are part of the certificate.

All calibrations have been conducted in the closed laboratory facility: environment temperature (22 ± 3)°C and humidity < 70%.

Calibration Equipment used (M&TE critical for calibration)

| Primary Standards | ID # | Cal Date (Certificate No.) | Scheduled Calibration |
|-----------------------------|--------------------|---------------------------------|-----------------------|
| Power meter NRP | SN: 104778 | 04-Apr-17 (No. 217-02521/02522) | Apr-18 |
| Power sensor NRP-Z91 | SN: 103244 | 04-Apr-17 (No. 217-02521) | Apr-18 |
| Power sensor NRP-Z91 | SN: 103245 | 04-Apr-17 (No. 217-02522) | Apr-18 |
| Reference 20 dB Attenuator | SN: 5058 (20k) | 07-Apr-17 (No. 217-02528) | Apr-18 |
| Type-N mismatch combination | SN: 5047.2 / 06327 | 07-Apr-17 (No. 217-02529) | Apr-18 |
| Probe ER3DV6 | SN: 2336 | 30-Dec-16 (No. ER3-2336_Dec16) | Dec-17 |
| Probe H3DV6 | SN: 6065 | 30-Dec-16 (No. H3-6065_Dec16) | Dec-17 |
| DAE4 | SN: 781 | 02-Sep-16 (No. DAE4-781_Sep16) | Sep-17 |

| Secondary Standards | ID # | Check Date (in house) | Scheduled Check |
|---------------------------|----------------|-----------------------------------|------------------------|
| Power meter Agilent 4419B | SN: GB42420191 | 09-Oct-09 (in house check Sep-14) | In house check: Oct-17 |
| Power sensor HP E4412A | SN: US38485102 | 05-Jan-10 (in house check Sep-14) | In house check: Oct-17 |
| Power sensor HP 8482A | SN: US37295597 | 09-Oct-09 (in house check Sep-14) | In house check: Oct-17 |
| RF generator R&S SMT-06 | SN: 832283/011 | 27-Aug-12 (in house check Oct-15) | In house check: Oct-17 |
| Network Analyzer HP 8753E | SN: US37390585 | 18-Oct-01 (in house check Oct-16) | In house check: Oct-17 |

| | Name | Function | Signature |
|----------------|------------------|-----------------------|-----------|
| Calibrated by: | Johannes Kurikka | Laboratory Technician | |
| Approved by: | Katja Pokovic | Technical Manager | |

Issued: May 25, 2017

This calibration certificate shall not be reproduced except in full without written approval of the laboratory.



Accredited by the Swiss Accreditation Service (SAS)

The Swiss Accreditation Service is one of the signatories to the EA
Multilateral Agreement for the recognition of calibration certificates

Accreditation No.: **SCS 0108**

References

- [1] ANSI-C63.19-2011
American National Standard, Methods of Measurement of Compatibility between Wireless Communications Devices and Hearing Aids.

Methods Applied and Interpretation of Parameters:

- *Coordinate System:* y-axis is in the direction of the dipole arms. z-axis is from the basis of the antenna (mounted on the table) towards its feed point between the two dipole arms. x-axis is normal to the other axes. In coincidence with the standards [1], the measurement planes (probe sensor center) are selected to be at a distance of 15 mm above the top metal edge of the dipole arms.
- *Measurement Conditions:* Further details are available from the hardcopies at the end of the certificate. All figures stated in the certificate are valid at the frequency indicated. The forward power to the dipole connector is set with a calibrated power meter connected and monitored with an auxiliary power meter connected to a directional coupler. While the dipole under test is connected, the forward power is adjusted to the same level.
- *Antenna Positioning:* The dipole is mounted on a HAC Test Arch phantom using the matching dipole positioner with the arms horizontal and the feeding cable coming from the floor. The measurements are performed in a shielded room with absorbers around the setup to reduce the reflections. It is verified before the mounting of the dipole under the Test Arch phantom, that its arms are perfectly in a line. It is installed on the HAC dipole positioner with its arms parallel below the dielectric reference wire and able to move elastically in vertical direction without changing its relative position to the top center of the Test Arch phantom. The vertical distance to the probe is adjusted after dipole mounting with a DASY5 Surface Check job. Before the measurement, the distance between phantom surface and probe tip is verified. The proper measurement distance is selected by choosing the matching section of the HAC Test Arch phantom with the proper device reference point (upper surface of the dipole) and the matching grid reference point (tip of the probe) considering the probe sensor offset. The vertical distance to the probe is essential for the accuracy.
- *Feed Point Impedance and Return Loss:* These parameters are measured using a HP 8753E Vector Network Analyzer. The impedance is specified at the SMA connector of the dipole. The influence of reflections was eliminated by applying the averaging function while moving the dipole in the air, at least 70cm away from any obstacles.
- *E-field distribution:* E field is measured in the x-y-plane with an isotropic ER3D-field probe with 100 mW forward power to the antenna feed point. In accordance with [1], the scan area is 20mm wide, its length exceeds the dipole arm length (180 or 90mm). The sensor center is 15 mm (in z) above the metal top of the dipole arms. Two 3D maxima are available near the end of the dipole arms. Assuming the dipole arms are perfectly in one line, the average of these two maxima (in subgrid 2 and subgrid 8) is determined to compensate for any non-parallelity to the measurement plane as well as the sensor displacement. The E-field value stated as calibration value represents the maximum of the interpolated 3D-E-field, in the plane above the dipole surface.

The reported uncertainty of measurement is stated as the standard uncertainty of measurement multiplied by the coverage factor $k=2$, which for a normal distribution corresponds to a coverage probability of approximately 95%.

Measurement Conditions

DASY system configuration, as far as not given on page 1.

| | | |
|---|---------------------|----------|
| DASY Version | DASY5 | V52.10.0 |
| Phantom | HAC Test Arch | |
| Distance Dipole Top - Probe Center | 15 mm | |
| Scan resolution | dx, dy = 5 mm | |
| Frequency | 835 MHz \pm 1 MHz | |
| Input power drift | < 0.05 dB | |

Maximum Field values at 835 MHz

| E-field 15 mm above dipole surface | condition | Interpolated maximum |
|---|--------------------|--|
| Maximum measured above high end | 100 mW input power | 109.2 V/m = 40.76 dBV/m |
| Maximum measured above low end | 100 mW input power | 109.1 V/m = 40.76 dBV/m |
| Averaged maximum above arm | 100 mW input power | 109.2 V/m \pm 12.8 % (k=2) |

Appendix (Additional assessments outside the scope of SCS 0108)

Antenna Parameters

| Frequency | Return Loss | Impedance |
|------------------|--------------------|---------------------------------|
| 800 MHz | 17.4 dB | 40.5 Ω - 7.8 j Ω |
| 835 MHz | 25.5 dB | 50.7 Ω + 5.3 j Ω |
| 900 MHz | 17.3 dB | 50.8 Ω - 13.8 j Ω |
| 950 MHz | 21.0 dB | 51.0 Ω + 9.0 j Ω |
| 960 MHz | 15.6 dB | 62.6 Ω + 14.1 j Ω |

3.2 Antenna Design and Handling

The calibration dipole has a symmetric geometry with a built-in two stub matching network, which leads to the enhanced bandwidth.

The dipole is built of standard semirigid coaxial cable. The internal matching line is open ended. The antenna is therefore open for DC signals.

Do not apply force to dipole arms, as they are liable to bend. The soldered connections near the feedpoint may be damaged. After excessive mechanical stress or overheating, check the impedance characteristics to ensure that the internal matching network is not affected.

After long term use with 40W radiated power, only a slight warming of the dipole near the feedpoint can be measured.

Impedance Measurement Plot

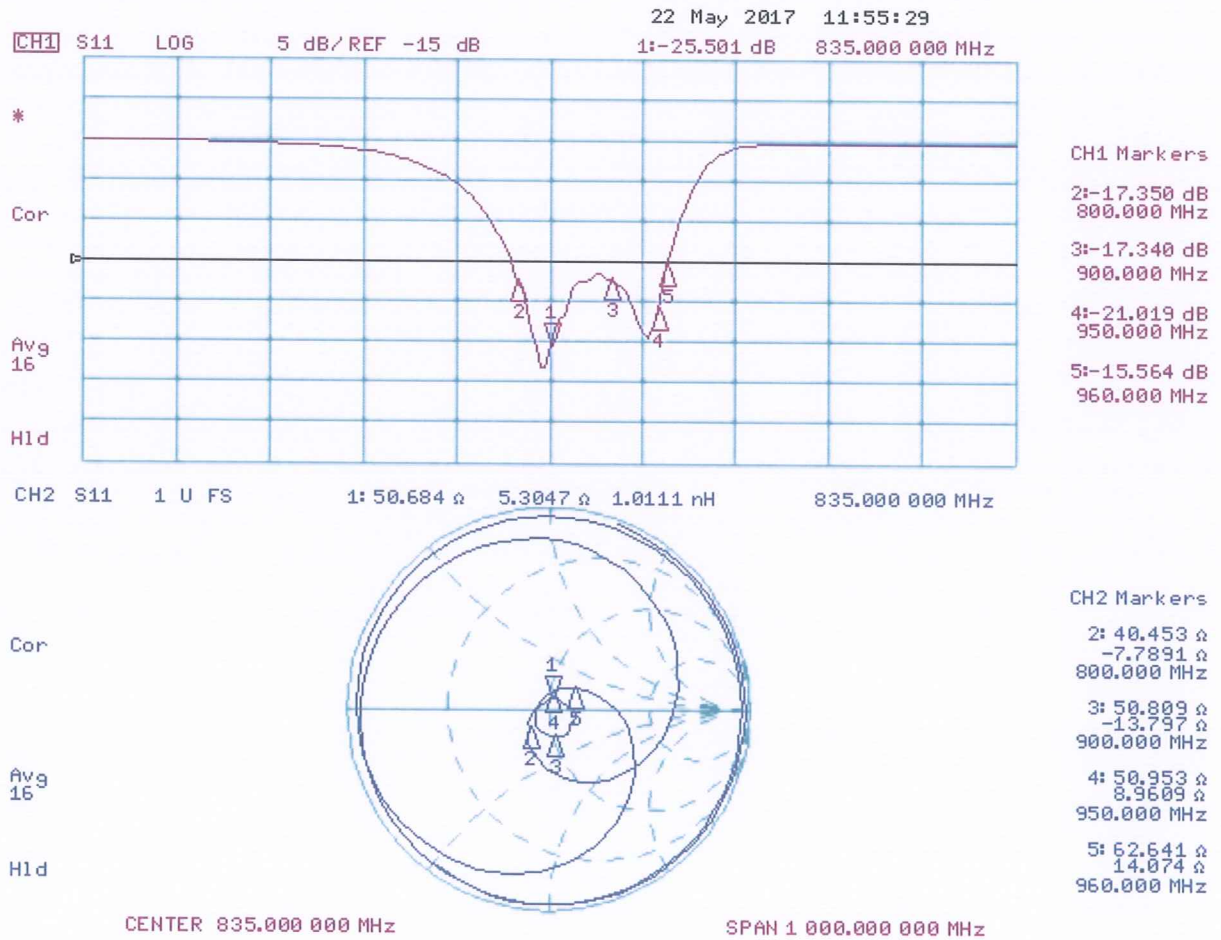

DASY5 E-field Result

Date: 22.05.2017

Test Laboratory: SPEAG Lab2

DUT: HAC-Dipole 835 MHz; Type: CD835V3; Serial: CD835V3 - SN: 1184

Communication System: UID 0 - CW ; Frequency: 835 MHz

Medium parameters used: $\sigma = 0$ S/m, $\epsilon_r = 1$; $\rho = 1000$ kg/m³

Phantom section: RF Section

Measurement Standard: DASY5 (IEEE/IEC/ANSI C63.19-2011)

DASY52 Configuration:

- Probe: ER3DV6 - SN2336; ConvF(1, 1, 1); Calibrated: 30.12.2016;
- Sensor-Surface: (Fix Surface)
- Electronics: DAE4 Sn781; Calibrated: 02.09.2016
- Phantom: HAC Test Arch with AMCC; Type: SD HAC P01 BA; Serial: 1070
- DASY52 52.10.0(1446); SEMCAD X 14.6.10(7417)

Dipole E-Field measurement @ 835MHz/E-Scan - 835MHz d=15mm/Hearing Aid Compatibility Test

(41x361x1): Interpolated grid: dx=0.5000 mm, dy=0.5000 mm

Device Reference Point: 0, 0, -6.3 mm

Reference Value = 108.9 V/m; Power Drift = -0.02 dB

Applied MIF = 0.00 dB

RF audio interference level = 40.76 dBV/m

Emission category: M3

MIF scaled E-field

| | | |
|--------------------------|--------------------------|--------------------------|
| Grid 1 M3 40.58 dBV/m | Grid 2 M3 40.76 dBV/m | Grid 3 M3 40.61 dBV/m |
| Grid 4 M4 36.05 dBV/m | Grid 5 M4 36.17 dBV/m | Grid 6 M4 36.03 dBV/m |
| Grid 7 M3 40.51 dBV/m | Grid 8 M3 40.76 dBV/m | Grid 9 M3 40.69 dBV/m |

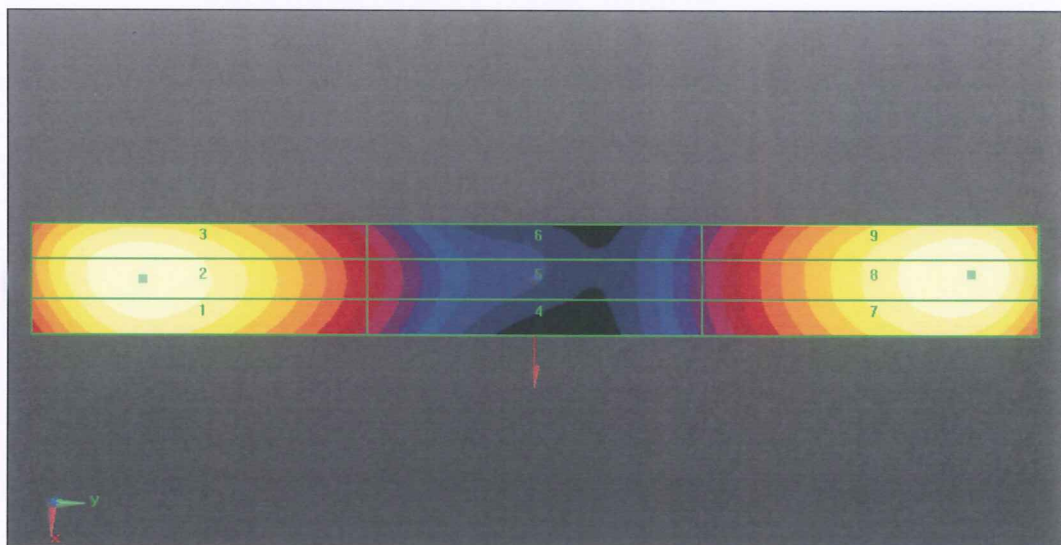
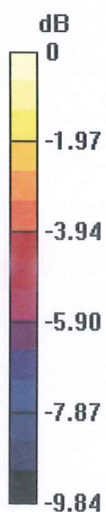

0 dB = 109.2 V/m = 40.76 dBV/m



Accredited by the Swiss Accreditation Service (SAS)
The Swiss Accreditation Service is one of the signatories to the EA
Multilateral Agreement for the recognition of calibration certificates

Accreditation No.: **SCS 0108**

Client **Sporton (Auden)**

Certificate No: **CD1880V3-1170_May17**

CALIBRATION CERTIFICATE

Object **CD1880V3 - SN: 1170**

Calibration procedure(s) **QA CAL-20.v6
Calibration procedure for dipoles in air**

Calibration date: **May 22, 2017**

This calibration certificate documents the traceability to national standards, which realize the physical units of measurements (SI).
The measurements and the uncertainties with confidence probability are given on the following pages and are part of the certificate.

All calibrations have been conducted in the closed laboratory facility: environment temperature (22 ± 3)°C and humidity < 70%.

Calibration Equipment used (M&TE critical for calibration)

| Primary Standards | ID # | Cal Date (Certificate No.) | Scheduled Calibration |
|-----------------------------|--------------------|---------------------------------|-----------------------|
| Power meter NRP | SN: 104778 | 04-Apr-17 (No. 217-02521/02522) | Apr-18 |
| Power sensor NRP-Z91 | SN: 103244 | 04-Apr-17 (No. 217-02521) | Apr-18 |
| Power sensor NRP-Z91 | SN: 103245 | 04-Apr-17 (No. 217-02522) | Apr-18 |
| Reference 20 dB Attenuator | SN: 5058 (20k) | 07-Apr-17 (No. 217-02528) | Apr-18 |
| Type-N mismatch combination | SN: 5047.2 / 06327 | 07-Apr-17 (No. 217-02529) | Apr-18 |
| Probe ER3DV6 | SN: 2336 | 30-Dec-16 (No. ER3-2336_Dec16) | Dec-17 |
| Probe H3DV6 | SN: 6065 | 30-Dec-16 (No. H3-6065_Dec16) | Dec-17 |
| DAE4 | SN: 781 | 02-Sep-16 (No. DAE4-781_Sep16) | Sep-17 |

| Secondary Standards | ID # | Check Date (in house) | Scheduled Check |
|---------------------------|----------------|-----------------------------------|------------------------|
| Power meter Agilent 4419B | SN: GB42420191 | 09-Oct-09 (in house check Sep-14) | In house check: Oct-17 |
| Power sensor HP E4412A | SN: US38485102 | 05-Jan-10 (in house check Sep-14) | In house check: Oct-17 |
| Power sensor HP 8482A | SN: US37295597 | 09-Oct-09 (in house check Sep-14) | In house check: Oct-17 |
| RF generator R&S SMT-06 | SN: 832283/011 | 27-Aug-12 (in house check Oct-15) | In house check: Oct-17 |
| Network Analyzer HP 8753E | SN: US37390585 | 18-Oct-01 (in house check Oct-16) | In house check: Oct-17 |

| | Name | Function | Signature |
|----------------|------------------|-----------------------|-----------|
| Calibrated by: | Johannes Kurikka | Laboratory Technician | |
| Approved by: | Katja Pokovic | Technical Manager | |

Issued: May 25, 2017

This calibration certificate shall not be reproduced except in full without written approval of the laboratory.



Accredited by the Swiss Accreditation Service (SAS)

The Swiss Accreditation Service is one of the signatories to the EA Multilateral Agreement for the recognition of calibration certificates

Accreditation No.: **SCS 0108**

References

- [1] ANSI-C63.19-2011
American National Standard, Methods of Measurement of Compatibility between Wireless Communications Devices and Hearing Aids.

Methods Applied and Interpretation of Parameters:

- *Coordinate System:* y-axis is in the direction of the dipole arms. z-axis is from the basis of the antenna (mounted on the table) towards its feed point between the two dipole arms. x-axis is normal to the other axes. In coincidence with the standards [1], the measurement planes (probe sensor center) are selected to be at a distance of 15 mm above the top metal edge of the dipole arms.
- *Measurement Conditions:* Further details are available from the hardcopies at the end of the certificate. All figures stated in the certificate are valid at the frequency indicated. The forward power to the dipole connector is set with a calibrated power meter connected and monitored with an auxiliary power meter connected to a directional coupler. While the dipole under test is connected, the forward power is adjusted to the same level.
- *Antenna Positioning:* The dipole is mounted on a HAC Test Arch phantom using the matching dipole positioner with the arms horizontal and the feeding cable coming from the floor. The measurements are performed in a shielded room with absorbers around the setup to reduce the reflections. It is verified before the mounting of the dipole under the Test Arch phantom, that its arms are perfectly in a line. It is installed on the HAC dipole positioner with its arms parallel below the dielectric reference wire and able to move elastically in vertical direction without changing its relative position to the top center of the Test Arch phantom. The vertical distance to the probe is adjusted after dipole mounting with a DASY5 Surface Check job. Before the measurement, the distance between phantom surface and probe tip is verified. The proper measurement distance is selected by choosing the matching section of the HAC Test Arch phantom with the proper device reference point (upper surface of the dipole) and the matching grid reference point (tip of the probe) considering the probe sensor offset. The vertical distance to the probe is essential for the accuracy.
- *Feed Point Impedance and Return Loss:* These parameters are measured using a HP 8753E Vector Network Analyzer. The impedance is specified at the SMA connector of the dipole. The influence of reflections was eliminated by applying the averaging function while moving the dipole in the air, at least 70cm away from any obstacles.
- *E-field distribution:* E field is measured in the x-y-plane with an isotropic ER3D-field probe with 100 mW forward power to the antenna feed point. In accordance with [1], the scan area is 20mm wide, its length exceeds the dipole arm length (180 or 90mm). The sensor center is 15 mm (in z) above the metal top of the dipole arms. Two 3D maxima are available near the end of the dipole arms. Assuming the dipole arms are perfectly in one line, the average of these two maxima (in subgrid 2 and subgrid 8) is determined to compensate for any non-parallelity to the measurement plane as well as the sensor displacement. The E-field value stated as calibration value represents the maximum of the interpolated 3D-E-field, in the plane above the dipole surface.

The reported uncertainty of measurement is stated as the standard uncertainty of measurement multiplied by the coverage factor $k=2$, which for a normal distribution corresponds to a coverage probability of approximately 95%.

Measurement Conditions

DASY system configuration, as far as not given on page 1.

| | | |
|---|----------------------|----------|
| DASY Version | DASY5 | V52.10.0 |
| Phantom | HAC Test Arch | |
| Distance Dipole Top - Probe Center | 15 mm | |
| Scan resolution | dx, dy = 5 mm | |
| Frequency | 1880 MHz \pm 1 MHz | |
| Input power drift | < 0.05 dB | |

Maximum Field values at 1880 MHz

| E-field 15 mm above dipole surface | condition | Interpolated maximum |
|---|--------------------|---|
| Maximum measured above high end | 100 mW input power | 92.7 V/m = 39.34 dBV/m |
| Maximum measured above low end | 100 mW input power | 89.6 V/m = 39.05 dBV/m |
| Averaged maximum above arm | 100 mW input power | 91.2 V/m \pm 12.8 % (k=2) |

Appendix (Additional assessments outside the scope of SCS 0108)

Antenna Parameters

| Frequency | Return Loss | Impedance |
|------------------|--------------------|--------------------------------|
| 1730 MHz | 25.4 dB | 52.0 Ω + 5.1 j Ω |
| 1880 MHz | 20.1 dB | 55.8 Ω + 8.8 j Ω |
| 1900 MHz | 20.7 dB | 57.8 Ω + 6.1 j Ω |
| 1950 MHz | 27.0 dB | 54.5 Ω - 1.1 j Ω |
| 2000 MHz | 22.5 dB | 45.0 Ω + 5.0 j Ω |

3.2 Antenna Design and Handling

The calibration dipole has a symmetric geometry with a built-in two stub matching network, which leads to the enhanced bandwidth.

The dipole is built of standard semirigid coaxial cable. The internal matching line is open ended. The antenna is therefore open for DC signals.

Do not apply force to dipole arms, as they are liable to bend. The soldered connections near the feedpoint may be damaged. After excessive mechanical stress or overheating, check the impedance characteristics to ensure that the internal matching network is not affected.

After long term use with 40W radiated power, only a slight warming of the dipole near the feedpoint can be measured.

Impedance Measurement Plot

22 May 2017 12:01:51

CH1 S11 LOG 5 dB/REF -18 dB 1:-20.059 dB 1 880.000 000 MHz

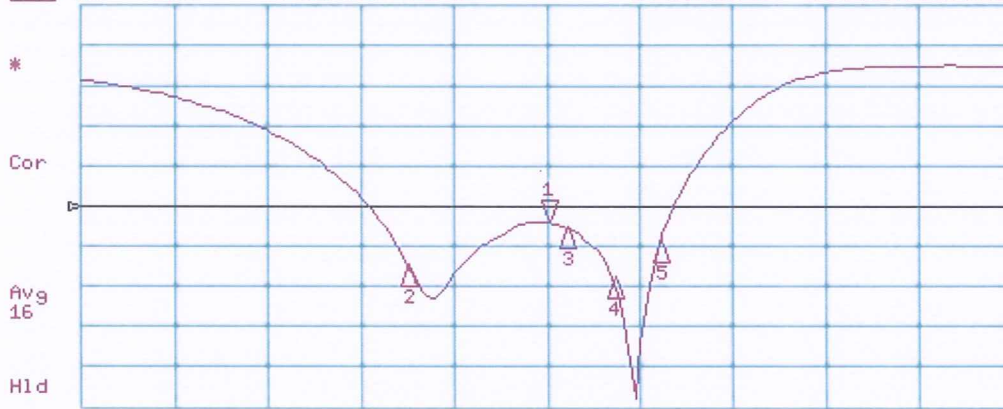

CH2 S11 1 U FS 1: 55.799 Ω 8.8008 Ω 745.05 μH 1 880.000 000 MHz

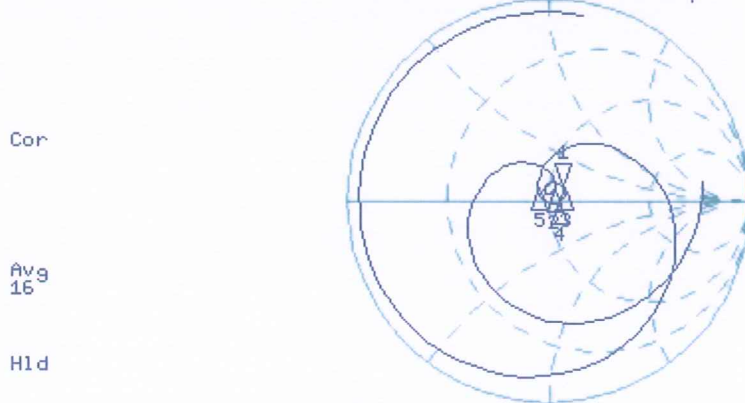

CENTER 1 880.000 000 MHz

SPAN 1 000.000 000 MHz