

# Shenzhen Academy of Information and Communications Technology

## SAR TEST REPORT

No. I17N01718-SAR

For

Yulong Computer Telecommunication Scientific (Shenzhen) Co., Ltd

Smart phone

Model Name: Coolpad 3632A

With

Hardware Version: P2

Software Version: 7.1.108.92.P2.171030.3632A.mpcs

FCC: R38YL3632A

Issued Date: 2017-11-11

**Designation Number: CN1210**

**Note:**

The test results in this test report relate only to the devices specified in this report. This report shall not be reproduced except in full without the written approval of SAICT.

**Test Laboratory:**

Shenzhen Academy of Information and Communications Technology

Building G, Shenzhen International Innovation Center, No.1006 Shennan Road, Futian District, Shenzhen,

Guangdong, P. R. China 518026.

Tel: +86(0)755-33322000, Fax: +86(0)755-33322001

Email: [yewu@caict.ac.cn](mailto:yewu@caict.ac.cn), website: [www.cszit.com](http://www.cszit.com)

**REPORT HISTORY**

<b>Report Number</b>	<b>Revision</b>	<b>Issue Date</b>	<b>Description</b>
I17N01718-SAR	Rev.0	2017-11-11	Initial creation of test report

## TABLE OF CONTENT

<b>1 TEST LABORATORY .....</b>	<b>5</b>
1.1 TESTING LOCATION .....	5
1.2 TESTING ENVIRONMENT .....	5
1.3 PROJECT DATA .....	5
1.4 SIGNATURE .....	5
<b>2 STATEMENT OF COMPLIANCE .....</b>	<b>6</b>
<b>3 CLIENT INFORMATION .....</b>	<b>8</b>
3.1 APPLICANT INFORMATION.....	8
3.2 MANUFACTURER INFORMATION .....	8
<b>4 EQUIPMENT UNDER TEST (EUT) AND ANCILLARY EQUIPMENT (AE) .....</b>	<b>9</b>
4.1 ABOUT EUT .....	9
4.2 INTERNAL IDENTIFICATION OF EUT USED DURING THE TEST .....	10
4.3 INTERNAL IDENTIFICATION OF AE USED DURING THE TEST .....	10
<b>5 TEST METHODOLOGY .....</b>	<b>11</b>
5.1 APPLICABLE LIMIT REGULATIONS.....	11
5.2 APPLICABLE MEASUREMENT STANDARDS .....	11
<b>6 SPECIFIC ABSORPTION RATE (SAR).....</b>	<b>12</b>
6.1 INTRODUCTION.....	12
6.2 SAR DEFINITION.....	12
<b>7 TISSUE SIMULATING LIQUIDS .....</b>	<b>13</b>
7.1 TARGETS FOR TISSUE SIMULATING LIQUID .....	13
7.2 DIELECTRIC PERFORMANCE .....	14
<b>8 SYSTEM VERIFICATION .....</b>	<b>20</b>
8.1 SYSTEM SETUP.....	20
8.2 SYSTEM VERIFICATION .....	21
<b>9 MEASUREMENT PROCEDURES .....</b>	<b>22</b>
9.1 TESTS TO BE PERFORMED.....	22
9.2 GENERAL MEASUREMENT PROCEDURE .....	23
9.3 WCDMA MEASUREMENT PROCEDURES FOR SAR .....	24
9.4 BLUETOOTH & WI-FI MEASUREMENT PROCEDURES FOR SAR.....	25
9.5 SAR MEASUREMENT FOR LTE.....	25
9.6 POWER DRIFT.....	26
<b>10 AREA SCAN BASED 1-G SAR.....</b>	<b>27</b>
10.1 REQUIREMENT OF KDB .....	27
10.2 FAST SAR ALGORITHMS.....	27
<b>11 CONDUCTED OUTPUT POWER.....</b>	<b>28</b>
11.1 MANUFACTURING TOLERANCE .....	28
11.2 HOTSPOT.....	36
11.3 GSM MEASUREMENT RESULT .....	44
11.4 WCDMA MEASUREMENT RESULT .....	46
11.5 LTE-FDD MEASUREMENT RESULT .....	47
11.6 WI-FI AND BT MEASUREMENT RESULT .....	61

<b>12 SIMULTANEOUS TX SAR CONSIDERATIONS</b> .....	<b>62</b>
12.1 INTRODUCTION.....	62
12.2 TRANSMIT ANTENNA SEPARATION DISTANCES.....	62
12.3 SAR MEASUREMENT POSITIONS.....	63
12.4 STANDALONE SAR TEST EXCLUSION CONSIDERATIONS.....	63
<b>13 EVALUATION OF SIMULTANEOUS</b> .....	<b>64</b>
<b>14 SAR TEST RESULT</b> .....	<b>65</b>
14.1 THE EVALUATION OF MULTI-BATTERIES.....	66
14.2 SAR RESULTS FOR FAST SAR .....	66
14.3 SAR RESULTS FOR STANDARD PROCEDURE .....	78
14.4 WLAN EVALUATION .....	81
<b>15 SAR MEASUREMENT VARIABILITY</b> .....	<b>83</b>
<b>16 MEASUREMENT UNCERTAINTY</b> .....	<b>85</b>
16.1 MEASUREMENT UNCERTAINTY FOR NORMAL SAR TESTS (300MHZ~3GHZ).....	85
16.2 MEASUREMENT UNCERTAINTY FOR FAST SAR TESTS (300MHZ~3GHZ) .....	86
<b>17 MAIN TEST INSTRUMENTS</b> .....	<b>87</b>
<b>ANNEX A GRAPH RESULTS</b> .....	<b>88</b>
<b>ANNEX B SYSTEMVERIFICATION RESULTS</b> .....	<b>128</b>
<b>ANNEX C SAR MEASUREMENT SETUP</b> .....	<b>139</b>
C.1 MEASUREMENT SET-UP .....	139
C.2 DASY5 E-FIELD PROBE SYSTEM .....	140
C.3 E-FIELD PROBE CALIBRATION.....	140
C.4 OTHER TEST EQUIPMENT.....	141
<b>ANNEX D POSITION OF THE WIRELESS DEVICE IN RELATION TO THE PHANTOM</b> .....	<b>145</b>
D.1 GENERAL CONSIDERATIONS .....	145
D.2 BODY-WORN DEVICE .....	146
D.3 DESKTOP DEVICE.....	146
D.4 DUT SETUP PHOTOS.....	147
<b>ANNEX E EQUIVALENT MEDIA RECIPES</b> .....	<b>148</b>
<b>ANNEX F SYSTEM VALIDATION</b> .....	<b>149</b>
<b>ANNEX G DAE CALIBRATION CERTIFICATE</b> .....	<b>150</b>
<b>ANNEX H PROBE CALIBRATION CERTIFICATE</b> .....	<b>155</b>
<b>ANNEX I DIPOLE CALIBRATION CERTIFICATE</b> .....	<b>166</b>
<b>ANNEX J SPOT CHECK TEST</b> .....	<b>206</b>
J.1 INTERNAL IDENTIFICATION OF EUT USED DURING THE SPOT CHECK TEST.....	206
J.2 MEASUREMENT RESULTS .....	206
<b>ANNEX K SYSTEM VALIDATION RESULTS FOR SPOT CHECK TEST</b> .....	<b>229</b>

## 1 Test Laboratory

### 1.1 Testing Location

Company Name:	Shenzhen Academy of Information and Communications Technology
Address:	Building G, Shenzhen International Innovation Center, No.1006 Shennan Road, Futian District, Shenzhen, Guangdong, China

### 1.2 Testing Environment

Temperature:	18°C~25 °C
Relative humidity:	30%~ 70%
Ground system resistance:	< 4Ω
Ambient noise & Reflection:	< 0.012 W/kg

### 1.3 Project Data

Project Leader:	Zhang Yunzhuan
Test Engineer:	Li Yongfu
Testing Start Date:	February 08, 2017
Testing End Date:	November 09, 2017

### 1.4 Signature

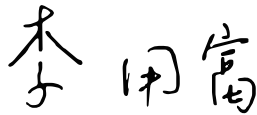

Li Yongfu

(Prepared this test report)



Zhang Yunzhuan

(Reviewed this test report)



Cao Junfei

Deputy Director of the laboratory  
(Approved this test report)

## 2 Statement of Compliance

This EUT is a variant product and the report of original sample is No.I17N00032-SAR. According to the client request, we quote the test results of original sample. The results of spot check are presented in annex J.

The maximum results of Specific Absorption Rate (SAR) found during testing for Yulong Computer Telecommunication Scientific (Shenzhen) Co., Ltd Smart phone Coolpad 3632A are as follows:

**Table 2.1: Highest Reported SAR (1g)**

Exposure Configuration	Technology Band	Highest Reported SAR 1g(W/Kg)	Equipment Class
Head (Separation Distance 0mm)	GSM850	<b>0.39</b>	PCE
	PCS1900	<b>0.03</b>	
	UMTS FDD 5	<b>0.53</b>	
	UMTS FDD 2	<b>0.54</b>	
	UMTS FDD 4	<b>0.62</b>	
	LTE Band 2	<b>0.61</b>	
	LTE Band 4	<b>0.41</b>	
	LTE Band 5	<b>0.42</b>	
	LTE Band 12	<b>0.29</b>	
	WLAN 2.4GHz	<b>0.97</b>	DTS
Body-worn (Data) (Separation Distance 10mm)	GSM850	<b>0.44</b>	PCE
	PCS1900	<b>0.83</b>	
	UMTS FDD 5	<b>0.70</b>	
	UMTS FDD 2	<b>1.33</b>	
	UMTS FDD 4	<b>1.20</b>	
	LTE Band 2	<b>1.26</b>	
	LTE Band 4	<b>1.29</b>	
	LTE Band 5	<b>0.67</b>	
	LTE Band 12	<b>0.54</b>	
	WLAN 2.4GHz	<b>0.26</b>	DTS

The SAR values found for the Mobile Phone are below the maximum recommended levels of 1.6 W/Kg as averaged over any 1g tissue according to the ANSI C95.1-1999.

For body worn operation, this device has been tested and meets FCC RF exposure guidelines when used with any accessory that contains no metal and which provides a minimum separation distance of 10 mm between this device and the body of the user. Use of other accessories may not ensure compliance with FCC RF exposure guidelines.

The EUT battery must be fully charged and checked periodically during the test to ascertain uniform power output.

The measurement together with the test system set-up is described in annex C of this test report. A detailed description of the equipment under test can be found in chapter 4 of this test report.

The highest reported SAR value is obtained at the case of **(Table 2.1)**, and the values are: **1.33W/kg(1g)**.

**Table 2.2: The sum of reported SAR values for main antenna and Wi-Fi**

	<b>Position</b>	<b>Main antenna</b>	<b>Wi-Fi</b>	<b>Sum</b>
<b>Highest reported SAR value for Head</b>	Left Touch	0.61	0.97	<b>1.58</b>
	Right Touch	0.62	0.48	<b>1.10</b>
<b>Highest reported SAR value for Body</b>	Rear	1.29	0.26	<b>1.55</b>
	Bottom	1.33	/	<b>1.33</b>

**Table2.3: The sum of reported SAR values for main antenna and BT**

	<b>Position</b>	<b>Main antenna</b>	<b>BT*</b>	<b>Sum</b>
<b>Highest reported SAR value for Head</b>	Left Touch	0.61	0.06	<b>0.67</b>
	Right Touch	0.62	0.06	<b>0.68</b>
<b>Highest reported SAR value for Body</b>	Rear	1.29	0.03	<b>1.32</b>
	Bottom	1.33	/	<b>1.33</b>

BT\*-Estimated SAR for Bluetooth (seethetable13.3)

According to the above tables, the highest sum of reported SAR values is **1.58 W/kg (1g)**. The detail for simultaneous transmission consideration is described in chapter 13.

### 3 Client Information

#### 3.1 Applicant Information

Company Name:	Yulong Computer Telecommunication Scientific (Shenzhen) Co., Ltd
Address /Post:	Coolpad Information Harbor, High-tech Industrial Park (North), Nanshan District, Shenzhen, P.R.C.
Contact:	wangping
Email:	wangping1@yulong.com
Telephone:	0755-83301199-83335
Fax:	/

#### 3.2 Manufacturer Information

Company Name:	Yulong Computer Telecommunication Scientific (Shenzhen) Co., Ltd
Address /Post:	Coolpad Information Harbor, High-tech Industrial Park (North), Nanshan District, Shenzhen, P.R.C.
Contact:	wangping
Email:	wangping1@yulong.com
Telephone:	0755-83301199-83335
Fax:	/



## 4 Equipment Under Test (EUT) and Ancillary Equipment (AE)

### 4.1 About EUT

Description:	Smart phone
Model Name:	Coolpad 3632A
Operating mode(s):	GSM 850/1900/900/1800, WCDMA 850/1700/1900, LTE_FDD Band 2/4/5/12, BT, Wi-Fi 2.4G
Tested Tx Frequency:	825–848.8 MHz (GSM 850)
	1850.2–1910 MHz (GSM 1900)
	826.4–846.6 MHz (WCDMA850 Band V)
	1712.4–1752.6 MHz (WCDMA1700 Band IV)
	1852.4–1907.6 MHz (WCDMA1900 Band II)
	1850.7–1909.3 MHz (LTE_FDD Band 2)
	1710.7–1754.3 MHz (LTE_FDD Band 4)
	824.7–848.3 MHz (LTE_FDD Band 5)
	699.7–715.3 MHz (LTE_FDD Band 12)
2412 – 2462 MHz (Wi-Fi 2.4G)	
GPRS&EGPRS Multislot Class:	33
GPRS capability Class:	/
WCDMA Category:	USAT: 6
	HSDPA: 14
	HSUPA: 6
Release Version:	GSM: Rel8
	GPRS: Rel8
	UMTS: Rel8
Test device Production information:	Production unit
Device type:	Portable device
Antenna type:	Integrated antenna
Accessories/Body-worn configurations:	/
Hotspot mode:	Support simultaneous transmission of hotspot and voice(or data)

#### 4.2 Internal Identification of EUT used during the test

EUT ID*	SN or IMEI	HW Version	SW Version
EUT1	IMEI: 862006030009421	P2	7.1.108.92.P2.171030.3632A.mpcs
EUT2	IMEI: 862006030009256	P2	7.1.108.92.P2.171030.3632A.mpcs
EUT3	IMEI: 862429037562392	P2	7.1.108.92.P2.171030.3632A.mpcs

\*EUT ID: is used to identify the test sample in the lab internally.

**Note:** It is performed to test SAR with the EUT 1 & EUT 3, and conducted power with the EUT 2.

#### 4.3 Internal Identification of AE used during the test

AE ID*	Description	Model	SN	Manufacturer
AE1	Battery	CPLD-417	CPLD41716424000001	Zhuhai COSLIGHT Battery CO., Ltd.
AE2	Battery	CPLD-417	CPLD41716424000001	Tianjin Lishen Battery Joint-Stock Co.,Ltd.

\*AE ID: is used to identify the test sample in the lab internally.

## 5 TEST METHODOLOGY

### 5.1 Applicable Limit Regulations

**ANSI C95.1–1999:** IEEE Standard for Safety Levels with Respect to Human Exposure to Radio Frequency Electromagnetic Fields, 3 kHz to 300 GHz.

It specifies the maximum exposure limit of **1.6 W/kg** as averaged over any 1 gram of tissue for portable devices being used within 20 cm of the user in the uncontrolled environment.

### 5.2 Applicable Measurement Standards

**IEEE 1528–2013:** Recommended Practice for Determining the Peak Spatial-Average Specific Absorption Rate (SAR) in the Human Head from Wireless Communications Devices: Experimental Techniques.

**KDB 447498 D01 General RF Exposure Guidance v06:** Mobile and Portable Devices RF Exposure Procedures and Equipment Authorization Policies.

**KDB648474 D04 Handset SAR v01r03:** SAR Evaluation Considerations for Wireless Handsets.

**KDB941225 D01 SAR test for 3G devices v03r01:** SAR Measurement Procedures for 3G Devices

**KDB941225 D05 SAR for LTE Devices v02r05:** SAR Evaluation Considerations for LTE Devices

**KDB 941225 D06 Hot Spot SAR v02r01:** SAR Evaluation Procedures for Portable Devices with Wireless Router Capabilities

**KDB 248227 D01 802.11 Wi-Fi SAR v02r02:** SAR Guidance for IEEE 802.11 (Wi-Fi) Transmitters.

**KDB 865664 D01 SAR measurement 100 MHz to 6 GHz v01r04:** SAR Measurement Requirements for 100 MHz to 6 GHz.

**KDB 865664 D02 RF Exposure Reporting v01r02:** RF Exposure Compliance Reporting and Documentation Considerations

## 6 Specific Absorption Rate (SAR)

### 6.1 Introduction

SAR is related to the rate at which energy is absorbed per unit mass in an object exposed to a radio field. The SAR distribution in a biological body is complicated and is usually carried out by experimental techniques or numerical modeling. The standard recommends limits for two tiers of groups, occupational/controlled and general population/uncontrolled, based on a person's awareness and ability to exercise control over his or her exposure. In general, occupational/controlled exposure limits are higher than the limits for general population/uncontrolled.

### 6.2 SAR Definition

The SAR definition is the time derivative (rate) of the incremental energy ( $dW$ ) absorbed by (dissipated in) an incremental mass ( $dm$ ) contained in a volume element ( $dv$ ) of a given density ( $\rho$ ). The equation description is as below:

$$SAR = \frac{d}{dt} \left( \frac{dW}{dm} \right) = \frac{d}{dt} \left( \frac{dW}{\rho dv} \right)$$

SAR is expressed in units of Watts per kilogram (W/kg)

SAR measurement can be either related to the temperature elevation in tissue by

$$SAR = c \left( \frac{\delta T}{\delta t} \right)$$

Where:  $C$  is the specific heat capacity,  $\delta T$  is the temperature rise and  $\delta t$  is the exposure duration, or related to the electrical field in the tissue by

$$SAR = \frac{\sigma |E|^2}{\rho}$$

Where:  $\sigma$  is the conductivity of the tissue,  $\rho$  is the mass density of tissue and  $E$  is the RMS electrical field strength.

However for evaluating SAR of low power transmitter, electrical field measurement is typically applied.

## 7 Tissue Simulating Liquids

### 7.1 Targets for tissue simulating liquid

Table 7.1: Targets for tissue simulating liquid

Frequency (MHz)	Liquid Type	Conductivity ( $\sigma$ )	$\pm 5\%$ Range	Permittivity ( $\epsilon$ )	$\pm 5\%$ Range
750	Head	0.89	0.85~0.93	41.94	39.8~44.0
750	Body	0.96	0.91~1.01	55.5	52.7~58.3
835	Head	0.90	0.86~0.95	41.5	39.4~43.6
835	Body	0.97	0.92~1.02	55.2	52.4~58.0
1800	Head	1.40	1.33~1.47	40.0	38.0~42.0
1800	Body	1.52	1.44~1.60	53.5	50.8~56.1
1900	Head	1.40	1.33~1.47	40.0	38.0~42.0
1900	Body	1.52	1.44~1.60	53.3	50.6~56.0
2450	Head	1.80	1.71~1.89	39.2	37.2~41.2
2450	Body	1.95	1.85~2.05	52.7	50.1~55.3

## 7.2 Dielectric Performance

Table 7.2: Dielectric Performance of Tissue Simulating Liquid

Measurement Date (yyyy-mm-dd)	Type	Frequency	Permittivity $\epsilon$	Drift (%)	Conductivity $\sigma$ (S/m)	Drift (%)
2017-2-14	Head	750	41.52	-1.00	0.906	1.80
2017-2-14	Body	750	53.46	-3.68	0.954	-0.63
2017-2-8	Head	835	41.18	-0.77	0.896	-0.44
2017-2-8	Body	835	55.58	0.69	0.984	1.44
2017-2-13	Head	1800	40.99	2.48	1.384	-1.14
2017-2-13	Body	1800	53.22	-0.52	1.502	-1.18
2017-2-12	Head	1900	40.66	1.65	1.419	1.36
2017-2-12	Body	1900	52.95	-0.66	1.548	1.84
2017-2-15	Head	2450	37.87	-3.39	1.853	2.94
2017-2-15	Body	2450	54.65	3.70	1.914	-1.85
2017-11-9	Head	750	42.66	1.72	0.901	1.24
2017-11-9	Body	750	53.43	-3.73	0.973	1.35
2017-11-8	Head	835	43.11	3.88	0.906	0.67
2017-11-8	Body	835	53.69	-2.74	0.988	1.86
2017-11-8	Head	1800	39.17	-2.08	1.377	-1.64
2017-11-8	Body	1800	53.08	-0.79	1.487	-2.17
2017-11-8	Head	1900	38.71	-3.23	1.413	0.93
2017-11-8	Body	1900	52.66	-1.20	1.564	2.89
2017-11-9	Head	2450	38.74	-1.17	1.861	3.39
2017-11-9	Body	2450	51.65	-1.99	1.926	-1.23

Note: The liquid temperature is 22.0°C

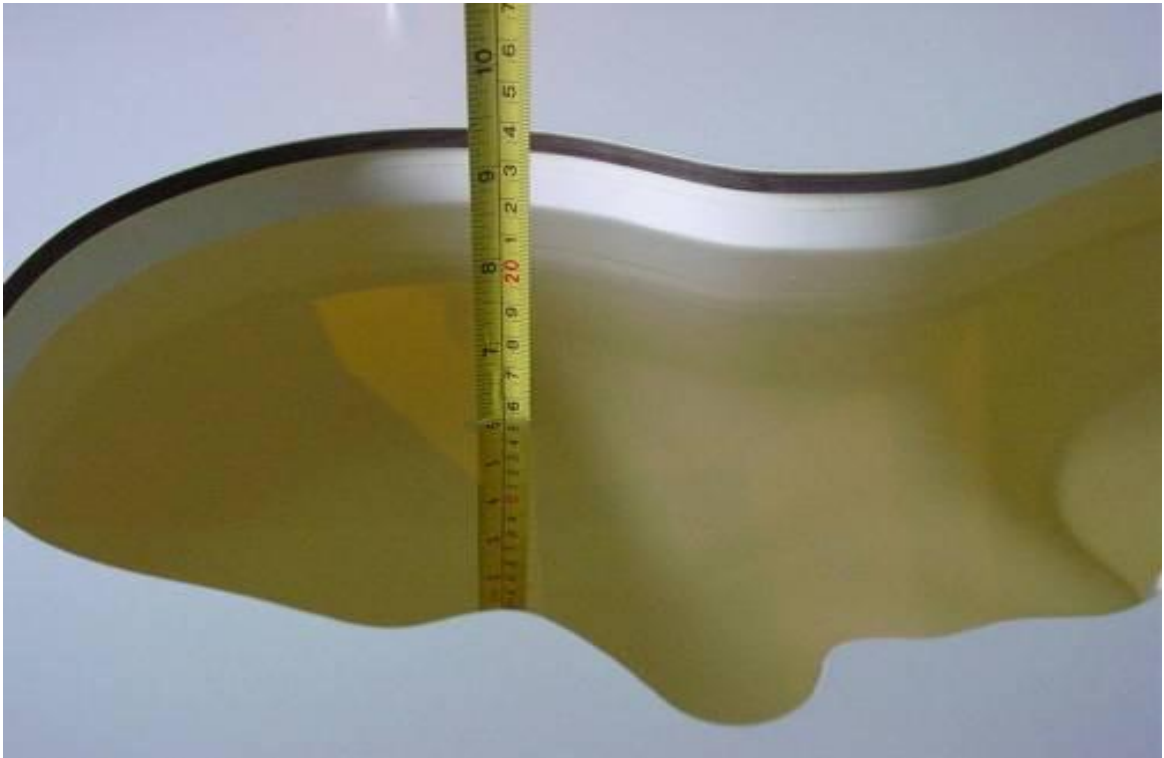

Picture 7-1: Liquid depth in the Head Phantom (750 MHz)

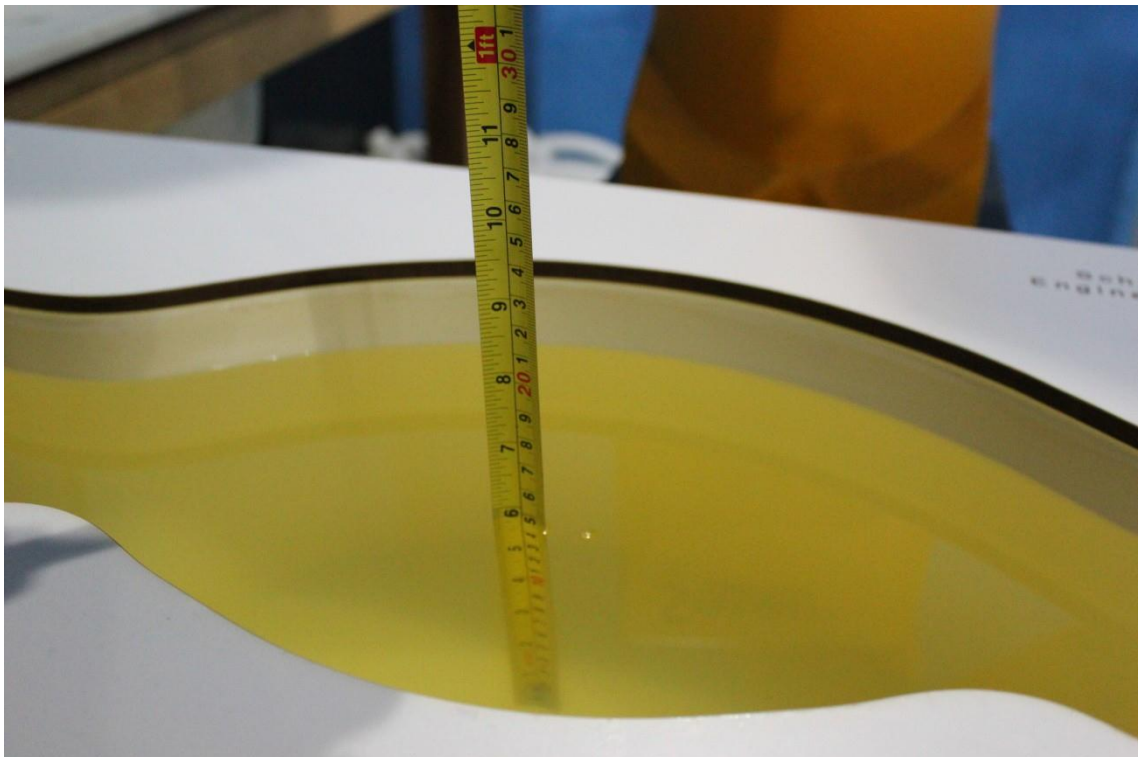

Picture 7-2: Liquid depth in the Flat Phantom (750 MHz)

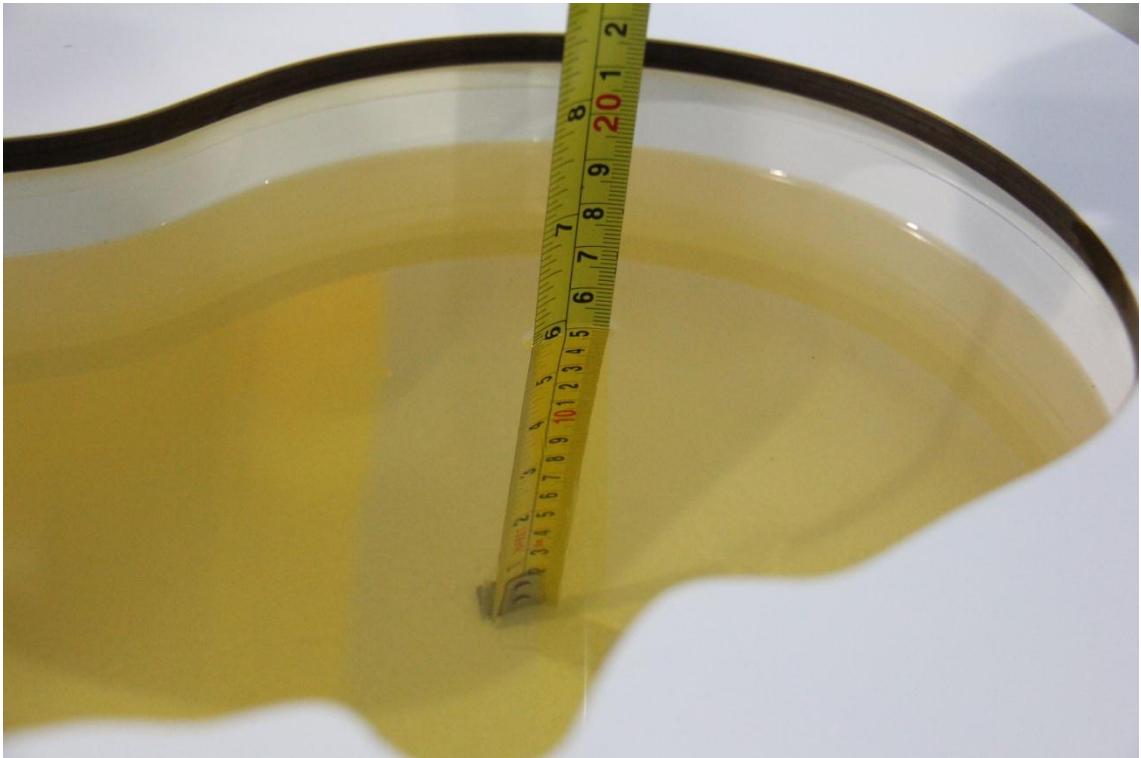

Picture 7-3: Liquid depth in the Head Phantom (835 MHz)

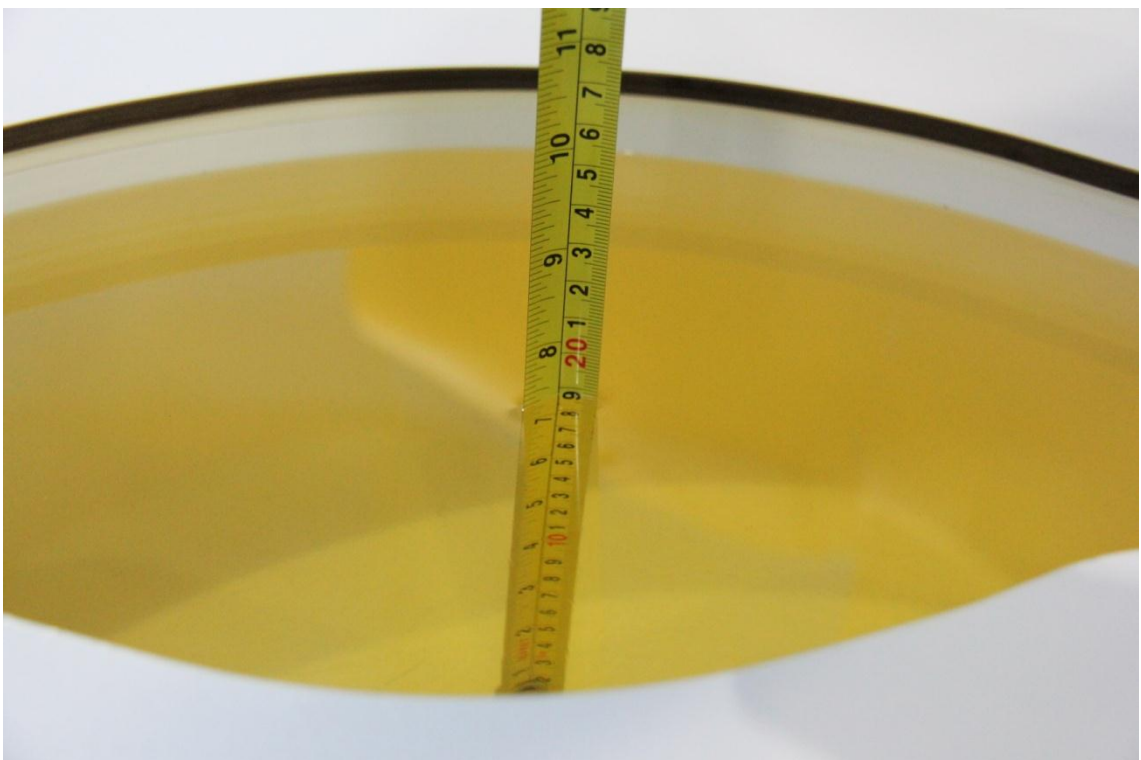

Picture 7-4: Liquid depth in the Flat Phantom (835 MHz)



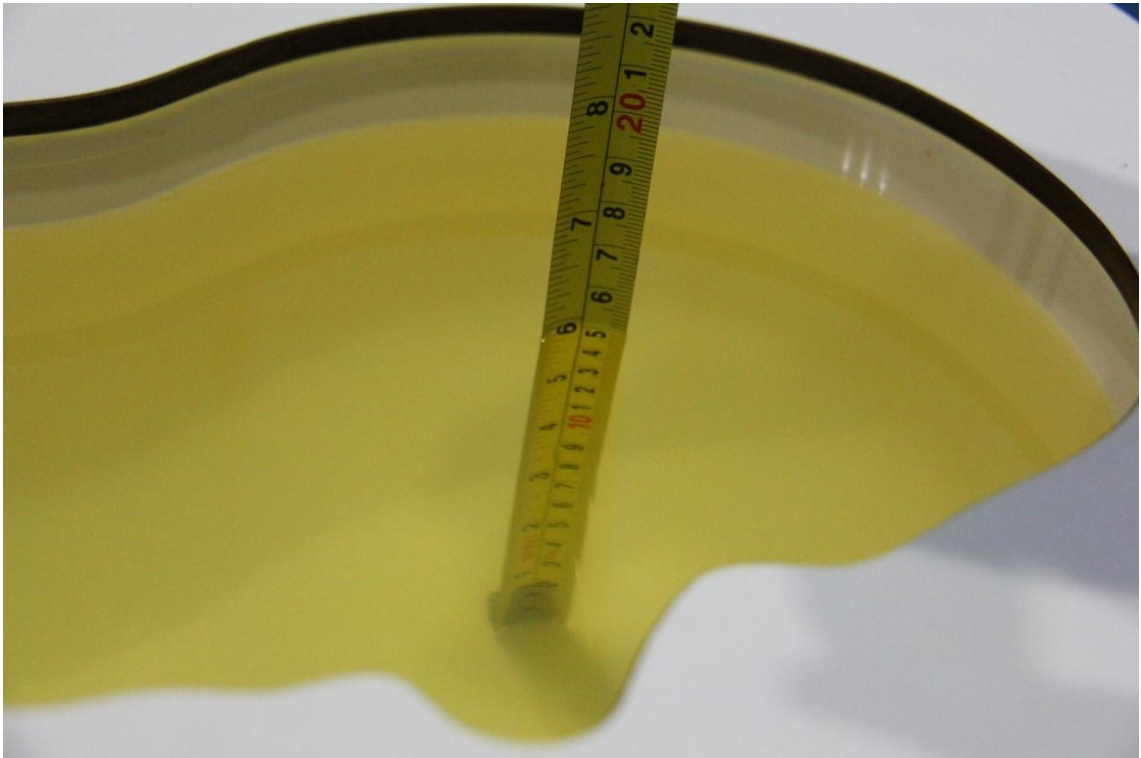

**Picture 7-5: Liquid depth in the Head Phantom (1800 MHz)**

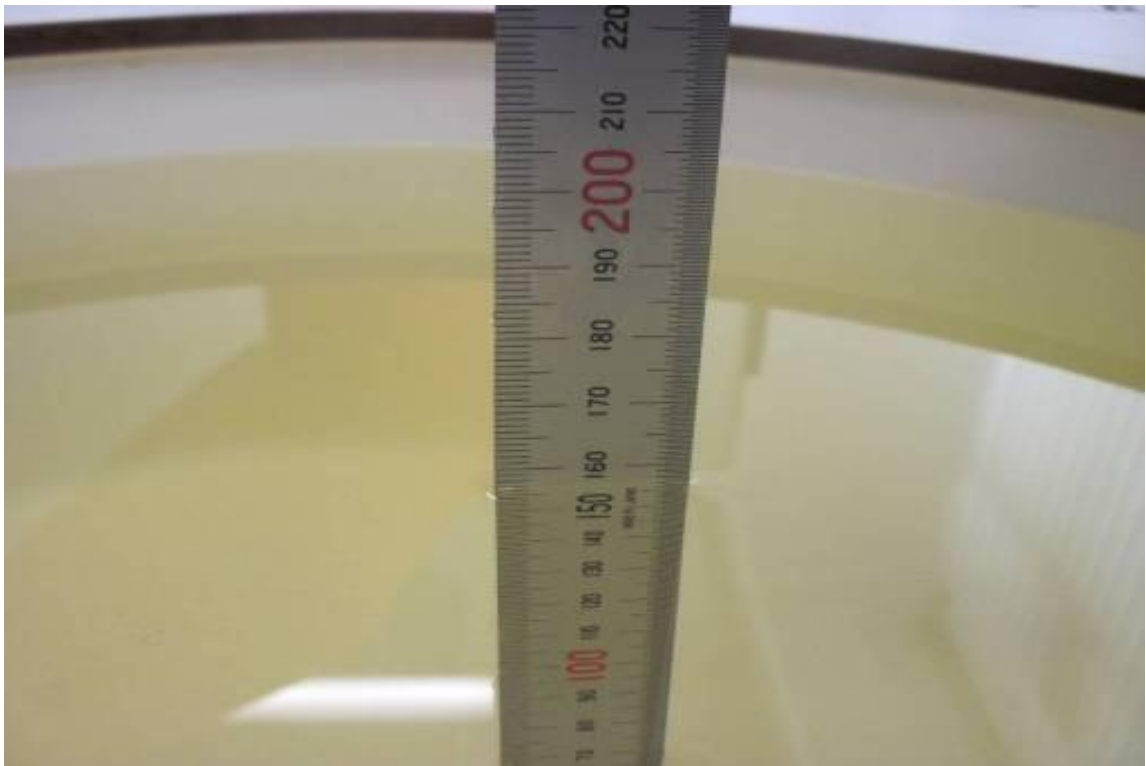

**Picture 7-6: Liquid depth in the Flat Phantom (1800MHz)**

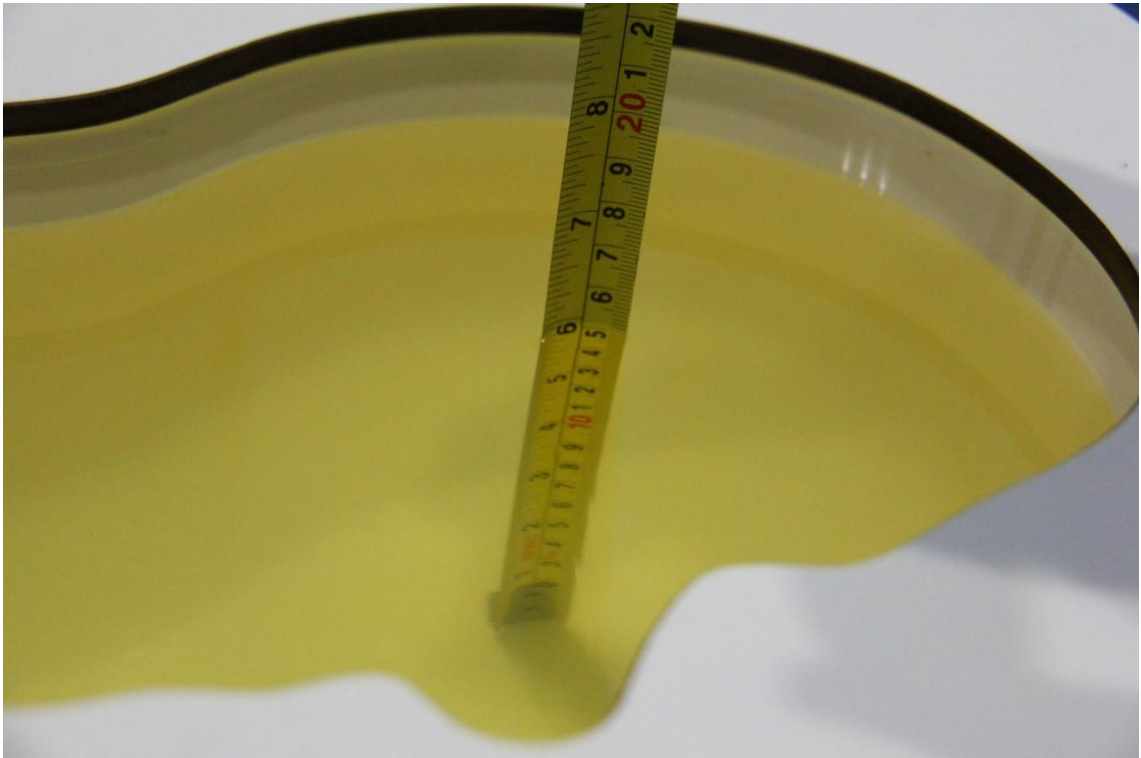

**Picture 7-7: Liquid depth in the Head Phantom (1900 MHz)**

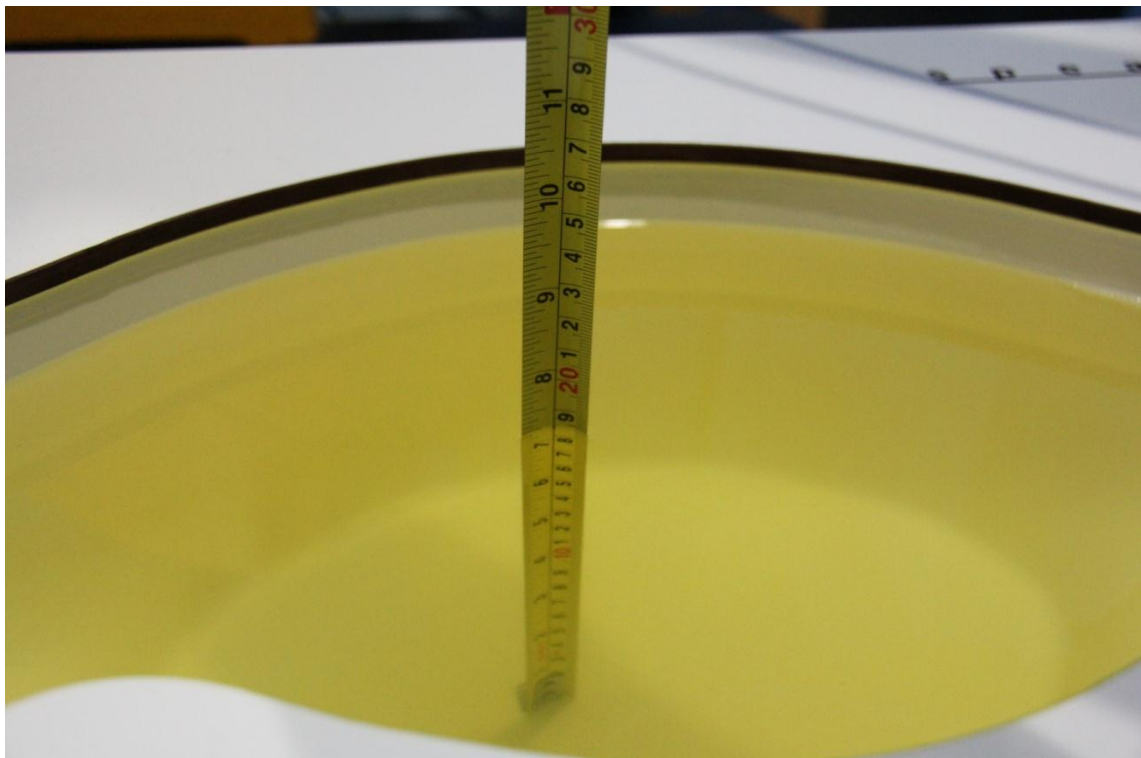

**Picture 7-8: Liquid depth in the Flat Phantom (1900MHz)**

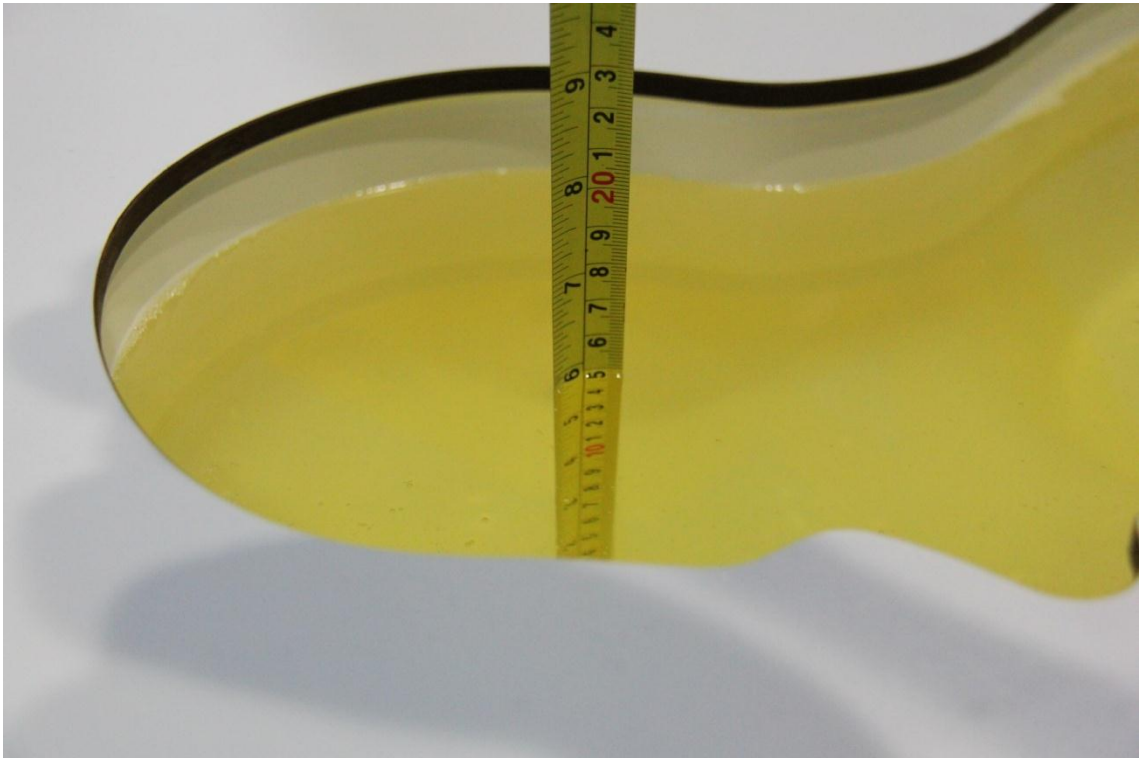

**Picture 7-9: Liquid depth in the Head Phantom(2450MHz)**

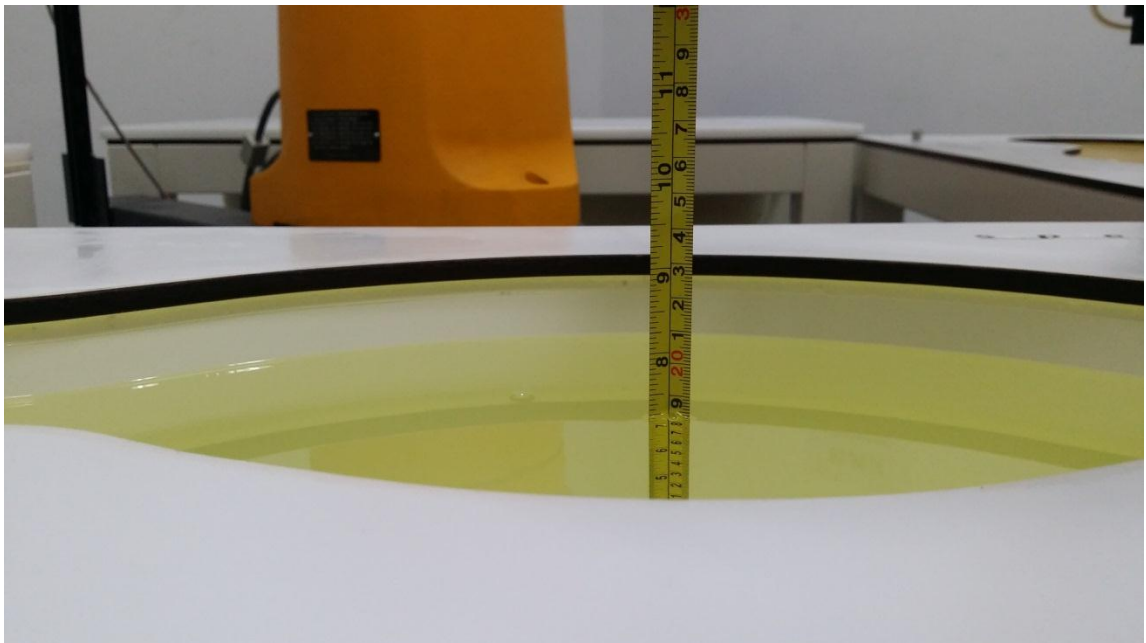

**Picture 7-10: Liquid depth in the Flat Phantom(2450MHz)**

## 8 System verification

### 8.1 System Setup

In the simplified setup for system evaluation, the DUT is replaced by a calibrated dipole and the power source is replaced by a continuous wave that comes from a signal generator. The calibrated dipole must be placed beneath the flat phantom section of the SAM twin phantom with the correct distance holder. The distance holder should touch the phantom surface with a light pressure at the reference marking and be oriented parallel to the long side of the phantom. The equipment setup is shown below:

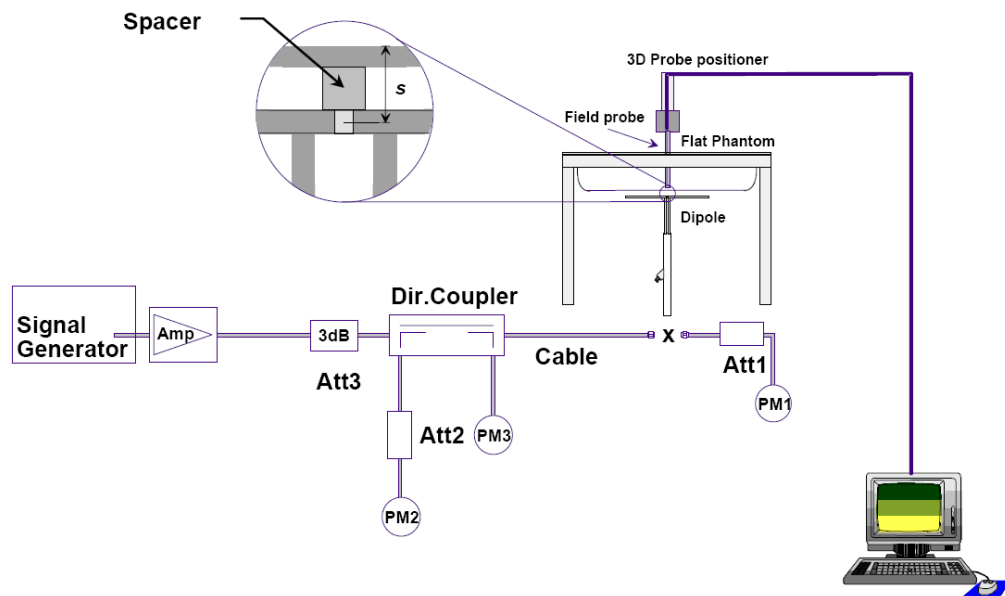

Picture 8.1 System Setup for System Evaluation



Picture 8.2 Photo of Dipole Setup

## 8.2 System Verification

SAR system verification is required to confirm measurement accuracy, according to the tissue dielectric media, probe calibration points and other system operating parameters required for measuring the SAR of a test device. The system verification must be performed for each frequency band and within the valid range of each probe calibration point required for testing the device.

The system verification results are required that the area scan estimated 1-g SAR is within 3% of the zoom scan 1-g SAR. The details are presented in annex B.

**Table 8.1: System Verification of Head**

Measurement Date (yyyy-mm-dd)	Frequency	Target value (W/kg)		Measured value (W/kg)		Deviation (%)	
		10 g Average	1 g Average	10 g Average	1 g Average	10 g Average	1 g Average
2017-2-14	750 MHz	5.46	8.33	5.64	8.64	3.30	3.72
2017-2-8	835 MHz	6.03	9.22	5.88	9.04	-2.49	-1.95
2017-2-13	1800 MHz	20.6	38.8	20.36	37.92	-1.17	-2.27
2017-2-12	1900 MHz	21.0	40.8	21.44	42.00	2.10	2.94
2017-2-15	2450 MHz	24.1	52.5	23.52	50.80	-2.41	-3.24
2017-11-9	750 MHz	5.46	8.33	5.60	8.64	2.56	3.72
2017-11-8	835 MHz	6.03	9.22	6.00	9.12	-0.50	-1.08
2017-11-8	1800 MHz	20.6	38.8	20.40	38.08	-0.97	-1.86
2017-11-8	1900 MHz	21.0	40.8	21.32	41.60	1.52	1.96
2017-11-9	2450 MHz	24.1	52.5	24.32	53.20	0.91	1.33

**Table 8.2: System Verification of Body**

Measurement Date (yyyy-mm-dd)	Frequency	Target value (W/kg)		Measured value (W/kg)		Deviation (%)	
		10 g Average	1 g Average	10 g Average	1 g Average	10 g Average	1 g Average
2017-2-14	750 MHz	5.76	8.78	5.60	8.56	-2.78	-2.51
2017-2-8	835 MHz	6.20	9.44	6.00	9.08	-3.23	-3.81
2017-2-13	1800 MHz	21.1	39.6	20.52	38.60	-2.75	-2.53
2017-2-12	1900 MHz	21.3	41.1	22.04	42.40	3.47	3.16
2017-2-15	2450 MHz	24.4	52.3	23.52	50.40	-3.61	-3.63
2017-11-9	750 MHz	5.76	8.78	5.68	8.52	-1.39	-2.96
2017-11-8	835 MHz	6.20	9.44	6.08	9.16	-1.94	-2.97
2017-11-8	1800 MHz	21.1	39.6	20.68	38.64	-1.99	-2.42
2017-11-8	1900 MHz	21.3	41.1	21.84	42.40	2.54	3.16
2017-11-9	2450 MHz	24.4	52.3	24.24	51.20	-0.66	-2.10

## 9 Measurement Procedures

### 9.1 Tests to be performed

In order to determine the highest value of the peak spatial-average SAR of a handset, all device positions, configurations and operational modes shall be tested for each frequency band according to steps 1 to 3 below. A flowchart of the test process is shown in picture 9.1.

**Step 1:** The tests described in 9.2 shall be performed at the channel that is closest to the center of the transmit frequency band ( $f_c$ ) for:

- a) all device positions (cheek and tilt, for both left and right sides of the SAM phantom, as described in annex D),
- b) all configurations for each device position in a), e.g., antenna extended and retracted, and
- c) all operational modes, e.g., analogue and digital, for each device position in a) and configuration in b) in each frequency band.

If more than three frequencies need to be tested according to 11.1 (i.e.,  $N_c > 3$ ), then all frequencies, configurations and modes shall be tested for all of the above test conditions.

**Step 2:** For the condition providing highest peak spatial-average SAR determined in Step 1, perform all tests described in 9.2 at all other test frequencies, i.e., lowest and highest frequencies. In addition, for all other conditions (device position, configuration and operational mode) where the peak spatial-average SAR value determined in Step 1 is within 3 dB of the applicable SAR limit, it is recommended that all other test frequencies shall be tested as well.

**Step 3:** Examine all data to determine the highest value of the peak spatial-average SAR found in Steps 1 to 2.

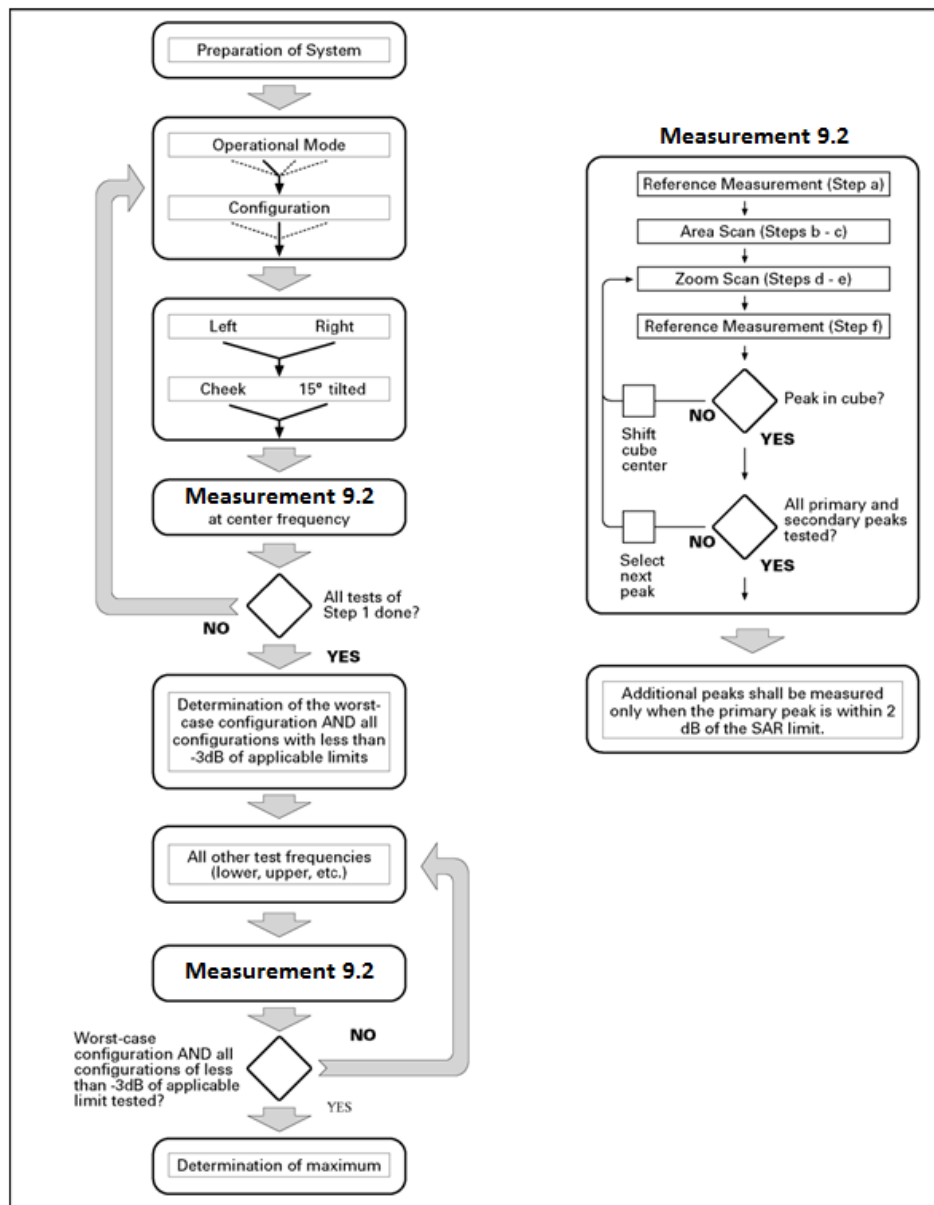

Picture 9.1 Block diagram of the tests to be performed

## 9.2 General Measurement Procedure

The area and zoom scan resolutions specified in the table below must be applied to the SAR measurements and fully documented in SAR reports to qualify for TCB approval. Probe boundary effect error compensation is required for measurements with the probe tip closer than half a probe tip diameter to the phantom surface. Both the probe tip diameter and sensor offset distance must satisfy measurement protocols; to ensure probe boundary effect errors are minimized and the higher fields closest to the phantom surface can be correctly measured and extrapolated to the phantom surface for computing 1-g SAR. Tolerances of the post-processing algorithms must be verified by the test laboratory for the scan resolutions used in the SAR measurements, according to the reference distribution functions specified in IEEE Std 1528-2013. The results should be documented as part of the system validation records and may be requested to support test results

when all the measurement parameters in the following table are not satisfied.

		$\leq 3$ GHz	$> 3$ GHz
Maximum distance from closest measurement point (geometric center of probe sensors) to phantom surface		$5 \pm 1$ mm	$\frac{1}{2} \delta \ln(2) \pm 0.5$ mm
Maximum probe angle from probe axis to phantom surface normal at the measurement location		$30^\circ \pm 1^\circ$	$20^\circ \pm 1^\circ$
Maximum area scan spatial resolution: $\Delta x_{Area}, \Delta y_{Area}$		$\leq 2$ GHz: $\leq 15$ mm 2 – 3 GHz: $\leq 12$ mm	3 – 4 GHz: $\leq 12$ mm 4 – 6 GHz: $\leq 10$ mm
		When the x or y dimension of the test device, in the measurement plane orientation, is smaller than the above, the measurement resolution must be $\leq$ the corresponding x or y dimension of the test device with at least one measurement point on the test device.	
Maximum zoom scan spatial resolution: $\Delta x_{Zoom}, \Delta y_{Zoom}$		$\leq 2$ GHz: $\leq 8$ mm 2 – 3 GHz: $\leq 5$ mm*	3 – 4 GHz: $\leq 5$ mm* 4 – 6 GHz: $\leq 4$ mm*
Maximum zoom scan spatial resolution, normal to phantom surface	uniform grid: $\Delta z_{Zoom}(n)$	$\leq 5$ mm	3 – 4 GHz: $\leq 4$ mm 4 – 5 GHz: $\leq 3$ mm 5 – 6 GHz: $\leq 2$ mm
	graded grid $\Delta z_{Zoom}(1)$ : between 1 <sup>st</sup> two points closest to phantom surface	$\leq 4$ mm	3 – 4 GHz: $\leq 3$ mm 4 – 5 GHz: $\leq 2.5$ mm 5 – 6 GHz: $\leq 2$ mm
	$\Delta z_{Zoom}(n>1)$ : between subsequent points	$\leq 1.5 \cdot \Delta z_{Zoom}(n-1)$	
Minimum zoom scan volume	x, y, z	$\geq 30$ mm	3 – 4 GHz: $\geq 28$ mm 4 – 5 GHz: $\geq 25$ mm 5 – 6 GHz: $\geq 22$ mm
Note: $\delta$ is the penetration depth of a plane-wave at normal incidence to the tissue medium; see draft standard IEEE P1528-2011 for details. * When zoom scan is required and the <i>reported</i> SAR from the area scan based <i>I-g SAR estimation</i> procedures of KDB 447498 is $\leq 1.4$ W/kg, $\leq 8$ mm, $\leq 7$ mm and $\leq 5$ mm zoom scan resolution may be applied, respectively, for 2 GHz to 3 GHz, 3 GHz to 4 GHz and 4 GHz to 6 GHz.			

### 9.3 WCDMA Measurement Procedures for SAR

The following procedures are applicable to WCDMA handsets operating under 3GPP Release99, Release 5 and Release 6. The default test configuration is to measure SAR with an established radio link between the DUT and a communication test set using a 12.2kbps RMC (reference measurement channel) configured in Test Loop Mode 1. SAR is selectively confirmed for other physical channel configurations (DPCCH & DPDCH<sub>n</sub>), HSDPA and HSPA (HSUPA/HSDPA) modes according to output power, exposure conditions and device operating capabilities. Both uplink and downlink should be configured with the same RMC or AMR, when required. SAR for Release 5 HSDPA and Release 6 HSPA are measured using the applicable FRC (fixed reference channel) and E-DCH reference channel configurations. Maximum output power is verified according to applicable versions of 3GPP TS 34.121 and SAR must be measured according to these maximum output conditions. When Maximum Power Reduction (MPR) is not implemented according to Cubic Metric (CM) requirements for Release 6 HSPA, the following procedures do not apply.



**For Release 5 HSDPA Data Devices:**

Sub-test	$\beta_c$	$\beta_d$	$\beta_d$ (SF)	$\beta_c / \beta_d$	$\beta_{hs}$	CM/dB
1	2/15	15/15	64	2/15	4/15	0.0
2	12/15	15/15	64	12/15	24/25	1.0
3	15/15	8/15	64	15/8	30/15	1.5
4	15/15	4/15	64	15/4	30/15	1.5

**For Release 6 HSPA Data Devices**

Sub-test	$\beta_c$	$\beta_d$	$\beta_d$ (SF)	$\beta_c / \beta_d$	$\beta_{hs}$	$\beta_{ec}$	$\beta_{ed}$	$\beta_{ed}$ (SF)	$\beta_{ed}$ (codes)	CM (dB)	MPR (dB)	AG Index	E-TFCI
1	11/15	15/15	64	11/15	22/15	209/225	1039/225	4	1	1.0	0.0	20	75
2	6/15	15/15	64	6/15	12/15	12/15	12/15	4	1	3.0	2.0	12	67
3	15/15	9/15	64	15/9	30/15	30/15	$\beta_{ed1}:47/15$ $\beta_{ed2}:47/15$	4	2	2.0	1.0	15	92
4	2/15	15/15	64	2/15	4/15	4/15	56/75	4	1	3.0	2.0	17	71
5	15/15	15/15	64	15/15	24/15	30/15	134/15	4	1	1.0	0.0	21	81

**9.4 Bluetooth & Wi-Fi Measurement Procedures for SAR**

Normal network operating configurations are not suitable for measuring the SAR of 802.11 transmitters in general. Unpredictable fluctuations in network traffic and antenna diversity conditions can introduce undesirable variations in SAR results. The SAR for these devices should be measured using chipset based test mode software to ensure that the results are consistent and reliable.

Chipset based test mode software is hardware dependent and generally varies among manufacturers. The device operating parameters established in a test mode for SAR measurements must be identical to those programmed in production units, including output power levels, amplifier gain settings and other RF performance tuning parameters. The test frequencies should correspond to actual channel frequencies defined for domestic use. SAR for devices with switched diversity should be measured with only one antenna transmitting at a time during each SAR measurement, according to a fixed modulation and data rate. The same data pattern should be used for all measurements.

**9.5 SAR Measurement for LTE**

SAR tests for LTE are performed with a base station simulator, Anristu MT8820C. Closed loop power control was used so the UE transmits with maximum output power during SAR testing. All powers were measured with the Anristu MT8820C. It is performed for conducted power and SAR based on the KDB941225 D05.

SAR is evaluated separately according to the following procedures for the different test positions in each exposure condition – head, body, body-worn accessories and other use conditions. The

procedures in the following subsections are applied separately to test each LTE frequency band.

1) QPSK with 1 RB allocation

Start with the largest channel bandwidth and measure SAR for QPSK with 1 RB allocation, using the RB offset and required test channel combination with the highest maximum output power among RB offsets at the upper edge, middle and lower edge of each required test channel. When the reported SAR is  $\leq 0.8$  W/kg, testing of the remaining RB offset configurations and required test channels is not required for 1 RB allocation; otherwise, SAR is required for the remaining required test channels and only for the RB offset configuration with the highest output power for that channel. When the reported SAR of a required test channel is  $> 1.45$  W/kg, SAR is required for all three RB offset configurations for that required test channel.

2) QPSK with 50% RB allocation

The procedures required for 1 RB allocation in 1) are applied to measure the SAR for QPSK with 50% RB allocation.

3) QPSK with 100% RB allocation

For QPSK with 100% RB allocation, SAR is not required when the highest maximum output power for 100 % RB allocation is less than the highest maximum output power in 50% and 1 RB allocations and the highest reported SAR for 1 RB and 50% RB allocation in 1) and 2) are  $\leq 0.8$  W/kg. Otherwise, SAR is measured for the highest output power channel; and if the reported SAR is  $> 1.45$  W/kg, the remaining required test channels must also be tested.

## 9.6 Power Drift

To control the output power stability during the SAR test, DASY5 system calculates the power drift by measuring the E-field at the same location at the beginning and at the end of the measurement for each test position. These drift values can be found in Section 14 labeled as: (Power Drift [dB]). This ensures that the power drift during one measurement is within 5%.

## **10 Area Scan Based 1-g SAR**

### **10.1 Requirement of KDB**

According to the KDB447498 D01, when the implementation is based the specific polynomial fit algorithm as presented at the 29th Bioelectromagnetics Society meeting (2007) and the estimated 1-gSAR is  $\leq 1.2$  W/kg, a zoom scan measurement is not required provided it is also not needed for any other purpose; for example, if the peak SAR location required for simultaneous transmission SAR test exclusion can be determined accurately by the SAR system or manually to discriminate between distinctive peaks and scattered noisy SAR distributions from area scans.

There must not be any warning or alert messages due to various measurement concerns identified by the SAR system; for example, noise in measurements, peaks too close to scan boundary, peaks are too sharp, spatial resolution and uncertainty issues etc. The SAR system verification must also demonstrate that the area scan estimated 1-g SAR is within 3% of the zoom scan 1-g SAR (See Annex B). When all the SAR results for each exposure condition in a frequency band and wireless mode are based on estimated 1-g SAR, the 1-g SAR for the highest SAR configuration must be determined by a zoom scan.

### **10.2 Fast SAR Algorithms**

The approach is based on the area scan measurement applying a frequency dependent attenuation parameter. This attenuation parameter was empirically determined by analyzing a large number of phones. The MOTOROLA FAST SAR was developed and validated by the MOTOROLA Research Group in Ft. Lauderdale.

In the initial study, an approximation algorithm based on Linear fit was developed. The accuracy of the algorithm has been demonstrated across a broad frequency range (136-2450 MHz) and for both 1- and 10-g averaged SAR using a sample of 264 SAR measurements from 55 wireless handsets. For the sample size studied, the root-mean-squared errors of the algorithm are 1.2% and 5.8% for 1- and 10-g averaged SAR, respectively. The paper describing the algorithm in detail is expected to be published in August 2004 within the Special Issue of Transactions on MTT.

In the second step, the same research group optimized the fitting algorithm to an Polynomial fit whereby the frequency validity was extended to cover the range 30-6000MHz. Details of this study can be found in the BEMS 2007 Proceedings.

Both algorithms are implemented in DASY software.

## 11 Conducted Output Power

### 11.1 Manufacturing tolerance

**Table 11.1: GSM Speech**

GSM 850			
Channel	Channel 251	Channel 190	Channel 128
Target (dBm)	32.5	32.5	32.5
Tolerance $\pm$ (dB)	1	1	1
GSM 1900			
Channel	Channel 810	Channel 661	Channel 512
Target (dBm)	30	30	30
Tolerance $\pm$ (dB)	1	1	1

**Table 11.2: GPRS & EGPRS (AP OFF)**

GSM 850 GPRS				
Channel		251	190	128
1Txslot	Target (dBm)	32.5	32.5	32.5
	Tolerance $\pm$ (dB)	1	1	1
2Txslots	Target (dBm)	29.5	29.5	29.5
	Tolerance $\pm$ (dB)	1	1	1
3Txslots	Target (dBm)	27	27	27
	Tolerance $\pm$ (dB)	1	1	1
4Txslots	Target (dBm)	26	26	26
	Tolerance $\pm$ (dB)	1	1	1
GSM 850 EGPRS (GMSK)				
Channel		251	190	128
1Txslot	Target (dBm)	32	32	32
	Tolerance $\pm$ (dB)	1	1	1
2Txslots	Target (dBm)	28.5	28.5	28.5
	Tolerance $\pm$ (dB)	1	1	1
3Txslots	Target (dBm)	26.5	26.5	26.5
	Tolerance $\pm$ (dB)	1	1	1
4Txslots	Target (dBm)	25.5	25.5	25.5
	Tolerance $\pm$ (dB)	1	1	1
GSM 850 EGPRS (8PSK)				
Channel		251	190	128
1Txslot	Target (dBm)	29.5	30	30.5
	Tolerance $\pm$ (dB)	1	1	1
2Txslots	Target (dBm)	27	27	27
	Tolerance $\pm$ (dB)	1	1	1
3Txslots	Target (dBm)	24.5	25	25
	Tolerance $\pm$ (dB)	1	1	1

4Txslots	Target (dBm)	23.5	23.5	23.5
	Tolerance $\pm$ (dB)	1	1	1

GSM 1900 GPRS				
Channel		810	661	512
1Txslot	Target (dBm)	30	30	30
	Tolerance $\pm$ (dB)	1	1	1
2Txslots	Target (dBm)	27	27	27
	Tolerance $\pm$ (dB)	1	1	1
3Txslots	Target (dBm)	24.5	24.5	25
	Tolerance $\pm$ (dB)	1	1	1
4Txslots	Target (dBm)	23.5	23.5	23.5
	Tolerance $\pm$ (dB)	1	1	1
GSM 1900 EGPRS (GMSK)				
Channel		810	661	512
1Txslot	Target (dBm)	29	29	29
	Tolerance $\pm$ (dB)	1	1	1
2Txslots	Target (dBm)	26	26	26
	Tolerance $\pm$ (dB)	1	1	1
3Txslots	Target (dBm)	23.5	24	24
	Tolerance $\pm$ (dB)	1	1	1
4Txslots	Target (dBm)	23	23	23
	Tolerance $\pm$ (dB)	1	1	1
GSM 1900 EGPRS (8PSK)				
Channel		810	661	512
1Txslot	Target (dBm)	24.5	24.5	24.5
	Tolerance $\pm$ (dB)	1	1	1
2Txslots	Target (dBm)	21.5	21.5	21.5
	Tolerance $\pm$ (dB)	1	1	1
3Txslots	Target (dBm)	19.5	19.5	19.5
	Tolerance $\pm$ (dB)	1	1	1
4Txslots	Target (dBm)	18.5	18.5	18.5
	Tolerance $\pm$ (dB)	1	1	1

**Table 11.3: WCDMA**

UMTS Band V		Conducted Power (dBm)		
		Channel 4233	Channel 4182	Channel 4132
CS	Target (dBm)	23.3	23.3	23.3
	Tolerance $\pm$ (dB)	0.7	0.7	0.7
HSUPA sub-test 1	Target (dBm)	22.5	22.5	22.5
	Tolerance $\pm$ (dB)	1	1	1
HSUPA sub-test 2	Target (dBm)	22	22	22
	Tolerance $\pm$ (dB)	1	1	1
HSUPA sub-test 3	Target (dBm)	21.5	22	22
	Tolerance $\pm$ (dB)	1	1	1
HSUPA sub-test 4	Target (dBm)	22	22.5	22
	Tolerance $\pm$ (dB)	1	1	1
HSUPA sub-test 5	Target (dBm)	23	23	23
	Tolerance $\pm$ (dB)	1	1	1
HSDPA sub-test 1-4	Target (dBm)	23	23	23
	Tolerance $\pm$ (dB)	1	1	1
UMTS Band IV		Conducted Power(dBm)		
		Channel 1513	Channel 1413	Channel 1312
CS	Target (dBm)	24.5	24.5	24.5
	Tolerance $\pm$ (dB)	0.7	0.7	0.7
HSUPA sub-test 1	Target (dBm)	22.5	22	22
	Tolerance $\pm$ (dB)	1	1	1
HSUPA sub-test 2	Target (dBm)	21	21	21
	Tolerance $\pm$ (dB)	1	1	1
HSUPA sub-test 3	Target (dBm)	21	21	21
	Tolerance $\pm$ (dB)	1	1	1
HSUPA sub-test 4	Target (dBm)	22	22	22
	Tolerance $\pm$ (dB)	1	1	1
HSUPA sub-test 5	Target (dBm)	22.5	22.5	22.5
	Tolerance $\pm$ (dB)	1	1	1
HSDPA sub-test 1-4	Target (dBm)	22.5	22.5	22.5
	Tolerance $\pm$ (dB)	1	1	1

UMTS Band II		Conducted Power(dBm)		
		Channel 9538	Channel 9400	Channel 9262
CS	Target (dBm)	23.5	23.5	23.5
	Tolerance $\pm$ (dB)	0.7	0.7	0.7
HSUPA sub-test 1	Target (dBm)	22	22	22
	Tolerance $\pm$ (dB)	1	1	1
HSUPA sub-test 2	Target (dBm)	21	21	21
	Tolerance $\pm$ (dB)	1	1	1
HSUPA sub-test 3	Target (dBm)	20.5	20.5	20.5
	Tolerance $\pm$ (dB)	1	1	1
HSUPA sub-test 4	Target (dBm)	21.5	21.5	21.5
	Tolerance $\pm$ (dB)	1	1	1
HSUPA sub-test 5	Target (dBm)	22	22	22
	Tolerance $\pm$ (dB)	1	1	1
HSDPA sub-test 1-4	Target (dBm)	22	22	22
	Tolerance $\pm$ (dB)	1	1	1

**Table 11.4: LTE**

LTE Band 2 QPSK			
Channel	Channel 19100	Channel 18900	Channel 18700
Target (dBm)	23	23	23
Tolerance $\pm$ (dB)	1	1	1
LTE Band 4 QPSK			
Channel	Channel 20300	Channel 20175	Channel 20050
Target (dBm)	23	23	23
Tolerance $\pm$ (dB)	1	1	1
LTE Band 5 QPSK			
Channel	Channel 20600	Channel 20525	Channel 20450
Target (dBm)	23	23	23
Tolerance $\pm$ (dB)	1	1	1
LTE Band 12 QPSK			
Channel	Channel 23130	Channel 23095	Channel 23060
Target (dBm)	23	23	23
Tolerance $\pm$ (dB)	1	1	1

LTE Band 2 16QAM			
Channel	Channel 19100	Channel 18900	Channel 18700
Target (dBm)	22	22	22
Tolerance $\pm$ (dB)	1	1	1
LTE Band 4 16QAM			
Channel	Channel 20300	Channel 20175	Channel 20050
Target (dBm)	22	22	22
Tolerance $\pm$ (dB)	1	1	1
LTE Band 5 16QAM			
Channel	Channel 20600	Channel 20525	Channel 20450
Target (dBm)	22.8	22.8	22.8
Tolerance $\pm$ (dB)	1	1	1
LTE Band 12 16QAM			
Channel	Channel 23130	Channel 23095	Channel 23060
Target (dBm)	22.8	22.8	22.8
Tolerance $\pm$ (dB)	1	1	1

LTE Band 2 64QAM			
Channel	Channel 19100	Channel 18900	Channel 18700
Target (dBm)	22	22	22
Tolerance $\pm$ (dB)	1	1	1
LTE Band 4 16QAM			
Channel	Channel 20300	Channel 20175	Channel 20050
Target (dBm)	21.8	21.8	21.8
Tolerance $\pm$ (dB)	1	1	1
LTE Band 5 64QAM			
Channel	Channel 20600	Channel 20525	Channel 20450
Target (dBm)	22.8	22.8	22.8
Tolerance $\pm$ (dB)	1	1	1
LTE Band 12 64QAM			
Channel	Channel 23130	Channel 23095	Channel 23060
Target (dBm)	22.8	22.8	22.8
Tolerance $\pm$ (dB)	1	1	1



**Table 11.5: Bluetooth**

Mode		2402MHz (Ch0)	2441MHz (Ch39)	2480MHz (Ch78)
GFSK	Target (dBm)	-0.5	0	-1.5
	Tolerance $\pm$ (dB)	1	1	1
EDR2M-4_DQPSK	Target (dBm)	0	0.5	-0.5
	Tolerance $\pm$ (dB)	1	1	1
EDR3M-8DPSK	Target (dBm)	0	0.5	-0.5
	Tolerance $\pm$ (dB)	1	1	1
GFSK(BLE)	Target (dBm)	-0.5	0	-1.5
	Tolerance $\pm$ (dB)	1	1	1

**Table 11.6: Wi-Fi**

Mode	Channel/Data rate	Target (dBm)	Tolerance $\pm$ (dB)
802.11 b (2.4GHz)	1Mbps	17	1
	2Mbps	17	1
	5.5Mbps	17	1
	11Mbps	17	1
802.11 g (2.4GHz)	6-9Mbps	17	1
	12-24Mbps	16.5	1
	36-48Mbps	16	1
	54Mbps	15	1
802.11 n (2.4GHz HT20)	MCS0	16.5	1
	MCS1	16	1
	MCS2	15.5	1
	MCS3- MCS5	15	1
	MCS6- MCS7	14.5	1

**Table 11.7: GSM1900 (AP ON)**

GSM 1900 GPRS				
Channel		810	661	512
1Txslot	Target (dBm)	26.5	26.5	26.5
	Tolerance $\pm$ (dB)	1	1	1
2Txslots	Target (dBm)	26.5	26.5	26.5
	Tolerance $\pm$ (dB)	1	1	1
3Txslots	Target (dBm)	24.5	24.5	25
	Tolerance $\pm$ (dB)	1	1	1
4Txslots	Target (dBm)	23.5	23.5	23.5
	Tolerance $\pm$ (dB)	1	1	1
GSM 1900 EGPRS (GMSK)				
Channel		810	661	512
1Txslot	Target (dBm)	26.5	26.5	26.5
	Tolerance $\pm$ (dB)	1	1	1
2Txslots	Target (dBm)	26	26.5	26.5
	Tolerance $\pm$ (dB)	1	1	1
3Txslots	Target (dBm)	24	24.5	24.5
	Tolerance $\pm$ (dB)	1	1	1
4Txslots	Target (dBm)	23.5	23.5	23.5
	Tolerance $\pm$ (dB)	1	1	1
GSM 1900 EGPRS (8PSK)				
Channel		810	661	512
1Txslot	Target (dBm)	25.5	25.5	26
	Tolerance $\pm$ (dB)	1	1	1
2Txslots	Target (dBm)	23	23	23
	Tolerance $\pm$ (dB)	1	1	1
3Txslots	Target (dBm)	21	21	21
	Tolerance $\pm$ (dB)	1	1	1
4Txslots	Target (dBm)	20	20	20
	Tolerance $\pm$ (dB)	1	1	1

**Table 11.8: WCDMA1700/1900 (AP ON)**

UMTS Band II		Conducted Power(dBm)		
		Channel 9538	9400	Channel 9262
CS	Target (dBm)	21	21	21
	Tolerance $\pm$ (dB)	0.7	0.7	0.7
UMTS Band IV		Conducted Power(dBm)		
		Channel 1513	Channel 1413	Channel 1312
CS	Target (dBm)	21.5	21.5	21.5
	Tolerance $\pm$ (dB)	0.7	0.7	0.7

**Table 11.9: LTE-Band 2/4 (AP ON)**

LTE Band 2		Conducted Power (dBm)		
		High	Middle	Low
QPSK	Target (dBm)	21.5	21.5	21.5
	Tolerance $\pm$ (dB)	1	1	1
16QAM	Target (dBm)	21.3	21.3	21.3
	Tolerance $\pm$ (dB)	1	1	1
64QAM	Target (dBm)	21	21	21
	Tolerance $\pm$ (dB)	1	1	1
LTE Band 4		Conducted Power (dBm)		
		High	Middle	Low
QPSK	Target (dBm)	23	23	23
	Tolerance $\pm$ (dB)	1	1	1
16QAM	Target (dBm)	22	22	22
	Tolerance $\pm$ (dB)	1	1	1
64QAM	Target (dBm)	21.8	21.8	21.8
	Tolerance $\pm$ (dB)	1	1	1

## 11.2 Hotspot

The conducted power is normal for all bands except PCS1900, WCDMA1700, WCDMA1900, LTE band 2 and LTE band 4. There is power reduction enabled for PCS1900, WCDMA1700, WCDMA1900, LTE band 2 and LTE band 4. The power reduction is enabled when the user enables hotspot mode via the manufacturer software. The tables below show the measured powers with hotspot.

**Table 11.10: The conducted power measurement results for GSM1900**

GSM 1900MHz	Conducted Power (dBm)		
	Channel 810(1909.8MHz)	Channel 661(1880MHz)	Channel 512(1850.2MHz)
	26.26	26.69	26.85

**Table 11.11: The conducted power measurement results for GPRS and EGPRS**

GSM 1900		Measured Power (dBm)			calculation	Average Power (dBm)		
		810	661	512		810	661	512
GPRS	1Txslots	26.19	26.65	26.84	-9.03dB	17.16	17.62	17.81
	2Txslots	26.04	26.56	26.78	-6.02dB	20.02	20.54	20.76
	3Txslots	24.08	24.74	24.99	-4.26dB	19.82	20.48	20.73
	4Txslots	23.59	23.58	23.80	-3.01dB	<b>20.58</b>	<b>20.57</b>	<b>20.79</b>
EGPRS (GMSK)	1Txslots	26.28	26.60	26.67	-9.03dB	17.25	17.57	17.64
	2Txslots	26.11	26.34	26.46	-6.02dB	20.09	20.32	20.44
	3Txslots	24.00	24.62	24.75	-4.26dB	19.74	20.36	20.49
	4Txslots	23.49	23.39	23.52	-3.01dB	<b>20.48</b>	<b>20.38</b>	<b>20.51</b>
EGPRS (8PSK)	1Txslots	25.55	25.78	25.96	-9.03dB	16.52	16.75	16.93
	2Txslots	22.99	23.27	23.43	-6.02dB	16.97	17.25	17.41
	3Txslots	20.91	21.20	21.35	-4.26dB	16.65	16.94	17.09
	4Txslots	19.75	20.02	20.25	-3.01dB	16.74	17.01	17.24

NOTES:

1) Division Factors

To average the power, the division factor is as follows:

1TX-slot = 1 transmit time slot out of 8 time slots=> conducted power divided by (8/1) => -9.03dB

2TX-slots = 2 transmit time slots out of 8 time slots=> conducted power divided by (8/2) => -6.02dB

3TX-slots = 3 transmit time slots out of 8 time slots=> conducted power divided by (8/3) => -4.26dB

4TX-slots = 4 transmit time slots out of 8 time slots=> conducted power divided by (8/4) => -3.01dB

**According to the conducted power as above, the body measurements are performed with 4Txslot for GPRS and EGPRS.**

**Table 11.12: The conducted Power for WCDMA**

Item	band	FDD IV result		
	ARFCN	1513 (1752.6MHz)	1412 (1732.4MHz)	1312 (1712.4MHz)
<b>WCDMA</b>	\	<b>21.90</b>	<b>21.80</b>	<b>21.80</b>
Item	band	FDD II result		
	ARFCN	9538 (1907.6MHz)	9400 (1880MHz)	9262 (1852.4MHz)
<b>WCDMA</b>	\	<b>21.10</b>	<b>20.90</b>	<b>20.90</b>

Table 11.13: The conducted Power for LTE

LTE-FDD Band 2				Actual output Power (dBm)			
Band-width	RB allocation	RB offset	Modulation	High	Middle	Low	
1.4 MHz				<b>1909.3MHz</b>	<b>1880MHz</b>	<b>1850.7MHz</b>	
	1RB	High	QPSK	21.39	21.31	21.34	
			16QAM	21.05	21.02	21.20	
			64QAM	20.78	20.69	20.99	
		Middle	QPSK	21.44	21.49	21.31	
			16QAM	21.04	21.15	21.15	
			64QAM	20.89	20.95	20.94	
		Low	QPSK	21.29	21.46	21.37	
			16QAM	20.95	21.13	21.05	
			64QAM	20.66	20.73	20.68	
	3RB	High	QPSK	21.50	21.48	21.54	
			16QAM	21.56	21.31	21.34	
			64QAM	21.44	21.17	21.00	
		Middle	QPSK	21.55	21.51	21.50	
			16QAM	21.55	21.35	21.45	
			64QAM	21.05	21.11	21.10	
		Low	QPSK	21.51	21.46	21.43	
			16QAM	21.42	21.30	21.38	
			64QAM	21.23	21.03	21.08	
	6RB	/	QPSK	21.47	21.33	21.43	
			16QAM	21.29	21.10	21.28	
			64QAM	20.98	20.95	21.09	
	3 MHz				<b>1908.5MHz</b>	<b>1880MHz</b>	<b>1851.5MHz</b>
		1RB	High	QPSK	21.41	21.48	21.49
				16QAM	21.05	20.98	21.33
				64QAM	20.79	20.76	21.04
			Middle	QPSK	21.55	21.63	21.36
16QAM				21.25	21.25	21.42	
64QAM				21.03	21.11	21.20	
Low			QPSK	21.56	21.42	21.35	
			16QAM	20.93	21.12	21.04	
			64QAM	20.77	20.88	20.62	
8RB		High	QPSK	21.56	21.52	21.48	
			16QAM	21.70	21.47	21.57	
			64QAM	21.28	21.10	21.36	
		Middle	QPSK	21.48	21.55	21.52	
			16QAM	21.65	21.54	21.51	
			64QAM	21.35	21.39	21.40	
Low		QPSK	21.56	21.52	21.50		

	15RB	/	16QAM	21.61	21.43	21.45
			64QAM	21.45	21.03	21.31
			QPSK	21.53	21.52	21.48
			16QAM	21.41	21.21	21.54
			64QAM	21.19	21.09	21.37
5 MHz				<b>1907.5MHz</b>	<b>1880MHz</b>	<b>1852.5MHz</b>
	1RB	High	QPSK	21.11	21.38	21.19
			16QAM	21.49	20.89	21.12
			64QAM	21.14	20.75	20.79
		Middle	QPSK	21.50	21.52	21.47
			16QAM	21.17	21.31	21.52
			64QAM	20.79	20.87	20.88
		Low	QPSK	21.39	21.46	21.23
			16QAM	21.08	21.06	21.28
			64QAM	20.86	20.88	20.93
	12RB	High	QPSK	21.47	21.46	21.44
			16QAM	21.44	21.46	21.32
			64QAM	21.07	21.06	21.09
		Middle	QPSK	21.50	21.49	21.48
			16QAM	21.43	21.54	21.34
			64QAM	21.02	21.13	20.96
		Low	QPSK	21.41	21.45	21.48
			16QAM	21.24	21.44	21.38
			64QAM	20.07	21.13	20.99
	25RB	/	QPSK	21.44	21.46	21.47
			16QAM	21.52	21.50	21.44
			64QAM	21.14	21.09	21.05

LTE-FDD Band 2				Actual output Power (dBm)					
10 MHz	1RB	High	QPSK	1905MHz	1880MHz	1855MHz			
			16QAM	21.56	21.41	21.34			
			64QAM	21.26	20.93	21.22			
			64QAM	20.99	20.69	20.88			
	1RB	Middle	QPSK	21.57	21.61	21.40			
				16QAM	21.44	21.23	21.34		
				64QAM	21.01	20.93	20.98		
	1RB	Low	QPSK	21.55	21.58	21.37			
				16QAM	21.30	21.22	21.18		
				64QAM	20.94	20.80	20.86		
10 MHz	25RB	High	QPSK	21.59	21.46	21.53			
				16QAM	21.56	21.51	21.58		
				64QAM	21.37	21.26	21.34		
			Middle	QPSK	21.62	21.58	21.53		
					16QAM	21.64	21.54	21.49	
					64QAM	21.22	21.17	21.29	
		25RB	Low	QPSK	21.61	21.56	21.59		
					16QAM	21.56	21.69	21.51	
					64QAM	21.34	21.20	21.10	
		50RB	/	QPSK	21.54	21.46	21.56		
					16QAM	21.65	21.58	21.52	
					64QAM	21.14	21.21	21.09	
15 MHz				1902.5MHz	1880MHz	1857.5MHz			
	1RB	High	QPSK	21.57	21.72	21.57			
			16QAM	20.96	21.80	21.36			
			64QAM	20.78	21.06	20.86			
		1RB	Middle	QPSK	21.68	21.48	21.64		
					16QAM	21.36	21.39	21.10	
					64QAM	21.03	21.09	21.00	
		1RB	Low	QPSK	21.69	21.48	21.56		
					16QAM	21.47	21.37	20.86	
					64QAM	21.14	21.07	20.87	
15 MHz	36RB	High	QPSK	21.67	21.66	21.69			
				16QAM	21.86	21.69	21.49		
				64QAM	21.68	21.59	21.44		
			36RB	Middle	QPSK	21.73	21.65	21.61	
						16QAM	21.65	21.49	21.47
						64QAM	21.55	21.33	21.09
		36RB	Low	QPSK	21.68	21.67	21.64		
					16QAM	21.62	21.63	21.68	
					64QAM	21.35	21.34	21.55	

	75RB	/	QPSK	21.73	21.73	21.67
16QAM			21.68	21.61	21.72	
64QAM			21.56	21.45	21.55	
20 MHz				<b>1900MHz</b>	<b>1880MHz</b>	<b>1860MHz</b>
	1RB	High	QPSK	21.24	21.50	21.40
			16QAM	21.14	21.06	21.11
			64QAM	20.97	20.88	20.85
		Middle	QPSK	21.55	<b>21.64</b>	21.61
			16QAM	21.87	21.42	21.34
			64QAM	21.34	21.35	21.47
		Low	QPSK	21.28	21.60	21.63
			16QAM	21.16	21.40	21.30
			64QAM	20.78	20.84	21.14
	50RB	High	QPSK	21.54	21.54	21.53
			16QAM	21.51	21.47	21.47
			64QAM	21.48	21.39	21.45
		Middle	QPSK	21.58	21.52	21.53
			16QAM	21.46	21.61	21.57
			64QAM	21.49	21.42	21.47
		Low	QPSK	<b>21.64</b>	21.52	21.55
			16QAM	21.52	21.60	21.56
			64QAM	21.55	21.60	21.45
	100RB	/	QPSK	21.48	21.46	<b>21.49</b>
			16QAM	21.55	21.55	21.55
			64QAM	21.32	21.53	21.24



LTE-FDD Band 4				Actual output Power (dBm)			
Band-width	RB allocation	RB offset	Modulation	High	Middle	Low	
1.4 MHz				<b>1754.3MHz</b>	<b>1732.5MHz</b>	<b>1710.7MHz</b>	
	1RB	High	QPSK	23.19	23.33	23.45	
			16QAM	22.10	22.02	22.14	
			64QAM	21.40	21.68	21.80	
		Middle	QPSK	23.32	23.39	23.40	
			16QAM	22.11	22.19	22.20	
			64QAM	21.98	22.09	22.03	
		Low	QPSK	23.25	23.47	23.42	
			16QAM	22.00	22.01	21.89	
			64QAM	21.75	21.83	21.42	
	3RB	High	QPSK	23.52	23.64	23.63	
			16QAM	22.28	22.33	22.45	
			64QAM	22.06	22.17	22.39	
		Middle	QPSK	23.49	23.60	23.68	
			16QAM	22.44	22.46	22.45	
			64QAM	22.19	22.31	22.07	
		Low	QPSK	23.41	23.68	23.68	
			16QAM	22.38	22.43	22.45	
			64QAM	22.32	22.21	22.07	
	6RB	/	QPSK	22.35	22.46	22.54	
			16QAM	21.40	21.45	21.30	
			64QAM	21.02	21.14	21.27	
	3 MHz				<b>1753.5MHz</b>	<b>1732.5MHz</b>	<b>1711.5MHz</b>
		1RB	High	QPSK	23.29	23.43	23.50
				16QAM	22.13	21.91	21.90
				64QAM	21.67	21.06	21.48
			Middle	QPSK	23.27	23.39	23.56
16QAM				22.25	22.23	22.13	
64QAM				22.14	22.02	21.96	
Low			QPSK	23.11	23.39	23.54	
			16QAM	21.93	22.19	22.24	
			64QAM	21.69	21.82	21.89	
8RB		High	QPSK	22.43	22.54	22.56	
			16QAM	21.43	21.53	21.59	
			64QAM	21.30	21.28	20.99	
		Middle	QPSK	22.48	22.52	22.55	
			16QAM	21.49	21.59	21.62	
			64QAM	21.06	21.24	21.34	
		Low	QPSK	22.35	22.56	22.60	
			16QAM	21.48	21.57	21.58	

			64QAM	21.31	21.28	21.33
	15RB	/	QPSK	22.43	22.51	22.58
			16QAM	21.42	21.52	21.49
			64QAM	21.40	21.29	21.22
				<b>1752.5MHz</b>	<b>1732.5MHz</b>	<b>1712.5MHz</b>
5 MHz	1RB	High	QPSK	23.30	23.37	23.35
			16QAM	22.23	21.94	21.92
			64QAM	22.09	21.76	21.52
		Middle	QPSK	23.43	23.36	23.36
			16QAM	22.25	22.23	21.96
			64QAM	22.10	22.05	21.89
		Low	QPSK	23.41	23.31	23.42
			16QAM	21.88	21.72	21.96
			64QAM	21.65	21.50	21.49
	12RB	High	QPSK	22.53	22.43	22.52
			16QAM	21.26	21.28	21.27
			64QAM	21.06	21.16	21.04
		Middle	QPSK	22.50	22.52	22.46
			16QAM	21.32	21.40	21.50
			64QAM	21.08	21.22	21.07
		Low	QPSK	22.46	22.42	22.52
			16QAM	21.40	21.37	21.48
			64QAM	21.04	21.00	21.22
	25RB	/	QPSK	22.45	22.51	22.58
			16QAM	21.45	21.43	21.58
			64QAM	21.08	21.22	21.45

LTE-FDD Band 4				Actual output Power (dBm)		
10 MHz				1750MHz	1732.5MHz	1715MHz
	10 MHz	1RB	High	QPSK	23.56	23.43
16QAM				22.24	22.24	22.25
64QAM				22.04	22.06	22.19
Middle			QPSK	23.56	23.49	23.50
			16QAM	22.27	22.25	22.11
			64QAM	22.01	22.03	21.90
Low			QPSK	23.64	23.51	23.65
			16QAM	22.43	22.32	22.21
			64QAM	22.24	22.19	22.14
25RB		High	QPSK	22.50	22.41	22.54
			16QAM	21.53	21.31	21.50
			64QAM	21.26	21.08	21.38
		Middle	QPSK	22.50	22.50	22.59
			16QAM	21.51	21.46	21.55
			64QAM	21.21	21.32	21.18
		Low	QPSK	22.50	22.51	22.41
			16QAM	21.44	21.42	21.43
			64QAM	21.04	21.06	21.22
50RB		/	QPSK	22.55	22.58	22.52
			16QAM	21.57	21.46	21.54
			64QAM	21.37	21.38	21.42
15 MHz				1747.5MHz	1732.5MHz	1717.5MHz
	1RB	High	QPSK	23.44	23.35	23.57
			16QAM	21.90	22.48	22.24
			64QAM	21.13	21.48	21.77
		Middle	QPSK	23.44	23.59	23.59
			16QAM	22.34	22.16	22.24
			64QAM	22.35	22.09	22.14
		Low	QPSK	23.44	23.53	23.63
			16QAM	22.37	22.25	21.88
			64QAM	22.19	22.05	21.80
	36RB	High	QPSK	23.54	23.47	23.57
			16QAM	22.73	22.53	22.59
			64QAM	22.37	22.30	22.19
		Middle	QPSK	23.66	23.57	23.38
			16QAM	22.54	22.49	22.41
			64QAM	22.34	22.10	22.09
		Low	QPSK	23.67	23.56	23.58
			16QAM	22.57	22.41	22.50
			64QAM	22.05	22.00	22.13

	75RB	/	QPSK	22.78	22.57	22.54
			16QAM	21.63	21.47	21.58
			64QAM	21.30	21.09	21.32
20 MHz				<b>1745MHz</b>	<b>1732.5MHz</b>	<b>1720MHz</b>
	1RB	High	QPSK	22.50	22.36	22.51
			16QAM	22.22	22.68	21.99
			64QAM	21.81	21.99	21.61
		Middle	QPSK	<b>22.64</b>	22.58	22.55
			16QAM	22.25	22.62	22.17
			64QAM	22.34	22.33	21.98
		Low	QPSK	22.58	22.49	22.39
			16QAM	22.34	21.74	22.25
			64QAM	22.20	22.31	22.10
	50RB	High	QPSK	22.40	22.40	22.44
			16QAM	21.40	21.47	21.45
			64QAM	21.43	21.40	21.38
		Middle	QPSK	22.51	22.51	22.54
			16QAM	21.53	21.56	21.48
			64QAM	21.41	21.40	21.52
		Low	QPSK	<b>22.70</b>	22.49	22.44
			16QAM	21.63	21.46	21.45
			64QAM	21.55	21.43	21.46
	100RB	/	QPSK	<b>22.54</b>	22.45	22.51
			16QAM	21.48	21.42	21.35
			64QAM	21.48	21.21	21.36

### 11.3 GSM Measurement result

During the process of testing, the EUT was controlled via Agilent Digital Radio Communication tester (E5515C) to ensure the maximum power transmission and proper modulation. This result contains conducted output power for the EUT. In all cases, the measured peak output power should be greater and within 5% than EMI measurement.

**Table 11.14: The conducted power measurement results for GSM850/1900**

GSM 850MHz	Conducted Power (dBm)		
	Channel 251(848.8MHz)	Channel 190(836.6MHz)	Channel 128(824.2MHz)
	32.54	32.93	32.80
GSM 1900MHz	Conducted Power(dBm)		
	Channel 810(1909.8MHz)	Channel 661(1880MHz)	Channel 512(1850.2MHz)
	29.62	30.08	30.48

**Table 11.15: The conducted power measurement results for GPRS and EGPRS**

GSM 850		Measured Power (dBm)			calculation	Average Power (dBm)		
		251	190	128		251	190	128
GPRS	1Txslots	32.51	32.88	32.77	-9.03dB	<b>23.48</b>	<b>23.85</b>	<b>23.74</b>
	2Txslots	29.30	29.16	29.25	-6.02dB	23.28	23.14	23.23
	3Txslots	27.09	27.00	27.06	-4.26dB	22.83	22.74	22.8
	4Txslots	26.09	26.03	26.35	-3.01dB	23.08	23.02	23.34
EGPRS (GMSK)	1Txslots	32.51	32.88	32.77	-9.03dB	<b>22.83</b>	<b>23.21</b>	<b>23.13</b>
	2Txslots	29.30	29.16	29.25	-6.02dB	22.59	22.59	22.65
	3Txslots	27.09	27.00	27.06	-4.26dB	22.19	22.16	22.21
	4Txslots	26.09	26.03	26.35	-3.01dB	22.45	22.43	22.73
EGPRS (8PSK)	1Txslots	25.09	25.12	25.11	-9.03dB	16.06	16.09	16.08
	2Txslots	22.01	22.01	21.99	-6.02dB	15.99	15.99	15.97
	3Txslots	20.45	20.35	20.50	-4.26dB	16.19	16.09	16.24
	4Txslots	19.33	19.29	19.46	-3.01dB	16.32	16.28	16.45
GSM 1900		Measured Power (dBm)			calculation	Average Power (dBm)		
		810	661	512		810	661	512
GPRS	1Txslots	29.61	30.05	30.48	-9.03dB	<b>20.58</b>	<b>21.02</b>	<b>21.45</b>
	2Txslots	26.66	26.90	27.13	-6.02dB	20.64	20.88	21.11
	3Txslots	24.03	24.87	25.15	-4.26dB	19.77	20.61	20.89
	4Txslots	23.52	23.57	23.80	-3.01dB	20.51	20.56	20.79
EGPRS (GMSK)	1Txslots	28.95	29.22	29.47	-9.03dB	<b>19.92</b>	<b>20.19</b>	<b>20.44</b>
	2Txslots	25.93	26.06	26.15	-6.02dB	19.91	20.04	20.13
	3Txslots	23.30	24.03	24.17	-4.26dB	19.04	19.77	19.91
	4Txslots	22.76	22.65	22.90	-3.01dB	19.75	19.64	19.89
EGPRS (8PSK)	1Txslots	24.51	24.72	24.94	-9.03dB	15.48	15.69	15.91
	2Txslots	21.40	21.61	21.84	-6.02dB	15.38	15.59	15.82
	3Txslots	19.22	19.43	19.70	-4.26dB	14.96	15.17	15.44
	4Txslots	18.43	18.68	18.77	-3.01dB	15.42	15.67	15.76

NOTES:

1) Division Factors

To average the power, the division factor is as follows:

1TX-slot = 1 transmit time slot out of 8 time slots=> conducted power divided by (8/1) => -9.03dB

2TX-slots = 2 transmit time slots out of 8 time slots=> conducted power divided by (8/2) => -6.02dB

3TX-slots = 3 transmit time slots out of 8 time slots=> conducted power divided by (8/3) => -4.26dB

4TX-slots = 4 transmit time slots out of 8 time slots=> conducted power divided by (8/4) => -3.01dB

**According to the conducted power as above, the body measurements are performed with 1Txslots for GSM 850 and 1Txslots for GSM 1900.**

**11.4 WCDMA Measurement result**

**Table 11.16: The conducted Power for WCDMA850/1700/1900**

Item	band	FDD Band 5 result		
	ARFCN	4233 (846.6MHz)	4182(836.4MHz)	4132 (826.4MHz)
<b>WCDMA</b>	\	<b>23.86</b>	<b>23.84</b>	<b>23.93</b>
<b>HSDPA</b>	1	23.1	23.2	23.2
	2	23.1	23.2	23.3
	3	22.6	22.7	22.7
	4	22.6	22.7	22.6
<b>HSUPA</b>	1	22.5	22.5	22.5
	2	22.0	22.1	21.7
	3	21.6	21.9	22.0
	4	22.4	22.7	22.0
	5	23.0	23.2	23.1
Item	band	FDD Band 4 result		
	ARFCN	1513 (1752.6MHz)	1413(1732.6MHz)	1312 (1712.4MHz)
<b>WCDMA</b>	\	<b>24.86</b>	<b>24.77</b>	<b>24.88</b>
<b>HSDPA</b>	1	22.6	22.5	22.4
	2	22.6	22.5	22.5
	3	22.1	22.0	22.0
	4	22.1	22.2	22.0
<b>HSUPA</b>	1	22.6	21.8	21.7
	2	21.4	21.0	20.9
	3	21.3	21.0	21.0
	4	22.0	22.2	22.0
	5	22.5	22.5	22.5
Item	band	FDD Band 2 result		
	ARFCN	9538 (1907.6MHz)	9400 (1880MHz)	9262 (1852.4MHz)
<b>WCDMA</b>	\	<b>23.69</b>	<b>23.83</b>	<b>23.78</b>
<b>HSDPA</b>	1	22.1	22.1	22.2
	2	22.1	22.2	22.2
	3	21.5	21.6	21.7
	4	21.6	21.6	21.8
<b>HSUPA</b>	1	22.2	22.2	22.2
	2	21.1	21.2	21.3
	3	20.7	20.8	20.7
	4	21.6	21.7	21.7
	5	22.2	22.3	22.2

11.5 LTE-FDD Measurement result

Table 11.17: The conducted Power for LTE-FDD

LTE-FDD Band 2				Actual output Power (dBm)			
Band-width	RB allocation	RB offset	Modulation	High	Middle	Low	
1.4 MHz				<b>1909.3MHz</b>	<b>1880MHz</b>	<b>1850.7MHz</b>	
	1RB	High	QPSK	23.35	23.27	23.41	
			16QAM	22.26	22.41	22.31	
			64QAM	22.02	22.24	22.15	
		Middle	QPSK	23.47	23.45	23.50	
			16QAM	22.33	22.31	22.56	
			64QAM	22.01	22.06	22.33	
		Low	QPSK	23.34	23.48	23.47	
			16QAM	22.22	22.25	22.30	
			64QAM	21.98	22.05	22.11	
	3RB	High	QPSK	23.55	23.48	23.59	
			16QAM	22.48	22.44	22.64	
			64QAM	22.07	22.01	22.46	
		Middle	QPSK	23.63	23.51	23.60	
			16QAM	22.57	22.44	22.62	
			64QAM	22.25	22.17	22.28	
		Low	QPSK	23.53	23.62	23.77	
			16QAM	22.50	22.48	22.58	
			64QAM	22.19	22.09	22.22	
	6RB	/	QPSK	22.58	22.43	22.54	
			16QAM	21.47	21.39	21.45	
			64QAM	21.27	21.02	21.27	
	3 MHz				<b>1908.5MHz</b>	<b>1880MHz</b>	<b>1851.5MHz</b>
		1RB	High	QPSK	23.43	23.55	23.54
16QAM				22.04	22.16	22.28	
64QAM				21.89	21.96	21.99	
Middle			QPSK	23.50	23.72	23.51	
			16QAM	22.39	22.42	22.64	
			64QAM	22.19	22.22	22.25	
Low			QPSK	23.24	23.75	23.60	
			16QAM	22.29	22.33	22.35	
			64QAM	22.16	22.11	22.02	
8RB		High	QPSK	22.60	22.66	22.66	
			16QAM	21.77	21.68	21.59	
			64QAM	21.28	21.29	21.22	
		Middle	QPSK	22.60	22.65	22.67	
			16QAM	21.75	21.66	21.68	
			64QAM	21.51	21.29	21.38	

		Low	QPSK	22.58	22.45	22.64
			16QAM	21.70	21.68	21.62
			64QAM	21.38	21.29	21.39
	15RB	/	QPSK	22.64	22.64	22.62
			16QAM	21.65	21.59	21.41
			64QAM	21.26	21.29	21.25
5 MHz				<b>1907.5MHz</b>	<b>1880MHz</b>	<b>1852.5MHz</b>
	1RB	High	QPSK	23.36	23.41	23.31
			16QAM	22.11	22.33	22.24
			64QAM	21.79	21.96	21.98
		Middle	QPSK	23.36	23.50	23.36
			16QAM	22.21	22.31	22.30
			64QAM	22.08	22.11	22.19
		Low	QPSK	23.31	23.46	23.43
			16QAM	21.98	22.32	22.27
			64QAM	21.79	21.97	22.06
	12RB	High	QPSK	22.55	22.49	22.62
			16QAM	21.54	21.48	21.43
			64QAM	21.33	21.25	21.39
		Middle	QPSK	22.56	22.70	22.57
			16QAM	21.48	21.42	21.39
			64QAM	21.39	21.29	21.11
		Low	QPSK	22.46	22.60	22.57
			16QAM	21.52	21.45	21.51
			64QAM	21.29	21.32	21.38
	25RB	/	QPSK	22.54	22.47	22.54
			16QAM	21.58	21.63	21.55
			64QAM	21.32	21.36	21.09



LTE-FDD Band 2				Actual output Power (dBm)			
				1905MHz	1880MHz	1855MHz	
10 MHz	1RB	High	QPSK	23.25	23.41	23.58	
			16QAM	22.23	22.37	22.23	
			64QAM	22.01	22.04	21.90	
		Middle	QPSK	23.28	23.55	23.60	
			16QAM	22.42	22.44	22.34	
			64QAM	22.31	22.33	22.11	
		Low	QPSK	23.36	23.59	23.63	
			16QAM	22.50	22.29	22.28	
			64QAM	22.18	22.06	22.09	
	25RB	High	QPSK	22.56	22.50	22.62	
			16QAM	21.61	21.49	21.62	
			64QAM	21.36	21.41	21.50	
		Middle	QPSK	22.47	22.63	22.69	
			16QAM	21.67	21.60	21.65	
			64QAM	21.33	21.23	21.20	
		Low	QPSK	22.53	22.59	22.66	
			16QAM	21.59	21.72	21.54	
			64QAM	21.39	21.29	21.48	
	50RB	/	QPSK	22.61	22.58	22.63	
			16QAM	21.73	21.52	21.55	
			64QAM	21.54	21.32	21.13	
	15 MHz				<b>1902.5MHz</b>	<b>1880MHz</b>	<b>1857.5MHz</b>
		1RB	High	QPSK	23.41	23.79	23.64
				16QAM	22.47	22.25	22.94
				64QAM	22.09	21.97	22.68
			Middle	QPSK	23.61	23.61	23.65
				16QAM	22.42	22.35	22.91
64QAM				22.38	22.19	22.68	
Low			QPSK	23.61	23.69	23.42	
			16QAM	22.38	22.41	22.51	
			64QAM	22.18	22.19	22.29	
36RB		High	QPSK	23.78	23.71	23.62	
			16QAM	22.75	22.76	22.62	
			64QAM	22.68	22.49	22.35	
		Middle	QPSK	23.60	23.58	23.63	
			16QAM	22.65	22.72	22.58	
			64QAM	22.54	22.39	22.36	
		Low	QPSK	23.64	23.67	23.62	
			16QAM	22.54	22.76	22.50	
			64QAM	22.30	22.56	22.32	

	75RB	/	QPSK	22.76	22.73	22.69
16QAM			21.73	21.69	21.66	
64QAM			21.31	21.09	21.20	
20 MHz				<b>1900MHz</b>	<b>1880MHz</b>	<b>1860MHz</b>
	1RB	High	QPSK	23.21	23.36	23.27
			16QAM	22.30	22.24	22.24
			64QAM	22.36	21.73	21.98
		Middle	QPSK	23.50	23.43	<b>23.75</b>
			16QAM	22.35	22.80	22.74
			64QAM	22.53	22.43	22.31
		Low	QPSK	23.25	23.56	23.38
			16QAM	22.15	21.97	22.24
			64QAM	21.97	22.09	22.15
	50RB	High	QPSK	22.58	22.51	22.52
			16QAM	21.68	21.58	21.41
			64QAM	21.34	21.36	21.39
		Middle	QPSK	22.58	<b>22.65</b>	22.61
			16QAM	21.62	21.59	21.76
			64QAM	21.37	21.34	21.38
		Low	QPSK	22.63	22.64	22.59
			16QAM	21.59	21.56	21.69
			64QAM	21.41	21.41	21.44
	100RB	/	QPSK	22.49	22.50	<b>22.59</b>
			16QAM	21.60	21.49	21.69
			64QAM	21.24	21.25	21.34

LTE-FDD Band 4				Actual output Power (dBm)			
Band-width	RB allocation	RB offset	Modulation	High	Middle	Low	
1.4 MHz				<b>1754.3MHz</b>	<b>1732.5MHz</b>	<b>1710.7MHz</b>	
	1RB	High	QPSK	23.11	23.32	23.35	
			16QAM	22.04	21.81	22.18	
			64QAM	21.88	21.59	21.79	
		Middle	QPSK	23.19	23.37	23.34	
			16QAM	22.20	22.13	22.06	
			64QAM	22.00	21.90	21.92	
		Low	QPSK	23.16	23.20	23.31	
			16QAM	22.07	21.78	22.23	
			64QAM	21.93	21.64	21.89	
	3RB	High	QPSK	23.40	23.39	23.56	
			16QAM	22.22	22.26	22.33	
			64QAM	22.09	22.01	22.16	
		Middle	QPSK	23.38	23.42	23.59	
			16QAM	22.28	22.37	22.41	
			64QAM	22.07	22.09	22.06	
		Low	QPSK	23.40	23.53	23.46	
			16QAM	22.25	22.35	22.37	
			64QAM	22.17	22.22	22.09	
	6RB	/	QPSK	22.22	22.33	22.43	
			16QAM	21.11	21.32	21.03	
			64QAM	21.02	21.11	20.88	
	3 MHz				<b>1753.5MHz</b>	<b>1732.5MHz</b>	<b>1711.5MHz</b>
		1RB	High	QPSK	23.25	23.35	23.33
				16QAM	22.03	21.83	21.88
				64QAM	21.86	21.36	21.33
			Middle	QPSK	23.11	23.33	23.30
16QAM				22.21	22.17	22.03	
64QAM				21.87	21.95	21.86	
Low			QPSK	23.22	23.19	23.46	
			16QAM	22.21	21.93	21.93	
			64QAM	21.87	21.68	21.56	
8RB		High	QPSK	22.31	22.41	22.40	
			16QAM	21.41	21.52	21.47	
			64QAM	21.09	21.24	21.09	
		Middle	QPSK	22.40	22.44	22.49	
			16QAM	21.48	21.58	21.49	
			64QAM	21.23	21.18	21.26	
		Low	QPSK	22.33	22.49	22.46	
			16QAM	21.37	21.50	21.44	
			64QAM	21.06	21.30	21.02	

	15RB	/	QPSK	22.27	22.49	22.47
16QAM			21.40	21.40	21.51	
64QAM			21.04	21.21	21.47	
5 MHz				<b>1752.5MHz</b>	<b>1732.5MHz</b>	<b>1712.5MHz</b>
	1RB	High	QPSK	23.14	23.39	23.26
			16QAM	22.19	21.80	22.03
			64QAM	21.88	21.64	21.78
		Middle	QPSK	23.49	23.41	23.46
			16QAM	22.27	22.24	22.10
			64QAM	22.17	22.10	22.01
		Low	QPSK	23.40	23.28	23.35
			16QAM	22.23	21.77	22.09
			64QAM	22.01	21.44	21.85
	12RB	High	QPSK	22.50	22.46	22.47
			16QAM	21.44	21.32	21.25
			64QAM	21.13	21.02	21.05
		Middle	QPSK	22.56	22.50	22.46
			16QAM	21.41	21.39	21.34
			64QAM	21.13	21.07	21.00
		Low	QPSK	22.54	22.45	22.55
			16QAM	21.40	21.26	21.42
			64QAM	21.06	21.00	21.13
	25RB	/	QPSK	22.52	22.47	22.60
			16QAM	21.44	21.43	21.47
			64QAM	21.33	21.16	21.32

LTE-FDD Band 4				Actual output Power (dBm)		
				1750MHz	1732.5MHz	1715MHz
10 MHz	1RB	High	QPSK	23.34	23.46	23.44
			16QAM	22.19	22.21	22.23
			64QAM	21.86	21.69	21.88
		Middle	QPSK	23.47	23.56	23.52
			16QAM	22.08	22.37	22.12
			64QAM	21.90	22.10	22.03
		Low	QPSK	23.55	23.41	23.66
			16QAM	22.36	22.11	22.24
			64QAM	21.98	21.79	21.88
	25RB	High	QPSK	22.45	22.51	22.53
			16QAM	21.46	21.38	21.44
			64QAM	21.44	21.20	21.21
		Middle	QPSK	22.58	22.54	22.51
			16QAM	21.54	21.50	21.50
			64QAM	21.25	21.33	21.14
		Low	QPSK	22.52	22.54	22.43
			16QAM	21.40	21.41	21.44
			64QAM	21.03	21.08	21,19
	50RB	/	QPSK	22.53	22.53	22.52
			16QAM	21.40	21.43	21.33
			64QAM	21.07	21.20	21.08
15 MHz				<b>1747.5MHz</b>	<b>1732.5MHz</b>	<b>1717.5MHz</b>
	1RB	High	QPSK	23.55	23.41	23.57
			16QAM	22.79	22.05	22.49
			64QAM	22.49	21.67	22.19
		Middle	QPSK	23.43	23.42	23.43
			16QAM	22.26	22.15	22.21
			64QAM	22.02	21.98	21.98
		Low	QPSK	23.49	23.53	23.64
			16QAM	22.33	22.26	22.30
			64QAM	22.00	22.01	22.03
	36RB	High	QPSK	23.54	23.53	23.63
			16QAM	22.44	22.46	22.63
			64QAM	22.02	22.16	22.19
		Middle	QPSK	23.65	23.42	23.38
			16QAM	22.70	22.42	22.36
			64QAM	22.46	22.10	22.09
		Low	QPSK	23.66	23.50	23.54
			16QAM	22.78	22.32	22.48
			64QAM	22.33	22.09	22.14

	75RB	/	QPSK	22.83	22.58	22.57
			16QAM	21.68	21.47	21.43
			64QAM	21.33	21.23	21.05
				<b>1745MHz</b>	<b>1732.5MHz</b>	<b>1720MHz</b>
20 MHz	1RB	High	QPSK	23.50	23.22	23.30
			16QAM	22.09	22.03	22.20
			64QAM	21.74	22.07	21.83
		Middle	QPSK	23.55	23.38	23.43
			16QAM	22.18	22.20	22.71
			64QAM	22.33	22.22	22.22
		Low	QPSK	23.40	23.43	<b>23.59</b>
			16QAM	22.27	22.18	22.17
			64QAM	21.82	21.70	22.11
	50RB	High	QPSK	22.45	22.37	22.41
			16QAM	21.57	21.27	21.39
			64QAM	21.39	21.24	21.29
		Middle	QPSK	22.50	22.54	22.54
			16QAM	21.58	21.38	21.49
			64QAM	21.48	21.38	21.32
		Low	QPSK	<b>22.67</b>	22.43	22.45
			16QAM	21.67	21.33	21.42
			64QAM	21.49	21.28	21.28
	100RB	/	QPSK	<b>22.52</b>	22.42	22.51
			16QAM	21.52	21.43	21.46
			64QAM	21.33	21.25	21.18

LTE-FDD Band 5				Actual output Power (dBm)			
Band-width	RB allocation	RB offset	Modulation	High	Middle	Low	
1.4 MHz				<b>848.3MHz</b>	<b>836.5MHz</b>	<b>824.7MHz</b>	
	1RB	High	QPSK	22.83	23.10	23.05	
			16QAM	22.73	23.10	23.01	
			64QAM	22.67	22.95	22.89	
		Middle	QPSK	23.04	23.09	23.08	
			16QAM	22.91	22.92	23.21	
			64QAM	22.90	22.77	22.99	
		Low	QPSK	22.91	23.07	23.03	
			16QAM	22.79	22.78	22.95	
			64QAM	22.76	22.58	22.77	
	3RB	High	QPSK	23.17	23.22	23.32	
			16QAM	23.22	23.21	23.14	
			64QAM	23.11	23.09	23.01	
		Middle	QPSK	23.21	23.20	23.24	
			16QAM	23.38	23.29	23.30	
			64QAM	23.06	23.06	23.26	
		Low	QPSK	23.17	23.16	23.19	
			16QAM	23.36	23.27	23.24	
			64QAM	23.16	23.07	21.12	
	6RB	/	QPSK	23.04	23.15	23.12	
			16QAM	22.09	22.16	22.28	
			64QAM	22.07	22.19	22.30	
	3 MHz				<b>847.5MHz</b>	<b>836.5MHz</b>	<b>825.5MHz</b>
		1RB	High	QPSK	23.03	23.03	23.20
				16QAM	22.73	22.75	22.71
				64QAM	22.67	22.57	22.70
			Middle	QPSK	23.05	23.21	23.22
16QAM				23.09	22.89	22.86	
64QAM				23.04	22.76	22.66	
Low			QPSK	23.04	23.14	23.20	
			16QAM	22.70	22.94	22.65	
			64QAM	22.76	22.89	22.63	
8RB		High	QPSK	23.14	23.14	23.26	
			16QAM	22.27	22.32	22.32	
			64QAM	22.06	22.04	22.15	
		Middle	QPSK	23.19	23.19	23.15	
			16QAM	22.26	22.31	22.34	
			64QAM	22.05	22.30	22.20	
		Low	QPSK	23.15	23.18	23.18	
			16QAM	22.24	22.32	22.26	
			64QAM	22.09	22.18	22.16	

	15RB	/	QPSK	23.12	23.19	23.19
16QAM			22.23	22.17	22.20	
64QAM			22.28	22.12	22.18	
5 MHz				<b>846.5MHz</b>	<b>836.5MHz</b>	<b>826.5MHz</b>
	1RB	High	QPSK	22.82	22.95	22.97
			16QAM	22.61	22.51	22.72
			64QAM	22.56	22.56	22.69
		Middle	QPSK	23.12	23.21	23.17
			16QAM	22.90	22.91	23.25
			64QAM	22.68	22.74	22.77
		Low	QPSK	22.93	22.88	23.06
			16QAM	22.95	22.72	22.91
			64QAM	22.34	22.38	22.69
	12RB	High	QPSK	23.07	23.15	23.18
			16QAM	22.07	22.10	22.19
			64QAM	22.09	22.01	22.18
		Middle	QPSK	23.06	23.17	23.24
			16QAM	22.19	22.21	22.22
			64QAM	22.09	22.06	22.13
		Low	QPSK	23.08	23.12	23.05
			16QAM	22.13	22.18	22.05
			64QAM	22.02	22.19	22.07
	25RB	/	QPSK	23.06	23.22	23.18
			16QAM	22.07	22.33	22.19
			64QAM	22.18	22.19	22.13



LTE-FDD Band 5				Actual output Power (dBm)		
				844MHz	836.5MHz	829MHz
	10 MHz	1RB	High	QPSK	22.93	23.16
16QAM				22.53	22.69	22.81
64QAM				22.87	22.79	22.67
Middle			QPSK	<b>23.28</b>	23.16	22.98
			16QAM	23.18	23.27	23.00
			64QAM	23.01	23.14	22.97
Low			QPSK	23.00	22.89	23.00
			16QAM	22.47	22.64	22.78
			64QAM	22.33	22.80	22.84
25RB		High	QPSK	23.06	23.16	23.30
			16QAM	22.22	22.23	22.25
			64QAM	22.14	22.13	22.26
		Middle	QPSK	23.20	23.23	<b>23.33</b>
			16QAM	22.28	22.34	22.38
			64QAM	22.10	22.19	22.28
		Low	QPSK	23.12	23.18	23.25
			16QAM	22.19	22.21	22.31
			64QAM	22.14	22.30	22.16
50RB		/	QPSK	23.06	23.20	<b>23.32</b>
			16QAM	22.15	22.33	22.34
			64QAM	22.20	22.24	22.13

LTE-FDD Band 12				Actual output Power (dBm)			
Band-width	RB allocation	RB offset	Modulation	High	Middle	Low	
1.4 MHz				<b>715.3MHz</b>	<b>707.5MHz</b>	<b>699.7MHz</b>	
	1RB	High	QPSK	22.90	23.06	23.03	
			16QAM	22.87	22.90	22.92	
			64QAM	22.90	22.76	22.88	
		Middle	QPSK	22.96	23.15	23.07	
			16QAM	23.08	22.99	22.95	
			64QAM	22.97	22.78	23.01	
		Low	QPSK	23.11	23.17	23.19	
			16QAM	23.03	22.59	22.96	
			64QAM	23.03	22.87	22.98	
	3RB	High	QPSK	23.27	23.30	23.28	
			16QAM	23.02	23.04	23.03	
			64QAM	23.00	22.98	22.85	
		Middle	QPSK	23.40	23.37	23.31	
			16QAM	23.23	23.12	23.14	
			64QAM	23.06	23.09	23.06	
		Low	QPSK	23.27	23.27	23.35	
			16QAM	23.18	23.09	23.07	
			64QAM	23.17	23.10	23.03	
	6RB	/	QPSK	23.16	23.23	23.17	
			16QAM	22.15	22.13	22.07	
			64QAM	22.05	22.06	22.00	
	3 MHz				<b>714.5MHz</b>	<b>707.5MHz</b>	<b>700.5MHz</b>
		1RB	High	QPSK	23.05	22.99	23.11
				16QAM	22.84	22.54	22.79
				64QAM	22.76	22.34	22.58
			Middle	QPSK	23.27	23.23	23.22
16QAM				23.27	23.00	23.32	
64QAM				23.05	23.01	23.12	
Low			QPSK	23.28	23.14	22.94	
			16QAM	22.95	23.40	23.22	
			64QAM	22.89	23.37	23.16	
8RB		High	QPSK	23.26	23.25	23.21	
			16QAM	22.34	22.33	22.39	
			64QAM	22.06	22.32	22.18	
		Middle	QPSK	23.21	23.29	23.26	
			16QAM	22.41	22.43	22.36	
			64QAM	22.45	22.38	22.20	
		Low	QPSK	23.24	23.24	23.22	
			16QAM	22.68	22.34	22.29	
			64QAM	22.48	22.29	22.19	