



SAR TEST REPORT

No. I17N00032-SAR

For

Yulong Computer Telecommunication Scientific (Shenzhen) Co., Ltd

Smart phone

Model Name: Coolpad 3632A

With

Hardware Version: P2

Software Version: 7.0.013.00.P0.161201.3632A.tmo

FCC:R38YL3632A

Issued Date: 2017-02-19

Note:

The test results in this test report relate only to the devices specified in this report. This report shall not be reproduced except in full without the written approval of CTTL.

Test Laboratory:

CTTL, Telecommunication Technology Labs, Academy of Telecommunication Research, MIIT

No.52, Huayuan North Road, Haidian District, Beijing, P. R. China 100191.

Tel:+86(0)10-62304633-2512,Fax:+86(0)10-62304633-2504

Email:cttl_terminals@catr.cn, website:www.chinattl.com



REPORT HISTORY

Report Number	Revision	Issue Date	Description
I17N00032-SAR	Rev.0	2017-02-19	Initial creation of test report



TABLE OF CONTENT

1 TEST LABORATORY	5
1.1 TESTING LOCATION	5
1.2 TESTING ENVIRONMENT.....	5
1.3 PROJECT DATA	5
1.4 SIGNATURE.....	5
2 STATEMENT OF COMPLIANCE	6
3 CLIENT INFORMATION	8
3.1 APPLICANT INFORMATION	8
3.2 MANUFACTURER INFORMATION	8
4 EQUIPMENT UNDER TEST (EUT) AND ANCILLARY EQUIPMENT (AE)	9
4.1 ABOUT EUT.....	9
4.2 INTERNAL IDENTIFICATION OF EUT USED DURING THE TEST	10
4.3 INTERNAL IDENTIFICATION OF AE USED DURING THE TEST	10
5 TEST METHODOLOGY	11
5.1 APPLICABLE LIMIT REGULATIONS	11
5.2 APPLICABLE MEASUREMENT STANDARDS.....	11
6 SPECIFIC ABSORPTION RATE (SAR).....	12
6.1 INTRODUCTION.....	12
6.2 SAR DEFINITION.....	12
7 TISSUE SIMULATING LIQUIDS	13
7.1 TARGETS FOR TISSUE SIMULATING LIQUID	13
7.2 DIELECTRIC PERFORMANCE	13
8 SYSTEM VERIFICATION	19
8.1 SYSTEM SETUP.....	19
8.2 SYSTEM VERIFICATION.....	20
9 MEASUREMENT PROCEDURES	21
9.1 TESTS TO BE PERFORMED	21
9.2 GENERAL MEASUREMENT PROCEDURE.....	22
9.3 WCDMA MEASUREMENT PROCEDURES FOR SAR	23
9.4 BLUETOOTH & WI-FI MEASUREMENT PROCEDURES FOR SAR	24
9.5 SAR MEASUREMENT FOR LTE.....	24
9.6 POWER DRIFT.....	25
10 AREA SCAN BASED 1-G SAR.....	26
10.1 REQUIREMENT OF KDB.....	26
10.2 FAST SAR ALGORITHMS	26
11 CONDUCTED OUTPUT POWER.....	27
11.1 MANUFACTURING TOLERANCE	27
11.2 GSM MEASUREMENT RESULT	43
11.3 WCDMA MEASUREMENT RESULT.....	45



11.4 LTE_FDD MEASUREMENT RESULT	46
11.5 WI-FI AND BT MEASUREMENT RESULT	60
12 SIMULTANEOUS TX SAR CONSIDERATIONS.....	61
12.1 INTRODUCTION.....	61
12.2 TRANSMIT ANTENNA SEPARATION DISTANCES	61
12.3 SAR MEASUREMENT POSITIONS	62
12.4 STANDALONE SAR TEST EXCLUSION CONSIDERATIONS	62
13 EVALUATION OF SIMULTANEOUS.....	63
14 SAR TEST RESULT	64
14.1 THE EVALUATION OF MULTI-BATTERIES	65
14.2 SAR RESULTS FOR FAST SAR.....	66
14.3 SAR RESULTS FOR STANDARD PROCEDURE	77
14.4 WLAN EVALUATION	80
15 SAR MEASUREMENT VARIABILITY.....	82
16 MEASUREMENT UNCERTAINTY	84
16.1 MEASUREMENT UNCERTAINTY FOR NORMAL SAR TESTS (300MHZ~3GHZ)	84
16.2 MEASUREMENT UNCERTAINTY FOR FAST SAR TESTS (300MHZ~3GHZ)	85
17 MAIN TEST INSTRUMENTS.....	86
ANNEX A GRAPH RESULTS.....	87
ANNEX B SYSTEMVERIFICATION RESULTS	127
ANNEX C SAR MEASUREMENT SETUP	138
C.1 MEASUREMENT SET-UP	138
C.2 DASYS E-FIELD PROBE SYSTEM.....	139
C.3 E-FIELD PROBE CALIBRATION	139
C.4 OTHER TEST EQUIPMENT.....	140
ANNEX D POSITION OF THE WIRELESS DEVICE IN RELATION TO THE PHANTOM	144
D.1 GENERAL CONSIDERATIONS	144
D.2 BODY-WORN DEVICE	145
D.3 DESKTOP DEVICE.....	145
D.4 DUT SETUP PHOTOS.....	146
ANNEX E EQUIVALENT MEDIA RECIPES.....	147
ANNEX F SYSTEM VALIDATION.....	148
ANNEX G DAE CALIBRATION CERTIFICATE.....	149
ANNEX H PROBE CALIBRATION CERTIFICATE.....	154
ANNEX I DIPOLE CALIBRATION CERTIFICATE.....	165

1 Test Laboratory

1.1 Testing Location

Company Name:	CTTL(Shenzhen)
Address:	TCL International E City No.1001 Zhongshanyuan Road, Nanshan District, Shenzhen, Guangdong Province P.R.China

1.2 Testing Environment

Temperature:	18°C~25 °C
Relative humidity:	30%~ 70%
Ground system resistance:	< 4Ω
Ambient noise & Reflection:	< 0.012 W/kg

1.3 Project Data

Project Leader:	Zhang Yunzhuan
Test Engineer:	Wang Fen
Testing Start Date:	February 08, 2017
Testing End Date:	February 15, 2017

1.4 Signature

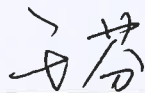

Wang Fen

(Prepared this test report)



Zhang Yunzhuan

(Reviewed this test report)



Cao Junfei

Deputy Director of the laboratory
(Approved this test report)

2 Statement of Compliance

The maximum results of Specific Absorption Rate (SAR) found during testing for Yulong Computer Telecommunication Scientific (Shenzhen) Co., Ltd Smart phone Coolpad 3632A are as follows:

Table 2.1: Highest Reported SAR (1g)

Exposure Configuration	Technology Band	Highest Reported SAR 1g(W/Kg)	Equipment Class
Head (Separation Distance 0mm)	GSM850	0.39	PCE
	PCS1900	0.03	
	UMTSFDD 5	0.53	
	UMTSFDD 2	0.46	
	UMTSFDD 4	0.59	
	LTEBand2	0.28	
	LTEBand4	0.38	
	LTEBand5	0.42	
	LTEBand12	0.29	
	WLAN2.4GHz	0.97	DTS
Body-worn (Data) (Separation Distance 10mm)	GSM850	0.44	PCE
	PCS1900	0.83	
	UMTSFDD 5	0.70	
	UMTSFDD 2	1.33	
	UMTSFDD 4	1.20	
	LTEBand2	1.26	
	LTEBand4	1.22	
	LTEBand5	0.67	
	LTEBand12	0.54	
	WLAN2.4GHz	0.26	DTS

The SAR values found for the Mobile Phone are below the maximum recommended levels of 1.6 W/Kg as averaged over any 1g tissue according to the ANSI C95.1-1999.

For body worn operation, this device has been tested and meets FCC RF exposure guidelines when used with any accessory that contains no metal and which provides a minimum separation distance of 10 mm between this device and the body of the user. Use of other accessories may not ensure compliance with FCC RF exposure guidelines.

The EUT battery must be fully charged and checked periodically during the test to ascertain uniform power output.

The measurement together with the test system set-up is described in annex C of this test report. A detailed description of the equipment under test can be found in chapter 4 of this test report.

The highest reported SAR value is obtained at the case of **(Table 2.1)**, and the values are: **1.33W/kg(1g)**.

Table 2.2: The sum of reported SAR values for main antenna and Wi-Fi

	Position	Main antenna	Wi-Fi	Sum
Highest reported SAR value for Head	Left Touch	0.54	0.97	1.51
	Right Touch	0.59	0.48	1.07
Highest reported SAR value for Body	Rear	1.26	0.26	1.52
	Bottom	1.33	/	1.33

Table 2.3: The sum of reported SAR values for main antenna and BT

	Position	Main antenna	BT*	Sum
Highest reported SAR value for Head	Left Touch	0.54	0.06	0.60
	Right Touch	0.59	0.06	0.65
Highest reported SAR value for Body	Rear	1.26	0.03	1.29
	Bottom	1.33	/	1.33

BT*-Estimated SAR for Bluetooth (see the table 13.3)

According to the above tables, the highest sum of reported SAR values is **1.52W/kg (1g)**. The detail for simultaneous transmission consideration is described in chapter 13.



3 Client Information

3.1 Applicant Information

Company Name:	Yulong Computer Telecommunication Scientific (Shenzhen) Co., Ltd
Address /Post:	Coolpad Information Harbor, High-tech Industrial Park (North), Nanshan District, Shenzhen, P.R.C.
Contact:	wangping
Email:	wangping1@yulong.com
Telephone:	0755-83301199-83335
Fax:	/

3.2 Manufacturer Information

Company Name:	Yulong Computer Telecommunication Scientific (Shenzhen) Co., Ltd
Address /Post:	Coolpad Information Harbor, High-tech Industrial Park (North), Nanshan District, Shenzhen, P.R.C.
Contact:	wangping
Email:	wangping1@yulong.com
Telephone:	0755-83301199-83335
Fax:	/

4 Equipment Under Test (EUT) and Ancillary Equipment (AE)

4.1 About EUT

Description:	Smart phone
Model Name:	Coolpad 3632A
Operating mode(s):	GSM 850/1900/900/1800, WCDMA 850/1700/1900, LTE_FDD Band 2/4/5/12, BT, Wi-Fi 2.4G
Tested Tx Frequency:	825–848.8 MHz (GSM 850)
	1850.2–1910 MHz (GSM 1900)
	826.4–846.6 MHz (WCDMA850 Band V)
	1712.4–1752.6 MHz (WCDMA1700 Band IV)
	1852.4–1907.6 MHz (WCDMA1900 Band II)
	1850.7–1909.3 MHz (LTE_FDD Band 2)
	1710.7–1754.3 MHz (LTE_FDD Band 4)
	824.7–848.3 MHz (LTE_FDD Band 5)
	699.7–715.3 MHz (LTE_FDD Band 12)
	2412 – 2462 MHz (Wi-Fi 2.4G)
GPRS&EGPRS Multislot Class:	33
GPRS capability Class:	/
WCDMA Category:	USAT: 6
	HSDPA: 6
	HSUPA:14
	HSPA+:14
	DC-HSDPA: 8
Release Version:	GSM: Rel8
	GPRS: Rel8
	UMTS: 8
Test device Production information:	Production unit
Device type:	Portable device
Antenna type:	Integrated antenna
Accessories/Body-worn configurations:	/
Hotspot mode:	Support simultaneous transmission of hotspot and voice(or data)

4.2 Internal Identification of EUT used during the test

EUT ID*	SN or IMEI	HW Version	SW Version
EUT1	IMEI:862006030009421	P2	7.0.013.00.P0.161201.3632A.tmo
EUT2	IMEI: 862006030009256	P2	7.0.013.00.P0.161201.3632A.tmo

*EUT ID: is used to identify the test sample in the lab internally.

Note: It is performed to test SAR with the EUT1, and conducted power with the EUT 2.

4.3 Internal Identification of AE used during the test

AE ID*	Description	Model	SN	Manufacturer
AE1	Battery	CPLD-417	CPLD41716424000001	Zhuhai COSLIGHT Battery CO., Ltd.
AE2	Battery	CPLD-417	CPLD41716424000001	Tianjin Lishen Battery Joint-Stock Co.,Ltd.

*AE ID: is used to identify the test sample in the lab internally.

5 TEST METHODOLOGY

5.1 Applicable Limit Regulations

ANSI C95.1–1999:IEEE Standard for Safety Levels with Respect to Human Exposure to Radio Frequency Electromagnetic Fields, 3 kHz to 300 GHz.

It specifies the maximum exposure limit of **1.6 W/kg** as averaged over any 1 gram of tissue for portable devices being used within 20 cm of the user in the uncontrolled environment.

5.2 Applicable Measurement Standards

IEEE 1528–2013: Recommended Practice for Determining the Peak Spatial-Average Specific Absorption Rate (SAR) in the Human Head from Wireless Communications Devices: Experimental Techniques.

KDB 447498 D01 General RF Exposure Guidance v06: Mobile and Portable Devices RF Exposure Procedures and Equipment Authorization Policies.

KDB648474 D04 Handset SAR v01r03: SAR Evaluation Considerations for Wireless Handsets.

KDB941225 D01 SAR test for 3G devices v03r01:SAR MeasurementProceduresfor3GDevices

KDB941225D05SAR forLTEDevicesv02r05:SAR EvaluationConsiderationsforLTEDevices

KDB 941225 D06 Hot Spot SAR v02r01: SAR Evaluation Procedures for Portable Devices with Wireless Router Capabilities

KDB 248227 D01 802.11 Wi-Fi SAR v02r02: SAR Guidancefor IEEE 802.11 (Wi-Fi) Transmitters.

KDB 865664 D01SAR measurement 100 MHz to 6 GHz v01r04: SAR Measurement Requirements for 100 MHz to 6 GHz.

KDB 865664 D02 RF Exposure Reporting v01r02: RF Exposure Compliance Reporting and Documentation Considerations

6 Specific Absorption Rate (SAR)

6.1 Introduction

SAR is related to the rate at which energy is absorbed per unit mass in an object exposed to a radio field. The SAR distribution in a biological body is complicated and is usually carried out by experimental techniques or numerical modeling. The standard recommends limits for two tiers of groups, occupational/controlled and general population/uncontrolled, based on a person's awareness and ability to exercise control over his or her exposure. In general, occupational/controlled exposure limits are higher than the limits for general population/uncontrolled.

6.2 SAR Definition

The SAR definition is the time derivative (rate) of the incremental energy (dW) absorbed by (dissipated in) an incremental mass (dm) contained in a volume element (dv) of a given density (ρ). The equation description is as below:

$$SAR = \frac{d}{dt} \left(\frac{dW}{dm} \right) = \frac{d}{dt} \left(\frac{dW}{\rho dv} \right)$$

SAR is expressed in units of Watts per kilogram (W/kg)

SAR measurement can be either related to the temperature elevation in tissue by

$$SAR = c \left(\frac{\delta T}{\delta t} \right)$$

Where: C is the specific heat capacity, δT is the temperature rise and δt is the exposure duration, or related to the electrical field in the tissue by

$$SAR = \frac{\sigma |E|^2}{\rho}$$

Where: σ is the conductivity of the tissue, ρ is the mass density of tissue and E is the RMS electrical field strength.

However for evaluating SAR of low power transmitter, electrical field measurement is typically applied.

7 Tissue Simulating Liquids

7.1 Targets for tissue simulating liquid

Table 7.1: Targets for tissue simulating liquid

Frequency (MHz)	Liquid Type	Conductivity (σ)	$\pm 5\%$ Range	Permittivity (ϵ)	$\pm 5\%$ Range
750	Head	0.89	0.85~0.93	41.94	39.8~44.0
750	Body	0.96	0.91~1.01	55.5	52.7~58.3
835	Head	0.90	0.86~0.95	41.5	39.4~43.6
835	Body	0.97	0.92~1.02	55.2	52.4~58.0
1800	Head	1.40	1.33~1.47	40.0	38.0~42.0
1800	Body	1.52	1.44~1.60	53.5	50.8~56.1
1900	Head	1.40	1.33~1.47	40.0	38.0~42.0
1900	Body	1.52	1.44~1.60	53.3	50.6~56.0
2450	Head	1.80	1.71~1.89	39.2	37.2~41.2
2450	Body	1.95	1.85~2.05	52.7	50.1~55.3

7.2 Dielectric Performance

Table 7.2: Dielectric Performance of Tissue Simulating Liquid

Measurement Date (yyyy-mm-dd)	Type	Frequency	Permittivity ϵ	Drift (%)	Conductivity σ (S/m)	Drift (%)
2017-2-14	Head	750	41.52	-1.00	0.906	1.80
2017-2-14	Body	750	53.46	-3.68	0.954	-0.63
2017-2-8	Head	835	41.18	-0.77	0.896	-0.44
2017-2-8	Body	835	55.58	0.69	0.984	1.44
2017-2-13	Head	1800	40.99	2.48	1.384	-1.14
2017-2-13	Body	1800	53.22	-0.52	1.502	-1.18
2017-2-12	Head	1900	40.66	1.65	1.419	1.36
2017-2-12	Body	1900	52.95	-0.66	1.548	1.84
2017-2-15	Head	2450	37.87	-3.39	1.853	2.94
2017-2-15	Body	2450	54.65	3.70	1.914	-1.85

Note: The liquid temperature is 22.0°C

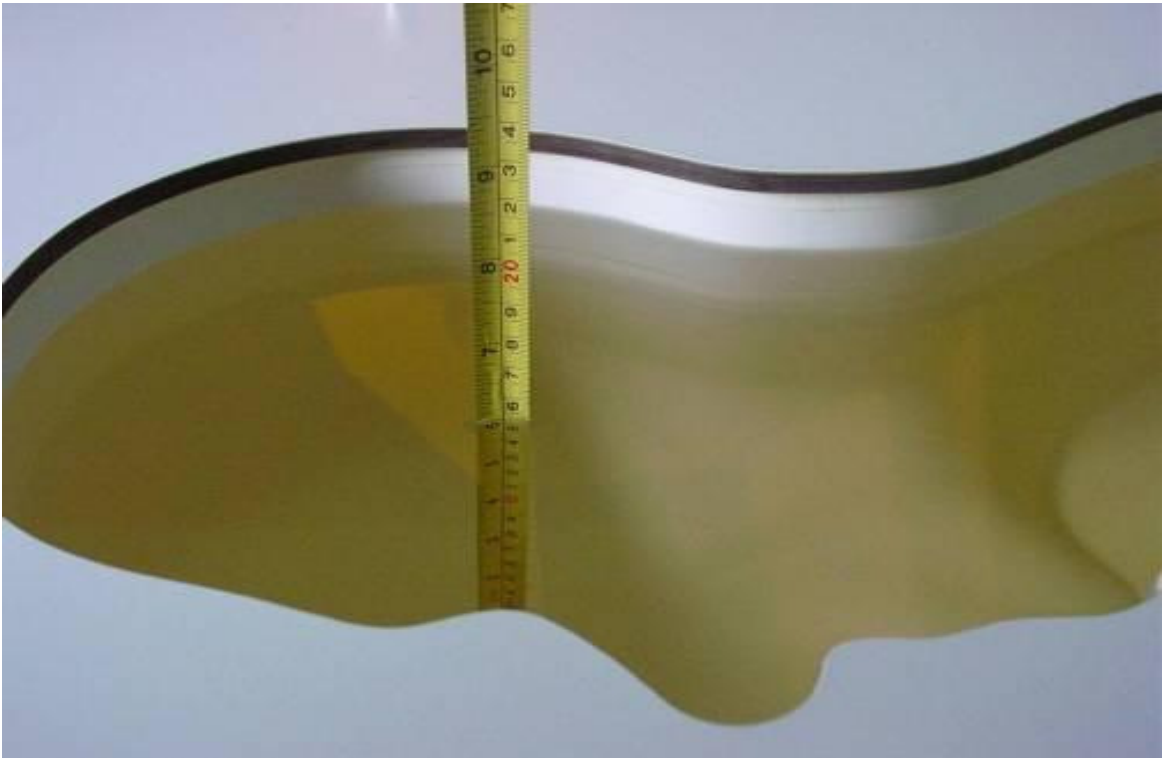

Picture 7-1: Liquid depth in the Head Phantom (750 MHz)

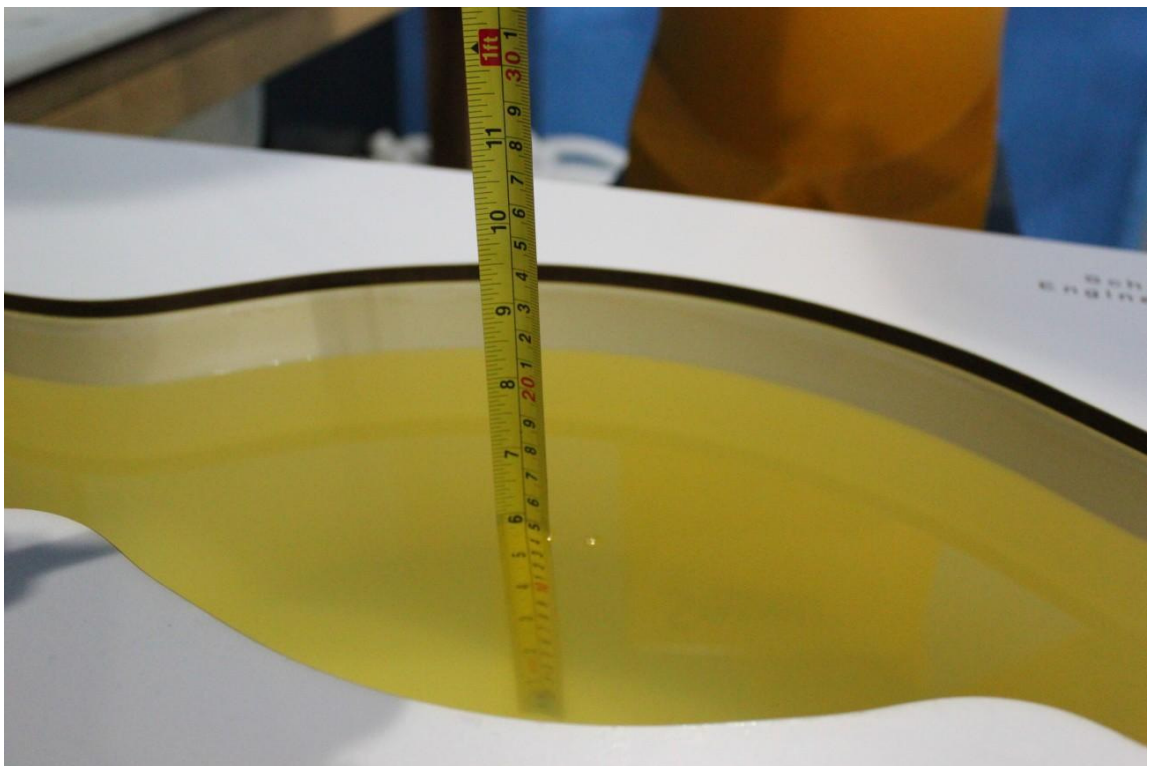

Picture 7-2: Liquid depth in the Flat Phantom (750 MHz)

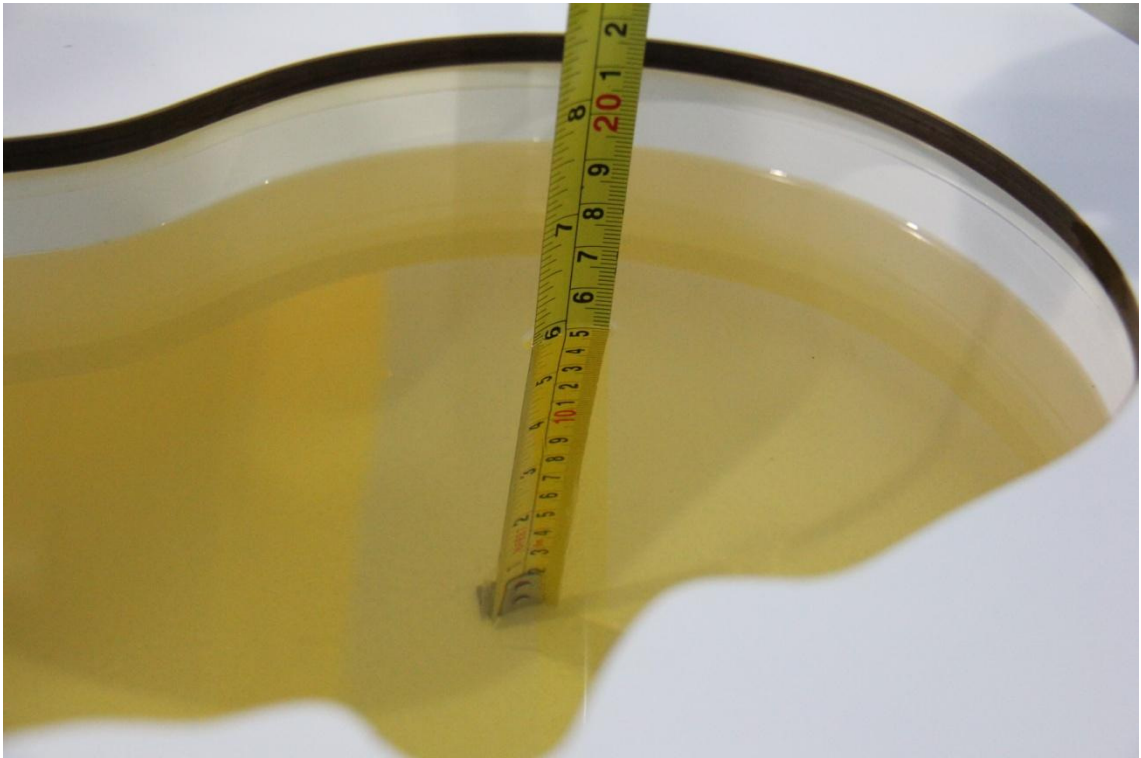

Picture 7-3: Liquid depth in the Head Phantom (835 MHz)

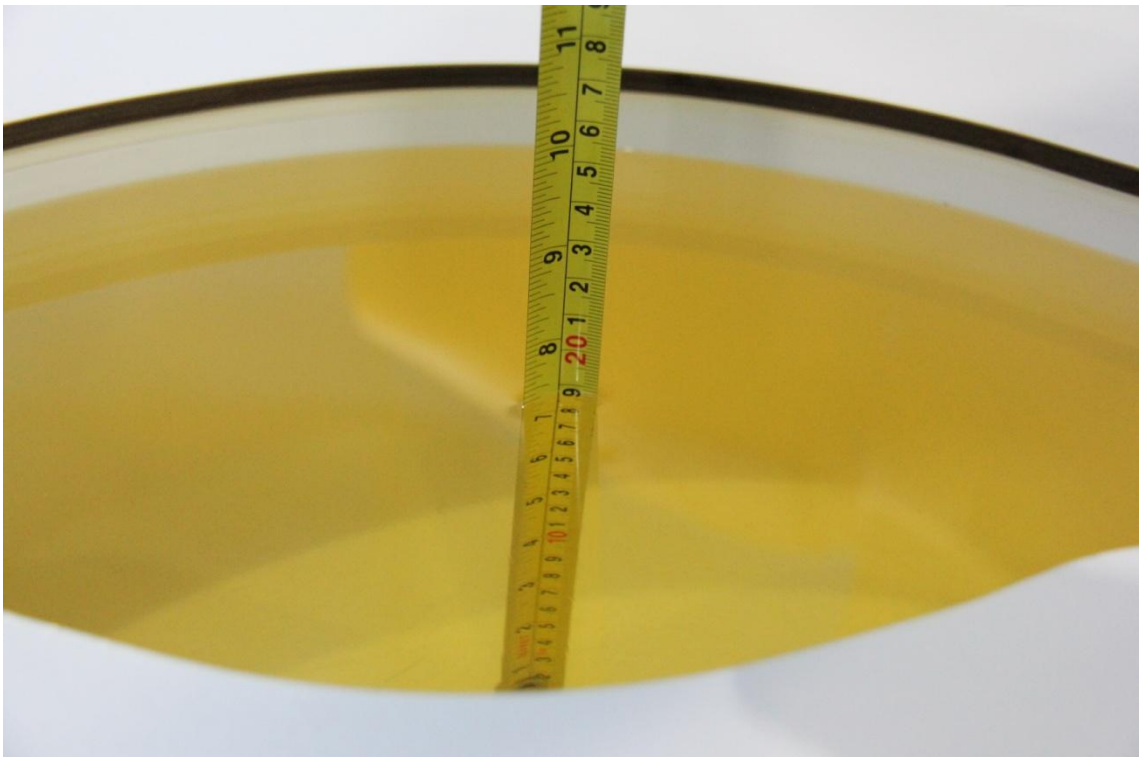

Picture 7-4: Liquid depth in the Flat Phantom (835 MHz)

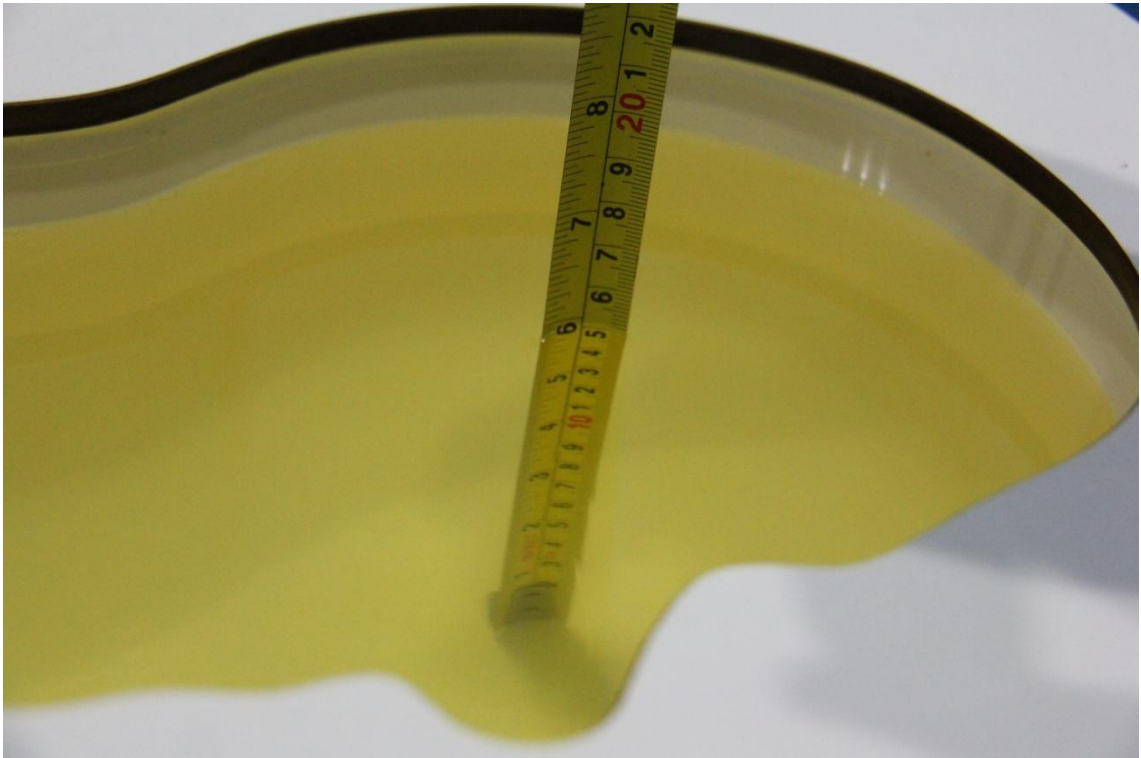

Picture 7-5: Liquid depth in the Head Phantom (1800 MHz)



Picture 7-6: Liquid depth in the Flat Phantom (1800MHz)

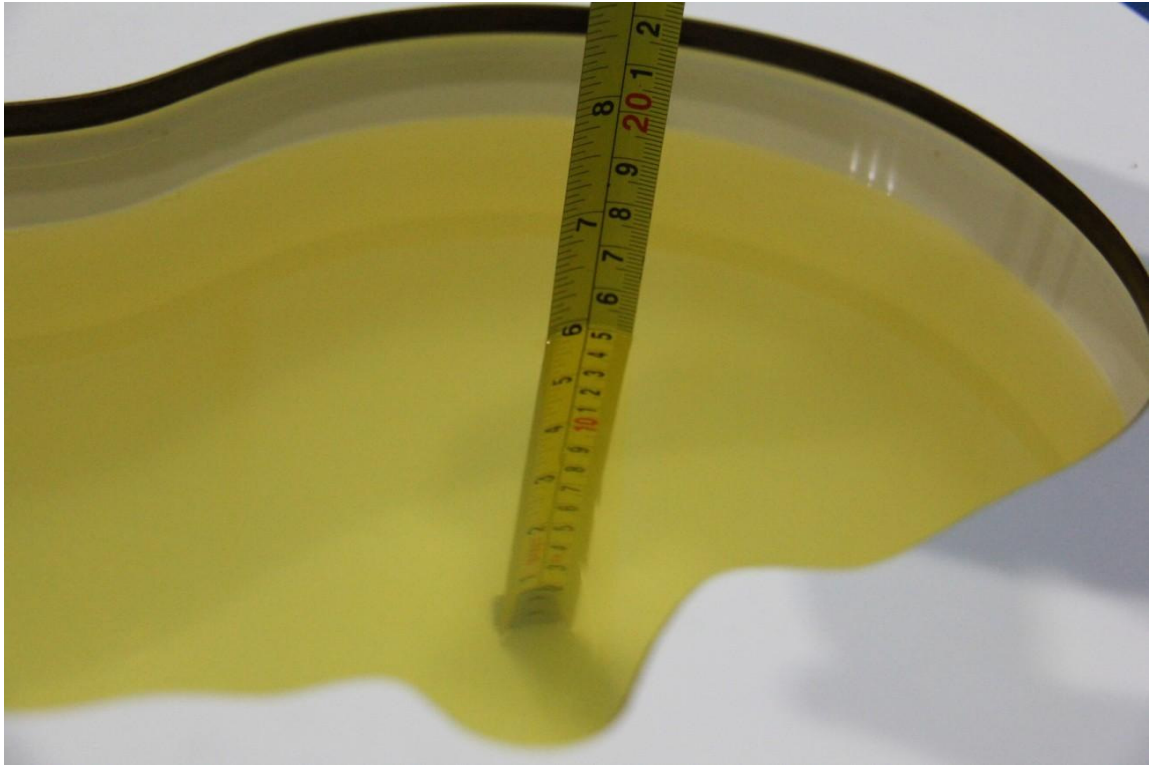

Picture 7-7: Liquid depth in the Head Phantom (1900 MHz)

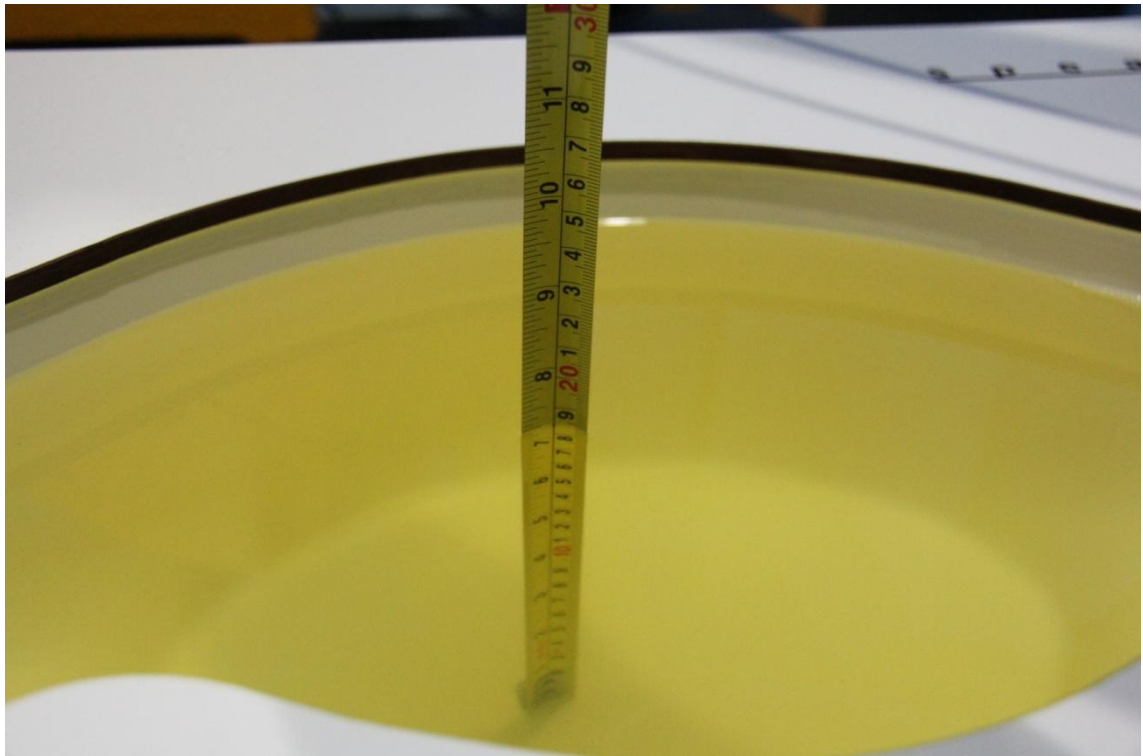

Picture 7-8: Liquid depth in the Flat Phantom (1900MHz)

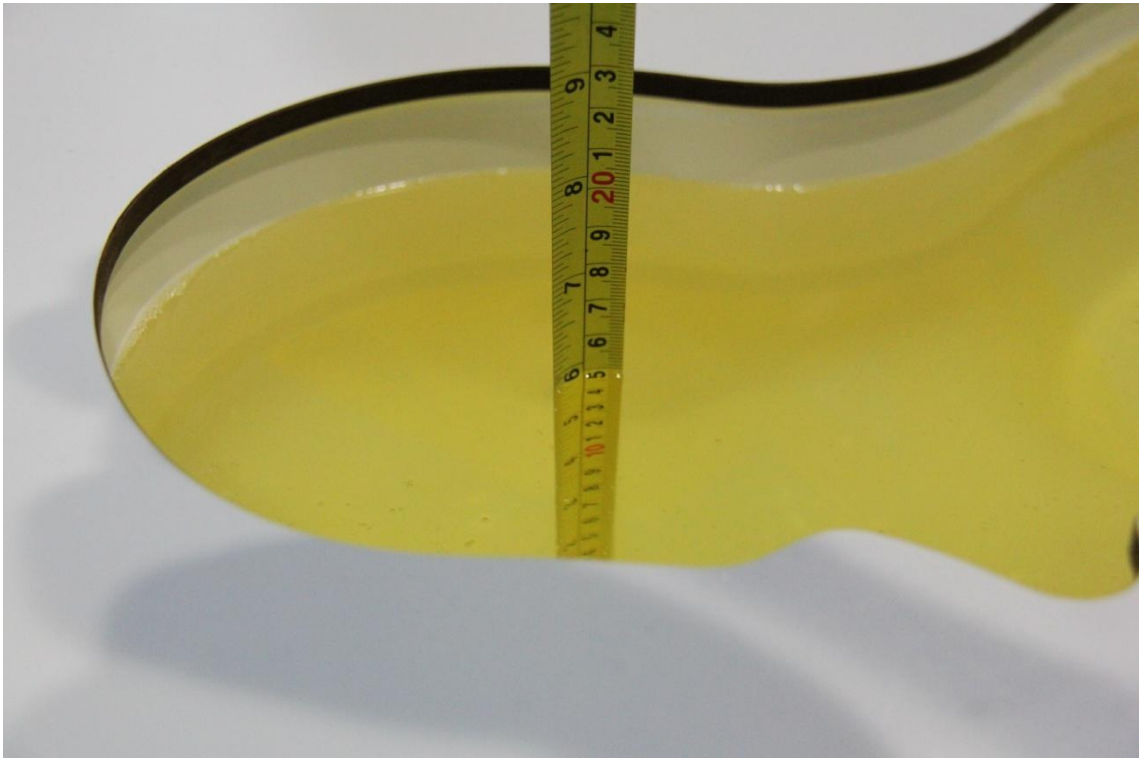

Picture 7-9: Liquiddepthin theHeadPhantom(2450MHz)

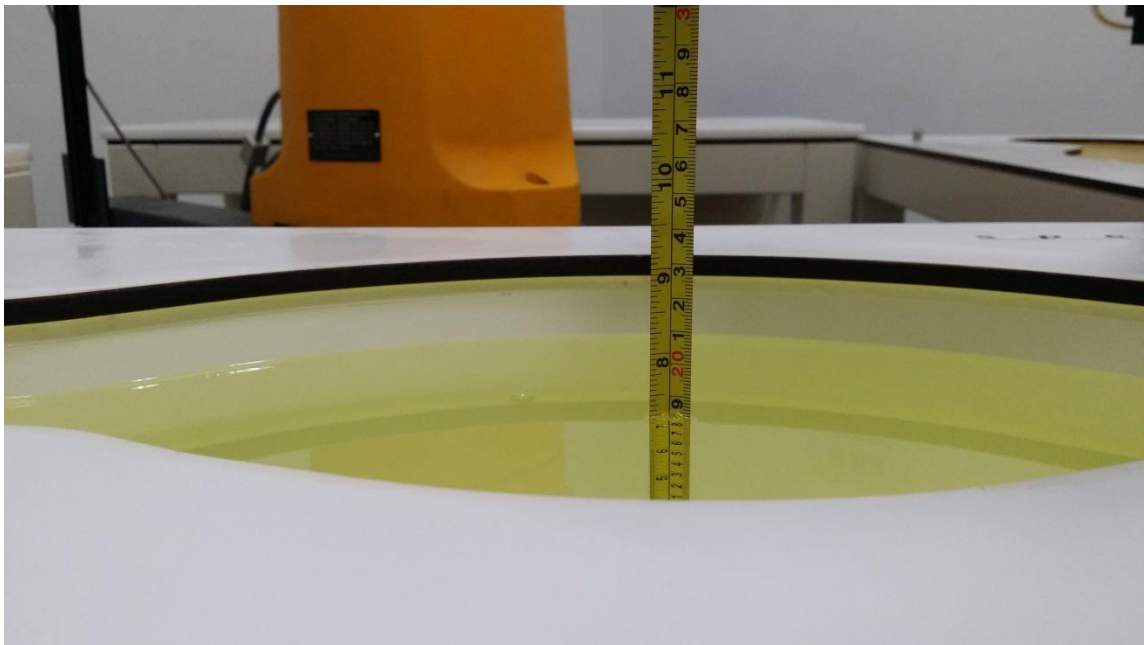

Picture 7-10: Liquiddepthin theFlatPhantom(2450MHz)

8 System verification

8.1 System Setup

In the simplified setup for system evaluation, the DUT is replaced by a calibrated dipole and the power source is replaced by a continuous wave that comes from a signal generator. The calibrated dipole must be placed beneath the flat phantom section of the SAM twin phantom with the correct distance holder. The distance holder should touch the phantom surface with a light pressure at the reference marking and be oriented parallel to the long side of the phantom. The equipment setup is shown below:

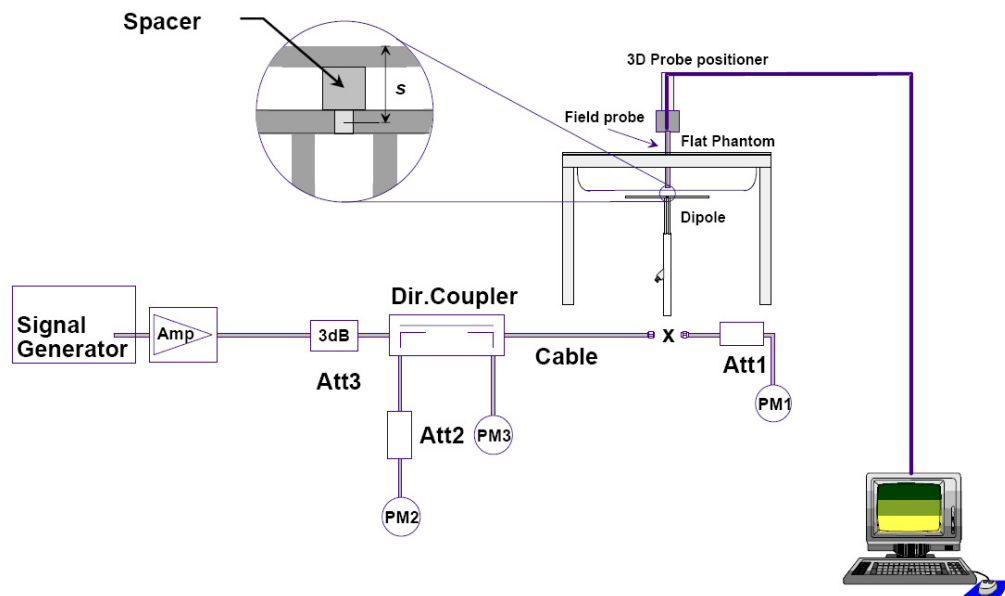

Picture 8.1 System Setup for System Evaluation



Picture 8.2 Photo of Dipole Setup

8.2 System Verification

SAR system verification is required to confirm measurement accuracy, according to the tissue dielectric media, probe calibration points and other system operating parameters required for measuring the SAR of a test device. The system verification must be performed for each frequency band and within the valid range of each probe calibration point required for testing the device.

The system verification results are required that the area scan estimated 1-g SAR is within 3% of the zoom scan 1-g SAR. The details are presented in annex B.

Table 8.1: System Verification of Head

Measurement Date (yyyy-mm-dd)	Frequency	Target value (W/kg)		Measured value (W/kg)		Deviation(%)	
		10 g Average	1 g Average	10 g Average	1 g Average	10 g Average	1 g Average
2017-2-14	750 MHz	5.46	8.33	5.64	8.64	3.30	3.72
2017-2-8	835 MHz	6.03	9.22	5.88	9.04	-2.49	-1.95
2017-2-13	1800 MHz	20.6	38.8	20.36	37.92	-1.17	-2.27
2017-2-12	1900 MHz	21.0	40.8	21.44	42.00	2.10	2.94
2017-2-15	2450 MHz	24.1	52.5	23.52	50.80	-2.41	-3.24

Table 8.2: System Verification of Body

Measurement Date (yyyy-mm-dd)	Frequency	Target value (W/kg)		Measured value (W/kg)		Deviation(%)	
		10 g Average	1 g Average	10 g Average	1 g Average	10 g Average	1 g Average
2017-2-14	750 MHz	5.76	8.78	5.60	8.56	-2.78	-2.51
2017-2-8	835 MHz	6.20	9.44	6.00	9.08	-3.23	-3.81
2017-2-13	1800 MHz	21.1	39.6	20.52	38.60	-2.75	-2.53
2017-2-12	1900 MHz	21.3	41.1	22.04	42.40	3.47	3.16
2017-2-15	2450 MHz	24.4	52.3	23.52	50.40	-3.61	-3.63

9 Measurement Procedures

9.1 Tests to be performed

In order to determine the highest value of the peak spatial-average SAR of a handset, all device positions, configurations and operational modes shall be tested for each frequency band according to steps 1 to 3 below. A flowchart of the test process is shown in picture 9.1.

Step 1: The tests described in 9.2 shall be performed at the channel that is closest to the center of the transmit frequency band (f_c) for:

- a) all device positions (cheek and tilt, for both left and right sides of the SAM phantom, as described in annex D),
- b) all configurations for each device position in a), e.g., antenna extended and retracted, and
- c) all operational modes, e.g., analogue and digital, for each device position in a) and configuration in b) in each frequency band.

If more than three frequencies need to be tested according to 11.1 (i.e., $N_c > 3$), then all frequencies, configurations and modes shall be tested for all of the above test conditions.

Step 2: For the condition providing highest peak spatial-average SAR determined in Step 1, perform all tests described in 9.2 at all other test frequencies, i.e., lowest and highest frequencies. In addition, for all other conditions (device position, configuration and operational mode) where the peak spatial-average SAR value determined in Step 1 is within 3 dB of the applicable SAR limit, it is recommended that all other test frequencies shall be tested as well.

Step 3: Examine all data to determine the highest value of the peak spatial-average SAR found in Steps 1 to 2.

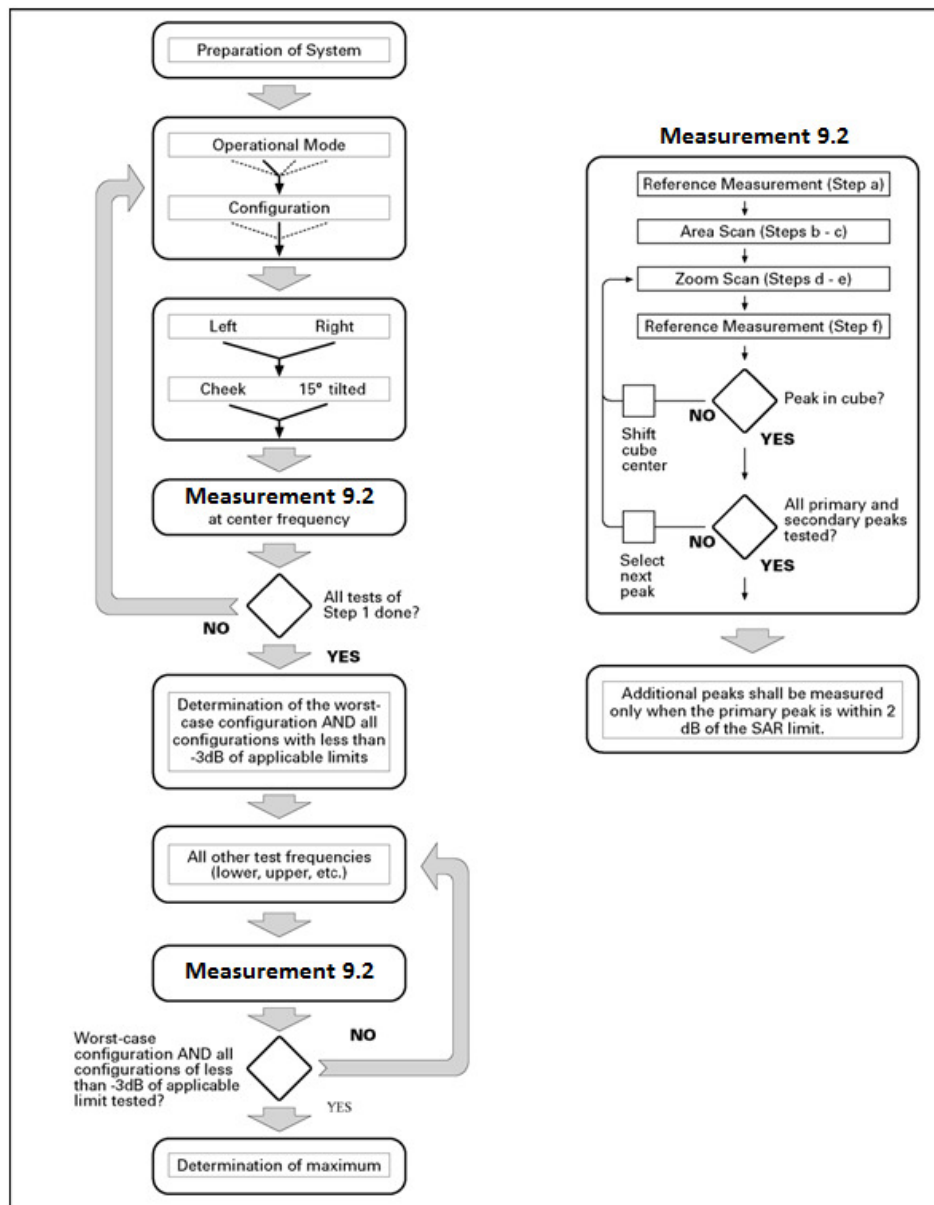

Picture 9.1 Block diagram of the tests to be performed

9.2 General Measurement Procedure

The area and zoom scan resolutions specified in the table below must be applied to the SAR measurements and fully documented in SAR reports to qualify for TCB approval. Probe boundary effect error compensation is required for measurements with the probe tip closer than half a probe tip diameter to the phantom surface. Both the probe tip diameter and sensor offset distance must satisfy measurement protocols; to ensure probe boundary effect errors are minimized and the higher fields closest to the phantom surface can be correctly measured and extrapolated to the phantom surface for computing 1-g SAR. Tolerances of the post-processing algorithms must be verified by the test laboratory for the scan resolutions used in the SAR measurements, according to the reference distribution functions specified in IEEE Std 1528-2013. The results should be documented as part of the system validation records and may be requested to support test results

when all the measurement parameters in the following table are not satisfied.

		≤ 3 GHz	> 3 GHz
Maximum distance from closest measurement point (geometric center of probe sensors) to phantom surface		5 ± 1 mm	$\frac{1}{2} \cdot \delta \cdot \ln(2) \pm 0.5$ mm
Maximum probe angle from probe axis to phantom surface normal at the measurement location		$30^\circ \pm 1^\circ$	$20^\circ \pm 1^\circ$
Maximum area scan spatial resolution: $\Delta x_{Area}, \Delta y_{Area}$		≤ 2 GHz: ≤ 15 mm 2 – 3 GHz: ≤ 12 mm	3 – 4 GHz: ≤ 12 mm 4 – 6 GHz: ≤ 10 mm
		When the x or y dimension of the test device, in the measurement plane orientation, is smaller than the above, the measurement resolution must be \leq the corresponding x or y dimension of the test device with at least one measurement point on the test device.	
Maximum zoom scan spatial resolution: $\Delta x_{Zoom}, \Delta y_{Zoom}$		≤ 2 GHz: ≤ 8 mm 2 – 3 GHz: ≤ 5 mm*	3 – 4 GHz: ≤ 5 mm* 4 – 6 GHz: ≤ 4 mm*
Maximum zoom scan spatial resolution, normal to phantom surface	uniform grid: $\Delta z_{Zoom}(n)$	≤ 5 mm	3 – 4 GHz: ≤ 4 mm 4 – 5 GHz: ≤ 3 mm 5 – 6 GHz: ≤ 2 mm
	graded grid $\Delta z_{Zoom}(1)$: between 1 st two points closest to phantom surface	≤ 4 mm	3 – 4 GHz: ≤ 3 mm 4 – 5 GHz: ≤ 2.5 mm 5 – 6 GHz: ≤ 2 mm
	$\Delta z_{Zoom}(n>1)$: between subsequent points	$\leq 1.5 \cdot \Delta z_{Zoom}(n-1)$	
Minimum zoom scan volume	x, y, z	≥ 30 mm	3 – 4 GHz: ≥ 28 mm 4 – 5 GHz: ≥ 25 mm 5 – 6 GHz: ≥ 22 mm
Note: δ is the penetration depth of a plane-wave at normal incidence to the tissue medium; see draft standard IEEE P1528-2011 for details. * When zoom scan is required and the <i>reported</i> SAR from the area scan based <i>I-g SAR estimation</i> procedures of KDB 447498 is ≤ 1.4 W/kg, ≤ 8 mm, ≤ 7 mm and ≤ 5 mm zoom scan resolution may be applied, respectively, for 2 GHz to 3 GHz, 3 GHz to 4 GHz and 4 GHz to 6 GHz.			

9.3 WCDMA Measurement Procedures for SAR

The following procedures are applicable to WCDMA handsets operating under 3GPP Release99, Release 5 and Release 6. The default test configuration is to measure SAR with an established radio link between the DUT and a communication test set using a 12.2kbps RMC (reference measurement channel) configured in Test Loop Mode 1. SAR is selectively confirmed for other physical channel configurations (DPCCH & DPDCH_n), HSDPA and HSPA (HSUPA/HSDPA) modes according to output power, exposure conditions and device operating capabilities. Both uplink and downlink should be configured with the same RMC or AMR, when required. SAR for Release 5 HSDPA and Release 6 HSPA are measured using the applicable FRC (fixed reference channel) and E-DCH reference channel configurations. Maximum output power is verified according to applicable versions of 3GPP TS 34.121 and SAR must be measured according to these maximum output conditions. When Maximum Power Reduction (MPR) is not implemented according to Cubic Metric (CM) requirements for Release 6 HSPA, the following procedures do not apply.

For Release 5 HSDPA Data Devices:

Sub-test	β_c	β_d	β_d (SF)	β_c / β_d	β_{hs}	CM/dB
1	2/15	15/15	64	2/15	4/15	0.0
2	12/15	15/15	64	12/15	24/25	1.0
3	15/15	8/15	64	15/8	30/15	1.5
4	15/15	4/15	64	15/4	30/15	1.5

For Release 6 HSPA Data Devices

Sub-test	β_c	β_d	β_d (SF)	β_c / β_d	β_{hs}	β_{ec}	β_{ed}	β_{ed} (SF)	β_{ed} (codes)	CM (dB)	MPR (dB)	AG Index	E-TFCI
1	11/15	15/15	64	11/15	22/15	209/225	1039/225	4	1	1.0	0.0	20	75
2	6/15	15/15	64	6/15	12/15	12/15	12/15	4	1	3.0	2.0	12	67
3	15/15	9/15	64	15/9	30/15	30/15	$\beta_{ed1}:47/15$ $\beta_{ed2}:47/15$	4	2	2.0	1.0	15	92
4	2/15	15/15	64	2/15	4/15	4/15	56/75	4	1	3.0	2.0	17	71
5	15/15	15/15	64	15/15	24/15	30/15	134/15	4	1	1.0	0.0	21	81

9.4 Bluetooth & Wi-Fi Measurement Procedures for SAR

Normal network operating configurations are not suitable for measuring the SAR of 802.11 transmitters in general. Unpredictable fluctuations in network traffic and antenna diversity conditions can introduce undesirable variations in SAR results. The SAR for these devices should be measured using chipset based test mode software to ensure that the results are consistent and reliable.

Chipset based test mode software is hardware dependent and generally varies among manufacturers. The device operating parameters established in a test mode for SAR measurements must be identical to those programmed in production units, including output power levels, amplifier gain settings and other RF performance tuning parameters. The test frequencies should correspond to actual channel frequencies defined for domestic use. SAR for devices with switched diversity should be measured with only one antenna transmitting at a time during each SAR measurement, according to a fixed modulation and data rate. The same data pattern should be used for all measurements.

9.5 SAR Measurement for LTE

SAR tests for LTE are performed with a base station simulator, Anristu MT8820C. Closed loop power control was used so the UE transmits with maximum output power during SAR testing. All powers were measured with the Anristu MT8820C. It is performed for conducted power and SAR based on the KDB941225 D05.

SAR is evaluated separately according to the following procedures for the different test positions in each exposure condition – head, body, body-worn accessories and other use conditions. The

procedures in the following subsections are applied separately to test each LTE frequency band.

1) QPSK with 1 RB allocation

Start with the largest channel bandwidth and measure SAR for QPSK with 1 RB allocation, using the RB offset and required test channel combination with the highest maximum output power among RB offsets at the upper edge, middle and lower edge of each required test channel. When the reported SAR is ≤ 0.8 W/kg, testing of the remaining RB offset configurations and required test channels is not required for 1 RB allocation; otherwise, SAR is required for the remaining required test channels and only for the RB offset configuration with the highest output power for that channel. When the reported SAR of a required test channel is > 1.45 W/kg, SAR is required for all three RB offset configurations for that required test channel.

2) QPSK with 50% RB allocation

The procedures required for 1 RB allocation in 1) are applied to measure the SAR for QPSK with 50% RB allocation.

3) QPSK with 100% RB allocation

For QPSK with 100% RB allocation, SAR is not required when the highest maximum output power for 100 % RB allocation is less than the highest maximum output power in 50% and 1 RB allocations and the highest reported SAR for 1 RB and 50% RB allocation in 1) and 2) are ≤ 0.8 W/kg. Otherwise, SAR is measured for the highest output power channel; and if the reported SAR is > 1.45 W/kg, the remaining required test channels must also be tested.

9.6 Power Drift

To control the output power stability during the SAR test, DASY5 system calculates the power drift by measuring the E-field at the same location at the beginning and at the end of the measurement for each test position. These drift values can be found in Section14 labeled as: (Power Drift [dB]). This ensures that the power drift during one measurement is within 5%.

10 Area Scan Based 1-g SAR

10.1 Requirement of KDB

According to the KDB447498 D01, when the implementation is based the specific polynomial fit algorithm as presented at the 29th Bioelectromagnetics Society meeting (2007) and the estimated 1-gSAR is ≤ 1.2 W/kg, a zoom scan measurement is not required provided it is also not needed for any other purpose; for example, if the peak SAR location required for simultaneous transmission SAR test exclusion can be determined accurately by the SAR system or manually to discriminate between distinctive peaks and scattered noisy SAR distributions from area scans.

There must not be any warning or alert messages due to various measurement concerns identified by the SAR system; for example, noise in measurements, peaks too close to scan boundary, peaks are too sharp, spatial resolution and uncertainty issues etc. The SAR system verification must also demonstrate that the area scan estimated 1-g SAR is within 3% of the zoom scan 1-g SAR (See Annex B). When all the SAR results for each exposure condition in a frequency band and wireless mode are based on estimated 1-g SAR, the 1-g SAR for the highest SAR configuration must be determined by a zoom scan.

10.2 Fast SAR Algorithms

The approach is based on the area scan measurement applying a frequency dependent attenuation parameter. This attenuation parameter was empirically determined by analyzing a large number of phones. The MOTOROLA FAST SAR was developed and validated by the MOTOROLA Research Group in Ft. Lauderdale.

In the initial study, an approximation algorithm based on Linear fit was developed. The accuracy of the algorithm has been demonstrated across a broad frequency range (136-2450 MHz) and for both 1- and 10-g averaged SAR using a sample of 264 SAR measurements from 55 wireless handsets. For the sample size studied, the root-mean-squared errors of the algorithm are 1.2% and 5.8% for 1- and 10-g averaged SAR, respectively. The paper describing the algorithm in detail is expected to be published in August 2004 within the Special Issue of Transactions on MTT.

In the second step, the same research group optimized the fitting algorithm to an Polynomial fit whereby the frequency validity was extended to cover the range 30-6000MHz. Details of this study can be found in the BEMS 2007 Proceedings.

Both algorithms are implemented in DASY software.

11 Conducted Output Power

11.1 Manufacturing tolerance

Table 11.1: GSM Speech

GSM 850			
Channel	Channel 251	Channel 190	Channel 128
Target (dBm)	32.5	32.5	32.5
Tolerance \pm (dB)	1	1	1
GSM 1900			
Channel	Channel 810	Channel 661	Channel 512
Target (dBm)	30	30	30
Tolerance \pm (dB)	1	1	1

Table 11.2: GPRS & EGPRS (AP OFF)

GSM 850 GPRS				
Channel		251	190	128
1Txslot	Target (dBm)	32.5	32.5	32.5
	Tolerance \pm (dB)	1	1	1
2Txslots	Target (dBm)	29.5	29.5	29.5
	Tolerance \pm (dB)	1	1	1
3Txslots	Target (dBm)	27	27	27
	Tolerance \pm (dB)	1	1	1
4Txslots	Target (dBm)	26	26	26
	Tolerance \pm (dB)	1	1	1
GSM 850 EGPRS (GMSK)				
Channel		251	190	128
1Txslot	Target (dBm)	32	32	32
	Tolerance \pm (dB)	1	1	1
2Txslots	Target (dBm)	28.5	28.5	28.5
	Tolerance \pm (dB)	1	1	1
3Txslots	Target (dBm)	26.5	26.5	26.5
	Tolerance \pm (dB)	1	1	1
4Txslots	Target (dBm)	25.5	25.5	25.5
	Tolerance \pm (dB)	1	1	1
GSM 850 EGPRS (8PSK)				
Channel		251	190	128
1Txslot	Target (dBm)	29.5	30	30.5
	Tolerance \pm (dB)	1	1	1
2Txslots	Target (dBm)	27	27	27
	Tolerance \pm (dB)	1	1	1
3Txslots	Target (dBm)	24.5	25	25
	Tolerance \pm (dB)	1	1	1

4Txslots	Target (dBm)	23.5	23.5	23.5
	Tolerance \pm (dB)	1	1	1

GSM 1900 GPRS				
Channel		810	661	512
1Txslot	Target (dBm)	30	30	30
	Tolerance \pm (dB)	1	1	1
2Txslots	Target (dBm)	27	27	27
	Tolerance \pm (dB)	1	1	1
3Txslots	Target (dBm)	24.5	24.5	25
	Tolerance \pm (dB)	1	1	1
4Txslots	Target (dBm)	23.5	23.5	23.5
	Tolerance \pm (dB)	1	1	1
GSM 1900 EGPRS (GMSK)				
Channel		810	661	512
1Txslot	Target (dBm)	29	29	29
	Tolerance \pm (dB)	1	1	1
2Txslots	Target (dBm)	26	26	26
	Tolerance \pm (dB)	1	1	1
3Txslots	Target (dBm)	23.5	24	24
	Tolerance \pm (dB)	1	1	1
4Txslots	Target (dBm)	23	23	23
	Tolerance \pm (dB)	1	1	1
GSM 1900 EGPRS (8PSK)				
Channel		810	661	512
1Txslot	Target (dBm)	24.5	24.5	24.5
	Tolerance \pm (dB)	1	1	1
2Txslots	Target (dBm)	21.5	21.5	21.5
	Tolerance \pm (dB)	1	1	1
3Txslots	Target (dBm)	19.5	19.5	19.5
	Tolerance \pm (dB)	1	1	1
4Txslots	Target (dBm)	18.5	18.5	18.5
	Tolerance \pm (dB)	1	1	1

Table 11.3: WCDMA

UMTS Band V		Conducted Power (dBm)		
		Channel 4233	Channel 4182	Channel 4132
CS	Target (dBm)	23.3	23.3	23.3
	Tolerance \pm (dB)	0.7	0.7	0.7
HSUPA sub-test 1	Target (dBm)	22.5	22.5	22.5
	Tolerance \pm (dB)	1	1	1
HSUPA sub-test 2	Target (dBm)	22	22	22
	Tolerance \pm (dB)	1	1	1
HSUPA sub-test 3	Target (dBm)	21.5	22	22
	Tolerance \pm (dB)	1	1	1
HSUPA sub-test 4	Target (dBm)	22	22.5	22
	Tolerance \pm (dB)	1	1	1
HSUPA sub-test 5	Target (dBm)	23	23	23
	Tolerance \pm (dB)	1	1	1
HSDPA sub-test 1-4	Target (dBm)	23	23	23
	Tolerance \pm (dB)	1	1	1
UMTS Band IV		Conducted Power(dBm)		
		Channel 1513	Channel 1413	Channel 1312
CS	Target (dBm)	24.5	24.5	24.5
	Tolerance \pm (dB)	0.7	0.7	0.7
HSUPA sub-test 1	Target (dBm)	22.5	22	22
	Tolerance \pm (dB)	1	1	1
HSUPA sub-test 2	Target (dBm)	21	21	21
	Tolerance \pm (dB)	1	1	1
HSUPA sub-test 3	Target (dBm)	21	21	21
	Tolerance \pm (dB)	1	1	1
HSUPA sub-test 4	Target (dBm)	22	22	22
	Tolerance \pm (dB)	1	1	1
HSUPA sub-test 5	Target (dBm)	22.5	22.5	22.5
	Tolerance \pm (dB)	1	1	1
HSDPA sub-test 1-4	Target (dBm)	22.5	22.5	22.5
	Tolerance \pm (dB)	1	1	1

UMTS Band II		Conducted Power(dBm)		
		Channel 9538	Channel 9400	Channel 9262
CS	Target (dBm)	23.5	23.5	23.5
	Tolerance \pm (dB)	0.7	0.7	0.7
HSUPA sub-test 1	Target (dBm)	22	22	22
	Tolerance \pm (dB)	1	1	1
HSUPA sub-test 2	Target (dBm)	21	21	21
	Tolerance \pm (dB)	1	1	1
HSUPA sub-test 3	Target (dBm)	20.5	20.5	20.5
	Tolerance \pm (dB)	1	1	1
HSUPA sub-test 4	Target (dBm)	21.5	21.5	21.5
	Tolerance \pm (dB)	1	1	1
HSUPA sub-test 5	Target (dBm)	22	22	22
	Tolerance \pm (dB)	1	1	1
HSDPA sub-test 1-4	Target (dBm)	22	22	22
	Tolerance \pm (dB)	1	1	1

Table 11.4: LTE

LTE Band 2QPSK			
Channel	Channel 19100	Channel 18900	Channel 18700
Target (dBm)	23	23	23
Tolerance \pm (dB)	1	1	1
LTE Band 4QPSK			
Channel	Channel 20300	Channel 20175	Channel 20050
Target (dBm)	23	23	23
Tolerance \pm (dB)	1	1	1
LTE Band 5QPSK			
Channel	Channel 20600	Channel 20525	Channel 20450
Target (dBm)	23	23	23
Tolerance \pm (dB)	1	1	1
LTE Band 12QPSK			
Channel	Channel 23130	Channel 23095	Channel 23060
Target (dBm)	23	23	23
Tolerance \pm (dB)	1	1	1

LTE Band 2 16QAM			
Channel	Channel 19100	Channel 18900	Channel 18700
Target (dBm)	22	22	22
Tolerance \pm (dB)	1	1	1
LTE Band 4 16QAM			
Channel	Channel 20300	Channel 20175	Channel 20050
Target (dBm)	22	22	22
Tolerance \pm (dB)	1	1	1
LTE Band 5 16QAM			
Channel	Channel 20600	Channel 20525	Channel 20450
Target (dBm)	22.8	22.8	22.8
Tolerance \pm (dB)	1	1	1
LTE Band 12 16QAM			
Channel	Channel 23130	Channel 23095	Channel 23060
Target (dBm)	22.8	22.8	22.8
Tolerance \pm (dB)	1	1	1

LTE Band 2 64QAM			
Channel	Channel 19100	Channel 18900	Channel 18700
Target (dBm)	22	22	22
Tolerance \pm (dB)	1	1	1
LTE Band 4 16QAM			
Channel	Channel 20300	Channel 20175	Channel 20050
Target (dBm)	21.8	21.8	21.8
Tolerance \pm (dB)	1	1	1
LTE Band 5 64QAM			
Channel	Channel 20600	Channel 20525	Channel 20450
Target (dBm)	22.8	22.8	22.8
Tolerance \pm (dB)	1	1	1
LTE Band 12 64QAM			
Channel	Channel 23130	Channel 23095	Channel 23060
Target (dBm)	22.8	22.8	22.8
Tolerance \pm (dB)	1	1	1

Table 11.5: Bluetooth

Mode		2402MHz (Ch0)	2441MHz (Ch39)	2480MHz (Ch78)
GFSK	Target (dBm)	-0.5	0	-1.5
	Tolerance \pm (dB)	1	1	1
EDR2M-4_DQPSK	Target (dBm)	0	0.5	-0.5
	Tolerance \pm (dB)	1	1	1
EDR3M-8DPSK	Target (dBm)	0	0.5	-0.5
	Tolerance \pm (dB)	1	1	1
GFSK(BLE)	Target (dBm)	-0.5	0	-1.5
	Tolerance \pm (dB)	1	1	1

Table 11.6: Wi-Fi

Mode	Channel/Data rate	Target (dBm)	Tolerance \pm (dB)
802.11 b (2.4GHz)	1Mbps	17	1
	2Mbps	17	1
	5.5Mbps	17	1
	11Mbps	17	1
802.11 g (2.4GHz)	6-9Mbps	17	1
	12-24Mbps	16.5	1
	36-48Mbps	16	1
	54Mbps	15	1
802.11 n (2.4GHz HT20)	MCS0	16.5	1
	MCS1	16	1
	MCS2	15.5	1
	MCS3-MCS5	15	1
	MCS6-MCS7	14.5	1

Table 11.7: GSM1900 (AP ON)

GSM 1900 GPRS				
Channel		810	661	512
1Txslot	Target (dBm)	26.5	26.5	26.5
	Tolerance \pm (dB)	1	1	1
2Txslots	Target (dBm)	26.5	26.5	26.5
	Tolerance \pm (dB)	1	1	1
3Txslots	Target (dBm)	24.5	24.5	25
	Tolerance \pm (dB)	1	1	1
4Txslots	Target (dBm)	23.5	23.5	23.5
	Tolerance \pm (dB)	1	1	1
GSM 1900 EGPRS (GMSK)				
Channel		810	661	512
1Txslot	Target (dBm)	26.5	26.5	26.5
	Tolerance \pm (dB)	1	1	1
2Txslots	Target (dBm)	26	26.5	26.5
	Tolerance \pm (dB)	1	1	1
3Txslots	Target (dBm)	24	24.5	24.5
	Tolerance \pm (dB)	1	1	1
4Txslots	Target (dBm)	23.5	23.5	23.5
	Tolerance \pm (dB)	1	1	1
GSM 1900 EGPRS (8PSK)				
Channel		810	661	512
1Txslot	Target (dBm)	25.5	25.5	26
	Tolerance \pm (dB)	1	1	1
2Txslots	Target (dBm)	23	23	23
	Tolerance \pm (dB)	1	1	1
3Txslots	Target (dBm)	21	21	21
	Tolerance \pm (dB)	1	1	1
4Txslots	Target (dBm)	20	20	20
	Tolerance \pm (dB)	1	1	1

Table 11.8: WCDMA1700/1900 (AP ON)

UMTS Band II		Conducted Power(dBm)		
		Channel 9538	9400	Channel 9262
CS	Target (dBm)	21	21	21
	Tolerance \pm (dB)	0.7	0.7	0.7
UMTS Band IV		Conducted Power(dBm)		
		Channel 1513	Channel 1413	Channel 1312
CS	Target (dBm)	21.5	21.5	21.5
	Tolerance \pm (dB)	0.7	0.7	0.7

Table 11.9: LTE-Band 2/4 (AP ON)

LTE Band 2		Conducted Power (dBm)		
		High	Middle	Low
QPSK	Target (dBm)	21.5	21.5	21.5
	Tolerance \pm (dB)	1	1	1
16QAM	Target (dBm)	21.3	21.3	21.3
	Tolerance \pm (dB)	1	1	1
64QAM	Target (dBm)	21	21	21
	Tolerance \pm (dB)	1	1	1
LTE Band 4		Conducted Power (dBm)		
		High	Middle	Low
QPSK	Target (dBm)	23	23	23
	Tolerance \pm (dB)	1	1	1
16QAM	Target (dBm)	22	22	22
	Tolerance \pm (dB)	1	1	1
64QAM	Target (dBm)	21.8	21.8	21.8
	Tolerance \pm (dB)	1	1	1

11.2 Hotspot

The conducted power is normal for all bands except PCS1900, WCDMA1700, WCDMA1900, LTE band 2 and LTE band 4. There is power reduction enabled for PCS1900, WCDMA1700, WCDMA1900, LTE band 2 and LTE band 4. The power reduction is enabled when the user enables hotspot mode via the manufacturer software. The tables below show the measured powers with hotspot.

Table 11.10: The conducted power measurement results for GSM1900

GSM 1900MHz	Conducted Power(dBm)		
	Channel 810(1909.8MHz)	Channel 661(1880MHz)	Channel 512(1850.2MHz)
	26.26	26.69	26.85

Table 11.11: The conducted power measurement results for GPRS and EGPRS

GSM 1900		Measured Power (dBm)			calculation	Average Power (dBm)		
		810	661	512		810	661	512
GPRS	1Txslots	26.19	26.65	26.84	-9.03dB	17.16	17.62	17.81
	2Txslots	26.04	26.56	26.78	-6.02dB	20.02	20.54	20.76
	3Txslots	24.08	24.74	24.99	-4.26dB	19.82	20.48	20.73
	4Txslots	23.59	23.58	23.80	-3.01dB	20.58	20.57	20.79
EGPRS (GMSK)	1Txslots	26.28	26.60	26.67	-9.03dB	17.25	17.57	17.64
	2Txslots	26.11	26.34	26.46	-6.02dB	20.09	20.32	20.44
	3Txslots	24.00	24.62	24.75	-4.26dB	19.74	20.36	20.49
	4Txslots	23.49	23.39	23.52	-3.01dB	20.48	20.38	20.51
EGPRS(8PSK)	1Txslots	25.55	25.78	25.96	-9.03dB	16.52	16.75	16.93
	2Txslots	22.99	23.27	23.43	-6.02dB	16.97	17.25	17.41
	3Txslots	20.91	21.20	21.35	-4.26dB	16.65	16.94	17.09
	4Txslots	19.75	20.02	20.25	-3.01dB	16.74	17.01	17.24

NOTES:

1) Division Factors

To average the power, the division factor is as follows:

1TX-slot = 1 transmit time slot out of 8 time slots=> conducted power divided by (8/1) => -9.03dB

2TX-slots = 2 transmit time slots out of 8 time slots=> conducted power divided by (8/2) => -6.02dB

3TX-slots = 3 transmit time slots out of 8 time slots=> conducted power divided by (8/3) => -4.26dB

4TX-slots = 4 transmit time slots out of 8 time slots=> conducted power divided by (8/4) => -3.01dB

According to the conducted power as above, the body measurements are performed with 4Txslot for GPRS and EGPRS.

Table 11.12: The conducted Power for WCDMA

Item	band	FDDIV result		
	ARFCN	1513 (1752.6MHz)	1412 (1732.4MHz)	1312 (1712.4MHz)
WCDMA	\	21.90	21.80	21.80
Item	band	FDDII result		
	ARFCN	9538(1907.6MHz)	9400(1880MHz)	9262(1852.4MHz)
WCDMA	\	21.10	20.90	20.90

Table 11.13: The conducted Power for LTE

LTE-FDD Band 2				Actual output Power (dBm)			
Band-width	RB allocation	RB offset	Modulation	High	Middle	Low	
1.4 MHz				1909.3MHz	1880MHz	1850.7MHz	
	1RB	High	QPSK	21.39	21.31	21.34	
			16QAM	21.05	21.02	21.20	
			64QAM	20.78	20.69	20.99	
		Middle	QPSK	21.44	21.49	21.31	
			16QAM	21.04	21.15	21.15	
			64QAM	20.89	20.95	20.94	
		Low	QPSK	21.29	21.46	21.37	
			16QAM	20.95	21.13	21.05	
			64QAM	20.66	20.73	20.68	
	3RB	High	QPSK	21.50	21.48	21.54	
			16QAM	21.56	21.31	21.34	
			64QAM	21.44	21.17	21.00	
		Middle	QPSK	21.55	21.51	21.50	
			16QAM	21.55	21.35	21.45	
			64QAM	21.05	21.11	21.10	
		Low	QPSK	21.51	21.46	21.43	
			16QAM	21.42	21.30	21.38	
			64QAM	21.23	21.03	21.08	
	6RB	/	QPSK	21.47	21.33	21.43	
			16QAM	21.29	21.10	21.28	
			64QAM	20.98	20.95	21.09	
	3 MHz				1908.5MHz	1880MHz	1851.5MHz
		1RB	High	QPSK	21.41	21.48	21.49
				16QAM	21.05	20.98	21.33
				64QAM	20.79	20.76	21.04
			Middle	QPSK	21.55	21.63	21.36
16QAM				21.25	21.25	21.42	
64QAM				21.03	21.11	21.20	
Low			QPSK	21.56	21.42	21.35	
			16QAM	20.93	21.12	21.04	
			64QAM	20.77	20.88	20.62	
8RB		High	QPSK	21.56	21.52	21.48	
			16QAM	21.70	21.47	21.57	
			64QAM	21.28	21.10	21.36	
		Middle	QPSK	21.48	21.55	21.52	
			16QAM	21.65	21.54	21.51	
			64QAM	21.35	21.39	21.40	
Low		QPSK	21.56	21.52	21.50		

	15RB	/	16QAM	21.61	21.43	21.45
			64QAM	21.45	21.03	21.31
			QPSK	21.53	21.52	21.48
			16QAM	21.41	21.21	21.54
			64QAM	21.19	21.09	21.37
5 MHz				1907.5MHz	1880MHz	1852.5MHz
	1RB	High	QPSK	21.11	21.38	21.19
			16QAM	21.49	20.89	21.12
			64QAM	21.14	20.75	20.79
		Middle	QPSK	21.50	21.52	21.47
			16QAM	21.17	21.31	21.52
			64QAM	20.79	20.87	20.88
		Low	QPSK	21.39	21.46	21.23
			16QAM	21.08	21.06	21.28
			64QAM	20.86	20.88	20.93
	12RB	High	QPSK	21.47	21.46	21.44
			16QAM	21.44	21.46	21.32
			64QAM	21.07	21.06	21.09
		Middle	QPSK	21.50	21.49	21.48
			16QAM	21.43	21.54	21.34
			64QAM	21.02	21.13	20.96
		Low	QPSK	21.41	21.45	21.48
			16QAM	21.24	21.44	21.38
			64QAM	20.07	21.13	20.99
	25RB	/	QPSK	21.44	21.46	21.47
			16QAM	21.52	21.50	21.44
			64QAM	21.14	21.09	21.05

LTE-FDD Band 2				Actual output Power (dBm)			
10 MHz	1RB	High		1905MHz	1880MHz	1855MHz	
			QPSK	21.56	21.41	21.34	
			16QAM	21.26	20.93	21.22	
			64QAM	20.99	20.69	20.88	
	Middle		QPSK	21.57	21.61	21.40	
				16QAM	21.44	21.23	21.34
				64QAM	21.01	20.93	20.98
	Low		QPSK	21.55	21.58	21.37	
				16QAM	21.30	21.22	21.18
				64QAM	20.94	20.80	20.86
10 MHz	25RB	High	QPSK	21.59	21.46	21.53	
				16QAM	21.56	21.51	21.58
				64QAM	21.37	21.26	21.34
		Middle	QPSK	21.62	21.58	21.53	
				16QAM	21.64	21.54	21.49
				64QAM	21.22	21.17	21.29
	Low	QPSK	21.61	21.56	21.59		
			16QAM	21.56	21.69	21.51	
			64QAM	21.34	21.20	21.10	
	50RB	/	QPSK	21.54	21.46	21.56	
				16QAM	21.65	21.58	21.52
				64QAM	21.14	21.21	21.09
15 MHz	1RB	High		1902.5MHz	1880MHz	1857.5MHz	
			QPSK	21.57	21.72	21.57	
			16QAM	20.96	21.80	21.36	
			64QAM	20.78	21.06	20.86	
	Middle		QPSK	21.68	21.48	21.64	
				16QAM	21.36	21.39	21.10
				64QAM	21.03	21.09	21.00
	Low		QPSK	21.69	21.48	21.56	
				16QAM	21.47	21.37	20.86
				64QAM	21.14	21.07	20.87
15 MHz	36RB	High	QPSK	21.67	21.66	21.69	
				16QAM	21.86	21.69	21.49
				64QAM	21.68	21.59	21.44
		Middle	QPSK	21.73	21.65	21.61	
				16QAM	21.65	21.49	21.47
				64QAM	21.55	21.33	21.09
	Low	QPSK	21.68	21.67	21.64		
			16QAM	21.62	21.63	21.68	
			64QAM	21.35	21.34	21.55	

	75RB	/	QPSK	21.73	21.73	21.67
			16QAM	21.68	21.61	21.72
			64QAM	21.56	21.45	21.55
20 MHz				1900MHz	1880MHz	1860MHz
	1RB	High	QPSK	21.24	21.50	21.40
			16QAM	21.14	21.06	21.11
			64QAM	20.97	20.88	20.85
		Middle	QPSK	21.55	21.64	21.61
			16QAM	21.87	21.42	21.34
			64QAM	21.34	21.35	21.47
		Low	QPSK	21.28	21.60	21.63
			16QAM	21.16	21.40	21.30
			64QAM	20.78	20.84	21.14
	50RB	High	QPSK	21.54	21.54	21.53
			16QAM	21.51	21.47	21.47
			64QAM	21.48	21.39	21.45
		Middle	QPSK	21.58	21.52	21.53
			16QAM	21.46	21.61	21.57
			64QAM	21.49	21.42	21.47
		Low	QPSK	21.64	21.52	21.55
			16QAM	21.52	21.60	21.56
			64QAM	21.55	21.60	21.45
	100RB	/	QPSK	21.48	21.46	21.49
			16QAM	21.55	21.55	21.55
			64QAM	21.32	21.53	21.24

LTE-FDD Band 4				Actual output Power (dBm)			
Band-width	RB allocation	RB offset	Modulation	High	Middle	Low	
1.4 MHz				1754.3MHz	1732.5MHz	1710.7MHz	
	1RB	High	QPSK	23.19	23.33	23.45	
			16QAM	22.10	22.02	22.14	
			64QAM	21.40	21.68	21.80	
		Middle	QPSK	23.32	23.39	23.40	
			16QAM	22.11	22.19	22.20	
			64QAM	21.98	22.09	22.03	
		Low	QPSK	23.25	23.47	23.42	
			16QAM	22.00	22.01	21.89	
			64QAM	21.75	21.83	21.42	
	3RB	High	QPSK	23.52	23.64	23.63	
			16QAM	22.28	22.33	22.45	
			64QAM	22.06	22.17	22.39	
		Middle	QPSK	23.49	23.60	23.68	
			16QAM	22.44	22.46	22.45	
			64QAM	22.19	22.31	22.07	
		Low	QPSK	23.41	23.68	23.68	
			16QAM	22.38	22.43	22.45	
			64QAM	22.32	22.21	22.07	
	6RB	/	QPSK	22.35	22.46	22.54	
			16QAM	21.40	21.45	21.30	
			64QAM	21.02	21.14	21.27	
	3 MHz				1753.5MHz	1732.5MHz	1711.5MHz
		1RB	High	QPSK	23.29	23.43	23.50
				16QAM	22.13	21.91	21.90
				64QAM	21.67	21.06	21.48
			Middle	QPSK	23.27	23.39	23.56
16QAM				22.25	22.23	22.13	
64QAM				22.14	22.02	21.96	
Low			QPSK	23.11	23.39	23.54	
			16QAM	21.93	22.19	22.24	
			64QAM	21.69	21.82	21.89	
8RB		High	QPSK	22.43	22.54	22.56	
			16QAM	21.43	21.53	21.59	
			64QAM	21.30	21.28	20.99	
		Middle	QPSK	22.48	22.52	22.55	
			16QAM	21.49	21.59	21.62	
			64QAM	21.06	21.24	21.34	
		Low	QPSK	22.35	22.56	22.60	
			16QAM	21.48	21.57	21.58	

			64QAM	21.31	21.28	21.33
	15RB	/	QPSK	22.43	22.51	22.58
			16QAM	21.42	21.52	21.49
			64QAM	21.40	21.29	21.22
				1752.5MHz	1732.5MHz	1712.5MHz
5 MHz	1RB	High	QPSK	23.30	23.37	23.35
			16QAM	22.23	21.94	21.92
			64QAM	22.09	21.76	21.52
		Middle	QPSK	23.43	23.36	23.36
			16QAM	22.25	22.23	21.96
			64QAM	22.10	22.05	21.89
		Low	QPSK	23.41	23.31	23.42
			16QAM	21.88	21.72	21.96
			64QAM	21.65	21.50	21.49
	12RB	High	QPSK	22.53	22.43	22.52
			16QAM	21.26	21.28	21.27
			64QAM	21.06	21.16	21.04
		Middle	QPSK	22.50	22.52	22.46
			16QAM	21.32	21.40	21.50
			64QAM	21.08	21.22	21.07
		Low	QPSK	22.46	22.42	22.52
			16QAM	21.40	21.37	21.48
			64QAM	21.04	21.00	21.22
	25RB	/	QPSK	22.45	22.51	22.58
			16QAM	21.45	21.43	21.58
			64QAM	21.08	21.22	21.45

LTE-FDD Band 4				Actual output Power (dBm)			
10 MHz	1RB	High		1750MHz	1732.5MHz	1715MHz	
			QPSK	23.56	23.43	23.49	
			16QAM	22.24	22.24	22.25	
			64QAM	22.04	22.06	22.19	
	Middle		QPSK	23.56	23.49	23.50	
				16QAM	22.27	22.25	22.11
				64QAM	22.01	22.03	21.90
	Low		QPSK	23.64	23.51	23.65	
				16QAM	22.43	22.32	22.21
				64QAM	22.24	22.19	22.14
10 MHz	25RB	High	QPSK	22.50	22.41	22.54	
				16QAM	21.53	21.31	21.50
				64QAM	21.26	21.08	21.38
		Middle	QPSK	22.50	22.50	22.59	
				16QAM	21.51	21.46	21.55
				64QAM	21.21	21.32	21.18
	Low	QPSK	22.50	22.51	22.41		
			16QAM	21.44	21.42	21.43	
			64QAM	21.04	21.06	21.22	
	50RB	/	QPSK	22.55	22.58	22.52	
				16QAM	21.57	21.46	21.54
				64QAM	21.37	21.38	21.42
15 MHz	1RB	High		1747.5MHz	1732.5MHz	1717.5MHz	
			QPSK	23.44	23.35	23.57	
			16QAM	21.90	22.48	22.24	
			64QAM	21.13	21.48	21.77	
	Middle		QPSK	23.44	23.59	23.59	
				16QAM	22.34	22.16	22.24
				64QAM	22.35	22.09	22.14
	Low		QPSK	23.44	23.53	23.63	
				16QAM	22.37	22.25	21.88
				64QAM	22.19	22.05	21.80
15 MHz	36RB	High	QPSK	23.54	23.47	23.57	
				16QAM	22.73	22.53	22.59
				64QAM	22.37	22.30	22.19
		Middle	QPSK	23.66	23.57	23.38	
				16QAM	22.54	22.49	22.41
				64QAM	22.34	22.10	22.09
	Low	QPSK	23.67	23.56	23.58		
			16QAM	22.57	22.41	22.50	
			64QAM	22.05	22.00	22.13	

	75RB	/	QPSK	22.78	22.57	22.54
			16QAM	21.63	21.47	21.58
			64QAM	21.30	21.09	21.32
20 MHz				1745MHz	1732.5MHz	1720MHz
	1RB	High	QPSK	22.50	22.36	22.51
			16QAM	22.22	22.68	21.99
			64QAM	21.81	21.99	21.61
		Middle	QPSK	22.64	22.58	22.55
			16QAM	22.25	22.62	22.17
			64QAM	22.34	22.33	21.98
		Low	QPSK	22.58	22.49	22.39
			16QAM	22.34	21.74	22.25
			64QAM	22.20	22.31	22.10
	50RB	High	QPSK	22.40	22.40	22.44
			16QAM	21.40	21.47	21.45
			64QAM	21.43	21.40	21.38
		Middle	QPSK	22.51	22.51	22.54
			16QAM	21.53	21.56	21.48
			64QAM	21.41	21.40	21.52
		Low	QPSK	22.70	22.49	22.44
			16QAM	21.63	21.46	21.45
			64QAM	21.55	21.43	21.46
	100RB	/	QPSK	22.54	22.45	22.51
			16QAM	21.48	21.42	21.35
			64QAM	21.48	21.21	21.36

11.3 GSM Measurement result

During the process of testing, the EUT was controlled via Agilent Digital Radio Communication tester (E5515C) to ensure the maximum power transmission and proper modulation. This result contains conducted output power for the EUT. In all cases, the measured peak output power should be greater and within 5% than EMI measurement.

Table 11.14: The conducted power measurement results for GSM850/1900

GSM 850MHz	Conducted Power (dBm)		
	Channel 251(848.8MHz)	Channel 190(836.6MHz)	Channel 128(824.2MHz)
	32.54	32.93	32.80
GSM 1900MHz	Conducted Power(dBm)		
	Channel 810(1909.8MHz)	Channel 661(1880MHz)	Channel 512(1850.2MHz)
	29.62	30.08	30.48

Table 11.15: The conducted power measurement results for GPRS and EGPRS

GSM 850		Measured Power (dBm)			calculation	Average Power (dBm)		
		251	190	128		251	190	128
GPRS	1Txslots	32.51	32.88	32.77	-9.03dB	23.48	23.85	23.74
	2Txslots	29.30	29.16	29.25	-6.02dB	23.28	23.14	23.23
	3Txslots	27.09	27.00	27.06	-4.26dB	22.83	22.74	22.8
	4Txslots	26.09	26.03	26.35	-3.01dB	23.08	23.02	23.34
EGPRS (GMSK)	1Txslots	32.51	32.88	32.77	-9.03dB	22.83	23.21	23.13
	2Txslots	29.30	29.16	29.25	-6.02dB	22.59	22.59	22.65
	3Txslots	27.09	27.00	27.06	-4.26dB	22.19	22.16	22.21
	4Txslots	26.09	26.03	26.35	-3.01dB	22.45	22.43	22.73
EGPRS (8PSK)	1Txslots	25.09	25.12	25.11	-9.03dB	16.06	16.09	16.08
	2Txslots	22.01	22.01	21.99	-6.02dB	15.99	15.99	15.97
	3Txslots	20.45	20.35	20.50	-4.26dB	16.19	16.09	16.24
	4Txslots	19.33	19.29	19.46	-3.01dB	16.32	16.28	16.45
GSM 1900		Measured Power (dBm)			calculation	Average Power (dBm)		
		810	661	512		810	661	512
GPRS	1Txslots	29.61	30.05	30.48	-9.03dB	20.58	21.02	21.45
	2Txslots	26.66	26.90	27.13	-6.02dB	20.64	20.88	21.11
	3Txslots	24.03	24.87	25.15	-4.26dB	19.77	20.61	20.89
	4Txslots	23.52	23.57	23.80	-3.01dB	20.51	20.56	20.79
EGPRS (GMSK)	1Txslots	28.95	29.22	29.47	-9.03dB	19.92	20.19	20.44
	2Txslots	25.93	26.06	26.15	-6.02dB	19.91	20.04	20.13
	3Txslots	23.30	24.03	24.17	-4.26dB	19.04	19.77	19.91
	4Txslots	22.76	22.65	22.90	-3.01dB	19.75	19.64	19.89
EGPRS (8PSK)	1Txslots	24.51	24.72	24.94	-9.03dB	15.48	15.69	15.91
	2Txslots	21.40	21.61	21.84	-6.02dB	15.38	15.59	15.82
	3Txslots	19.22	19.43	19.70	-4.26dB	14.96	15.17	15.44
	4Txslots	18.43	18.68	18.77	-3.01dB	15.42	15.67	15.76

NOTES:

1) Division Factors

To average the power, the division factor is as follows:

1TX-slot = 1 transmit time slot out of 8 time slots=> conducted power divided by (8/1) => -9.03dB

2TX-slots = 2 transmit time slots out of 8 time slots=> conducted power divided by (8/2) => -6.02dB

3TX-slots = 3 transmit time slots out of 8 time slots=> conducted power divided by (8/3) => -4.26dB

4TX-slots = 4 transmit time slots out of 8 time slots=> conducted power divided by (8/4) => -3.01dB

According to the conducted power as above, the body measurements are performed with 1Txslots for GSM 850 and 1Txslots for GSM 1900.

11.4 WCDMA Measurement result

Table 11.16: The conducted Power for WCDMA850/1700/1900

Item	band	FDDBand 5 result		
	ARFCN	4233 (846.6MHz)	4182(836.4MHz)	4132 (826.4MHz)
WCDMA	\	23.86	23.84	23.93
HSDPA	1	23.1	23.2	23.2
	2	23.1	23.2	23.3
	3	22.6	22.7	22.7
	4	22.6	22.7	22.6
HSUPA	1	22.5	22.5	22.5
	2	22.0	22.1	21.7
	3	21.6	21.9	22.0
	4	22.4	22.7	22.0
	5	23.0	23.2	23.1
Item	band	FDDBand4 result		
	ARFCN	1513 (1752.6MHz)	1413(1732.6MHz)	1312 (1712.4MHz)
WCDMA	\	24.86	24.77	24.88
HSDPA	1	22.6	22.5	22.4
	2	22.6	22.5	22.5
	3	22.1	22.0	22.0
	4	22.1	22.2	22.0
HSUPA	1	22.6	21.8	21.7
	2	21.4	21.0	20.9
	3	21.3	21.0	21.0
	4	22.0	22.2	22.0
	5	22.5	22.5	22.5
Item	band	FDD Band2 result		
	ARFCN	9538 (1907.6MHz)	9400 (1880MHz)	9262 (1852.4MHz)
WCDMA	\	23.69	23.83	23.78
HSDPA	1	22.1	22.1	22.2
	2	22.1	22.2	22.2
	3	21.5	21.6	21.7
	4	21.6	21.6	21.8
HSUPA	1	22.2	22.2	22.2
	2	21.1	21.2	21.3
	3	20.7	20.8	20.7
	4	21.6	21.7	21.7
	5	22.2	22.3	22.2

11.5LTE-FDD Measurement result

Table 11.17: The conducted Power for LTE-FDD

LTE-FDD Band 2				Actual output Power (dBm)			
Band-width	RAllocation	RBoffset	Modulation	High	Middle	Low	
1.4 MHz				1909.3MHz	1880MHz	1850.7MHz	
	1RB	High	QPSK	23.35	23.27	23.41	
			16QAM	22.26	22.41	22.31	
			64QAM	22.02	22.24	22.15	
		Middle	QPSK	23.47	23.45	23.50	
			16QAM	22.33	22.31	22.56	
			64QAM	22.01	22.06	22.33	
		Low	QPSK	23.34	23.48	23.47	
			16QAM	22.22	22.25	22.30	
			64QAM	21.98	22.05	22.11	
	3RB	High	QPSK	23.55	23.48	23.59	
			16QAM	22.48	22.44	22.64	
			64QAM	22.07	22.01	22.46	
		Middle	QPSK	23.63	23.51	23.60	
			16QAM	22.57	22.44	22.62	
			64QAM	22.25	22.17	22.28	
		Low	QPSK	23.53	23.62	23.77	
			16QAM	22.50	22.48	22.58	
			64QAM	22.19	22.09	22.22	
	6RB	/	QPSK	22.58	22.43	22.54	
			16QAM	21.47	21.39	21.45	
			64QAM	21.27	21.02	21.27	
	3 MHz				1908.5MHz	1880MHz	1851.5MHz
		1RB	High	QPSK	23.43	23.55	23.54
16QAM				22.04	22.16	22.28	
64QAM				21.89	21.96	21.99	
Middle			QPSK	23.50	23.72	23.51	
			16QAM	22.39	22.42	22.64	
			64QAM	22.19	22.22	22.25	
Low			QPSK	23.24	23.75	23.60	
			16QAM	22.29	22.33	22.35	
			64QAM	22.16	22.11	22.02	
8RB		High	QPSK	22.60	22.66	22.66	
			16QAM	21.77	21.68	21.59	
			64QAM	21.28	21.29	21.22	
		Middle	QPSK	22.60	22.65	22.67	
			16QAM	21.75	21.66	21.68	
			64QAM	21.51	21.29	21.38	

		Low	QPSK	22.58	22.45	22.64
			16QAM	21.70	21.68	21.62
			64QAM	21.38	21.29	21.39
	15RB	/	QPSK	22.64	22.64	22.62
			16QAM	21.65	21.59	21.41
			64QAM	21.26	21.29	21.25
5 MHz				1907.5MHz	1880MHz	1852.5MHz
	1RB	High	QPSK	23.36	23.41	23.31
			16QAM	22.11	22.33	22.24
			64QAM	21.79	21.96	21.98
		Middle	QPSK	23.36	23.50	23.36
			16QAM	22.21	22.31	22.30
			64QAM	22.08	22.11	22.19
		Low	QPSK	23.31	23.46	23.43
			16QAM	21.98	22.32	22.27
			64QAM	21.79	21.97	22.06
	12RB	High	QPSK	22.55	22.49	22.62
			16QAM	21.54	21.48	21.43
			64QAM	21.33	21.25	21.39
		Middle	QPSK	22.56	22.70	22.57
			16QAM	21.48	21.42	21.39
			64QAM	21.39	21.29	21.11
		Low	QPSK	22.46	22.60	22.57
			16QAM	21.52	21.45	21.51
			64QAM	21.29	21.32	21.38
	25RB	/	QPSK	22.54	22.47	22.54
			16QAM	21.58	21.63	21.55
			64QAM	21.32	21.36	21.09

LTE-FDD Band 2				Actual output Power (dBm)			
				1905MHz	1880MHz	1855MHz	
10 MHz	1RB	High	QPSK	23.25	23.41	23.58	
			16QAM	22.23	22.37	22.23	
			64QAM	22.01	22.04	21.90	
		Middle	QPSK	23.28	23.55	23.60	
			16QAM	22.42	22.44	22.34	
			64QAM	22.31	22.33	22.11	
		Low	QPSK	23.36	23.59	23.63	
			16QAM	22.50	22.29	22.28	
			64QAM	22.18	22.06	22.09	
	25RB	High	QPSK	22.56	22.50	22.62	
			16QAM	21.61	21.49	21.62	
			64QAM	21.36	21.41	21.50	
		Middle	QPSK	22.47	22.63	22.69	
			16QAM	21.67	21.60	21.65	
			64QAM	21.33	21.23	21.20	
		Low	QPSK	22.53	22.59	22.66	
			16QAM	21.59	21.72	21.54	
			64QAM	21.39	21.29	21.48	
	50RB	/	QPSK	22.61	22.58	22.63	
			16QAM	21.73	21.52	21.55	
			64QAM	21.54	21.32	21.13	
	15 MHz				1902.5MHz	1880MHz	1857.5MHz
		1RB	High	QPSK	23.41	23.79	23.64
				16QAM	22.47	22.25	22.94
				64QAM	22.09	21.97	22.68
			Middle	QPSK	23.61	23.61	23.65
				16QAM	22.42	22.35	22.91
64QAM				22.38	22.19	22.68	
Low			QPSK	23.61	23.69	23.42	
			16QAM	22.38	22.41	22.51	
			64QAM	22.18	22.19	22.29	
36RB		High	QPSK	23.78	23.71	23.62	
			16QAM	22.75	22.76	22.62	
			64QAM	22.68	22.49	22.35	
		Middle	QPSK	23.60	23.58	23.63	
			16QAM	22.65	22.72	22.58	
			64QAM	22.54	22.39	22.36	
		Low	QPSK	23.64	23.67	23.62	
			16QAM	22.54	22.76	22.50	
			64QAM	22.30	22.56	22.32	

	75RB	/	QPSK	22.76	22.73	22.69
			16QAM	21.73	21.69	21.66
			64QAM	21.31	21.09	21.20
				1900MHz	1880MHz	1860MHz
20 MHz	1RB	High	QPSK	23.21	23.36	23.27
			16QAM	22.30	22.24	22.24
			64QAM	22.36	21.73	21.98
		Middle	QPSK	23.50	23.43	23.75
			16QAM	22.35	22.80	22.74
			64QAM	22.53	22.43	22.31
		Low	QPSK	23.25	23.56	23.38
			16QAM	22.15	21.97	22.24
			64QAM	21.97	22.09	22.15
	50RB	High	QPSK	22.58	22.51	22.52
			16QAM	21.68	21.58	21.41
			64QAM	21.34	21.36	21.39
		Middle	QPSK	22.58	22.65	22.61
			16QAM	21.62	21.59	21.76
			64QAM	21.37	21.34	21.38
		Low	QPSK	22.63	22.64	22.59
			16QAM	21.59	21.56	21.69
			64QAM	21.41	21.41	21.44
	100RB	/	QPSK	22.49	22.50	22.59
			16QAM	21.60	21.49	21.69
			64QAM	21.24	21.25	21.34

LTE-FDD Band 4				Actual output Power (dBm)			
Band-width	RAllocation	RBoffset	Modulation	High	Middle	Low	
1.4 MHz				1754.3MHz	1732.5MHz	1710.7MHz	
	1RB	High	QPSK	23.11	23.32	23.35	
			16QAM	22.04	21.81	22.18	
			64QAM	21.88	21.59	21.79	
		Middle	QPSK	23.19	23.37	23.34	
			16QAM	22.20	22.13	22.06	
			64QAM	22.00	21.90	21.92	
		Low	QPSK	23.16	23.20	23.31	
			16QAM	22.07	21.78	22.23	
			64QAM	21.93	21.64	21.89	
	3RB	High	QPSK	23.40	23.39	23.56	
			16QAM	22.22	22.26	22.33	
			64QAM	22.09	22.01	22.16	
		Middle	QPSK	23.38	23.42	23.59	
			16QAM	22.28	22.37	22.41	
			64QAM	22.07	22.09	22.06	
		Low	QPSK	23.40	23.53	23.46	
			16QAM	22.25	22.35	22.37	
			64QAM	22.17	22.22	22.09	
	6RB	/	QPSK	22.22	22.33	22.43	
			16QAM	21.11	21.32	21.03	
			64QAM	21.02	21.11	20.88	
	3 MHz				1753.5MHz	1732.5MHz	1711.5MHz
		1RB	High	QPSK	23.25	23.35	23.33
				16QAM	22.03	21.83	21.88
				64QAM	21.86	21.36	21.33
			Middle	QPSK	23.11	23.33	23.30
16QAM				22.21	22.17	22.03	
64QAM				21.87	21.95	21.86	
Low			QPSK	23.22	23.19	23.46	
			16QAM	22.21	21.93	21.93	
			64QAM	21.87	21.68	21.56	
8RB		High	QPSK	22.31	22.41	22.40	
			16QAM	21.41	21.52	21.47	
			64QAM	21.09	21.24	21.09	
		Middle	QPSK	22.40	22.44	22.49	
			16QAM	21.48	21.58	21.49	
			64QAM	21.23	21.18	21.26	
		Low	QPSK	22.33	22.49	22.46	
			16QAM	21.37	21.50	21.44	
			64QAM	21.06	21.30	21.02	

	15RB	/	QPSK	22.27	22.49	22.47
			16QAM	21.40	21.40	21.51
			64QAM	21.04	21.21	21.47
				1752.5MHz	1732.5MHz	1712.5MHz
5 MHz	1RB	High	QPSK	23.14	23.39	23.26
			16QAM	22.19	21.80	22.03
			64QAM	21.88	21.64	21.78
		Middle	QPSK	23.49	23.41	23.46
			16QAM	22.27	22.24	22.10
			64QAM	22.17	22.10	22.01
		Low	QPSK	23.40	23.28	23.35
			16QAM	22.23	21.77	22.09
			64QAM	22.01	21.44	21.85
	12RB	High	QPSK	22.50	22.46	22.47
			16QAM	21.44	21.32	21.25
			64QAM	21.13	21.02	21.05
		Middle	QPSK	22.56	22.50	22.46
			16QAM	21.41	21.39	21.34
			64QAM	21.13	21.07	21.00
		Low	QPSK	22.54	22.45	22.55
			16QAM	21.40	21.26	21.42
			64QAM	21.06	21.00	21.13
	25RB	/	QPSK	22.52	22.47	22.60
			16QAM	21.44	21.43	21.47
			64QAM	21.33	21.16	21.32

LTE-FDD Band 4				Actual output Power (dBm)			
				1750MHz	1732.5MHz	1715MHz	
10 MHz	1RB	High	QPSK	23.34	23.46	23.44	
			16QAM	22.19	22.21	22.23	
			64QAM	21.86	21.69	21.88	
		Middle	QPSK	23.47	23.56	23.52	
			16QAM	22.08	22.37	22.12	
			64QAM	21.90	22.10	22.03	
		Low	QPSK	23.55	23.41	23.66	
			16QAM	22.36	22.11	22.24	
			64QAM	21.98	21.79	21.88	
	25RB	High	QPSK	22.45	22.51	22.53	
			16QAM	21.46	21.38	21.44	
			64QAM	21.44	21.20	21.21	
		Middle	QPSK	22.58	22.54	22.51	
			16QAM	21.54	21.50	21.50	
			64QAM	21.25	21.33	21.14	
		Low	QPSK	22.52	22.54	22.43	
			16QAM	21.40	21.41	21.44	
			64QAM	21.03	21.08	21,19	
	50RB	/	QPSK	22.53	22.53	22.52	
			16QAM	21.40	21.43	21.33	
			64QAM	21.07	21.20	21.08	
	15 MHz				1747.5MHz	1732.5MHz	1717.5MHz
		1RB	High	QPSK	23.55	23.41	23.57
				16QAM	22.79	22.05	22.49
				64QAM	22.49	21.67	22.19
			Middle	QPSK	23.43	23.42	23.43
				16QAM	22.26	22.15	22.21
64QAM				22.02	21.98	21.98	
Low			QPSK	23.49	23.53	23.64	
			16QAM	22.33	22.26	22.30	
			64QAM	22.00	22.01	22.03	
36RB		High	QPSK	23.54	23.53	23.63	
			16QAM	22.44	22.46	22.63	
			64QAM	22.02	22.16	22.19	
		Middle	QPSK	23.65	23.42	23.38	
			16QAM	22.70	22.42	22.36	
			64QAM	22.46	22.10	22.09	
		Low	QPSK	23.66	23.50	23.54	
			16QAM	22.78	22.32	22.48	
			64QAM	22.33	22.09	22.14	

	75RB	/	QPSK	22.83	22.58	22.57
			16QAM	21.68	21.47	21.43
			64QAM	21.33	21.23	21.05
				1745MHz	1732.5MHz	1720MHz
20 MHz	1RB	High	QPSK	23.50	23.22	23.30
			16QAM	22.09	22.03	22.20
			64QAM	21.74	22.07	21.83
		Middle	QPSK	23.55	23.38	23.43
			16QAM	22.18	22.20	22.71
			64QAM	22.33	22.22	22.22
		Low	QPSK	23.40	23.43	23.59
			16QAM	22.27	22.18	22.17
			64QAM	21.82	21.70	22.11
	50RB	High	QPSK	22.45	22.37	22.41
			16QAM	21.57	21.27	21.39
			64QAM	21.39	21.24	21.29
		Middle	QPSK	22.50	22.54	22.54
			16QAM	21.58	21.38	21.49
			64QAM	21.48	21.38	21.32
		Low	QPSK	22.67	22.43	22.45
			16QAM	21.67	21.33	21.42
			64QAM	21.49	21.28	21.28
	100RB	/	QPSK	22.52	22.42	22.51
			16QAM	21.52	21.43	21.46
			64QAM	21.33	21.25	21.18

LTE-FDD Band 5				Actual output Power (dBm)			
Band-width	RAllocation	RBoffset	Modulation	High	Middle	Low	
1.4 MHz				848.3MHz	836.5MHz	824.7MHz	
	1RB	High	QPSK	22.83	23.10	23.05	
			16QAM	22.73	23.10	23.01	
			64QAM	22.67	22.95	22.89	
		Middle	QPSK	23.04	23.09	23.08	
			16QAM	22.91	22.92	23.21	
			64QAM	22.90	22.77	22.99	
		Low	QPSK	22.91	23.07	23.03	
			16QAM	22.79	22.78	22.95	
			64QAM	22.76	22.58	22.77	
	3RB	High	QPSK	23.17	23.22	23.32	
			16QAM	23.22	23.21	23.14	
			64QAM	23.11	23.09	23.01	
		Middle	QPSK	23.21	23.20	23.24	
			16QAM	23.38	23.29	23.30	
			64QAM	23.06	23.06	23.26	
		Low	QPSK	23.17	23.16	23.19	
			16QAM	23.36	23.27	23.24	
			64QAM	23.16	23.07	21.12	
	6RB	/	QPSK	23.04	23.15	23.12	
			16QAM	22.09	22.16	22.28	
			64QAM	22.07	22.19	22.30	
	3 MHz				847.5MHz	836.5MHz	825.5MHz
		1RB	High	QPSK	23.03	23.03	23.20
				16QAM	22.73	22.75	22.71
				64QAM	22.67	22.57	22.70
			Middle	QPSK	23.05	23.21	23.22
16QAM				23.09	22.89	22.86	
64QAM				23.04	22.76	22.66	
Low			QPSK	23.04	23.14	23.20	
			16QAM	22.70	22.94	22.65	
			64QAM	22.76	22.89	22.63	
8RB		High	QPSK	23.14	23.14	23.26	
			16QAM	22.27	22.32	22.32	
			64QAM	22.06	22.04	22.15	
		Middle	QPSK	23.19	23.19	23.15	
			16QAM	22.26	22.31	22.34	
			64QAM	22.05	22.30	22.20	
		Low	QPSK	23.15	23.18	23.18	
			16QAM	22.24	22.32	22.26	
			64QAM	22.09	22.18	22.16	

	15RB	/	QPSK	23.12	23.19	23.19
16QAM			22.23	22.17	22.20	
64QAM			22.28	22.12	22.18	
5 MHz				846.5MHz	836.5MHz	826.5MHz
	1RB	High	QPSK	22.82	22.95	22.97
			16QAM	22.61	22.51	22.72
			64QAM	22.56	22.56	22.69
		Middle	QPSK	23.12	23.21	23.17
			16QAM	22.90	22.91	23.25
			64QAM	22.68	22.74	22.77
		Low	QPSK	22.93	22.88	23.06
			16QAM	22.95	22.72	22.91
			64QAM	22.34	22.38	22.69
	12RB	High	QPSK	23.07	23.15	23.18
			16QAM	22.07	22.10	22.19
			64QAM	22.09	22.01	22.18
		Middle	QPSK	23.06	23.17	23.24
			16QAM	22.19	22.21	22.22
			64QAM	22.09	22.06	22.13
		Low	QPSK	23.08	23.12	23.05
			16QAM	22.13	22.18	22.05
			64QAM	22.02	22.19	22.07
	25RB	/	QPSK	23.06	23.22	23.18
			16QAM	22.07	22.33	22.19
			64QAM	22.18	22.19	22.13

LTE-FDD Band 5				Actual output Power (dBm)		
				844MHz	836.5MHz	829MHz
	10 MHz	1RB	High	QPSK	22.93	23.16
16QAM				22.53	22.69	22.81
64QAM				22.87	22.79	22.67
Middle			QPSK	23.28	23.16	22.98
			16QAM	23.18	23.27	23.00
			64QAM	23.01	23.14	22.97
Low			QPSK	23.00	22.89	23.00
			16QAM	22.47	22.64	22.78
			64QAM	22.33	22.80	22.84
25RB		High	QPSK	23.06	23.16	23.30
			16QAM	22.22	22.23	22.25
			64QAM	22.14	22.13	22.26
		Middle	QPSK	23.20	23.23	23.33
			16QAM	22.28	22.34	22.38
			64QAM	22.10	22.19	22.28
		Low	QPSK	23.12	23.18	23.25
			16QAM	22.19	22.21	22.31
			64QAM	22.14	22.30	22.16
50RB		/	QPSK	23.06	23.20	23.32
			16QAM	22.15	22.33	22.34
			64QAM	22.20	22.24	22.13

LTE-FDD Band 12				Actual output Power (dBm)			
Band-width	RB allocation	RB offset	Modulation	High	Middle	Low	
1.4 MHz				715.3MHz	707.5MHz	699.7MHz	
	1RB	High	QPSK	22.90	23.06	23.03	
			16QAM	22.87	22.90	22.92	
			64QAM	22.90	22.76	22.88	
		Middle	QPSK	22.96	23.15	23.07	
			16QAM	23.08	22.99	22.95	
			64QAM	22.97	22.78	23.01	
		Low	QPSK	23.11	23.17	23.19	
			16QAM	23.03	22.59	22.96	
			64QAM	23.03	22.87	22.98	
	3RB	High	QPSK	23.27	23.30	23.28	
			16QAM	23.02	23.04	23.03	
			64QAM	23.00	22.98	22.85	
		Middle	QPSK	23.40	23.37	23.31	
			16QAM	23.23	23.12	23.14	
			64QAM	23.06	23.09	23.06	
		Low	QPSK	23.27	23.27	23.35	
			16QAM	23.18	23.09	23.07	
			64QAM	23.17	23.10	23.03	
	6RB	/	QPSK	23.16	23.23	23.17	
			16QAM	22.15	22.13	22.07	
			64QAM	22.05	22.06	22.00	
	3 MHz				714.5MHz	707.5MHz	700.5MHz
		1RB	High	QPSK	23.05	22.99	23.11
				16QAM	22.84	22.54	22.79
				64QAM	22.76	22.34	22.58
			Middle	QPSK	23.27	23.23	23.22
16QAM				23.27	23.00	23.32	
64QAM				23.05	23.01	23.12	
Low			QPSK	23.28	23.14	22.94	
			16QAM	22.95	23.40	23.22	
			64QAM	22.89	23.37	23.16	
8RB		High	QPSK	23.26	23.25	23.21	
			16QAM	22.34	22.33	22.39	
			64QAM	22.06	22.32	22.18	
		Middle	QPSK	23.21	23.29	23.26	
			16QAM	22.41	22.43	22.36	
			64QAM	22.45	22.38	22.20	
		Low	QPSK	23.24	23.24	23.22	
			16QAM	22.68	22.34	22.29	

	15RB	/	64QAM	22.48	22.29	22.19
			QPSK	23.15	23.24	23.19
			16QAM	22.15	22.30	22.04
			64QAM	22.16	22.47	22.20
5 MHz				713.5MHz	707.5MHz	701.5MHz
	1RB	High	QPSK	22.87	22.94	22.92
			16QAM	22.85	22.78	22.87
			64QAM	22.43	22.49	22.65
		Middle	QPSK	23.17	23.17	22.99
			16QAM	23.09	23.23	23.11
			64QAM	23.01	23.10	23.01
		Low	QPSK	22.90	23.07	22.84
			16QAM	22.53	22.93	22.67
			64QAM	22.29	22.97	22.71
	12RB	High	QPSK	23.10	23.09	23.13
			16QAM	22.07	22.06	22.12
			64QAM	22.10	22.09	22.06
		Middle	QPSK	23.28	23.16	23.18
			16QAM	22.41	22.14	22.18
			64QAM	22.38	22.32	22.11
		Low	QPSK	23.13	23.06	23.16
			16QAM	22.21	22.16	22.08
			64QAM	22.09	22.11	22.10
	25RB	/	QPSK	23.14	23.14	23.10
			16QAM	22.25	22.34	22.25
			64QAM	22.08	22.43	22.32

LTE-FDD Band 12				Actual output Power (dBm)		
				711MHz	707.5MHz	704MHz
10 MHz	1RB	High	QPSK	23.13	23.01	23.12
			16QAM	22.72	22.91	22.90
			64QAM	22.73	22.54	22.79
		Middle	QPSK	23.30	23.30	23.25
			16QAM	23.18	23.25	23.06
			64QAM	23.01	23.01	22.97
		Low	QPSK	23.01	22.97	23.04
			16QAM	22.76	22.59	22.68
			64QAM	22.85	22.62	22.46
	25RB	High	QPSK	23.17	23.21	23.23
			16QAM	22.17	22.30	22.41
			64QAM	22.29	22.38	22.12
		Middle	QPSK	23.24	23.29	23.24
			16QAM	22.34	22.35	22.36
			64QAM	22.19	22.22	22.20
		Low	QPSK	23.27	23.19	23.01
			16QAM	22.28	22.30	22.26
			64QAM	22.49	22.36	22.24
	50RB	/	QPSK	23.20	23.20	23.19
			16QAM	22.23	22.31	22.25
			64QAM	22.34	22.25	22.34

11.6 Wi-Fi and BT Measurement result

The output power of BT antenna is as following:

Mode	Conducted Power (dBm)		
	Channel 0 (2402MHz)	Channel 39 (2441MHz)	Channel 78 (2480MHz)
GFSK	-0.73	0.04	-1.63
$\pi/4$ DQPSK	0.07	0.74	-0.89
8DPSK	0.17	0.82	-0.83
BLE	-0.85	-0.03	-1.51

The average conducted power for Wi-Fi is as following:

802.11b (dBm)

Channel\data rate	1Mbps	2Mbps	5.5Mbps	11Mbps
1(2412MHz)	17.03	16.33	16.06	16.29
6(2437MHz)	17.14	17.07	16.38	17.02
11(2462MHz)	17.49	16.93	17.06	17.16

802.11g (dBm)

Channel\data rate	6Mbps	9Mbps	12Mbps	18Mbps	24Mbps	36Mbps	48Mbps	54Mbps
1(2412MHz)	17.00	17.12	16.78	16.86	16.91	16.17	16.24	15.38
6(2437MHz)	16.75	16.82	16.45	16.54	16.58	15.78	15.88	14.93
11(2462MHz)	16.76	16.69	16.31	16.41	16.47	15.67	15.77	14.86

802.11n (dBm) - HT20 (2.4G)

Channel\data rate	MCS0	MCS1	MCS2	MCS3	MCS4	MCS5	MCS6	MCS7
1(2412MHz)	16.65	16.32	15.51	15.08	15.22	15.31	14.92	14.49
6(2437MHz)	16.38	15.98	15.14	14.68	15.14	15.15	14.68	14.14
11(2462MHz)	16.42	16.08	15.21	14.77	14.89	14.96	14.48	14.04

12 Simultaneous TX SAR Considerations

12.1 Introduction

The following procedures adopted from “FCC SAR Considerations for Cell Phones with Multiple Transmitters” are applicable to handsets with built-in unlicensed transmitters such as 802.11 a/b/g and Bluetooth devices which may simultaneously transmit with the licensed transmitter.

For this device, the BT and Wi-Fi can transmit simultaneous with other transmitters.

12.2 Transmit Antenna Separation Distances

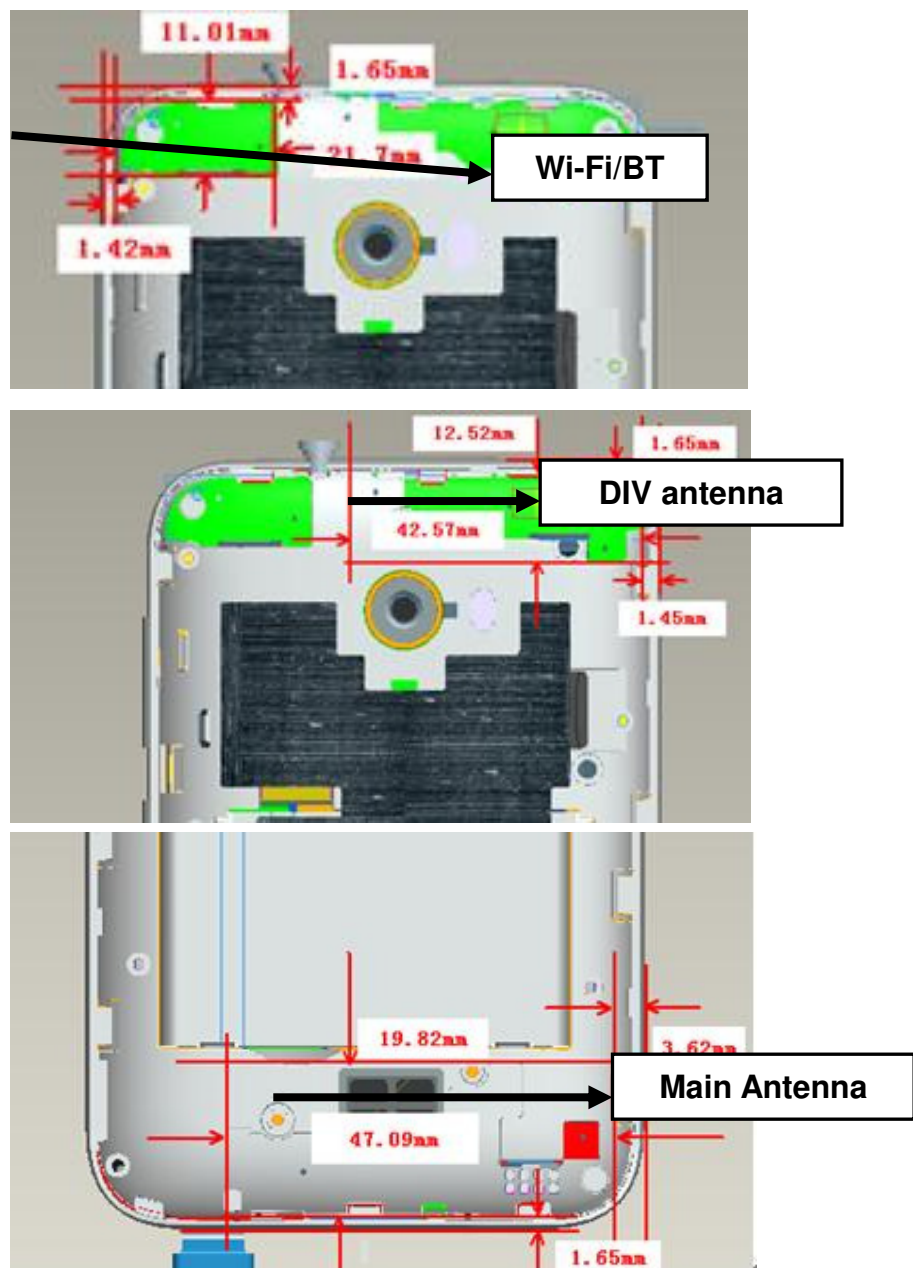

Picture 12.1 Antenna Locations

12.3 SAR Measurement Positions

According to the KDB941225 D06 Hot Spot SAR, the edges with less than 2.5 cm distance to the antennas need to be tested for SAR.

SAR measurement positions						
Mode	Front	Rear	Left edge	Right edge	Top edge	Bottom edge
Main antenna	Yes	Yes	Yes	Yes	No	Yes
WLAN	Yes	Yes	No	Yes	Yes	No

12.4 Standalone SAR Test Exclusion Considerations

Standalone 1-g head or body SAR evaluation by measurement or numerical simulation is not required when the corresponding SAR Exclusion Threshold condition, listed below, is satisfied. The 1-g SAR test exclusion threshold for 100 MHz to 6 GHz at test separation distances ≤ 50 mm are determined by:

$[(\text{max. power of channel, including tune-up tolerance, mW}) / (\text{min. test separation distance, mm})] \cdot [\sqrt{f(\text{GHz})}] \leq 3.0$ for 1-g SAR, where

- $f(\text{GHz})$ is the RF channel transmit frequency in GHz
- Power and distance are rounded to the nearest mW and mm before calculation
- The result is rounded to one decimal place for comparison

Table 12.1: Standalone SAR test exclusion considerations

Band/Mode	f(GHz)	Position	SAR test exclusion threshold (mW)	RF output power		SAR test exclusion
				dBm	mW	
Bluetooth	2.441	Head	9.60	1.5	1.41	Yes
		Body	19.20	1.5	1.41	Yes
2.4GHz WLAN 802.11 b	2.45	Head	9.58	18	63.10	No
		Body	19.17	18	63.10	No

13 Evaluation of Simultaneous

Table 13.1: The sum of reported SAR values for main antenna and WiFi

	Position	Main antenna	WiFi	Sum
Highest reported SAR value for Head	Left Touch	0.54	0.97	1.51
	Right Touch	0.59	0.48	1.07
Highest reported SAR value for Body	Rear	1.26	0.26	1.52
	Bottom	1.33	/	1.33

Table 13.2: The sum of reported SAR values for main antenna and Bluetooth

	Position	Main antenna	BT*	Sum
Highest reported SAR value for Head	Left Touch	0.54	0.06	0.60
	Right Touch	0.59	0.06	0.65
Highest reported SAR value for Body	Rear	1.26	0.03	1.29
	Bottom	1.33	/	1.33

BT* - Estimated SAR for Bluetooth (see the table 13.3)

Table 13.3: Estimated SAR for Bluetooth

Position	f (GHz)	Distance (mm)	Upper limit of power *		Estimated _{1g} (W/kg)
			dBm	mW	
Head	2.441	5	1.5	1.41	0.06
Body	2.441	10	1.5	1.41	0.03

* - Maximum possible output power declared by manufacturer

When standalone SAR test exclusion applies to an antenna that transmits simultaneously with other antennas, the standalone SAR must be estimated according to following to determine simultaneous transmission SAR test exclusion:

(max. power of channel, including tune-up tolerance, mW)/(min. test separation distance, mm)]·[√f(GHz)/x] W/kg for test separation distances ≤ 50 mm;

Where x = 7.5 for 1-g SAR.

When the minimum test separation distance is < 5 mm, a distance of 5 mm is applied to determine SAR test exclusion

Conclusion:

According to the above tables, the sum of reported SAR values is < 1.6W/kg. So the simultaneous transmission SAR with volume scans is not required.

14 SAR Test Result

It is determined by user manual for the distance between the EUT and the phantom bottom.

The distance is 10mm and just applied to the condition of body worn accessory.

It is performed for all SAR measurements with area scan based 1-g SAR estimation (Fast SAR). A zoom scan measurement is added when the estimated 1-g SAR is the highest measured SAR in each exposure configuration, wireless mode and frequency band combination or >1.2W/kg.

The calculated SAR is obtained by the following formula:

$$\text{Reported SAR} = \text{Measured SAR} \times 10^{(P_{\text{Target}} - P_{\text{Measured}})/10}$$

Where P_{Target} is the power of manufacturing upper limit;

P_{Measured} is the measured power in chapter 11.

Table 14.1: Duty Cycle

Mode	Duty Cycle
Speech for GSM850/1900	1:8.3
GPRS&EGPRS for GSM850/1900 (AP OFF)	1:8.3
GPRS&EGPRS for GSM850/1900 (AP ON)	1:2
WCDMA850/1700/1900	1:1
FDD_LTE Band 2/4/5/12	1:1

14.1 The evaluation of multi-batteries

We'll perform the head measurement in all bands with the primary battery depending on the evaluation of multi-batteries and retest on highest value point with other batteries. Then, repeat the measurement in the Body test.

Table 14.2: The evaluation of multi-batteries for Head Test

Frequency		Mode/Band	Side	Test Position	Battery Manufacturer	SAR(1g)	Power Drift(dB)
MHz	Ch.					(W/kg)	
836.6	190	GSM850	Right	Touch	Zhuhai COSLIGHT Battery CO., Ltd.	0.247	0.05
836.6	190	GSM850	Right	Touch	Tianjin Lishen Battery Joint-Stock Co.,Ltd.	0.264	0.02

Note:Accordingtothevaluesintheabovetable,thebattery,CPLD-417 by TianjinLishen Battery Joint-stock Co., Ltd.,istheprimarybattery.We'llperformtheHeadmeasurementwiththisbatteryandretestonhighestvalue pointwithothers.

Table 14.3: The evaluation of multi-batteries for Body Test

Frequency		Mode/Band	Test Position	Spacing (mm)	Battery Manufacturer	SAR(1g)	Power Drift(dB)
MHz	Ch.					(W/kg)	
836.6	190	GSM850	Rear	10	Zhuhai COSLIGHT Battery CO., Ltd.	0.353	-0.04
836.6	190	GSM850	Rear	10	Tianjin Lishen Battery Joint-Stock Co.,Ltd.	0.378	0.06

Note:Accordingtothevaluesintheabovetable,thebattery,CPLD-417 by TianjinLishen Battery Joint-stock Co., Ltd.,istheprimarybattery.We'llperformtheBodymeasurementwiththisbatteryandretestonhighestvalue pointwithothers.

14.2 SAR results for Fast SAR

Table 14.4: SAR Values (GSM 850 MHz - Head)

Frequency		Side	Test Position	Figure No.	Ambient Temperature: 22.6.°C		Liquid Temperature: 22.1°C				
MHz	Ch.				Conducted Power (dBm)	Max. tune-upPower (dBm)	Measured SAR(10g) (W/kg)	Reported SAR(10g) (W/kg)	Measured SAR(1g) (W/kg)	Reported SAR(1g)(W/kg)	Power Drift (dB)
836.6	190	Left	Touch	/	32.93	33.5	0.198	0.23	0.281	0.32	0.03
836.6	190	Left	Tilt	/	32.93	33.5	0.135	0.15	0.190	0.22	0.06
836.6	190	Right	Touch	/	32.93	33.5	0.186	0.21	0.264	0.30	0.02
836.6	190	Right	Tilt	/	32.93	33.5	0.129	0.15	0.181	0.21	-0.12
848.8	251	Left	Touch	Fig.1	32.54	33.5	0.231	0.29	0.309	0.39	-0.08
824.2	128	Left	Touch	/	32.80	33.5	0.174	0.20	0.247	0.29	0.05

Table 14.5: SAR Values (GSM 850 MHz -Body) -AP ON

Frequency		Test Position	Figure No.	Ambient Temperature: 22.6.°C		Liquid Temperature: 22.1°C				
MHz	Ch.			Conducted Power (dBm)	Max. tune-upPower (dBm)	Measured SAR(10g) (W/kg)	Reported SAR(10g) (W/kg)	Measured SAR(1g) (W/kg)	Reported SAR(1g)(W/kg)	Power Drift (dB)
836.6	190	Front	/	32.88	33.5	0.231	0.27	0.321	0.37	0.09
836.6	190	Rear	Fig.2	32.88	33.5	0.282	0.33	0.378	0.44	0.06
836.6	190	Left	/	32.88	33.5	0.108	0.12	0.156	0.18	-0.14
836.6	190	Right	/	32.88	33.5	0.178	0.21	0.258	0.30	-0.11
836.6	190	Bottom	/	32.88	33.5	0.070	0.08	0.110	0.13	0.02
848.8	251	Rear	/	32.51	33.5	0.247	0.31	0.343	0.43	0.07
824.2	128	Rear	/	32.77	33.5	0.242	0.29	0.335	0.40	-0.09
836.6	190	Rear EGPRS	/	32.24	33.0	0.264	0.31	0.362	0.43	0.10

Note1: The distance between the EUT and the phantom bottom is 10mm.

Table 14.6: SAR Values (GSM 850 MHz -Body) -AP OFF

Frequency		Test Position	Figure No.	Ambient Temperature: 22.6.°C		Liquid Temperature: 22.1°C				
MHz	Ch.			Conducted Power (dBm)	Max. tune-upPower (dBm)	Measured SAR(10g) (W/kg)	Reported SAR(10g) (W/kg)	Measured SAR(1g) (W/kg)	Reported SAR(1g)(W/kg)	Power Drift (dB)
836.6	190	Front	/	32.88	33.5	0.231	0.27	0.321	0.37	0.09
836.6	190	Rear	/	32.88	33.5	0.282	0.33	0.378	0.44	0.06
848.8	251	Rear	/	32.51	33.5	0.247	0.31	0.343	0.43	0.07
824.2	128	Rear	/	32.77	33.5	0.242	0.29	0.335	0.40	-0.09
836.6	190	RearEGPRS	/	32.24	33.0	0.264	0.31	0.362	0.43	0.10

Note1: The distance between the EUT and the phantom bottom is 10mm.

Table 14.7: SAR Values (GSM 1900 MHz - Head)

Frequency		Side	Test Position	Figure No.	Ambient Temperature: 22.2°C		Liquid Temperature: 21.7°C		Measured SAR(1g) (W/kg)	Reported SAR(1g)(W/kg)	Power Drift (dB)
MHz	Ch.				Conducted Power (dBm)	Max. tune-up Power (dBm)	Measured SAR(10g) (W/kg)	Reported SAR(10g) (W/kg)			
1880	661	Left	Touch	/	30.08	31	0.011	0.01	0.019	0.02	0.01
1880	661	Left	Tilt	/	30.08	31	0.007	0.01	0.012	0.01	0.07
1880	661	Right	Touch	/	30.08	31	0.012	0.01	0.020	0.02	-0.03
1880	661	Right	Tilt	/	30.08	31	0.006	0.01	0.010	0.01	0.05
1909.8	810	Right	Touch	/	29.62	31	0.011	0.02	0.019	0.03	-0.06
1850.2	512	Right	Touch	Fig.3	30.48	31	0.012	0.01	0.021	0.02	-0.11

Table 14.8: SAR Values (GSM 1900 MHz -Body) -AP ON

Frequency		Test Position	Figure No.	Ambient Temperature: 22.2°C		Liquid Temperature: 21.7°C		Measured SAR(1g) (W/kg)	Reported SAR(1g)(W/kg)	Power Drift (dB)
MHz	Ch.			Conducted Power (dBm)	Max. tune-up Power (dBm)	Measured SAR(10g) (W/kg)	Reported SAR(10g) (W/kg)			
1880	661	Front	/	23.58	24.5	0.291	0.36	0.543	0.67	0.03
1880	661	Rear	Fig.4	23.58	24.5	0.346	0.43	0.668	0.83	0.12
1880	661	Left	/	23.58	24.5	0.041	0.05	0.069	0.09	0.06
1880	661	Right	/	23.58	24.5	0.056	0.07	0.097	0.12	0.12
1880	661	Bottom	/	23.58	24.5	0.325	0.40	0.655	0.81	0.07
1909.8	810	Rear	/	23.59	24.5	0.295	0.36	0.543	0.67	0.11
1850.2	512	Rear	/	23.80	24.5	0.348	0.41	0.617	0.72	0.13
1880	661	Rear EGPRS	/	23.39	24.5	0.281	0.36	0.512	0.66	0.01

Note1: The distance between the EUT and the phantom bottom is 10mm.

Table 14.9: SAR Values (GSM 1900 MHz -Body) -AP OFF

Frequency		Test Position	Figure No.	Ambient Temperature: 22.2°C		Liquid Temperature: 21.7°C		Measured SAR(1g) (W/kg)	Reported SAR(1g)(W/kg)	Power Drift (dB)
MHz	Ch.			Conducted Power (dBm)	Max. tune-up Power (dBm)	Measured SAR(10g) (W/kg)	Reported SAR(10g) (W/kg)			
1880	661	Front	/	30.05	31	0.200	0.25	0.345	0.43	0.09
1880	661	Rear	/	30.05	31	0.264	0.33	0.473	0.59	-0.04
1909.8	810	Rear	/	29.61	31	0.301	0.41	0.523	0.72	-0.09
1850.2	512	Rear	/	30.48	31	0.269	0.30	0.480	0.54	0.02
1909.8	810	Rear EGPRS	/	28.95	30	0.299	0.38	0.522	0.66	0.05

Note1: The distance between the EUT and the phantom bottom is 15mm.

Table 14.10: SAR Values (WCDMA 850 MHz - Head)

Frequency		Side	Test Position	Figure No.	Ambient Temperature: 22.5°C		Liquid Temperature: 22.0°C				
MHz	Ch.				Conducted Power (dBm)	Max. tune-up Power (dBm)	Measured SAR(10g) (W/kg)	Reported SAR(10g) (W/kg)	Measured SAR(1g) (W/kg)	Reported SAR(1g)(W/kg)	Power Drift (dB)
836.4	4182	Left	Touch	/	23.84	24.	0.296	0.31	0.421	0.44	0.03
836.4	4182	Left	Tilt	/	23.84	24.	0.222	0.23	0.316	0.33	-0.08
836.4	4182	Right	Touch	/	23.84	24.	0.276	0.29	0.391	0.41	0.13
836.4	4182	Right	Tilt	/	23.84	24.	0.171	0.18	0.242	0.25	0.05
846.6	4233	Left	Touch	/	23.86	24.	0.229	0.24	0.331	0.34	-0.09
826.4	4132	Left	Touch	Fig.5	23.93	24.	0.387	0.39	0.520	0.53	-0.04

Table 14.11: SAR Values (WCDMA 850 MHz -Body) -AP ON

Frequency		Test Position	Figure No.	Ambient Temperature: 22.5°C		Liquid Temperature: 22.0°C				
MHz	Ch.			Conducted Power (dBm)	Max. tune-up Power (dBm)	Measured SAR(10g) (W/kg)	Reported SAR(10g) (W/kg)	Measured SAR(1g) (W/kg)	Reported SAR(1g)(W/kg)	Power Drift (dB)
836.4	4182	Front	/	23.84	24.	0.361	0.37	0.498	0.52	0.06
836.4	4182	Rear	/	23.84	24	0.464	0.48	0.644	0.67	-0.03
836.4	4182	Left	/	23.84	24	0.296	0.31	0.426	0.44	0.11
836.4	4182	Right	/	23.84	24	0.324	0.34	0.467	0.48	0.16
836.4	4182	Bottom	/	23.84	24	0.138	0.14	0.217	0.23	-0.08
846.6	4233	Rear	Fig.6	23.86	24	0.524	0.54	0.676	0.70	0.06
826.4	4132	Rear	/	23.93	24	0.481	0.49	0.665	0.68	0.07

Note1: The distance between the EUT and the phantom bottom is 10mm.

Table 14.12: SAR Values (WCDMA 850 MHz -Body) -AP OFF

Frequency		Test Position	Figure No.	Ambient Temperature: 22.5°C		Liquid Temperature: 22.0°C				
MHz	Ch.			Conducted Power (dBm)	Max. tune-up Power (dBm)	Measured SAR(10g) (W/kg)	Reported SAR(10g) (W/kg)	Measured SAR(1g) (W/kg)	Reported SAR(1g)(W/kg)	Power Drift (dB)
836.4	4182	Front	/	23.84	24.	0.361	0.37	0.498	0.52	0.06
836.4	4182	Rear	/	23.84	24	0.464	0.48	0.644	0.67	-0.03
846.6	4233	Rear	/	23.86	24	0.524	0.54	0.676	0.70	0.06
826.4	4132	Rear	/	23.93	24	0.481	0.49	0.665	0.68	0.07

Note1: The distance between the EUT and the phantom bottom is 10mm.

Table 14.13: SAR Values (WCDMA1900 MHz - Head)

Frequency		Side	Test Position	Figure No.	Ambient Temperature: 21.8°C		Liquid Temperature: 21.3°C				Power Drift (dB)
MHz	Ch.				Conducted Power (dBm)	Max. tune-up Power (dBm)	Measured SAR(10g) (W/kg)	Reported SAR(10g) (W/kg)	Measured SAR(1g) (W/kg)	Reported SAR(1g) (W/kg)	
1880	9400	Left	Touch	/	23.83	24.2	0.177	0.19	0.312	0.34	0.04
1880	9400	Left	Tilt	/	23.83	24.2	0.114	0.12	0.208	0.23	0.03
1880	9400	Right	Touch	/	23.83	24.2	0.229	0.25	0.402	0.44	0.09
1880	9400	Right	Tilt	/	23.83	24.2	0.130	0.14	0.228	0.25	-0.05
1907.6	9538	Right	Touch	/	23.69	24.2	0.197	0.22	0.347	0.39	-0.06
1852.4	9262	Right	Touch	Fig.7	23.78	24.2	0.241	0.27	0.417	0.46	0.02

Table 14.14: SAR Values (WCDMA1900 MHz Body) -AP ON

Frequency		Test Position	Figure No.	Ambient Temperature: 22.3°C		Liquid Temperature: 21.8°C				Power Drift (dB)
MHz	Ch.			Conducted Power (dBm)	Max. tune-up Power (dBm)	Measured SAR(10g) (W/kg)	Reported SAR(10g) (W/kg)	Measured SAR(1g) (W/kg)	Reported SAR(1g) (W/kg)	
1880	9400	Front	/	20.9	21.7	0.485	0.58	0.895	1.08	0.05
1880	9400	Rear	/	20.9	21.7	0.549	0.66	1.010	1.21	0.03
1880	9400	Left	/	20.9	21.7	0.064	0.08	0.109	0.13	-0.11
1880	9400	Right	/	20.9	21.7	0.089	0.11	0.157	0.19	0.14
1880	9400	Bottom	Fig.8	20.9	21.7	0.571	0.69	1.110	1.33	0.03
1907.6	9538	Rear	/	21.1	21.7	0.616	0.71	1.100	1.26	0.01
1852.4	9262	Rear	/	20.9	21.7	0.520	0.63	0.940	1.13	-0.02
1907.6	9538	Front	/	21.1	21.7	0.476	0.55	0.887	1.02	-0.09
1852.4	9262	Front	/	20.9	21.7	0.493	0.59	0.904	1.09	0.06
1907.6	9538	Bottom	/	21.1	21.7	0.534	0.61	1.050	1.21	-0.12
1852.4	9262	Bottom	/	20.9	21.7	0.553	0.66	1.070	1.29	0.03

Note1: The distance between the EUT and the phantom bottom is 10mm.

Table 14.15: SAR Values (WCDMA1900 MHz -Body) -AP OFF

Frequency		Test Position	Figure No.	Ambient Temperature: 22.3°C		Liquid Temperature: 21.8°C				Power Drift (dB)
MHz	Ch.			Conducted Power (dBm)	Max. tune-up Power (dBm)	Measured SAR(10g) (W/kg)	Reported SAR(10g) (W/kg)	Measured SAR(1g) (W/kg)	Reported SAR(1g) (W/kg)	
1880	9400	Front	/	23.83	24.2	0.290	0.32	0.511	0.56	0.03
1880	9400	Rear	/	23.83	24.2	0.342	0.37	0.612	0.67	0.05
1907.6	9538	Rear	/	23.69	24.2	0.337	0.38	0.623	0.70	-0.06
1852.4	9262	Rear	/	23.78	24.2	0.405	0.45	0.699	0.77	0.04

Note1: The distance between the EUT and the phantom bottom is 15mm.

Table 14.16: SAR Values (WCDMA1700 MHz - Head)

Frequency		Side	Test Position	Figure No.	Ambient Temperature: 22.7°C		Liquid Temperature: 22.2°C		Measured SAR(1g) (W/kg)	Reported SAR(1g)(W/kg)	Power Drift (dB)
MHz	Ch.				Conducted Power (dBm)	Max. tune-up Power (dBm)	Measured SAR(10g) (W/kg)	Reported SAR(10g) (W/kg)			
1732.6	1413	Left	Touch	/	24.77	25.2	0.289	0.32	0.488	0.54	-0.02
1732.6	1413	Left	Tilt	/	24.77	25.2	0.105	0.12	0.178	0.20	-0.04
1732.6	1413	Right	Touch	/	24.77	25.2	0.314	0.35	0.517	0.57	0.02
1732.6	1413	Right	Tilt	/	24.77	25.2	0.137	0.15	0.220	0.24	-0.07
1752.6	1513	Right	Touch	Fig.9	24.86	25.2	0.342	0.37	0.545	0.59	0.12
1712.4	1312	Right	Touch	/	24.88	25.2	0.236	0.25	0.390	0.42	0.02

Table 14.17: SAR Values (WCDMA1700 MHz -Body) -AP ON

Frequency		Test Position	Figure No.	Ambient Temperature: 22.6°C		Liquid Temperature: 22.1°C		Measured SAR(1g) (W/kg)	Reported SAR(1g)(W/kg)	Power Drift (dB)
MHz	Ch.			Conducted Power (dBm)	Max. tune-up Power (dBm)	Measured SAR(10g) (W/kg)	Reported SAR(10g) (W/kg)			
1732.6	1413	Front	Fig.10	21.8	22.2	0.592	0.65	1.090	1.20	0.13
1732.6	1413	Rear	/	21.8	22.2	0.540	0.59	0.901	0.99	-0.08
1732.6	1413	Left	/	21.8	22.2	0.079	0.09	0.131	0.14	0.05
1732.6	1413	Right	/	21.8	22.2	0.132	0.14	0.230	0.25	0.07
1732.6	1413	Bottom	/	21.8	22.2	0.453	0.50	0.863	0.95	0.11
1752.6	1513	Front	/	21.9	22.2	0.482	0.52	0.872	0.93	-0.07
1712.4	1312	Front	/	21.8	22.2	0.444	0.49	0.805	0.88	-0.04
1752.6	1513	Rear	/	21.9	22.2	0.550	0.59	0.914	0.98	0.11
1712.4	1312	Rear	/	21.8	22.2	0.496	0.54	0.821	0.90	0.07
1752.6	1513	Bottom	/	21.9	22.2	0.508	0.54	1.010	1.08	0.03
1712.4	1312	Bottom	/	21.8	22.2	0.451	0.49	0.901	0.99	0.15

Note1: The distance between the EUT and the phantom bottom is 10mm.

Table 14.18: SAR Values (WCDMA1700 MHz -Body) -AP OFF

Frequency		Test Position	Figure No.	Ambient Temperature: 22.6°C		Liquid Temperature: 22.1°C		Measured SAR(1g) (W/kg)	Reported SAR(1g)(W/kg)	Power Drift (dB)
MHz	Ch.			Conducted Power (dBm)	Max. tune-up Power (dBm)	Measured SAR(10g) (W/kg)	Reported SAR(10g) (W/kg)			
1732.6	1413	Front	/	24.77	25.2	0.394	0.44	0.652	0.72	0.02
1732.6	1413	Rear	/	24.77	25.2	0.371	0.41	0.615	0.68	0.03
1752.6	1513	Front	/	24.86	25.2	0.459	0.50	0.790	0.85	0.01
1712.4	1312	Front	/	24.88	25.2	0.355	0.38	0.585	0.63	0.07

Note1: The distance between the EUT and the phantom bottom is 15mm.

Table 14.19: SAR Values (LTE Band 2-Head)

Frequency		Configuration	Test Position	Conduct-ed Power (dBm)	Max. tune-up Power (dBm)	Figure No.	Ambient Temperature: 21.5°C		Liquid Temperature: 21.0°C		Power Drift (dB)
MHz	Ch.						Measured SAR(10g) (W/kg)	Reported SAR(10g) (W/kg)	Measured SAR(1g) (W/kg)	Reported SAR(1g) (W/kg)	
1860	18700	1RB_Mid	Left Touch	23.75	24	Fig.11	0.157	0.17	0.269	0.28	-0.10
1880	18900	50RB_Mid	Left Touch	22.65	23	/	0.110	0.12	0.188	0.20	0.06
1860	18700	1RB_Mid	Left Tilt	23.75	24	/	0.120	0.13	0.210	0.22	0.08
1880	18900	50RB_Mid	Left Tilt	22.65	23	/	0.093	0.10	0.168	0.18	0.05
1860	18700	1RB_Mid	Right Touch	23.75	24	/	0.148	0.16	0.256	0.27	-0.12
1880	18900	50RB_Mid	Right Touch	22.65	23	/	0.097	0.11	0.152	0.16	-0.06
1860	18700	1RB_Mid	Right Tilt	23.75	24	/	0.125	0.13	0.215	0.23	0.04
1880	18900	50RB_Mid	Right Tilt	22.65	23	/	0.086	0.09	0.150	0.16	0.07

Table 14.20: SAR Values (LTE Band 2-Body)-AP ON

Frequency		Configuration	Test Position	Conduct-ed Power (dBm)	Max. tune-up Power (dBm)	Figure No.	Ambient Temperature: 21.8°C		Liquid Temperature: 21.3°C		Power Drift (dB)
MHz	Ch.						Measured SAR(10g) (W/kg)	Reported SAR(10g) (W/kg)	Measured SAR(1g) (W/kg)	Reported SAR(1g) (W/kg)	
1880	18900	1RB_Mid	Front	21.64	22.5	/	0.440	0.54	0.800	0.98	-0.06
1900	19100	50RB_Low	Front	21.64	22.5	/	0.413	0.50	0.743	0.91	-0.05
1880	18900	1RB_Mid	Rear	21.64	22.5	/	0.477	0.58	0.894	1.09	0.02
1900	19100	50RB_Low	Rear	21.64	22.5	/	0.446	0.54	0.781	0.95	0.07
1880	18900	1RB_Mid	Left	21.64	22.5	/	0.059	0.07	0.101	0.12	0.15
1900	19100	50RB_Low	Left	21.64	22.5	/	0.052	0.06	0.094	0.11	0.13
1880	18900	1RB_Mid	Right	21.64	22.5	/	0.095	0.12	0.171	0.21	0.05
1900	19100	50RB_Low	Right	21.64	22.5	/	0.091	0.11	0.165	0.20	0.07
1880	18900	1RB_Mid	Bottom	21.64	22.5	Fig.12	0.530	0.65	1.030	1.26	-0.03
1900	19100	50RB_Low	Bottom	21.64	22.5	/	0.468	0.57	0.924	1.13	-0.01
1900	19100	1RB_Mid	Rear	21.55	22.5	/	0.462	0.57	0.873	1.09	-0.04
1860	18700	1RB_Mid	Rear	21.61	22.5	/	0.459	0.56	0.869	1.07	0.08
1800	18900	50RB_Low	Rear	21.52	22.5	/	0.442	0.55	0.775	0.97	0.04
1860	18700	50RB_Low	Rear	21.55	22.5	/	0.436	0.54	0.771	0.96	-0.14
1860	18700	100RB	Rear	21.49	22.5	/	0.424	0.54	0.746	0.94	-0.11
1900	19100	1RB_Mid	Front	21.55	22.5	/	0.421	0.52	0.783	0.97	0.09
1860	18700	1RB_Mid	Front	21.61	22.5	/	0.433	0.53	0.792	0.97	0.10
1800	18900	50RB_Low	Front	21.52	22.5	/	0.407	0.51	0.734	0.92	0.05
1860	18700	50RB_Low	Front	21.55	22.5	/	0.418	0.52	0.774	0.96	0.05
1860	18700	100RB	Front	21.49	22.5	/	0.403	0.51	0.733	0.92	0.15
1900	19100	1RB_Mid	Bottom	21.55	22.5	/	0.526	0.65	0.996	1.24	0.08
1860	18700	1RB_Mid	Bottom	21.61	22.5	/	0.514	0.63	0.985	1.21	-0.04
1800	18900	50RB_Low	Bottom	21.52	22.5	/	0.455	0.57	0.894	1.12	0.07
1860	18700	50RB_Low	Bottom	21.55	22.5	/	0.437	0.54	0.886	1.10	0.02
1860	18700	100RB	Bottom	21.49	22.5	/	0.432	0.55	0.846	1.07	0.06

Note1: The distance between the EUT and the phantom bottom is 10mm.

Table 14.21: SAR Values (LTE Band 2-Body)-AP OFF

Frequency		Ambient Temperature: 21.8°C					Liquid Temperature: 21.3°C				
MHz	Ch.	Configuration	Test Position	Conduct-ed Power (dBm)	Max. tune-up Power (dBm)	Figure No.	Measured SAR(10g) (W/kg)	Reported SAR(10g) (W/kg)	Measured SAR(1g) (W/kg)	Reported SAR(1g) (W/kg)	Power Drift (dB)
1860	18700	1RB_Mid	Front	23.75	24	/	0.409	0.43	0.698	0.74	0.03
1880	19890	50RB_Mid	Front	22.65	23	/	0.306	0.33	0.529	0.57	-0.04
1860	18700	1RB_Mid	Rear	23.75	24	/	0.448	0.47	0.766	0.81	-0.02
1880	19890	50RB_Mid	Rear	22.65	23	/	0.337	0.37	0.600	0.65	0.03
1900	19100	1RB_Mid	Rear	23.50	24	/	0.438	0.49	0.752	0.84	0.09
1880	19890	1RB_Mid	Rear	23.43	24	/	0.434	0.49	0.745	0.85	0.11
1860	18700	100RB	Rear	22.59	23	/	0.417	0.46	0.725	0.80	0.05

Note1: The distance between the EUT and the phantom bottom is 15mm.

Table 14.22: SAR Values (LTE Band 4-Head)

Frequency		Ambient Temperature: 22.2°C					Liquid Temperature: 21.7°C				
MHz	Ch.	Configuration	Test Position	Conduct-ed Power (dBm)	Max. tune-up Power (dBm)	Figure No.	Measured SAR(10g) (W/kg)	Reported SAR(10g) (W/kg)	Measured SAR(1g) (W/kg)	Reported SAR(1g) (W/kg)	Power Drift (dB)
1720	20050	1RB_Low	Left Touch	23.59	24	/	0.202	0.22	0.334	0.37	0.11
1745	20300	50RB_Low	Left Touch	22.67	23	/	0.183	0.20	0.286	0.31	0.08
1720	20050	1RB_Low	Left Tilt	23.59	24	/	0.067	0.07	0.111	0.12	-0.06
1745	20300	50RB_Low	Left Tilt	22.67	23	/	0.062	0.07	0.105	0.11	0.03
1720	20050	1RB_Low	Right Touch	23.59	24	Fig.13	0.223	0.25	0.350	0.38	-0.14
1745	20300	50RB_Low	Right Touch	22.67	23	/	0.208	0.22	0.327	0.35	0.13
1720	20050	1RB_Low	Right Tilt	23.59	24	/	0.086	0.09	0.141	0.15	-0.09
1745	20300	50RB_Low	Right Tilt	22.67	23	/	0.075	0.08	0.119	0.13	0.07

Table 14.23: SAR Values (LTE Band 4-Body)-APON

Frequency		Ambient Temperature: 21.8°C					Liquid Temperature: 21.3°C				
MHz	Ch.	Configuration	Test Position	Conduct-ed Power (dBm)	Max. tune-up Power (dBm)	Figure No.	Measured SAR(10g) (W/kg)	Reported SAR(10g) (W/kg)	Measured SAR(1g) (W/kg)	Reported SAR(1g) (W/kg)	Power Drift (dB)
1745	20300	1RB_Mid	Front	22.64	24	/	0.474	0.65	0.855	1.17	0.06
1745	20300	50RB_Low	Front	22.70	24	/	0.439	0.59	0.763	1.03	0.12
1745	20300	1RB_Mid	Rear	22.64	24	/	0.460	0.63	0.799	1.09	0.05
1745	20300	50RB_Low	Rear	22.70	24	/	0.411	0.55	0.742	1.00	-0.03
1745	20300	1RB_Mid	Left	22.64	24	/	0.075	0.10	0.121	0.17	0.02
1745	20300	50RB_Low	Left	22.70	24	/	0.076	0.10	0.125	0.17	-0.01
1745	20300	1RB_Mid	Right	22.64	24	/	0.120	0.16	0.210	0.29	0.11
1745	20300	50RB_Low	Right	22.70	24	/	0.122	0.16	0.214	0.29	-0.06
1745	20300	1RB_Mid	Bottom	22.64	24	Fig.14	0.486	0.66	0.892	1.22	0.13
1745	20300	50RB_Low	Bottom	22.70	24	/	0.458	0.62	0.881	1.19	0.03

1732.5	20175	1RB_Mid	Front	22.58	24	/	0.462	0.64	0.836	1.16	-0.07
1720	20050	1RB_Mid	Front	22.55	24	/	0.458	0.64	0.729	1.02	-0.05
1732.5	20175	50RB_Low	Front	22.49	24	/	0.433	0.61	0.755	1.07	0.05
1720	20050	50RB_Low	Front	22.44	24	/	0.424	0.61	0.751	1.08	0.03
1745	20300	100RB	Front	22.54	24	/	0.409	0.57	0.734	1.03	-0.09
1732.5	20175	1RB_Mid	Rear	22.58	24	/	0.453	0.63	0.788	1.09	-0.08
1720	20050	1RB_Mid	Rear	22.55	24	/	0.448	0.63	0.773	1.08	0.07
1732.5	20175	50RB_Low	Rear	22.49	24	/	0.432	0.61	0.753	1.07	0.06
1720	20050	50RB_Low	Rear	22.44	24	/	0.425	0.61	0.742	1.06	-0.07
1745	20300	100RB	Rear	22.54	24	/	0.404	0.57	0.742	1.04	0.05
1732.5	20175	1RB_Mid	Bottom	22.58	24	/	0.477	0.66	0.874	1.21	0.04
1720	20050	1RB_Mid	Bottom	22.55	24	/	0.465	0.65	0.869	1.21	0.11
1732.5	20175	50RB_Low	Bottom	22.49	24	/	0.431	0.61	0.855	1.21	0.14
1720	20050	50RB_Low	Bottom	22.44	24	/	0.427	0.61	0.850	1.19	-0.04
1745	20300	100RB	Bottom	22.54	24	/	0.419	0.59	0.855	1.20	0.06

Note1: The distance between the EUT and the phantom bottom is 10mm.

Table 14.24: SAR Values (LTE Band 4-Body)–AP OFF

Frequency		Ambient Temperature: 21.8°C					Liquid Temperature: 21.3°C				
MHz	Ch.	Configuration	Test Position	Conduct-ed Power (dBm)	Max. tune-up Power (dBm)	Figure No.	Measured SAR(10g) (W/kg)	Reported SAR(10g) (W/kg)	Measured SAR(1g) (W/kg)	Reported SAR(1g) (W/kg)	Power Drift (dB)
1720	20050	1RB_Low	Front	23.59	24	/	0.322	0.35	0.539	0.59	0.08
1745	20300	50RB_Low	Front	22.67	23	/	0.273	0.29	0.477	0.51	0.13
1720	20050	1RB_Low	Rear	23.59	24	/	0.300	0.33	0.504	0.55	-0.03
1745	20300	50RB_Low	Rear	22.67	23	/	0.283	0.31	0.481	0.52	0.06

Note1: The distance between the EUT and the phantom bottom is 15mm.

Table 14.25: SAR Values (LTE Band 5-Head)

Frequency		Configuration	Test Position	Conduct-ed Power (dBm)	Max. tune-up Power (dBm)	Figure No.	Ambient Temperature: 22.0°C		Liquid Temperature: 21.5°C		Power Drift (dB)
MHz	Ch.						Measured SAR(10g) (W/kg)	Reported SAR(10g) (W/kg)	Measured SAR(1g) (W/kg)	Reported SAR(1g) (W/kg)	
844	20600	1RB_Mid	Left Touch	23.28	24	/	0.214	0.25	0.311	0.37	0.12
829	20450	25RB_Mid	Left Touch	23.33	24	/	0.182	0.21	0.263	0.31	0.11
844	20600	1RB_Mid	Left Tilt	23.28	24	/	0.135	0.16	0.194	0.23	0.15
829	20450	25RB_Mid	Left Tilt	23.33	24	/	0.112	0.13	0.159	0.19	0.20
844	20600	1RB_Mid	Right Touch	23.28	24	Fig.15	0.268	0.32	0.356	0.42	-0.12
829	20450	25RB_Mid	Right Touch	23.33	24	/	0.185	0.22	0.269	0.31	0.11
844	20600	1RB_Mid	Right Tilt	23.28	24	/	0.132	0.16	0.191	0.23	0.17
829	20450	25RB_Mid	Right Tilt	23.33	24	/	0.106	0.12	0.151	0.18	0.12

Table 14.26: SAR Values (LTE Band 5-Body) -AP ON

Frequency		Configuration	Test Position	Conduct-ed Power (dBm)	Max. tune-up Power (dBm)	Figure No.	Ambient Temperature: 22.4°C		Liquid Temperature: 21.9°C		Power Drift (dB)
MHz	Ch.						Measured SAR(10g) (W/kg)	Reported SAR(10g) (W/kg)	Measured SAR(1g) (W/kg)	Reported SAR(1g) (W/kg)	
844	20600	1RB_Mid	Front	23.28	24	/	0.249	0.29	0.352	0.42	-0.08
829	20450	25RB_Mid	Front	23.33	24	/	0.218	0.25	0.307	0.36	0.03
844	20600	1RB_Mid	Rear	23.28	24	Fig.16	0.433	0.51	0.570	0.67	-0.06
829	20450	25RB_Mid	Rear	23.33	24	/	0.326	0.38	0.461	0.54	-0.14
844	20600	1RB_Mid	Left	23.28	24	/	0.246	0.29	0.356	0.42	-0.08
829	20450	25RB_Mid	Left	23.33	24	/	0.232	0.27	0.343	0.40	0.00
844	20600	1RB_Mid	Right	23.28	24	/	0.237	0.28	0.352	0.42	-0.04
829	20450	25RB_Mid	Right	23.33	24	/	0.221	0.26	0.327	0.38	-0.04
844	20600	1RB_Mid	Bottom	23.28	24	/	0.136	0.16	0.222	0.26	-0.12
829	20450	25RB_Mid	Bottom	23.33	24	/	0.103	0.12	0.169	0.20	-0.12

Note1: The distance between the EUT and the phantom bottom is 10mm

Table 14.27: SAR Values (LTE Band 5-Body) -AP OFF

Frequency		Configuration	Test Position	Conduct-ed Power (dBm)	Max. tune-up Power (dBm)	Figure No.	Ambient Temperature: 22.4°C		Liquid Temperature: 21.9°C		Power Drift (dB)
MHz	Ch.						Measured SAR(10g) (W/kg)	Reported SAR(10g) (W/kg)	Measured SAR(1g) (W/kg)	Reported SAR(1g) (W/kg)	
844	20600	1RB_Mid	Front	23.28	24	/	0.249	0.29	0.352	0.42	-0.08
829	20450	25RB_Mid	Front	23.33	24	/	0.218	0.25	0.307	0.36	0.03
844	20600	1RB_Mid	Rear	23.28	24	/	0.433	0.51	0.570	0.67	-0.06
829	20450	25RB_Mid	Rear	23.33	24	/	0.326	0.38	0.461	0.54	-0.14

Note1: The distance between the EUT and the phantom bottom is 10mm

Table 14.28: SAR Values (LTE Band 12-Head)

Frequency		Configuration	Test Position	Conduct-ed Power (dBm)	Max. tune-up Power (dBm)	Figure No.	Measured SAR(10g) (W/kg)	Reported SAR(10g) (W/kg)	Measured SAR(1g) (W/kg)	Reported SAR(1g) (W/kg)	Power Drift (dB)
MHz	Ch.										
Ambient Temperature: 22.3°C Liquid Temperature: 21.8°C											
707.5	23095	1RB_Mid	Left Touch	23.30	24	Fig.17	0.192	0.23	0.245	0.29	0.05
707.5	23095	25RB_Mid	Left Touch	23.29	24	/	0.145	0.17	0.209	0.25	0.03
707.5	23095	1RB_Mid	Left Tilt	23.30	24	/	0.117	0.14	0.165	0.19	0.02
707.5	23095	25RB_Mid	Left Tilt	23.29	24	/	0.094	0.11	0.132	0.16	0.12
707.5	23095	1RB_Mid	Right Touch	23.30	24	/	0.158	0.19	0.223	0.26	0.13
707.5	23095	25RB_Mid	Right Touch	23.29	24	/	0.125	0.15	0.177	0.21	0.08
707.5	23095	1RB_Mid	Right Tilt	23.30	24	/	0.096	0.11	0.136	0.16	0.14
707.5	23095	25RB_Mid	Right Tilt	23.29	24	/	0.080	0.09	0.113	0.13	0.08

Table 14.29: SAR Values (LTE Band 12-Body) -AP ON

Frequency		Configuration	Test Position	Conduct-ed Power (dBm)	Max. tune-up Power (dBm)	Figure No.	Measured SAR(10g) (W/kg)	Reported SAR(10g) (W/kg)	Measured SAR(1g) (W/kg)	Reported SAR(1g) (W/kg)	Power Drift (dB)
MHz	Ch.										
Ambient Temperature: 22.7°C Liquid Temperature: 22.2°C											
707.5	23095	1RB_Mid	Front	23.30	24	/	0.159	0.19	0.222	0.26	-0.13
707.5	23095	25RB_Mid	Front	23.29	24	/	0.128	0.15	0.179	0.21	0.12
707.5	23095	1RB_Mid	Rear	23.30	24	Fig.18	0.385	0.45	0.459	0.54	-0.07
707.5	23095	25RB_Mid	Rear	23.29	24	/	0.177	0.21	0.253	0.30	-0.04
707.5	23095	1RB_Mid	Left	23.30	24	/	0.218	0.26	0.316	0.37	0.14
707.5	23095	25RB_Mid	Left	23.29	24	/	0.190	0.22	0.274	0.32	-0.12
707.5	23095	1RB_Mid	Right	23.30	24	/	0.213	0.25	0.312	0.37	-0.02
707.5	23095	25RB_Mid	Right	23.29	24	/	0.146	0.17	0.225	0.26	0.06
707.5	23095	1RB_Mid	Bottom	23.30	24	/	0.078	0.09	0.123	0.14	0.06
707.5	23095	25RB_Mid	Bottom	23.29	24	/	0.062	0.07	0.098	0.12	0.00

Note1: The distance between the EUT and the phantom bottom is 10mm

Table 14.30: SAR Values (LTE Band 12-Body)-AP OFF

Frequency		Configuration	Test Position	Conduct-ed Power (dBm)	Max. tune-up Power (dBm)	Figure No.	Measured SAR(10g) (W/kg)	Reported SAR(10g) (W/kg)	Measured SAR(1g) (W/kg)	Reported SAR(1g) (W/kg)	Power Drift (dB)
MHz	Ch.										
Ambient Temperature: 22.7°C Liquid Temperature: 22.2°C											
707.5	23095	1RB_Mid	Front	23.30	24	/	0.159	0.19	0.222	0.26	-0.13
707.5	23095	25RB_Mid	Front	23.29	24	/	0.128	0.15	0.179	0.21	0.12
707.5	23095	1RB_Mid	Rear	23.30	24	/	0.385	0.45	0.459	0.54	-0.07
707.5	23095	25RB_Mid	Rear	23.29	24	/	0.177	0.21	0.253	0.30	-0.04

Note1: The distance between the EUT and the phantom bottom is 10mm

Table 14.31: SAR Values ((WLAN - Head) for other batteries

Frequency		Side	Test Position	Figure No.	Ambient Temperature: 21.8°C		Liquid Temperature: 21.3°C		Measured SAR(1g) (W/kg)	Reported SAR(1g)(W/kg)	Power Drift (dB)
MHz	Ch.				Conducted Power (dBm)	Max. tune-up Power (dBm)	Measured SAR(10g) (W/kg)	Reported SAR(10g) (W/kg)			
2462	11	Left	Touch	/	17.49	18	0.415	0.47	0.816	0.92	0.07

Table 14.32: SAR Values (WCDMA1900 MHz -Body) for other batteries

Frequency		Test Position	Figure No.	Ambient Temperature: 22.3°C		Liquid Temperature: 21.8°C		Measured SAR(1g) (W/kg)	Reported SAR(1g)(W/kg)	Power Drift (dB)
MHz	Ch.			Conducted Power (dBm)	Max. tune-up Power (dBm)	Measured SAR(10g) (W/kg)	Reported SAR(10g) (W/kg)			
1880	9400	Bottom	/	20.9	21.7	0.554	0.67	1.07	1.29	0.11

Note1: The distance between the EUT and the phantom bottom is 10mm

14.3 SAR results for Standard procedure

There is zoom scan measurement to be added for the highest measured SAR in each exposure configuration/band.

Table 14.33: SAR Values (GSM 850 MHz - Head)

Ambient Temperature: 22.6.°C					Liquid Temperature: 22.1°C						
Frequency		Side	Test Position	Figure No.	Conducted Power (dBm)	Max. tune-up Power (dBm)	Measured SAR(10g) (W/kg)	Reported SAR(10g) (W/kg)	Measured SAR(1g) (W/kg)	Reported SAR(1g)(W/kg)	Power Drift (dB)
MHz	Ch.										
848.8	251	Left	Touch	Fig.1	32.54	33.5	0.231	0.29	0.309	0.39	-0.08

Table 14.34: SAR Values (GSM 850 MHz -Body) –APON

Ambient Temperature: 22.6.°C					Liquid Temperature: 22.1°C						
Frequency		Test Position	Figure No.	Conducted Power (dBm)	Max. tune-up Power (dBm)	Measured SAR(10g) (W/kg)	Reported SAR(10g) (W/kg)	Measured SAR(1g) (W/kg)	Reported SAR(1g)(W/kg)	Power Drift (dB)	
MHz	Ch.										
836.6	190	Rear	Fig.2	32.88	33.5	0.282	0.33	0.378	0.44	0.06	

Note1: The distance between the EUT and the phantom bottom is 10mm.

Table 14.35: SAR Values (GSM 1900 MHz - Head)

Ambient Temperature: 22.2°C					Liquid Temperature: 21.7°C						
Frequency		Side	Test Position	Figure No.	Conducted Power (dBm)	Max. tune-up Power (dBm)	Measured SAR(10g) (W/kg)	Reported SAR(10g) (W/kg)	Measured SAR(1g) (W/kg)	Reported SAR(1g)(W/kg)	Power Drift (dB)
MHz	Ch.										
1909.8	810	Right	Touch	/	29.62	31	0.011	0.02	0.019	0.03	-0.06

Table 14.36: SAR Values (GSM 1900 MHz -Body) –APON

Ambient Temperature: 22.2°C					Liquid Temperature: 21.7°C						
Frequency		Test Position	Figure No.	Conducted Power (dBm)	Max. tune-up Power (dBm)	Measured SAR(10g) (W/kg)	Reported SAR(10g) (W/kg)	Measured SAR(1g) (W/kg)	Reported SAR(1g)(W/kg)	Power Drift (dB)	
MHz	Ch.										
1880	661	Rear	Fig.3	23.58	24.5	0.346	0.43	0.668	0.83	0.12	

Note1: The distance between the EUT and the phantom bottom is 10mm.

Table 14.37: SAR Values (WCDMA 850 MHz - Head)

Ambient Temperature: 22.5°C					Liquid Temperature: 22.0°C						
Frequency		Side	Test Position	Figure No.	Conducted Power (dBm)	Max. tune-up Power (dBm)	Measured SAR(10g) (W/kg)	Reported SAR(10g) (W/kg)	Measured SAR(1g) (W/kg)	Reported SAR(1g)(W/kg)	Power Drift (dB)
MHz	Ch.										
826.4	4132	Left	Touch	Fig.4	23.93	24.	0.387	0.39	0.520	0.53	-0.04

Table 14.38: SAR Values (WCDMA 850 MHz -Body) –APON

Ambient Temperature: 22.5°C					Liquid Temperature: 22.0°C						
Frequency		Test Position	Figure No.	Conducted Power (dBm)	Max. tune-up Power (dBm)	Measured SAR(10g) (W/kg)	Reported SAR(10g) (W/kg)	Measured SAR(1g) (W/kg)	Reported SAR(1g)(W/kg)	Power Drift (dB)	
MHz	Ch.										
846.6	4233	Rear	Fig.5	23.86	24	0.524	0.54	0.676	0.70	0.06	

Note1: The distance between the EUT and the phantom bottom is 10mm

Table 14.39: SAR Values (WCDMA1900 MHz - Head)

Ambient Temperature: 21.8°C						Liquid Temperature: 21.3°C					
Frequency		Side	Test Position	Figure No.	Conducted Power (dBm)	Max. tune-up Power (dBm)	Measured SAR(10g) (W/kg)	Reported SAR(10g) (W/kg)	Measured SAR(1g) (W/kg)	Reported SAR(1g)(W/kg)	Power Drift (dB)
MHz	Ch.										
1852.4	9262	Right	Touch	Fig.6	23.78	24.2	0.241	0.27	0.417	0.46	0.02

Table 14.40: SAR Values (WCDMA1900 MHz -Body) –APON

Ambient Temperature: 22.3°C						Liquid Temperature: 21.8°C					
Frequency		Test Position	Figure No.	Conducted Power (dBm)	Max. tune-up Power (dBm)	Measured SAR(10g) (W/kg)	Reported SAR(10g) (W/kg)	Measured SAR(1g) (W/kg)	Reported SAR(1g)(W/kg)	Power Drift (dB)	
MHz	Ch.										
1880	9400	Bottom	Fig.7	20.9	21.7	0.571	0.69	1.110	1.33	0.03	

Note1: The distance between the EUT and the phantom bottom is 10mm

Table 14.41: SAR Values (WCDMA1700 MHz - Head)

Ambient Temperature: 22.7°C						Liquid Temperature: 22.2°C					
Frequency		Side	Test Position	Figure No.	Conducted Power (dBm)	Max. tune-up Power (dBm)	Measured SAR(10g) (W/kg)	Reported SAR(10g) (W/kg)	Measured SAR(1g) (W/kg)	Reported SAR(1g)(W/kg)	Power Drift (dB)
MHz	Ch.										
1752.6	1513	Right	Touch	Fig.8	24.86	25.2	0.342	0.37	0.545	0.59	0.12

Table 14.42: SAR Values (WCDMA1700 MHz -Body) -AP ON

Ambient Temperature: 22.6°C						Liquid Temperature: 22.1°C					
Frequency		Test Position	Figure No.	Conducted Power (dBm)	Max. tune-up Power (dBm)	Measured SAR(10g) (W/kg)	Reported SAR(10g) (W/kg)	Measured SAR(1g) (W/kg)	Reported SAR(1g)(W/kg)	Power Drift (dB)	
MHz	Ch.										
1732.6	1413	Front	Fig.9	21.8	22.2	0.592	0.65	1.090	1.20	0.13	

Note1: The distance between the EUT and the phantom bottom is 10mm.

Table 14.43: SAR Values (LTE Band 2-Head)

Ambient Temperature: 21.5°C						Liquid Temperature: 21.0°C					
Frequency		Configuration	Test Position	Conducted Power (dBm)	Max. tune-up Power (dBm)	Figure No.	Measured SAR(10g) (W/kg)	Reported SAR(10g) (W/kg)	Measured SAR(1g) (W/kg)	Reported SAR(1g) (W/kg)	Power Drift (dB)
MHz	Ch.										
1860	18700	1RB_Mid	Left Touch	23.75	24	Fig.10	0.157	0.17	0.269	0.28	-0.10

Table 14.44: SAR Values (LTE Band 2-Body) -AP ON

Ambient Temperature: 21.8°C						Liquid Temperature: 21.3°C					
Frequency		Configuration	Test Position	Conducted Power (dBm)	Max. tune-up Power (dBm)	Figure No.	Measured SAR(10g) (W/kg)	Reported SAR(10g) (W/kg)	Measured SAR(1g) (W/kg)	Reported SAR(1g) (W/kg)	Power Drift (dB)
MHz	Ch.										
1880	18900	1RB_Mid	Bottom	21.64	22.5	Fig.11	0.530	0.65	1.030	1.26	-0.03

Note: The distance between the EUT and the phantom bottom is 10mm.

Table 14.45: SAR Values (LTE Band 4-Head)

Ambient Temperature: 22.2°C						Liquid Temperature: 21.7°C					
Frequency		Configuration	Test Position	Conduct-ed Power (dBm)	Max. tune-up Power (dBm)	Figure No.	Measured SAR(10g) (W/kg)	Reported SAR(10g) (W/kg)	Measured SAR(1g) (W/kg)	Reported SAR(1g) (W/kg)	Power Drift (dB)
MHz	Ch.										
1720	20050	1RB_Low	Right Touch	23.59	24	Fig.12	0.223	0.25	0.35	0.38	-0.14

Table 14.46: SAR Values (LTE Band 4-Body) -AP ON

Ambient Temperature: 21.8°C						Liquid Temperature: 21.3°C					
Frequency		Configuration	Test Position	Conduct-ed Power (dBm)	Max. tune-up Power (dBm)	Figure No.	Measured SAR(10g) (W/kg)	Reported SAR(10g) (W/kg)	Measured SAR(1g) (W/kg)	Reported SAR(1g) (W/kg)	Power Drift (dB)
MHz	Ch.										
1745	20300	1RB_Mid	Bottom	22.64	24	Fig.13	0.486	0.66	0.892	1.22	0.13

Note: The distance between the EUT and the phantom bottom is 10mm.

Table 14.47: SAR Values (LTE Band 5-Head)

Ambient Temperature: 22.0°C						Liquid Temperature: 21.5°C					
Frequency		Configuration	Test Position	Conduct-ed Power (dBm)	Max. tune-up Power (dBm)	Figure No.	Measured SAR(10g) (W/kg)	Reported SAR(10g) (W/kg)	Measured SAR(1g) (W/kg)	Reported SAR(1g) (W/kg)	Power Drift (dB)
MHz	Ch.										
844	20600	1RB_Mid	Right Touch	23.28	24	Fig.14	0.268	0.32	0.356	0.42	-0.12

Table 14.48: SAR Values (LTE Band 5-Body) -AP ON

Ambient Temperature: 22.4°C						Liquid Temperature: 21.9°C					
Frequency		Configuration	Test Position	Conduct-ed Power (dBm)	Max. tune-up Power (dBm)	Figure No.	Measured SAR(10g) (W/kg)	Reported SAR(10g) (W/kg)	Measured SAR(1g) (W/kg)	Reported SAR(1g) (W/kg)	Power Drift (dB)
MHz	Ch.										
844	20600	1RB_Mid	Rear	23.28	24	Fig.15	0.433	0.51	0.570	0.67	-0.06

Note: The distance between the EUT and the phantom bottom is 10mm

Table 14.49: SAR Values (LTE Band 12-Head)

Ambient Temperature: 22.3°C						Liquid Temperature: 21.8°C					
Frequency		Configuration	Test Position	Conduct-ed Power (dBm)	Max. tune-up Power (dBm)	Figure No.	Measured SAR(10g) (W/kg)	Reported SAR(10g) (W/kg)	Measured SAR(1g) (W/kg)	Reported SAR(1g) (W/kg)	Power Drift (dB)
MHz	Ch.										
707.5	23095	1RB_Mid	Left Touch	23.30	24	Fig.16	0.192	0.23	0.245	0.29	0.05

Table 14.50: SAR Values (LTE Band 12-Body) -AP ON

Ambient Temperature: 22.7°C						Liquid Temperature: 22.2°C					
Frequency		Configuration	Test Position	Conduct-ed Power (dBm)	Max. tune-up Power (dBm)	Figure No.	Measured SAR(10g) (W/kg)	Reported SAR(10g) (W/kg)	Measured SAR(1g) (W/kg)	Reported SAR(1g) (W/kg)	Power Drift (dB)
MHz	Ch.										
707.5	23095	1RB_Mid	Rear	23.30	24	Fig.17	0.385	0.45	0.459	0.54	-0.07

Note: The distance between the EUT and the phantom bottom is 10mm

14.4WLAN Evaluation

According to the KDB248227 D01, SAR is measured for 2.4GHz 802.11b DSSS using the initial test position procedure.

Head Evaluation

Table 14.51: SAR Values (WLAN - Head)– 802.11b 1Mbps (Fast SAR)

Frequency		Side	Test Position	Figure No.	Conducted Power (dBm)	Max. tune-upPower (dBm)	Measured SAR(10g) (W/kg)	Reported SAR(10g) (W/kg)	Measured SAR(1g) (W/kg)	Reported SAR(1g)(W/kg)	Power Drift (dB)
MHz	Ch.										
Ambient Temperature: 22.2°C Liquid Temperature: 21.7°C											
2462	11	Left	Touch	/	17.49	18	0.436	0.49	0.833	0.94	-0.03
2462	11	Left	Tilt	/	17.49	18	0.297	0.33	0.584	0.66	0.03
2462	11	Right	Touch	/	17.49	18	0.224	0.25	0.405	0.46	-0.04
2462	11	Right	Tilt	/	17.49	18	0.163	0.18	0.291	0.33	0.03

As shown above table, the initial test position for head is “Left Touch”. So the head SAR of WLAN is presented as below:

Table 14.52: SAR Values (WLAN - Head) – 802.11b 1Mbps (Full SAR)

Frequency		Side	Test Position	Figure No.	Conducted Power (dBm)	Max. tune-upPower (dBm)	Measured SAR(10g) (W/kg)	Reported SAR(10g) (W/kg)	Measured SAR(1g) (W/kg)	Reported SAR(1g)(W/kg)	Power Drift (dB)
MHz	Ch.										
Ambient Temperature: 22.2°C Liquid Temperature: 21.7°C											
2462	11	Left	Touch	Fig.19	17.49	18	0.438	0.49	0.835	0.94	-0.03
2462	11	Left	Tilt	/	17.49	18	0.299	0.34	0.588	0.66	0.03
2442	6	Left	Touch	/	17.17	18	0.394	0.48	0.754	0.91	0.07
2462	11	Right	Touch	/	17.49	18	0.225	0.25	0.407	0.46	-0.04

According to the KDB248227 D01, The reported SAR must be scaled to 100% transmission duty factor to determine compliance at the maximum tune-up tolerance limit. A maximum transmission duty factor of 95.96% is achievable for WLAN in this project and the scaled reported SAR is presented as below.

Table 14.53: SAR Values (WLAN - Head) – 802.11b 1Mbps (Scaled Reported SAR)

Frequency		Side	Test Position	Actual duty factor	maximum duty factor	Reported SAR (1g)(W/kg)	Scaled reported SAR (1g)(W/kg)
MHz	Ch.						
Ambient Temperature: 22.2°C Liquid Temperature: 21.7°C							
2462	11	Left	Touch	95.96%	100%	0.94	0.97
2462	11	Right	Touch	95.96%	100%	0.46	0.48

SAR is not required for OFDM because the 802.11b adjusted SAR ≤ 1.2 W/kg.

Body Evaluation (AP ON)

Table 14.54: SAR Values (WLAN - Body)– 802.11b 1Mbps (Fast SAR)

Frequency		Test Position	Figure No.	Ambient Temperature: 22.3°C		Liquid Temperature: 21.8°C		Measured SAR(1g) (W/kg)	Reported SAR(1g)(W/kg)	Power Drift (dB)
MHz	Ch.			Conducted Power (dBm)	Max. tune-upPower (dBm)	Measured SAR(10g) (W/kg)	Reported SAR(10g) (W/kg)			
2462	11	Front	/	17.49	18	0.101	0.11	0.179	0.20	0.12
2462	11	Rear	/	17.49	18	0.113	0.13	0.222	0.25	0.10
2462	11	Right	/	17.49	18	0.086	0.10	0.147	0.17	-0.08
2462	11	Top	/	17.49	18	0.079	0.09	0.135	0.15	0.03

Note1: The distance between the EUT and the phantom bottom is 10mm.

As shown above table, the initial test position for body is “Rear”. So the body SAR of WLAN is presented as below:

Table 14.55: SAR Values (WLAN - Body) – 802.11b 1Mbps (Full SAR)

Frequency		Test Position	Figure No.	Ambient Temperature: 22.3°C		Liquid Temperature: 21.8°C		Measured SAR(1g) (W/kg)	Reported SAR(1g)(W/kg)	Power Drift (dB)
MHz	Ch.			Conducted Power (dBm)	Max. tune-upPower (dBm)	Measured SAR(10g) (W/kg)	Reported SAR(10g) (W/kg)			
2462	11	Rear	Fig.21	17.49	18	0.115	0.13	0.224	0.25	0.10

According to the KDB248227 D01, The reported SAR must be scaled to 100% transmission duty factor to determine compliance at the maximum tune-up tolerance limit. A maximum transmission duty factor of 95.96% is achievable for WLAN in this project and the scaled reported SAR is presented as below.

Table 14.56: SAR Values (WLAN - Body) – 802.11b 1Mbps (Scaled Reported SAR)

Frequency		Test Position	Ambient Temperature: 22.3°C		Liquid Temperature: 21.8°C		Reported SAR (1g)(W/kg)	Scaled reported SAR (1g)(W/kg)
MHz	Ch.		Actual duty factor	maximum duty factor	Reported SAR (1g)(W/kg)	Scaled reported SAR (1g)(W/kg)		
2462	11	Rear	95.96%	100%	0.25	0.26		

SAR is not required for OFDM because the 802.11b adjusted SAR \leq 1.2 W/kg.

Body Evaluation (AP OFF)

Table 14.57: SAR Values (WLAN - Body)– 802.11b 1Mbps (Fast SAR)

Frequency		Test Position	Figure No.	Ambient Temperature: 22.3°C		Liquid Temperature: 21.8°C		Measured SAR(1g) (W/kg)	Reported SAR(1g)(W/kg)	Power Drift (dB)
MHz	Ch.			Conducted Power (dBm)	Max. tune-upPower (dBm)	Measured SAR(10g) (W/kg)	Reported SAR(10g) (W/kg)			
2462	11	Front	/	17.49	18	0.051	0.06	0.106	0.12	0.02
2462	11	Rear	/	17.49	18	0.063	0.07	0.134	0.15	0.09

Note1: The distance between the EUT and the phantom bottom is 15mm.

As shown above table, the initial test position for body is “Rear”. So the body SAR of WLAN is presented as below:

Table 14.58: SAR Values (WLAN - Body) – 802.11b 1Mbps (Full SAR)

Frequency		Test Position	Figure No.	Conducted Power (dBm)	Max. tune-up Power (dBm)	Measured SAR(10g) (W/kg)	Reported SAR(10g) (W/kg)	Measured SAR(1g) (W/kg)	Reported SAR(1g) (W/kg)	Power Drift (dB)
MHz	Ch.									
2462	11	Rear	Fig.22	17.49	18	0.066	0.08	0.139	0.16	0.09

According to the KDB248227 D01, The reported SAR must be scaled to 100% transmission duty factor to determine compliance at the maximum tune-up tolerance limit. A maximum transmission duty factor of 95.96% is achievable for WLAN in this project and the scaled reported SAR is presented as below.

Table 14.59: SAR Values (WLAN - Body) – 802.11b 1Mbps (Scaled Reported SAR)

Frequency		Test Position	Actual duty factor	maximum duty factor	Reported SAR (1g)(W/kg)	Scaled reported SAR (1g)(W/kg)
MHz	Ch.					
2462	11	Rear	95.96%	100%	0.16	0.17

SAR is not required for OFDM because the 802.11b adjusted SAR ≤ 1.2 W/kg.

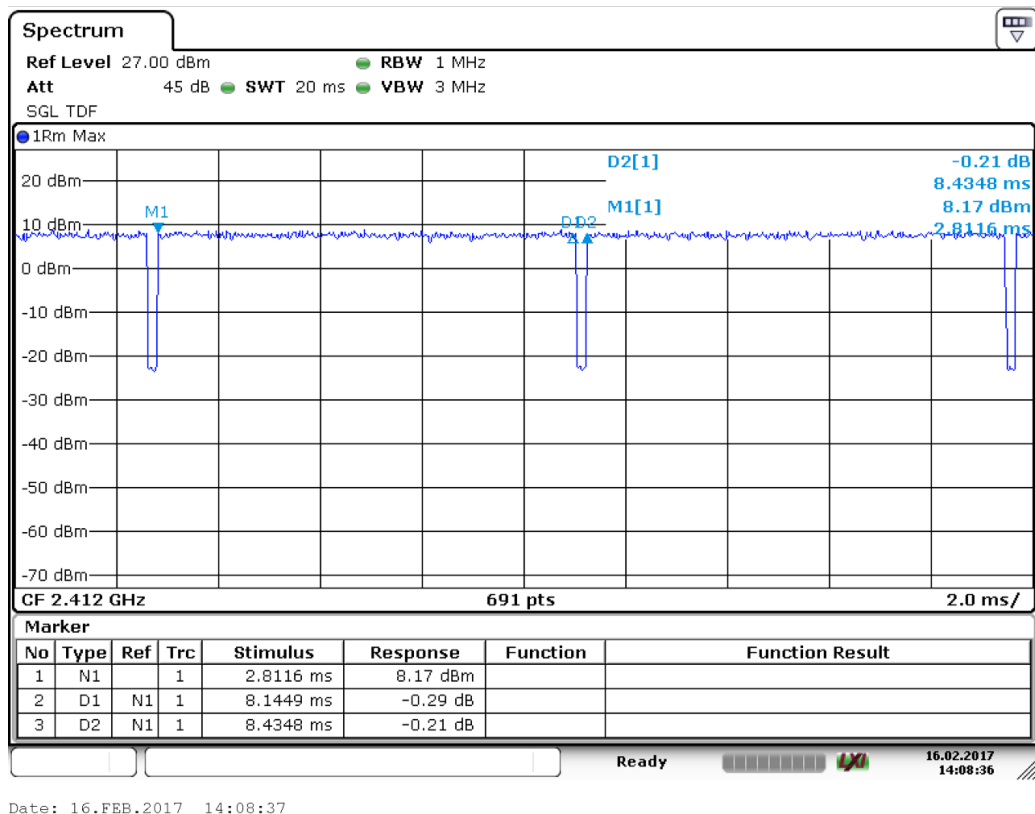

Picture 14.1: The plot of duty factor

15 SAR Measurement Variability

SAR measurement variability must be assessed for each frequency band, which is determined by the SAR probe calibration point and tissue-equivalent medium used for the device measurements.

When both head and body tissue-equivalent media are required for SAR measurements in a frequency band, the variability measurement procedures should be applied to the tissue medium with the highest measured SAR, using the highest measured SAR configuration for that tissue-equivalent medium.

The following procedures are applied to determine if repeated measurements are required.

- 1) Repeated measurement is not required when the original highest measured SAR is < 0.80 W/kg; steps 2) through 4) do not apply.
- 2) When the original highest measured SAR is ≥ 0.80 W/kg, repeat that measurement once.
- 3) Perform a second repeated measurement only if the ratio of largest to smallest SAR for the original and first repeated measurements is > 1.20 or when the original or repeated measurement is ≥ 1.45 W/kg ($\sim 10\%$ from the 1-g SAR limit).
- 4) Perform a third repeated measurement only if the original, first or second repeated measurement is ≥ 1.5 W/kg and the ratio of largest to smallest SAR for the original, first and second repeated measurements is > 1.20 .

Table 15.1: SAR Measurement Variability for Body WCDMA 1900 (1g) –AP ON

Frequency		Test Position	Spacing (mm)	Original SAR (W/kg)	First Repeated SAR (W/kg)	The Ratio	Second Repeated SAR (W/kg)
MHz	Ch.						
1880	9400	Bottom	10	1.11	1.10	1.01	/

Table 15.2: SAR Measurement Variability for Body WCDMA 1700 (1g) - AP ON

Frequency		Test Position	Spacing (mm)	Original SAR (W/kg)	First Repeated SAR (W/kg)	The Ratio	Second Repeated SAR (W/kg)
MHz	Ch.						
1732.6	1413	Front	10	1.09	1.07	1.02	/

Table 15.3: SAR Measurement Variability for Body LTE Band 2 (1g)–AP ON

Frequency		Test Position	Spacing (mm)	Original SAR (W/kg)	First Repeated SAR (W/kg)	The Ratio	Second Repeated SAR (W/kg)
MHz	Ch.						
1880	18900	Bottom	10	1.03	1.00	1.03	/

Table 15.4: SAR Measurement Variability for Body LTE Band 4 (1g) –AP ON

Frequency		Test Position	Spacing (mm)	Original SAR (W/kg)	First Repeated SAR (W/kg)	The Ratio	Second Repeated SAR (W/kg)
MHz	Ch.						
1745	20300	Bottom	10	0.892	0.885	1.01	/

Table 15.5: SAR Measurement Variability for Head WiFi 802.11b 1Mbps (1g)

Frequency		Side	Test Position	Original SAR (W/kg)	First Repeated SAR (W/kg)	The Ratio	Second Repeated SAR (W/kg)
MHz	Ch.						
2462	11	Left	Touch	0.835	0.818	1.02	/

16 Measurement Uncertainty

16.1 Measurement Uncertainty for Normal SAR Tests (300MHz~3GHz)

No.	Error Description	Type	Uncertainty value	Probably Distribution	Div.	(Ci) 1g	(Ci) 10g	Std. Unc. (1g)	Std. Unc. (10g)	Degree of freedom
Measurement system										
1	Probe calibration	B	6.0	N	1	1	1	6.0	6.0	∞
2	Isotropy	B	4.7	R	$\sqrt{3}$	1	1	1.6	1.6	∞
3	Boundary effect	B	1.0	R	$\sqrt{3}$	1	1	6.4	6.4	∞
4	Linearity	B	4.7	R	$\sqrt{3}$	1	1	0.5	0.5	∞
5	Detection limit	B	1.0	N	1	1	1	1	1	∞
6	Readout electronics	B	0.3	R	$\sqrt{3}$	1	1	0.6	0.6	∞
7	Response time	B	0.8	R	$\sqrt{3}$	1	1	0.0	0.0	∞
8	Integration time	B	2.6	R	$\sqrt{3}$	1	1	1.0	1.0	∞
9	RFambient conditions-noise	B	0	R	$\sqrt{3}$	1	1	1.7	1.7	∞
10	RFambient conditions-reflection	B	0	R	$\sqrt{3}$	1	1	1.7	1.7	∞
11	Probe positioned mech. restrictions	B	0.4	R	$\sqrt{3}$	1	1	0.2	0.2	∞
12	Probe positioning with respect to phantom shell	B	2.9	R	$\sqrt{3}$	1	1	1.7	1.7	∞
13	Post-processing	B	1.0	R	$\sqrt{3}$	1	1	1.2	1.2	∞
14	Probe modulation response	B	2.3	R	$\sqrt{3}$	1	1	1.21	1.21	∞
Test sample related										
15	Test sample positioning	A	3.3	N	1	1	1	3.3	3.3	5
16	Device holder uncertainty	A	3.4	N	1	1	1	3.4	3.4	5
17	Power scaling	B	2.4	R	$\sqrt{3}$	1	1	2.4	2.4	∞
18	Drift of output power	B	5.0	R	$\sqrt{3}$	1	1	2.9	2.9	∞
Phantom and set-up										
19	Phantom uncertainty	B	4.0	R	$\sqrt{3}$	1	1	2.3	2.3	∞
20	Liquid conductivity (target)	B	5.0	R	$\sqrt{3}$	0.64	0.43	1.8	1.2	∞
21	Liquid conductivity (meas.)	A	2.06	N	1	0.64	0.43	1	0.28	9
22	Liquid permittivity (target)	B	5.0	R	$\sqrt{3}$	0.6	0.49	1.7	1.4	∞
23	Liquid permittivity (meas.)	A	1.6	N	1	0.6	0.49	0.31	0.25	9
24	Algorithm for correcting SAR for deviations in permittivity and conductivity	B	1.9	N	1	1	1	1.9	1.9	∞
Combined standard uncertainty			$u_c = \sqrt{\sum_{i=1}^{21} c_i^2 u_i^2}$					11.9	11.8	323
Expanded uncertainty (Confidence interval of 95 %)			$u_e = 2u_c$					23.8	23.7	

16.2 Measurement Uncertainty for Fast SAR Tests (300MHz~3GHz)

No.	Error Description	Type	Uncertainty value	Probably Distribution	Div.	(Ci) 1g	(Ci) 10g	Std. Unc. (1g)	Std. Unc. (10g)	Degree of freedom
Measurement system										
1	Probe calibration	B	6.0	N	1	1	1	6.0	6.0	∞
2	Isotropy	B	4.7	R	$\sqrt{3}$	1	1	1.6	1.6	∞
3	Boundary effect	B	1.0	R	$\sqrt{3}$	1	1	6.4	6.4	∞
4	Linearity	B	4.7	R	$\sqrt{3}$	1	1	0.5	0.5	∞
5	Detection limit	B	1.0	R	1	1	1	1	1	∞
6	Readout electronics	B	0.3	R	$\sqrt{3}$	1	1	0.6	0.6	∞
7	Response time	B	0.8	R	$\sqrt{3}$	1	1	0.0	0.0	∞
8	Integration time	B	2.6	R	$\sqrt{3}$	1	1	1.0	1.0	∞
9	RF ambient conditions-noise	B	0	R	$\sqrt{3}$	1	1	1.7	1.7	∞
10	RF ambient conditions-reflection	B	0	R	$\sqrt{3}$	1	1	1.7	1.7	∞
11	Probe positioned mech. Restrictions	B	0.4	R	$\sqrt{3}$	1	1	0.2	0.2	∞
12	Probe positioning with respect to phantom shell	B	2.9	R	$\sqrt{3}$	1	1	1.7	1.7	∞
13	Post-processing	B	1.0	R	$\sqrt{3}$	1	1	1.2	1.2	∞
14	Probe modulation response	B	2.3	R	$\sqrt{3}$	1	1	1.21	1.21	∞
15	Fast SAR z-Approximation	B	7.0	R	$\sqrt{3}$	1	4.0	4.0	1	∞
Test sample related										
16	Test sample positioning	A	3.3	N	1	1	1	3.3	3.3	71
17	Device holder uncertainty	A	3.4	N	1	1	1	3.4	3.4	5
18	Power scaling	B	2.2	R	$\sqrt{3}$	1	1	2.2	2.2	∞
19	Drift of output power	B	5.0	R	$\sqrt{3}$	1	1	2.9	2.9	∞
Phantom and set-up										
20	Phantom uncertainty	B	4.0	R	$\sqrt{3}$	1	1	2.3	2.3	∞
21	Liquid conductivity (target)	B	5.0	R	$\sqrt{3}$	0.64	0.43	1.8	1.2	∞
22	Liquid conductivity (meas.)	A	2.06	N	1	0.64	0.43	1.32	0.89	43
23	Liquid permittivity (target)	B	5.0	R	$\sqrt{3}$	0.6	0.49	1.7	1.4	∞
24	Liquid permittivity (meas.)	A	1.6	N	1	0.6	0.49	1.0	0.8	521
25	Algorithm for correcting SAR for deviations in permittivity and conductivity	B	1.9	N	1	1	0.84	1.9	1.6	∞

Combined standard uncertainty	$u_c = \sqrt{\sum_{i=1}^{22} c_i^2 u_i^2}$					12.6	12.5	257
Expanded uncertainty (Confidence interval of 95 %)	$u_e = 2u_c$					25.1	25.0	

17MAIN TEST INSTRUMENTS

Table 17.1: List of Main Instruments

No.	Name	Type	Serial Number	Calibration Date	Valid Period
01	Network analyzer	Agilent E5071C	MY46103759	2016-11-19	One year
02	Dielectricprobe	85070E	MY44300317	/	
03	Power meter	NRP	102603	2017-01-06	One year
04	Power sensor	NRP-Z51	102211		
05	Signal Generator	E8257D	MY47461211	2016-06-15	One year
06	Amplifier	VTL5400	0404	/	
07	DAE	SPEAG DAE4	786	2016-12-08	One year
08	E-field Probe	SPEAG ES3DV3	3151	2016-11-17	One year
09	Dipole Validation Kit	SPEAG D750V3	1163	2016-09-19	Three year
10	Dipole Validation Kit	SPEAG D835V2	4d057	2015-10-22	Three year
11	Dipole Validation Kit	SPEAG D1800V2	2d147	2015-11-03	Three year
12	Dipole Validation Kit	SPEAG D1900V2	5d088	2015-11-04	Three year
13	Dipole Validation Kit	SPEAG D2450V2	873	2015-10-30	Three year
14	BTS	E5515C	GB47460389	2017-01-06	One year
15	Radio Communication Analyzer	Anristu MT8820C	6201563767	2017-01-06	One year

END OF REPORT BODY

ANNEX A Graph Results

GSM850 Left Cheek High

Date/Time: 2017-2-8

Electronics: DAE4 Sn786

Medium: Head 835 MHz

Medium parameters used (interpolated): $f = 848.8$ MHz; $\sigma = 0.910$ S/m; $\epsilon_r = 41.018$; $\rho = 1000$ kg/m³

Ambient Temperature:22.6°C Liquid Temperature:22.1°C

Communication System: UID 0, 2G_GSM (0) Frequency: 848.8 MHz Duty Cycle: 1:8.3

Probe: ES3DV3 - SN3151ConvF(6.08,6.08, 6.08);

Left Cheek High/Area Scan (61x111x1): Interpolated grid: dx=1.500 mm, dy=1.500 mm

Maximum value of SAR (interpolated) = 0.312 W/kg

LeftCheek High/Zoom Scan (5x5x7)/Cube 0: Measurement grid: dx=8mm, dy=8mm, dz=5mm

Reference Value = 7.623 V/m; Power Drift = -0.08 dB

Peak SAR (extrapolated) = 0.296 W/kg

SAR(1 g) = 0.309 W/kg; SAR(10 g) = 0.231 W/kg

Maximum value of SAR (measured) = 0.327 W/kg

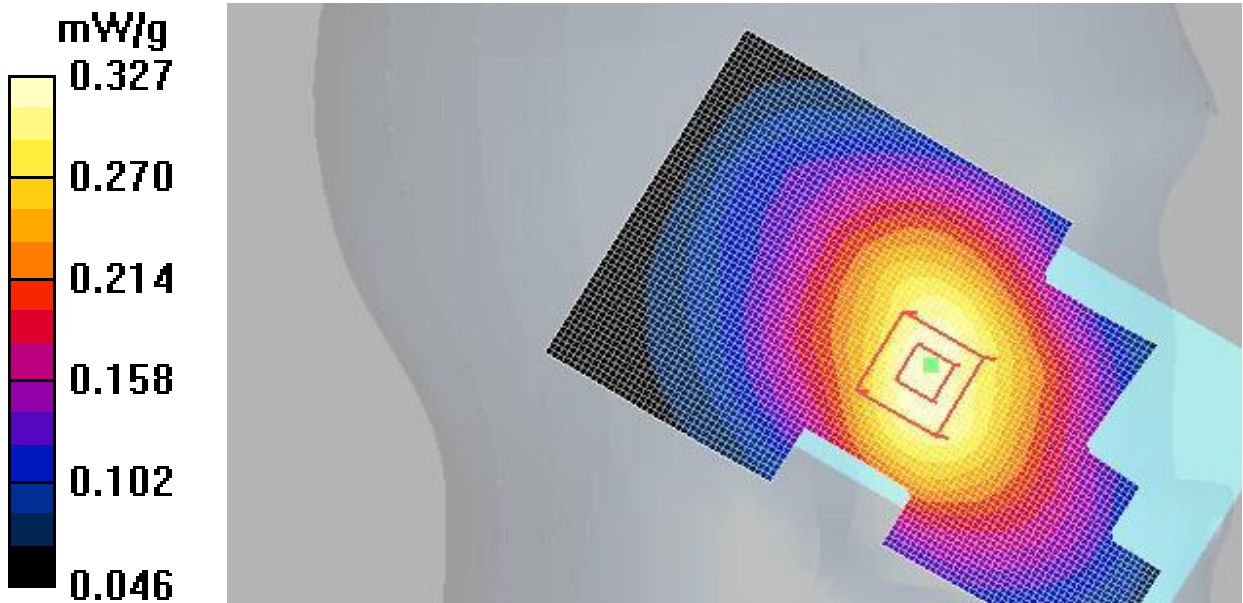

Fig.1 GSM 850MHz CH251

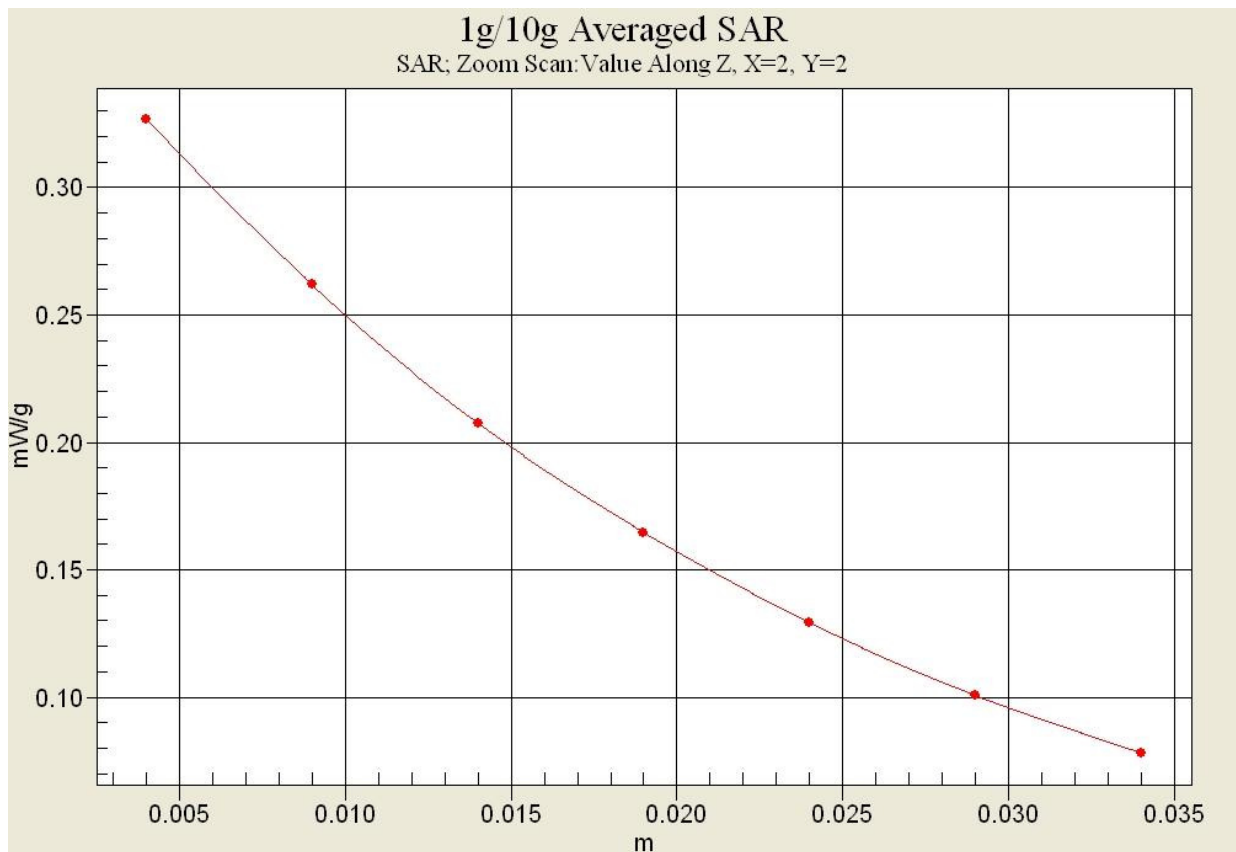

Fig.1-1 Z-Scan at power reference point (GSM 850 MHz CH251)

GSM850 Body RearMiddle

Date/Time: 2017-2-8

Electronics: DAE4 Sn786

Medium: Body 835 MHz

Medium parameters used (interpolated): $f = 836.6$ MHz; $\sigma = 0.985$ S/m; $\epsilon_r = 55.566$; $\rho = 1000$ kg/m³

Ambient Temperature: 22.6°C Liquid Temperature: 22.1°C

Communication System: UID 0, GPRS 1 Txslot (0) Frequency: 836.6 MHz Duty Cycle: 1:8.3

Probe: ES3DV3 - SN3151 ConvF(6.13, 6.13, 6.13);

Rear side Mid/Area Scan (41x111x1): Interpolated grid: dx=1.500 mm, dy=1.500 mm

Maximum value of SAR (interpolated) = 0.378 W/kg

Rear side Mid/Zoom Scan (5x5x7)/Cube 0: Measurement grid: dx=8mm, dy=8mm, dz=5mm

Reference Value = 19.108 V/m; Power Drift = 0.06 dB

Peak SAR (extrapolated) = 0.521 W/kg

SAR(1 g) = 0.378W/kg; SAR(10 g) = 0.282 W/kg

Maximum value of SAR (measured) = 0.382 W/kg

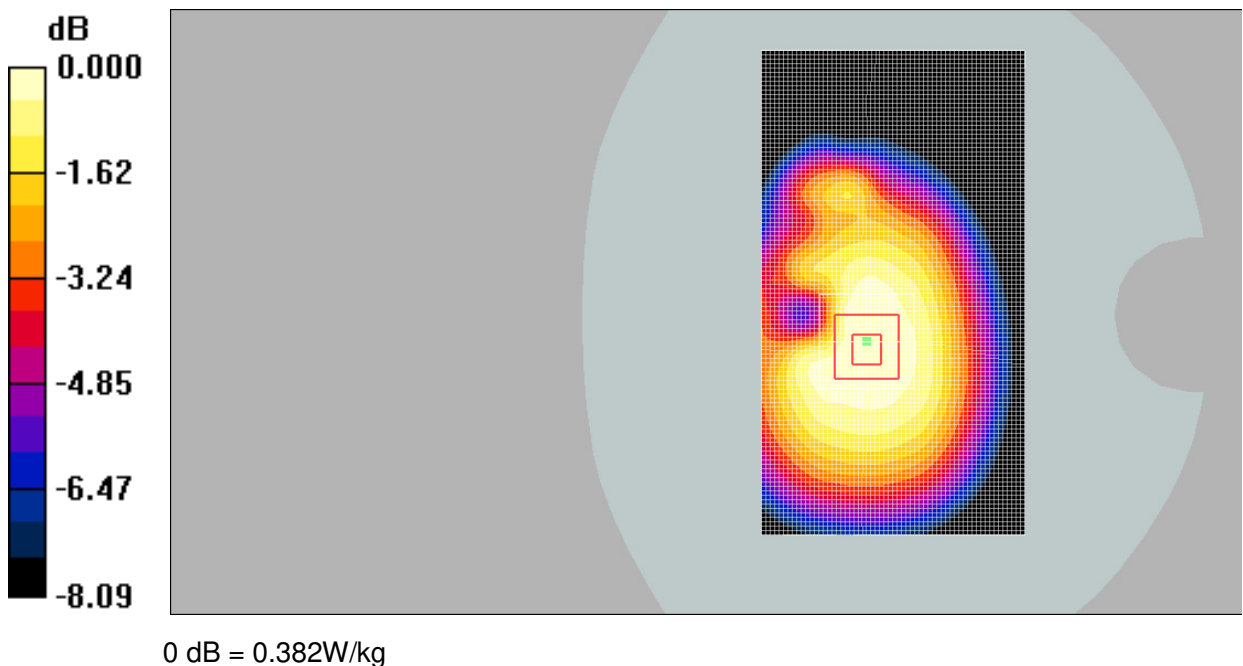

Fig.2 GSM 850 MHz CH190

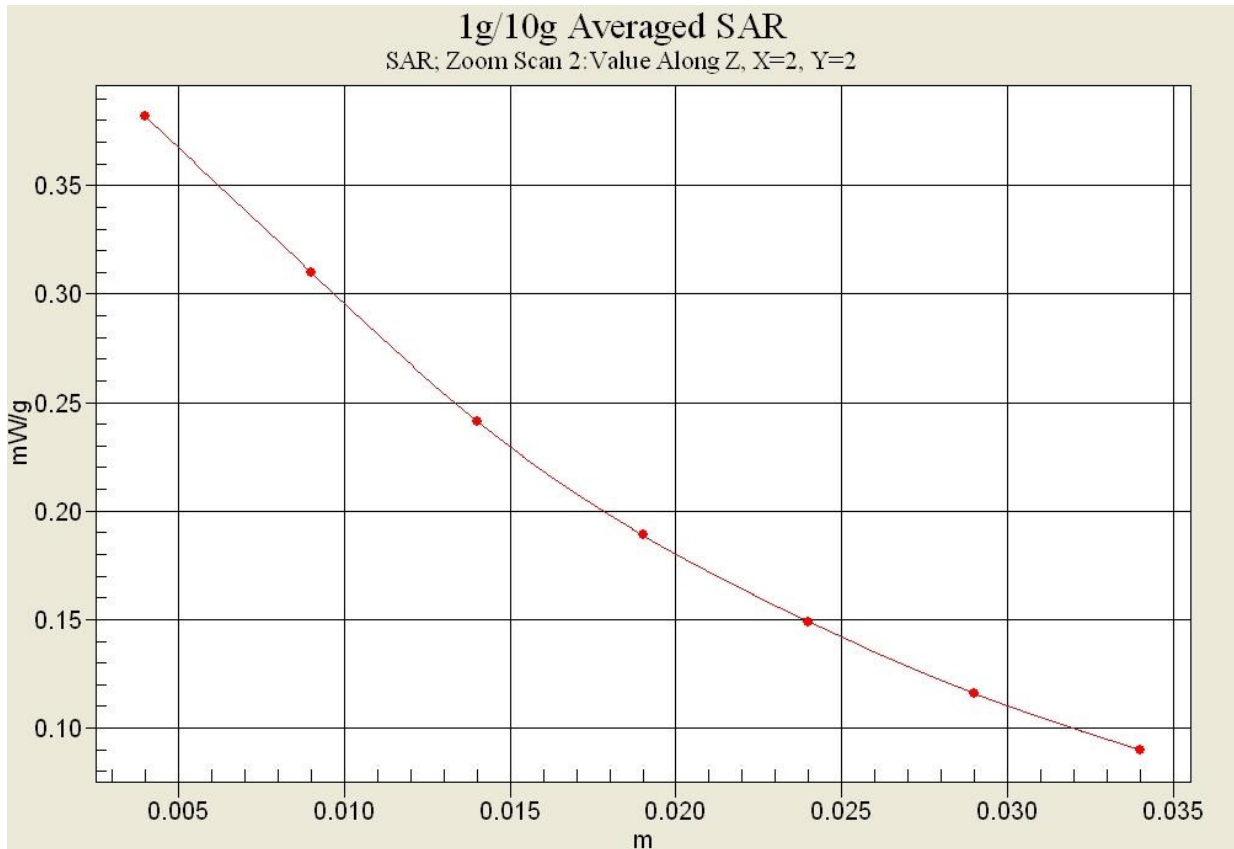

Fig.2-1 Z-Scan at power reference point (GSM 850 MHz CH190)

GSM1900 Right Cheek Low

Date/Time: 2017-2-12

Electronics: DAE4 Sn786

Medium: Head 1900 MHz

Medium parameters used (interpolated): $f = 1850.2$ MHz; $\sigma = 1.377$ S/m; $\epsilon_r = 40.793$; $\rho = 1000$ kg/m³

Ambient Temperature:22.2°C Liquid Temperature:21.7°C

Communication System: UID 0, 2G_GSM (0) Frequency: 1850.2 MHz Duty Cycle: 1:8.3

Probe: ES3DV3 - SN3151 ConvF(4.88, 4.88, 4.88);

Right Cheek Low/Area Scan (61x111x1): Interpolated grid: dx=1.500 mm, dy=1.500 mm

Maximum value of SAR (interpolated) = 0.023 W/kg

Right Cheek Low/Zoom Scan (5x5x7)/Cube0: Measurement grid: dx=8mm, dy=8mm, dz=5mm

Reference Value = 1.817 V/m; Power Drift = -0.11 dB

Peak SAR (extrapolated) = 0.025 W/kg

SAR(1 g) = 0.021 W/kg; SAR(10 g) = 0.012 W/kg

Maximum value of SAR (measured) = 0.022W/kg

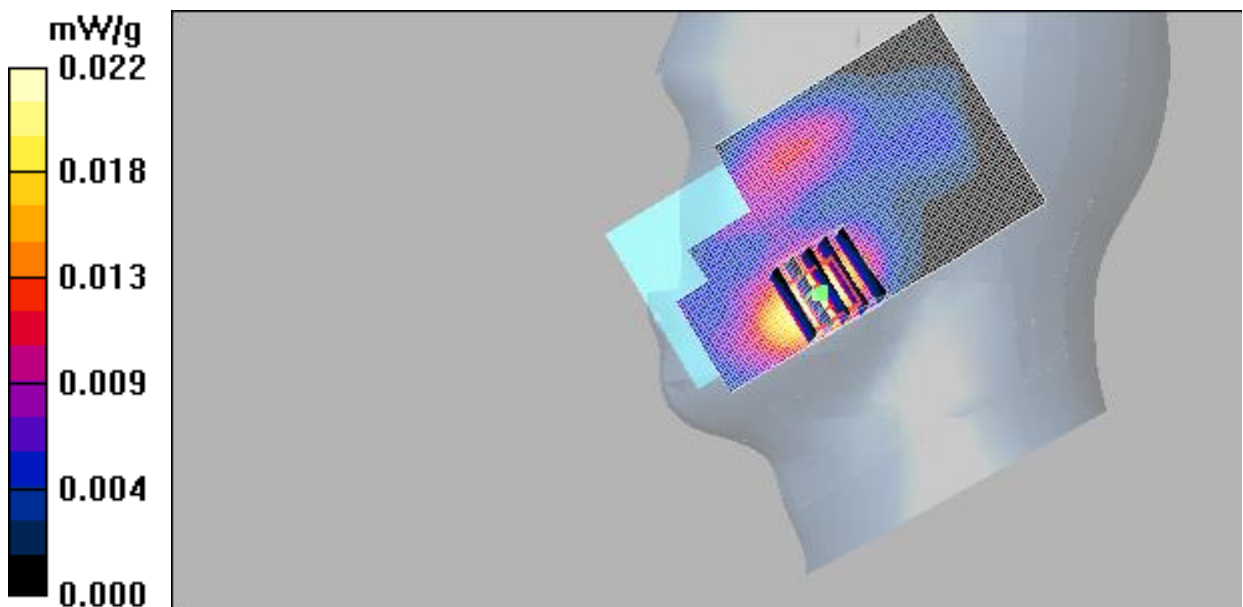

Fig.3 GSM 1900 MHz CH512

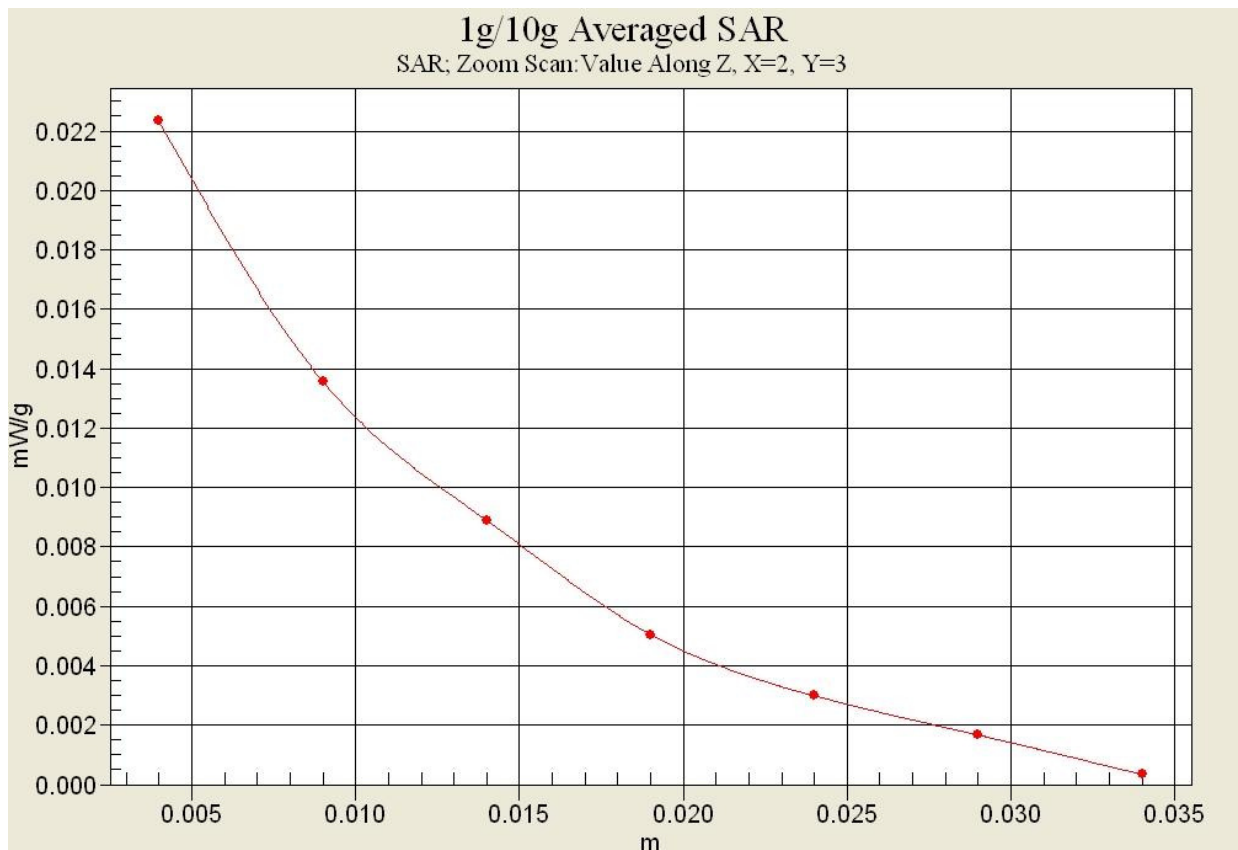

Fig.3-1 Z-Scan at power reference point (GSM 1900 MHz CH512)

GSM1900 Body Rear Middle

Date/Time: 2017-2-12

Electronics: DAE4 Sn786

Medium: Body 1900 MHz

Medium parameters used: $f = 1880$ MHz; $\sigma = 1.531$ S/m; $\epsilon_r = 52.973$; $\rho = 1000$ kg/m³

Ambient Temperature: 22.2°C Liquid Temperature: 21.7°C

Communication System: UID 0, GPRS 4 Txslot (0) Frequency: 1880 MHz Duty Cycle: 1:2

Probe: ES3DV3 - SN3151 ConvF(4.49, 4.49, 4.49);

Rear side Mid/Area Scan (51x61x1): Interpolated grid: dx=1.500 mm, dy=1.500 mm

Maximum value of SAR (interpolated) = 0.713 W/kg

Rear side Mid/Zoom Scan (5x5x7)/Cube 0: Measurement grid: dx=8mm, dy=8mm, dz=5mm

Reference Value = 9.286 V/m; Power Drift = 0.12 dB

Peak SAR (extrapolated) = 1.07 W/kg

SAR(1 g) = 0.668 W/kg; SAR(10 g) = 0.346 W/kg

Maximum value of SAR (measured) = 0.692 W/kg

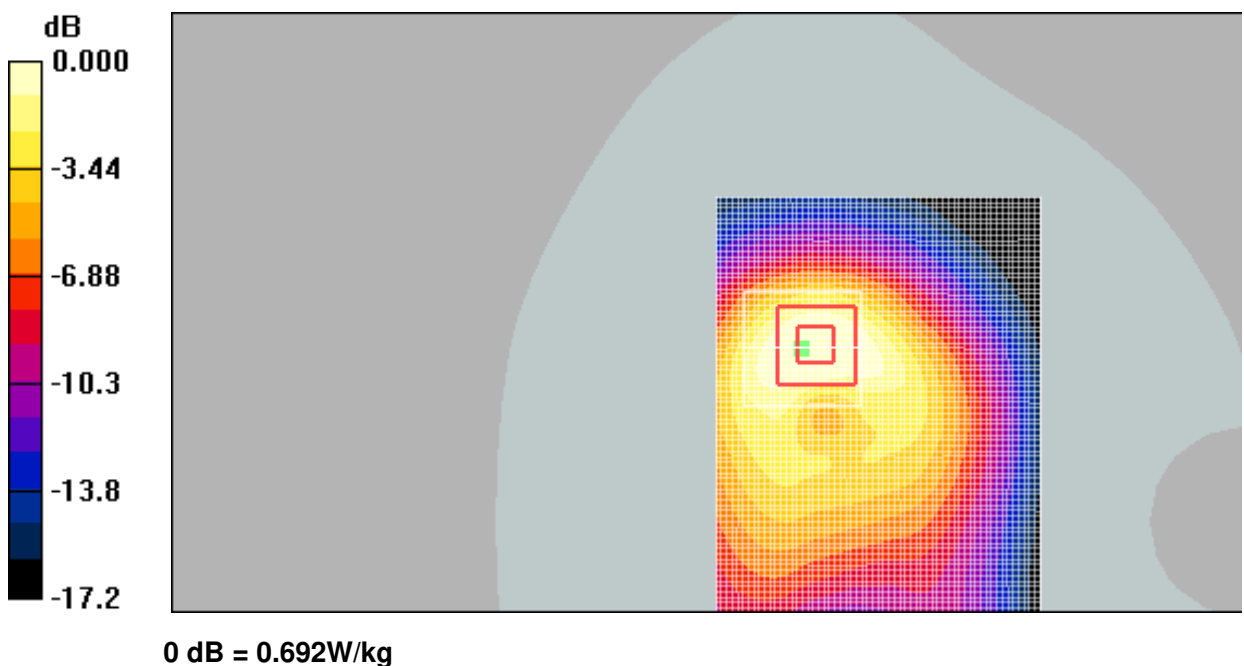

Fig.4 GSM 1900 MHz CH661

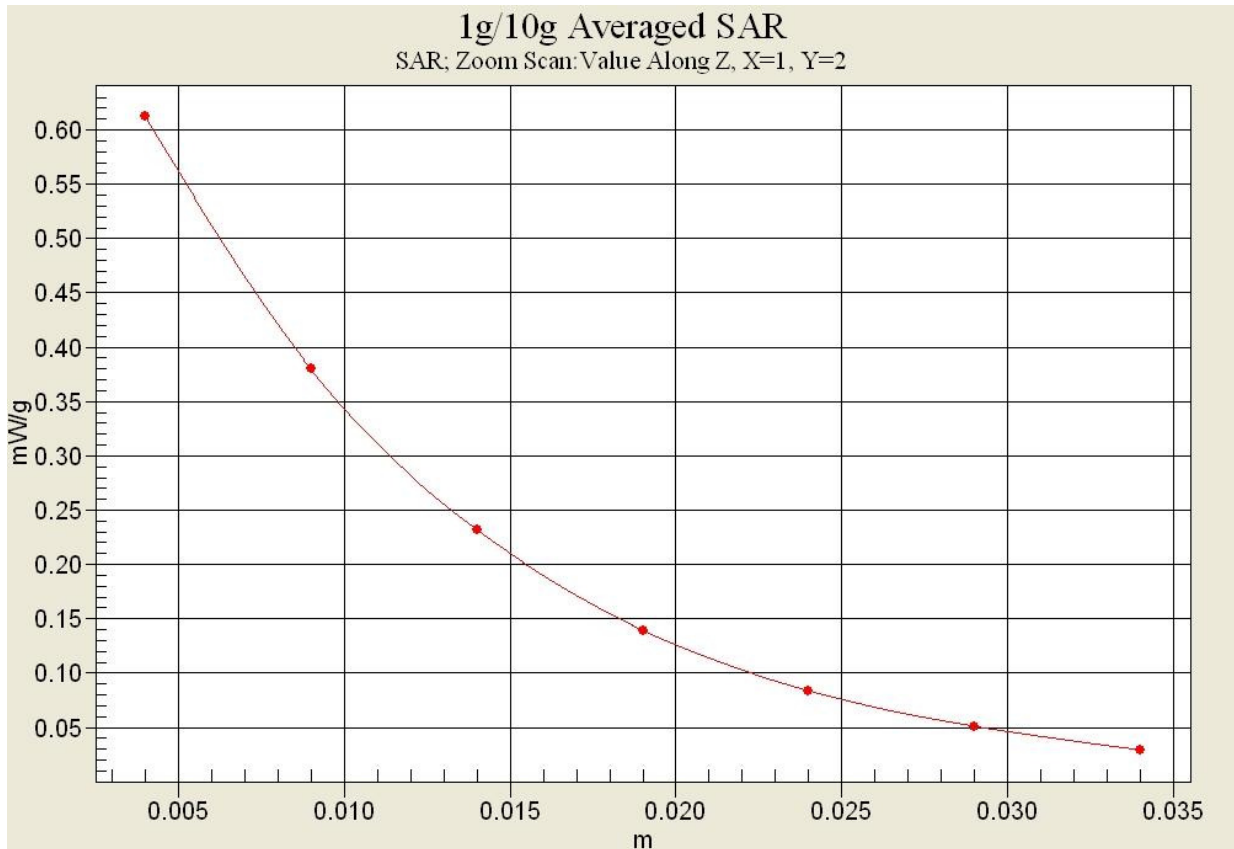

Fig.4-1 Z-Scan at power reference point (GSM 1900 MHz CH661)

WCDMA 850 Left Cheek Low

Date/Time: 2017-2-8

Electronics: DAE4 Sn786

Medium: Head 835 MHz

Medium parameters used (interpolated): $f = 826.4$ MHz; $\sigma = 0.889$ S/m; $\epsilon_r = 41.282$; $\rho = 1000$ kg/m³

Ambient Temperature: 22.5°C Liquid Temperature: 22.0°C

Communication System: UID 0, 3G_WCDMA (0) Frequency: 826.4 MHz Duty Cycle: 1:1

Probe: ES3DV3 - SN3151 ConvF(6.08, 6.08, 6.08);

Left CheekLow/Area Scan (61x111x1): Interpolated grid: dx=1.500 mm, dy=1.500 mm

Maximum value of SAR (interpolated) = 0.752 W/kg

Left Cheek Low/Zoom Scan (5x5x7)/Cube 0: Measurement grid: dx=8mm, dy=8mm, dz=5mm

Reference Value = 14.625 V/m; Power Drift = -0.04dB

Peak SAR (extrapolated) = 0.875 W/kg

SAR(1 g) = 0.520 W/kg; SAR(10 g) = 0.387 W/kg

Maximum value of SAR (measured) = 0.655 W/kg

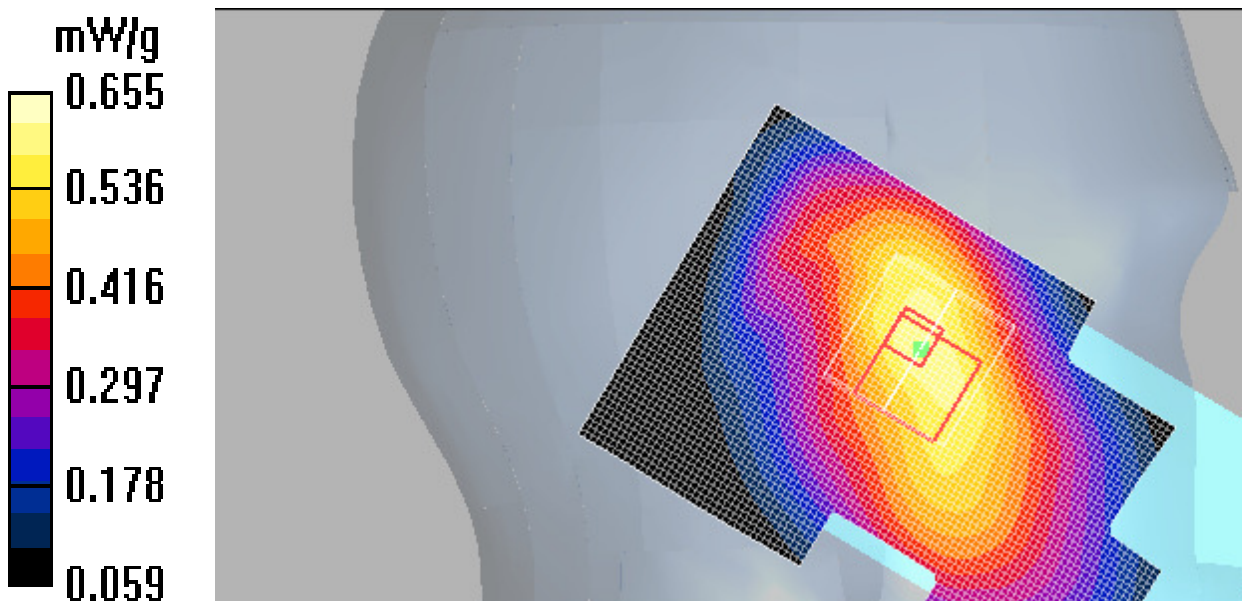

Fig.5 WCDMA 850 CH4132

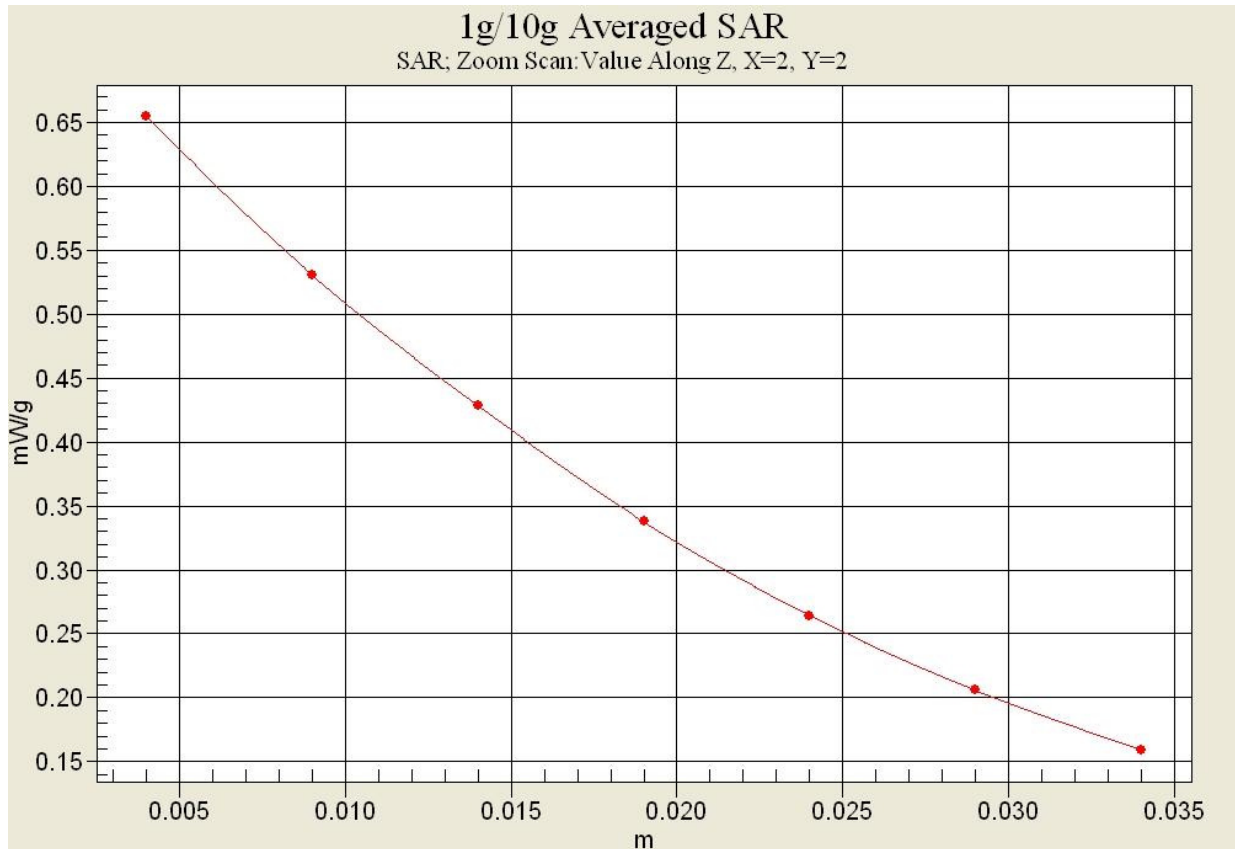

Fig.5-1 Z-Scan at power reference point (WCDMA 850 CH4132)

WCDMA 850 Body RearHigh

Date/Time: 2017-2-8

Electronics: DAE4 Sn786

Medium: Body 835 MHz

Medium parameters used (interpolated): $f = 846.6$ MHz; $\sigma = 0.994$ S/m; $\epsilon_r = 55.483$; $\rho = 1000$ kg/m³

Ambient Temperature: 22.5°C Liquid Temperature: 22.0°C

Communication System: UID 0, 3G_WCDMA (0) Frequency: 846.6 MHz Duty Cycle: 1:1

Probe: ES3DV3 - SN3151 ConvF(6.13, 6.13, 6.13);

Rear side High/Area Scan (41x111x1): Interpolated grid: dx=1.500 mm, dy=1.500 mm

Maximum value of SAR (interpolated) = 0.685 W/kg

Rear side High/Zoom Scan (5x5x7)/Cube 0: Measurement grid: dx=8mm, dy=8mm, dz=5mm

Reference Value = 26.154 V/m; Power Drift = 0.06 dB

Peak SAR (extrapolated) = 0.806 W/kg

SAR(1 g) = 0.676 W/kg; SAR(10 g) = 0.524 W/kg

Maximum value of SAR (measured) = 0.706 W/kg

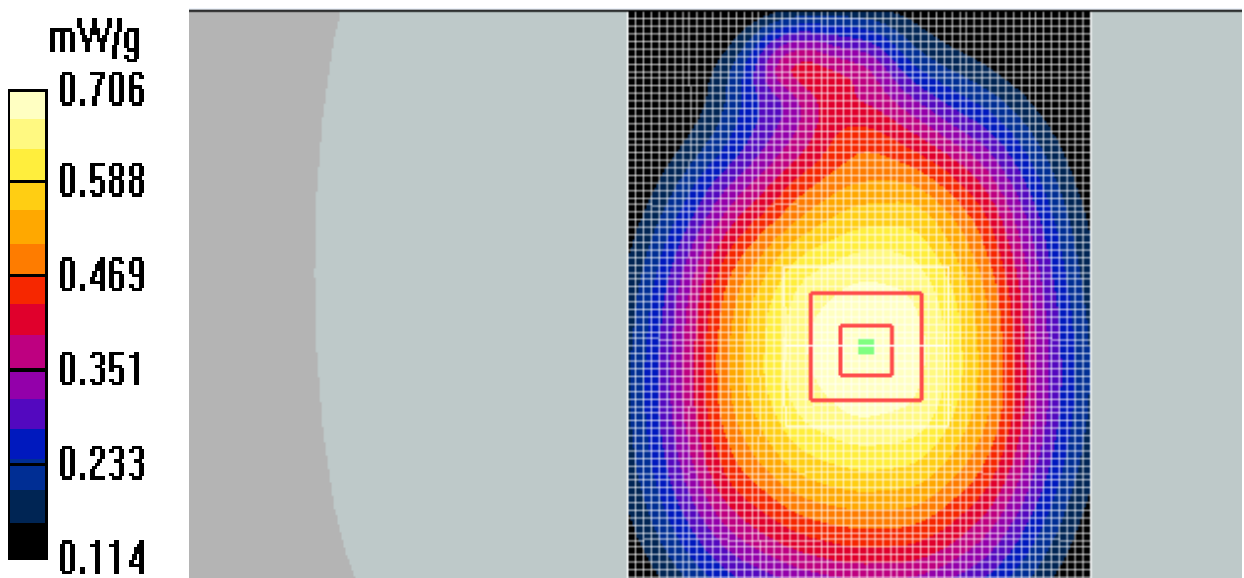

Fig.6 WCDMA 850 CH4182

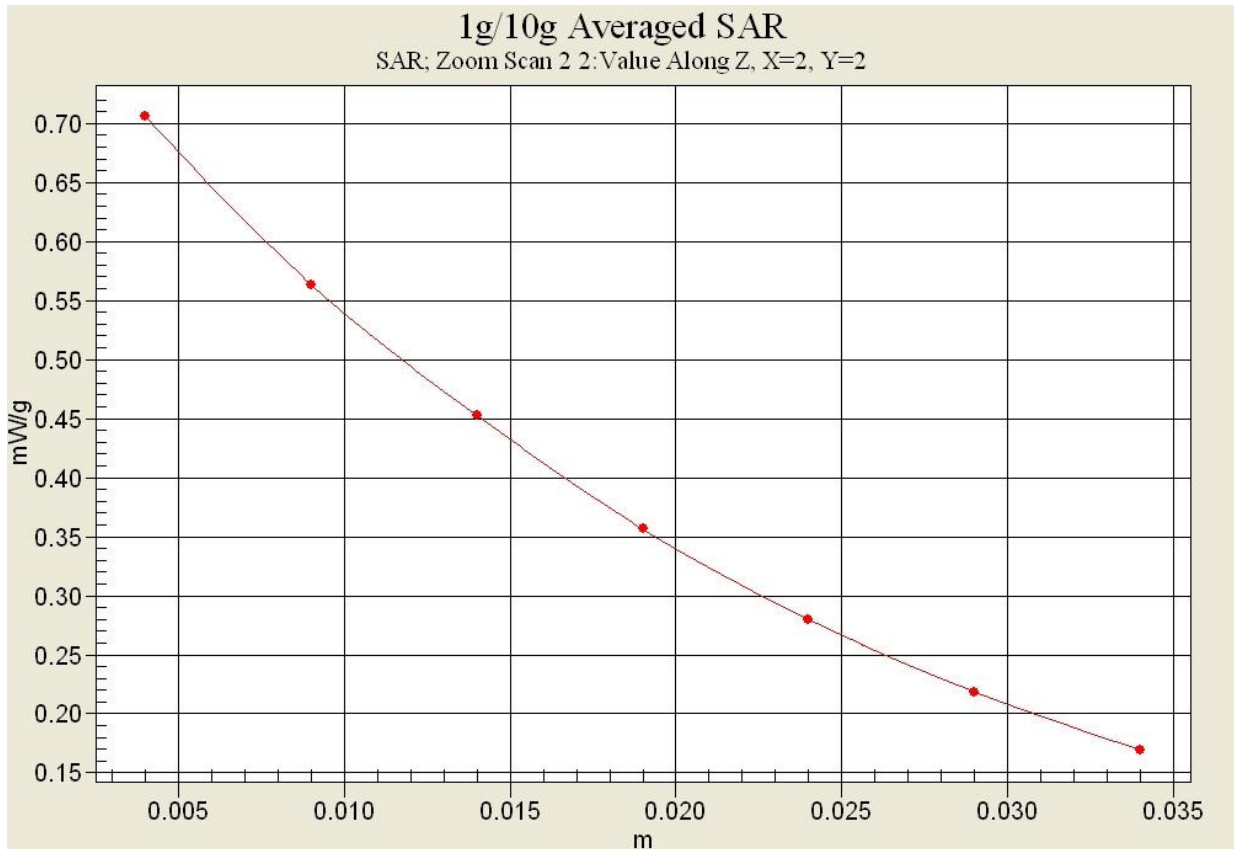

Fig.6-1 Z-Scan at power reference point (WCDMA850 CH4182)