

FCC SAR Test Report

Report No. : SA181018W001

Applicant : Yulong Computer Telecommunication Scientific (Shenzhen) Co., Ltd

Address : Building B, Boton Science Park, Chaguang Road, Xili Town, Nanshan District, Shenzhen

Product : Feature phone

FCC ID : R38YL3312A

Brand : coolpad

Model No. : Coolpad 3312A

Standards : FCC 47 CFR Part 2 (2.1093) / IEEE C95.1:1992 / IEEE 1528:2013
 KDB 865664 D01 v01r04 / KDB 865664 D02 v01r02
 KDB 248227 D01 v02r02 / KDB 447498 D01 v06 / KDB 648474 D04 v01r03
 / KDB 941225 D01 v03r01 / KDB 941225 D05 v02r05 / KDB 941225 D06 v02r01

Sample Received Date : Nov. 01, 2018

Date of Testing : Nov. 02, 2018 ~ Nov. 17, 2018

CERTIFICATION: The above equipment have been tested by **BV 7LAYERS COMMUNICATIONS TECHNOLOGY (SHENZHEN) CO. LTD.**, and found compliance with the requirement of the above standards. The test record, data evaluation & Equipment Under Test (EUT) configurations represented herein are true and accurate accounts of the measurements of the sample’s SAR characteristics under the conditions specified in this report. It should not be reproduced except in full, without the written approval of our laboratory. The client should not use it to claim product certification, approval, or endorsement by A2LA or any government agencies.

Prepared By : Xianxiong Qin
 Xianxiong Qin / Engineer



Approved By : Luke Lu
 Luke Lu / Manager

This report is governed by, and incorporates by reference, CPS Conditions of Service as posted at the date of issuance of this report at <http://www.bureauveritas.com/home/about-us/our-business/cps/about-us/terms-conditions> and is intended for your exclusive use. Any copying or replication of this report to or for any other person or entity, or use of our name or trademark, is permitted only with our prior written permission. This report sets forth our findings solely with respect to the test samples identified herein. The results set forth in this report are not indicative or representative of the quality or characteristics of the lot from which a test sample was taken or any similar or identical product unless specifically and expressly noted. Our report includes all of the tests requested by you and the results thereof based upon the information that you provided to us. Measurement uncertainty is only provided upon request for accredited tests. You have 60 days from date of issuance of this report to notify us of any material error or omission caused by our negligence or if you require measurement uncertainty; provided, however, that such notice shall be in writing and shall specifically address the issue you wish to raise. A failure to raise such issue within the prescribed time shall constitute your unqualified acceptance of the completeness of this report, the tests conducted and the correctness of the report contents.

Table of Contents

Release Control Record	3
1. Summary of Maximum SAR Value	4
2. Description of Equipment Under Test	5
3. SAR Measurement System	6
3.1 Definition of Specific Absorption Rate (SAR)	6
3.2 SPEAG DASY System	6
3.2.1 Robot.....	7
3.2.2 Probes.....	8
3.2.3 Data Acquisition Electronics (DAE)	8
3.2.4 Phantoms	9
3.2.5 Device Holder.....	10
3.2.6 System Validation Dipoles.....	10
3.2.7 Tissue Simulating Liquids.....	11
3.3 SAR System Verification	14
3.4 SAR Measurement Procedure	15
3.4.1 Area & Zoom Scan Procedure	15
3.4.2 Volume Scan Procedure.....	15
3.4.3 Power Drift Monitoring.....	16
3.4.4 Spatial Peak SAR Evaluation	16
3.4.5 SAR Averaged Methods	16
4. SAR Measurement Evaluation	17
4.1 EUT Configuration and Setting.....	17
4.2 EUT Testing Position	22
4.2.1 Head Exposure Conditions.....	22
4.2.2 Body-worn Accessory Exposure Conditions.....	24
4.2.3 Hotspot Mode Exposure Conditions	25
4.2.4 SAR Test Exclusion Evaluations	26
4.2.5 Simultaneous Transmission Possibilities.....	27
4.3 Tissue Verification	28
4.4 System Validation.....	28
4.5 System Verification.....	29
4.6 Maximum Output Power.....	30
4.6.1 Maximum Conducted Power	30
4.6.2 Measured Conducted Power Result.....	32
4.7 SAR Testing Results	50
4.7.1 SAR Test Reduction Considerations	50
4.7.2 SAR Results for Head Exposure Condition	52
4.7.3 SAR Results for Body-worn Exposure Condition (Separation Distance is 1.5 cm Gap).....	54
4.7.4 SAR Results for Hotspot Exposure Condition (Separation Distance is 1.0 cm Gap).....	56
4.7.5 SAR Measurement Variability.....	61
4.7.6 Simultaneous Multi-band Transmission Evaluation	62
5. Calibration of Test Equipment.....	70
6. Measurement Uncertainty	71
7. Information on the Testing Laboratories.....	72
Appendix A. SAR Plots of System Verification	
Appendix B. SAR Plots of SAR Measurement	
Appendix C. Calibration Certificate for Probe and Dipole	
Appendix D. Photographs of EUT and Setup	



Release Control Record

Report No.	Reason for Change	Date Issued
SA181018W001	Initial release	Nov. 28, 2018

1. Summary of Maximum SAR Value

Equipment Class	Mode	Highest Reported Head SAR _{1g} (W/kg)	Highest Reported Body-worn SAR _{1g} (1.5 cm Gap) (W/kg)	Highest Reported Hotspot SAR _{1g} (1.0 cm Gap) (W/kg)
PCE	GSM850	0.28	1.25	0.58
	GSM1900	0.31	0.43	0.80
	CDMA BC0	0.21	1.03	0.91
	CDMA BC1	0.19	1.17	1.20
	CDMA BC10	0.22	1.05	1.06
	LTE 2	0.19	0.86	1.24
	LTE 4	0.18	0.71	1.12
	LTE 5	0.79	0.85	1.14
	LTE 12	0.50	0.45	0.77
	LTE 13	0.49	0.43	0.68
	LTE 25	0.16	0.79	1.25
	LTE 26	0.80	0.90	1.23
LTE 41	0.15	0.34	0.47	
DTS	2.4G WLAN	0.22	0.10	0.13
DSS	Bluetooth	N/A	N/A	N/A
Highest Simultaneous Transmission SAR		Head (W/kg)	Body-worn (W/kg)	Hotspot (W/kg)
PCE + DTS		1.02	1.35	1.38
PCE + DSS		N/A	1.27	N/A

Note:

- The SAR limit (**Head & Body: SAR_{1g} 1.6 W/kg**) for general population / uncontrolled exposure is specified in FCC 47 CFR part 2 (2.1093) and ANSI/IEEE C95.1-1992.

2. Description of Equipment Under Test

EUT Type	Feature phone
FCC ID	R38YL3312A
Brand Name	coolpad
Model Name	Coolpad 3312A
IMEI Code	990008010004260
HW Version	P1
SW Version	3312A.SPRINT.181214.0D
Tx Frequency Bands (Unit: MHz)	GSM850 : 824.2 ~ 848.8 GSM1900 : 1850.2 ~ 1909.8 CDMA BC0 : 824.7 ~ 848.31 CDMA BC1 : 1851.25 ~ 1908.75 CDMA BC10 : 817.9 ~ 823.1 LTE Band 2 : 1850.7 ~ 1909.3 (1.4M), 1851.5 ~ 1908.5 (3M), 1852.5 ~ 1907.5 (5M), 1855 ~ 1905 (10M), 1857.5 ~ 1902.5 (15M), 1860 ~ 1900 (20M) LTE Band 4 : 1710.7 ~ 1754.3 (1.4M), 1711.5 ~ 1753.5 (3M), 1712.5 ~ 1752.5 (5M), 1715 ~ 1750 (10M), 1717.5 ~ 1747.5 (15M), 1720 ~ 1745 (20M) LTE Band 5 : 824.7 ~ 848.3 (1.4M), 825.5 ~ 847.5 (3M), 826.5 ~ 846.5 (5M), 829 ~ 844 (10M) LTE Band 12 : 699.7 ~ 715.3 (1.4M), 700.5 ~ 714.5 (3M), 701.5 ~ 713.5 (5M), 704 ~ 711 (10M) LTE Band 13 : 779.5 ~ 784.5 (5M), 782 (10M) LTE Band 25 : 1850.7 ~ 1914.3 (1.4M), 1851.5 ~ 1913.5 (3M), 1852.5 ~ 1912.5 (5M), 1855 ~ 1910 (10M), 1857.5 ~ 1907.5 (15M), 1860 ~ 1905 (20M) LTE Band 26 : 814.7 ~ 848.3 (1.4M), 815.5 ~ 847.5 (3M), 816.5 ~ 846.5 (5M), 819 ~ 844 (10M), 821.5 ~ 841.5 (15M) LTE Band 41 : 2498.5 ~ 2687.5 (5M), 2501 ~ 2685 (10M), 2503.5 ~ 2682.5 (15M), 2506 ~ 2680 (20M) WLAN : 2412 ~ 2462 Bluetooth : 2402 ~ 2480
Uplink Modulations	GSM & GPRS : GMSK EDGE : 8PSK CDMA : QPSK LTE : QPSK, 16QAM 802.11b : DSSS 802.11g/n : OFDM Bluetooth : GFSK, $\pi/4$ -DQPSK, 8-DPSK, LE
Maximum Tune-up Conducted Power (Unit: dBm)	Please refer to section 4.6.1 of this report.
Antenna Type	WLAN: PIFA Antenna WWAN: Fixed Internal Antenna

Note:

- The above EUT information is declared by manufacturer and for more detailed features description please refers to the manufacturer's specifications or User's Manual.

List of Accessory:

Battery 1	Model Name	CPLD-194
	Power Rating	3.7Vdc, 1390mAh
	Type	Li-ion
	Manufacturer	ShangHai BYD COMPANY LIMITED
Battery 2	Model Name	CPLD-194
	Power Rating	3.7Vdc, 1390mAh
	Manufacturer	SHENZHEN RUIDE ELECTRONIC INDUSTRIAL CO.,LTD

3. SAR Measurement System

3.1 Definition of Specific Absorption Rate (SAR)

SAR is related to the rate at which energy is absorbed per unit mass in an object exposed to a radio field. The SAR distribution in a biological body is complicated and is usually carried out by experimental techniques or numerical modeling. The standard recommends limits for two tiers of groups, occupational/controlled and general population/uncontrolled, based on a person's awareness and ability to exercise control over his or her exposure. In general, occupational/controlled exposure limits are higher than the limits for general population/uncontrolled.

The SAR definition is the time derivative (rate) of the incremental energy (dW) absorbed by (dissipated in) an incremental mass (dm) contained in a volume element (dv) of a given density (ρ). The equation description is as below:

$$\text{SAR} = \frac{d}{dt} \left(\frac{dW}{dm} \right) = \frac{d}{dt} \left(\frac{dW}{\rho dv} \right)$$

SAR is expressed in units of Watts per kilogram (W/kg)

SAR measurement can be related to the electrical field in the tissue by

$$\text{SAR} = \frac{\sigma |E|^2}{\rho}$$

Where: σ is the conductivity of the tissue, ρ is the mass density of the tissue and E is the RMS electrical field strength.

3.2 SPEAG DASY System

DASY system consists of high precision robot, probe alignment sensor, phantom, robot controller, controlled measurement server and near-field probe. The robot includes six axes that can move to the precision position of the DASY5 software defined. The DASY software can define the area that is detected by the probe. The robot is connected to controlled box. Controlled measurement server is connected to the controlled robot box. The DAE includes amplifier, signal multiplexing, AD converter, offset measurement and surface detection. It is connected to the Electro-optical coupler (ECO). The ECO performs the conversion from the optical into digital electric signal of the DAE and transfers data to the PC.

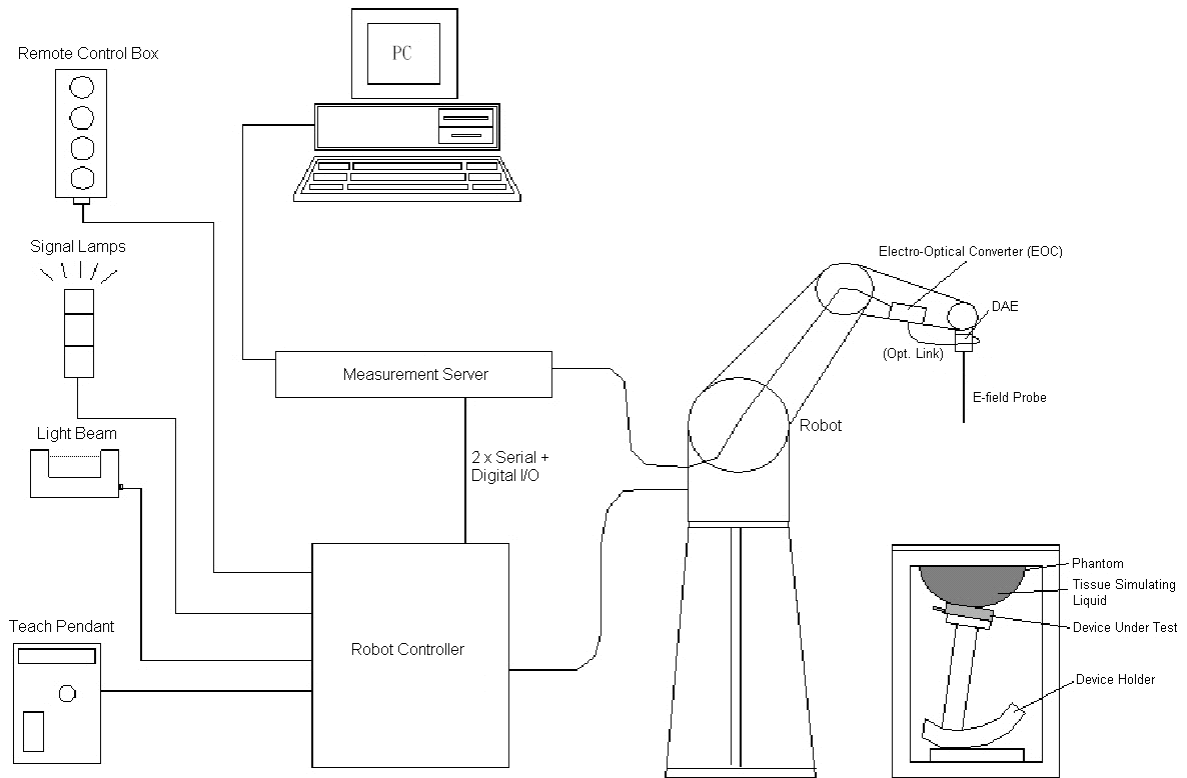

Fig-3.1 DASY System Setup

3.2.1 Robot

The DASY system uses the high precision robots from Stäubli SA (France). For the 6-axis controller system, the robot controller version (DASY5: CS8c) from Stäubli is used. The Stäubli robot series have many features that are important for our application:

- High precision (repeatability ± 0.035 mm)
- High reliability (industrial design)
- Jerk-free straight movements
- Low ELF interference (the closed metallic construction shields against motor control fields)





Fig-3.2 DASY5

FCC SAR Test Report

3.2.2 Probes

The SAR measurement is conducted with the dosimetric probe. The probe is specially designed and calibrated for use in liquid with high permittivity. The dosimetric probe has special calibration in liquid at different frequency.

Model	EX3DV4	
Construction	Symmetrical design with triangular core. Built-in shielding against static charges. PEEK enclosure material (resistant to organic solvents, e.g., DGBE).	
Frequency	10 MHz to 6 GHz Linearity: ± 0.2 dB	
Directivity	± 0.3 dB in HSL (rotation around probe axis) ± 0.5 dB in tissue material (rotation normal to probe axis)	
Dynamic Range	10 μ W/g to 100 mW/g Linearity: ± 0.2 dB (noise: typically < 1 μ W/g)	
Dimensions	Overall length: 337 mm (Tip: 20 mm) Tip diameter: 2.5 mm (Body: 12 mm) Typical distance from probe tip to dipole centers: 1 mm	

Model	ES3DV3	
Construction	Symmetrical design with triangular core. Interleaved sensors. Built-in shielding against static charges. PEEK enclosure material (resistant to organic solvents, e.g., DGBE).	
Frequency	10 MHz to 4 GHz Linearity: ± 0.2 dB	
Directivity	± 0.2 dB in HSL (rotation around probe axis) ± 0.3 dB in tissue material (rotation normal to probe axis)	
Dynamic Range	5 μ W/g to 100 mW/g Linearity: ± 0.2 dB	
Dimensions	Overall length: 337 mm (Tip: 20 mm) Tip diameter: 3.9 mm (Body: 12 mm) Distance from probe tip to dipole centers: 2.0 mm	

3.2.3 Data Acquisition Electronics (DAE)

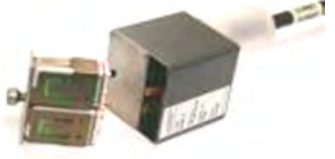
Model	DAE3, DAE4	
Construction	Signal amplifier, multiplexer, A/D converter and control logic. Serial optical link for communication with DASY embedded system (fully remote controlled). Two step probe touch detector for mechanical surface detection and emergency robot stop.	
Measurement Range	-100 to +300 mV (16 bit resolution and two range settings: 4mV, 400mV)	
Input Offset Voltage	< 5 μ V (with auto zero)	
Input Bias Current	< 50 fA	
Dimensions	60 x 60 x 68 mm	

FCC SAR Test Report

3.2.4 Phantoms

Model	Twin SAM	
Construction	The shell corresponds to the specifications of the Specific Anthropomorphic Mannequin (SAM) phantom defined in IEEE 1528 and IEC 62209-1. It enables the dosimetric evaluation of left and right hand phone usage as well as body mounted usage at the flat phantom region. A cover prevents evaporation of the liquid. Reference markings on the phantom allow the complete setup of all predefined phantom positions and measurement grids by teaching three points with the robot.	
Material	Vinylester, glass fiber reinforced (VE-GF)	
Shell Thickness	2 ± 0.2 mm (6 ± 0.2 mm at ear point)	
Dimensions	Length: 1000 mm Width: 500 mm Height: adjustable feet	
Filling Volume	approx. 25 liters	

Model	ELI	
Construction	Phantom for compliance testing of handheld and body-mounted wireless devices in the frequency range of 30 MHz to 6 GHz. ELI is fully compatible with the IEC 62209-2 standard and all known tissue simulating liquids. ELI has been optimized regarding its performance and can be integrated into our standard phantom tables. A cover prevents evaporation of the liquid. Reference markings on the phantom allow installation of the complete setup, including all predefined phantom positions and measurement grids, by teaching three points. The phantom is compatible with all SPEAG dosimetric probes and dipoles.	
Material	Vinylester, glass fiber reinforced (VE-GF)	
Shell Thickness	2.0 ± 0.2 mm (bottom plate)	
Dimensions	Major axis: 600 mm Minor axis: 400 mm	
Filling Volume	approx. 30 liters	

FCC SAR Test Report

3.2.5 Device Holder

Model	Mounting Device	
Construction	In combination with the Twin SAM Phantom or ELI4, the Mounting Device enables the rotation of the mounted transmitter device in spherical coordinates. Rotation point is the ear opening point. Transmitter devices can be easily and accurately positioned according to IEC, IEEE, FCC or other specifications. The device holder can be locked for positioning at different phantom sections (left head, right head, flat).	
Material	POM	

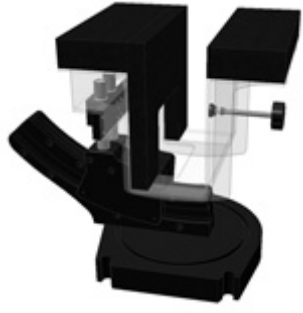
Model	Laptop Extensions Kit	
Construction	Simple but effective and easy-to-use extension for Mounting Device that facilitates the testing of larger devices according to IEC 62209-2 (e.g., laptops, cameras, etc.). It is lightweight and fits easily on the upper part of the Mounting Device in place of the phone positioner.	
Material	POM, Acrylic glass, Foam	

3.2.6 System Validation Dipoles

Model	D-Serial	
Construction	Symmetrical dipole with 1/4 balun. Enables measurement of feed point impedance with NWA. Matched for use near flat phantoms filled with tissue simulating solutions.	
Frequency	750 MHz to 5800 MHz	
Return Loss	> 20 dB	
Power Capability	> 100 W (f < 1GHz), > 40 W (f > 1GHz)	

3.2.7 Tissue Simulating Liquids

For SAR measurement of the field distribution inside the phantom, the phantom must be filled with homogeneous tissue simulating liquid to a depth of at least 15 cm. For head SAR testing, the liquid height from the ear reference point (ERP) of the phantom to the liquid top surface is larger than 15 cm. For body SAR testing, the liquid height from the center of the flat phantom to the liquid top surface is larger than 15 cm. The nominal dielectric values of the tissue simulating liquids in the phantom and the tolerance of 5% are listed in Table-3.1.

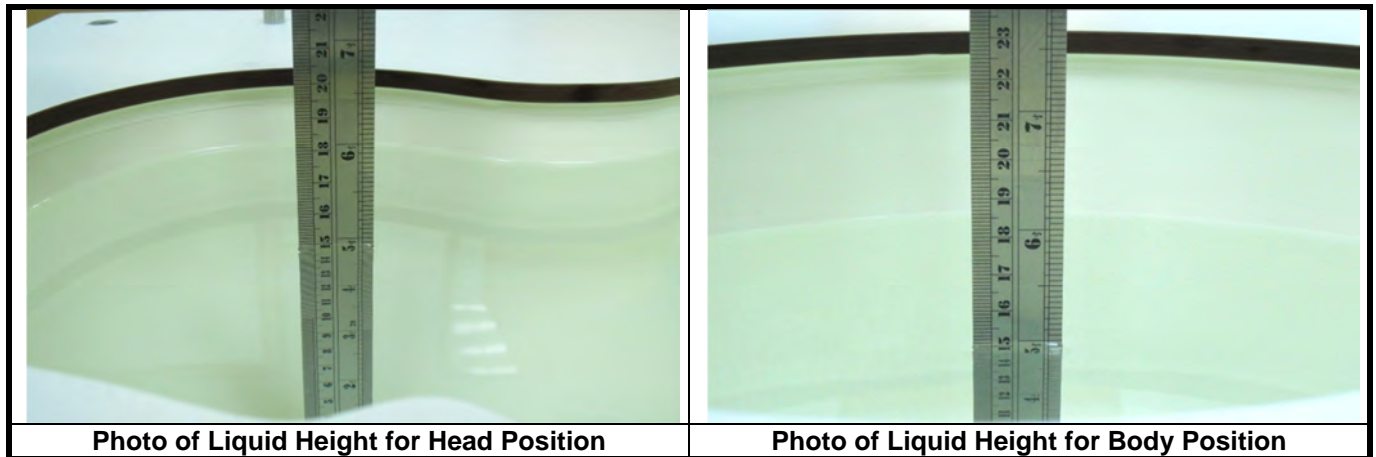

The dielectric properties of the head tissue simulating liquids are defined in IEEE 1528, and KDB 865664 D01 Appendix A. For the body tissue simulating liquids, the dielectric properties are defined in KDB 865664 D01 Appendix A. The dielectric properties of the tissue simulating liquids were verified prior to the SAR evaluation using a dielectric assessment kit and a network analyzer.

Table-3.1 Targets of Tissue Simulating Liquid

Frequency (MHz)	Target Permittivity	Range of $\pm 5\%$	Target Conductivity	Range of $\pm 5\%$
For Head				
750	41.9	39.8 ~ 44.0	0.89	0.85 ~ 0.93
835	41.5	39.4 ~ 43.6	0.90	0.86 ~ 0.95
900	41.5	39.4 ~ 43.6	0.97	0.92 ~ 1.02
1450	40.5	38.5 ~ 42.5	1.20	1.14 ~ 1.26
1640	40.3	38.3 ~ 42.3	1.29	1.23 ~ 1.35
1750	40.1	38.1 ~ 42.1	1.37	1.30 ~ 1.44
1800	40.0	38.0 ~ 42.0	1.40	1.33 ~ 1.47
1900	40.0	38.0 ~ 42.0	1.40	1.33 ~ 1.47
2000	40.0	38.0 ~ 42.0	1.40	1.33 ~ 1.47
2300	39.5	37.5 ~ 41.5	1.67	1.59 ~ 1.75
2450	39.2	37.2 ~ 41.2	1.80	1.71 ~ 1.89
2600	39.0	37.1 ~ 41.0	1.96	1.86 ~ 2.06
3500	37.9	36.0 ~ 39.8	2.91	2.76 ~ 3.06
5200	36.0	34.2 ~ 37.8	4.66	4.43 ~ 4.89
5300	35.9	34.1 ~ 37.7	4.76	4.52 ~ 5.00
5500	35.6	33.8 ~ 37.4	4.96	4.71 ~ 5.21
5600	35.5	33.7 ~ 37.3	5.07	4.82 ~ 5.32
5800	35.3	33.5 ~ 37.1	5.27	5.01 ~ 5.53
For Body				
750	55.5	52.7 ~ 58.3	0.96	0.91 ~ 1.01
835	55.2	52.4 ~ 58.0	0.97	0.92 ~ 1.02
900	55.0	52.3 ~ 57.8	1.05	1.00 ~ 1.10
1450	54.0	51.3 ~ 56.7	1.30	1.24 ~ 1.37
1640	53.8	51.1 ~ 56.5	1.40	1.33 ~ 1.47
1750	53.4	50.7 ~ 56.1	1.49	1.42 ~ 1.56
1800	53.3	50.6 ~ 56.0	1.52	1.44 ~ 1.60
1900	53.3	50.6 ~ 56.0	1.52	1.44 ~ 1.60
2000	53.3	50.6 ~ 56.0	1.52	1.44 ~ 1.60
2300	52.9	50.3 ~ 55.5	1.81	1.72 ~ 1.90
2450	52.7	50.1 ~ 55.3	1.95	1.85 ~ 2.05
2600	52.5	49.9 ~ 55.1	2.16	2.05 ~ 2.27
3500	51.3	48.7 ~ 53.9	3.31	3.14 ~ 3.48
5200	49.0	46.6 ~ 51.5	5.30	5.04 ~ 5.57
5300	48.9	46.5 ~ 51.3	5.42	5.15 ~ 5.69
5500	48.6	46.2 ~ 51.0	5.65	5.37 ~ 5.93
5600	48.5	46.1 ~ 50.9	5.77	5.48 ~ 6.06
5800	48.2	45.8 ~ 50.6	6.00	5.70 ~ 6.30

FCC SAR Test Report

The following table gives the recipes for tissue simulating liquids.

Table-3.2 Recipes of Tissue Simulating Liquid

Tissue Type	Bactericide	DGBE	HEC	NaCl	Sucrose	Triton X-100	Water	Diethylene Glycol Mono-hexylether
H750	0.2	-	0.2	1.5	56.0	-	42.1	-
H835	0.2	-	0.2	1.5	57.0	-	41.1	-
H900	0.2	-	0.2	1.4	58.0	-	40.2	-
H1450	-	43.3	-	0.6	-	-	56.1	-
H1640	-	45.8	-	0.5	-	-	53.7	-
H1750	-	47.0	-	0.4	-	-	52.6	-
H1800	-	44.5	-	0.3	-	-	55.2	-
H1900	-	44.5	-	0.2	-	-	55.3	-
H2000	-	44.5	-	0.1	-	-	55.4	-
H2300	-	44.9	-	0.1	-	-	55.0	-
H2450	-	45.0	-	0.1	-	-	54.9	-
H2600	-	45.1	-	0.1	-	-	54.8	-
H3500	-	28.0	-	0.2	-	20.0	71.8	-
H5G	-	-	-	-	-	17.2	65.5	17.3
B750	0.2	-	0.2	0.8	48.8	-	50.0	-
B835	0.2	-	0.2	0.9	48.5	-	50.2	-
B900	0.2	-	0.2	0.9	48.2	-	50.5	-
B1450	-	34.0	-	0.3	-	-	65.7	-
B1640	-	32.5	-	0.3	-	-	67.2	-
B1750	-	31.0	-	0.2	-	-	68.8	-
B1800	-	29.5	-	0.4	-	-	70.1	-
B1900	-	29.5	-	0.3	-	-	70.2	-
B2000	-	30.0	-	0.2	-	-	69.8	-
B2300	-	31.0	-	0.1	-	-	68.9	-
B2450	-	31.4	-	0.1	-	-	68.5	-
B2600	-	31.8	-	0.1	-	-	68.1	-
B3500	-	28.8	-	0.1	-	-	71.1	-
B5G	-	-	-	-	-	10.7	78.6	10.7

3.3 SAR System Verification

The system check verifies that the system operates within its specifications. It is performed daily or before every SAR measurement. The system check uses normal SAR measurements in the flat section of the phantom with a matched dipole at a specified distance. The system verification setup is shown as below.

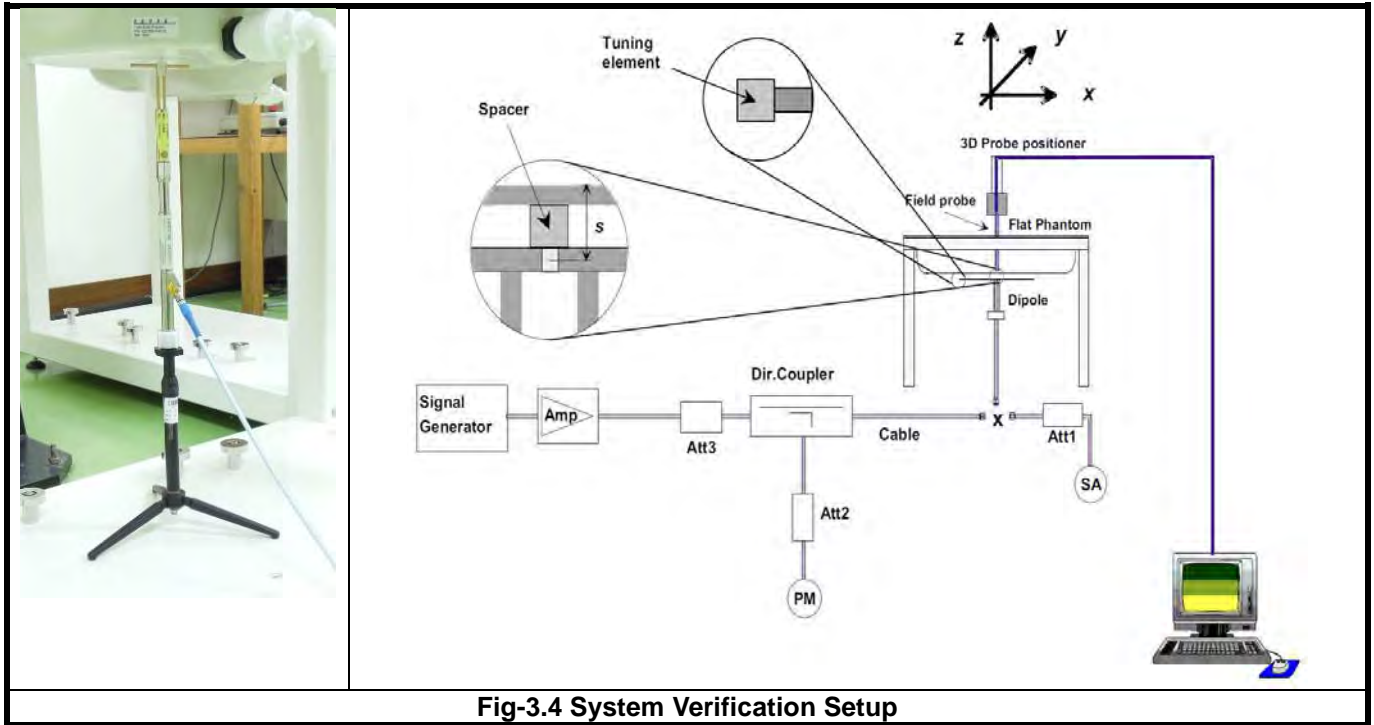

Fig-3.4 System Verification Setup

The validation dipole is placed beneath the flat phantom with the specific spacer in place. The distance spacer is touch the phantom surface with a light pressure at the reference marking and be oriented parallel to the long side of the phantom. The spectrum analyzer measures the forward power at the location of the system check dipole connector. The signal generator is adjusted for the desired forward power (250 mW is used for 700 MHz to 3 GHz, 100 mW is used for 3.5 GHz to 6 GHz) at the dipole connector and the power meter is read at that level. After connecting the cable to the dipole, the signal generator is readjusted for the same reading at power meter.

After system check testing, the SAR result will be normalized to 1W forward input power and compared with the reference SAR value derived from validation dipole certificate report. The deviation of system check should be within 10 %.

3.4 SAR Measurement Procedure

According to the SAR test standard, the recommended procedure for assessing the peak spatial-average SAR value consists of the following steps:

- (a) Power reference measurement
- (b) Area scan
- (c) Zoom scan
- (d) Power drift measurement

The SAR measurement procedures for each of test conditions are as follows:

- (a) Make EUT to transmit maximum output power
- (b) Measure conducted output power through RF cable
- (c) Place the EUT in the specific position of phantom
- (d) Perform SAR testing steps on the DASY system
- (e) Record the SAR value

3.4.1 Area & Zoom Scan Procedure

First Area Scan is used to locate the approximate location(s) of the local peak SAR value(s). The measurement grid within an Area Scan is defined by the grid extent, grid step size and grid offset. Next, in order to determine the EM field distribution in a three-dimensional spatial extension, Zoom Scan is required. The Zoom Scan is performed around the highest E-field value to determine the averaged SAR-distribution over 10 g. According to KDB 865664 D01, the resolution for Area and Zoom scan is specified in the table below.

Items	<= 2 GHz	2-3 GHz	3-4 GHz	4-5 GHz	5-6 GHz
Area Scan ($\Delta x, \Delta y$)	<= 15 mm	<= 12 mm	<= 12 mm	<= 10 mm	<= 10 mm
Zoom Scan ($\Delta x, \Delta y$)	<= 8 mm	<= 5 mm	<= 5 mm	<= 4 mm	<= 4 mm
Zoom Scan (Δz)	<= 5 mm	<= 5 mm	<= 4 mm	<= 3 mm	<= 2 mm
Zoom Scan Volume	>= 30 mm	>= 30 mm	>= 28 mm	>= 25 mm	>= 22 mm

Note:

When zoom scan is required and report SAR is <= 1.4 W/kg, the zoom scan resolution of $\Delta x / \Delta y$ (2-3GHz: <= 8 mm, 3-4GHz: <= 7 mm, 4-6GHz: <= 5 mm) may be applied.

3.4.2 Volume Scan Procedure

The volume scan is used for assess overlapping SAR distributions for antennas transmitting in different frequency bands. It is equivalent to an oversized zoom scan used in standalone measurements. The measurement volume will be used to enclose all the simultaneous transmitting antennas. For antennas transmitting simultaneously in different frequency bands, the volume scan is measured separately in each frequency band. In order to sum correctly to compute the 1g aggregate SAR, the EUT remain in the same test position for all measurements and all volume scan use the same spatial resolution and grid spacing. When all volume scan were completed, the software, SEMCAD postprocessor can combine and subsequently superpose these measurement data to calculating the multiband SAR.

3.4.3 Power Drift Monitoring

All SAR testing is under the EUT install full charged battery and transmit maximum output power. In DASY measurement software, the power reference measurement and power drift measurement procedures are used for monitoring the power drift of EUT during SAR test. Both these procedures measure the field at a specified reference position before and after the SAR testing. The software will calculate the field difference in dB. If the power drift more than 5%, the SAR will be retested.

3.4.4 Spatial Peak SAR Evaluation

The procedure for spatial peak SAR evaluation has been implemented according to the test standard. It can be conducted for 1g and 10g, as well as for user-specific masses. The DASY software includes all numerical procedures necessary to evaluate the spatial peak SAR value.

The base for the evaluation is a "cube" measurement. The measured volume must include the 1g and 10g cubes with the highest averaged SAR values. For that purpose, the center of the measured volume is aligned to the interpolated peak SAR value of a previously performed area scan.

The entire evaluation of the spatial peak values is performed within the post-processing engine (SEMCAD). The system always gives the maximum values for the 1g and 10g cubes. The algorithm to find the cube with highest averaged SAR is divided into the following stages:

- (a) Extraction of the measured data (grid and values) from the Zoom Scan
- (b) Calculation of the SAR value at every measurement point based on all stored data (A/D values and measurement parameters)
- (c) Generation of a high-resolution mesh within the measured volume
- (d) Interpolation of all measured values from the measurement grid to the high-resolution grid
- (e) Extrapolation of the entire 3-D field distribution to the phantom surface over the distance from sensor to surface
- (f) Calculation of the averaged SAR within masses of 1g and 10g

3.4.5 SAR Averaged Methods

In DASY, the interpolation and extrapolation are both based on the modified Quadratic Shepard's method. The interpolation scheme combines a least-square fitted function method and a weighted average method which are the two basic types of computational interpolation and approximation.

Extrapolation routines are used to obtain SAR values between the lowest measurement points and the inner phantom surface. The extrapolation distance is determined by the surface detection distance and the probe sensor offset. The uncertainty increases with the extrapolation distance. To keep the uncertainty within 1% for the 1 g and 10 g cubes, the extrapolation distance should not be larger than 5 mm.

4. SAR Measurement Evaluation

4.1 EUT Configuration and Setting

<Connections between EUT and System Simulator>

For WWAN SAR testing, the EUT was linked and controlled by base station emulator (Agilent E5515C is used for GSM/ CDMA, and Anritsu MT8820C is used for LTE). Communication between the EUT and the emulator was established by air link. The distance between the EUT and the communicating antenna of the emulator is larger than 50 cm and the output power radiated from the emulator antenna is at least 30 dB smaller than the output power of EUT. The EUT was set from the emulator to radiate maximum output power during SAR testing.

<Considerations Related to GSM / GPRS / EDGE for Setup and Testing>

The maximum multi-slot capability supported by this device is as below.

1. This EUT is class B device
2. This EUT supports GPRS multi-slot class 12 (max. uplink: 4, max. downlink: 4, total timeslots: 5)
3. This EUT supports EDGE multi-slot class 12 (max. uplink: 4, max. downlink: 4, total timeslots: 5)

For GSM850 frequency band, the power control level is set to 5 for GSM mode and GPRS (GMSK: CS1), and set to 8 for EDGE (GMSK: MCS1, 8PSK: MCS9). For GSM1900 frequency band, the power control level is set to 0 for GSM mode and GPRS (GMSK: CS1), and set to 2 for EDGE (GMSK: MCS1, 8PSK: MCS9).

SAR test reduction for GPRS and EDGE modes is determined by the source-based time-averaged output power specified for production units, including tune-up tolerance. The data mode with highest specified time-averaged output power should be tested for SAR compliance in the applicable exposure conditions. For modes with the same specified maximum output power and tolerance, the higher number time-slot configuration should be tested.

<Considerations Related to CDMA for Setup and Testing>

CDMA 1xRTT Handsets Head SAR

SAR for next to the ear head exposure is measured in RC3 with the handset configured to transmit at full rate in SO55. The 3G SAR test reduction procedure is applied to RC1 with RC3 as the primary mode. Otherwise, SAR is required for the channel with maximum measured output in RC1 using the head exposure configuration that results in the highest reported SAR in RC3.

CDMA 1xRTT Handsets Body-worn SAR

Body-worn SAR is measured in RC3 with the handset configured in TDSO/SO32 to transmit at full rate on FCH only with all other code channels disabled. The 3G SAR test reduction procedure is applied to the multiple code channel configuration (FCH + SCH_n), with FCH only as the primary mode. Otherwise, SAR is required for multiple code channel configuration (FCH + SCH_n), with FCH at full rate and SCH₀ enabled at 9600 bps, using the highest reported SAR configuration for FCH only. The 3G SAR test reduction procedure is applied to body-worn SAR in RC1 with RC3 as the primary mode. Otherwise, SAR is required for RC1, with SO55 and full rate, using the highest reported SAR configuration for body-worn exposure in RC3.

Handsets with built-in EV-DO

The 3G SAR test reduction procedure is applied to EV-DO Rev. 0 with 1xRTT RC3 as the primary mode to determine body-worn test requirements. Otherwise, body-worn SAR is required for Rev. 0, at 153.6 kbps, using the highest reported SAR configuration for body-worn exposure in RC3. The 3G SAR test reduction procedure is applied separately to Rev. A and Rev. B, with Rev. 0 as the primary mode to determine body-worn SAR test requirements. When SAR is not required for Rev. 0, the 3G SAR test reduction is applied with 1xRTT RC3 as the primary mode. Otherwise, SAR is required for Rev. A or Rev. B, with a Reverse Data Channel payload size of 4096 bits and a Termination Target of 16 slots defined for Subtype 2 and 3 Physical Layer configurations, using the highest reported SAR configuration for body-worn exposure in Rev. 0 or RC3, as appropriate. A Forward Traffic Channel data rate corresponding to the 2-slot version of 307.2 kbps with ACK Channel transmitting in all slots is configured in the downlink for Rev. 0, Rev. A and Rev. B.

EV-DO Data Devices

SAR is measured using the F/R TAP configurations required for Rev. 0, Rev. A and Rev. B. The AT is tested with a Reverse Data Channel rate of 153.6 kbps in Subtype 0/1 Physical Layer configurations. A Reverse Data Channel payload size of 4096 bits and Termination Target of 16 slots are used for Subtype 2 and 3. FTAP, FETAP and FMCTAP are all configured with a Forward Traffic Channel data rate corresponding to the 2-slot version of 307.2 kbps with ACK Channel transmitting in all slots. AT power control is in "All Bits Up" conditions for the TAP / ETAP / MCTAP. Body-worn and other body SAR are measured using Subtype 0/1 Physical Layer configurations for Rev. 0. The 3G SAR test reduction procedure is applied to Rev. A, Subtype 2 Physical layer configuration, with Rev. 0 as the primary mode. Otherwise, SAR is measured for Rev. A using the highest reported SAR configuration for body-worn exposure in Rev. 0. SAR is required for Rev. B, Subtype 3; it is measured by applying both the "test 2" and "test 3" configurations used for power measurement.

EV-DO Data Devices Support 1xRTT

The 3G SAR test reduction procedure is applied to 1xRTT RC3 and RC1 with EV-DO Rev. 0, Rev. A and Rev. B as the respective primary modes. Otherwise, the "CDMA 1xRTT Handsets Body-worn SAR" procedures are applied.

1x-Advanced SAR Guidance

The 3G SAR test reduction procedure is applied to 1x-Advanced with 1xRTT RC3 as the primary mode. When SAR measurement is required, the 1x-Advanced power measurement configurations are used. The 1x Advanced SAR procedures are applied separately to head, body-worn and other exposure conditions.

FCC SAR Test Report

<Considerations Related to LTE for Setup and Testing>

This device contains LTE transmitter which follows 3GPP standards, is category 3, supports both QPSK and 16QAM modulations, and supported LTE band and channel bandwidth is listed in below. The output power was tested per 3GPP TS 36.521-1 maximum transmit procedures for both QPSK and 16QAM modulation. The results please refer to section 4.6 of this report.

EUT Supported LTE Band and Channel Bandwidth						
LTE Band	BW 1.4 MHz	BW 3 MHz	BW 5 MHz	BW 10 MHz	BW 15 MHz	BW 20 MHz
2	V	V	V	V	V	V
4	V	V	V	V	V	V
5	V	V	V	V		
12	V	V	V	V		
13			V	V		
25	V	V	V	V	V	V
26	V	V	V	V	V	
41			V	V	V	V

The LTE maximum power reduction (MPR) in accordance with 3GPP TS 36.101 is active all times during LTE operation. The allowed MPR for the maximum output power is specified in below.

Modulation	Channel Bandwidth / RB Configurations						LTE MPR Setting (dB)
	BW 1.4 MHz	BW 3 MHz	BW 5 MHz	BW 10 MHz	BW 15 MHz	BW 20 MHz	
QPSK	> 5	> 4	> 8	> 12	> 16	> 18	1
16QAM	<= 5	<= 4	<= 8	<= 12	<= 16	<= 18	1
16QAM	> 5	> 4	> 8	> 12	> 16	> 18	2

Note: MPR is according to the standard and implemented in the circuit (mandatory).

In addition, the device is compliant with additional maximum power reduction (A-MPR) requirements defined in 3GPP TS 36.101 section 6.2.4 that was disabled for all FCC compliance testing.

During LTE SAR testing, the related parameters of operating band, channel bandwidth, uplink channel number, modulation type, and RB was set in base station simulator. When the EUT has registered and communicated to base station simulator, the simulator set to make EUT transmitting the maximum radiated power.

TDD-LTE Setup Configurations

According to KDB 941225 D05, SAR testing for TDD-LTE device must be tested using a fixed periodic duty factor according to the highest transmission duty factor implemented for the device and supported by the defined 3GPP TDD-LTE configurations. The TDD-LTE of this device supports frame structure type 2 defined in 3GPP TS 36.211 section 4.2, and the frame structure configuration can be referred to below.

FCC SAR Test Report

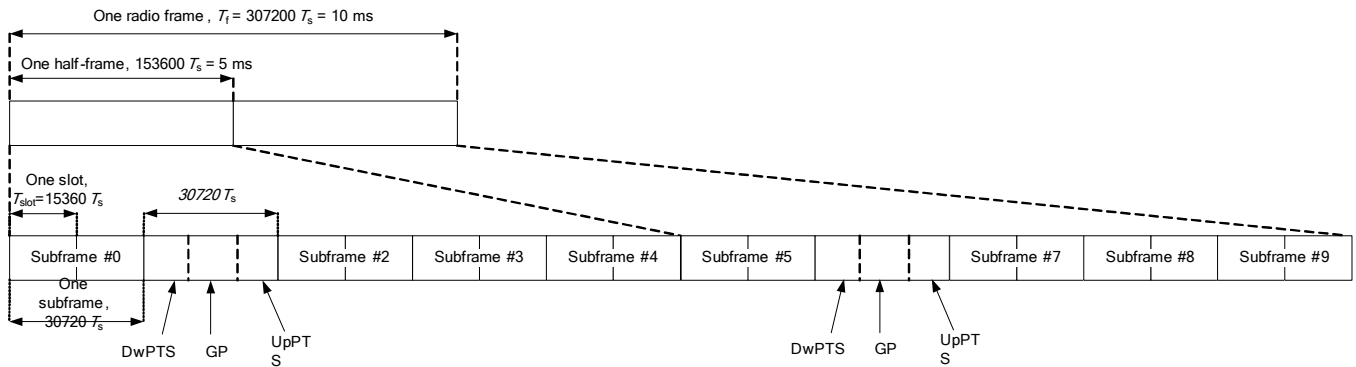

3GPP TS 36.211 Figure 4.2-1: Frame Structure Type 2

Special Subframe Configuration	Normal Cyclic Prefix in Downlink			Extended Cyclic Prefix in Downlink		
	DwPTS	UpPTS		DwPTS	UpPTS	
		Normal Cyclic Prefix in Uplink	Extended Cyclic Prefix in Uplink		Normal Cyclic Prefix in Uplink	Extended Cyclic Prefix in Uplink
0	6592 · Ts	2192 · Ts	2560 · Ts	7680 · Ts	2192 · Ts	2560 · Ts
1	19760 · Ts			20480 · Ts		
2	21952 · Ts			23040 · Ts		
3	24144 · Ts			25600 · Ts		
4	26336 · Ts			7680 · Ts		
5	6592 · Ts	4384 · Ts	5120 · Ts	20480 · Ts	4384 · Ts	5120 · Ts
6	19760 · Ts			23040 · Ts		
7	21952 · Ts			12800 · Ts		
8	24144 · Ts			-		
9	13168 · Ts	-	-	-	-	-

3GPP TS 36.211 Table 4.2-1: Configuration of Special Subframe

Uplink-Downlink Configuration	Downlink-to-Uplink Switch-Point Periodicity	Subframe Number										
		0	1	2	3	4	5	6	7	8	9	
0	5 ms	D	S	U	U	U	D	S	U	U	U	
1	5 ms	D	S	U	U	D	D	S	U	U	D	
2	5 ms	D	S	U	D	D	D	S	U	D	D	
3	10 ms	D	S	U	U	U	D	D	D	D	D	
4	10 ms	D	S	U	U	D	D	D	D	D	D	
5	10 ms	D	S	U	D	D	D	D	D	D	D	
6	5 ms	D	S	U	U	U	D	S	U	U	D	

3GPP TS 36.211 Table 4.2-2: Uplink-Downlink Configurations

The variety of different TD-LTE uplink-downlink configurations allows a network operator to allocate the network's capacity between uplink and downlink traffic to meet the needs of the network. The uplink duty cycle of these seven configurations can readily be computed and shown in below.

UL-DL Configuration	0	1	2	3	4	5	6
Highest Duty-Cycle	63.33%	43.33%	23.33%	31.67%	21.67%	11.67%	53.33%

<Considerations Related to WLAN for Setup and Testing>

In general, various vendor specific external test software and chipset based internal test modes are typically used for SAR measurement. These chipset based test mode utilities are generally hardware and manufacturer dependent, and often include substantial flexibility to reconfigure or reprogram a device. A Wi-Fi device must be configured to

FCC SAR Test Report

transmit continuously at the required data rate, channel bandwidth and signal modulation, using the highest transmission duty factor supported by the test mode tools for SAR measurement. The test frequencies established using test mode must correspond to the actual channel frequencies. When 802.11 frame gaps are accounted for in the transmission, a maximum transmission duty factor of 92 - 96% is typically achievable in most test mode configurations. A minimum transmission duty factor of 85% is required to avoid certain hardware and device implementation issues related to wide range SAR scaling. In addition, a periodic transmission duty factor is required for current generation SAR systems to measure SAR correctly. The reported SAR must be scaled to 100% transmission duty factor to determine compliance at the maximum tune-up tolerance limit.

According to KDB 248227 D01, this device has installed WLAN engineering testing software which can provide continuous transmitting RF signal. During WLAN SAR testing, this device was operated to transmit continuously at the maximum transmission duty with specified transmission mode, operating frequency, lowest data rate, and maximum output power.

Initial Test Configuration

An initial test configuration is determined for OFDM transmission modes in 2.4 GHz and 5 GHz bands according to the channel bandwidth, modulation and data rate combination(s) with the highest maximum output power specified for production units in each standalone and aggregated frequency band. When the same maximum power is specified for multiple transmission modes in a frequency band, the largest channel bandwidth, lowest order modulation, lowest data rate and lowest order 802.11a/g/n/ac mode is used for SAR measurement, on the highest measured output power channel in the initial test configuration, for each frequency band.

Subsequent Test Configuration

SAR measurement requirements for the remaining 802.11 transmission mode configurations that have not been tested in the initial test configuration are determined separately for each standalone and aggregated frequency band, in each exposure condition, according to the maximum output power specified for production units. Additional power measurements may be required to determine if SAR measurements are required for subsequent highest output power channels in a subsequent test configuration. When the highest reported SAR for the initial test configuration according to the initial test position or fixed exposure position requirements, is adjusted by the ratio of the subsequent test configuration to initial test configuration specified maximum output power and the adjusted SAR is ≤ 1.2 W/kg, SAR is not required for that subsequent test configuration.

SAR Test Configuration and Channel Selection

When multiple channel bandwidth configurations in a frequency band have the same specified maximum output power, the initial test configuration is using largest channel bandwidth, lowest order modulation, lowest data rate, and lowest order 802.11 mode (i.e., 802.11a is chosen over 802.11n then 802.11ac or 802.11g is chosen over 802.11n). After an initial test configuration is determined, if multiple test channels have the same measured maximum output power, the channel chosen for SAR measurement is determined according to the following.

- 1) The channel closest to mid-band frequency is selected for SAR measurement.
- 2) For channels with equal separation from mid-band frequency; for example, high and low channels or two mid-band channels, the higher frequency (number) channel is selected for SAR measurement.

4.2 EUT Testing Position

According to KDB 648474 D04, handsets are tested for SAR compliance in head, body-worn accessory and other use configurations described in the following subsections.

4.2.1 Head Exposure Conditions

Head exposure is limited to next to the ear voice mode operations. Head SAR compliance is tested according to the test positions defined in IEEE Std 1528-2013 using the SAM phantom illustrated as below.

1. Define two imaginary lines on the handset
 - (a) The vertical centerline passes through two points on the front side of the handset - the midpoint of the width w_t of the handset at the level of the acoustic output, and the midpoint of the width w_b of the bottom of the handset.
 - (b) The horizontal line is perpendicular to the vertical centerline and passes through the center of the acoustic output. The horizontal line is also tangential to the face of the handset at point A.
 - (c) The two lines intersect at point A. Note that for many handsets, point A coincides with the center of the acoustic output; however, the acoustic output may be located elsewhere on the horizontal line. Also note that the vertical centerline is not necessarily parallel to the front face of the handset, especially for clamshell handsets, handsets with flip covers, and other irregularly shaped handsets.

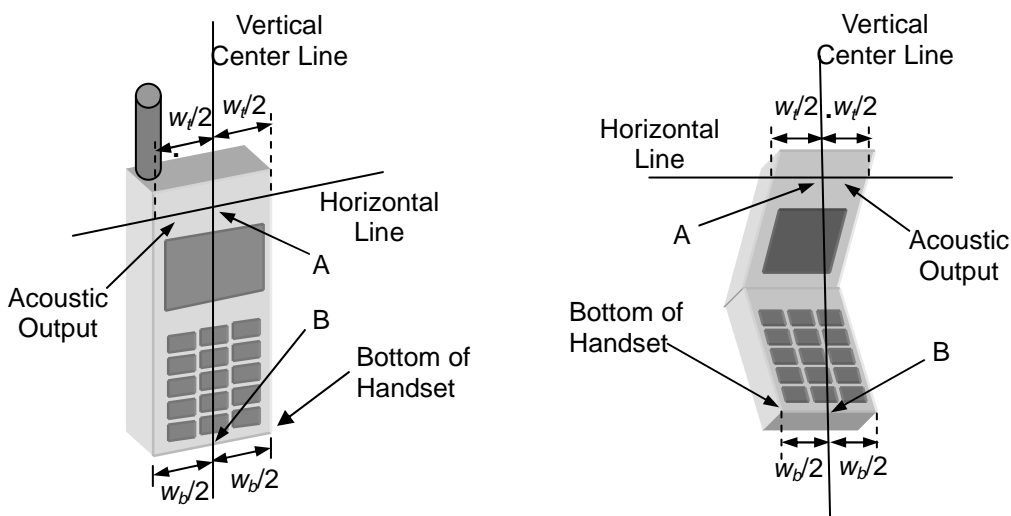

Fig-4.1 Illustration for Handset Vertical and Horizontal Reference Lines

2. Cheek Position

- (a) To position the device with the vertical center line of the body of the device and the horizontal line crossing the center piece in a plane parallel to the sagittal plane of the phantom. While maintaining the device in this plane, align the vertical center line with the reference plane containing the three ear and mouth reference point (M: Mouth, RE: Right Ear, and LE: Left Ear) and align the center of the ear piece with the line RE-LE.
- (b) To move the device towards the phantom with the ear piece aligned with the line LE-RE until the phone touched the ear. While maintaining the device in the reference plane and maintaining the phone contact with the ear,

move the bottom of the phone until any point on the front side is in contact with the cheek of the phantom or until contact with the ear is lost (see Fig-4.2).

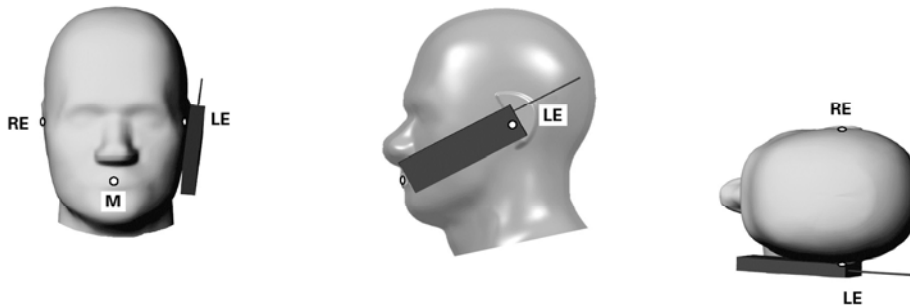

Fig-4.2 Illustration for Cheek Position

3. Tilted Position

- (a) To position the device in the “cheek” position described above.
- (b) While maintaining the device the reference plane described above and pivoting against the ear, moves it outward away from the mouth by an angle of 15 degrees or until contact with the ear is lost (see Fig-4.3).

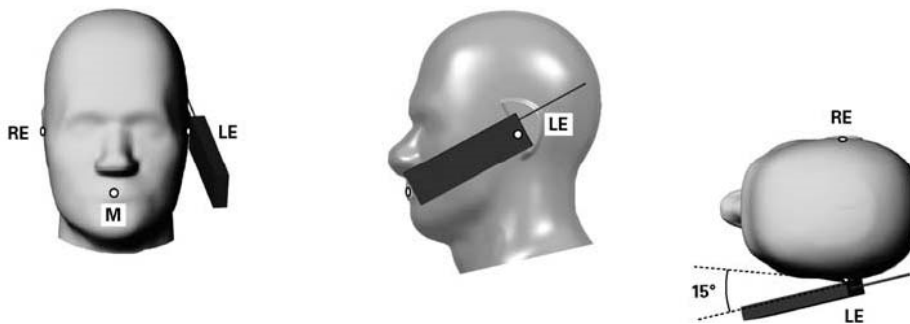

Fig-4.3 Illustration for Tilted Position

4.2.2 Body-worn Accessory Exposure Conditions

Body-worn accessory exposure is typically related to voice mode operations when handsets are carried in body-worn accessories. The body-worn accessory procedures in KDB 447498 D01 are used to test for body-worn accessory SAR compliance, without a headset connected to it. This enables the test results for such configuration to be compatible with that required for hotspot mode when the body-worn accessory test separation distance is greater than or equal to that required for hotspot mode. When the reported SAR for a body-worn accessory, measured without a headset connected to the handset, is > 1.2 W/kg, the highest reported SAR configuration for that wireless mode and frequency band should be repeated for that body-worn accessory with a headset attached to the handset.

Body-worn accessories that do not contain metallic or conductive components may be tested according to worst-case exposure configurations, typically according to the smallest test separation distance required for the group of body-worn accessories with similar operating and exposure characteristics. All body-worn accessories containing metallic components are tested in conjunction with the host device.

Body-worn accessory SAR compliance is based on a single minimum test separation distance for all wireless and operating modes applicable to each body-worn accessory used by the host, and according to the relevant voice and/or data mode transmissions and operations. If a body-worn accessory supports voice only operations in its normal and expected use conditions, testing of data mode for body-worn compliance is not required.

A conservative minimum test separation distance for supporting off-the-shelf body-worn accessories that may be acquired by users of consumer handsets is used to test for body-worn accessory SAR compliance. This distance is determined by the handset manufacturer, according to the requirements of Supplement C 01-01. Devices that are designed to operate on the body of users using lanyards and straps, or without requiring additional body-worn accessories, will be tested using a conservative minimum test separation distance ≤ 5 mm to support compliance.

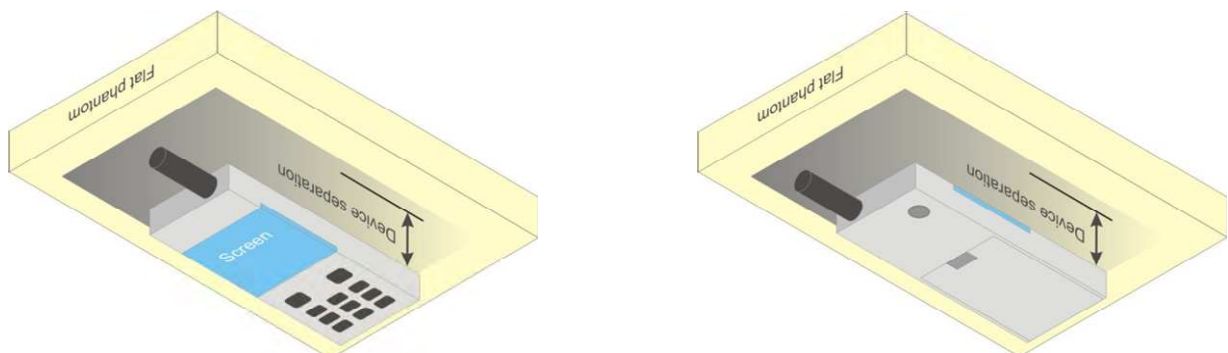
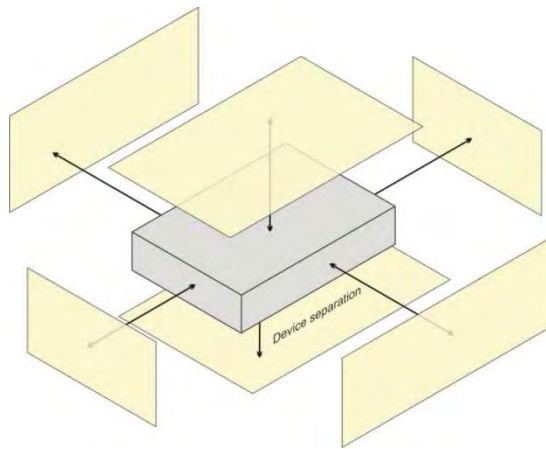

Fig-4.4 Illustration for Body Worn Position

4.2.3 Hotspot Mode Exposure Conditions

For handsets that support hotspot mode operations, with wireless router capabilities and various web browsing functions, the relevant hand and body exposure conditions are tested according to the hotspot SAR procedures in KDB 941225 D06. A test separation distance of 10 mm is required between the phantom and all surfaces and edges with a transmitting antenna located within 25 mm from that surface or edge. When the form factor of a handset is smaller than 9 cm x 5 cm, a test separation distance of 5 mm (instead of 10 mm) is required for testing hotspot mode. When the separation distance required for body-worn accessory testing is larger than or equal to that tested for hotspot mode, in the same wireless mode and for the same surface of the phone, the hotspot mode SAR data may be used to support body-worn accessory SAR compliance for that particular configuration (surface).



Based on the antenna location shown on appendix D of this report, the SAR testing required for hotspot mode is listed as below.

Antenna	Front Face	Rear Face	Left Side	Right Side	Top Side	Bottom Side
WWAN Ant	√	√	√	√	√	√
WLAN / BT	√	√	√	√	√	√

4.2.4 SAR Test Exclusion Evaluations

According to KDB 447498 D01, the SAR test exclusion condition is based on source-based time-averaged maximum conducted output power, adjusted for tune-up tolerance, and the minimum test separation distance required for the exposure conditions. The SAR exclusion threshold is determined by the following formula.

$$\frac{\text{Max. Tune up Power}_{(mW)}}{\text{Min. Test Separation Distance}_{(mm)}} \times \sqrt{f_{(GHz)}} \leq 3.0 \text{ for SAR-1g, } \leq 7.5 \text{ for SAR-10g}$$

When the minimum test separation distance is < 5 mm, a distance of 5 mm is applied to determine SAR test exclusion.

Mode	Max. Tune-up Power (dBm)	Max. Tune-up Power (mW)	Body-worn		
			Ant. to Surface (mm)	Calculated Result	Require SAR Testing?
BT (2.48 GHz)	1.0	1.26	15	0.1	No

Note:

1. When separation distance <= 50 mm and the calculated result shown in above table is <= 3.0 for SAR-1g exposure condition, or <= 7.5 for SAR-10g exposure condition, the SAR testing exclusion is applied.

4.2.5 Simultaneous Transmission Possibilities

The simultaneous transmission possibilities for this device are listed as below.

Simultaneous TX Combination	Capable Transmit Configurations	Head (Voice / VoIP)	Body-worn (Voice / VoIP)	Hotspot (Data)
1	GSM850 (Voice / Data) + WLAN (Data)	Yes	Yes	Yes
2	GSM1900 (Voice / Data) + WLAN (Data)	Yes	Yes	Yes
3	CDMA BC0 (Voice / Data) + WLAN (Data)	Yes	Yes	Yes
4	CDMA BC1 (Voice / Data) + WLAN (Data)	Yes	Yes	Yes
5	CDMA BC10 (Voice / Data) + WLAN (Data)	Yes	Yes	Yes
6	LTE 2 (Data) + WLAN (Data)	Yes	Yes	Yes
7	LTE 4 (Data) + WLAN (Data)	Yes	Yes	Yes
8	LTE 5 (Data) + WLAN (Data)	Yes	Yes	Yes
9	LTE 12 (Data) + WLAN (Data)	Yes	Yes	Yes
10	LTE 13 (Data) + WLAN (Data)	Yes	Yes	Yes
11	LTE 25 (Data) + WLAN (Data)	Yes	Yes	Yes
12	LTE 26 (Data) + WLAN (Data)	Yes	Yes	Yes
13	LTE 41 (Data) + WLAN (Data)	Yes	Yes	Yes
14	GSM850 (Voice / Data) + BT (Data)	No	Yes	No
15	GSM1900 (Voice / Data) + BT (Data)	No	Yes	No
16	CDMA BC0 (Voice / Data) + BT (Data)	No	Yes	No
17	CDMA BC1 (Voice / Data) + BT (Data)	No	Yes	No
18	CDMA BC10 (Voice / Data) + BT (Data)	No	Yes	No
19	LTE 2 (Data) + BT (Data)	No	Yes	No
20	LTE 4 (Data) + BT (Data)	No	Yes	No
21	LTE 5 (Data) + BT (Data)	No	Yes	No
22	LTE 12 (Data) + BT (Data)	No	Yes	No
23	LTE 13 (Data) + BT (Data)	No	Yes	No
24	LTE 25 (Data) + BT (Data)	No	Yes	No
25	LTE 26 (Data) + BT (Data)	No	Yes	No
26	LTE 41 (Data) + BT (Data)	No	Yes	No

Note :

1. The WLAN and Bluetooth cannot transmit simultaneously, so there is no co-location test requirement for WLAN and Bluetooth.
2. The WWAN transmitter can only use either CDMA or LTE at a time.

FCC SAR Test Report

4.3 Tissue Verification

The measuring results for tissue simulating liquid are shown as below.

Test Date	Tissue Type	Frequency (MHz)	Liquid Temp. (°C)	Measured Conductivity (σ)	Measured Permittivity (ϵ_r)	Target Conductivity (σ)	Target Permittivity (ϵ_r)	Conductivity Deviation (%)	Permittivity Deviation (%)
Nov. 09, 2018	H750	750	22.1	0.892	41.077	0.89	41.90	0.22	-1.96
Nov. 10, 2018	H835	835	21.9	0.906	41.947	0.90	41.50	0.67	1.08
Nov. 08, 2018	H1750	1750	22.2	1.325	40.765	1.37	40.10	-3.28	1.66
Nov. 11, 2018	H1900	1900	21.8	1.374	39.600	1.40	40.00	-1.86	-1.00
Nov. 12, 2018	H2450	2450	21.8	1.843	38.147	1.80	39.20	2.39	-2.69
Nov. 14, 2018	H2600	2600	22.1	2.003	37.538	1.96	39.00	2.19	-3.75
Nov. 02, 2018	B750	750	21.8	0.966	55.257	0.96	55.50	0.63	-0.44
Nov. 15, 2018	B750	750	21.9	0.965	55.172	0.96	55.50	0.52	-0.59
Nov. 03, 2018	B835	835	22.1	0.978	55.642	0.97	55.20	0.82	0.80
Nov. 16, 2018	B835	835	22.1	0.992	55.615	0.97	55.20	2.27	0.75
Nov. 04, 2018	B1750	1750	21.9	1.461	54.188	1.49	53.40	-1.95	1.48
Nov. 13, 2018	B1750	1750	21.8	1.439	53.695	1.49	53.40	-3.42	0.55
Nov. 05, 2018	B1900	1900	22.1	1.577	53.606	1.52	53.30	3.75	0.57
Nov. 17, 2018	B1900	1900	22.2	1.584	53.066	1.52	53.30	4.21	-0.44
Nov. 06, 2018	B2450	2450	21.7	1.949	51.779	1.95	52.70	-0.05	-1.75
Nov. 07, 2018	B2600	2600	21.9	2.096	50.743	2.16	52.50	-2.96	-3.35

Note:

The dielectric properties of the tissue simulating liquid must be measured within 24 hours before the SAR testing and within $\pm 5\%$ of the target values. Liquid temperature during the SAR testing must be within ± 2 °C.

4.4 System Validation

The SAR measurement system was validated according to procedures in KDB 865664 D01. The validation status in tabulated summary is as below.

Test Date	Probe S/N	Calibration Point	Measured Conductivity (σ)	Measured Permittivity (ϵ_r)	Validation for CW			Validation for Modulation			
					Sensitivity Range	Probe Linearity	Probe Isotropy	Modulation Type	Duty Factor	PAR	
Nov. 09, 2018	3873	Head	750	0.892	41.077	Pass	Pass	Pass	N/A	N/A	N/A
Nov. 10, 2018	3873	Head	835	0.906	41.947	Pass	Pass	Pass	GMSK	Pass	N/A
Nov. 08, 2018	3873	Head	1750	1.325	40.765	Pass	Pass	Pass	N/A	N/A	N/A
Nov. 11, 2018	3873	Head	1900	1.374	39.600	Pass	Pass	Pass	GMSK	Pass	N/A
Nov. 12, 2018	3873	Head	2450	1.843	38.147	Pass	Pass	Pass	OFDM	N/A	Pass
Nov. 14, 2018	3873	Head	2600	2.003	37.538	Pass	Pass	Pass	N/A	N/A	N/A
Nov. 02, 2018	3873	Body	750	0.966	55.257	Pass	Pass	Pass	N/A	N/A	N/A
Nov. 15, 2018	3873	Body	750	0.965	55.172	Pass	Pass	Pass	N/A	N/A	N/A
Nov. 03, 2018	3873	Body	835	0.978	55.642	Pass	Pass	Pass	GMSK	Pass	N/A
Nov. 16, 2018	3873	Body	835	0.992	55.615	Pass	Pass	Pass	GMSK	Pass	N/A
Nov. 04, 2018	3873	Body	1750	1.461	54.188	Pass	Pass	Pass	N/A	N/A	N/A
Nov. 13, 2018	3873	Body	1750	1.439	53.695	Pass	Pass	Pass	N/A	N/A	N/A
Nov. 05, 2018	3873	Body	1900	1.577	53.606	Pass	Pass	Pass	GMSK	Pass	N/A
Nov. 17, 2018	3873	Body	1900	1.584	53.066	Pass	Pass	Pass	GMSK	Pass	N/A
Nov. 06, 2018	3873	Body	2450	1.949	51.779	Pass	Pass	Pass	OFDM	N/A	Pass
Nov. 07, 2018	3873	Body	2600	2.096	50.743	Pass	Pass	Pass	N/A	N/A	N/A

4.5 System Verification

The measuring result for system verification is tabulated as below.

Test Date	Mode	Frequency (MHz)	1W Target SAR-1g (W/kg)	Measured SAR-1g (W/kg)	Normalized to 1W SAR-1g (W/kg)	Deviation (%)	Dipole S/N	Probe S/N	DAE S/N
Nov. 09, 2018	Head	750	8.51	2.13	8.52	0.12	1067	3873	1341
Nov. 10, 2018	Head	835	9.51	2.44	9.76	2.63	4d139	3873	1341
Nov. 08, 2018	Head	1750	36.80	9.61	38.44	4.46	1071	3873	1341
Nov. 11, 2018	Head	1900	39.80	10.50	42.00	5.53	5d159	3873	1341
Nov. 12, 2018	Head	2450	53.10	14.10	56.40	6.21	893	3873	1341
Nov. 14, 2018	Head	2600	56.00	14.00	56.00	0.00	1110	3873	1341
Nov. 02, 2018	Body	750	8.80	2.12	8.48	-3.64	1067	3873	1341
Nov. 15, 2018	Body	750	8.80	2.37	9.48	7.73	1067	3873	1341
Nov. 03, 2018	Body	835	9.70	2.38	9.52	-1.86	4d139	3873	1341
Nov. 16, 2018	Body	835	9.70	2.31	9.24	-4.74	4d139	3873	1341
Nov. 04, 2018	Body	1750	38.00	9.68	38.72	1.89	1071	3873	1341
Nov. 13, 2018	Body	1750	38.00	9.65	38.60	1.58	1071	3873	1341
Nov. 05, 2018	Body	1900	40.20	10.60	42.40	5.47	5d159	3873	1341
Nov. 17, 2018	Body	1900	40.20	10.50	42.00	4.48	5d159	3873	1341
Nov. 06, 2018	Body	2450	51.50	13.00	52.00	0.97	893	3873	1341
Nov. 07, 2018	Body	2600	54.50	14.20	56.80	4.22	1110	3873	1341

Note:

Comparing to the reference SAR value provided by SPEAG, the validation data should be within its specification of 10 %. The result indicates the system check can meet the variation criterion and the plots can be referred to Appendix A of this report.

4.6 Maximum Output Power

4.6.1 Maximum Conducted Power

The maximum conducted average power (Unit: dBm) including tune-up tolerance is shown as below.

Mode	GSM1900
GSM (GMSK, 1Tx-slot)	30.0
GPRS (GMSK, 1Tx-slot)	30.0
GPRS (GMSK, 2Tx-slot)	26.5
GPRS (GMSK, 3Tx-slot)	25.5
GPRS (GMSK, 4Tx-slot)	24.5
EDGE (8PSK, 1Tx-slot)	25.5
EDGE (8PSK, 2Tx-slot)	24.0
EDGE (8PSK, 3Tx-slot)	22.0
EDGE (8PSK, 4Tx-slot)	20.5

Mode	GSM850 (without Power Reduction)	GSM850 (with Power Reduction)	Power Reduction (dB)
GSM (GMSK, 1Tx-slot)	33.5	29.0	4.5
GPRS (GMSK, 1Tx-slot)	33.5	29.0	4.5
GPRS (GMSK, 2Tx-slot)	31.0	27.0	4.0
GPRS (GMSK, 3Tx-slot)	29.0	25.5	3.5
GPRS (GMSK, 4Tx-slot)	28.5	25.5	3.0
EDGE (8PSK, 1Tx-slot)	26.5	23.0	3.5
EDGE (8PSK, 2Tx-slot)	25.5	21.0	4.0
EDGE (8PSK, 3Tx-slot)	22.5	20.5	2.0
EDGE (8PSK, 4Tx-slot)	22.0	20.0	2.0

Mode	CDMA BC0 (without Power Reduction)	CDMA BC0 (with Power Reduction)	Power Reduction (dB)
1xRTT	23.5	22.5	1.0
1xEVDO Rev.0	23.5	22.5	1.0
1xEVDO Rev.A	23.5	22.5	1.0

Mode	CDMA BC1 (without Power Reduction)	CDMA BC1 (with Power Reduction)	Power Reduction (dB)
1xRTT	24.0	22.5	1.5
1xEVDO Rev.0	24.0	22.5	1.5
1xEVDO Rev.A	24.0	22.5	1.5

Mode	CDMA BC10 (without Power Reduction)	CDMA BC10 (with Power Reduction)	Power Reduction (dB)
1xRTT	23.5	22.5	1.0
1xEVDO Rev.0	23.5	22.5	1.0
1xEVDO Rev.A	23.5	22.5	1.0

FCC SAR Test Report

Mode	LTE 2 (without Power Reduction)	LTE 2 (with Power Reduction)	Power Reduction (dB)
QPSK / 16QAM	23.5 / 22.5	22.5 / 22.5	1.0 / 0

Mode	LTE 4 (without Power Reduction)	LTE 4 (with Power Reduction)	Power Reduction (dB)
QPSK / 16QAM	24.0 / 23.0	23.0 / 23.0	1.0 / 0

Mode	LTE 25 (without Power Reduction)	LTE 25 (with Power Reduction)	Power Reduction (dB)
QPSK / 16QAM	23.5 / 22.5	22.5 / 22.5	1.0 / 0

Mode	LTE 5	LTE 12	LTE 13
QPSK / 16QAM	24.0 / 23.0	24.0 / 23.0	24.0 / 23.0

Mode	LTE 26	LTE 41
QPSK / 16QAM	24.0 / 23.0	24.5 / 23.5

Mode	2.4G WLAN
802.11b	18.5
802.11g	16.5
802.11n HT20	13.0

Mode	2.4G Bluetooth
GFSK	1.0
$\pi/4$ -DQPSK	-0.5
8DPSK	-0.5
LE	-5.0

FCC SAR Test Report

4.6.2 Measured Conducted Power Result

The measuring conducted average power (Unit: dBm) is shown as below.

Band Channel Frequency (MHz)	GSM850		
	128	189	251
	824.2	836.4	848.8
EUT without Power Reduction			
Maximum Burst-Averaged Output Power			
GSM (GMSK, 1Tx-slot)	32.93	33.15	33.28
GPRS (GMSK, 1Tx-slot)	32.92	33.14	33.27
GPRS (GMSK, 2Tx-slot)	30.10	30.32	30.45
GPRS (GMSK, 3Tx-slot)	27.95	28.17	28.30
GPRS (GMSK, 4Tx-slot)	27.72	27.94	28.07
EDGE (8PSK, 1Tx-slot)	25.90	26.12	26.25
EDGE (8PSK, 2Tx-slot)	24.56	24.78	24.91
EDGE (8PSK, 3Tx-slot)	21.71	21.93	22.06
EDGE (8PSK, 4Tx-slot)	21.31	21.53	21.66
Maximum Frame-Averaged Output Power			
GSM (GMSK, 1Tx-slot)	23.93	24.15	24.28
GPRS (GMSK, 1Tx-slot)	23.92	24.14	24.27
GPRS (GMSK, 2Tx-slot)	24.10	24.32	24.45
GPRS (GMSK, 3Tx-slot)	23.69	23.91	24.04
GPRS (GMSK, 4Tx-slot)	24.72	24.94	25.07
EDGE (8PSK, 1Tx-slot)	16.90	17.12	17.25
EDGE (8PSK, 2Tx-slot)	18.56	18.78	18.91
EDGE (8PSK, 3Tx-slot)	17.45	17.67	17.80
EDGE (8PSK, 4Tx-slot)	18.31	18.53	18.66
EUT with Power Reduction			
Maximum Burst-Averaged Output Power			
GSM (GMSK, 1Tx-slot)	27.95	28.42	28.60
GPRS (GMSK, 1Tx-slot)	27.94	28.41	28.59
GPRS (GMSK, 2Tx-slot)	25.81	26.28	26.46
GPRS (GMSK, 3Tx-slot)	24.57	25.04	25.22
GPRS (GMSK, 4Tx-slot)	24.44	24.91	25.09
EDGE (8PSK, 1Tx-slot)	22.07	22.54	22.72
EDGE (8PSK, 2Tx-slot)	19.74	20.21	20.39
EDGE (8PSK, 3Tx-slot)	19.46	19.93	20.11
EDGE (8PSK, 4Tx-slot)	19.17	19.64	19.82
Maximum Frame-Averaged Output Power			
GSM (GMSK, 1Tx-slot)	18.95	19.42	19.60
GPRS (GMSK, 1Tx-slot)	18.94	19.41	19.59
GPRS (GMSK, 2Tx-slot)	19.81	20.28	20.46
GPRS (GMSK, 3Tx-slot)	20.31	20.78	20.96
GPRS (GMSK, 4Tx-slot)	21.44	21.91	22.09
EDGE (8PSK, 1Tx-slot)	13.07	13.54	13.72
EDGE (8PSK, 2Tx-slot)	13.74	14.21	14.39
EDGE (8PSK, 3Tx-slot)	15.20	15.67	15.85
EDGE (8PSK, 4Tx-slot)	16.17	16.64	16.82

Band	GSM1900		
	Channel	661	810
Frequency (MHz)	1850.2	1880.0	1909.8
Maximum Burst-Averaged Output Power			
GSM (GMSK, 1Tx-slot)	29.32	29.48	29.57
GPRS (GMSK, 1Tx-slot)	29.09	29.25	29.34
GPRS (GMSK, 2Tx-slot)	26.11	26.27	26.36
GPRS (GMSK, 3Tx-slot)	24.92	25.08	25.17
GPRS (GMSK, 4Tx-slot)	23.65	23.81	23.90
EDGE (8PSK, 1Tx-slot)	24.79	24.95	25.04
EDGE (8PSK, 2Tx-slot)	23.50	23.66	23.75
EDGE (8PSK, 3Tx-slot)	20.25	20.41	20.50
EDGE (8PSK, 4Tx-slot)	20.07	20.23	20.32
Maximum Frame-Averaged Output Power			
GSM (GMSK, 1Tx-slot)	20.32	20.48	20.57
GPRS (GMSK, 1Tx-slot)	20.09	20.25	20.34
GPRS (GMSK, 2Tx-slot)	20.11	20.27	20.36
GPRS (GMSK, 3Tx-slot)	20.66	20.82	20.91
GPRS (GMSK, 4Tx-slot)	20.65	20.81	20.90
EDGE (8PSK, 1Tx-slot)	15.79	15.95	16.04
EDGE (8PSK, 2Tx-slot)	17.50	17.66	17.75
EDGE (8PSK, 3Tx-slot)	15.99	16.15	16.24
EDGE (8PSK, 4Tx-slot)	17.07	17.23	17.32

Note:

- SAR testing was performed on the maximum frame-averaged power mode.
- The frame-averaged power is linearly proportion to the slot number configured and it is linearly scaled the maximum burst-averaged power based on time slots. The calculated method is shown as below:

$$\text{Frame-averaged power} = 10 \times \log (\text{Burst-averaged power mW} \times \text{Slot used} / 8)$$
- The configuration of time-slot for GSM has transmitting signal in one time-slot during one frame (8 time-slots).

FCC SAR Test Report

Band Channel	CDMA BC0			CDMA BC1		
	1013	384	777	25	600	1175
Frequency (MHz)	824.70	836.52	848.31	1851.25	1880.00	1908.75
EUT without Power Reduction						
1xRTT RC1+SO55	23.36	23.18	23.19	23.66	23.73	23.75
1xRTT RC3+SO55	23.38	23.21	23.26	23.55	23.64	23.68
1xRTT RC3+SO32 (FCH)	23.35	23.28	23.26	23.46	23.56	23.57
1xRTT RC3+SO32 (SCH)	23.34	23.19	23.28	23.51	23.62	23.64
1xEVDO Rev.0 RTAP 153.6	23.28	23.13	23.22	23.49	23.51	23.53
1xEVDO Rev.A RETAP 4096	23.26	23.11	23.20	23.45	23.49	23.51
RC1+SO3	23.36	23.21	23.30	23.56	23.57	23.59
RC3+SO3	23.33	23.18	23.27	23.53	23.63	23.66
EUT with Power Reduction						
1xRTT RC1+SO55	22.07	21.91	21.89	21.86	22.04	21.95
1xRTT RC3+SO55	21.98	21.82	21.80	21.85	22.03	21.94
1xRTT RC3+SO32 (FCH)	22.06	21.90	21.88	21.91	22.09	22.00
1xRTT RC3+SO32 (SCH)	22.09	21.93	21.91	21.89	22.07	21.98
1xEVDO Rev.0 RTAP 153.6	22.03	21.87	21.85	21.83	22.01	21.92
1xEVDO Rev.A RETAP 4096	22.01	21.85	21.83	21.81	21.99	21.90
RC1+SO3	22.09	21.93	21.91	21.80	21.98	21.89
RC3+SO3	22.06	21.90	21.88	21.79	21.97	21.88

Band Channel	CDMA BC10		
	476	580	684
Frequency (MHz)	817.9	820.5	823.1
EUT without Power Reduction			
1xRTT RC1+SO55	23.04	23.06	22.88
1xRTT RC3+SO55	23.12	22.99	22.86
1xRTT RC3+SO32 (FCH)	22.99	22.96	22.89
1xRTT RC3+SO32 (SCH)	22.99	22.94	22.85
1xEVDO Rev.0 RTAP 153.6	22.98	22.93	22.84
1xEVDO Rev.A RETAP 4096	22.96	22.91	22.82
RC1+SO3	22.99	22.94	22.85
RC3+SO3	22.94	22.89	22.80
EUT with Power Reduction			
1xRTT RC1+SO55	21.80	21.78	21.62
1xRTT RC3+SO55	21.79	21.77	21.61
1xRTT RC3+SO32 (FCH)	21.78	21.76	21.60
1xRTT RC3+SO32 (SCH)	21.81	21.79	21.63
1xEVDO Rev.0 RTAP 153.6	21.77	21.75	21.59
1xEVDO Rev.A RETAP 4096	21.74	21.72	21.56
RC1+SO3	21.73	21.71	21.55
RC3+SO3	21.75	21.73	21.57

FCC SAR Test Report

LTE Band / BW	RB Size	RB Offset	QPSK			3GPP MPR (dB)	16QAM			3GPP MPR (dB)
			Low CH 18607	Mid CH 18900	High CH 19193		Low CH 18607	Mid CH 18900	High CH 19193	
			1850.7 MHz	1880.0 MHz	1909.3 MHz		1850.7 MHz	1880.0 MHz	1909.3 MHz	
EUT without Power Reduction										
2 / 1.4M	1	0	23.00	22.92	23.07	0	21.58	21.50	21.65	1
	1	2	22.94	22.86	23.01	0	21.55	21.47	21.62	1
	1	5	22.83	22.75	22.90	0	21.42	21.34	21.49	1
	3	0	22.99	22.91	23.06	0	21.56	21.48	21.63	1
	3	1	22.93	22.85	23.00	0	21.53	21.45	21.60	1
	3	3	22.82	22.74	22.89	0	21.40	21.32	21.47	1
	6	0	21.82	21.74	21.89	1	20.93	20.85	21.00	2
EUT with Power Reduction										
2 / 1.4M	1	0	21.81	21.68	21.70	0	21.85	21.72	21.74	0
	1	2	21.90	21.77	21.79	0	21.68	21.55	21.57	0
	1	5	21.55	21.42	21.44	0	20.90	20.77	20.79	0
	3	0	21.80	21.67	21.69	0	21.83	21.70	21.72	1
	3	1	21.89	21.76	21.78	0	21.66	21.53	21.55	1
	3	3	21.54	21.41	21.43	0	20.88	20.75	20.77	1
	6	0	21.87	21.74	21.76	0	20.96	20.83	20.85	1

LTE Band / BW	RB Size	RB Offset	QPSK			3GPP MPR (dB)	16QAM			3GPP MPR (dB)
			Low CH 18615	Mid CH 18900	High CH 19185		Low CH 18615	Mid CH 18900	High CH 19185	
			1851.5 MHz	1880.0 MHz	1908.5 MHz		1851.5 MHz	1880.0 MHz	1908.5 MHz	
EUT without Power Reduction										
2 / 3M	1	0	23.03	22.95	23.10	0	21.61	21.53	21.68	1
	1	7	22.97	22.89	23.04	0	21.58	21.50	21.65	1
	1	14	22.86	22.78	22.93	0	21.45	21.37	21.52	1
	8	0	21.94	21.86	22.01	1	20.98	20.90	21.05	2
	8	3	21.88	21.80	21.95	1	20.94	20.86	21.01	2
	8	7	21.79	21.71	21.86	1	20.90	20.82	20.97	2
	15	0	21.85	21.77	21.92	1	20.96	20.88	21.03	2
EUT with Power Reduction										
2 / 3M	1	0	21.84	21.71	21.73	0	21.88	21.75	21.77	0
	1	7	21.93	21.80	21.82	0	21.71	21.58	21.60	0
	1	14	21.58	21.45	21.47	0	20.93	20.80	20.82	0
	8	0	21.92	21.79	21.81	0	20.75	20.62	20.64	1
	8	3	21.85	21.72	21.74	0	20.92	20.79	20.81	1
	8	7	21.77	21.64	21.66	0	20.93	20.80	20.82	1
	15	0	21.90	21.77	21.79	0	20.99	20.86	20.88	1

FCC SAR Test Report

LTE Band / BW	RB Size	RB Offset	QPSK			3GPP MPR (dB)	16QAM			3GPP MPR (dB)
			Low CH 18625	Mid CH 18900	High CH 19175		Low CH 18625	Mid CH 18900	High CH 19175	
			1852.5 MHz	1880.0 MHz	1907.5 MHz		1852.5 MHz	1880.0 MHz	1907.5 MHz	
EUT without Power Reduction										
2 / 5M	1	0	23.06	22.98	23.13	0	21.64	21.56	21.71	1
	1	12	23.00	22.92	23.07	0	21.61	21.53	21.68	1
	1	24	22.89	22.81	22.96	0	21.48	21.40	21.55	1
	12	0	21.97	21.89	22.04	1	21.01	20.93	21.08	2
	12	6	21.91	21.83	21.98	1	20.97	20.89	21.04	2
	12	13	21.82	21.74	21.89	1	20.93	20.85	21.00	2
	25	0	21.88	21.80	21.95	1	20.99	20.91	21.06	2
EUT with Power Reduction										
2 / 5M	1	0	21.87	21.74	21.76	0	21.91	21.78	21.80	0
	1	12	21.96	21.83	21.85	0	21.74	21.61	21.63	0
	1	24	21.61	21.48	21.50	0	20.96	20.83	20.85	0
	12	0	21.95	21.82	21.84	0	20.78	20.65	20.67	1
	12	6	21.88	21.75	21.77	0	20.95	20.82	20.84	1
	12	13	21.80	21.67	21.69	0	20.96	20.83	20.85	1
	25	0	21.93	21.80	21.82	0	21.02	20.89	20.91	1

LTE Band / BW	RB Size	RB Offset	QPSK			3GPP MPR (dB)	16QAM			3GPP MPR (dB)
			Low CH 18650	Mid CH 18900	High CH 19150		Low CH 18650	Mid CH 18900	High CH 19150	
			1855.0 MHz	1880.0 MHz	1905.0 MHz		1855.0 MHz	1880.0 MHz	1905.0 MHz	
EUT without Power Reduction										
2 / 10M	1	0	23.08	23.00	23.15	0	21.66	21.58	21.73	1
	1	24	23.02	22.94	23.09	0	21.63	21.55	21.70	1
	1	49	22.91	22.83	22.98	0	21.50	21.42	21.57	1
	25	0	21.99	21.91	22.06	1	21.03	20.95	21.10	2
	25	12	21.93	21.85	22.00	1	20.99	20.91	21.06	2
	25	25	21.84	21.76	21.91	1	20.95	20.87	21.02	2
	50	0	21.90	21.82	21.97	1	21.01	20.93	21.08	2
EUT with Power Reduction										
2 / 10M	1	0	21.89	21.76	21.78	0	21.93	21.80	21.82	0
	1	24	21.98	21.85	21.87	0	21.76	21.63	21.65	0
	1	49	21.63	21.50	21.52	0	20.98	20.85	20.87	0
	25	0	21.97	21.84	21.86	0	20.80	20.67	20.69	1
	25	12	21.90	21.77	21.79	0	20.97	20.84	20.86	1
	25	25	21.82	21.69	21.71	0	20.98	20.85	20.87	1
	50	0	21.95	21.82	21.84	0	21.04	20.91	20.93	1

FCC SAR Test Report

LTE Band / BW	RB Size	RB Offset	QPSK			3GPP MPR (dB)	16QAM			3GPP MPR (dB)
			Low CH 18675	Mid CH 18900	High CH 19125		Low CH 18675	Mid CH 18900	High CH 19125	
			1857.5 MHz	1880.0 MHz	1902.5 MHz		1857.5 MHz	1880.0 MHz	1902.5 MHz	
EUT without Power Reduction										
2 / 15M	1	0	23.11	23.03	23.18	0	21.69	21.61	21.76	1
	1	37	23.05	22.97	23.12	0	21.66	21.58	21.73	1
	1	74	22.94	22.86	23.01	0	21.53	21.45	21.60	1
	36	0	22.02	21.94	22.09	1	21.06	20.98	21.13	2
	36	19	21.96	21.88	22.03	1	21.02	20.94	21.09	2
	36	39	21.87	21.79	21.94	1	20.98	20.90	21.05	2
	75	0	21.93	21.85	22.00	1	21.04	20.96	21.11	2
EUT with Power Reduction										
2 / 15M	1	0	21.92	21.79	21.81	0	21.96	21.83	21.85	0
	1	37	22.01	21.88	21.90	0	21.79	21.66	21.68	0
	1	74	21.66	21.53	21.55	0	21.01	20.88	20.90	0
	36	0	22.00	21.87	21.89	0	20.83	20.70	20.72	1
	36	19	21.93	21.80	21.82	0	21.00	20.87	20.89	1
	36	39	21.85	21.72	21.74	0	21.01	20.88	20.90	1
	75	0	21.98	21.85	21.87	0	21.07	20.94	20.96	1

LTE Band / BW	RB Size	RB Offset	QPSK			3GPP MPR (dB)	16QAM			3GPP MPR (dB)
			Low CH 18700	Mid CH 18900	High CH 19100		Low CH 18700	Mid CH 18900	High CH 19100	
			1860.0 MHz	1880.0 MHz	1900.0 MHz		1860.0 MHz	1880.0 MHz	1900.0 MHz	
EUT without Power Reduction										
2 / 20M	1	0	23.16	23.08	23.23	0	21.74	21.66	21.81	1
	1	50	23.10	23.02	23.17	0	21.71	21.63	21.78	1
	1	99	22.99	22.91	23.06	0	21.58	21.50	21.65	1
	50	0	22.07	21.99	22.14	1	21.11	21.03	21.18	2
	50	25	22.01	21.93	22.08	1	21.07	20.99	21.14	2
	50	50	21.92	21.84	21.99	1	21.03	20.95	21.10	2
	100	0	21.98	21.90	22.05	1	21.09	21.01	21.16	2
EUT with Power Reduction										
2 / 20M	1	0	21.97	21.84	21.86	0	22.01	21.88	21.90	0
	1	50	22.06	21.93	21.95	0	21.84	21.71	21.73	0
	1	99	21.71	21.58	21.60	0	21.06	20.93	20.95	0
	50	0	22.05	21.92	21.94	0	20.88	20.75	20.77	1
	50	25	21.98	21.85	21.87	0	21.05	20.92	20.94	1
	50	50	21.90	21.77	21.79	0	21.06	20.93	20.95	1
	100	0	22.03	21.90	21.92	0	21.12	20.99	21.01	1

FCC SAR Test Report

Band / BW	RB Size	RB Offset	QPSK			3GPP MPR (dB)	16QAM			3GPP MPR (dB)
			Low CH 19957	Mid CH 20175	High CH 20393		Low CH 19957	Mid CH 20175	High CH 20393	
			1710.7 MHz	1732.5 MHz	1754.3 MHz		1710.7 MHz	1732.5 MHz	1754.3 MHz	
EUT without Power Reduction										
4 / 1.4M	1	0	23.55	23.58	23.62	0	22.47	22.50	22.54	1
	1	2	23.41	23.44	23.48	0	21.65	21.68	21.72	1
	1	5	23.37	23.40	23.44	0	21.49	21.52	21.56	1
	3	0	23.53	23.56	23.60	1	22.46	22.49	22.53	2
	3	1	23.39	23.42	23.46	1	21.64	21.67	21.71	2
	3	3	23.35	23.38	23.42	1	21.48	21.51	21.55	2
	6	0	22.50	22.53	22.57	1	21.47	21.50	21.54	2
EUT with Power Reduction										
4 / 1.4M	1	0	22.49	22.25	22.28	0	22.06	21.82	21.85	0
	1	2	22.36	22.12	22.15	0	22.22	21.98	22.01	0
	1	5	22.25	22.01	22.04	0	21.90	21.66	21.69	0
	3	0	22.47	22.23	22.26	0	22.05	21.81	21.84	1
	3	1	22.34	22.10	22.13	0	22.21	21.97	22.00	1
	3	3	22.23	21.99	22.02	0	21.89	21.65	21.68	1
	6	0	22.41	22.17	22.20	0	21.33	21.09	21.12	1

Band / BW	RB Size	RB Offset	QPSK			3GPP MPR (dB)	16QAM			3GPP MPR (dB)
			Low CH 19965	Mid CH 20175	High CH 20385		Low CH 19965	Mid CH 20175	High CH 20385	
			1711.5 MHz	1732.5 MHz	1753.5 MHz		1711.5 MHz	1732.5 MHz	1753.5 MHz	
EUT without Power Reduction										
4 / 3M	1	0	23.56	23.59	23.63	0	22.48	22.51	22.55	1
	1	7	23.42	23.45	23.49	0	21.66	21.69	21.73	1
	1	14	23.38	23.41	23.45	0	21.50	21.53	21.57	1
	8	0	22.56	22.59	22.63	1	21.48	21.51	21.55	2
	8	3	22.41	22.44	22.48	1	21.34	21.37	21.41	2
	8	7	22.39	22.42	22.46	1	21.44	21.47	21.51	2
	15	0	22.51	22.54	22.58	1	21.48	21.51	21.55	2
EUT with Power Reduction										
4 / 3M	1	0	22.50	22.26	22.29	0	22.07	21.83	21.86	0
	1	7	22.37	22.13	22.16	0	22.23	21.99	22.02	0
	1	14	22.26	22.02	22.05	0	21.91	21.67	21.70	0
	8	0	22.47	22.23	22.26	0	21.25	21.01	21.04	1
	8	3	22.43	22.19	22.22	0	21.33	21.09	21.12	1
	8	7	22.39	22.15	22.18	0	21.36	21.12	21.15	1
	15	0	22.42	22.18	22.21	0	21.34	21.10	21.13	1

FCC SAR Test Report

Band / BW	RB Size	RB Offset	QPSK			3GPP MPR (dB)	16QAM			3GPP MPR (dB)
			Low CH 19975	Mid CH 20175	High CH 20375		Low CH 19975	Mid CH 20175	High CH 20375	
			1712.5 MHz	1732.5 MHz	1752.5 MHz		1712.5 MHz	1732.5 MHz	1752.5 MHz	
EUT without Power Reduction										
4 / 5M	1	0	23.59	23.62	23.66	0	22.51	22.54	22.58	1
	1	12	23.45	23.48	23.52	0	21.69	21.72	21.76	1
	1	24	23.41	23.44	23.48	0	21.53	21.56	21.60	1
	12	0	22.59	22.62	22.66	1	21.51	21.54	21.58	2
	12	6	22.44	22.47	22.51	1	21.37	21.40	21.44	2
	12	13	22.42	22.45	22.49	1	21.47	21.50	21.54	2
	25	0	22.54	22.57	22.61	1	21.51	21.54	21.58	2
EUT with Power Reduction										
4 / 5M	1	0	22.53	22.29	22.32	0	22.10	21.86	21.89	0
	1	12	22.40	22.16	22.19	0	22.26	22.02	22.05	0
	1	24	22.29	22.05	22.08	0	21.94	21.70	21.73	0
	12	0	22.50	22.26	22.29	0	21.28	21.04	21.07	1
	12	6	22.46	22.22	22.25	0	21.36	21.12	21.15	1
	12	13	22.42	22.18	22.21	0	21.39	21.15	21.18	1
	25	0	22.45	22.21	22.24	0	21.37	21.13	21.16	1

Band / BW	RB Size	RB Offset	QPSK			3GPP MPR (dB)	16QAM			3GPP MPR (dB)
			Low CH 20000	Mid CH 20175	High CH 20350		Low CH 20000	Mid CH 20175	High CH 20350	
			1715.0 MHz	1732.5 MHz	1750.0 MHz		1715.0 MHz	1732.5 MHz	1750.0 MHz	
EUT without Power Reduction										
4 / 10M	1	0	23.63	23.66	23.70	0	22.55	22.58	22.62	1
	1	24	23.49	23.52	23.56	0	21.73	21.76	21.80	1
	1	49	23.45	23.48	23.52	0	21.57	21.60	21.64	1
	25	0	22.63	22.66	22.70	1	21.55	21.58	21.62	2
	25	12	22.48	22.51	22.55	1	21.41	21.44	21.48	2
	25	25	22.46	22.49	22.53	1	21.51	21.54	21.58	2
	50	0	22.58	22.61	22.65	1	21.55	21.58	21.62	2
EUT with Power Reduction										
4 / 10M	1	0	22.57	22.33	22.36	0	22.14	21.90	21.93	0
	1	24	22.44	22.20	22.23	0	22.30	22.06	22.09	0
	1	49	22.33	22.09	22.12	0	21.98	21.74	21.77	0
	25	0	22.54	22.30	22.33	0	21.32	21.08	21.11	1
	25	12	22.50	22.26	22.29	0	21.40	21.16	21.19	1
	25	25	22.46	22.22	22.25	0	21.43	21.19	21.22	1
	50	0	22.49	22.25	22.28	0	21.41	21.17	21.20	1

FCC SAR Test Report

Band / BW	RB Size	RB Offset	QPSK			3GPP MPR (dB)	16QAM			3GPP MPR (dB)
			Low CH 20025	Mid CH 20175	High CH 20325		Low CH 20025	Mid CH 20175	High CH 20325	
			1717.5 MHz	1732.5 MHz	1747.5 MHz		1717.5 MHz	1732.5 MHz	1747.5 MHz	
EUT without Power Reduction										
4 / 15M	1	0	23.69	23.72	23.76	0	22.61	22.64	22.68	1
	1	37	23.55	23.58	23.62	0	21.79	21.82	21.86	1
	1	74	23.51	23.54	23.58	0	21.63	21.66	21.70	1
	36	0	22.69	22.72	22.76	1	21.61	21.64	21.68	2
	36	19	22.54	22.57	22.61	1	21.47	21.50	21.54	2
	36	39	22.52	22.55	22.59	1	21.57	21.60	21.64	2
	75	0	22.64	22.67	22.71	1	21.61	21.64	21.68	2
EUT with Power Reduction										
4 / 15M	1	0	22.63	22.39	22.42	0	22.20	21.96	21.99	0
	1	37	22.50	22.26	22.29	0	22.36	22.12	22.15	0
	1	74	22.39	22.15	22.18	0	22.04	21.80	21.83	0
	36	0	22.60	22.36	22.39	0	21.38	21.14	21.17	1
	36	19	22.56	22.32	22.35	0	21.46	21.22	21.25	1
	36	39	22.52	22.28	22.31	0	21.49	21.25	21.28	1
	75	0	22.55	22.31	22.34	0	21.47	21.23	21.26	1

Band / BW	RB Size	RB Offset	QPSK			3GPP MPR (dB)	16QAM			3GPP MPR (dB)
			Low CH 20050	Mid CH 20175	High CH 20300		Low CH 20050	Mid CH 20175	High CH 20300	
			1720.0 MHz	1732.5 MHz	1745.0 MHz		1720.0 MHz	1732.5 MHz	1745.0 MHz	
EUT without Power Reduction										
4 / 20M	1	0	23.72	23.75	23.79	0	22.64	22.67	22.71	1
	1	50	23.58	23.61	23.65	0	21.82	21.85	21.89	1
	1	99	23.54	23.57	23.61	0	21.66	21.69	21.73	1
	50	0	22.72	22.75	22.79	1	21.64	21.67	21.71	2
	50	25	22.57	22.60	22.64	1	21.50	21.53	21.57	2
	50	50	22.55	22.58	22.62	1	21.60	21.63	21.67	2
	100	0	22.67	22.70	22.74	1	21.64	21.67	21.71	2
EUT with Power Reduction										
4 / 20M	1	0	22.66	22.42	22.45	0	22.23	21.99	22.02	0
	1	50	22.53	22.29	22.32	0	22.39	22.15	22.18	0
	1	99	22.42	22.18	22.21	0	22.07	21.83	21.86	0
	50	0	22.63	22.39	22.42	0	21.41	21.17	21.20	1
	50	25	22.59	22.35	22.38	0	21.49	21.25	21.28	1
	50	50	22.55	22.31	22.34	0	21.52	21.28	21.31	1
	100	0	22.58	22.34	22.37	0	21.50	21.26	21.29	1

FCC SAR Test Report

LTE Band / BW	RB Size	RB Offset	QPSK			3GPP MPR (dB)	16QAM			3GPP MPR (dB)
			Low CH 20407	Mid CH 20525	High CH 20643		Low CH 20407	Mid CH 20525	High CH 20643	
			824.7 MHz	836.5 MHz	848.3 MHz		824.7 MHz	836.5 MHz	848.3 MHz	
5 / 1.4M	1	0	23.29	23.34	23.23	0	22.13	22.18	22.07	1
	1	2	23.35	23.40	23.29	0	22.17	22.22	22.11	1
	1	5	23.06	23.11	23.00	0	22.10	22.15	22.04	1
	3	0	23.27	23.32	23.21	0	22.12	22.17	22.06	1
	3	1	23.33	23.38	23.27	0	22.16	22.21	22.10	1
	3	3	23.04	23.09	22.98	0	22.09	22.14	22.03	1
	6	0	22.30	22.35	22.24	1	21.37	21.42	21.31	2

LTE Band / BW	RB Size	RB Offset	QPSK			3GPP MPR (dB)	16QAM			3GPP MPR (dB)
			Low CH 20415	Mid CH 20525	High CH 20635		Low CH 20415	Mid CH 20525	High CH 20635	
			825.5 MHz	836.5 MHz	847.5 MHz		825.5 MHz	836.5 MHz	847.5 MHz	
5 / 3M	1	0	23.33	23.38	23.27	0	22.17	22.22	22.11	1
	1	7	23.39	23.44	23.33	0	22.21	22.26	22.15	1
	1	14	23.10	23.15	23.04	0	22.14	22.19	22.08	1
	8	0	22.40	22.45	22.34	1	21.47	21.52	21.41	2
	8	3	22.41	22.46	22.35	1	21.54	21.59	21.48	2
	8	7	22.32	22.37	22.26	1	21.43	21.48	21.37	2
	15	0	22.34	22.39	22.28	1	21.41	21.46	21.35	2

LTE Band / BW	RB Size	RB Offset	QPSK			3GPP MPR (dB)	16QAM			3GPP MPR (dB)
			Low CH 20425	Mid CH 20525	High CH 20625		Low CH 20425	Mid CH 20525	High CH 20625	
			826.5 MHz	836.5 MHz	846.5 MHz		826.5 MHz	836.5 MHz	846.5 MHz	
5 / 5M	1	0	23.39	23.44	23.33	0	22.23	22.28	22.17	1
	1	12	23.45	23.50	23.39	0	22.27	22.32	22.21	1
	1	24	23.16	23.21	23.10	0	22.20	22.25	22.14	1
	12	0	22.46	22.51	22.40	1	21.53	21.58	21.47	2
	12	6	22.47	22.52	22.41	1	21.60	21.65	21.54	2
	12	13	22.38	22.43	22.32	1	21.49	21.54	21.43	2
	25	0	22.40	22.45	22.34	1	21.47	21.52	21.41	2

LTE Band / BW	RB Size	RB Offset	QPSK			3GPP MPR (dB)	16QAM			3GPP MPR (dB)
			Low CH 20450	Mid CH 20525	High CH 20600		Low CH 20450	Mid CH 20525	High CH 20600	
			829.0 MHz	836.5 MHz	844.0 MHz		829.0 MHz	836.5 MHz	844.0 MHz	
5 / 10M	1	0	23.42	23.47	23.36	0	22.26	22.31	22.20	1
	1	24	23.48	23.53	23.42	0	22.30	22.35	22.24	1
	1	49	23.19	23.24	23.13	0	22.23	22.28	22.17	1
	25	0	22.49	22.54	22.43	1	21.56	21.61	21.50	2
	25	12	22.50	22.55	22.44	1	21.63	21.68	21.57	2
	25	25	22.41	22.46	22.35	1	21.52	21.57	21.46	2
	50	0	22.43	22.48	22.37	1	21.50	21.55	21.44	2

FCC SAR Test Report

LTE Band / BW	RB Size	RB Offset	QPSK			3GPP MPR (dB)	16QAM			3GPP MPR (dB)
			Low CH 23017	Mid CH 23095	High CH 23173		Low CH 23017	Mid CH 23095	High CH 23173	
			699.7 MHz	707.5 MHz	715.3 MHz		699.7 MHz	707.5 MHz	715.3 MHz	
12 / 1.4M	1	0	23.45	23.08	23.32	0	22.05	21.68	21.92	1
	1	2	23.32	22.95	23.19	0	21.96	21.59	21.83	1
	1	5	23.39	23.02	23.26	0	22.00	21.63	21.87	1
	3	0	23.43	23.06	23.30	0	22.04	21.67	21.91	1
	3	1	23.30	22.93	23.17	0	21.95	21.58	21.82	1
	3	3	23.37	23.00	23.24	0	21.99	21.62	21.86	1
	6	0	22.36	21.99	22.23	1	21.45	21.08	21.32	2

LTE Band / BW	RB Size	RB Offset	QPSK			3GPP MPR (dB)	16QAM			3GPP MPR (dB)
			Low CH 23025	Mid CH 23095	High CH 23165		Low CH 23025	Mid CH 23095	High CH 23165	
			700.5 MHz	707.5 MHz	714.5 MHz		700.5 MHz	707.5 MHz	714.5 MHz	
12 / 3M	1	0	23.49	23.12	23.36	0	22.09	21.72	21.96	1
	1	7	23.36	22.99	23.23	0	22.00	21.63	21.87	1
	1	14	23.43	23.06	23.30	0	22.04	21.67	21.91	1
	8	0	22.42	22.05	22.29	1	21.32	20.95	21.19	2
	8	3	22.29	21.92	22.16	1	21.31	20.94	21.18	2
	8	7	22.36	21.99	22.23	1	21.30	20.93	21.17	2
	15	0	22.40	22.03	22.27	1	21.49	21.12	21.36	2

LTE Band / BW	RB Size	RB Offset	QPSK			3GPP MPR (dB)	16QAM			3GPP MPR (dB)
			Low CH 23035	Mid CH 23095	High CH 23155		Low CH 23035	Mid CH 23095	High CH 23155	
			701.5 MHz	707.5 MHz	713.5 MHz		701.5 MHz	707.5 MHz	713.5 MHz	
12 / 5M	1	0	23.55	23.18	23.42	0	22.15	21.78	22.02	1
	1	12	23.42	23.05	23.29	0	22.06	21.69	21.93	1
	1	24	23.49	23.12	23.36	0	22.10	21.73	21.97	1
	12	0	22.48	22.11	22.35	1	21.38	21.01	21.25	2
	12	6	22.35	21.98	22.22	1	21.37	21.00	21.24	2
	12	13	22.42	22.05	22.29	1	21.36	20.99	21.23	2
	25	0	22.46	22.09	22.33	1	21.55	21.18	21.42	2

LTE Band / BW	RB Size	RB Offset	QPSK			3GPP MPR (dB)	16QAM			3GPP MPR (dB)
			Low CH 23060	Mid CH 23095	High CH 23130		Low CH 23060	Mid CH 23095	High CH 23130	
			704.0 MHz	707.5 MHz	711.0 MHz		704.0 MHz	707.5 MHz	711.0 MHz	
12 / 10M	1	0	23.58	23.21	23.45	0	22.18	21.81	22.05	1
	1	24	23.45	23.08	23.32	0	22.09	21.72	21.96	1
	1	49	23.52	23.15	23.39	0	22.13	21.76	22.00	1
	25	0	22.51	22.14	22.38	1	21.41	21.04	21.28	2
	25	12	22.38	22.01	22.25	1	21.40	21.03	21.27	2
	25	25	22.45	22.08	22.32	1	21.39	21.02	21.26	2
	50	0	22.49	22.12	22.36	1	21.58	21.21	21.45	2

FCC SAR Test Report

LTE Band / BW	RB Size	RB Offset	QPSK			3GPP MPR (dB)	16QAM			3GPP MPR (dB)
			Low CH 23205	Mid CH 23230	High CH 23255		Low CH 23205	Mid CH 23230	High CH 23255	
			779.5 MHz	782.0 MHz	784.5 MHz		779.5 MHz	782.0 MHz	784.5 MHz	
13 / 5M	1	0	23.49	23.31	23.62	0	21.95	21.77	22.08	1
	1	12	23.53	23.35	23.66	0	22.24	22.06	22.37	1
	1	24	23.51	23.33	23.64	0	22.03	21.85	22.16	1
	12	0	22.44	22.26	22.57	1	21.62	21.44	21.75	2
	12	6	22.66	22.48	22.79	1	21.42	21.24	21.55	2
	12	13	22.45	22.27	22.58	1	21.51	21.33	21.64	2
	25	0	22.51	22.33	22.64	1	21.55	21.37	21.68	2

LTE Band / BW	RB Size	RB Offset	QPSK	3GPP MPR (dB)	16QAM	3GPP MPR (dB)
			Mid CH 23230		Mid CH 23230	
			782.0 MHz		782.0 MHz	
13 / 10M	1	0	23.34	0	22.11	1
	1	24	23.68	0	22.24	1
	1	49	23.51	0	22.19	1
	25	0	22.59	1	21.62	2
	25	12	22.66	1	21.58	2
	25	25	22.61	1	21.51	2
	50	0	22.51	1	21.71	2

LTE Band / BW	RB Size	RB Offset	QPSK			3GPP MPR (dB)	16QAM			3GPP MPR (dB)
			Low CH 26047	Mid CH 26365	High CH 26683		Low CH 26047	Mid CH 26365	High CH 26683	
			1850.7 MHz	1882.5 MHz	1914.3 MHz		1850.7 MHz	1882.5 MHz	1914.3 MHz	
EUT without Power Reduction										
25 / 1.4M	1	0	23.08	23.02	23.04	0	21.61	21.55	21.57	1
	1	2	23.04	22.98	23.00	0	21.77	21.71	21.73	1
	1	5	22.98	22.92	22.94	0	21.45	21.39	21.41	1
	3	0	22.09	22.03	22.05	0	21.09	21.03	21.05	1
	3	1	22.04	21.98	22.00	0	21.05	20.99	21.01	1
	3	3	21.99	21.93	21.95	0	21.11	21.05	21.07	1
	6	0	21.94	21.88	21.90	1	20.96	20.90	20.92	2
EUT with Power Reduction										
25 / 1.4M	1	0	21.79	22.03	21.71	0	21.72	21.96	21.64	0
	1	2	21.76	22.00	21.68	0	21.43	21.67	21.35	0
	1	5	21.33	21.57	21.25	0	21.09	21.33	21.01	0
	3	0	21.76	22.00	21.68	0	20.62	20.86	20.54	1
	3	1	21.66	21.90	21.58	0	20.75	20.99	20.67	1
	3	3	21.62	21.86	21.54	0	20.70	20.94	20.62	1
	6	0	21.65	21.89	21.57	0	20.73	20.97	20.65	1

FCC SAR Test Report

LTE Band / BW	RB Size	RB Offset	QPSK			3GPP MPR (dB)	16QAM			3GPP MPR (dB)
			Low CH 26055	Mid CH 26365	High CH 26675		Low CH 26055	Mid CH 26365	High CH 26675	
			1851.5 MHz	1882.5 MHz	1913.5 MHz		1851.5 MHz	1882.5 MHz	1913.5 MHz	
EUT without Power Reduction										
25 / 3M	1	0	23.10	23.04	23.06	0	21.63	21.57	21.59	1
	1	7	23.06	23.00	23.02	0	21.79	21.73	21.75	1
	1	14	23.00	22.94	22.96	0	21.47	21.41	21.43	1
	8	0	22.11	22.05	22.07	1	21.11	21.05	21.07	2
	8	3	22.06	22.00	22.02	1	21.07	21.01	21.03	2
	8	7	22.01	21.95	21.97	1	21.13	21.07	21.09	2
	15	0	21.96	21.90	21.92	1	20.98	20.92	20.94	2
EUT with Power Reduction										
25 / 3M	1	0	21.81	22.05	21.73	0	21.74	21.98	21.66	0
	1	7	21.78	22.02	21.70	0	21.45	21.69	21.37	0
	1	14	21.35	21.59	21.27	0	21.11	21.35	21.03	0
	8	0	21.78	22.02	21.70	0	20.64	20.88	20.56	1
	8	3	21.68	21.92	21.60	0	20.77	21.01	20.69	1
	8	7	21.64	21.88	21.56	0	20.72	20.96	20.64	1
		15	0	21.67	21.91	21.59	0	20.75	20.99	20.67

LTE Band / BW	RB Size	RB Offset	QPSK			3GPP MPR (dB)	16QAM			3GPP MPR (dB)
			Low CH 26065	Mid CH 26365	High CH 26665		Low CH 26065	Mid CH 26365	High CH 26665	
			1852.5 MHz	1882.5 MHz	1912.5 MHz		1852.5 MHz	1882.5 MHz	1912.5 MHz	
EUT without Power Reduction										
25 / 5M	1	0	23.13	23.07	23.09	0	21.66	21.60	21.62	1
	1	12	23.09	23.03	23.05	0	21.82	21.76	21.78	1
	1	24	23.03	22.97	22.99	0	21.50	21.44	21.46	1
	12	0	22.14	22.08	22.10	1	21.14	21.08	21.10	2
	12	6	22.09	22.03	22.05	1	21.10	21.04	21.06	2
	12	13	22.04	21.98	22.00	1	21.16	21.10	21.12	2
		25	0	21.99	21.93	21.95	1	21.01	20.95	20.97
EUT with Power Reduction										
25 / 5M	1	0	21.84	22.08	21.76	0	21.77	22.01	21.69	0
	1	12	21.81	22.05	21.73	0	21.48	21.72	21.40	0
	1	24	21.38	21.62	21.30	0	21.14	21.38	21.06	0
	12	0	21.81	22.05	21.73	0	20.67	20.91	20.59	1
	12	6	21.71	21.95	21.63	0	20.80	21.04	20.72	1
	12	13	21.67	21.91	21.59	0	20.75	20.99	20.67	1
		25	0	21.70	21.94	21.62	0	20.78	21.02	20.70

FCC SAR Test Report

LTE Band / BW	RB Size	RB Offset	QPSK			3GPP MPR (dB)	16QAM			3GPP MPR (dB)
			Low CH 26090	Mid CH 26365	High CH 26640		Low CH 26090	Mid CH 26365	High CH 26640	
			1855.0 MHz	1882.5 MHz	1910.0 MHz		1855.0 MHz	1882.5 MHz	1910.0 MHz	
EUT without Power Reduction										
25 / 10M	1	0	23.10	23.04	23.06	0	21.63	21.57	21.59	1
	1	24	23.06	23.00	23.02	0	21.79	21.73	21.75	1
	1	49	23.00	22.94	22.96	0	21.47	21.41	21.43	1
	25	0	22.11	22.05	22.07	1	21.11	21.05	21.07	2
	25	12	22.06	22.00	22.02	1	21.07	21.01	21.03	2
	25	25	22.01	21.95	21.97	1	21.13	21.07	21.09	2
	50	0	21.96	21.90	21.92	1	20.98	20.92	20.94	2
EUT with Power Reduction										
25 / 10M	1	0	21.86	22.10	21.78	0	21.79	22.03	21.71	0
	1	24	21.83	22.07	21.75	0	21.50	21.74	21.42	0
	1	49	21.40	21.64	21.32	0	21.16	21.40	21.08	0
	25	0	21.83	22.07	21.75	0	20.69	20.93	20.61	1
	25	12	21.73	21.97	21.65	0	20.82	21.06	20.74	1
	25	25	21.69	21.93	21.61	0	20.77	21.01	20.69	1
	50	0	21.72	21.96	21.64	0	20.80	21.04	20.72	1

LTE Band / BW	RB Size	RB Offset	QPSK			3GPP MPR (dB)	16QAM			3GPP MPR (dB)
			Low CH 26115	Mid CH 26365	High CH 26615		Low CH 26115	Mid CH 26365	High CH 26615	
			1857.5 MHz	1882.5 MHz	1907.5 MHz		1857.5 MHz	1882.5 MHz	1907.5 MHz	
EUT without Power Reduction										
25 / 15M	1	0	23.12	23.06	23.08	0	21.65	21.59	21.61	1
	1	37	23.08	23.02	23.04	0	21.81	21.75	21.77	1
	1	74	23.02	22.96	22.98	0	21.49	21.43	21.45	1
	36	0	22.13	22.07	22.09	1	21.13	21.07	21.09	2
	36	19	22.08	22.02	22.04	1	21.09	21.03	21.05	2
	36	39	22.03	21.97	21.99	1	21.15	21.09	21.11	2
	75	0	21.98	21.92	21.94	1	21.00	20.94	20.96	2
EUT with Power Reduction										
25 / 15M	1	0	21.88	22.12	21.80	0	21.81	22.05	21.73	0
	1	37	21.85	22.09	21.77	0	21.52	21.76	21.44	0
	1	74	21.42	21.66	21.34	0	21.18	21.42	21.10	0
	36	0	21.85	22.09	21.77	0	20.71	20.95	20.63	1
	36	19	21.75	21.99	21.67	0	20.84	21.08	20.76	1
	36	39	21.71	21.95	21.63	0	20.79	21.03	20.71	1
	75	0	21.74	21.98	21.66	0	20.82	21.06	20.74	1

FCC SAR Test Report

LTE Band / BW	RB Size	RB Offset	QPSK			3GPP MPR (dB)	16QAM			3GPP MPR (dB)
			Low CH 26140	Mid CH 26365	High CH 26590		Low CH 26140	Mid CH 26365	High CH 26590	
			1860.0 MHz	1882.5 MHz	1905.0 MHz		1860.0 MHz	1882.5 MHz	1905.0 MHz	
EUT without Power Reduction										
25 / 20M	1	0	23.15	23.09	23.11	0	21.68	21.62	21.64	1
	1	50	23.11	23.05	23.07	0	21.84	21.78	21.80	1
	1	99	23.05	22.99	23.01	0	21.52	21.46	21.48	1
	50	0	22.16	22.10	22.12	1	21.16	21.10	21.12	2
	50	25	22.11	22.05	22.07	1	21.12	21.06	21.08	2
	50	50	22.06	22.00	22.02	1	21.18	21.12	21.14	2
	100	0	22.01	21.95	21.97	1	21.03	20.97	20.99	2
EUT with Power Reduction										
25 / 20M	1	0	21.91	22.15	21.83	0	21.84	22.08	21.76	0
	1	50	21.88	22.12	21.80	0	21.55	21.79	21.47	0
	1	99	21.45	21.69	21.37	0	21.21	21.45	21.13	0
	50	0	21.88	22.12	21.80	0	20.74	20.98	20.66	1
	50	25	21.78	22.02	21.70	0	20.87	21.11	20.79	1
	50	50	21.74	21.98	21.66	0	20.82	21.06	20.74	1
	100	0	21.77	22.01	21.69	0	20.85	21.09	20.77	1

LTE Band / BW	RB Size	RB Offset	QPSK			3GPP MPR (dB)	16QAM			3GPP MPR (dB)
			Low CH 26697	Mid CH 26865	High CH 27033		Low CH 26697	Mid CH 26865	High CH 27033	
			814.7 MHz	831.5 MHz	848.3 MHz		814.7 MHz	831.5 MHz	848.3 MHz	
26 / 1.4M	1	0	22.84	22.92	22.80	0	22.07	22.15	22.03	1
	1	2	23.07	23.15	23.03	0	21.82	21.90	21.78	1
	1	5	23.04	23.12	23.00	0	21.55	21.63	21.51	1
	3	0	22.82	22.90	22.78	0	22.06	22.14	22.02	1
	3	1	23.05	23.13	23.01	0	21.81	21.89	21.77	1
	3	3	23.02	23.10	22.98	0	21.54	21.62	21.50	1
	6	0	22.00	22.08	21.96	1	21.12	21.20	21.08	2

LTE Band / BW	RB Size	RB Offset	QPSK			3GPP MPR (dB)	16QAM			3GPP MPR (dB)
			Low CH 26705	Mid CH 26865	High CH 27025		Low CH 26705	Mid CH 26865	High CH 27025	
			815.5 MHz	831.5 MHz	847.5 MHz		815.5 MHz	831.5 MHz	847.5 MHz	
26 / 3M	1	0	22.88	22.96	22.84	0	22.11	22.19	22.07	1
	1	7	23.11	23.19	23.07	0	21.86	21.94	21.82	1
	1	14	23.08	23.16	23.04	0	21.59	21.67	21.55	1
	8	0	22.06	22.14	22.02	1	21.04	21.12	21.00	2
	8	3	22.12	22.20	22.08	1	21.17	21.25	21.13	2
	8	7	21.97	22.05	21.93	1	21.11	21.19	21.07	2
	15	0	22.04	22.12	22.00	1	21.16	21.24	21.12	2

FCC SAR Test Report

LTE Band / BW	RB Size	RB Offset	QPSK			3GPP MPR (dB)	16QAM			3GPP MPR (dB)
			Low CH 26715	Mid CH 26865	High CH 27015		Low CH 26715	Mid CH 26865	High CH 27015	
			816.5 MHz	831.5 MHz	846.5 MHz		816.5 MHz	831.5 MHz	846.5 MHz	
26 / 5M	1	0	22.91	22.99	22.87	0	22.14	22.22	22.10	1
	1	12	23.14	23.22	23.10	0	21.89	21.97	21.85	1
	1	24	23.11	23.19	23.07	0	21.62	21.70	21.58	1
	12	0	22.09	22.17	22.05	1	21.07	21.15	21.03	2
	12	6	22.15	22.23	22.11	1	21.20	21.28	21.16	2
	12	13	22.00	22.08	21.96	1	21.14	21.22	21.10	2
	25	0	22.07	22.15	22.03	1	21.19	21.27	21.15	2

LTE Band / BW	RB Size	RB Offset	QPSK			3GPP MPR (dB)	16QAM			3GPP MPR (dB)
			Low CH 26740	Mid CH 26865	High CH 26990		Low CH 26740	Mid CH 26865	High CH 26990	
			819.0 MHz	831.5 MHz	844.0 MHz		819.0 MHz	831.5 MHz	844.0 MHz	
26 / 10M	1	0	22.94	23.02	22.90	0	22.17	22.25	22.13	1
	1	24	23.17	23.25	23.13	0	21.92	22.00	21.88	1
	1	49	23.14	23.22	23.10	0	21.65	21.73	21.61	1
	25	0	22.12	22.20	22.08	1	21.10	21.18	21.06	2
	25	12	22.18	22.26	22.14	1	21.23	21.31	21.19	2
	25	25	22.03	22.11	21.99	1	21.17	21.25	21.13	2
	50	0	22.10	22.18	22.06	1	21.22	21.30	21.18	2

LTE Band / BW	RB Size	RB Offset	QPSK			3GPP MPR (dB)	16QAM			3GPP MPR (dB)
			Low CH 26765	Mid CH 26865	High CH 26965		Low CH 26765	Mid CH 26865	High CH 26965	
			821.5 MHz	831.5 MHz	841.5 MHz		821.5 MHz	831.5 MHz	841.5 MHz	
26 / 15M	1	0	22.97	23.05	22.93	0	22.20	22.28	22.16	1
	1	37	23.20	23.28	23.16	0	21.95	22.03	21.91	1
	1	74	23.17	23.25	23.13	0	21.68	21.76	21.64	1
	36	0	22.15	22.23	22.11	1	21.13	21.21	21.09	2
	36	19	22.21	22.29	22.17	1	21.26	21.34	21.22	2
	36	39	22.06	22.14	22.02	1	21.20	21.28	21.16	2
	75	0	22.13	22.21	22.09	1	21.25	21.33	21.21	2

FCC SAR Test Report

LTE Band / BW	RB Size	RB Offset	QPSK					3GPP MPR (dB)	16QAM					3GPP MPR (dB)
			L-CH 39675	M-CH 40148	M-CH 40620	M-CH 41093	H-CH 41565		L-CH 39675	M-CH 40148	M-CH 40620	M-CH 41093	H-CH 41565	
			2498.5 MHz	2545.8 MHz	2593.0 MHz	2640.3 MHz	2687.5 MHz		2498.5 MHz	2545.8 MHz	2593.0 MHz	2640.3 MHz	2687.5 MHz	
41 / 5M	1	0	23.83	23.73	23.82	23.79	23.76	0	22.08	21.98	22.07	22.04	22.01	1
	1	12	23.88	23.78	23.87	23.84	23.81	0	22.35	22.25	22.34	22.31	22.28	1
	1	24	23.75	23.65	23.74	23.71	23.68	0	22.03	21.93	22.02	21.99	21.96	1
	12	0	22.81	22.71	22.80	22.77	22.74	1	21.72	21.62	21.71	21.68	21.65	2
	12	6	22.95	22.85	22.94	22.91	22.88	1	21.85	21.75	21.84	21.81	21.78	2
	12	13	22.79	22.69	22.78	22.75	22.72	1	21.89	21.79	21.88	21.85	21.82	2
	25	0	22.85	22.75	22.84	22.81	22.78	1	21.99	21.89	21.98	21.95	21.92	2

LTE Band / BW	RB Size	RB Offset	QPSK					3GPP MPR (dB)	16QAM					3GPP MPR (dB)
			L-CH 39700	M-CH 40160	M-CH 40620	M-CH 41080	H-CH 41540		L-CH 39700	M-CH 40160	M-CH 40620	M-CH 41080	H-CH 41540	
			2501.0 MHz	2547.0 MHz	2593.0 MHz	2639.0 MHz	2685.0 MHz		2501.0 MHz	2547.0 MHz	2593.0 MHz	2639.0 MHz	2685.0 MHz	
41 / 10M	1	0	23.86	23.76	23.85	23.82	23.79	0	22.11	22.01	22.10	22.07	22.04	1
	1	24	23.91	23.81	23.90	23.87	23.84	0	22.38	22.28	22.37	22.34	22.31	1
	1	49	23.78	23.68	23.77	23.74	23.71	0	22.06	21.96	22.05	22.02	21.99	1
	25	0	22.84	22.74	22.83	22.80	22.77	1	21.75	21.65	21.74	21.71	21.68	2
	25	12	22.98	22.88	22.97	22.94	22.91	1	21.88	21.78	21.87	21.84	21.81	2
	25	25	22.82	22.72	22.81	22.78	22.75	1	21.92	21.82	21.91	21.88	21.85	2
	50	0	22.88	22.78	22.87	22.84	22.81	1	22.02	21.92	22.01	21.98	21.95	2

LTE Band / BW	RB Size	RB Offset	QPSK					3GPP MPR (dB)	16QAM					3GPP MPR (dB)
			L-CH 39725	M-CH 40173	M-CH 40620	M-CH 41068	H-CH 41515		L-CH 39725	M-CH 40173	M-CH 40620	M-CH 41068	H-CH 41515	
			2503.5 MHz	2548.3 MHz	2593.0 MHz	2637.8 MHz	2682.5 MHz		2503.5 MHz	2548.3 MHz	2593.0 MHz	2637.8 MHz	2682.5 MHz	
41 / 15M	1	0	23.90	23.80	23.89	23.86	23.83	0	22.15	22.05	22.14	22.11	22.08	1
	1	37	23.95	23.85	23.94	23.91	23.88	0	22.42	22.32	22.41	22.38	22.35	1
	1	74	23.82	23.72	23.81	23.78	23.75	0	22.10	22.00	22.09	22.06	22.03	1
	36	0	22.88	22.78	22.87	22.84	22.81	1	21.79	21.69	21.78	21.75	21.72	2
	36	19	23.02	22.92	23.01	22.98	22.95	1	21.92	21.82	21.91	21.88	21.85	2
	36	39	22.86	22.76	22.85	22.82	22.79	1	21.96	21.86	21.95	21.92	21.89	2
	75	0	22.92	22.82	22.91	22.88	22.85	1	22.06	21.96	22.05	22.02	21.99	2

LTE Band / BW	RB Size	RB Offset	QPSK					3GPP MPR (dB)	16QAM					3GPP MPR (dB)
			L-CH 39750	M-CH 40185	M-CH 40620	M-CH 41055	H-CH 41490		L-CH 39750	M-CH 40185	M-CH 40620	M-CH 41055	H-CH 41490	
			2506.0 MHz	2549.5 MHz	2593.0 MHz	2636.5 MHz	2680.0 MHz		2506.0 MHz	2549.5 MHz	2593.0 MHz	2636.5 MHz	2680.0 MHz	
41 / 20M	1	0	23.96	23.86	23.95	23.92	23.89	0	22.21	22.11	22.20	22.17	22.14	1
	1	50	24.01	23.91	24.00	23.97	23.94	0	22.48	22.38	22.47	22.44	22.41	1
	1	99	23.88	23.78	23.87	23.84	23.81	0	22.16	22.06	22.15	22.12	22.09	1
	50	0	22.94	22.84	22.93	22.90	22.87	1	21.85	21.75	21.84	21.81	21.78	2
	50	25	23.08	22.98	23.07	23.04	23.01	1	21.98	21.88	21.97	21.94	21.91	2
	50	50	22.92	22.82	22.91	22.88	22.85	1	22.02	21.92	22.01	21.98	21.95	2
	100	0	22.98	22.88	22.97	22.94	22.91	1	22.12	22.02	22.11	22.08	22.05	2

FCC SAR Test Report

<WLAN 2.4G>

Mode	802.11b		
Channel / Frequency (MHz)	1 (2412)	6 (2437)	11 (2462)
Average Power	16.81	16.05	18.14
Mode	802.11g		
Channel / Frequency (MHz)	1 (2412)	6 (2437)	11 (2462)
Average Power	16.18	16.05	16.24
Mode	802.11n (HT20)		
Channel / Frequency (MHz)	1 (2412)	6 (2437)	11 (2462)
Average Power	11.60	11.07	12.54

<Bluetooth>

Mode	Bluetooth GFSK		
Channel / Frequency (MHz)	0 (2402)	39 (2441)	78 (2480)
Average Power	0.61	0.29	-0.01
Mode	Bluetooth $\pi/4$ -DQPSK		
Channel / Frequency (MHz)	0 (2402)	39 (2441)	78 (2480)
Average Power	-0.89	-1.18	-1.34
Mode	Bluetooth 8DPSK		
Channel / Frequency (MHz)	0 (2402)	39 (2441)	78 (2480)
Average Power	-1.07	-0.95	-1.24
Mode	Bluetooth LE		
Channel / Frequency (MHz)	0 (2402)	19 (2440)	39 (2480)
Average Power	-5.54	-6.81	-6.42

4.7 SAR Testing Results

4.7.1 SAR Test Reduction Considerations

<KDB 447498 D01, General RF Exposure Guidance>

Testing of other required channels within the operating mode of a frequency band is not required when the reported SAR for the mid-band or highest output power channel is:

- (1) ≤ 0.8 W/kg or 2.0 W/kg, for 1-g or 10-g respectively, when the transmission band is ≤ 100 MHz
- (2) ≤ 0.6 W/kg or 1.5 W/kg, for 1-g or 10-g respectively, when the transmission band is between 100 MHz and 200 MHz
- (3) ≤ 0.4 W/kg or 1.0 W/kg, for 1-g or 10-g respectively, when the transmission band is ≥ 200 MHz

<KDB 941225 D01, 3G SAR Measurement Procedures>

The mode tested for SAR is referred to as the primary mode. The equivalent modes considered for SAR test reduction are denoted as secondary modes. Both primary and secondary modes must be in the same frequency band. When the maximum output power and tune-up tolerance specified for production units in a secondary mode is $\leq 1/4$ dB higher than the primary mode or when the highest reported SAR of the primary mode is scaled by the ratio of specified maximum output power and tune-up tolerance of secondary to primary mode and the adjusted SAR is ≤ 1.2 W/kg, SAR measurement is not required for the secondary mode.

<KDB 941225 D05, SAR Evaluation Considerations for LTE Devices>

(1) QPSK with 1 RB and 50% RB allocation

Start with the largest channel bandwidth and measure SAR, using the RB offset and required test channel combination with the highest maximum output power among RB offsets at the upper edge, middle and lower edge of each required test channel. When the reported SAR is ≤ 0.8 W/kg, testing of the remaining RB offset configurations and required test channels is not required; otherwise, SAR is required for the remaining required test channels and only for the RB offset configuration with the highest output power for that channel. When the reported SAR of a required test channel is > 1.45 W/kg, SAR is required for all three RB offset configurations for that required test channel.

(2) QPSK with 100% RB allocation

SAR is not required when the highest maximum output power for 100% RB allocation is less than the highest maximum output power in 50% and 1 RB allocations and the highest reported SAR for 1 RB and 50% RB allocation are ≤ 0.8 W/kg. Otherwise, SAR is measured for the highest output power channel; and if the reported SAR is > 1.45 W/kg, the remaining required test channels must also be tested.

(3) Higher order modulations

SAR is required only when the highest maximum output power for the configuration in the higher order modulation is $> 1/2$ dB higher than the same configuration in QPSK or when the reported SAR for the QPSK configuration is > 1.45 W/kg.

(4) Other channel bandwidth

SAR is required when the highest maximum output power of the smaller channel bandwidth is $> 1/2$ dB higher than the equivalent channel configurations in the largest channel bandwidth configuration or the reported SAR of a configuration for the largest channel bandwidth is > 1.45 W/kg.

<KDB 248227 D01, SAR Guidance for Wi-Fi Transmitters>

- (1) For handsets operating next to ear, hotspot mode or mini-tablet configurations, the initial test position procedures were applied. The test position with the highest extrapolated peak SAR will be used as the initial test position. When the reported SAR of initial test position is ≤ 0.4 W/kg, SAR testing for remaining test positions is not required. Otherwise, SAR is evaluated at the subsequent highest peak SAR positions until the reported SAR result is ≤ 0.8 W/kg or all test positions are measured.
- (2) For WLAN 2.4 GHz, the highest measured maximum output power channel for DSSS was selected for SAR measurement. When the reported SAR is ≤ 0.8 W/kg, no further SAR testing is required. Otherwise, SAR is evaluated at the next highest measured output power channel. When any reported SAR is > 1.2 W/kg, SAR is required for the third channel. For OFDM modes (802.11g/n), SAR is not required when the highest reported SAR for DSSS is adjusted by the ratio of OFDM to DSSS specified maximum output power and it is ≤ 1.2 W/kg.

FCC SAR Test Report

4.7.2 SAR Results for Head Exposure Condition

Plot No.	Band	Mode	Test Position	Ch.	Battery	Max. Tune-up Power (dBm)	Measured Conducted Power (dBm)	Power Drift (dB)	Measured SAR-1g (W/kg)	Scaling Factor	Scaled SAR-1g (W/kg)
1	GSM850	GPRS12	Right Cheek	251	1	28.5	28.07	-0.08	0.253	1.10	0.28
	GSM850	GPRS12	Right Tilted	251	1	28.5	28.07	0.05	0.097	1.10	0.11
	GSM850	GPRS12	Left Cheek	251	1	28.5	28.07	0.02	0.158	1.10	0.17
	GSM850	GPRS12	Left Tilted	251	1	28.5	28.07	0.03	0.069	1.10	0.08
	GSM850	GPRS12	Right Cheek	251	2	28.5	28.07	-0.09	0.253	1.10	0.28
2	GSM1900	GPRS12	Right Cheek	810	1	24.5	23.90	-0.04	0.196	1.15	0.23
	GSM1900	GPRS12	Right Tilted	810	1	24.5	23.90	0.00	0.112	1.15	0.13
	GSM1900	GPRS12	Left Cheek	810	1	24.5	23.90	-0.10	0.267	1.15	0.31
3	CDMA BC0	RC3+SO55	Right Cheek	1013	1	23.5	23.38	-0.05	0.201	1.03	0.21
	CDMA BC0	RC3+SO55	Right Tilted	1013	1	23.5	23.38	0.05	0.058	1.03	0.06
	CDMA BC0	RC3+SO55	Left Cheek	1013	1	23.5	23.38	0.01	0.144	1.03	0.15
4	CDMA BC0	RC3+SO55	Left Tilted	1013	1	23.5	23.38	-0.16	0.037	1.03	0.04
	CDMA BC0	RC3+SO55	Right Cheek	1013	2	23.5	23.38	0.13	0.199	1.03	0.20
	CDMA BC1	RC3+SO55	Right Cheek	1175	1	24.0	23.68	0.05	0.134	1.08	0.14
	CDMA BC1	RC3+SO55	Right Tilted	1175	1	24.0	23.68	0.07	0.089	1.08	0.10
	CDMA BC1	RC3+SO55	Left Cheek	1175	1	24.0	23.68	0.05	0.181	1.08	0.19
5	CDMA BC1	RC3+SO55	Left Tilted	1175	1	24.0	23.68	-0.07	0.1	1.08	0.11
	CDMA BC1	RC3+SO55	Left Cheek	1175	2	24.0	23.68	0.02	0.178	1.08	0.19
	CDMA BC10	RC3+SO55	Right Cheek	476	1	23.5	23.12	0.16	0.197	1.09	0.22
	CDMA BC10	RC3+SO55	Right Tilted	476	1	23.5	23.12	-0.01	0.053	1.09	0.06
	CDMA BC10	RC3+SO55	Left Cheek	476	1	23.5	23.12	0.03	0.149	1.09	0.16
6	CDMA BC10	RC3+SO55	Left Tilted	476	1	23.5	23.12	-0.03	0.036	1.09	0.04
	CDMA BC10	RC3+SO55	Right Cheek	476	2	23.5	23.12	0.01	0.188	1.09	0.21

Plot No.	Band	Mode	Test Position	Ch.	RB#	RB Offset	Battery	Max. Tune-up Power (dBm)	Measured Conducted Power (dBm)	Power Drift (dB)	Measured SAR-1g (W/kg)	Scaling Factor	Scaled SAR-1g (W/kg)
6	LTE 2	QPSK20M	Right Cheek	19100	1	0	1	23.5	23.23	-0.18	0.147	1.06	0.16
	LTE 2	QPSK20M	Right Tilted	19100	1	0	1	23.5	23.23	-0.10	0.087	1.06	0.09
	LTE 2	QPSK20M	Left Cheek	19100	1	0	1	23.5	23.23	0.01	0.177	1.06	0.19
	LTE 2	QPSK20M	Left Tilted	19100	1	0	1	23.5	23.23	-0.09	0.09	1.06	0.10
	LTE 2	QPSK20M	Right Cheek	19100	50	0	1	22.5	22.14	-0.08	0.105	1.09	0.11
	LTE 2	QPSK20M	Right Tilted	19100	50	0	1	22.5	22.14	0.10	0.069	1.09	0.07
	LTE 2	QPSK20M	Left Cheek	19100	50	0	1	22.5	22.14	0.04	0.129	1.09	0.14
	LTE 2	QPSK20M	Left Tilted	19100	50	0	1	22.5	22.14	0.05	0.135	1.09	0.15
	LTE 2	QPSK20M	Left Cheek	19100	1	0	2	23.5	23.23	0.01	0.166	1.06	0.18
	LTE 4	QPSK20M	Right Cheek	20300	1	0	1	24.0	23.79	0.15	0.133	1.05	0.14
	LTE 4	QPSK20M	Right Tilted	20300	1	0	1	24.0	23.79	0.05	0.1	1.05	0.10
	LTE 4	QPSK20M	Left Cheek	20300	1	0	1	24.0	23.79	0.06	0.175	1.05	0.18
7	LTE 4	QPSK20M	Left Tilted	20300	1	0	1	24.0	23.79	0.06	0.154	1.05	0.16
	LTE 4	QPSK20M	Right Cheek	20300	50	0	1	23.0	22.79	0.00	0.117	1.05	0.12
	LTE 4	QPSK20M	Right Tilted	20300	50	0	1	23.0	22.79	0.18	0.077	1.05	0.08
	LTE 4	QPSK20M	Left Cheek	20300	50	0	1	23.0	22.79	0.02	0.164	1.05	0.17
	LTE 4	QPSK20M	Left Tilted	20300	50	0	1	23.0	22.79	-0.01	0.094	1.05	0.10
	LTE 4	QPSK20M	Left Cheek	20300	1	0	2	24.0	23.79	0.07	0.144	1.05	0.15

FCC SAR Test Report

Plot No.	Band	Mode	Test Position	Ch.	RB#	RB Offset	Battery	Max. Tune-up Power (dBm)	Measured Conducted Power (dBm)	Power Drift (dB)	Measured SAR-1g (W/kg)	Scaling Factor	Scaled SAR-1g (W/kg)
8	LTE 5	QPSK10M	Right Cheek	20525	1	24	1	24.0	23.53	-0.04	0.706	1.11	0.79
	LTE 5	QPSK10M	Right Tilted	20525	1	24	1	24.0	23.53	-0.06	0.345	1.11	0.38
	LTE 5	QPSK10M	Left Cheek	20525	1	24	1	24.0	23.53	0.02	0.645	1.11	0.72
	LTE 5	QPSK10M	Left Tilted	20525	1	24	1	24.0	23.53	0.05	0.361	1.11	0.40
	LTE 5	QPSK10M	Right Cheek	20525	25	12	1	23.0	22.55	-0.01	0.621	1.11	0.69
	LTE 5	QPSK10M	Right Tilted	20525	25	12	1	23.0	22.55	0.00	0.384	1.11	0.43
	LTE 5	QPSK10M	Left Cheek	20525	25	12	1	23.0	22.55	-0.01	0.587	1.11	0.65
	LTE 5	QPSK10M	Left Tilted	20525	25	12	1	23.0	22.55	0.00	0.294	1.11	0.33
	LTE 5	QPSK10M	Right Cheek	20525	1	24	2	24.0	23.53	0.11	0.703	1.11	0.78
9	LTE 12	QPSK10M	Right Cheek	23060	1	0	1	24.0	23.58	-0.13	0.451	1.10	0.50
	LTE 12	QPSK10M	Right Tilted	23060	1	0	1	24.0	23.58	-0.06	0.209	1.10	0.23
	LTE 12	QPSK10M	Left Cheek	23060	1	0	1	24.0	23.58	0.07	0.414	1.10	0.46
	LTE 12	QPSK10M	Left Tilted	23060	1	0	1	24.0	23.58	-0.01	0.237	1.10	0.26
	LTE 12	QPSK10M	Right Cheek	23060	25	0	1	23.0	22.51	-0.11	0.365	1.12	0.41
	LTE 12	QPSK10M	Right Tilted	23060	25	0	1	23.0	22.51	0.04	0.188	1.12	0.21
	LTE 12	QPSK10M	Left Cheek	23060	25	0	1	23.0	22.51	0.05	0.306	1.12	0.34
	LTE 12	QPSK10M	Left Tilted	23060	25	0	1	23.0	22.51	0.11	0.17	1.12	0.19
	LTE 12	QPSK10M	Right Cheek	23060	1	0	2	24.0	23.58	0.11	0.399	1.10	0.44
10	LTE 13	QPSK10M	Right Cheek	23230	1	24	1	24.0	23.68	-0.07	0.457	1.08	0.49
	LTE 13	QPSK10M	Right Tilted	23230	1	24	1	24.0	23.68	0.04	0.244	1.08	0.26
	LTE 13	QPSK10M	Left Cheek	23230	1	24	1	24.0	23.68	0.12	0.452	1.08	0.49
	LTE 13	QPSK10M	Left Tilted	23230	1	24	1	24.0	23.68	0.04	0.243	1.08	0.26
	LTE 13	QPSK10M	Right Cheek	23230	25	12	1	23.0	22.66	-0.01	0.387	1.08	0.42
	LTE 13	QPSK10M	Right Tilted	23230	25	12	1	23.0	22.66	0.07	0.22	1.08	0.24
	LTE 13	QPSK10M	Left Cheek	23230	25	12	1	23.0	22.66	0.13	0.332	1.08	0.36
	LTE 13	QPSK10M	Left Tilted	23230	25	12	1	23.0	22.66	-0.06	0.16	1.08	0.17
	LTE 13	QPSK10M	Right Cheek	23230	1	24	2	24.0	23.68	0.07	0.452	1.08	0.49
11	LTE 25	QPSK20M	Right Cheek	26140	1	0	1	23.5	23.15	0.11	0.144	1.08	0.16
	LTE 25	QPSK20M	Right Tilted	26140	1	0	1	23.5	23.15	-0.04	0.079	1.08	0.09
	LTE 25	QPSK20M	Left Cheek	26140	1	0	1	23.5	23.15	0.11	0.147	1.08	0.16
	LTE 25	QPSK20M	Left Tilted	26140	1	0	1	23.5	23.15	-0.05	0.093	1.08	0.10
	LTE 25	QPSK20M	Right Cheek	26140	50	0	1	22.5	22.16	0.12	0.098	1.08	0.11
	LTE 25	QPSK20M	Right Tilted	26140	50	0	1	22.5	22.16	-0.09	0.066	1.08	0.07
	LTE 25	QPSK20M	Left Cheek	26140	50	0	1	22.5	22.16	0.06	0.122	1.08	0.13
	LTE 25	QPSK20M	Left Tilted	26140	50	0	1	22.5	22.16	0.07	0.074	1.08	0.08
	LTE 25	QPSK20M	Left Cheek	26140	1	0	2	23.5	23.15	-0.03	0.131	1.08	0.14
12	LTE 26	QPSK15M	Right Cheek	26865	1	37	1	24.0	23.28	0.01	0.681	1.18	0.80
	LTE 26	QPSK15M	Right Tilted	26865	1	37	1	24.0	23.28	0.09	0.304	1.18	0.36
	LTE 26	QPSK15M	Left Cheek	26865	1	37	1	24.0	23.28	-0.08	0.591	1.18	0.70
	LTE 26	QPSK15M	Left Tilted	26865	1	37	1	24.0	23.28	-0.15	0.317	1.18	0.37
	LTE 26	QPSK15M	Right Cheek	26865	36	19	1	23.0	22.29	0.01	0.502	1.18	0.59
	LTE 26	QPSK15M	Right Tilted	26865	36	19	1	23.0	22.29	-0.09	0.31	1.18	0.37
	LTE 26	QPSK15M	Left Cheek	26865	36	19	1	23.0	22.29	0.17	0.471	1.18	0.55
	LTE 26	QPSK15M	Left Tilted	26865	36	19	1	23.0	22.29	-0.07	0.237	1.18	0.28
	LTE 26	QPSK15M	Right Cheek	26765	1	37	1	24.0	23.20	-0.03	0.659	1.20	0.79
	LTE 26	QPSK15M	Right Cheek	26965	1	37	1	24.0	23.16	0.02	0.651	1.21	0.79
	LTE 26	QPSK15M	Right Cheek	26865	75	0	1	23.0	22.21	-0.03	0.496	1.20	0.59
	LTE 26	QPSK15M	Right Cheek	26865	1	37	2	24.0	23.28	-0.01	0.664	1.18	0.78
	LTE 26	QPSK15M	Right Cheek	26865	1	37	1	24.0	23.28	-0.06	0.672	1.18	0.79

FCC SAR Test Report

Plot No.	Band	Mode	Test Position	Ch.	RB#	RB Offset	Battery	Max. Tune-up Power (dBm)	Measured Conducted Power (dBm)	Power Drift (dB)	Measured SAR-1g (W/kg)	Scaling Factor	Scaled SAR-1g (W/kg)
	LTE 41	QPSK20M	Right Cheek	39750	1	50	1	24.5	24.01	0.07	0.108	1.12	0.12
	LTE 41	QPSK20M	Right Tilted	39750	1	50	1	24.5	24.01	-0.02	0.066	1.12	0.07
13	LTE 41	QPSK20M	Left Cheek	39750	1	50	1	24.5	24.01	0.09	0.136	1.12	0.15
	LTE 41	QPSK20M	Left Tilted	39750	1	50	1	24.5	24.01	0.08	0.059	1.12	0.07
	LTE 41	QPSK20M	Right Cheek	39750	50	25	1	23.5	23.08	0.04	0.077	1.10	0.08
	LTE 41	QPSK20M	Right Tilted	39750	50	25	1	23.5	23.08	0.06	0.052	1.10	0.06
	LTE 41	QPSK20M	Left Cheek	39750	50	25	1	23.5	23.08	-0.01	0.099	1.10	0.11
	LTE 41	QPSK20M	Left Tilted	39750	50	25	1	23.5	23.08	0.00	0.044	1.10	0.05
	LTE 41	QPSK20M	Left Cheek	39750	1	50	2	24.5	24.01	-0.04	0.123	1.12	0.14

Plot No.	Band	Mode	Test Position	Ch.	Battery	Max. Tune-up Power (dBm)	Measured Conducted Power (dBm)	Power Drift (dB)	Measured SAR-1g (W/kg)	Scaling Factor	Scaled SAR-1g (W/kg)
14	802.11b	-	Right Cheek	11	1	18.5	18.14	-0.11	0.201	1.09	0.22
	802.11b	-	Right Tilted	11	1	18.5	18.14	0.12	0.03	1.09	0.03
	802.11b	-	Left Cheek	11	1	18.5	18.14	0.04	0.083	1.09	0.09
	802.11b	-	Left Tilted	11	1	18.5	18.14	-0.01	0.033	1.09	0.04
	802.11b	-	Right Cheek	11	2	18.5	18.14	-0.08	0.175	1.09	0.19

4.7.3 SAR Results for Body-worn Exposure Condition (Separation Distance is 1.5 cm Gap)

Plot No.	Band	Mode	Test Position	Ch.	Battery	Earphone	Max. Tune-up Power (dBm)	Measured Conducted Power (dBm)	Power Drift (dB)	Measured SAR-1g (W/kg)	Scaling Factor	Scaled SAR-1g (W/kg)
	GSM850	GPRS12	Front Face	251	1	-	28.5	28.07	0.11	0.461	1.10	0.51
	GSM850	GPRS12	Rear Face	251	1	-	28.5	28.07	-0.01	0.85	1.10	0.94
	GSM850	GPRS12	Rear Face	128	1	-	28.5	27.72	-0.06	0.949	1.20	1.14
15	GSM850	GPRS12	Rear Face	189	1	-	28.5	27.94	0.03	1.1	1.14	1.25
	GSM850	GPRS12	Rear Face	189	2	-	28.5	27.94	-0.11	1.08	1.14	1.23
	GSM850	GPRS12	Rear Face	189	1	V	28.5	27.94	0.10	1.08	1.14	1.23
	GSM850	GPRS12	Rear Face	189	1	-	28.5	27.94	0.03	1.09	1.14	1.24
	GSM1900	GPRS12	Front Face	810	1	-	24.5	23.90	0.06	0.081	1.15	0.09
16	GSM1900	GPRS12	Rear Face	810	1	-	24.5	23.90	0.06	0.371	1.15	0.43
	GSM1900	GPRS12	Rear Face	810	2	-	24.5	23.90	0.01	0.347	1.15	0.40
	CDMA BC0	RC3+SO32	Front Face	1013	1	-	23.5	23.35	0.01	0.44	1.04	0.46
17	CDMA BC0	RC3+SO32	Rear Face	1013	1	-	23.5	23.35	-0.01	0.994	1.04	1.03
	CDMA BC0	RC3+SO32	Rear Face	384	1	-	23.5	23.28	-0.13	0.839	1.05	0.88
	CDMA BC0	RC3+SO32	Rear Face	777	1	-	23.5	23.26	-0.01	0.627	1.06	0.66
	CDMA BC0	RC3+SO32	Rear Face	1013	2	-	23.5	23.35	-0.15	0.988	1.04	1.02
	CDMA BC0	RC3+SO32	Rear Face	1013	1	-	23.5	23.35	0.02	0.989	1.04	1.02
	CDMA BC1	RC3+SO32	Front Face	1175	1	-	24.0	23.57	0.07	0.209	1.10	0.23
	CDMA BC1	RC3+SO32	Rear Face	1175	1	-	24.0	23.57	-0.11	0.906	1.10	1.00
18	CDMA BC1	RC3+SO32	Rear Face	25	1	-	24.0	23.46	0.13	1.03	1.13	1.17
	CDMA BC1	RC3+SO32	Rear Face	600	1	-	24.0	23.56	0.04	0.922	1.11	1.02
	CDMA BC1	RC3+SO32	Rear Face	25	2	-	24.0	23.46	-0.06	0.933	1.13	1.06
	CDMA BC1	RC3+SO32	Rear Face	25	1	-	24.0	23.46	0.02	1	1.13	1.13
	CDMA BC10	RC3+SO32	Front Face	476	1	-	23.5	22.99	0.05	0.394	1.12	0.44
19	CDMA BC10	RC3+SO32	Rear Face	476	1	-	23.5	22.99	-0.03	0.935	1.12	1.05
	CDMA BC10	RC3+SO32	Rear Face	580	1	-	23.5	22.96	-0.02	0.928	1.13	1.05
	CDMA BC10	RC3+SO32	Rear Face	684	1	-	23.5	22.89	-0.01	0.893	1.15	1.03
	CDMA BC10	RC3+SO32	Rear Face	476	2	-	23.5	22.99	0.03	0.932	1.12	1.05
	CDMA BC10	RC3+SO32	Rear Face	476	1	-	23.5	22.99	0.05	0.928	1.12	1.04

FCC SAR Test Report

Plot No.	Band	Mode	Test Position	Ch.	Battery	RB#	RB Offset	Max. Tune-up Power (dBm)	Measured Conducted Power (dBm)	Power Drift (dB)	Measured SAR-1g (W/kg)	Scaling Factor	Scaled SAR-1g (W/kg)
	LTE 2	QPSK20M	Front Face	19100	1	1	0	23.5	23.23	0.04	0.181	1.06	0.19
20	LTE 2	QPSK20M	Rear Face	19100	1	1	0	23.5	23.23	-0.15	0.81	1.06	0.86
	LTE 2	QPSK20M	Front Face	19100	1	50	0	22.5	22.14	-0.03	0.133	1.09	0.14
	LTE 2	QPSK20M	Rear Face	19100	1	50	0	22.5	22.14	-0.09	0.616	1.09	0.67
	LTE 2	QPSK20M	Rear Face	18700	1	1	0	22.5	23.16	0.06	0.821	0.86	0.71
	LTE 2	QPSK20M	Rear Face	18900	1	1	0	22.5	23.08	0.04	0.8	0.87	0.70
	LTE 2	QPSK20M	Rear Face	19100	1	100	0	22.5	22.05	0.01	0.639	1.11	0.71
	LTE 2	QPSK20M	Rear Face	19100	2	1	0	23.5	23.23	0.10	0.788	1.06	0.84
	LTE 2	QPSK20M	Rear Face	19100	1	1	0	23.5	23.23	0.09	0.791	1.06	0.84
	LTE 4	QPSK20M	Front Face	20300	1	1	0	24.0	23.79	0.19	0.278	1.05	0.29
21	LTE 4	QPSK20M	Rear Face	20300	1	1	0	24.0	23.79	0.10	0.674	1.05	0.71
	LTE 4	QPSK20M	Front Face	20300	1	50	0	23.0	22.79	0.02	0.21	1.05	0.22
	LTE 4	QPSK20M	Rear Face	20300	1	50	0	23.0	22.79	-0.08	0.491	1.05	0.52
	LTE 4	QPSK20M	Rear Face	20300	2	1	0	24.0	23.79	0.19	0.631	1.05	0.66
	LTE 5	QPSK10M	Front Face	20525	1	1	24	24.0	23.53	0.06	0.358	1.11	0.40
22	LTE 5	QPSK10M	Rear Face	20525	1	1	24	24.0	23.53	0.16	0.763	1.11	0.85
	LTE 5	QPSK10M	Front Face	20525	1	25	12	23.0	22.55	0.02	0.268	1.11	0.30
	LTE 5	QPSK10M	Rear Face	20525	1	25	12	23.0	22.55	0.04	0.579	1.11	0.64
	LTE 5	QPSK10M	Rear Face	20450	1	1	24	24.0	23.48	-0.02	0.589	1.13	0.66
	LTE 5	QPSK10M	Rear Face	20600	1	1	24	24.0	23.42	0.01	0.646	1.14	0.74
	LTE 5	QPSK10M	Rear Face	20525	1	50	0	23.0	22.48	-0.03	0.518	1.13	0.58
	LTE 5	QPSK10M	Rear Face	20525	2	1	24	24.0	23.53	-0.13	0.675	1.11	0.75
	LTE 5	QPSK10M	Rear Face	20525	1	1	24	24.0	23.53	0.06	0.759	1.11	0.85
	LTE 12	QPSK10M	Front Face	23060	1	1	0	24.0	23.58	0.17	0.084	1.10	0.09
23	LTE 12	QPSK10M	Rear Face	23060	1	1	0	24.0	23.58	-0.02	0.407	1.10	0.45
	LTE 12	QPSK10M	Front Face	23060	1	25	0	23.0	22.51	0.02	0.07	1.12	0.08
	LTE 12	QPSK10M	Rear Face	23060	1	25	0	23.0	22.51	-0.11	0.335	1.12	0.38
	LTE 12	QPSK10M	Rear Face	23060	2	1	0	24.0	23.58	-0.09	0.39	1.10	0.43
	LTE 13	QPSK10M	Front Face	23230	1	1	24	24.0	23.68	0.11	0.068	1.08	0.07
24	LTE 13	QPSK10M	Rear Face	23230	1	1	24	24.0	23.68	-0.07	0.396	1.08	0.43
	LTE 13	QPSK10M	Front Face	23230	1	25	12	23.0	22.66	-0.02	0.053	1.08	0.06
	LTE 13	QPSK10M	Rear Face	23230	1	25	12	23.0	22.66	-0.10	0.325	1.08	0.35
	LTE 13	QPSK10M	Rear Face	23230	2	1	24	24.0	23.68	0.04	0.395	1.08	0.43
	LTE 25	QPSK20M	Front Face	26140	1	1	0	23.5	23.15	0.14	0.218	1.08	0.24
25	LTE 25	QPSK20M	Rear Face	26140	1	1	0	23.5	23.15	0.04	0.725	1.08	0.79
	LTE 25	QPSK20M	Front Face	26140	1	50	0	22.5	22.16	0.02	0.166	1.08	0.18
	LTE 25	QPSK20M	Rear Face	26140	1	50	0	22.5	22.16	0.10	0.6	1.08	0.65
	LTE 25	QPSK20M	Rear Face	26140	2	1	0	23.5	23.15	0.08	0.715	1.08	0.78
	LTE 26	QPSK15M	Front Face	26775	1	1	37	24.0	23.28	0.07	0.228	1.18	0.27
	LTE 26	QPSK15M	Rear Face	26775	1	1	37	24.0	23.28	0.02	0.675	1.18	0.80
	LTE 26	QPSK15M	Front Face	26775	1	36	19	23.0	22.29	-0.04	0.184	1.18	0.22
	LTE 26	QPSK15M	Rear Face	26775	1	36	19	23.0	22.29	-0.03	0.536	1.18	0.63
26	LTE 26	QPSK15M	Rear Face	26875	1	1	37	24.0	23.20	0.09	0.749	1.20	0.90
	LTE 26	QPSK15M	Rear Face	26975	1	1	37	24.0	23.16	0.13	0.718	1.21	0.87
	LTE 26	QPSK15M	Rear Face	26875	1	75	0	23.0	22.21	-0.03	0.655	1.20	0.79
	LTE 26	QPSK15M	Rear Face	26875	2	1	37	24.0	23.20	0.16	0.731	1.20	0.88
	LTE 26	QPSK15M	Rear Face	26875	1	1	37	24.0	23.20	0.05	0.741	1.20	0.89

FCC SAR Test Report

Plot No.	Band	Mode	Test Position	Ch.	Battery	RB#	RB Offset	Max. Tune-up Power (dBm)	Measured Conducted Power (dBm)	Power Drift (dB)	Measured SAR-1g (W/kg)	Scaling Factor	Scaled SAR-1g (W/kg)
	LTE 41	QPSK20M	Front Face	39750	1	1	50	24.5	24.01	0.04	0.071	1.12	0.08
27	LTE 41	QPSK20M	Rear Face	39750	1	1	50	24.5	24.01	0.00	0.303	1.12	0.34
	LTE 41	QPSK20M	Front Face	39750	1	50	25	23.5	23.08	-0.03	0.057	1.10	0.06
	LTE 41	QPSK20M	Rear Face	39750	1	50	25	23.5	23.08	0.03	0.237	1.10	0.26
	LTE 41	QPSK20M	Rear Face	39750	2	1	50	24.5	24.01	0.00	0.299	1.12	0.33

Plot No.	Band	Mode	Test Position	Ch.	Battery	Max. Tune-up Power (dBm)	Measured Conducted Power (dBm)	Power Drift (dB)	Measured SAR-1g (W/kg)	Scaling Factor	Scaled SAR-1g (W/kg)
	802.11b	-	Front Face	11	1	18.5	18.14	0.03	0.045	1.09	0.05
28	802.11b	-	Rear Face	11	1	18.5	18.14	0.00	0.088	1.09	0.10
	802.11b	-	Rear Face	11	2	18.5	18.14	0.17	0.081	1.09	0.09

4.7.4 SAR Results for Hotspot Exposure Condition (Separation Distance is 1.0 cm Gap)

Plot No.	Band	Mode	Test Position	Ch.	Battery	Max. Tune-up Power (dBm)	Measured Conducted Power (dBm)	Power Drift (dB)	Measured SAR-1g (W/kg)	Scaling Factor	Scaled SAR-1g (W/kg)
	GSM850	GPRS12	Front Face	251	1	25.5	25.09	-0.01	0.348	1.10	0.38
29	GSM850	GPRS12	Rear Face	251	1	25.5	25.09	-0.16	0.532	1.10	0.58
	GSM850	GPRS12	Left Side	251	1	25.5	25.09	-0.08	0.411	1.10	0.45
	GSM850	GPRS12	Right Side	251	1	25.5	25.09	-0.12	0.429	1.10	0.47
	GSM850	GPRS12	Top Side	251	1	25.5	25.09	-0.02	0.042	1.10	0.05
	GSM850	GPRS12	Bottom Side	251	1	25.5	25.09	0.05	0.201	1.10	0.22
	GSM850	GPRS12	Front Face	251	2	25.5	25.09	-0.05	0.478	1.10	0.53
	GSM1900	GPRS12	Front Face	810	1	24.5	23.90	0.04	0.125	1.15	0.14
30	GSM1900	GPRS12	Rear Face	810	1	24.5	23.90	0.09	0.701	1.15	0.80
	GSM1900	GPRS12	Left Side	810	1	24.5	23.90	0.02	0.209	1.15	0.24
	GSM1900	GPRS12	Right Side	810	1	24.5	23.90	-0.04	0.086	1.15	0.10
	GSM1900	GPRS12	Top Side	810	1	24.5	23.90	0.15	0.046	1.15	0.05
	GSM1900	GPRS12	Bottom Side	810	1	24.5	23.90	0.11	0.511	1.15	0.59
	GSM1900	GPRS12	Rear Face	512	1	24.5	23.65	0.12	0.661	1.22	0.80
	GSM1900	GPRS12	Rear Face	661	1	24.5	23.81	0.10	0.638	1.17	0.75
	GSM1900	GPRS12	Rear Face	810	2	24.5	23.90	-0.03	0.689	1.15	0.79
	GSM1900	GPRS12	Rear Face	810	1	24.5	23.90	-0.02	0.689	1.15	0.79
	CDMA BC0	RTAP 153.6	Front Face	1013	1	22.5	22.03	0.08	0.544	1.11	0.61
	CDMA BC0	RTAP 153.6	Rear Face	1013	1	22.5	22.03	-0.05	0.76	1.11	0.85
	CDMA BC0	RTAP 153.6	Left Side	1013	1	22.5	22.03	-0.05	0.642	1.11	0.72
	CDMA BC0	RTAP 153.6	Right Side	1013	1	22.5	22.03	-0.07	0.671	1.11	0.75
	CDMA BC0	RTAP 153.6	Top Side	1013	1	22.5	22.03	0.16	0.033	1.11	0.04
	CDMA BC0	RTAP 153.6	Bottom Side	1013	1	22.5	22.03	0.06	0.133	1.11	0.15
31	CDMA BC0	RTAP 153.6	Rear Face	384	1	22.5	21.87	-0.11	0.787	1.16	0.91
	CDMA BC0	RTAP 153.6	Rear Face	777	1	22.5	21.85	0.03	0.733	1.16	0.85
	CDMA BC0	RTAP 153.6	Rear Face	384	2	22.5	21.87	-0.03	0.777	1.16	0.90
	CDMA BC0	RTAP 153.6	Rear Face	384	1	22.5	21.87	-0.11	0.779	1.16	0.90

FCC SAR Test Report

Plot No.	Band	Mode	Test Position	Ch.	Battery	Max. Tune-up Power (dBm)	Measured Conducted Power (dBm)	Power Drift (dB)	Measured SAR-1g (W/kg)	Scaling Factor	Scaled SAR-1g (W/kg)
32	CDMA BC1	RTAP 153.6	Front Face	1175	1	22.5	22.01	0.05	0.312	1.12	0.35
	CDMA BC1	RTAP 153.6	Rear Face	1175	1	22.5	22.01	0.10	1.07	1.12	1.20
	CDMA BC1	RTAP 153.6	Left Side	1175	1	22.5	22.01	0.03	0.319	1.12	0.36
	CDMA BC1	RTAP 153.6	Right Side	1175	1	22.5	22.01	0.02	0.131	1.12	0.15
	CDMA BC1	RTAP 153.6	Top Side	1175	1	22.5	22.01	-0.04	0.071	1.12	0.08
	CDMA BC1	RTAP 153.6	Bottom Side	1175	1	22.5	22.01	0.05	0.779	1.12	0.87
	CDMA BC1	RTAP 153.6	Rear Face	25	1	22.5	21.83	0.02	0.88	1.17	1.03
	CDMA BC1	RTAP 153.6	Rear Face	600	1	22.5	21.92	0.08	1.01	1.14	1.15
	CDMA BC1	RTAP 153.6	Bottom Side	25	1	22.5	21.83	0.02	0.641	1.17	0.75
	CDMA BC1	RTAP 153.6	Bottom Side	600	1	22.5	21.92	-0.01	0.801	1.14	0.92
	CDMA BC1	RTAP 153.6	Rear Face	1175	2	22.5	22.01	0.06	1.07	1.12	1.20
CDMA BC1	RTAP 153.6	Rear Face	1175	1	22.5	22.01	0.10	1.06	1.12	1.19	
33	CDMA BC10	RTAP 153.6	Front Face	476	1	22.5	21.77	0.04	0.491	1.18	0.58
	CDMA BC10	RTAP 153.6	Rear Face	476	1	22.5	21.77	0.04	0.9	1.18	1.06
	CDMA BC10	RTAP 153.6	Left Side	476	1	22.5	21.77	-0.02	0.59	1.18	0.70
	CDMA BC10	RTAP 153.6	Right Side	476	1	22.5	21.77	0.08	0.665	1.18	0.79
	CDMA BC10	RTAP 153.6	Top Side	476	1	22.5	21.77	0.12	0.032	1.18	0.04
	CDMA BC10	RTAP 153.6	Bottom Side	476	1	22.5	21.77	0.00	0.11	1.18	0.13
	CDMA BC10	RTAP 153.6	Rear Face	580	1	22.5	21.75	-0.09	0.896	1.19	1.06
	CDMA BC10	RTAP 153.6	Rear Face	684	1	22.5	21.59	-0.11	0.856	1.23	1.06
	CDMA BC10	RTAP 153.6	Rear Face	476	2	22.5	21.77	0.04	0.9	1.18	1.06
	CDMA BC10	RTAP 153.6	Rear Face	476	1	22.5	21.77	0.11	0.889	1.18	1.05

Plot No.	Band	Mode	Test Position	Ch.	Battery	RB#	RB Offset	Max. Tune-up Power (dBm)	Measured Conducted Power (dBm)	Power Drift (dB)	Measured SAR-1g (W/kg)	Scaling Factor	Scaled SAR-1g (W/kg)
34	LTE 2	QPSK20M	Front Face	18700	1	1	50	22.5	22.06	0.03	0.338	1.11	0.37
	LTE 2	QPSK20M	Rear Face	18700	1	1	50	22.5	22.06	0.00	0.895	1.11	0.99
	LTE 2	QPSK20M	Left Side	18700	1	1	50	22.5	22.06	0.02	0.267	1.11	0.30
	LTE 2	QPSK20M	Right Side	18700	1	1	50	22.5	22.06	0.12	0.11	1.11	0.12
	LTE 2	QPSK20M	Top Side	18700	1	1	50	22.5	22.06	0.03	0.059	1.11	0.07
	LTE 2	QPSK20M	Bottom Side	18700	1	1	50	22.5	22.06	0.01	0.655	1.11	0.72
	LTE 2	QPSK20M	Front Face	18700	1	50	0	22.5	22.05	-0.02	0.27	1.11	0.30
	LTE 2	QPSK20M	Rear Face	18700	1	50	0	22.5	22.05	0.14	0.929	1.11	1.03
	LTE 2	QPSK20M	Left Side	18700	1	50	0	22.5	22.05	0.00	0.209	1.11	0.23
	LTE 2	QPSK20M	Right Side	18700	1	50	0	22.5	22.05	0.09	0.085	1.11	0.09
	LTE 2	QPSK20M	Top Side	18700	1	50	0	22.5	22.05	-0.01	0.048	1.11	0.05
	LTE 2	QPSK20M	Bottom Side	18700	1	50	0	22.5	22.05	0.01	0.679	1.11	0.75
	LTE 2	QPSK20M	Rear Face	18900	1	1	50	22.5	21.93	0.03	0.962	1.14	1.10
	LTE 2	QPSK20M	Rear Face	19100	1	1	50	22.5	21.95	0.03	1.09	1.14	1.24
	LTE 2	QPSK20M	Rear Face	18900	1	50	0	22.5	21.92	0.19	1.01	1.14	1.15
	LTE 2	QPSK20M	Rear Face	19100	1	50	0	22.5	21.94	0.09	1.09	1.14	1.24
	LTE 2	QPSK20M	Rear Face	18700	1	100	0	22.5	22.03	0.19	0.92	1.11	1.03
	LTE 2	QPSK20M	Rear Face	19100	2	1	50	22.5	21.95	0.08	1.08	1.14	1.23
LTE 2	QPSK20M	Rear Face	19100	1	1	50	22.5	21.95	0.03	1.08	1.14	1.23	

FCC SAR Test Report

Plot No.	Band	Mode	Test Position	Ch.	Battery	RB#	RB Offset	Max. Tune-up Power (dBm)	Measured Conducted Power (dBm)	Power Drift (dB)	Measured SAR-1g (W/kg)	Scaling Factor	Scaled SAR-1g (W/kg)
35	LTE 4	QPSK20M	Front Face	20050	1	1	0	23.0	22.66	-0.12	0.44	1.08	0.48
	LTE 4	QPSK20M	Rear Face	20050	1	1	0	23.0	22.66	0.07	1.04	1.08	1.12
	LTE 4	QPSK20M	Left Side	20050	1	1	0	23.0	22.66	0.06	0.343	1.08	0.37
	LTE 4	QPSK20M	Right Side	20050	1	1	0	23.0	22.66	0.07	0.165	1.08	0.18
	LTE 4	QPSK20M	Top Side	20050	1	1	0	23.0	22.66	0.03	0.069	1.08	0.07
	LTE 4	QPSK20M	Bottom Side	20050	1	1	0	23.0	22.66	0.02	0.721	1.08	0.78
	LTE 4	QPSK20M	Front Face	20050	1	50	0	23.0	22.63	-0.06	0.31	1.09	0.34
	LTE 4	QPSK20M	Rear Face	20050	1	50	0	23.0	22.63	-0.01	0.899	1.09	0.98
	LTE 4	QPSK20M	Left Side	20050	1	50	0	23.0	22.63	-0.03	0.277	1.09	0.30
	LTE 4	QPSK20M	Right Side	20050	1	50	0	23.0	22.63	0.06	0.126	1.09	0.14
	LTE 4	QPSK20M	Top Side	20050	1	50	0	23.0	22.63	0.09	0.051	1.09	0.06
	LTE 4	QPSK20M	Bottom Side	20050	1	50	0	23.0	22.63	0.02	0.584	1.09	0.64
LTE 4	QPSK20M	Rear Face	20175	1	1	0	23.0	22.42	-0.05	0.945	1.14	1.08	
LTE 4	QPSK20M	Rear Face	20300	1	1	0	23.0	22.45	0.13	0.944	1.14	1.07	
LTE 4	QPSK20M	Rear Face	20175	1	50	0	23.0	22.39	0.07	0.914	1.15	1.05	
LTE 4	QPSK20M	Rear Face	20300	1	50	0	23.0	22.42	0.05	0.945	1.14	1.08	
LTE 4	QPSK20M	Rear Face	20050	1	100	0	23.0	22.58	0.12	0.931	1.10	1.03	
LTE 4	QPSK20M	Rear Face	20050	2	1	0	23.0	22.66	-0.05	1.02	1.08	1.10	
LTE 4	QPSK20M	Rear Face	20050	1	1	0	23.0	22.66	-0.01	1.03	1.08	1.11	
36	LTE 5	QPSK10M	Front Face	20525	1	1	24	24.0	23.53	-0.15	0.343	1.11	0.38
	LTE 5	QPSK10M	Rear Face	20525	1	1	24	24.0	23.53	0.03	0.973	1.11	1.08
	LTE 5	QPSK10M	Left Side	20525	1	1	24	24.0	23.53	-0.19	0.498	1.11	0.55
	LTE 5	QPSK10M	Right Side	20525	1	1	24	24.0	23.53	-0.06	0.579	1.11	0.65
	LTE 5	QPSK10M	Top Side	20525	1	1	24	24.0	23.53	0.02	0.029	1.11	0.03
	LTE 5	QPSK10M	Bottom Side	20525	1	1	24	24.0	23.53	0.01	0.165	1.11	0.18
	LTE 5	QPSK10M	Front Face	20525	1	25	12	23.0	22.55	-0.02	0.325	1.11	0.36
	LTE 5	QPSK10M	Rear Face	20525	1	25	12	23.0	22.55	0.06	0.785	1.11	0.87
	LTE 5	QPSK10M	Left Side	20525	1	25	12	23.0	22.55	0.01	0.472	1.11	0.52
	LTE 5	QPSK10M	Right Side	20525	1	25	12	23.0	22.55	-0.06	0.549	1.11	0.61
	LTE 5	QPSK10M	Top Side	20525	1	25	12	23.0	22.55	0.01	0.027	1.11	0.03
	LTE 5	QPSK10M	Bottom Side	20525	1	25	12	23.0	22.55	0.01	0.156	1.11	0.17
	LTE 5	QPSK10M	Rear Face	20450	1	1	24	24.0	23.48	0.03	1.01	1.13	1.14
	LTE 5	QPSK10M	Rear Face	20600	1	1	24	24.0	23.42	-0.05	0.935	1.14	1.07
	LTE 5	QPSK10M	Rear Face	20450	1	25	12	23.0	22.50	-0.09	0.754	1.12	0.85
	LTE 5	QPSK10M	Rear Face	20600	1	25	12	23.0	22.44	-0.02	0.693	1.14	0.79
	LTE 5	QPSK10M	Rear Face	20525	1	50	0	23.0	22.48	0.02	0.787	1.13	0.89
	LTE 5	QPSK10M	Rear Face	20450	2	1	24	24.0	23.48	0.02	0.846	1.13	0.95
LTE 5	QPSK10M	Rear Face	20450	1	1	24	24.0	23.48	0.11	0.848	1.13	0.96	
37	LTE 12	QPSK10M	Front Face	23060	1	1	24	24.0	23.58	0.00	0.132	1.10	0.15
	LTE 12	QPSK10M	Rear Face	23060	1	1	24	24.0	23.58	-0.01	0.698	1.10	0.77
	LTE 12	QPSK10M	Left Side	23060	1	1	24	24.0	23.58	0.10	0.168	1.10	0.19
	LTE 12	QPSK10M	Right Side	23060	1	1	24	24.0	23.58	0.05	0.197	1.10	0.22
	LTE 12	QPSK10M	Top Side	23060	1	1	24	24.0	23.58	-0.15	0.012	1.10	0.01
	LTE 12	QPSK10M	Bottom Side	23060	1	1	24	24.0	23.58	0.13	0.132	1.10	0.15
	LTE 12	QPSK10M	Front Face	23060	1	25	0	23.0	22.51	-0.01	0.104	1.12	0.12
	LTE 12	QPSK10M	Rear Face	23060	1	25	0	23.0	22.51	-0.02	0.553	1.12	0.62
	LTE 12	QPSK10M	Left Side	23060	1	25	0	23.0	22.51	0.03	0.133	1.12	0.15
	LTE 12	QPSK10M	Right Side	23060	1	25	0	23.0	22.51	-0.12	0.156	1.12	0.17
	LTE 12	QPSK10M	Top Side	23060	1	25	0	23.0	22.51	0.15	0.008	1.12	0.01
	LTE 12	QPSK10M	Bottom Side	23060	1	25	0	23.0	22.51	0.01	0.104	1.12	0.12
LTE 12	QPSK10M	Rear Face	23060	2	1	24	24.0	23.58	-0.15	0.688	1.10	0.76	

FCC SAR Test Report

Plot No.	Band	Mode	Test Position	Ch.	Battery	RB#	RB Offset	Max. Tune-up Power (dBm)	Measured Conducted Power (dBm)	Power Drift (dB)	Measured SAR-1g (W/kg)	Scaling Factor	Scaled SAR-1g (W/kg)
	LTE 13	QPSK10M	Front Face	23230	1	1	24	24.0	23.68	-0.02	0.111	1.08	0.12
38	LTE 13	QPSK10M	Rear Face	23230	1	1	24	24.0	23.68	-0.08	0.636	1.08	0.68
	LTE 13	QPSK10M	Left Side	23230	1	1	24	24.0	23.68	0.03	0.192	1.08	0.21
	LTE 13	QPSK10M	Right Side	23230	1	1	24	24.0	23.68	-0.09	0.209	1.08	0.22
	LTE 13	QPSK10M	Top Side	23230	1	1	24	24.0	23.68	0.06	0.012	1.08	0.01
	LTE 13	QPSK10M	Bottom Side	23230	1	1	24	24.0	23.68	0.17	0.114	1.08	0.12
	LTE 13	QPSK10M	Front Face	23230	1	25	12	23.0	22.66	-0.02	0.085	1.08	0.09
	LTE 13	QPSK10M	Rear Face	23230	1	25	12	23.0	22.66	-0.03	0.488	1.08	0.53
	LTE 13	QPSK10M	Left Side	23230	1	25	12	23.0	22.66	0.01	0.147	1.08	0.16
	LTE 13	QPSK10M	Right Side	23230	1	25	12	23.0	22.66	0.02	0.161	1.08	0.17
	LTE 13	QPSK10M	Top Side	23230	1	25	12	23.0	22.66	-0.04	0.009	1.08	0.01
	LTE 13	QPSK10M	Bottom Side	23230	1	25	12	23.0	22.66	0.16	0.087	1.08	0.09
	LTE 13	QPSK10M	Rear Face	23230	2	1	24	24.0	23.68	-0.01	0.629	1.08	0.68
	LTE 25	QPSK20M	Front Face	26365	1	1	0	22.5	22.15	0.00	0.302	1.08	0.33
	LTE 25	QPSK20M	Rear Face	26365	1	1	0	22.5	22.15	0.07	0.953	1.08	1.03
	LTE 25	QPSK20M	Left Side	26365	1	1	0	22.5	22.15	0.01	0.288	1.08	0.31
	LTE 25	QPSK20M	Right Side	26365	1	1	0	22.5	22.15	0.17	0.116	1.08	0.13
	LTE 25	QPSK20M	Top Side	26365	1	1	0	22.5	22.15	-0.03	0.05	1.08	0.05
	LTE 25	QPSK20M	Bottom Side	26365	1	1	0	22.5	22.15	0.04	0.598	1.08	0.65
	LTE 25	QPSK20M	Front Face	26365	1	50	0	22.5	22.12	0.08	0.214	1.09	0.23
	LTE 25	QPSK20M	Rear Face	26365	1	50	0	22.5	22.12	0.04	1	1.09	1.09
	LTE 25	QPSK20M	Left Side	26365	1	50	0	22.5	22.12	-0.08	0.244	1.09	0.27
	LTE 25	QPSK20M	Right Side	26365	1	50	0	22.5	22.12	0.11	0.092	1.09	0.10
	LTE 25	QPSK20M	Top Side	26365	1	50	0	22.5	22.12	-0.13	0.042	1.09	0.05
	LTE 25	QPSK20M	Bottom Side	26365	1	50	0	22.5	22.12	0.01	0.476	1.09	0.52
	LTE 25	QPSK20M	Rear Face	26140	1	1	0	22.5	21.91	-0.09	0.861	1.15	0.99
	LTE 25	QPSK20M	Rear Face	26590	1	1	0	22.5	21.83	0.01	1.02	1.17	1.19
	LTE 25	QPSK20M	Rear Face	26140	1	50	0	22.5	21.88	0.06	0.89	1.15	1.03
39	LTE 25	QPSK20M	Rear Face	26590	1	50	0	22.5	21.80	0.10	1.06	1.17	1.25
	LTE 25	QPSK20M	Rear Face	26365	1	100	0	22.5	22.01	0.01	0.996	1.12	1.11
	LTE 25	QPSK20M	Rear Face	26590	2	50	0	22.5	21.80	0.00	1.03	1.17	1.21
	LTE 25	QPSK20M	Rear Face	26590	1	50	0	22.5	21.80	0.15	1.04	1.17	1.22
	LTE 26	QPSK15M	Front Face	26865	1	1	37	24.0	23.28	-0.17	0.117	1.18	0.14
	LTE 26	QPSK15M	Rear Face	26865	1	1	37	24.0	23.28	-0.16	0.966	1.18	1.14
	LTE 26	QPSK15M	Left Side	26865	1	1	37	24.0	23.28	0.15	0.409	1.18	0.48
	LTE 26	QPSK15M	Right Side	26865	1	1	37	24.0	23.28	0.09	0.424	1.18	0.50
	LTE 26	QPSK15M	Top Side	26865	1	1	37	24.0	23.28	0.06	0.024	1.18	0.03
	LTE 26	QPSK15M	Bottom Side	26865	1	1	37	24.0	23.28	0.07	0.103	1.18	0.12
	LTE 26	QPSK15M	Front Face	26865	1	36	19	23.0	22.29	-0.03	0.079	1.18	0.09
	LTE 26	QPSK15M	Rear Face	26865	1	36	19	23.0	22.29	-0.01	0.653	1.18	0.77
	LTE 26	QPSK15M	Left Side	26865	1	36	19	23.0	22.29	0.01	0.276	1.18	0.33
	LTE 26	QPSK15M	Right Side	26865	1	36	19	23.0	22.29	0.02	0.287	1.18	0.34
	LTE 26	QPSK15M	Top Side	26865	1	36	19	23.0	22.29	0.01	0.016	1.18	0.02
	LTE 26	QPSK15M	Bottom Side	26865	1	36	19	23.0	22.29	0.00	0.069	1.18	0.08
	LTE 26	QPSK15M	Rear Face	26765	1	1	37	24.0	23.20	0.02	1.02	1.20	1.23
40	LTE 26	QPSK15M	Rear Face	26965	1	1	37	24.0	23.16	0.00	1.01	1.21	1.23
	LTE 26	QPSK15M	Rear Face	26865	1	75	0	23.0	22.21	0.02	0.625	1.20	0.75
	LTE 26	QPSK15M	Rear Face	26965	2	1	37	24.0	23.16	0.06	0.999	1.21	1.21
	LTE 26	QPSK15M	Rear Face	26965	1	1	37	24.0	23.16	0.03	1	1.21	1.21

FCC SAR Test Report

Plot No.	Band	Mode	Test Position	Ch.	Battery	RB#	RB Offset	Max. Tune-up Power (dBm)	Measured Conducted Power (dBm)	Power Drift (dB)	Measured SAR-1g (W/kg)	Scaling Factor	Scaled SAR-1g (W/kg)
	LTE 41	QPSK20M	Front Face	39750	1	1	50	24.5	24.01	0.07	0.097	1.12	0.11
41	LTE 41	QPSK20M	Rear Face	39750	1	1	50	24.5	24.01	0.11	0.419	1.12	0.47
	LTE 41	QPSK20M	Left Side	39750	1	1	50	24.5	24.01	0.05	0.185	1.12	0.21
	LTE 41	QPSK20M	Right Side	39750	1	1	50	24.5	24.01	0.07	0.074	1.12	0.08
	LTE 41	QPSK20M	Top Side	39750	1	1	50	24.5	24.01	0.03	0.038	1.12	0.04
	LTE 41	QPSK20M	Bottom Side	39750	1	1	50	24.5	24.01	0.03	0.112	1.12	0.13
	LTE 41	QPSK20M	Front Face	39750	1	50	25	23.5	23.08	-0.02	0.078	1.10	0.09
	LTE 41	QPSK20M	Rear Face	39750	1	50	25	23.5	23.08	-0.06	0.305	1.10	0.34
	LTE 41	QPSK20M	Left Side	39750	1	50	25	23.5	23.08	0.03	0.148	1.10	0.16
	LTE 41	QPSK20M	Right Side	39750	1	50	25	23.5	23.08	0.01	0.059	1.10	0.06
	LTE 41	QPSK20M	Top Side	39750	1	50	25	23.5	23.08	-0.15	0.031	1.10	0.03
	LTE 41	QPSK20M	Bottom Side	39750	1	50	25	23.5	23.08	0.10	0.089	1.10	0.10
	LTE 41	QPSK20M	Rear Face	39750	2	1	50	24.5	24.01	0.00	0.381	1.12	0.43

Plot No.	Band	Mode	Test Position	Ch.	Battery	Max. Tune-up Power (dBm)	Measured Conducted Power (dBm)	Power Drift (dB)	Measured SAR-1g (W/kg)	Scaling Factor	Scaled SAR-1g (W/kg)
	802.11b	-	Front Face	11	1	18.5	18.14	0.09	0.063	1.09	0.07
42	802.11b	-	Rear Face	11	1	18.5	18.14	0.12	0.122	1.09	0.13
	802.11b	-	Left Side	11	1	18.5	18.14	-0.07	0.032	1.09	0.03
	802.11b	-	Right Side	11	1	18.5	18.14	0.14	0.121	1.09	0.13
	802.11b	-	Top Side	11	1	18.5	18.14	0.19	0.043	1.09	0.05
	802.11b	-	Bottom Side	11	1	18.5	18.14	0.10	0.034	1.09	0.04
	802.11b	-	Rear Face	11	2	18.5	18.14	0.01	0.122	1.09	0.13

FCC SAR Test Report

4.7.5 SAR Measurement Variability

According to KDB 865664 D01, SAR measurement variability was assessed for each frequency band, which is determined by the SAR probe calibration point and tissue-equivalent medium used for the device measurements. When both head and body tissue-equivalent media are required for SAR measurements in a frequency band, the variability measurement procedures should be applied to the tissue medium with the highest measured SAR, using the highest measured SAR configuration for that tissue-equivalent medium. Alternatively, if the highest measured SAR for both head and body tissue-equivalent media are ≤ 1.45 W/kg and the ratio of these highest SAR values, i.e., largest divided by smallest value, is ≤ 1.10 , the highest SAR configuration for either head or body tissue-equivalent medium may be used to perform the repeated measurement. These additional measurements are repeated after the completion of all measurements requiring the same head or body tissue-equivalent medium in a frequency band. The test device should be returned to ambient conditions (normal room temperature) with the battery fully charged before it is re-mounted on the device holder for the repeated measurement(s) to minimize any unexpected variations in the repeated results.

SAR repeated measurement procedure:

1. When the highest measured SAR is < 0.80 W/kg, repeated measurement is not required.
2. When the highest measured SAR is ≥ 0.80 W/kg, repeat that measurement once.
3. If the ratio of largest to smallest SAR for the original and first repeated measurements is > 1.20 , or when the original or repeated measurement is ≥ 1.45 W/kg, perform a second repeated measurement.
4. If the ratio of largest to smallest SAR for the original, first and second repeated measurements is > 1.20 , and the original, first or second repeated measurement is ≥ 1.5 W/kg, perform a third repeated measurement.

Band	Mode	Test Position	Ch.	Original Measured SAR-1g (W/kg)	1st Repeated SAR-1g (W/kg)	L/S Ratio	2nd Repeated SAR-1g (W/kg)	L/S Ratio	3rd Repeated SAR-1g (W/kg)	L/S Ratio
GSM850	GPRS12	Rear Face	189	1.1	1.09	1.01	N/A	N/A	N/A	N/A
GSM1900	GPRS12	Rear Face	810	0.701	0.689	1.02	N/A	N/A	N/A	N/A
CDMA BC0	RC3+SO32	Rear Face	1013	0.994	0.989	1.01	N/A	N/A	N/A	N/A
CDMA BC0	RTAP 153.6	Rear Face	384	0.787	0.779	1.01	N/A	N/A	N/A	N/A
CDMA BC1	RC3+SO32	Rear Face	25	1.03	1	1.03	N/A	N/A	N/A	N/A
CDMA BC1	RTAP 153.6	Rear Face	1175	1.07	1.06	1.01	N/A	N/A	N/A	N/A
CDMA BC10	RC3+SO32	Rear Face	476	0.935	0.928	1.01	N/A	N/A	N/A	N/A
LTE 2	QPSK20M	Rear Face	19100	0.81	0.791	1.02	N/A	N/A	N/A	N/A
LTE 4	QPSK20M	Rear Face	20050	1.04	1.03	1.01	N/A	N/A	N/A	N/A
LTE 5	QPSK10M	Rear Face	20525	0.763	0.759	1.01	N/A	N/A	N/A	N/A
LTE 5	QPSK10M	Rear Face	20450	1.01	0.848	1.19	N/A	N/A	N/A	N/A
LTE 25	QPSK20M	Rear Face	26590	1.06	1.04	1.02	N/A	N/A	N/A	N/A
LTE 26	QPSK15M	Rear Face	26875	0.749	0.741	1.01	N/A	N/A	N/A	N/A
LTE 26	QPSK15M	Rear Face	26965	1.01	1	1.01	N/A	N/A	N/A	N/A
LTE 26	QPSK15M	Right Cheek	26865	0.681	0.672	1.01	N/A	N/A	N/A	N/A

4.7.6 Simultaneous Multi-band Transmission Evaluation

<Estimated SAR Calculation>

According to KDB 447498 D01, when standalone SAR test exclusion applies to an antenna that transmits simultaneously with other antennas, the standalone SAR was estimated according to following formula to result in substantially conservative SAR values of <= 0.4 W/kg to determine simultaneous transmission SAR test exclusion.

$$\text{Estimated SAR} = \frac{\text{Max. Tune up Power}_{(mW)}}{\text{Min. Test Separation Distance}_{(mm)}} \times \frac{\sqrt{f_{(GHz)}}}{7.5}$$

If the minimum test separation distance is < 5 mm, a distance of 5 mm is used for estimated SAR calculation. When the test separation distance is > 50 mm, the 0.4 W/kg is used for SAR-1g.

Mode / Band	Frequency (GHz)	Max. Tune-up Power (dBm)	Test Position	Separation Distance (mm)	Estimated SAR (W/kg)
BT (DSS)	2.48	1.0	Body-worn	15	0.02

Note:

1. The separation distance is determined from the outer housing of the EUT to the user.
2. When standalone SAR testing is not required, an estimated SAR can be applied to determine simultaneous transmission SAR test exclusion.

FCC SAR Test Report

<SAR Summation Analysis>

Simultaneous transmission SAR test exclusion is determined for each operating configuration and exposure condition according to the reported standalone SAR of each applicable simultaneous transmitting antenna. When the sum of SAR_{1g} of all simultaneously transmitting antennas in an operating mode and exposure condition combination is within the SAR limit (SAR_{1g} 1.6 W/kg), the simultaneous transmission SAR is not required. When the sum of SAR_{1g} is greater than the SAR limit (SAR_{1g} 1.6 W/kg), SAR test exclusion is determined by the SPLSR.

No.	Conditions (SAR1 + SAR2)	Exposure Condition	Test Position	Max. SAR1	Max. SAR2	SAR Summation	SPLSR Analysis
1	GSM 850 + WLAN (DTS)	Head	Right Cheek	0.28	0.22	0.50	∑ SAR < 1.6, Not required
			Right Tilted	0.11	0.03	0.14	∑ SAR < 1.6, Not required
			Left Cheek	0.17	0.09	0.26	∑ SAR < 1.6, Not required
			Left Tilted	0.08	0.04	0.12	∑ SAR < 1.6, Not required
		Body-Worn	Front Face	0.51	0.05	0.56	∑ SAR < 1.6, Not required
			Rear Face	1.25	0.10	1.35	∑ SAR < 1.6, Not required
		Hotspot	Front Face	0.38	0.07	0.45	∑ SAR < 1.6, Not required
			Rear Face	0.58	0.13	0.71	∑ SAR < 1.6, Not required
			Left Side	0.45	0.03	0.48	∑ SAR < 1.6, Not required
			Right Side	0.47	0.13	0.60	∑ SAR < 1.6, Not required
			Top Side	0.05	0.05	0.10	∑ SAR < 1.6, Not required
			Bottom Side	0.22	0.04	0.26	∑ SAR < 1.6, Not required
2	GSM 850 + BT (DSS)	Body-Worn	Front Face	0.51	0.02	0.53	∑ SAR < 1.6, Not required
			Rear Face	1.25	0.02	1.27	∑ SAR < 1.6, Not required

FCC SAR Test Report

No.	Conditions (SAR1 + SAR2)	Exposure Condition	Test Position	Max. SAR1	Max. SAR2	SAR Summation	SPLSR Analysis
3	GSM 1900 + WLAN (DTS)	Head	Right Cheek	0.23	0.22	0.45	Σ SAR < 1.6, Not required
			Right Tilted	0.13	0.03	0.16	Σ SAR < 1.6, Not required
			Left Cheek	0.31	0.09	0.40	Σ SAR < 1.6, Not required
			Left Tilted	0.14	0.04	0.18	Σ SAR < 1.6, Not required
		Body-Worn	Front Face	0.09	0.05	0.14	Σ SAR < 1.6, Not required
			Rear Face	0.43	0.10	0.53	Σ SAR < 1.6, Not required
		Hotspot	Front Face	0.14	0.07	0.21	Σ SAR < 1.6, Not required
			Rear Face	0.80	0.13	0.93	Σ SAR < 1.6, Not required
			Left Side	0.24	0.03	0.27	Σ SAR < 1.6, Not required
			Right Side	0.10	0.13	0.23	Σ SAR < 1.6, Not required
			Top Side	0.05	0.05	0.10	Σ SAR < 1.6, Not required
			Bottom Side	0.59	0.04	0.63	Σ SAR < 1.6, Not required
4	GSM 1900 + BT (DSS)	Body-Worn	Front Face	0.09	0.02	0.11	Σ SAR < 1.6, Not required
			Rear Face	0.43	0.02	0.45	Σ SAR < 1.6, Not required

No.	Conditions (SAR1 + SAR2)	Exposure Condition	Test Position	Max. SAR1	Max. SAR2	SAR Summation	SPLSR Analysis
5	CDMA BC0 + WLAN (DTS)	Head	Right Cheek	0.21	0.22	0.43	Σ SAR < 1.6, Not required
			Right Tilted	0.06	0.03	0.09	Σ SAR < 1.6, Not required
			Left Cheek	0.15	0.09	0.24	Σ SAR < 1.6, Not required
			Left Tilted	0.04	0.04	0.08	Σ SAR < 1.6, Not required
		Body-Worn	Front Face	0.46	0.05	0.51	Σ SAR < 1.6, Not required
			Rear Face	1.03	0.10	1.13	Σ SAR < 1.6, Not required
		Hotspot	Front Face	0.61	0.07	0.68	Σ SAR < 1.6, Not required
			Rear Face	0.91	0.13	1.04	Σ SAR < 1.6, Not required
			Left Side	0.72	0.03	0.75	Σ SAR < 1.6, Not required
			Right Side	0.75	0.13	0.88	Σ SAR < 1.6, Not required
			Top Side	0.04	0.05	0.09	Σ SAR < 1.6, Not required
			Bottom Side	0.15	0.04	0.19	Σ SAR < 1.6, Not required
6	CDMA BC0 + BT (DSS)	Body-Worn	Front Face	0.46	0.02	0.48	Σ SAR < 1.6, Not required
			Rear Face	1.03	0.02	1.05	Σ SAR < 1.6, Not required

FCC SAR Test Report

No.	Conditions (SAR1 + SAR2)	Exposure Condition	Test Position	Max. SAR1	Max. SAR2	SAR Summation	SPLSR Analysis
7	CDMA BC1 + WLAN (DTS)	Head	Right Cheek	0.14	0.22	0.36	Σ SAR < 1.6, Not required
			Right Tilted	0.10	0.03	0.13	Σ SAR < 1.6, Not required
			Left Cheek	0.19	0.09	0.28	Σ SAR < 1.6, Not required
			Left Tilted	0.11	0.04	0.15	Σ SAR < 1.6, Not required
		Body-Worn	Front Face	0.23	0.05	0.28	Σ SAR < 1.6, Not required
			Rear Face	1.17	0.10	1.27	Σ SAR < 1.6, Not required
		Hotspot	Front Face	0.35	0.07	0.42	Σ SAR < 1.6, Not required
			Rear Face	1.20	0.13	1.33	Σ SAR < 1.6, Not required
			Left Side	0.36	0.03	0.39	Σ SAR < 1.6, Not required
			Right Side	0.15	0.13	0.28	Σ SAR < 1.6, Not required
			Top Side	0.08	0.05	0.13	Σ SAR < 1.6, Not required
		Bottom Side	0.92	0.04	0.96	Σ SAR < 1.6, Not required	
8	CDMA BC1 + BT (DSS)	Body-Worn	Front Face	0.23	0.02	0.25	Σ SAR < 1.6, Not required
			Rear Face	1.17	0.02	1.19	Σ SAR < 1.6, Not required

No.	Conditions (SAR1 + SAR2)	Exposure Condition	Test Position	Max. SAR1	Max. SAR2	SAR Summation	SPLSR Analysis
9	CDMA BC10 + WLAN (DTS)	Head	Right Cheek	0.22	0.22	0.44	Σ SAR < 1.6, Not required
			Right Tilted	0.06	0.03	0.09	Σ SAR < 1.6, Not required
			Left Cheek	0.16	0.09	0.25	Σ SAR < 1.6, Not required
			Left Tilted	0.04	0.04	0.08	Σ SAR < 1.6, Not required
		Body-Worn	Front Face	0.44	0.05	0.49	Σ SAR < 1.6, Not required
			Rear Face	1.05	0.10	1.15	Σ SAR < 1.6, Not required
		Hotspot	Front Face	0.58	0.07	0.65	Σ SAR < 1.6, Not required
			Rear Face	1.06	0.13	1.19	Σ SAR < 1.6, Not required
			Left Side	0.70	0.03	0.73	Σ SAR < 1.6, Not required
			Right Side	0.79	0.13	0.92	Σ SAR < 1.6, Not required
			Top Side	0.04	0.05	0.09	Σ SAR < 1.6, Not required
		Bottom Side	0.13	0.04	0.17	Σ SAR < 1.6, Not required	
10	CDMA BC10 + BT (DSS)	Body-Worn	Front Face	0.44	0.02	0.46	Σ SAR < 1.6, Not required
			Rear Face	1.05	0.02	1.07	Σ SAR < 1.6, Not required

FCC SAR Test Report

No.	Conditions (SAR1 + SAR2)	Exposure Condition	Test Position	Max. SAR1	Max. SAR2	SAR Summation	SPLSR Analysis
11	LTE 2 + WLAN (DTS)	Head	Right Cheek	0.16	0.22	0.38	Σ SAR < 1.6, Not required
			Right Tilted	0.09	0.03	0.12	Σ SAR < 1.6, Not required
			Left Cheek	0.19	0.09	0.28	Σ SAR < 1.6, Not required
			Left Tilted	0.10	0.04	0.14	Σ SAR < 1.6, Not required
		Body-Worn	Front Face	0.19	0.05	0.24	Σ SAR < 1.6, Not required
			Rear Face	0.86	0.10	0.96	Σ SAR < 1.6, Not required
		Hotspot	Front Face	0.37	0.07	0.44	Σ SAR < 1.6, Not required
			Rear Face	1.24	0.13	1.37	Σ SAR < 1.6, Not required
			Left Side	0.30	0.03	0.33	Σ SAR < 1.6, Not required
			Right Side	0.12	0.13	0.25	Σ SAR < 1.6, Not required
			Top Side	0.07	0.05	0.12	Σ SAR < 1.6, Not required
		Bottom Side	0.75	0.04	0.79	Σ SAR < 1.6, Not required	
12	LTE 2 + BT (DSS)	Body-Worn	Front Face	0.19	0.02	0.21	Σ SAR < 1.6, Not required
			Rear Face	0.86	0.02	0.88	Σ SAR < 1.6, Not required

No.	Conditions (SAR1 + SAR2)	Exposure Condition	Test Position	Max. SAR1	Max. SAR2	SAR Summation	SPLSR Analysis
13	LTE 4 + WLAN (DTS)	Head	Right Cheek	0.14	0.22	0.36	Σ SAR < 1.6, Not required
			Right Tilted	0.10	0.03	0.13	Σ SAR < 1.6, Not required
			Left Cheek	0.18	0.09	0.27	Σ SAR < 1.6, Not required
			Left Tilted	0.16	0.04	0.20	Σ SAR < 1.6, Not required
		Body-Worn	Front Face	0.29	0.05	0.34	Σ SAR < 1.6, Not required
			Rear Face	0.71	0.10	0.81	Σ SAR < 1.6, Not required
		Hotspot	Front Face	0.48	0.07	0.55	Σ SAR < 1.6, Not required
			Rear Face	1.12	0.13	1.25	Σ SAR < 1.6, Not required
			Left Side	0.37	0.03	0.40	Σ SAR < 1.6, Not required
			Right Side	0.78	0.13	0.91	Σ SAR < 1.6, Not required
			Top Side	0.07	0.05	0.12	Σ SAR < 1.6, Not required
		Bottom Side	0.78	0.04	0.82	Σ SAR < 1.6, Not required	
14	LTE 4 + BT (DSS)	Body-Worn	Front Face	0.29	0.02	0.31	Σ SAR < 1.6, Not required
			Rear Face	0.71	0.02	0.73	Σ SAR < 1.6, Not required

FCC SAR Test Report

No.	Conditions (SAR1 + SAR2)	Exposure Condition	Test Position	Max. SAR1	Max. SAR2	SAR Summation	SPLSR Analysis
15	LTE 5 + WLAN (DTS)	Head	Right Cheek	0.79	0.22	1.01	Σ SAR < 1.6, Not required
			Right Tilted	0.38	0.03	0.41	Σ SAR < 1.6, Not required
			Left Cheek	0.72	0.09	0.81	Σ SAR < 1.6, Not required
			Left Tilted	0.40	0.04	0.44	Σ SAR < 1.6, Not required
		Body-Worn	Front Face	0.40	0.05	0.45	Σ SAR < 1.6, Not required
			Rear Face	0.85	0.10	0.95	Σ SAR < 1.6, Not required
		Hotspot	Front Face	0.38	0.07	0.45	Σ SAR < 1.6, Not required
			Rear Face	1.14	0.13	1.27	Σ SAR < 1.6, Not required
			Left Side	0.55	0.03	0.58	Σ SAR < 1.6, Not required
			Right Side	0.65	0.13	0.78	Σ SAR < 1.6, Not required
			Top Side	0.03	0.05	0.08	Σ SAR < 1.6, Not required
		Bottom Side	0.18	0.04	0.22	Σ SAR < 1.6, Not required	
16	LTE 5 + BT (DSS)	Body-Worn	Front Face	0.40	0.02	0.42	Σ SAR < 1.6, Not required
			Rear Face	0.85	0.02	0.87	Σ SAR < 1.6, Not required

No.	Conditions (SAR1 + SAR2)	Exposure Condition	Test Position	Max. SAR1	Max. SAR2	SAR Summation	SPLSR Analysis
17	LTE 12 + WLAN (DTS)	Head	Right Cheek	0.50	0.22	0.72	Σ SAR < 1.6, Not required
			Right Tilted	0.23	0.03	0.26	Σ SAR < 1.6, Not required
			Left Cheek	0.46	0.09	0.55	Σ SAR < 1.6, Not required
			Left Tilted	0.26	0.04	0.30	Σ SAR < 1.6, Not required
		Body-Worn	Front Face	0.09	0.05	0.14	Σ SAR < 1.6, Not required
			Rear Face	0.45	0.10	0.55	Σ SAR < 1.6, Not required
		Hotspot	Front Face	0.15	0.07	0.22	Σ SAR < 1.6, Not required
			Rear Face	0.77	0.13	0.90	Σ SAR < 1.6, Not required
			Left Side	0.19	0.03	0.22	Σ SAR < 1.6, Not required
			Right Side	0.22	0.13	0.35	Σ SAR < 1.6, Not required
			Top Side	0.01	0.05	0.06	Σ SAR < 1.6, Not required
		Bottom Side	0.15	0.04	0.19	Σ SAR < 1.6, Not required	
18	LTE 12 + BT (DSS)	Body-Worn	Front Face	0.09	0.02	0.11	Σ SAR < 1.6, Not required
			Rear Face	0.45	0.02	0.47	Σ SAR < 1.6, Not required

FCC SAR Test Report

No.	Conditions (SAR1 + SAR2)	Exposure Condition	Test Position	Max. SAR1	Max. SAR2	SAR Summation	SPLSR Analysis
19	LTE 13 + WLAN (DTS)	Head	Right Cheek	0.49	0.22	0.71	Σ SAR < 1.6, Not required
			Right Tilted	0.26	0.03	0.29	Σ SAR < 1.6, Not required
			Left Cheek	0.49	0.09	0.58	Σ SAR < 1.6, Not required
			Left Tilted	0.26	0.04	0.30	Σ SAR < 1.6, Not required
		Body-Worn	Front Face	0.07	0.05	0.12	Σ SAR < 1.6, Not required
			Rear Face	0.43	0.10	0.53	Σ SAR < 1.6, Not required
		Hotspot	Front Face	0.12	0.07	0.19	Σ SAR < 1.6, Not required
			Rear Face	0.68	0.13	0.81	Σ SAR < 1.6, Not required
			Left Side	0.21	0.03	0.24	Σ SAR < 1.6, Not required
			Right Side	0.22	0.13	0.35	Σ SAR < 1.6, Not required
			Top Side	0.01	0.05	0.06	Σ SAR < 1.6, Not required
Bottom Side	0.12	0.04	0.16	Σ SAR < 1.6, Not required			
	0.12	0.04	0.16	Σ SAR < 1.6, Not required			
20	LTE 13 + BT (DSS)	Body-Worn	Front Face	0.07	0.02	0.09	Σ SAR < 1.6, Not required
			Rear Face	0.43	0.02	0.45	Σ SAR < 1.6, Not required

No.	Conditions (SAR1 + SAR2)	Exposure Condition	Test Position	Max. SAR1	Max. SAR2	SAR Summation	SPLSR Analysis
21	LTE 25 + WLAN (DTS)	Head	Right Cheek	0.16	0.22	0.38	Σ SAR < 1.6, Not required
			Right Tilted	0.09	0.03	0.12	Σ SAR < 1.6, Not required
			Left Cheek	0.16	0.09	0.25	Σ SAR < 1.6, Not required
			Left Tilted	0.10	0.04	0.14	Σ SAR < 1.6, Not required
		Body-Worn	Front Face	0.24	0.05	0.29	Σ SAR < 1.6, Not required
			Rear Face	0.79	0.10	0.89	Σ SAR < 1.6, Not required
		Hotspot	Front Face	0.33	0.07	0.40	Σ SAR < 1.6, Not required
			Rear Face	1.25	0.13	1.38	Σ SAR < 1.6, Not required
			Left Side	0.31	0.03	0.34	Σ SAR < 1.6, Not required
			Right Side	0.13	0.13	0.26	Σ SAR < 1.6, Not required
			Top Side	0.05	0.05	0.10	Σ SAR < 1.6, Not required
Bottom Side	0.65	0.04	0.69	Σ SAR < 1.6, Not required			
	0.65	0.04	0.69	Σ SAR < 1.6, Not required			
22	LTE 25 + BT (DSS)	Body-Worn	Front Face	0.24	0.02	0.26	Σ SAR < 1.6, Not required
			Rear Face	0.79	0.02	0.81	Σ SAR < 1.6, Not required

FCC SAR Test Report

No.	Conditions (SAR1 + SAR2)	Exposure Condition	Test Position	Max. SAR1	Max. SAR2	SAR Summation	SPLSR Analysis
23	LTE 26 + WLAN (DTS)	Head	Right Cheek	0.80	0.22	1.02	Σ SAR < 1.6, Not required
			Right Tilted	0.37	0.03	0.40	Σ SAR < 1.6, Not required
			Left Cheek	0.70	0.09	0.79	Σ SAR < 1.6, Not required
			Left Tilted	0.37	0.04	0.41	Σ SAR < 1.6, Not required
		Body-Worn	Front Face	0.27	0.05	0.32	Σ SAR < 1.6, Not required
			Rear Face	0.90	0.10	1.00	Σ SAR < 1.6, Not required
		Hotspot	Front Face	0.14	0.07	0.21	Σ SAR < 1.6, Not required
			Rear Face	1.23	0.13	1.36	Σ SAR < 1.6, Not required
			Left Side	0.48	0.03	0.51	Σ SAR < 1.6, Not required
			Right Side	0.50	0.13	0.63	Σ SAR < 1.6, Not required
			Top Side	0.03	0.05	0.08	Σ SAR < 1.6, Not required
			Bottom Side	0.12	0.04	0.16	Σ SAR < 1.6, Not required
24	LTE 26 + BT (DSS)	Body-Worn	Front Face	0.27	0.02	0.29	Σ SAR < 1.6, Not required
			Rear Face	0.90	0.02	0.92	Σ SAR < 1.6, Not required

No.	Conditions (SAR1 + SAR2)	Exposure Condition	Test Position	Max. SAR1	Max. SAR2	SAR Summation	SPLSR Analysis
25	LTE 41 + WLAN (DTS)	Head	Right Cheek	0.12	0.22	0.34	Σ SAR < 1.6, Not required
			Right Tilted	0.07	0.03	0.10	Σ SAR < 1.6, Not required
			Left Cheek	0.15	0.09	0.24	Σ SAR < 1.6, Not required
			Left Tilted	0.07	0.04	0.11	Σ SAR < 1.6, Not required
		Body-Worn	Front Face	0.08	0.05	0.13	Σ SAR < 1.6, Not required
			Rear Face	0.34	0.10	0.44	Σ SAR < 1.6, Not required
		Hotspot	Front Face	0.11	0.07	0.18	Σ SAR < 1.6, Not required
			Rear Face	0.47	0.13	0.60	Σ SAR < 1.6, Not required
			Left Side	0.21	0.03	0.24	Σ SAR < 1.6, Not required
			Right Side	0.08	0.13	0.21	Σ SAR < 1.6, Not required
			Top Side	0.04	0.05	0.09	Σ SAR < 1.6, Not required
			Bottom Side	0.13	0.04	0.17	Σ SAR < 1.6, Not required
26	LTE 41 + BT (DSS)	Body-Worn	Front Face	0.08	0.02	0.10	Σ SAR < 1.6, Not required
			Rear Face	0.34	0.02	0.36	Σ SAR < 1.6, Not required

Test Engineer : Xianxiong Qin, and Rambo

5. Calibration of Test Equipment

Equipment	Manufacturer	Model	SN	Cal. Date	Cal. Interval
System Validation Dipole	SPEAG	D750V3	1067	Sep. 05, 2018	1 Year
System Validation Dipole	SPEAG	D835V2	4d139	Sep. 06, 2018	1 Year
System Validation Dipole	SPEAG	D1750V2	1071	Sep. 13, 2018	1 Year
System Validation Dipole	SPEAG	D1900V2	5d159	Sep. 11, 2018	1 Year
System Validation Dipole	SPEAG	D2450V2	893	Aug. 31, 2018	1 Year
System Validation Dipole	SPEAG	D2600V2	1110	Aug. 31, 2018	1 Year
Dosimetric E-Field Probe	SPEAG	EX3DV4	3873	Aug. 31, 2018	1 Year
Data Acquisition Electronics	SPEAG	DAE4	1341	Aug. 28, 2018	1 Year
Radio Communication Analyzer	ANRITSU	MT8820C	6201300717	Jul. 09, 2018	1 Year
Wireless Communication Test Set	Agilent	E5515C	MY50260600	May. 14, 2018	1 Year
ENA Series Network Analyzer	Agilent	E5071C	MY46214638	Jul. 09, 2018	1 Year
Spectrum Analyzer	KEYSIGHT	N9010A	MY54510355	Jul. 09, 2018	1 Year
MXG Analog Signal Generator	KEYSIGHT	N5183A	MY50143024	Mar. 14, 2018	1 Year
Power Meter	Agilent	N1914A	MY52180044	Oct. 10, 2018	2 Years
Power Sensor	Agilent	E9304A H18	MY52050011	Jan. 04, 2018	1 Year
Power Meter	ANRITSU	ML2495A	1506002	Mar. 02, 2018	1 Year
Power Sensor	ANRITSU	MA2411B	1339353	Mar. 02, 2018	1 Year
Temp. & Humi. Recorder	CLOCK	HTC-1	157248	Jul. 11, 2018	1 Year
Electronic Thermometer	YONGFA	YF-160A	120100323	Sep. 14, 2018	1 Year
Coupler	Woken	0110A056020-10	COM27RW1A3	Sep. 14, 2018	1 Year

6. Measurement Uncertainty

Source of Uncertainty	Tolerance (± %)	Probability Distribution	Divisor	Ci (1g)	Ci (10g)	Standard Uncertainty (± %, 1g)	Standard Uncertainty (± %, 10g)	Vi
Measurement System								
Probe Calibration	6.0	Normal	1	1	1	6.0	6.0	∞
Axial Isotropy	4.7	Rectangular	√3	0.707	0.707	1.9	1.9	∞
Hemispherical Isotropy	9.6	Rectangular	√3	0.707	0.707	3.9	3.9	∞
Boundary Effect	1.0	Rectangular	√3	1	1	0.6	0.6	∞
Linearity	4.7	Rectangular	√3	1	1	2.7	2.7	∞
System Detection Limits	0.25	Rectangular	√3	1	1	0.14	0.14	∞
Readout Electronics	0.3	Normal	1	1	1	0.3	0.3	∞
Response Time	0.0	Rectangular	√3	1	1	0.0	0.0	∞
Integration Time	1.7	Rectangular	√3	1	1	1.0	1.0	∞
RF Ambient Conditions - Noise	3.0	Rectangular	√3	1	1	1.7	1.7	∞
RF Ambient Conditions - Reflections	3.0	Rectangular	√3	1	1	1.7	1.7	∞
Probe Positioner Mechanical Tolerance	0.4	Rectangular	√3	1	1	0.2	0.2	∞
Probe Positioning with Respect to Phantom Shell	2.9	Rectangular	√3	1	1	1.7	1.7	∞
Extrapolation, interpolation, and integration algorithms for max. SAR evaluation	2.0	Rectangular	√3	1	1	1.2	1.2	∞
Test Sample Related								
Test Sample Positioning	1.5 / 0.7	Normal	1	1	1	1.5	0.7	32
Device Holder Uncertainty	4.2 / 1.8	Normal	1	1	1	4.2	1.8	32
Output Power Variation - SAR Drift Measurement	5.0	Rectangular	√3	1	1	2.9	2.9	∞
Phantom and Tissue Parameters								
Phantom Uncertainty (Shape and Thickness Tolerances)	7.2	Rectangular	√3	1	1	4.2	4.2	∞
Liquid Conductivity - Deviation from Target Values	5.0	Rectangular	√3	0.64	0.43	1.8	1.2	∞
Liquid Conductivity - Measurement Uncertainty	1.0	Normal	1	0.64	0.43	0.6	0.4	25
Liquid Permittivity - Deviation from Target Values	5.0	Rectangular	√3	0.60	0.49	1.7	1.4	∞
Liquid Permittivity - Measurement Uncertainty	0.5	Normal	1	0.60	0.49	0.3	0.2	25
Combined Standard Uncertainty						± 11.2 %	± 10.4 %	
Expanded Uncertainty (K=2)						± 22.4 %	± 20.8 %	

Uncertainty budget for frequency range 300 MHz to 3 GHz

7. Information on the Testing Laboratories

We, BV 7LAYERS COMMUNICATIONS TECHNOLOGY (SHENZHEN) CO. LTD., were founded in 2015 to provide our best service in EMC, Radio, Telecom and Safety consultation. Our laboratories are accredited and approved according to ISO/IEC 17025.

If you have any comments, please feel free to contact us at the following:

Add: No. B102, Dazu Chuangxin Mansion, North of Beihuan Avenue, North Area, Hi-Tech Industry Park, Nanshan District, Shenzhen, Guangdong, China

Tel: 86-755-8869-6566

Fax: 86-755-8869-6577

Email: customerservice.dg@cn.bureauveritas.com

Web Site: www.bureauveritas.com

The road map of all our labs can be found in our web site also.

---END---

Appendix A. SAR Plots of System Verification

The plots for system verification with largest deviation for each SAR system combination are shown as follows.

System Check_H900_181115

DUT: Dipole:900 MHz;Type:D900V2; SN:1d139

Communication System: CW; Frequency: 900 MHz;Duty Cycle: 1:1

Medium: HSL900_1115 Medium parameters used: $f = 900$ MHz; $\sigma = 0.949$ S/m; $\epsilon_r = 41.542$; $\rho = 1000$ kg/m³

Ambient Temperature : 22.8 °C ; Liquid Temperature : 21.8 °C

DASY5 Configuration:

- Probe: EX3DV4 - SN3873; ConvF(9.42, 9.42, 9.42); Calibrated: 2018/08/31;
- Sensor-Surface: 1.4mm (Mechanical Surface Detection)
- Electronics: DAE4 Sn1341; Calibrated: 2018/08/28
- Phantom: Left Phantom with CRP v5.0; Type: QD000P40CD; Serial: TP:1722
- Measurement SW: DASY52, Version 52.8 (8); SEMCAD X Version 14.6.10 (7331)

Pin=250mW/Area Scan (71x121x1): Interpolated grid: dx=1.500 mm, dy=1.500 mm
Maximum value of SAR (interpolated) = 3.42 W/kg

Pin=250mW/Zoom Scan (5x5x7)/Cube 0: Measurement grid: dx=8mm, dy=8mm, dz=5mm
Reference Value = 59.29 V/m; Power Drift = 0.02 dB
Peak SAR (extrapolated) = 3.87 W/kg
SAR(1 g) = 2.57 W/kg; SAR(10 g) = 1.66 W/kg
Maximum value of SAR (measured) = 3.45 W/kg

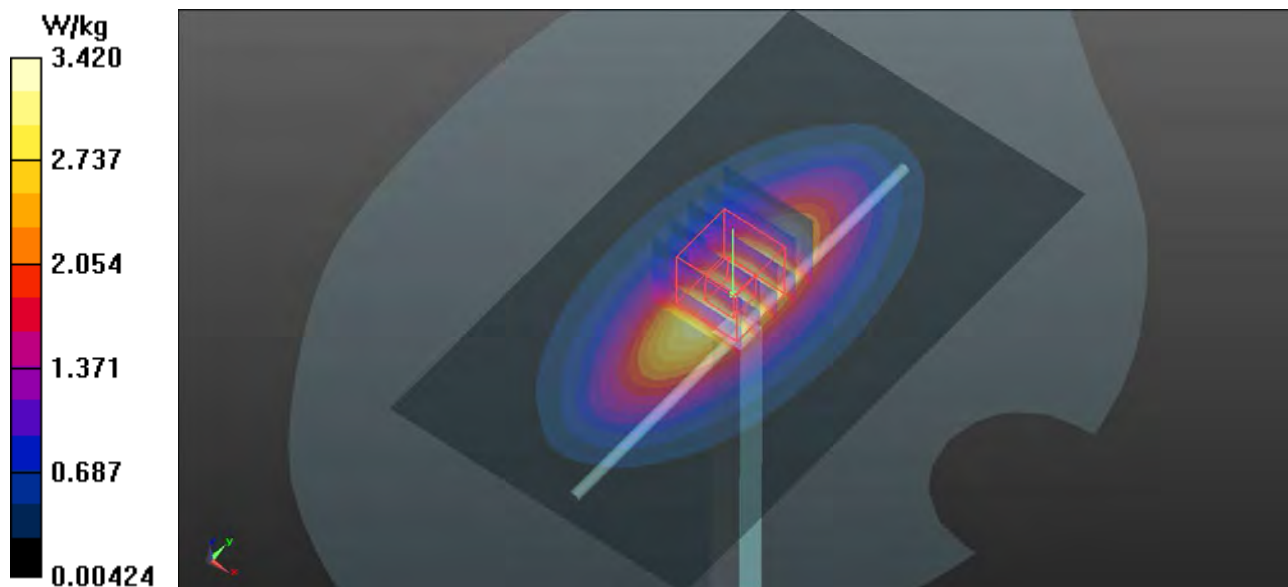

System Check_H1750_181114

DUT: Dipole:1750 MHz;Type:D1750V2; SN:1071

Communication System: CW; Frequency: 1750 MHz;Duty Cycle: 1:1

Medium: HSL1750_1114 Medium parameters used: $f = 1750$ MHz; $\sigma = 1.325$ S/m; $\epsilon_r = 40.765$; $\rho = 1000$ kg/m³

Ambient Temperature : 22.9 °C ; Liquid Temperature : 21.9 °C

DASY5 Configuration:

- Probe: EX3DV4 - SN3873; ConvF(8.39, 8.39, 8.39); Calibrated: 2018/08/31;
- Sensor-Surface: 1.4mm (Mechanical Surface Detection)
- Electronics: DAE4 Sn1341; Calibrated: 2018/08/28
- Phantom: Front Phantom with CRP v5.0; Type: QD000P40CD; Serial: TP:1695
- Measurement SW: DASY52, Version 52.8 (8); SEMCAD X Version 14.6.10 (7331)

Pin=250mW/Area Scan (71x81x1): Interpolated grid: dx=1.500 mm, dy=1.500 mm
Maximum value of SAR (interpolated) = 14.6 W/kg

Pin=250mW/Zoom Scan (5x5x7)/Cube 0: Measurement grid: dx=8mm, dy=8mm, dz=5mm
Reference Value = 104.8 V/m; Power Drift = 0.14 dB
Peak SAR (extrapolated) = 17.2 W/kg
SAR(1 g) = 9.61 W/kg; SAR(10 g) = 5.19 W/kg
Maximum value of SAR (measured) = 14.5 W/kg

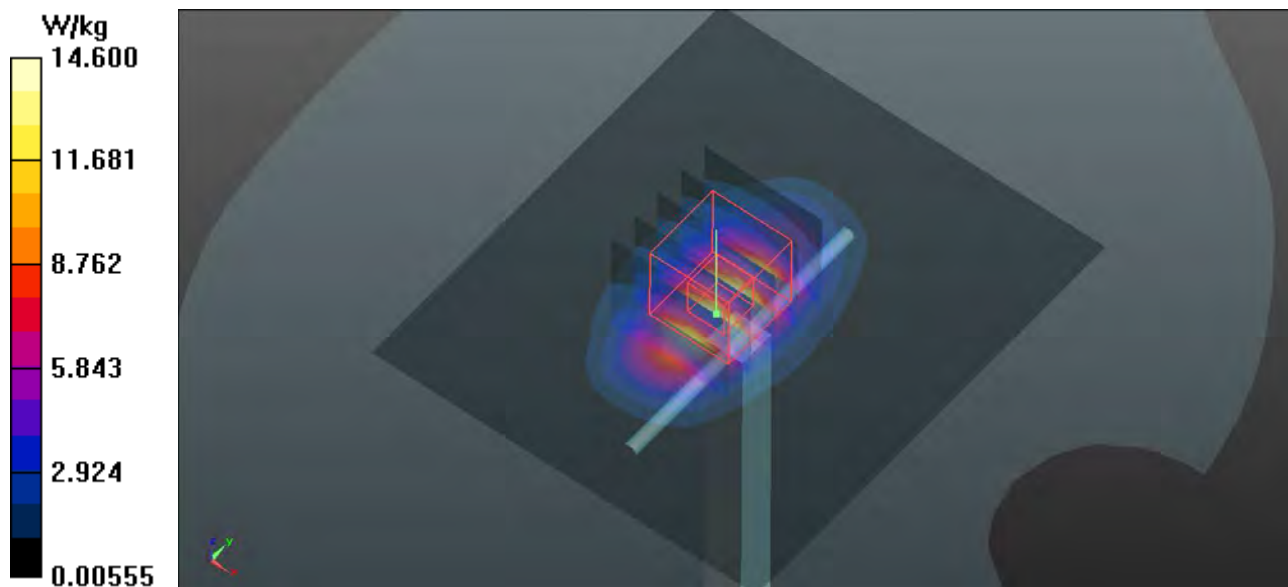

System Check_H2000_181114

DUT: Dipole:1900MHz;Type:D1900V2; SN:5d159

Communication System: CW; Frequency: 1900 MHz;Duty Cycle: 1:1

Medium: HSL2000_1114 Medium parameters used: $f = 1900$ MHz; $\sigma = 1.339$ S/m; $\epsilon_r = 40.979$; $\rho = 1000$ kg/m³

Ambient Temperature : 22.9 °C ; Liquid Temperature : 21.9 °C

DASY5 Configuration:

- Probe: EX3DV4 - SN3873; ConvF(8.12, 8.12, 8.12); Calibrated: 2018/08/31;
- Sensor-Surface: 1.4mm (Mechanical Surface Detection)
- Electronics: DAE4 Sn1341; Calibrated: 2018/08/28
- Phantom: Front Phantom with CRP v5.0; Type: QD000P40CD; Serial: TP:1695
- Measurement SW: DASY52, Version 52.8 (8); SEMCAD X Version 14.6.10 (7331)

Pin=250mW/Area Scan (71x81x1): Interpolated grid: dx=1.500 mm, dy=1.500 mm
Maximum value of SAR (interpolated) = 15.3 W/kg

Pin=250mW/Zoom Scan (5x5x7)/Cube 0: Measurement grid: dx=8mm, dy=8mm, dz=5mm
Reference Value = 103.0 V/m; Power Drift = 0.13 dB
Peak SAR (extrapolated) = 18.3 W/kg
SAR(1 g) = 10 W/kg; SAR(10 g) = 5.24 W/kg
Maximum value of SAR (measured) = 15.4 W/kg

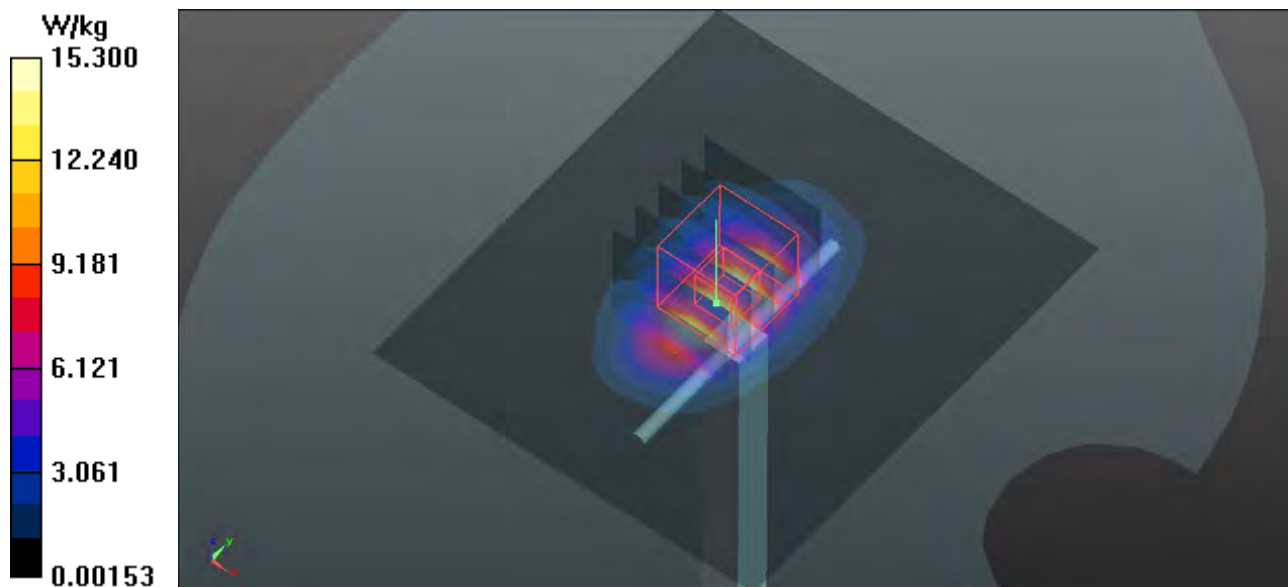

System Check_H2450_181207

DUT: Dipole:2450 MHz;Type:D2450V2; SN:893

Communication System: CW; Frequency: 2450 MHz;Duty Cycle: 1:1

Medium: HSL2450_1207 Medium parameters used: $f = 2450$ MHz; $\sigma = 1.845$ S/m; $\epsilon_r = 39.398$; $\rho = 1000$ kg/m³

Ambient Temperature : 23.1 °C ; Liquid Temperature : 22.1 °C

DASY5 Configuration:

- Probe: EX3DV4 - SN3873; ConvF(7.19, 7.19, 7.19); Calibrated: 2018/08/31;
- Sensor-Surface: 1.4mm (Mechanical Surface Detection)
- Electronics: DAE4 Sn1341; Calibrated: 2018/08/28
- Phantom: Front Phantom with CRP v5.0; Type: QD000P40CD; Serial: TP:1695
- Measurement SW: DASY52, Version 52.8 (8); SEMCAD X Version 14.6.10 (7331)

Pin=250mW/Area Scan (71x81x1): Interpolated grid: dx=1.200 mm, dy=1.200 mm
Maximum value of SAR (interpolated) = 23.8 W/kg

Pin=250mW/Zoom Scan (7x7x7)/Cube 0: Measurement grid: dx=5mm, dy=5mm, dz=5mm
Reference Value = 108.1 V/m; Power Drift = 0.10 dB
Peak SAR (extrapolated) = 29.2 W/kg
SAR(1 g) = 14 W/kg; SAR(10 g) = 6.41 W/kg
Maximum value of SAR (measured) = 23.5 W/kg

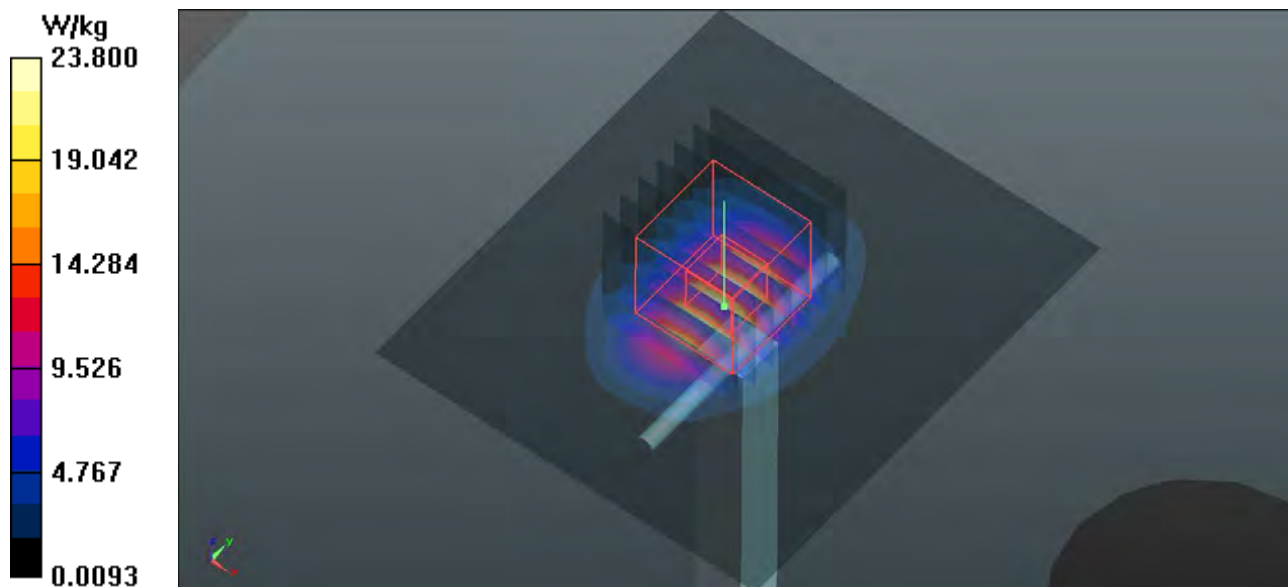

Appendix B. SAR Plots of SAR Measurement

The SAR plots for highest measured SAR in each exposure configuration, wireless mode and frequency band combination, and measured SAR > 1.5 W/kg are shown as follows.

P01 GSM900_GPRS12_Right Cheek_Ch124

DUT: 181030W001

Communication System: GPRS12; Frequency: 914.8 MHz; Duty Cycle: 1:2

Medium: HSL900_1115 Medium parameters used: $f = 915 \text{ MHz}$; $\sigma = 0.96 \text{ S/m}$; $\epsilon_r = 41.46$; $\rho = 1000 \text{ kg/m}^3$

Ambient Temperature : $22.8 \text{ }^\circ\text{C}$; Liquid Temperature : $21.8 \text{ }^\circ\text{C}$

DASY5 Configuration:

- Probe: EX3DV4 - SN3873; ConvF(9.42, 9.42, 9.42); Calibrated: 2018/08/31;
- Sensor-Surface: 1.4mm (Mechanical Surface Detection)
- Electronics: DAE4 Sn1341; Calibrated: 2018/08/28
- Phantom: Left Phantom with CRP v5.0; Type: QD000P40CD; Serial: TP:1722
- Measurement SW: DASY52, Version 52.8 (8); SEMCAD X Version 14.6.10 (7331)

- **Area Scan (51x91x1)**: Interpolated grid: $dx=2.000 \text{ mm}$, $dy=2.000 \text{ mm}$

Maximum value of SAR (interpolated) = 0.582 W/kg

- **Zoom Scan (5x5x7)/Cube 0**: Measurement grid: $dx=8\text{mm}$, $dy=8\text{mm}$, $dz=5\text{mm}$

Reference Value = 6.191 V/m ; Power Drift = 0.00 dB

Peak SAR (extrapolated) = 0.636 W/kg

SAR(1 g) = 0.501 W/kg ; SAR(10 g) = 0.378 W/kg

Maximum value of SAR (measured) = 0.587 W/kg

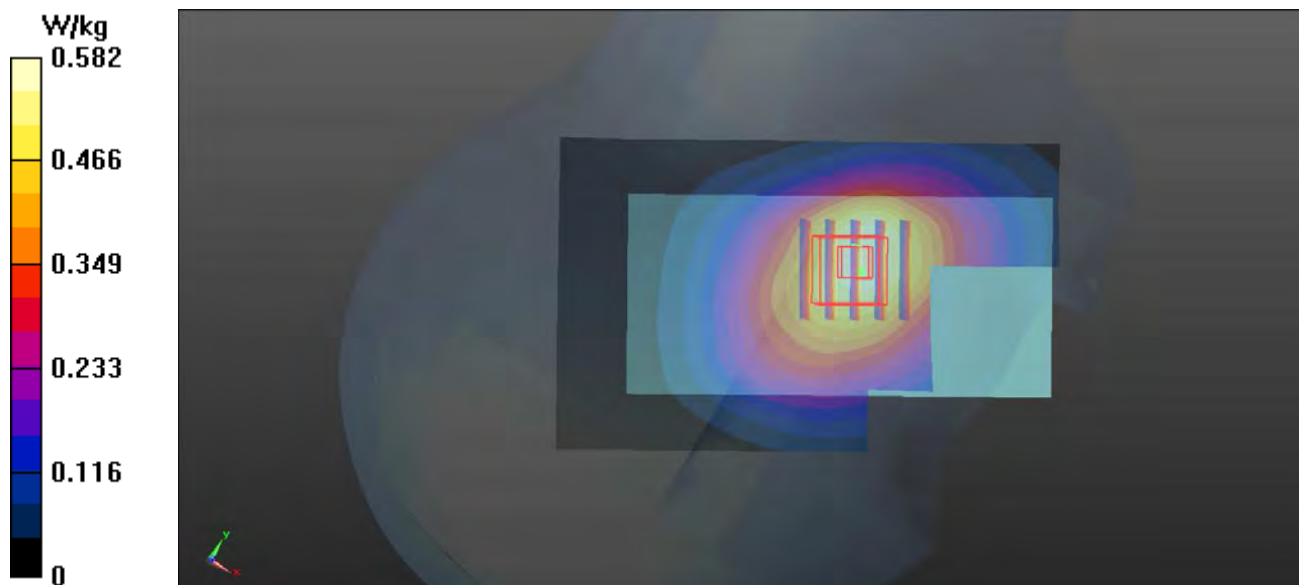

P02 GSM1800_GPRS11_Left Cheek_Ch699

DUT: 181030W001

Communication System: GPRS11; Frequency: 1747.6 MHz; Duty Cycle: 1:2.67

Medium: HSL1750_1114 Medium parameters used: $f = 1748$ MHz; $\sigma = 1.325$ S/m; $\epsilon_r = 40.769$; $\rho = 1000$ kg/m³

Ambient Temperature : 22.9 °C ; Liquid Temperature : 21.9 °C

DASY5 Configuration:

- Probe: EX3DV4 - SN3873; ConvF(8.39, 8.39, 8.39); Calibrated: 2018/08/31;
- Sensor-Surface: 1.4mm (Mechanical Surface Detection)
- Electronics: DAE4 Sn1341; Calibrated: 2018/08/28
- Phantom: Front Phantom with CRP v5.0; Type: QD000P40CD; Serial: TP:1695
- Measurement SW: DASY52, Version 52.8 (8); SEMCAD X Version 14.6.10 (7331)

- **Area Scan (51x91x1):** Interpolated grid: dx=2.000 mm, dy=2.000 mm

Maximum value of SAR (interpolated) = 0.408 W/kg

- **Zoom Scan (5x5x7)/Cube 0:** Measurement grid: dx=8mm, dy=8mm, dz=5mm

Reference Value = 4.319 V/m; Power Drift = 0.13 dB

Peak SAR (extrapolated) = 0.420 W/kg

SAR(1 g) = 0.282 W/kg; SAR(10 g) = 0.185 W/kg

Maximum value of SAR (measured) = 0.373 W/kg

- **Zoom Scan (5x5x7)/Cube 1:** Measurement grid: dx=8mm, dy=8mm, dz=5mm

Reference Value = 4.319 V/m; Power Drift = 0.13 dB

Peak SAR (extrapolated) = 0.285 W/kg

SAR(1 g) = 0.199 W/kg; SAR(10 g) = 0.137 W/kg

Maximum value of SAR (measured) = 0.252 W/kg

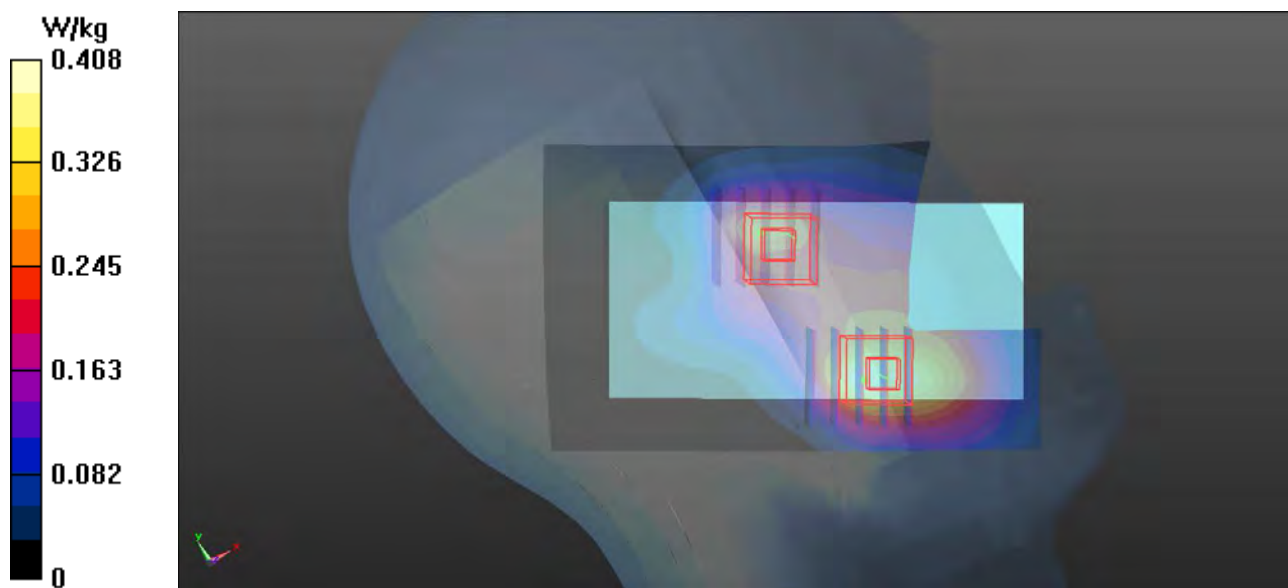

P03 WCDMA I_RMC12.2K_Left Cheek_Ch9887

DUT: 181030W001

Communication System: WCDMA; Frequency: 1977.4 MHz; Duty Cycle: 1:1

Medium: HSL2000_1114 Medium parameters used: $f = 1977.4$ MHz; $\sigma = 1.407$ S/m; $\epsilon_r = 40.738$; $\rho = 1000$ kg/m³

Ambient Temperature : 22.9 °C; Liquid Temperature : 21.9 °C

DASY5 Configuration:

- Probe: EX3DV4 - SN3873; ConvF(8.12, 8.12, 8.12); Calibrated: 2018/08/31;
- Sensor-Surface: 1.4mm (Mechanical Surface Detection)
- Electronics: DAE4 Sn1341; Calibrated: 2018/08/28
- Phantom: Front Phantom with CRP v5.0; Type: QD000P40CD; Serial: TP:1695
- Measurement SW: DASY52, Version 52.8 (8); SEMCAD X Version 14.6.10 (7331)

- **Area Scan (51x91x1):** Interpolated grid: dx=2.000 mm, dy=2.000 mm

Maximum value of SAR (interpolated) = 0.393 W/kg

- **Zoom Scan (5x5x7)/Cube 0:** Measurement grid: dx=8mm, dy=8mm, dz=5mm

Reference Value = 4.642 V/m; Power Drift = 0.01 dB

Peak SAR (extrapolated) = 0.505 W/kg

SAR(1 g) = 0.306 W/kg; SAR(10 g) = 0.184 W/kg

Maximum value of SAR (measured) = 0.426 W/kg

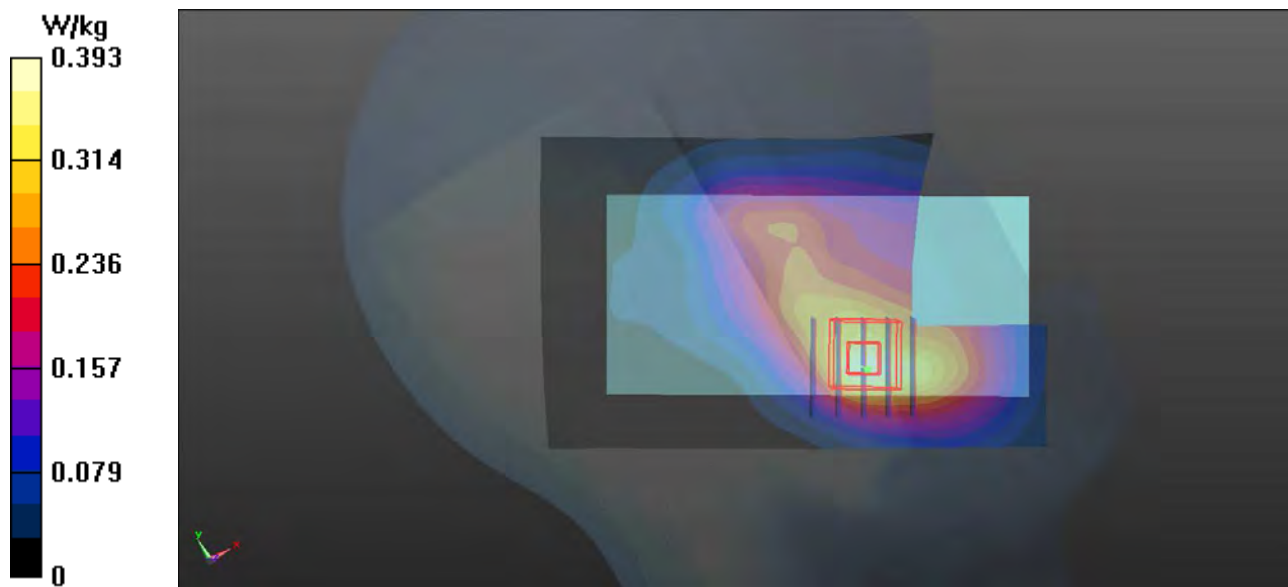

P04 WCDMA VIII_RMC12.2K_Right Cheek_Ch2863

DUT: 181030W001

Communication System: WCDMA; Frequency: 912.6 MHz; Duty Cycle: 1:1

Medium: HSL900_1115 Medium parameters used: $f = 913 \text{ MHz}$; $\sigma = 0.958 \text{ S/m}$; $\epsilon_r = 41.471$; $\rho = 1000 \text{ kg/m}^3$

Ambient Temperature : 22.8 °C ; Liquid Temperature : 21.8 °C

DASY5 Configuration:

- Probe: EX3DV4 - SN3873; ConvF(9.42, 9.42, 9.42); Calibrated: 2018/08/31;
- Sensor-Surface: 1.4mm (Mechanical Surface Detection)
- Electronics: DAE4 Sn1341; Calibrated: 2018/08/28
- Phantom: Left Phantom with CRP v5.0; Type: QD000P40CD; Serial: TP:1722
- Measurement SW: DASY52, Version 52.8 (8); SEMCAD X Version 14.6.10 (7331)

- **Area Scan (51x91x1):** Interpolated grid: $dx=2.000 \text{ mm}$, $dy=2.000 \text{ mm}$

Maximum value of SAR (interpolated) = 0.439 W/kg

- **Zoom Scan (5x5x7)/Cube 0:** Measurement grid: $dx=8\text{mm}$, $dy=8\text{mm}$, $dz=5\text{mm}$

Reference Value = 5.235 V/m; Power Drift = 0.02 dB

Peak SAR (extrapolated) = 0.465 W/kg

SAR(1 g) = 0.376 W/kg; SAR(10 g) = 0.286 W/kg

Maximum value of SAR (measured) = 0.433 W/kg

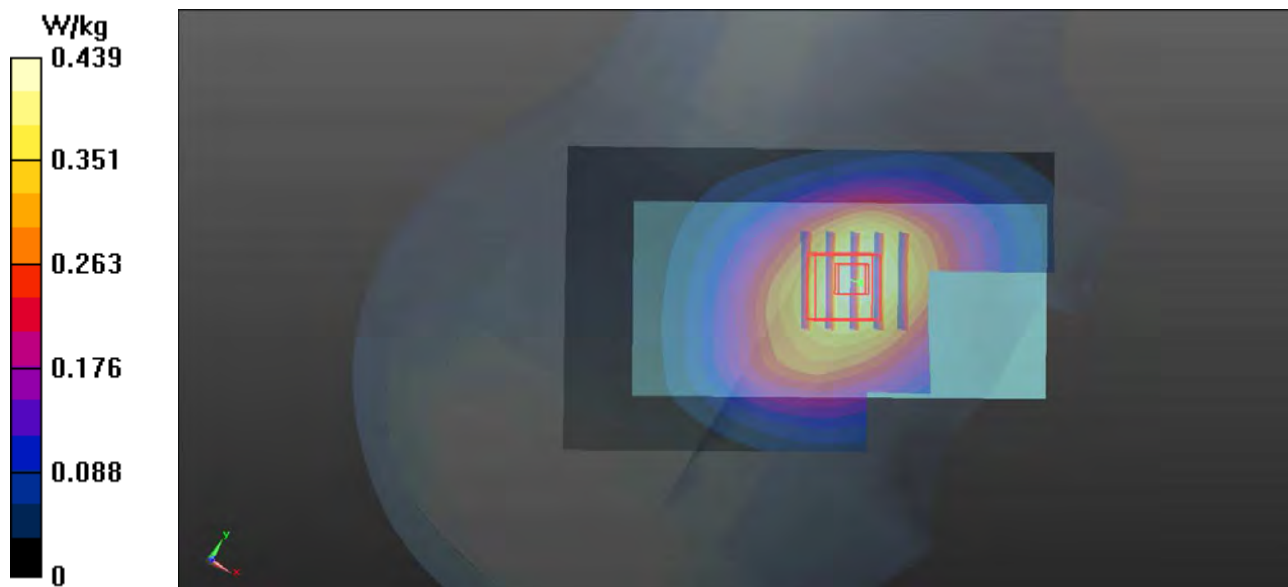

P05 802.11b_Left Cheek_Ch1

DUT: 181030W001

Communication System: 802.11b; Frequency: 2412 MHz; Duty Cycle: 1:1

Medium: HSL2450_1207 Medium parameters used: $f = 2412$ MHz; $\sigma = 1.804$ S/m; $\epsilon_r = 39.56$; $\rho = 1000$ kg/m³

Ambient Temperature : 23.1 °C; Liquid Temperature : 22.1 °C

DASY5 Configuration:

- Probe: EX3DV4 - SN3873; ConvF(7.19, 7.19, 7.19); Calibrated: 2018/08/31;
- Sensor-Surface: 1.4mm (Mechanical Surface Detection)
- Electronics: DAE4 Sn1341; Calibrated: 2018/08/28
- Phantom: Front Phantom with CRP v5.0; Type: QD000P40CD; Serial: TP:1695
- Measurement SW: DASY52, Version 52.8 (8); SEMCAD X Version 14.6.10 (7331)

- **Area Scan (51x91x1):** Interpolated grid: dx=2.000 mm, dy=2.000 mm

Maximum value of SAR (interpolated) = 0.599 W/kg

- **Zoom Scan (5x5x7)/Cube 0:** Measurement grid: dx=8mm, dy=8mm, dz=5mm

Reference Value = 8.645 V/m; Power Drift = 0.13 dB

Peak SAR (extrapolated) = 0.616 W/kg

SAR(1 g) = 0.237 W/kg; SAR(10 g) = 0.097 W/kg

Maximum value of SAR (measured) = 0.475 W/kg

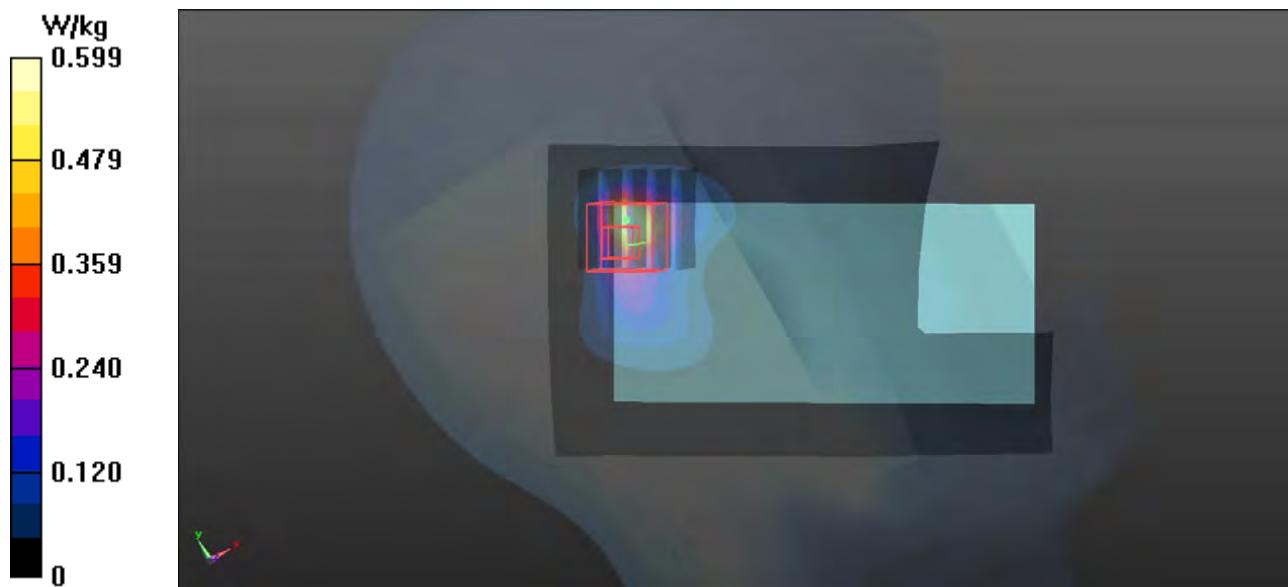

P06 GSM900_GPRS12_Rear Face_0.5cm_Ch124

DUT: 181030W001

Communication System: GPRS12; Frequency: 914.8 MHz; Duty Cycle: 1:2
Medium: HSL900_1115 Medium parameters used: $f = 915 \text{ MHz}$; $\sigma = 0.96 \text{ S/m}$; $\epsilon_r = 41.46$; $\rho = 1000 \text{ kg/m}^3$
Ambient Temperature : $22.8 \text{ }^\circ\text{C}$; Liquid Temperature : $21.8 \text{ }^\circ\text{C}$

DASY5 Configuration:

- Probe: EX3DV4 - SN3873; ConvF(9.42, 9.42, 9.42); Calibrated: 2018/08/31;
- Sensor-Surface: 1.4mm (Mechanical Surface Detection)
- Electronics: DAE4 Sn1341; Calibrated: 2018/08/28
- Phantom: Left Phantom with CRP v5.0; Type: QD000P40CD; Serial: TP:1722
- Measurement SW: DASY52, Version 52.8 (8); SEMCAD X Version 14.6.10 (7331)

- **Area Scan (61x101x1):** Interpolated grid: $dx=2.000 \text{ mm}$, $dy=2.000 \text{ mm}$
Maximum value of SAR (interpolated) = 1.87 W/kg

- **Zoom Scan (5x5x7)/Cube 0:** Measurement grid: $dx=8\text{mm}$, $dy=8\text{mm}$, $dz=5\text{mm}$
Reference Value = 20.81 V/m ; Power Drift = 0.05 dB
Peak SAR (extrapolated) = 3.04 W/kg
SAR(1 g) = 1.4 W/kg ; SAR(10 g) = 0.647 W/kg
Maximum value of SAR (measured) = 2.43 W/kg

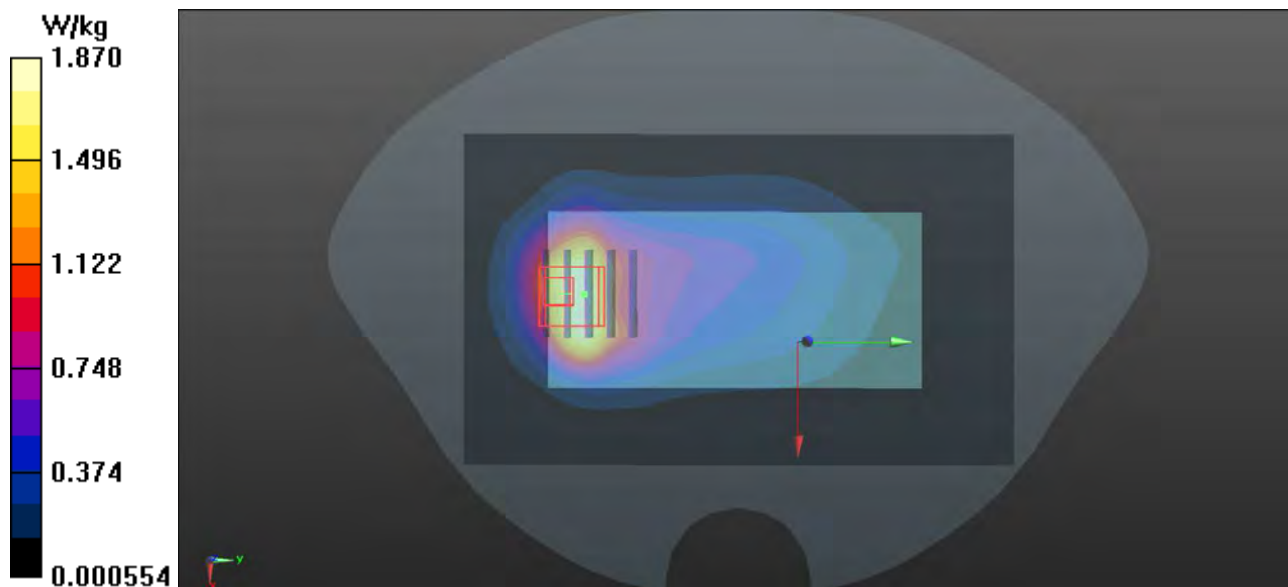

P07 GSM1800_GPRS11_Rear Face_0.5cm_Ch699

DUT: 181030W001

Communication System: GPRS11; Frequency: 1747.6 MHz; Duty Cycle: 1:2.67

Medium: HSL1750_1114 Medium parameters used: $f = 1748$ MHz; $\sigma = 1.325$ S/m; $\epsilon_r = 40.769$; $\rho = 1000$ kg/m³

Ambient Temperature : 22.9 °C; Liquid Temperature : 21.9 °C

DASY5 Configuration:

- Probe: EX3DV4 - SN3873; ConvF(8.39, 8.39, 8.39); Calibrated: 2018/08/31;
- Sensor-Surface: 1.4mm (Mechanical Surface Detection)
- Electronics: DAE4 Sn1341; Calibrated: 2018/08/28
- Phantom: Front Phantom with CRP v5.0; Type: QD000P40CD; Serial: TP:1695
- Measurement SW: DASY52, Version 52.8 (8); SEMCAD X Version 14.6.10 (7331)

- **Area Scan (61x101x1):** Interpolated grid: dx=2.000 mm, dy=2.000 mm

Maximum value of SAR (interpolated) = 2.55 W/kg

- **Zoom Scan (5x5x7)/Cube 0:** Measurement grid: dx=8mm, dy=8mm, dz=5mm

Reference Value = 13.00 V/m; Power Drift = 0.03 dB

Peak SAR (extrapolated) = 3.07 W/kg

SAR(1 g) = 1.54 W/kg; SAR(10 g) = 0.826 W/kg

Maximum value of SAR (measured) = 2.48 W/kg

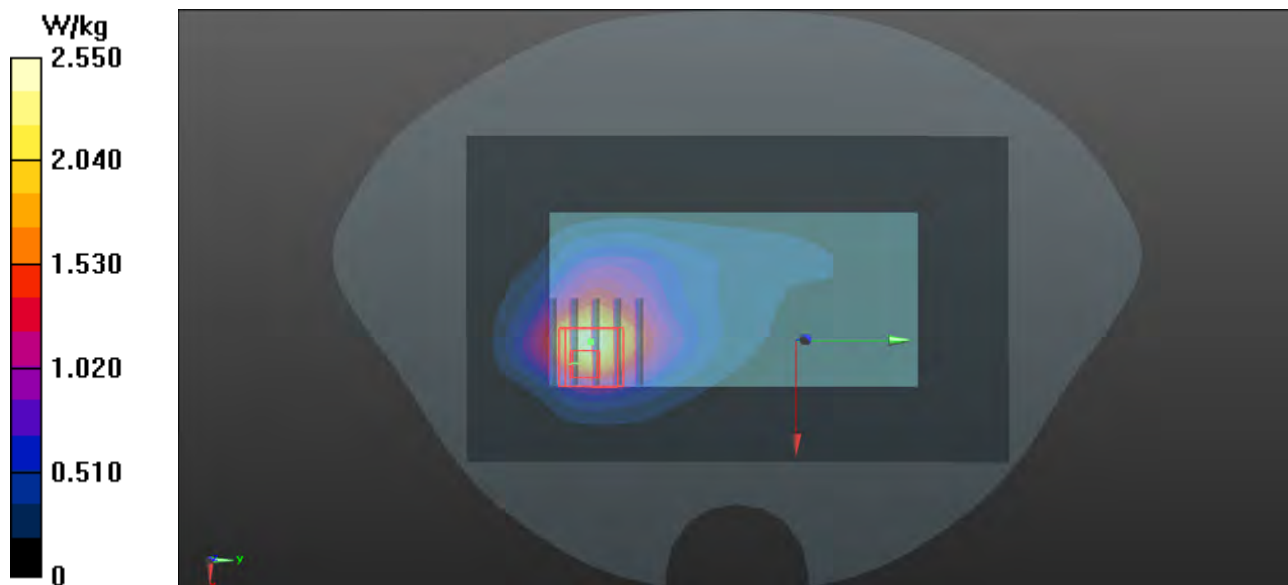

P08 WCDMA I_RMC12.2K_Rear Face_0.5cm_Ch9887

DUT: 181030W001

Communication System: WCDMA; Frequency: 1977.4 MHz; Duty Cycle: 1:1

Medium: HSL2000_1114 Medium parameters used: $f = 1977.4$ MHz; $\sigma = 1.407$ S/m; $\epsilon_r = 40.738$; $\rho = 1000$ kg/m³

Ambient Temperature : 22.9 °C ; Liquid Temperature : 21.9 °C

DASY5 Configuration:

- Probe: EX3DV4 - SN3873; ConvF(8.12, 8.12, 8.12); Calibrated: 2018/08/31;
- Sensor-Surface: 1.4mm (Mechanical Surface Detection)
- Electronics: DAE4 Sn1341; Calibrated: 2018/08/28
- Phantom: Front Phantom with CRP v5.0; Type: QD000P40CD; Serial: TP:1695
- Measurement SW: DASY52, Version 52.8 (8); SEMCAD X Version 14.6.10 (7331)

- **Area Scan (61x101x1):** Interpolated grid: dx=2.000 mm, dy=2.000 mm
Maximum value of SAR (interpolated) = 3.23 W/kg

- **Zoom Scan (5x5x7)/Cube 0:** Measurement grid: dx=8mm, dy=8mm, dz=5mm
Reference Value = 12.60 V/m; Power Drift = -0.08 dB
Peak SAR (extrapolated) = 3.11 W/kg
SAR(1 g) = 1.5 W/kg; SAR(10 g) = 0.814 W/kg
Maximum value of SAR (measured) = 2.30 W/kg

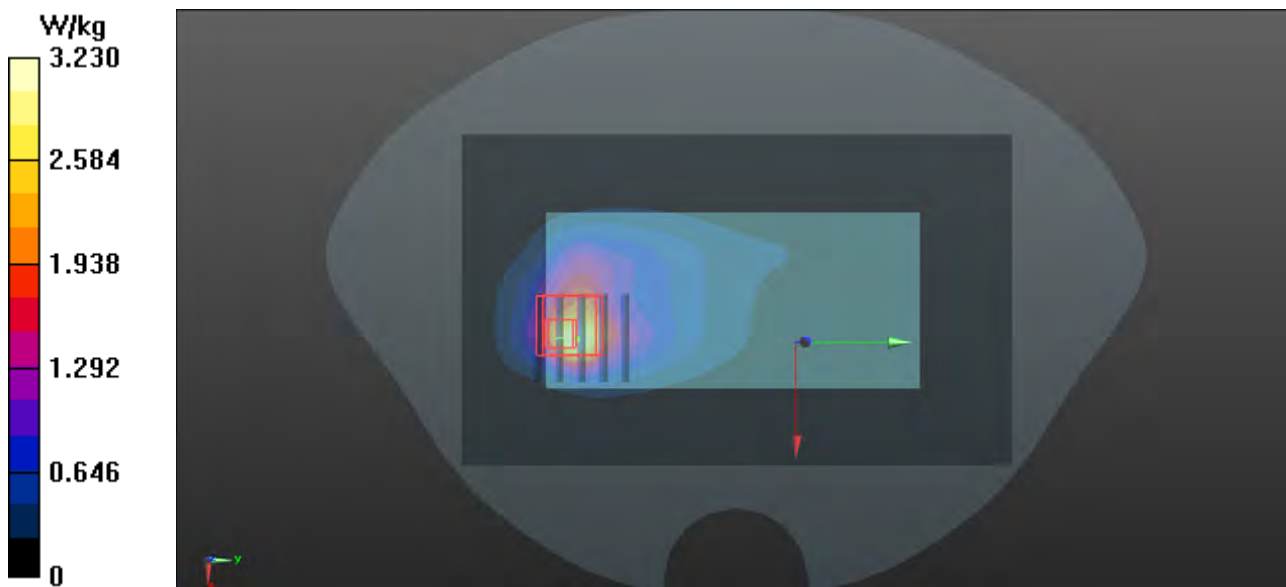

P09 WCDMA VIII_RMC12.2K_Rear Face_0.5cm_Ch2863

DUT: 181030W001

Communication System: WCDMA; Frequency: 912.6 MHz; Duty Cycle: 1:1

Medium: HSL900_1115 Medium parameters used: $f = 913 \text{ MHz}$; $\sigma = 0.958 \text{ S/m}$; $\epsilon_r = 41.471$; $\rho = 1000 \text{ kg/m}^3$

Ambient Temperature : $22.8 \text{ }^\circ\text{C}$; Liquid Temperature : $21.8 \text{ }^\circ\text{C}$

DASY5 Configuration:

- Probe: EX3DV4 - SN3873; ConvF(9.42, 9.42, 9.42); Calibrated: 2018/08/31;
- Sensor-Surface: 1.4mm (Mechanical Surface Detection)
- Electronics: DAE4 Sn1341; Calibrated: 2018/08/28
- Phantom: Left Phantom with CRP v5.0; Type: QD000P40CD; Serial: TP:1722
- Measurement SW: DASY52, Version 52.8 (8); SEMCAD X Version 14.6.10 (7331)

- **Area Scan (61x101x1):** Interpolated grid: $dx=2.000 \text{ mm}$, $dy=2.000 \text{ mm}$

Maximum value of SAR (interpolated) = 1.56 W/kg

- **Zoom Scan (5x5x7)/Cube 0:** Measurement grid: $dx=8\text{mm}$, $dy=8\text{mm}$, $dz=5\text{mm}$

Reference Value = 18.06 V/m ; Power Drift = -0.01 dB

Peak SAR (extrapolated) = 1.84 W/kg

SAR(1 g) = 0.899 W/kg ; SAR(10 g) = 0.457 W/kg

Maximum value of SAR (measured) = 1.32 W/kg

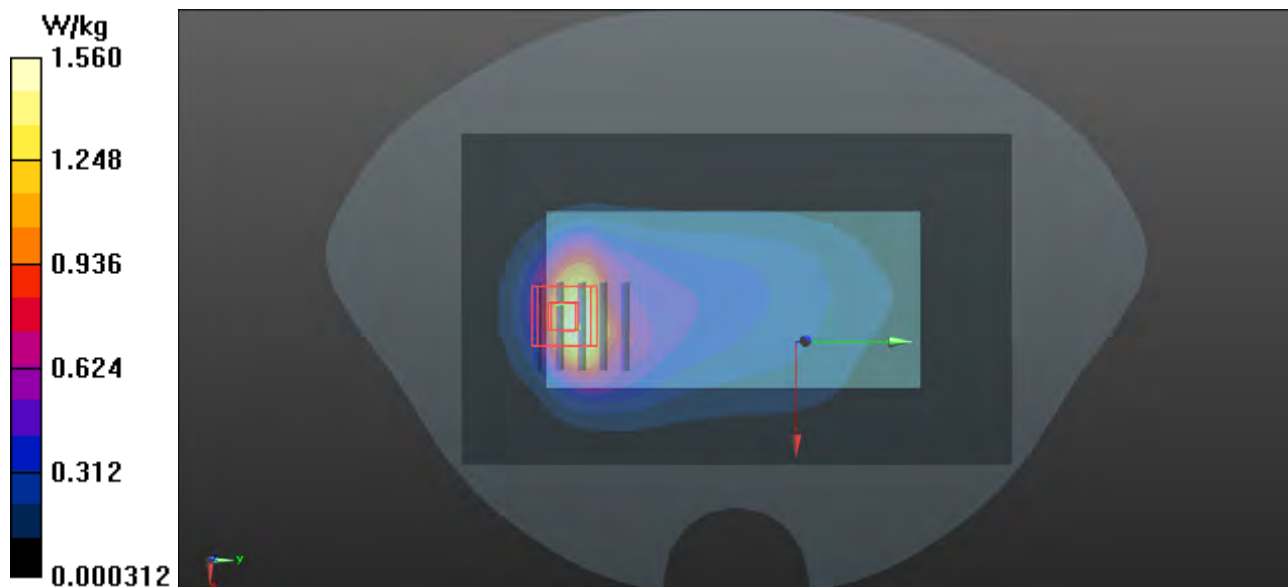

P10 802.11b_Rear Face_0.5cm_Ch13

DUT: 181030W001

Communication System: 802.11b ; Frequency: 2472 MHz;Duty Cycle: 1:1

Medium: HSL2450_1207 Medium parameters used: $f = 2472$ MHz; $\sigma = 1.868$ S/m; $\epsilon_r = 39.307$; $\rho = 1000$ kg/m³

Ambient Temperature : 23.1 °C ; Liquid Temperature : 22.1 °C

DASY5 Configuration:

- Probe: EX3DV4 - SN3873; ConvF(7.19, 7.19, 7.19); Calibrated: 2018/08/31;
- Sensor-Surface: 1.4mm (Mechanical Surface Detection)
- Electronics: DAE4 Sn1341; Calibrated: 2018/08/28
- Phantom: Front Phantom with CRP v5.0; Type: QD000P40CD; Serial: TP:1695
- Measurement SW: DASY52, Version 52.8 (8); SEMCAD X Version 14.6.10 (7331)

- **Area Scan (51x91x1):** Interpolated grid: dx=2.000 mm, dy=2.000 mm

Maximum value of SAR (interpolated) = 0.398 W/kg

- **Zoom Scan (5x5x7)/Cube 0:** Measurement grid: dx=8mm, dy=8mm, dz=5mm

Reference Value = 3.957 V/m; Power Drift = 0.04 dB

Peak SAR (extrapolated) = 0.531 W/kg

SAR(1 g) = 0.213 W/kg; SAR(10 g) = 0.093 W/kg

Maximum value of SAR (measured) = 0.400 W/kg

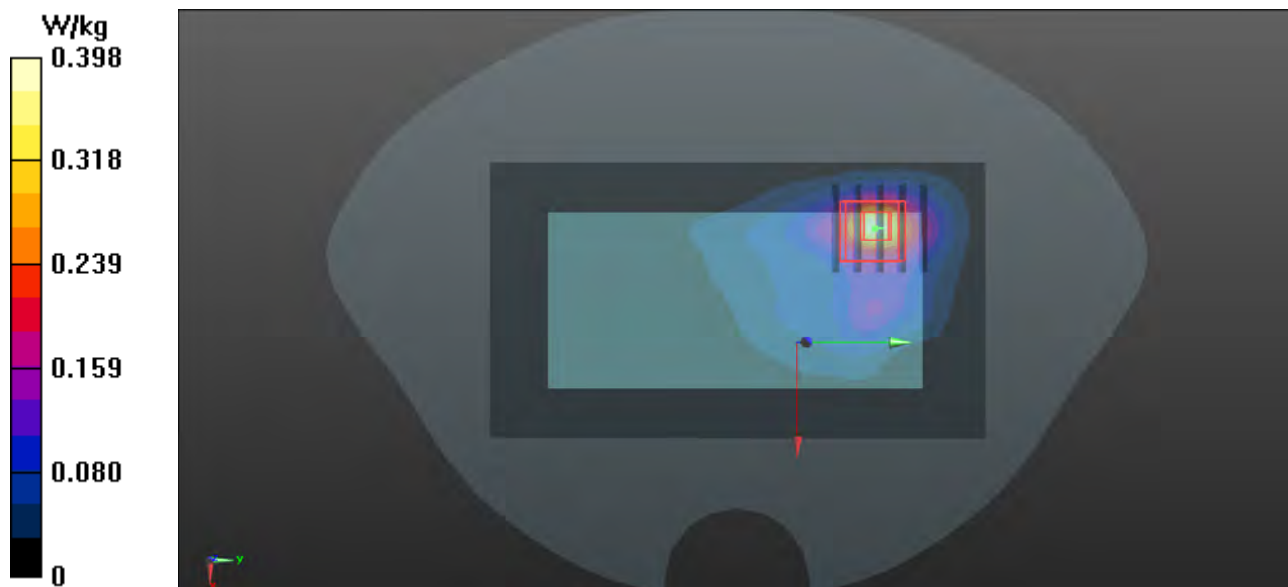



Appendix C. Calibration Certificate for Probe and Dipole

The SPEAG calibration certificates are shown as follows.



In Collaboration with
s p e a g
 CALIBRATION LABORATORY



中国认可
 国际互认
 校准
 CALIBRATION
 CNAS L0570

Add: No.51 Xueyuan Road, Haidian District, Beijing, 100191, China
 Tel: +86-10-62304633-2079 Fax: +86-10-62304633-2504
 E-mail: cttl@chinattl.com http://www.chinattl.cn

Client

ADT_CN

Certificate No:

Z18-60312

CALIBRATION CERTIFICATE

Object

D900V2 - SN:1d139

Calibration Procedure(s)

FF-Z11-003-01

Calibration Procedures for dipole validation kits

Calibration date:

September 7, 2018

This calibration Certificate documents the traceability to national standards, which realize the physical units of measurements(SI). The measurements and the uncertainties with confidence probability are given on the following pages and are part of the certificate.

All calibrations have been conducted in the closed laboratory facility: environment temperature(22±3)°C and humidity<70%.

Calibration Equipment used (M&TE critical for calibration)

Primary Standards	ID #	Cal Date(Calibrated by, Certificate No.)	Scheduled Calibration
Power Meter NRVD	102083	01-Nov-17 (CTTL, No.J17X08756)	Oct-18
Power sensor NRV-Z5	100542	01-Nov-17 (CTTL, No.J17X08756)	Oct-18
Reference Probe EX3DV4	SN 7464	12-Sep-17(SPEAG,No.EX3-7464_Sep17)	Sep-18
DAE4	SN 1524	13-Sep-17(SPEAG,No.DAE4-1524_Sep17)	Sep-18
Secondary Standards	ID #	Cal Date(Calibrated by, Certificate No.)	Scheduled Calibration
Signal Generator E4438C	MY49071430	23-Jan-18 (CTTL, No.J18X00560)	Jan-19
NetworkAnalyzer E5071C	MY46110673	24-Jan-18 (CTTL, No.J18X00561)	Jan-19

	Name	Function	Signature
Calibrated by:	Zhao Jing	SAR Test Engineer	
Reviewed by:	Lin Hao	SAR Test Engineer	
Approved by:	Qi Dianyuan	SAR Project Leader	

Issued: September 10, 2018

This calibration certificate shall not be reproduced except in full without written approval of the laboratory.



In Collaboration with

s p e a g
CALIBRATION LABORATORY

Add: No.51 Xueyuan Road, Haidian District, Beijing, 100191, China

Tel: +86-10-62304633-2079

Fax: +86-10-62304633-2504

E-mail: cttl@chinattl.com

http://www.chinattl.cn

Glossary:

TSL	tissue simulating liquid
ConvF	sensitivity in TSL / NORM _{x,y,z}
N/A	not applicable or not measured

Calibration is Performed According to the Following Standards:

- IEEE Std 1528-2013, "IEEE Recommended Practice for Determining the Peak Spatial-Averaged Specific Absorption Rate (SAR) in the Human Head from Wireless Communications Devices: Measurement Techniques", June 2013
- IEC 62209-1, "Measurement procedure for assessment of specific absorption rate of human exposure to radio frequency fields from hand-held and body-mounted wireless communication devices- Part 1: Device used next to the ear (Frequency range of 300MHz to 6GHz)", July 2016
- IEC 62209-2, "Procedure to measure the Specific Absorption Rate (SAR) For wireless communication devices used in close proximity to the human body (frequency range of 30MHz to 6GHz)", March 2010
- KDB865664, SAR Measurement Requirements for 100 MHz to 6 GHz

Additional Documentation:

- DASY4/5 System Handbook

Methods Applied and Interpretation of Parameters:

- Measurement Conditions:* Further details are available from the Validation Report at the end of the certificate. All figures stated in the certificate are valid at the frequency indicated.
- Antenna Parameters with TSL:* The dipole is mounted with the spacer to position its feed point exactly below the center marking of the flat phantom section, with the arms oriented parallel to the body axis.
- Feed Point Impedance and Return Loss:* These parameters are measured with the dipole positioned under the liquid filled phantom. The impedance stated is transformed from the measurement at the SMA connector to the feed point. The Return Loss ensures low reflected power. No uncertainty required.
- Electrical Delay:* One-way delay between the SMA connector and the antenna feed point. No uncertainty required.
- SAR measured:* SAR measured at the stated antenna input power.
- SAR normalized:* SAR as measured, normalized to an input power of 1 W at the antenna connector.
- SAR for nominal TSL parameters:* The measured TSL parameters are used to calculate the nominal SAR result.

The reported uncertainty of measurement is stated as the standard uncertainty of Measurement multiplied by the coverage factor $k=2$, which for a normal distribution Corresponds to a coverage probability of approximately 95%.



Add: No.51 Xueyuan Road, Haidian District, Beijing, 100191, China
 Tel: +86-10-62304633-2079 Fax: +86-10-62304633-2504
 E-mail: cttl@chinattl.com http://www.chinattl.cn

Measurement Conditions

DASY system configuration, as far as not given on page 1.

DASY Version	DASY52	52.10.1.1446
Extrapolation	Advanced Extrapolation	
Phantom	Triple Flat Phantom 5.1C	
Distance Dipole Center - TSL	15 mm	with Spacer
Zoom Scan Resolution	dx, dy, dz = 5 mm	
Frequency	900 MHz ± 1 MHz	

Head TSL parameters

The following parameters and calculations were applied.

	Temperature	Permittivity	Conductivity
Nominal Head TSL parameters	22.0 °C	41.5	0.97 mho/m
Measured Head TSL parameters	(22.0 ± 0.2) °C	42.7 ± 6 %	0.97 mho/m ± 6 %
Head TSL temperature change during test	<1.0 °C	----	----

SAR result with Head TSL

SAR averaged over 1 cm ³ (1 g) of Head TSL	Condition	
SAR measured	250 mW input power	2.70 mW / g
SAR for nominal Head TSL parameters	normalized to 1W	10.9 mW / g ± 18.8 % (k=2)
SAR averaged over 10 cm ³ (10 g) of Head TSL	Condition	
SAR measured	250 mW input power	1.75 mW / g
SAR for nominal Head TSL parameters	normalized to 1W	7.05 mW / g ± 18.7 % (k=2)

Body TSL parameters

The following parameters and calculations were applied.

	Temperature	Permittivity	Conductivity
Nominal Body TSL parameters	22.0 °C	55.0	1.05 mho/m
Measured Body TSL parameters	(22.0 ± 0.2) °C	55.5 ± 6 %	1.07 mho/m ± 6 %
Body TSL temperature change during test	<1.0 °C	----	----

SAR result with Body TSL

SAR averaged over 1 cm ³ (1 g) of Body TSL	Condition	
SAR measured	250 mW input power	2.81 mW / g
SAR for nominal Body TSL parameters	normalized to 1W	11.1 mW / g ± 18.8 % (k=2)
SAR averaged over 10 cm ³ (10 g) of Body TSL	Condition	
SAR measured	250 mW input power	1.85 mW / g
SAR for nominal Body TSL parameters	normalized to 1W	7.32 mW / g ± 18.7 % (k=2)



Add: No.51 Xueyuan Road, Haidian District, Beijing, 100191, China
Tel: +86-10-62304633-2079 Fax: +86-10-62304633-2504
E-mail: cttl@chinattl.com http://www.chinattl.cn

Appendix (Additional assessments outside the scope of CNAS L0570)

Antenna Parameters with Head TSL

Impedance, transformed to feed point	48.5Ω- 1.26jΩ
Return Loss	- 33.9dB

Antenna Parameters with Body TSL

Impedance, transformed to feed point	46.8Ω+ 0.19jΩ
Return Loss	- 29.6dB

General Antenna Parameters and Design

Electrical Delay (one direction)	1.272 ns
----------------------------------	----------

After long term use with 100W radiated power, only a slight warming of the dipole near the feedpoint can be measured.

The dipole is made of standard semirigid coaxial cable. The center conductor of the feeding line is directly connected to the second arm of the dipole. The antenna is therefore short-circuited for DC-signals. On some of the dipoles, small end caps are added to the dipole arms in order to improve matching when loaded according to the position as explained in the "Measurement Conditions" paragraph. The SAR data are not affected by this change. The overall dipole length is still according to the Standard.

No excessive force must be applied to the dipole arms, because they might bend or the soldered connections near the feedpoint may be damaged.

Additional EUT Data

Manufactured by	SPEAG
-----------------	-------



Add: No.51 Xueyuan Road, Haidian District, Beijing, 100191, China
Tel: +86-10-62304633-2079 Fax: +86-10-62304633-2504
E-mail: cttl@chinattl.com http://www.chinattl.cn

DASY5 Validation Report for Head TSL

Date: 09.07.2018

Test Laboratory: CTTL, Beijing, China

DUT: Dipole 900 MHz; Type: D900V2; Serial: D900V2 - SN: 1d139

Communication System: UID 0, CW; Frequency: 900 MHz; Duty Cycle: 1:1

Medium parameters used: $f = 900$ MHz; $\sigma = 0.966$ S/m; $\epsilon_r = 42.67$; $\rho = 1000$ kg/m³

Phantom section: Right Section

DASY5 Configuration:

- Probe: EX3DV4 - SN7464; ConvF(10.03, 10.03, 10.03) @ 900 MHz; Calibrated: 9/12/2017
- Sensor-Surface: 1.4mm (Mechanical Surface Detection)
- Electronics: DAE4 Sn1524; Calibrated: 9/13/2017
- Phantom: MFP_V5.1C ; Type: QD 000 P51CA; Serial: 1062
- Measurement SW: DASY52, Version 52.10 (1); SEMCAD X Version 14.6.11 (7439)

Dipole Calibration/Zoom Scan (7x7x7) (7x7x7)/Cube 0: Measurement grid: dx=5mm, dy=5mm, dz=5mm

Reference Value = 60.09 V/m; Power Drift = 0.01 dB

Peak SAR (extrapolated) = 4.20 W/kg

SAR(1 g) = 2.7 W/kg; SAR(10 g) = 1.75 W/kg

Maximum value of SAR (measured) = 3.68 W/kg

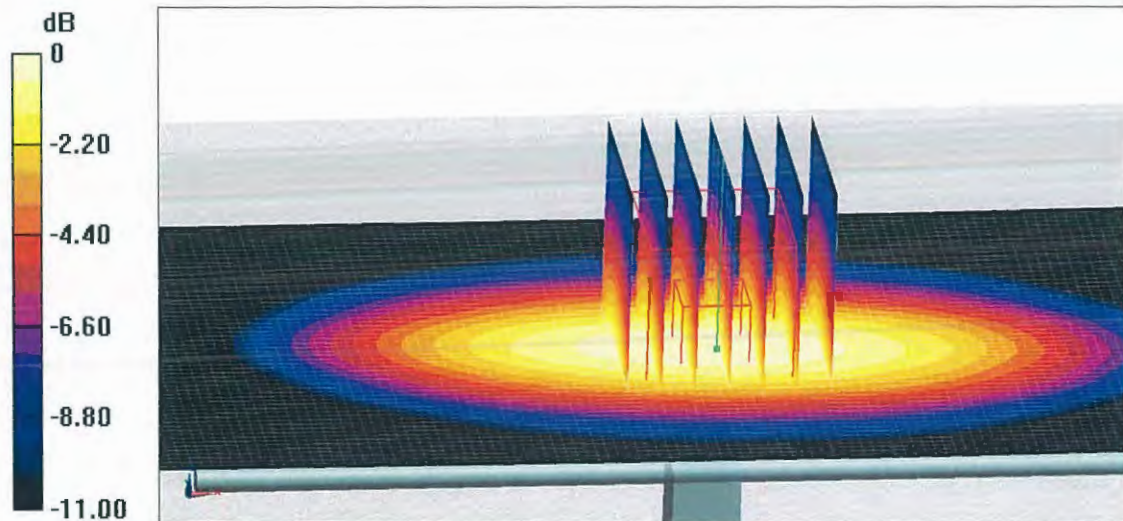

0 dB = 3.68 W/kg = 5.66 dBW/kg



Add: No.51 Xueyuan Road, Haidian District, Beijing, 100191, China
Tel: +86-10-62304633-2079 Fax: +86-10-62304633-2504
E-mail: cttl@chinattl.com http://www.chinattl.cn

Impedance Measurement Plot for Head TSL

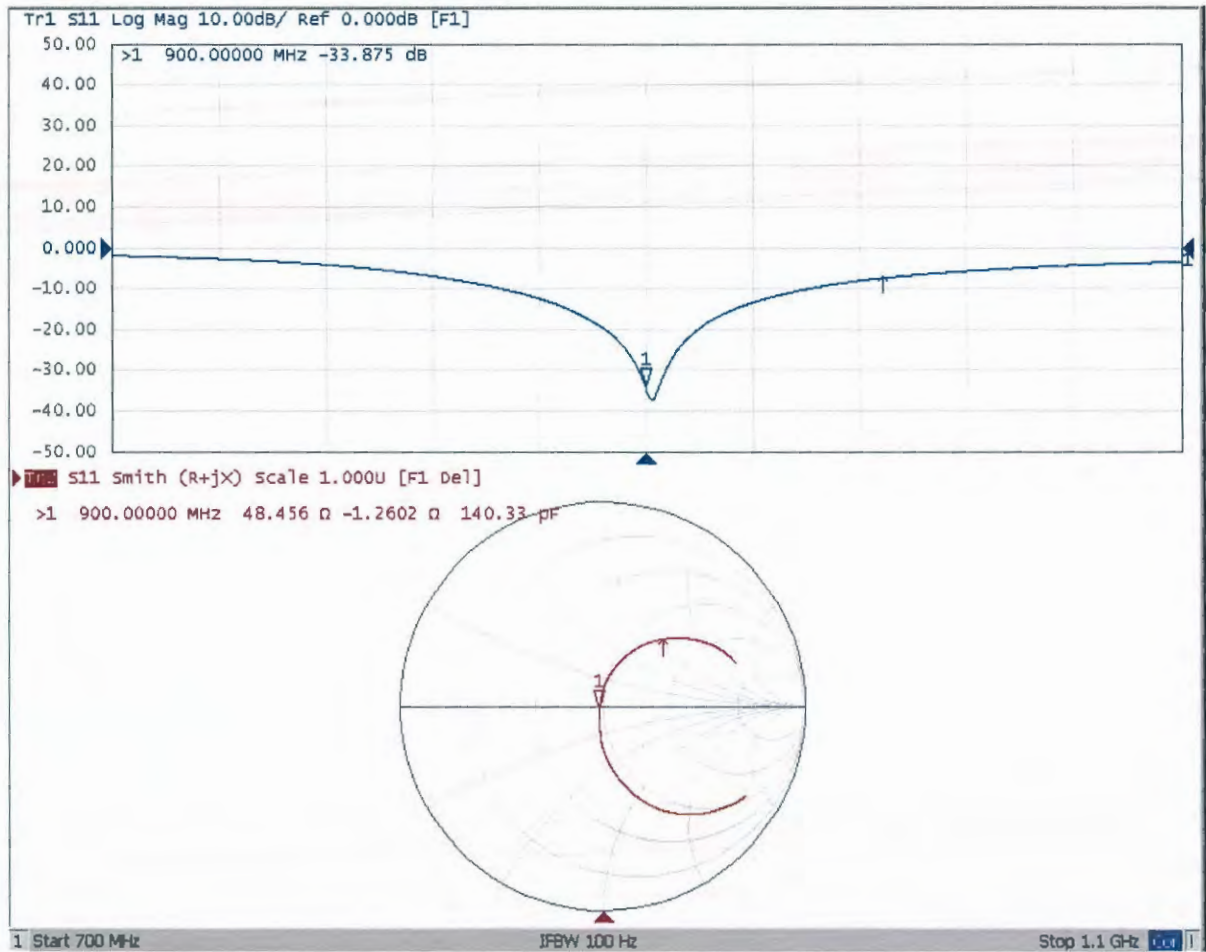



Add: No.51 Xueyuan Road, Haidian District, Beijing, 100191, China
Tel: +86-10-62304633-2079 Fax: +86-10-62304633-2504
E-mail: cttl@chinattl.com http://www.chinattl.cn

DASY5 Validation Report for Body TSL

Date: 09.06.2018

Test Laboratory: CTTL, Beijing, China

DUT: Dipole 900 MHz; Type: D900V2; Serial: D900V2 - SN: 1d139

Communication System: UID 0, CW; Frequency: 900 MHz; Duty Cycle: 1:1

Medium parameters used: $f = 900$ MHz; $\sigma = 1.071$ S/m; $\epsilon_r = 55.51$; $\rho = 1000$ kg/m³

Phantom section: Left Section

DASY5 Configuration:

- Probe: EX3DV4 - SN7464; ConvF(10.17, 10.17, 10.17) @ 900 MHz; Calibrated: 9/12/2017
- Sensor-Surface: 1.4mm (Mechanical Surface Detection)
- Electronics: DAE4 Sn1524; Calibrated: 9/13/2017
- Phantom: MFP_V5.1C ; Type: QD 000 P51CA; Serial: 1062
- Measurement SW: DASY52, Version 52.10 (1); SEMCAD X Version 14.6.11 (7439)

Dipole Calibration/Zoom Scan (7x7x7) (7x7x7)/Cube 0: Measurement grid: dx=5mm, dy=5mm, dz=5mm

Reference Value = 57.56 V/m; Power Drift = -0.02 dB

Peak SAR (extrapolated) = 4.30 W/kg

SAR(1 g) = 2.81 W/kg; SAR(10 g) = 1.85 W/kg

Maximum value of SAR (measured) = 3.78 W/kg

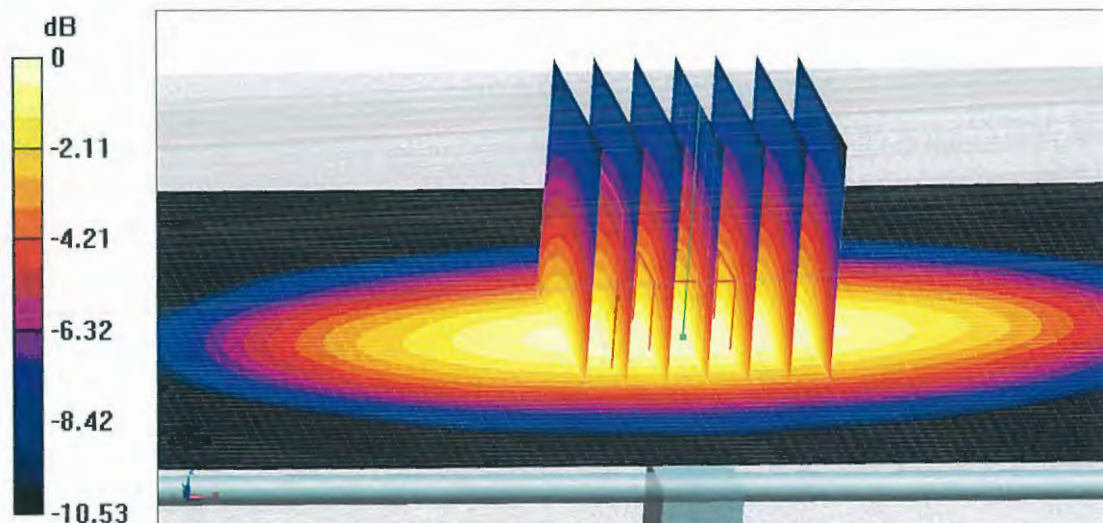

0 dB = 3.78 W/kg = 5.77 dBW/kg



Add: No.51 Xueyuan Road, Haidian District, Beijing, 100191, China
Tel: +86-10-62304633-2079 Fax: +86-10-62304633-2504
E-mail: cttl@chinattl.com http://www.chinattl.cn

Impedance Measurement Plot for Body TSL

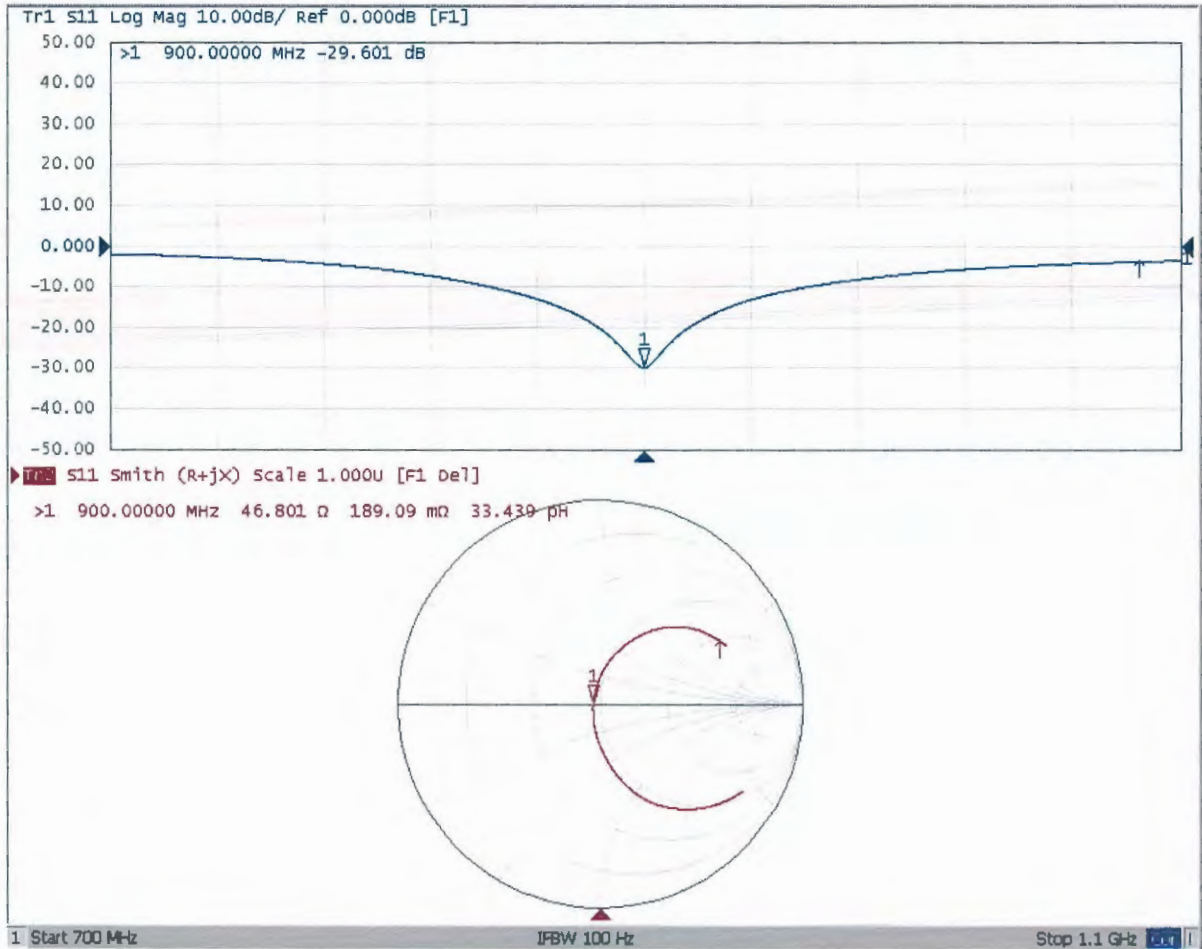



Add: No.51 Xueyuan Road, Haidian District, Beijing, 100191, China
Tel: +86-10-62304633-2079 Fax: +86-10-62304633-2504
E-mail: cttl@chinattl.com http://www.chinattl.cn

Client **ADT_CN**

Certificate No: **Z18-60313**

CALIBRATION CERTIFICATE

Object **D1750V2 - SN: 1071**

Calibration Procedure(s) **FF-Z11-003-01**
Calibration Procedures for dipole validation kits

Calibration date: **September 13, 2018**

This calibration Certificate documents the traceability to national standards, which realize the physical units of measurements(SI). The measurements and the uncertainties with confidence probability are given on the following pages and are part of the certificate.

All calibrations have been conducted in the closed laboratory facility: environment temperature(22±3)°C and humidity<70%.

Calibration Equipment used (M&TE critical for calibration)

Primary Standards	ID #	Cal Date(Calibrated by, Certificate No.)	Scheduled Calibration
Power Meter NRVD	102083	01-Nov-17 (CTTL, No.J17X08756)	Oct-18
Power sensor NRV-Z5	100542	01-Nov-17 (CTTL, No.J17X08756)	Oct-18
Reference Probe EX3DV4	SN 3846	25-Jan-18(SPEAG,No.EX3-3846_Jan18)	Jan-19
DAE4	SN 777	15-Dec-17(SPEAG,No.DAE4-777_Dec17)	Dec-18
Secondary Standards	ID #	Cal Date(Calibrated by, Certificate No.)	Scheduled Calibration
Signal Generator E4438C	MY49071430	23-Jan-18 (CTTL, No.J18X00560)	Jan-19
NetworkAnalyzer E5071C	MY46110673	24-Jan-18 (CTTL, No.J18X00561)	Jan-19

	Name	Function	Signature
Calibrated by:	Zhao Jing	SAR Test Engineer	
Reviewed by:	Lin Jun	SAR Test Engineer	
Approved by:	Qi Dianyuan	SAR Project Leader	

Issued: September 16, 2018

This calibration certificate shall not be reproduced except in full without written approval of the laboratory.



Add: No.51 Xueyuan Road, Haidian District, Beijing, 100191, China
Tel: +86-10-62304633-2079 Fax: +86-10-62304633-2504
E-mail: cttl@chinattl.com http://www.chinattl.cn

Glossary:

TSL	tissue simulating liquid
ConvF	sensitivity in TSL / NORM _{x,y,z}
N/A	not applicable or not measured

Calibration is Performed According to the Following Standards:

- IEEE Std 1528-2013, "IEEE Recommended Practice for Determining the Peak Spatial-Averaged Specific Absorption Rate (SAR) in the Human Head from Wireless Communications Devices: Measurement Techniques", June 2013
- IEC 62209-1, "Measurement procedure for assessment of specific absorption rate of human exposure to radio frequency fields from hand-held and body-mounted wireless communication devices- Part 1: Device used next to the ear (Frequency range of 300MHz to 6GHz)", July 2016
- IEC 62209-2, "Procedure to measure the Specific Absorption Rate (SAR) For wireless communication devices used in close proximity to the human body (frequency range of 30MHz to 6GHz)", March 2010
- KDB865664, SAR Measurement Requirements for 100 MHz to 6 GHz

Additional Documentation:

- DASY4/5 System Handbook

Methods Applied and Interpretation of Parameters:

- Measurement Conditions:** Further details are available from the Validation Report at the end of the certificate. All figures stated in the certificate are valid at the frequency indicated.
- Antenna Parameters with TSL:** The dipole is mounted with the spacer to position its feed point exactly below the center marking of the flat phantom section, with the arms oriented parallel to the body axis.
- Feed Point Impedance and Return Loss:** These parameters are measured with the dipole positioned under the liquid filled phantom. The impedance stated is transformed from the measurement at the SMA connector to the feed point. The Return Loss ensures low reflected power. No uncertainty required.
- Electrical Delay:** One-way delay between the SMA connector and the antenna feed point. No uncertainty required.
- SAR measured:** SAR measured at the stated antenna input power.
- SAR normalized:** SAR as measured, normalized to an input power of 1 W at the antenna connector.
- SAR for nominal TSL parameters:** The measured TSL parameters are used to calculate the nominal SAR result.

The reported uncertainty of measurement is stated as the standard uncertainty of Measurement multiplied by the coverage factor $k=2$, which for a normal distribution Corresponds to a coverage probability of approximately 95%.



Add: No.51 Xueyuan Road, Haidian District, Beijing, 100191, China
Tel: +86-10-62304633-2079 Fax: +86-10-62304633-2504
E-mail: cttl@chinattl.com http://www.chinattl.cn

Measurement Conditions

DASY system configuration, as far as not given on page 1.

DASY Version	DASY52	52.10.1.1476
Extrapolation	Advanced Extrapolation	
Phantom	Triple Flat Phantom 5.1C	
Distance Dipole Center - TSL	10 mm	with Spacer
Zoom Scan Resolution	dx, dy, dz = 5 mm	
Frequency	1750 MHz ± 1 MHz	

Head TSL parameters

The following parameters and calculations were applied.

	Temperature	Permittivity	Conductivity
Nominal Head TSL parameters	22.0 °C	40.1	1.37 mho/m
Measured Head TSL parameters	(22.0 ± 0.2) °C	40.9 ± 6 %	1.36 mho/m ± 6 %
Head TSL temperature change during test	<1.0 °C	---	---

SAR result with Head TSL

SAR averaged over 1 cm ³ (1 g) of Head TSL	Condition	
SAR measured	250 mW input power	9.12 mW / g
SAR for nominal Head TSL parameters	normalized to 1W	36.8 mW / g ± 18.8 % (k=2)
SAR averaged over 10 cm ³ (10 g) of Head TSL	Condition	
SAR measured	250 mW input power	4.92 mW / g
SAR for nominal Head TSL parameters	normalized to 1W	19.8 mW / g ± 18.7 % (k=2)

Body TSL parameters

The following parameters and calculations were applied.

	Temperature	Permittivity	Conductivity
Nominal Body TSL parameters	22.0 °C	53.4	1.49 mho/m
Measured Body TSL parameters	(22.0 ± 0.2) °C	53.4 ± 6 %	1.52 mho/m ± 6 %
Body TSL temperature change during test	<1.0 °C	---	---

SAR result with Body TSL

SAR averaged over 1 cm ³ (1 g) of Body TSL	Condition	
SAR measured	250 mW input power	9.62 mW / g
SAR for nominal Body TSL parameters	normalized to 1W	38.0 mW / g ± 18.8 % (k=2)
SAR averaged over 10 cm ³ (10 g) of Body TSL	Condition	
SAR measured	250 mW input power	5.20 mW / g
SAR for nominal Body TSL parameters	normalized to 1W	20.6 mW / g ± 18.7 % (k=2)